

# Free Polycategories for Unitary Supermaps of Arbitrary Dimension

Matt Wilson<sup>1,2</sup> and Giulio Chiribella<sup>1,2,3,4</sup>

<sup>1</sup>Quantum Group, Department of Computer Science, University of Oxford

<sup>2</sup>HKU-Oxford Joint Laboratory for Quantum Information and Computation

<sup>3</sup>QICI Quantum Information and Computation Initiative, Department of Computer Science

<sup>4</sup>Perimeter Institute for Theoretical Physics, 31 Caroline Street North, Waterloo, Ontario, Canada

We provide a construction for holes into which morphisms of abstract symmetric monoidal categories can be inserted, termed the *polyslot* construction  $\mathbf{pslot}[\mathbf{C}]$ , and identify a sub-class  $\mathbf{srep}[\mathbf{C}]$  of polyslots which are *single-party representable*. These constructions strengthen a previously introduced notion of locally-applicable transformation used to characterize quantum supermaps in a way that is sufficient to reconstruct unitary supermaps directly from the monoidal structure of the category of unitaries. Both constructions furthermore freely reconstruct the enriched polycategorical semantics for quantum supermaps which allows to compose supermaps in sequence and in parallel whilst forbidding the creation of time-loops. By doing so supermaps and their polycategorical semantics are generalized to infinite dimensions, in such a way as to include canonical examples such as the quantum switch. Beyond specific applications to quantum-relevant categories, a general class of categorical structures termed path-contraction groupoids are defined on which the  $\mathbf{srep}[\mathbf{C}]$  and  $\mathbf{pslot}[\mathbf{C}]$  constructions are shown to coincide.

## 1 Introduction

A key concept in a variety of scientific and mathematical disciplines is the specification of two classes of data, a collection of systems that may be assigned possible states and the specification processes which act upon systems so as to edit or evolve those states. A common emergent theme within some such fields has been the development of the concept of a hole into-which a process could be inserted, such instances can be seen within the study of quantum information processing [1–5], quantum foundations [1–6], bidirectional programming [7–9], game-theory [10–13], machine learning [14], open systems dynamics [15], and financial trading [16]. A natural primitive notion of diagram-with-hole for an arbitrary symmetric monoidal category can be given by taking a circuit

---

Matt Wilson: [matthew.wilson@cs.ox.ac.uk](mailto:matthew.wilson@cs.ox.ac.uk)

Giulio Chiribella: [giulio.chiribella@cs.ox.ac.uk](mailto:giulio.chiribella@cs.ox.ac.uk)

diagram term, and puncturing a series of holes into it:

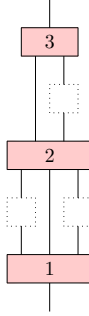

Such diagrams have been studied in quantum theory under the name of quantum-combs [1], and in bidirectional programming as profunctor optics [7, 17, 18] with the two approaches connected in the unitary case by [19]. However, in quantum contexts considerable attention is given to a generalisation of the above picture to black-box holes called quantum supermaps [2], which are not assumed to be expressed as circuit-diagrams of the above form. The canonical example of such a supermap is the quantum switch [3, 20] which represents a quantum superposition of two possible diagrams with open holes.

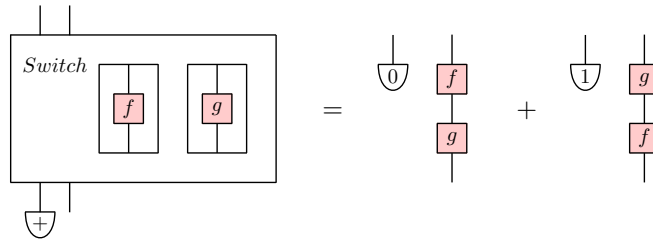

The concept of a black-box hole, which processes may be plugged into, is at the intuitive level easy enough to imagine, and yet, it has been unclear how to generalize quantum supermaps appropriately to arbitrary operational probabilistic theories [21, 22], including to infinite-dimensional quantum theory. A proposal of [4] refers only to single inputs, and it is unclear whether the proposal of [23] produces maps that can be suitably extended to be applied on part of any bipartite process. A proposal of [24] is to use  $\ast\mathbf{Hilb}$  [25, 26] which produces fairly well-behaved results but however requires understanding of the use of non-standard analysis or 2-category theory and as currently defined is only appropriate for the unitary (non-mixed) setting. The issue, in short, is that whilst the spirit of the definition of quantum supermaps is intended to be abstract and black-box, in practice the definition of supermap on a physical theory requires knowledge of mathematical structure beyond the circuit-theoretic structure of that theory, such as the existence of an appropriate raw-material category into which the quantum channels embed [27–30].

This article is written with the aim of suggesting appropriate definitions for supermaps that require *only* the circuit-theoretic structure of the categories they act on in their definition. An exploration of the available definitions of supermaps in general symmetric monoidal categories is expected to have two main applications, first, a satisfactory generalization to infinite dimensions would allow to make a connection between the supermap program and the program of unification of quantum theory with gravitational physics, where quantum causal structures such as those present in the quantum switch are predicted by some to play a key conceptual role [6, 31]. Beyond applications to quantum gravity, a principled definition of black-box hole, and exploration of the

landscape of possible definitions may be of use to those other fields in which circuits with open holes are currently studied.

In previous work, a definition of locally-applicable transformation was proposed for modeling black-box holes in general symmetric monoidal categories, and shown to recover the quantum supermaps when applied to the symmetric monoidal category of quantum channels [24]. The key principle was to capture the following expected behaviour of a hole, the possibility to apply to part of any bipartite process whilst commuting with local actions on the environment:

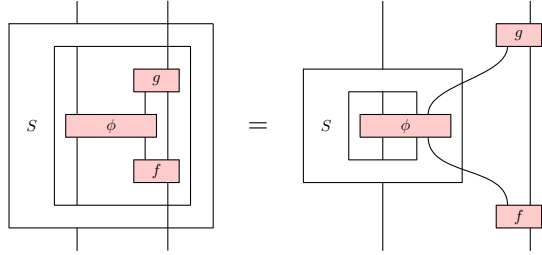

Whilst in this work locally-applicable transformations on quantum channels were shown to be in one-to-one correspondence with quantum supermaps, there are two properties we desire for a construction of supermaps on arbitrary symmetric monoidal categories which are not exhibited by the definition of a locally-applicable transformation.

- First, we aim to find a construction on symmetric monoidal categories which when applied to the category  $\mathbf{fU}$  of finite-dimensional unitary processes, recovers the unitary-preserving quantum supermaps.
- Secondly, we aim to find a construction that allows to unambiguously give formal meaning to the following intuitive pictures that one would like to safely imagine when thinking about such holes:

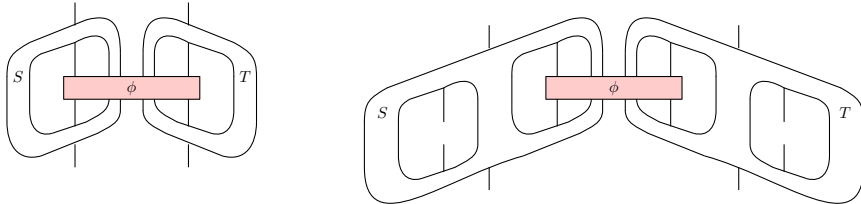

In short we desire a construction strong enough freely give a monoidal [32] and polycategorical [33] semantics for holes in symmetric monoidal categories, capturing the heart of the linear distributivity of previous approaches to constructing categories of quantum supermaps [27, 29].

In this paper, we provide two stronger constructions that satisfy these requirements. The first construction, termed the  $\mathbf{srep}[\mathbf{C}]$  construction, reconstructs supermaps by assuming a powerful structural theorem, that as viewed by single parties, they act as combs [2]. By developing a second construction of a polycategory of *polyslots* termed  $\mathbf{pslot}[\mathbf{C}]$  we show that the decomposition of supermaps at the single-party level as combs is a consequence in unitary quantum theory of a strong-locality principle. This strong-locality can be interpreted as taking the bi-commutant of the family of combs, and so connects the definition of supermaps to the definition of subsystems

as bi-commutant families of operations [34]. In our first class of results, we show that the above constructions indeed provide an enriched polycategorical semantics

**Theorem 1.**  $\mathbf{pslot}[\mathbf{C}]$  and  $\mathbf{srep}[\mathbf{C}]$  are symmetric polycategories

In our second class of results, we prove that in a broad class of categories which we term “path contraction groupoids” the above constructions coincide.

**Theorem 2.** Let  $\mathbf{G}$  be a path-contraction groupoid, then  $\mathbf{pslot}[\mathbf{G}] = \mathbf{srep}[\mathbf{G}]$

As a corollary of this theorem, we find that either construction characterizes the finite dimensional quantum supermaps in both the mixed and unitary cases.

**Theorem 3.** Polyslots generalize quantum supermaps on the quantum channels and on the unitaries to arbitrary symmetric monoidal categories. Formally, there is an equivalence

$$\mathbf{pslot}[\mathbf{fU}] \cong \mathbf{uQS}$$

of polycategories where  $\mathbf{fU}$  is the category of unitaries and  $\mathbf{uQS}$  the polycategory of unitary-preserving quantum supermaps along with an equivalence

$$\mathbf{pslot}[\mathbf{fQC}] \cong \mathbf{QS}$$

of polycategories where  $\mathbf{fQC}$  is the category of finite-dimensional quantum channels and  $\mathbf{QS}$  the polycategory of quantum supermaps.

In applications to infinite-dimensional unitary quantum theory, we further find that  $\mathbf{pslot}[\mathbf{sepU}]$  and equivalently  $\mathbf{srep}[\mathbf{sepU}]$  are always implementable by time-loops and unitaries, where  $\mathbf{sepU}$  is the category of unitary linear maps between separable Hilbert spaces. Whilst  $\mathbf{pslot}[\mathbf{sepU}]$  is strong enough to enforce a polycategorical semantics for infinite-dimensional unitary-preserving supermaps, we find that  $\mathbf{pslot}[\mathbf{sepU}]$  is still flexible enough to include generalizations of motivating instances of quantum supermaps such as the quantum switch to infinite dimensions. The applications of this general black-box definition of hole to the growing number of scientific fields in which open diagrams are studied is left for future discovery, as is the extension of the construction to include the more elaborate and iterated type-systems developed for handling higher-order quantum theory in a series of recent works [27–30, 35].

## 2 Preliminary Material

Here we introduce the category-theoretic terms used throughout the paper, category theory is used here purely as an organizing language, and all calculations are written in a way that is aimed to be followable by those who are familiar only with string diagrams for compact closed categories. In general, we will adopt the convention of representing processes that are higher-order in white and processes which are lower order in pink, this choice has no formal significance and is made purely for readability.

**Category Theory** A category [32] consists in a specification of objects  $A, B, C, \dots$  and a specification of morphisms which act between them. Formally a category is equipped with, for each pair  $A, B$  of objects a set  $\mathbf{C}(A, B)$  terms the set of “morphisms”. A category furthermore is equipped with a composition function  $\circ : \mathbf{C}(A, B) \times \mathbf{C}(B, C) \rightarrow \mathbf{C}(A, C)$  denoted  $\circ$  for each  $A, B, C$  such that  $f \circ (g \circ h) = (f \circ g) \circ h$ . Categories come with unit morphisms  $id_A : A \rightarrow A$  for each object  $A$  such that for each  $f : A \rightarrow b$  then  $f \circ id_A = f = id_B \circ f$ . The defining conditions of a category can be conveniently absorbed into a graphical language which makes clear their suitability for representing processes between systems. An object  $A$  of a category can always be represented by a wire, and a morphism  $f : A \rightarrow B$  by a box with input wire  $A$  and output wire  $B$ :

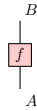

Sequential composition  $f \circ g$  is denoted:

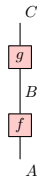

with associativity allowing for unambiguous interpretation of the diagram. The identity process can be represented by a wire:



So that again the defining equation  $f \circ id_A = id_A$  is absorbed into graphical language. As far as theories of information processing are concerned the sequential composition in the definitions data of a category is often interpreted as specification of a notion of time-ordered application of processes. Finally, we describe a morphism  $f : A \rightarrow B$  as an *isomorphism* if there exists  $\bar{f} : B \rightarrow A$  such that  $f \circ \bar{f} = id_B$  and  $\bar{f} \circ f = id_A$ . If every morphism of a category  $\mathbf{C}$  is an isomorphism then  $\mathbf{C}$  is termed a *groupoid*.

**Monoidal categories** In the process-theoretic approach to physics [36–38], the primary object of study is that of a circuit-theory. A monoidal category is an algebraic model of the notion of such a circuit theory, being equipped with sequential and parallel composition. Formally a monoidal category is a category  $\mathbf{C}$  equipped with a functor  $\otimes : \mathbf{C} \times \mathbf{C} \rightarrow \mathbf{C}$ . Which assigns to each pair  $(A, B)$  of objects in  $\mathbf{C}$  an object  $A \otimes B$  again in  $\mathbf{C}$ ,



and similarly to each pair  $(f, g)$  or morphisms a new morphism  $f \otimes g$ . The key feature of a monoidal category is the interchange law  $(f \otimes id) \circ (id \otimes g) = (id \otimes g) \circ (f \otimes id)$  which can be presented diagrammatically by box-sliding:

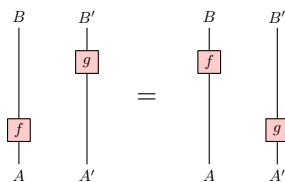

The interchange law is often interpreted as modelling concurrency, the possibility for processes to happen to different places, with their precise times of application irrelevant due to their spatial separation. Beyond monoidal categories one can define those which are *symmetric*, meaning that they are equipped with a braid  $\beta_{B,A} : B \otimes A \rightarrow A \otimes B$  depicted graphically by:



when applied twice the condition of symmetry further requires that  $\beta_{B,A} \circ \beta_{A,B} = id_{B \otimes A}$ , which essentially entails that the spatial position of wires on the page is of relevance only as-so-far as it is useful for book-keeping. If a monoidal category is a groupoid we will term it a *monoidal groupoid*.

**Compact closed categories** A compact closed category is one in which, internally, arbitrary input and output wires can be plugged together. Formally a compact closed category is a symmetric monoidal category  $\mathbf{C}$  equipped with for each object  $A$  a “dual” object  $A^*$ , a state  $\cup : I \rightarrow A^* \otimes A$  and effect  $\cup : A^* \otimes A \rightarrow I$  such that:

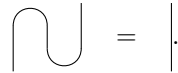

often referred to as the *snake equation*. A key feature of the snake equation is that it equips a monoidal category with an equivalence between inputs and outputs, this is a practically useful graphical property that allows the representation of process/state duality and feedback in monoidal categories in an internalized way.

**Polycategories** There are non-monoidal algebraic structures within which interchange laws can be specified, polycategorical structures [33] will provide an instance of such structures relevant to this paper. polycategorical structure is given by specification of a class of atomic objects, and then morphisms are defined as going between lists of such atomic objects

$$f : \underline{A} \rightarrow \underline{B} \quad \underline{A} = A_1 \dots A_n \quad , \quad \underline{B} = B_1 \dots B_m.$$

Whilst monoidal structure allows to compose along many objects at once, poly-categorical structure allows to compose morphisms along individually specified objects, formally given  $f : \underline{A} \rightarrow \underline{BNC}$  and  $g : \underline{DNE} \rightarrow \underline{F}$  one may construct the composition  $g \circ_N f : \underline{DAE} \rightarrow \underline{BFC}$  along  $N$ . Morphisms of polycategories can be written just as they would be for monoidal categories

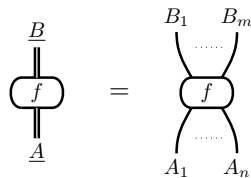

with composition denoted by

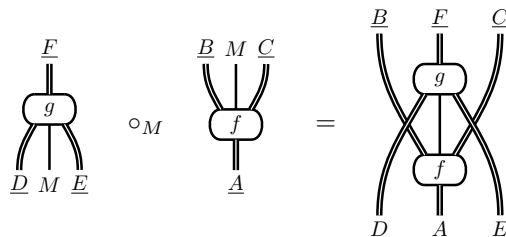

for the diagrammatic representation to be sound, there should be no difference in interpretation of the following pictures

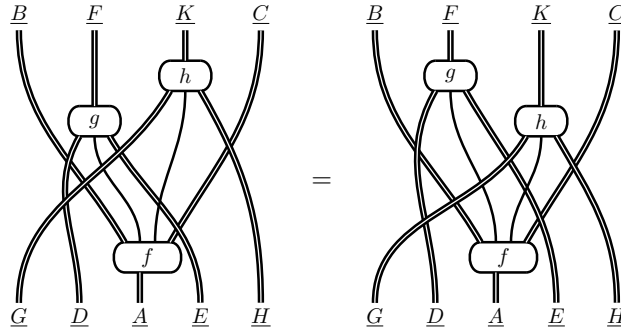

amongst others. Formally, whilst polycategories are not monoidal they still are equipped with a certain notion of interchange law, which is in this context often referred to as associativity. The full specification of the associativity conditions required for symmetric polycategories is left to appendix C.

**Quantum Theory** In this paper, we introduce quantum theory foremost as a monoidal category. In particular, for this paper, we mainly address pure reversible quantum theory, typically represented by the category of unitary linear maps.

**Definition 1** (The category  $\mathbf{fHilb}$ ). *The category  $\mathbf{fHilb}$  has objects given by finite dimensional Hilbert spaces and morphisms given by linear maps. Sequential composition in  $\mathbf{fHilb}$  is given by the standard composition rule for linear maps, the monoidal product is given on objects by the tensor product  $H_A \otimes H_B$  of Hilbert spaces. On morphisms the monoidal product is given by linear extension of  $(f \otimes g)(\phi \otimes \psi) := f(\phi) \otimes g(\psi)$ . The category  $\mathbf{fHilb}$  is furthermore compact closed with  $\cup := \sum_i |i\rangle \otimes \langle i|$  and  $\cap = \sum_i \langle i| \otimes |i\rangle$ .*

The category  $\mathbf{fHilb}$  can be viewed as the fundamental raw-material category from which a multitude of categories relevant to quantum information processing can be constructed. The main category we will be concerned with in this paper is the category that is typically interpreted as representing the time-reversible dynamics of quantum theory, the category  $\mathbf{fU}$  of unitaries.

**Definition 2** (The category  $\mathbf{fU}$ ). *The category  $\mathbf{fU} \subseteq \mathbf{fHilb}$  has objects given by finite-dimensional Hilbert spaces and morphisms given by unitary linear maps, that is, linear maps  $U : H_A \rightarrow H_B$  such that  $U^\dagger \circ U = id = U \circ U^\dagger$ . In this sense  $U^\dagger$  is typically interpreted as the time-reverse of  $U$ . All sequential and parallel composition rules are inherited from  $\mathbf{fHilb}$ , however compact closure is not inherited since neither of  $\cap, \cup$  or in general unitary.*

To account for noise, quantum information theorists typically are concerned instead with the categories of completely positive and completely positive trace-preserving maps.

**Definition 3** (The category  $\mathbf{fCP}$ ). *The category  $\mathbf{fCP}$  has as objects the spaces  $\mathcal{L}(H_A)$  of linear operators on Hilbert spaces. The morphisms of type  $\mathcal{L}(H_A) \rightarrow \mathcal{L}(H_B)$  in  $\mathbf{fCP}$  are given by the completely-positive operators [39].  $\mathbf{fCP}$  is also equipped with bell-states and effects and so is compact closed. The resulting isomorphism between states and processes in  $\mathbf{fCP}$  is typically referred to as the CJ (Choi-Jamiolkowski) [40] isomorphism.*

**Definition 4** (The category **fQC**). *The category **fQC** of quantum channels is the sub-category of **fCP** containing only those morphisms which are trace-preserving. **fQC** is not compact closed since its only effect is the trace. The quantum channels are the processes in quantum information theory most commonly referred to as deterministic.*

The four symmetric monoidal categories introduced in this section are the most commonly used in the consideration of pure and mixed quantum theory respectively.

**Quantum supermaps** Quantum supermaps are used in quantum information theory and quantum foundations to formalize a notion of higher-order transformation that can be applied to transformations [2]. Intuitively the goal of the definition of quantum supermaps is to formalize the following kind of picture:

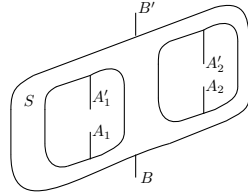

used to represent a higher-order process that accepts as an argument a process of type  $A_1 \rightarrow A_1'$  and a process of type  $A_2 \rightarrow A_2'$  to produce a process of type  $B \rightarrow B'$ . Such maps will typically be interpreted as having type  $[A_1, A_1'][A_2, A_2'] \rightarrow [B, B']$  within some kind of algebraic structure.

It is typically required that such maps should be well-defined when acting on only parts of bipartite processes

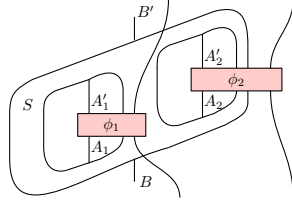

however, some care has to be taken in defining how supermaps can be used or composed together due to a key structural feature of supermaps termed *enrichment* which is a mathematical translation of the idea that the basic structural features present in **C** (parallel and sequential composition) can be implemented as higher-order transformations [41]. In other words, there is typically a supermap of type  $\circ : [A, B][B, C] \rightarrow [A, C]$  which implements sequential composition viewed intuitively as

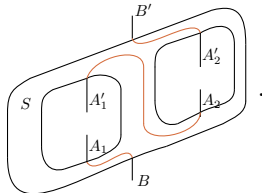

This simple observation, and a generally expected feature of theories of supermaps, motivates a further expected polycategorical feature of supermap composition. Polycategorical structure as witnessed by linear distributivity of the **Caus[C]** construction allows us to unambiguously give



meaning to

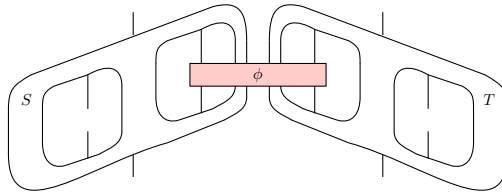

with the following diagram in the graphical language for polycategories.

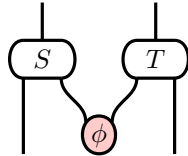

However, because polycategories can only be connected one leg at a time, there is no composition rule in the definition of a polycategory, which allows to give meaning to the following diagram

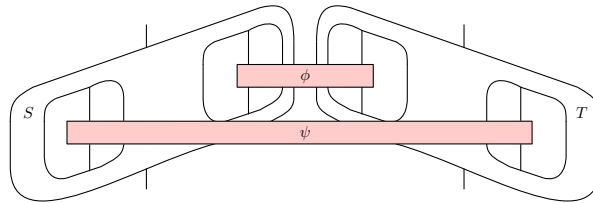

which would require the possibility to compose along more than one wire at-once, creating cycles

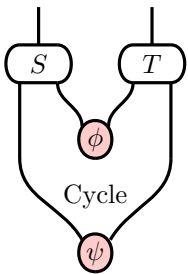

Indeed such a diagram should not be allowed since when combined with the structure of enrichment, it may be used to produce time loops as intuitively represented by the following diagram

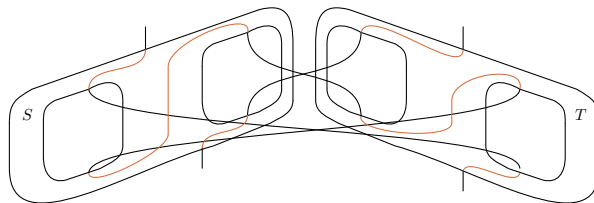

These observations point us towards the following goal, define supermaps for abstract symmetric monoidal categories in a way that allows us to freely construct a polycategorical enriched semantics for them, so that supermaps on abstract symmetric monoidal categories may be composed in complex ways whilst guaranteeing that time-loops never be formed.

In the classic approach to the definition of quantum supermaps, the Choi-Jamilkiowski isomorphism is leveraged, which identifies completely positive maps with positive operators. Here we will review the standard definition of quantum supermaps in a way that allows to briefly point out their polycategorical structure. The definition we give slightly generalizes the construction of a polycategory of second-order causal processes using the  $\mathbf{Caus}[\mathbf{C}]$  construction by never referencing the concept of causality. In category-theoretic terms, the C-J isomorphism is the observation of compact closure of the category  $\mathbf{CP}$  and it is compact closure when present which allows for a convenient definition of supermaps:

**Definition 5** (**P-Supermaps**). *Let  $\mathbf{C} \subseteq \mathbf{P}$  be an embedding of a symmetric monoidal category  $\mathbf{C}$  into a compact closed category  $\mathbf{P}$ , a morphism*

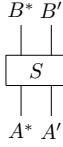

in  $\mathbf{P}$  is a **P-supermap** on  $\mathbf{C}$  of type  $S : [A, A'] \rightarrow [B, B']$  if and only if for every  $\phi \in \mathbf{C}(A \otimes X, A' \otimes X')$  then

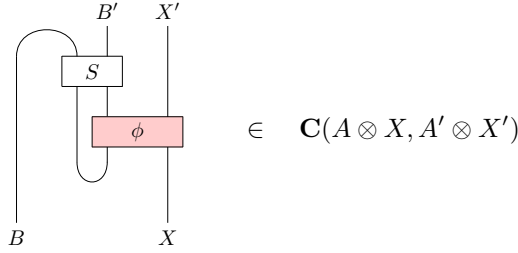

When a category has states and effects a meaningful generalization can be given for supermaps of type  $K \rightarrow M$  with  $K \subseteq \mathbf{C}(A, A')$  and  $M \subseteq \mathbf{C}(B, B')$ , however since there are no such states or effects in the category of unitaries we prefer to use the above definition which is less general for other categories such as  $\mathbf{QC}$  but can be written in the more familiar standard category-theoretic language. Given that the category of unitaries does not have a meaningful internalized notion of reduction of an extended process by auxiliary states and effects we will separately introduce a definition for unitaries of multi-party supermaps.

**Definition 6.** *Let  $\mathbf{C} \subseteq \mathbf{P}$  be an embedding of a symmetric monoidal category  $\mathbf{C}$  into a compact closed category  $\mathbf{P}$ , a morphism*

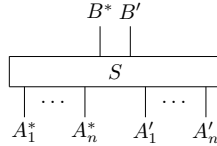

in  $\mathbf{P}$  is a **P-supermap** on  $\mathbf{C}$  of type  $S : \Gamma \rightarrow [B, B']$  if and only if for every  $\underline{A}_i := [A_i, A'_i]$  of  $\Gamma$  and

family  $\phi_i \in \mathbf{C}(A_i \otimes X_i, A'_i \otimes X'_i)$  then

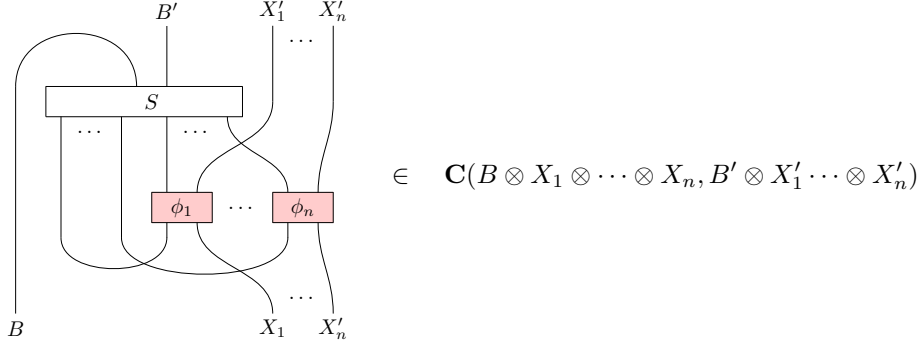

**Lemma 1.** A symmetric polycategory  $\mathbf{polyPsup}[\mathbf{C}]$  can be defined with objects given by pairs  $[A, A']$  of objects of  $\mathbf{C}$  and morphisms of type  $S : \Gamma \rightarrow \Delta$  given by the  $\mathbf{P}$ -supermaps of type  $S : \Gamma \rightarrow \Delta$

*Proof.* Given in the appendix □

**Definition 7** (Quantum Supermaps). For brevity we refer to the  $\mathbf{fCP}$ -supermaps on  $\mathbf{fQC}$  as Quantum Supermaps and the corresponding polycategory is referred to as  $\mathbf{QS}$ , we furthermore refer to the  $\mathbf{fHilb}$ -supermaps on  $\mathbf{fU}$  as Unitary Supermaps with the corresponding polycategory denoted  $\mathbf{uQS}$

**Locally-Applicable Transformations** In this section we review a characterization of quantum supermaps as certain types of natural transformations [24], this removes the need to reference an ambient category such as  $\mathbf{P}$  into which the category  $\mathbf{C}$  embeds when defining supermaps. The goal of the paper will be to extend this natural transformation definition of supermap so that it is strong enough to (a) recover unitary supermaps when applied to the category of unitaries (b) extend supermaps to infinite dimensions in a satisfactory way (c) construct a polycategorical enriched semantics for composition-without-time-loops of supermaps on arbitrary symmetric monoidal categories.

The notion of a supermap, a higher-order transformation that can be applied locally to lower-order transformations, appears to need only one primitive notion to be made sense of, that of processes with multiple inputs and outputs so that one may speak of *local* application:

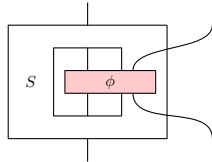

All together this gives the sense that supermaps ought to be definable at the level of the monoidal structure of quantum theory, without reference to additional mathematical structures such as compact closure. In the case of the  $\mathbf{CP}$ -supermaps on  $\mathbf{QC}$  a monoidal characterization has recently been found by the authors using a categorical notion of *locally-applicable transformation*. We will generally choose to write the action  $S_{X, X'}(\phi)$  of any function  $S_{X, X'} : \mathbf{C}(A \otimes X, A' \otimes X') \rightarrow$

$\mathbf{C}(B \otimes X, B' \otimes X')$  on some  $\phi \in \mathbf{C}(A \otimes X, A' \otimes X')$  as:

$$S_{X, X'}(\phi) := \begin{array}{c} \begin{array}{|c|} \hline X' \\ \hline \begin{array}{|c|} \hline \phi \\ \hline \end{array} \\ \hline X \\ \hline \end{array} \\ \hline \end{array}$$

**Definition 8** (locally-applicable transformations). *A locally-applicable transformation of type  $S : [A, A'] \rightarrow [B, B']$  is a family of functions  $S_{X, X'}$  satisfying*

$$\begin{array}{c} \begin{array}{|c|} \hline \begin{array}{|c|} \hline \begin{array}{|c|} \hline g \\ \hline \end{array} \\ \hline \phi \\ \hline \begin{array}{|c|} \hline f \\ \hline \end{array} \\ \hline \end{array} \\ \hline \end{array} \\ \hline \end{array} = \begin{array}{c} \begin{array}{|c|} \hline g \\ \hline \begin{array}{|c|} \hline \phi \\ \hline \end{array} \\ \hline f \\ \hline \end{array} \\ \hline \end{array}$$

The locally applicable transformations define a category  $\mathbf{lot}[\mathbf{C}]$  with objects given by pairs  $[A, A']$  and morphisms  $[A, A'] \rightarrow [B, B']$  given by locally applicable transformations of the same type.  $\mathbf{P}$ -supermaps on a category  $\mathbf{C}$  always define locally-applicable transformations on  $\mathbf{C}$ , as witnessed by a faithful functor  $\mathcal{F}_{\mathbf{P}} : \mathbf{Psup}[\mathbf{C}] \rightarrow \mathbf{lot}[\mathbf{C}]$ . This functor is given explicitly by

$$\mathcal{F}_{\mathbf{P}} \left( \begin{array}{c} B^* \ B' \\ \hline S \\ \hline A^* \ A' \end{array} \right)_{XX'} := \begin{array}{c} \begin{array}{|c|} \hline S \\ \hline \phi \\ \hline \end{array} \\ \hline \end{array}$$

In [24] it is proven that there is an equivalence between the quantum supermaps and the locally-applicable transformations on  $\mathbf{QC}$ .

**Theorem 4.** *There is a one-to-one correspondence between the locally-applicable transformations of type  $[A, A'] \rightarrow [B, B']$  on  $\mathbf{QC}$  and the quantum supermaps of the same type [24].*

As we will observe in the main text of the paper, there is no such correspondence between the locally-applicable transformations on  $\mathbf{U}$  and the Unitary supermaps, a stronger notion, that of being a *slot* will be further required. We finish the preliminary material by noting that locally-applicable transformations admit a simple multi-party generalization.

**Definition 9.** *A locally-applicable transformation of type  $[A_1, A'_1] \dots [A_n, A'_n] \rightarrow [B, B']$  is a family of functions  $S_{E_1 \dots E_n}^{E'_1 \dots E'_n}$  satisfying:*

$$\begin{array}{c} \begin{array}{|c|} \hline B' \\ \hline \begin{array}{|c|} \hline S \\ \hline \begin{array}{|c|} \hline \begin{array}{|c|} \hline g_1 \\ \hline \phi_1 \\ \hline f_1 \\ \hline \end{array} \\ \hline \dots \\ \hline \begin{array}{|c|} \hline g_n \\ \hline \phi_n \\ \hline f_n \\ \hline \end{array} \\ \hline \end{array} \\ \hline \begin{array}{|c|} \hline X_1 \\ \hline \dots \\ \hline X_n \\ \hline \end{array} \\ \hline B \\ \hline \end{array} \\ \hline \end{array} = \begin{array}{c} \begin{array}{|c|} \hline B' \\ \hline \begin{array}{|c|} \hline S \\ \hline \begin{array}{|c|} \hline \phi_1 \\ \hline \end{array} \\ \hline \dots \\ \hline \begin{array}{|c|} \hline \phi_n \\ \hline \end{array} \\ \hline \begin{array}{|c|} \hline X_1 \\ \hline \dots \\ \hline X_n \\ \hline \end{array} \\ \hline \begin{array}{|c|} \hline f_1 \\ \hline \dots \\ \hline f_n \\ \hline \end{array} \\ \hline B \\ \hline \end{array} \\ \hline \end{array}$$

These multiple-input locally-applicable transformations do not appear to come with a natural polycategorical structure, instead being equipped with a weaker notion of multi-categorical structure [56], which allows for multiple inputs but only a single output, allowing to draw the following kinds of string diagrams

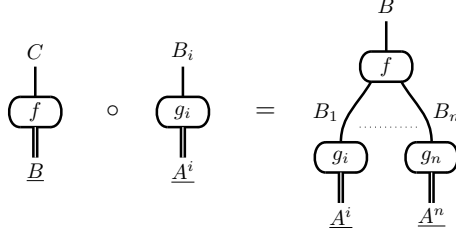

**Lemma 2** (The multicategory of locally-applicable transformations). *A multi-category  $\mathbf{lot}[\mathbf{C}]$  can be defined which has as objects pairs  $[A, A']$  and as multi-morphisms from  $[A_1, A'_1] \dots [A_n, A'_n]$  to  $[B, B']$  the locally-applicable transformations of type  $[A_1, A'_1] \dots [A_n, A'_n] \rightarrow [B, B']$ . Composition is given graphically by taking  $S \circ (T^1 \dots T^m)(\phi_i^j)$  to be*

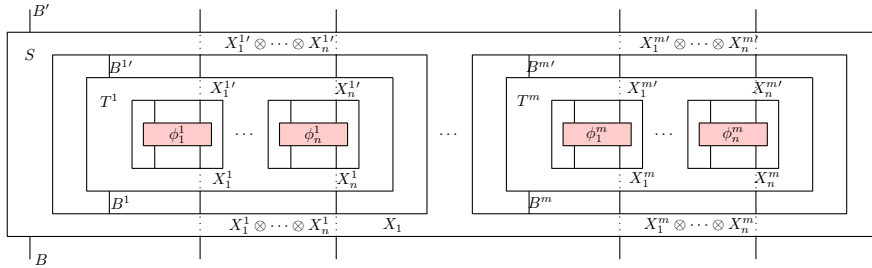

Since we have seen motivation for developing a polycategorical semantics for supermaps, the fact that it is only clear how to give locally-applicable transformations a multi-categorical structure is a sign that stronger conditions are required to provide polycategorical semantics, this is essentially the same issue as the inability to give a suitable monoidal product for locally-applicable transformations. The above difficulty is discussed in more detail in the next section, after which two strengthenings of locally applicable transformations are developed each of which characterizes the unitary supermaps and on arbitrary symmetric monoidal categories freely provides a polycategorical rather than multi-categorical structure.

### 3 The Need for a Stronger Definition than Locally Applicable Transformation

In this section we show why locally-applicable transformations are not strong enough to satisfy our two goals, in the course of doing so we introduce a few definitions which will be used throughout the paper.

- First, we wish to reconstruct unitary supermaps from only the monoidal structure of the category of unitaries. However, locally-applicable transformations on unitaries are more general than unitary supermaps, in other words there are locally-applicable transformations  $S^{loop} : [A, A'] \rightarrow [B, B']$  and  $S^V : [A, A'] \rightarrow [B, B']$  which cannot be implemented by unitary

supermaps of the same type. Put simply whilst it has been proven that  $\mathbf{lot}[\mathbf{fQC}] = \mathbf{QS}$  [24] it is not the case that

$$\mathbf{lot}[\mathbf{fU}] \neq \mathbf{uQS}$$

which means that we will need a stronger condition than that of a locally applicable transformation to tightly generalize the construct of supermaps to arbitrary symmetric monoidal categories.

- Second, we wish to reconstruct a monoidal and polycategorical semantics for the composition of general supermaps, locally-applicable transformations do not however generally satisfy the kind of interchange law we would require, in-fact it is exactly  $S^{loop}$  and  $S^V$  which do not commute when applied to separate parts of bipartite systems. Algebraically there does not appear to be a sensible notion of tensor product  $\otimes$  such that  $S^{loop} \otimes S^V$  can act on all bipartite processes *and*

$$(S^{loop} \otimes id) \circ (id \otimes S^V) = (id \otimes S^V) \circ (S^{loop} \otimes id)$$

This means that we will have to give a stronger condition to guarantee that we can give a formal semantics to the following intuitive picture:

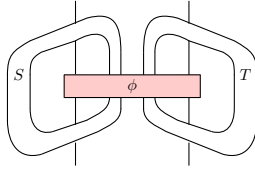

The locally-applicable transformations  $S^{loop}$  and  $S^V$  would give following ambiguity:

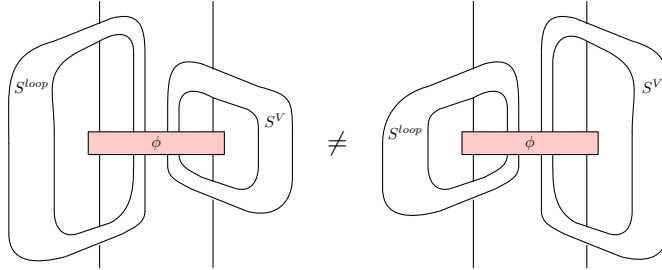

and so we consider them to be unsuitable for a formalisation of the intuitive concept of a hole.

We will introduce each problem separately in more detail, and then in the main paper we show that both problems can be addressed by the same definition of slot. A slot will be morphism in the centre, suitably defined, of the locally-applicable transformations. This definition naturally solves the problem of the interchange law by definition and in turn by forcing commutation with transformations such as  $S^{loop}$  and  $S^V$  this definition will be strong enough to tightly characterize the unitary supermaps. In short we will find that for any  $\mathbf{C}$  then  $\mathbf{slot}[\mathbf{C}]$  is monoidal,  $\mathbf{pslot}[\mathbf{C}]$  is a polycategory, and furthermore that  $\mathbf{pslot}[\mathbf{fU}] = \mathbf{uQS}$  and  $\mathbf{pslot}[\mathbf{fQC}] = \mathbf{QS}$ . Meaning that the polycategorical structure of supermaps can be generalized to arbitrary symmetric monoidal categories.

**Observation 1: locally-applicable transformations do not characterise unitary supermaps** Let us consider two locally-applicable transformations on the category of unitaries which will play an important role throughout this paper. Both classes are given by conditioning on properties of unitaries which due to the time-reversibility of  $\mathbf{U}$  cannot be affected by applying local unitaries to auxiliary systems. The first example of a locally-applicable transformation works by checking the signalling structure of a unitary and applying a time-loop whenever the signalling structure permits:

**Definition 10.** *The locally-applicable transformation  $S^{loop} : [A, A'] \rightarrow [B, B']$  is defined by taking  $S_{XX'}^{loop}(\phi)$  to be*

$$\begin{aligned}
 & \begin{array}{c} B' \quad X' \\ \vdots \quad \vdots \\ \boxed{S_{XX'}} \\ \vdots \quad \vdots \\ B \quad X \end{array} \quad := \quad \begin{array}{c} B' \quad X' \\ \vdots \quad \vdots \\ \boxed{\phi} \\ \vdots \quad \vdots \\ B \quad X \end{array} \quad \text{if} \quad \begin{array}{c} \boxed{\phi} \\ \vdots \quad \vdots \end{array} = \begin{array}{c} \boxed{R} \\ \vdots \quad \vdots \\ \boxed{L} \end{array} \quad (1) \\
 & \quad \quad \quad := \quad \begin{array}{c} \boxed{\phi} \\ \vdots \quad \vdots \end{array} \quad \text{if else} \quad (2)
 \end{aligned}$$

The second uses the signalling structure of the input unitary to decide whether to apply a local unitary:

**Definition 11.** *The locally-applicable transformation  $S^V : [A, A'] \rightarrow [B, B']$  is defined by taking  $S_{XX'}^V(\phi)$  to be*

$$\begin{aligned}
 & \begin{array}{c} B' \quad X' \\ \vdots \quad \vdots \\ \boxed{S_{XX'}} \\ \vdots \quad \vdots \\ B \quad X \end{array} \quad := \quad \begin{array}{c} \boxed{V} \\ \vdots \quad \vdots \\ \boxed{\phi} \\ \vdots \quad \vdots \end{array} \quad \text{if} \quad \begin{array}{c} \boxed{\phi} \\ \vdots \quad \vdots \end{array} = \begin{array}{c} \boxed{R} \\ \vdots \quad \vdots \\ \boxed{L} \end{array} \quad (3) \\
 & \quad \quad \quad := \quad \begin{array}{c} \boxed{\phi} \\ \vdots \quad \vdots \end{array} \quad \text{if else} \quad (4)
 \end{aligned}$$

Each definition indeed gives a locally-applicable transformation on the category of unitaries. Neither of  $S^{loop}$  or  $S^V$  are however implementable by unitary supermaps.

**Lemma 3.** *Let  $S : [A, A] \rightarrow [A, A]$  be a  $\mathbf{P}$ -supermap on  $\mathbf{U}$  such that  $\mathcal{F}_{\mathbf{P}}(S) = S^{loop}$ , then  $A = I \cong \mathbb{C}$ .*

*Proof.* Assume that there exists some  $S : A^* \otimes A' \rightarrow B^* \otimes B'$  such that:

$$\begin{array}{c} \boxed{S^{loop}} \\ \vdots \quad \vdots \\ \boxed{\phi} \\ \vdots \quad \vdots \end{array} = \mathcal{F}_{\mathbf{P}} \left( \begin{array}{c} B^* \quad B' \\ \vdots \quad \vdots \\ \boxed{S} \\ \vdots \quad \vdots \\ A^* \quad A' \end{array} \right)_{XX'} = \begin{array}{c} B' \quad X' \\ \vdots \quad \vdots \\ \boxed{S} \\ \vdots \quad \vdots \\ \boxed{\phi} \\ \vdots \quad \vdots \\ B \quad X \end{array}$$

For an arbitrary object  $A$  consider the identity  $id_A$ , then:

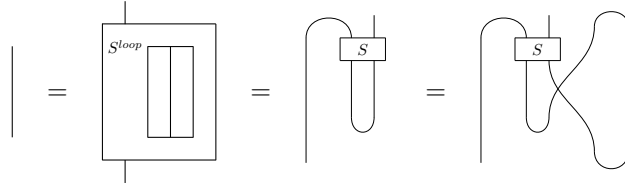

Now returning to function box representation:

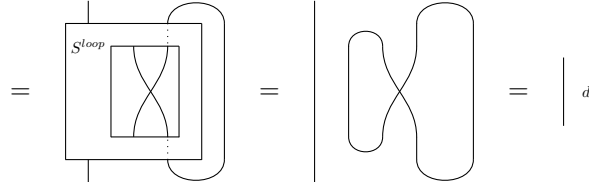

It follows that

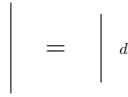

Which in  $\mathbf{U}$  is a contradiction unless  $d_A = 1$  so that  $A \cong \mathbb{C}$ . □

A similar proof applies to the locally applicable transformation  $S^V$ .

**Problem 2: locally-applicable transformations cannot be composed in parallel** Intu-

itively we imagine that given access to a bipartite process  $\phi : A \otimes B \rightarrow A' \otimes B'$ , one could imagine applying some supermap  $S \boxtimes T$  which represents acting with  $S : [A_1, A'_1] \rightarrow [A_2, A'_2]$  on the left hand side and with  $T : [B_1, B'_1] \rightarrow [B_2, B'_2]$  on the right hand side:

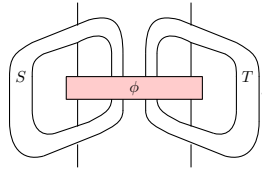

To show the approximate issues imagine defining the application on the right hand side for  $T$  by

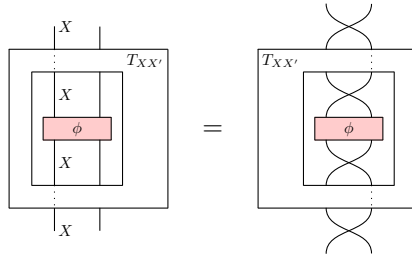

One could hope to give meaning to the picture representing some notion of  $(id \otimes S^V) \circ (S^{loop} \otimes id)$  by

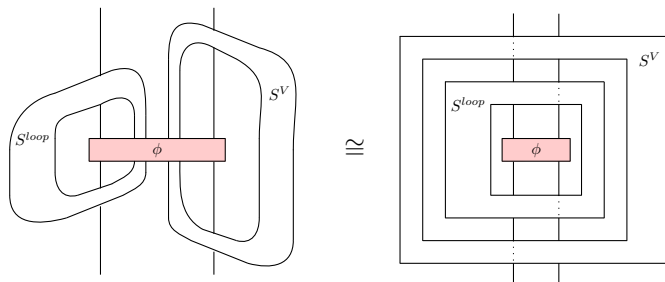



Analogously we can write what we would hope to be the diagram representing  $(S^{loop} \otimes id) \circ (id \otimes S^V)$ :

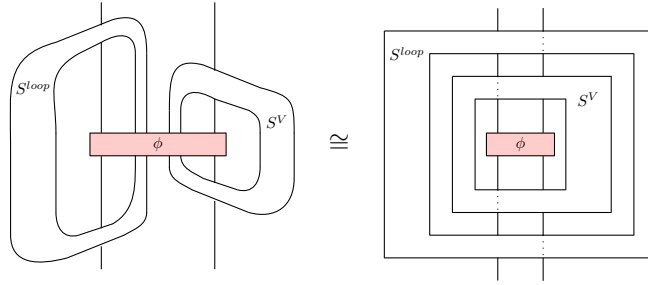

In a monoidal category these two terms would need to be the same, however, for the specific locally-applicable transformations chosen this is not the case, as witnessed by each terms action on the swap. First note that:

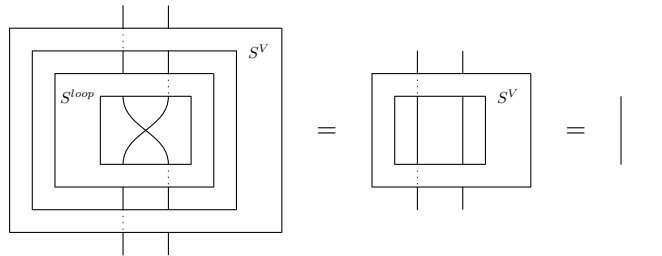

and yet:

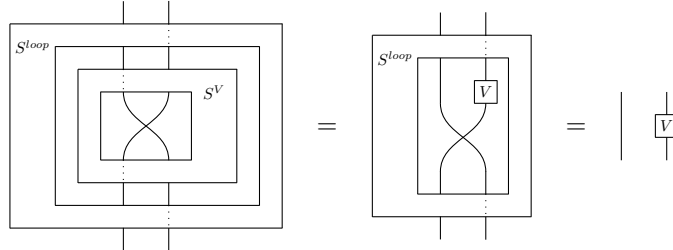

Consequently, we observe the following, the locally-applicable transformations on unitaries which are *not* unitary supermaps appear to be those which can be used to fail the interchange law. In the main contributions of this paper, we formalize this observation, showing that those locally-applicable transformations which are guaranteed to satisfy the interchange law, are exactly those which can be implemented as unitary supermaps. We call these (strongly) locally-applicable transformations *slots*.

## 4 Solution: Polyslots

We motivate two constructions  $\mathbf{slot}[\mathbf{C}]$  and  $\mathbf{pslot}[\mathbf{C}]$  by the attempt to define the parallel composition of locally-applicable transformations. When trying to define such a parallel composition rule we will find that we need to still allow for auxiliary systems on a further third pair of wires,

consequently we choose to introduce the following notation.

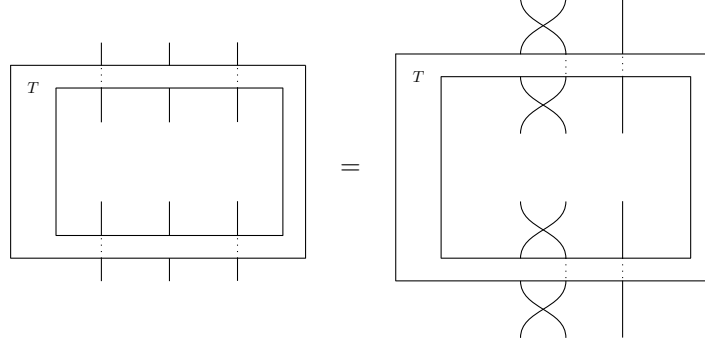

To construct from all locally-applicable transformations those which can be composed in parallel we consider only these  $S$  which commute with all other locally applicable transformations  $T$  in the following sense. We will call these **Strongly LOcally-applicable T**ransformations **slots**.

**Definition 12.** A slot of type  $S : [A_1, A'_1] \rightarrow [A_2, A'_2]$  is a locally-applicable transformation of the same type such that for every locally-applicable transformation  $T : [B_1, B'_1] \rightarrow [B_2, B'_2]$  and  $\phi \in \mathbf{C}(A_1 \otimes B_1 \otimes X, A'_1 \otimes B'_1 \otimes X')$  then:

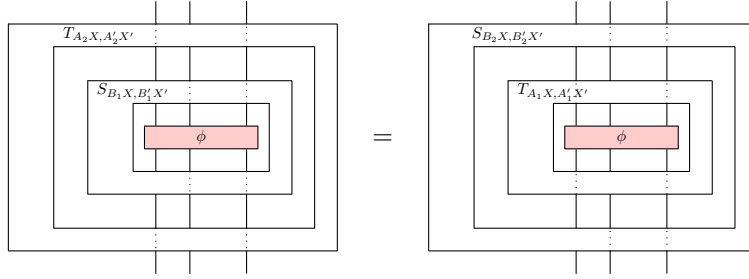

The corresponding category  $\mathbf{slot}[\mathbf{C}] \subseteq \mathbf{lot}[\mathbf{C}]$  is defined by keeping all objects and all locally-applicable transformations which are slots.

So in intuitive terms, slots are those functions that are so local, that they commute not only with combs but with all other functions which commute with combs. Either of these commuting expressions can be used to define the parallel composition of slots. Intuitively the monoidal product takes two slots  $S, T$  and views them as a new single-slot  $S \boxtimes T$  which can be used in the following way:

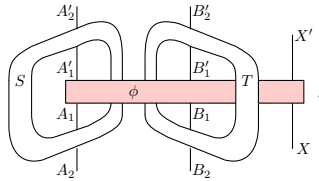

That both of the expressions in the definition of a slot are required to be equal guarantees unambiguous interpretation of the above picture and the required interchange law for symmetric monoidal categories.

**Theorem 5.** The category  $\mathbf{Slot}[\mathbf{C}]$  is symmetric monoidal with:

- $[A, A'] \boxtimes [B, B'] = [A \otimes B, A' \otimes B']$

- $(S \boxtimes T)_{X, X'}$  given by:

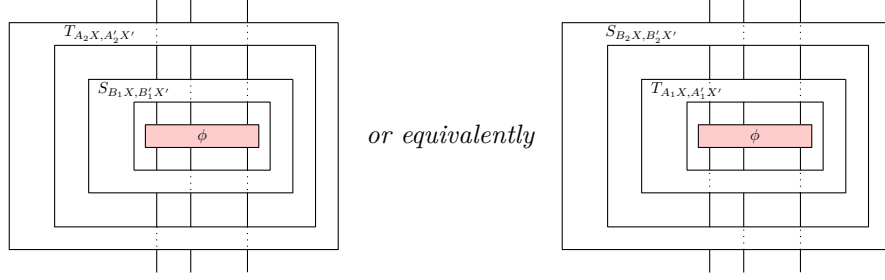

*Proof.* Given in the appendix □

The definition of a slot can be generalized to slots with multiple inputs, which we pre-emptively refer to as *polyslots*. From here on, when monoidal products of lists of wires or morphisms need to be expressed, we use doubled wires.

**Definition 13** (Multi-party slots). Let  $\underline{\mathbf{A}}$  be a list with each element of the form  $\mathbf{A}_i = [A_i, A'_i]$  for some objects  $A_i, A'_i$  of  $\mathbf{C}$ , a poly-slot of type  $S : \underline{\mathbf{A}} \rightarrow [B, B']$  is a locally-applicable transformation of type  $\underline{\mathbf{A}} \rightarrow [B, B']$  such that for every  $k$  and every  $\underline{\phi}_{1 \dots k-1}, \underline{\phi}_{k+1 \dots |\underline{\mathbf{A}}|}$  then the family of functions given by

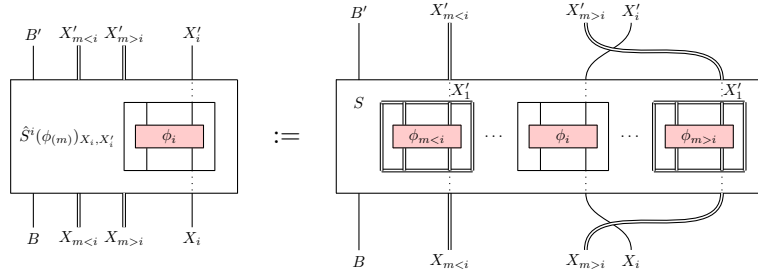

Is a slot of type

$$S^i(\phi(m)) : [A_i, A'_i] \rightarrow [B \otimes X_{m<i} \otimes X_{m>i}, B' \otimes X'_{m<i} \otimes X'_{m>i}]$$

**Theorem 6.** The polyslots on  $\mathbf{C}$  define a polycategory  $\mathbf{pslot}[\mathbf{C}]$  with:

- Objects given by pairs  $[A, B]$  with  $A, B$  objects of  $\mathbf{C}$
- Poly-morphisms of type  $S : \underline{\mathbf{A}} \rightarrow \Theta$  given by polyslots of type  $S : [A_1, A'_1] \dots [A_n, A'_n] \rightarrow [B_1 \otimes \dots \otimes B_m, B'_1 \otimes \dots \otimes B'_m]$
- Composition  $T \circ_M S$  of  $S : \underline{\mathbf{A}} \rightarrow \underline{\mathbf{BMC}}$  and  $S : \underline{\mathbf{DME}} \rightarrow \underline{\mathbf{F}}$  given by taking  $T \circ_M S(d_{(i)}, a_{(j)}, e_{(k)})$  to be

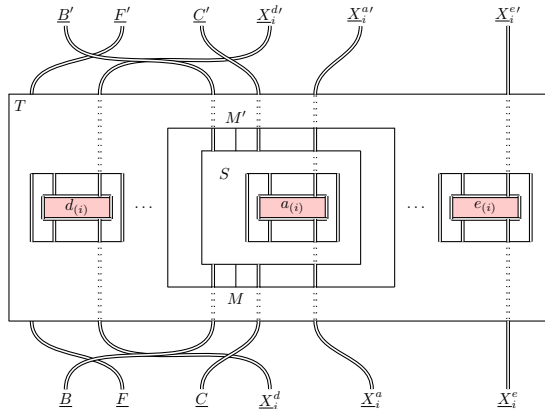

*Proof.* Given in the appendix □

#### 4.1 Single-Party Representable Supermaps

Here we give a minimal construction that generalizes the multiparty unitary and CPTP supermaps to arbitrary categories, the construction works by leveraging a structural theorem for unitary and CPTP supermaps, that they always decompose *locally* as combs. We will find that this construction is a special case of the definition of polyslot.

**Definition 14.** A single-party representable supermap of type

$$S : [A_1, A'_1] \dots [A_N, A'_N] \rightarrow [B, B']$$

is a family of functions

$$S_{X_1 \dots X_N, X'_1 \dots X'_N} : \mathbf{C}(A_1 X_1, A'_1 X'_1) \dots \mathbf{C}(A_N X_N, A'_N X'_N) \rightarrow \mathbf{C}(B X_1 \dots X_N, B'_1 X'_1 \dots X'_N)$$

such that for every  $i$  and family of morphisms  $\phi_{(m)}$  with  $m \in \{1 \dots (i-1)(i+1) \dots n\}$  there exists  $S(\phi_{(m)})_i^u$  and  $S(\phi_{(m)})_i^d$  satisfying

$$S_{X_1 \dots X_N, X'_1 \dots X'_N}(\phi_1 \dots \phi_i \dots \phi_N) = \begin{array}{c} B' \quad X'_1 \quad X'_i \quad X'_N \\ \hline S(\phi_{(m)})_i^u \\ \hline \phi_i \\ \hline S(\phi_{(m)})_i^d \\ \hline B \quad X_1 \quad X_i \quad X_N \end{array} .$$

**Lemma 4.** Single-party representable supermaps of type  $S : [A_1, A'_1] \dots [A_N, A'_N] \rightarrow [B, B']$  are locally applicable transformations of the same type.

*Proof.* We define

$$\begin{array}{c} \psi_i \\ \hline \end{array} = \begin{array}{c} g_i \\ \hline \phi_i \\ \hline f_i \end{array}$$

and then use locally representability to say that:

$$\begin{array}{c} B' \\ \hline S \\ \hline \begin{array}{c} X'_1 \\ \hline g_1 \\ \hline \phi_1 \\ \hline f_1 \\ \hline X_1 \end{array} \dots \begin{array}{c} X'_i \\ \hline g_i \\ \hline \phi_i \\ \hline f_i \\ \hline X_i \end{array} \dots \begin{array}{c} X'_n \\ \hline g_n \\ \hline \phi_n \\ \hline f_n \\ \hline X_n \end{array} \\ \hline B \end{array} = \begin{array}{c} B' \quad X'_1 \quad X'_i \quad X'_N \\ \hline S(\psi_{(m)})_i^u \\ \hline g_i \\ \hline \phi_i \\ \hline f_i \\ \hline S(\psi_{(m)})_i^d \\ \hline B \quad X_1 \quad X_i \quad X_N \end{array}$$

finally using the interchange law for symmetric monoidal categories to write:

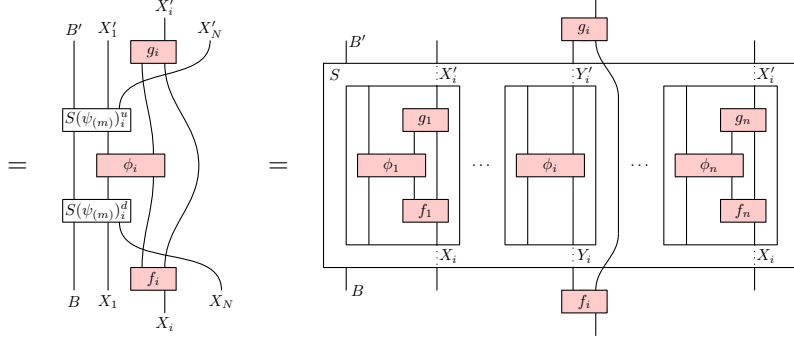

going through the same steps for every  $i$  completes the proof.  $\square$

We now note that single-party representable supermaps on  $\mathbf{C}$  form a poly-category.

**Theorem 7.** *The single-party representable supermaps on  $\mathbf{C}$  define a polycategory  $\mathbf{srep}[\mathbf{C}]$  with:*

- Objects given by pairs  $[A, B]$  with  $A, B$  objects of  $\mathbf{C}$
- Poly-morphisms of type  $S : \Gamma \rightarrow \Theta$  with  $\Gamma = [A_1, A'_1] \dots [A_n, A'_n]$  and  $\Theta = [B_1, B'_1] \dots [B_n, B'_n]$  given by single-party representable supermaps of type  $S : [A_1, A'_1] \dots [A_n, A'_n] \rightarrow [B_1 \otimes \dots \otimes B_m, B'_1 \otimes \dots \otimes B'_m]$
- Composition defined in the same way as for  $\mathbf{pslot}[\mathbf{C}]$

*Proof.* The composition rule is the same as that of  $\mathbf{pslot}[\mathbf{C}]$  and so is associative/unital. What must be checked is that the composition is still single-party representable. A careful proof is omitted but is a direct consequence of the fact that combs are closed under composition.  $\square$

**Lemma 5.** *For any symmetric monoidal category  $\mathbf{C}$  then  $\mathbf{srep}[\mathbf{C}] \subseteq \mathbf{pslot}[\mathbf{C}]$ , meaning that every single-party representable supermap of type  $S : [A_1, A'_1] \dots [A_n, A'_n] \rightarrow [B_1 \otimes \dots \otimes B_m, B'_1 \otimes \dots \otimes B'_m]$  is a polyslot of the same type.*

*Proof.* This follows from noting that each single-party representable supermap, when acting on its part of any of its input bipartite processes acts as a comb, which implies that it commutes with any other locally-applicable transformation.  $\square$

So, single-party representable supermaps, are a special case of the polyslots. We will find that when applied to unitaries of arbitrary dimension, however, the locality property of polyslots is strong enough to enforce representability. To frame this result we will require a generalization of traced monoidal categories to path-contraction categories. This will in turn give us a third way to define supermaps on the category of unitaries between separable Hilbert spaces.

## 5 Path Contraction Categories

We now consider pathing constraints, using relations between a choice of input and output decomposition to specify the ways in which a morphism decomposes. A more detailed discussion is given in [24], however, for the purposes of this paper we will only need to address a primitive

form of pathing constraint of interest in a variety of protocols in the field of quantum information processing. For any relation  $\tau$  we can define a set of processes  $\mathcal{E}_{path}(\tau)$  and we say that

$$\begin{array}{c} | \\ \hline \phi \\ \hline | \end{array} \in \mathcal{E}_{path} \left( \begin{array}{ccc} & B & X' \\ & \nearrow & \uparrow \\ A & & X \\ & \nwarrow & \downarrow \end{array} \right)$$

if and only if there exist processes 1, 2 such that

$$\begin{array}{c} | \\ \hline \phi \\ \hline | \end{array} = \begin{array}{c} | \\ \hline R \\ \hline | \\ \hline L \\ \hline | \end{array}$$

We say that 1, 2 serve as a *witness* for the satisfaction of the pathing constraint by  $\phi$ . The intuition is that the relation  $\tau$  serves to specify the systems between which it is permitted that there may be directed paths, indeed the decomposition above forbids the presence of a directed path from the bottom-right object to the top-left object. Whilst the above form is the most common considered in quantum information processing, we will more often be concerned with pathing constraints which naturally arise in the following form

$$\begin{array}{c} | \\ \hline \phi \\ \hline | \end{array} \in \mathcal{E}_{path} \left( \begin{array}{ccc} & \nearrow & \nearrow \\ \uparrow & & \downarrow \\ & \nwarrow & \nwarrow \end{array} \right)$$

which entails the following decomposition

$$\begin{array}{c} | \\ \hline \phi \\ \hline | \end{array} = \begin{array}{c} | \\ \hline R \\ \hline | \\ \hline L \\ \hline | \end{array}$$

A key step in our internalization theorem, of slots on unitaries as unitary supermaps, will be to observe that all unitary slots preserve non-pathing constraints of the above form. To allow us to phrase our results in a general form we define a generalization of compact closed, or trace monoidal category, which allows contracting input and output wires *when* the contraction is such that when pulled taught would give a morphism  $\mathbf{C}$ .

**Definition 15.** *The no-pathing functor  $np_{A \rightarrow B}(-, =) : \mathbf{C}^{op} \times \mathbf{C} \rightarrow \mathbf{Set}$  is defined by*

$$np_{A \rightarrow B}(X, X') := \mathcal{E}_{path} \left( \begin{array}{ccc} & B & X' \\ & \nearrow & \uparrow \\ A & & X \\ & \nwarrow & \downarrow \end{array} \right)$$

With respect to the families of sets specified by the no-pathing functor we can define path-contraction categories, as those categories in which such no-pathing constraints can be safely put together.

**Definition 16.** *A path-contraction category  $\mathbf{C}$  is a symmetric monoidal category  $\mathbf{C}$  equipped with a functor  $pc_A(-, =) : \mathbf{C}^{op} \times \mathbf{C} \rightarrow \mathbf{Set}$  satisfying*

$$np_{A \rightarrow A}(X, X') \subseteq pc_A(X, X') \subseteq \mathbf{C}(AX, AX')$$

and equipped with a natural transformation  $\eta_{X, X'} : pc_A(X, X') \rightarrow \mathbf{C}(X, X')$ , denoted in function-box notation as:

$$\eta(\phi \in \mathcal{E}(\tau)) := \begin{array}{c} \boxed{\begin{array}{c} | \\ \hline \phi \\ \hline | \end{array}} \end{array}$$

satisfying:

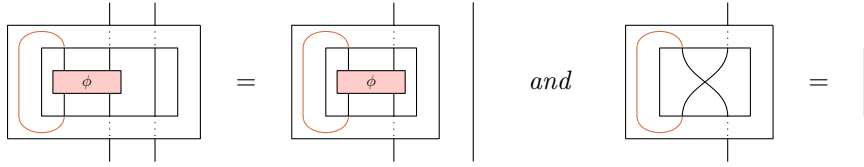

and furthermore such that whenever  $\phi \in pc_Z(YX, YX') \cap pc_Y(ZX, ZX')$  (up to swaps) and furthermore

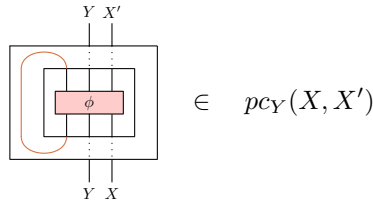

then

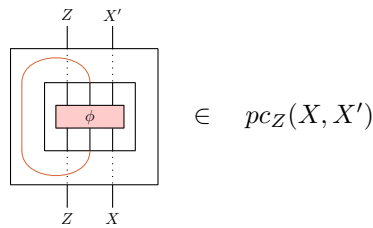

and furthermore

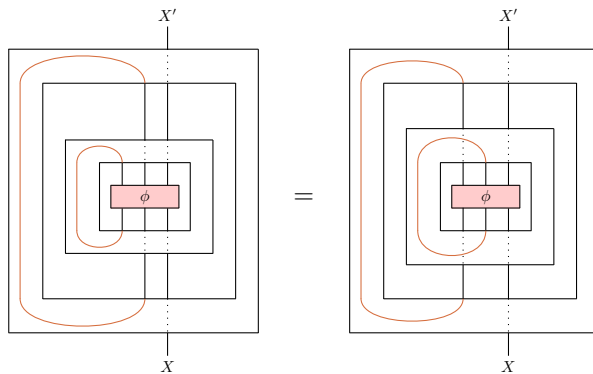

where again swaps have been used to define the contraction of wires which are not on the left-hand side. In general we refer to either of the above equivalent diagrams by

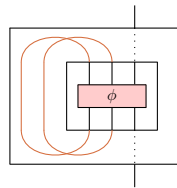

The above properties along with naturality are enough to ensure that contraction along any no-pathing process evaluates in an intuitive way:

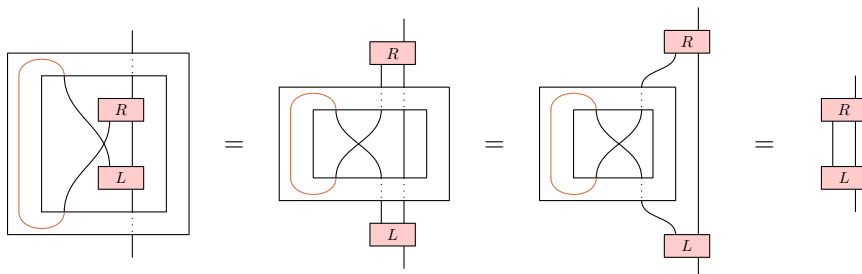

Note that whenever a category can be equipped with a path-contraction structure for some functors  $pc_A(X, X')$  then it can always be equipped with a path-contraction structure for the functors  $np_{A \rightarrow A}(X, X')$ .

**Example 1.** Any symmetric monoidal subcategory  $\mathbf{C}$  of a compact closed category  $\mathbf{P}$  is a path-contraction category with the natural transformation given by using the cup and cap

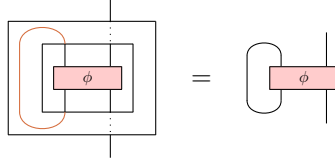

Consequently the category  $\mathbf{fU}$  of finite dimensional unitaries is a path contraction category via its embedding into  $\mathbf{fHilb}$ , as is the category  $\mathbf{fQC}$  of finite dimensional quantum channels via its embedding into  $\mathbf{fCP}$ .

As another direct corollary, any symmetric monoidal subcategory  $\mathbf{C}$  of a traced monoidal category  $\mathbf{P}$  is a path contraction category via its embedding into the free compact closed category over any traced monoidal category. Our motivation for working with path-contraction categories as opposed to categories that embed into compact closed categories is the ease with which they allow us to simultaneously discuss categories that include infinite-dimensional quantum systems. We take  $\mathbf{sepHilb}$  to be the category of bounded linear maps between separable Hilbert spaces, and furthermore take  $\mathbf{sepU} \subseteq \mathbf{sepHilb}$  to be the subcategory of unitary linear maps.

**Lemma 6.** The category  $\mathbf{sepU}$  of unitaries between separable Hilbert spaces is a path-contraction category.

*Proof.* In  $\mathbf{sepHilb}$  one can write the identity processes as the result of a limit called *resolution of the identity*:

$$| = \text{Lim}_{n \rightarrow \infty} \sum_{i=1}^n \begin{array}{c} \downarrow \\ \uparrow \end{array}$$

Furthermore  $\mathbf{sepHilb}$  has the property that limits commute with sequential and parallel composition, this is sufficient for us to define path contraction by

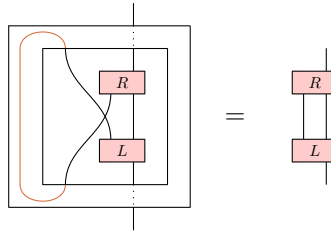

this is well defined since

$$\begin{array}{c} R \\ | \\ L \end{array} = \text{Lim}_{n \rightarrow \infty} \sum_{i=1}^n \begin{array}{c} R \\ \downarrow i \\ \uparrow i \\ L \end{array} = \text{Lim}_{n \rightarrow \infty} \sum_{i=1}^n \begin{array}{c} i \\ \downarrow \\ R \\ \uparrow \\ L \\ i \end{array}$$



so when

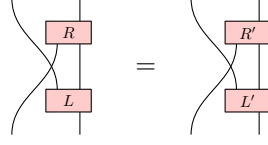

we can say that

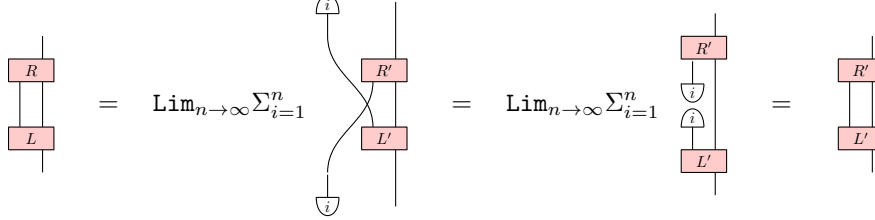

An alternative way to observe path contraction for  $\mathbf{sepHilb}$  is to note that the weak pseudo-functorial embedding  $\mathbf{trunc}[-]_w : \mathbf{sepHilb} \rightarrow \mathbf{Hilb}^*$  of  $\mathbf{sepHilb}$  into the compact closed 2-category  $\mathbf{Hilb}^*$  is sufficiently well-behaved to define path-contraction by using cups and caps of  $\mathbf{Hilb}^*$  [25]. We instead give the construction in terms of limits explicitly since we expect such technology to be more familiar to the wider physics community.  $\square$

Note that each of  $\mathbf{fU}$  and  $\mathbf{sepU}$  are groupoids.

**Definition 17.** A path-contraction groupoid is a path-contraction category in which every morphism is an isomorphism.

**Example 2.**  $\mathbf{fU}$  and  $\mathbf{sepU}$  are path-contraction groupoids.

Consequently the language of path-contraction groupoids will allow us to prove theorems simultaneously for unitaries on finite, and separable Hilbert spaces. We finish by noting the following

**Lemma 7.** In a groupoid, for every  $V : Y \rightarrow X$  and  $W : X' \rightarrow Y'$  then:

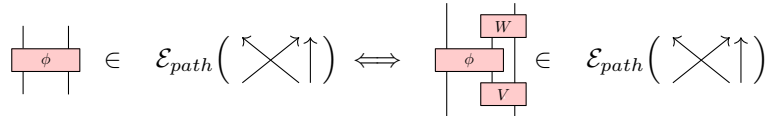

*Proof.* Given by invertibility of  $V, W$ .  $\square$

This lemma allows to generalize the definitions of  $S^V$  and  $S^{loop}$  to arbitrary path-contraction groupoids.

## 5.1 Path-Contraction Supermaps

Here we note that path-contraction structure when present can itself be used to construct a definition of supermap.

**Definition 18.** Let  $\mathbf{C}$  be a path-contraction category with functor  $pc_A(X, X')$ , then a path contraction supermap of type  $S : \Gamma \rightarrow [B, B']$  is any locally-applicable transformation of the same type

which takes the form

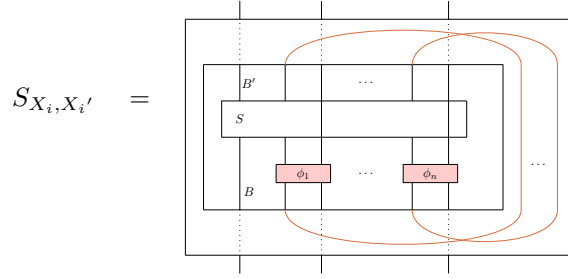

**Lemma 8.** *The path-contraction supermaps define a polycategory  $\mathbf{pathcon}[\mathbf{C}]$*

*Proof.* This is a straightforward generalization of the proof for  $\mathbf{P}$ -supermaps with  $\mathbf{P}$  a compact closed category. Indeed we note without proof from now on that given an embedding of a symmetric monoidal category  $\mathbf{C}$  into a compact closed category  $\mathbf{P}$  then the  $\mathbf{P}$ -supermaps are in one-to-one correspondence with the path-contraction-supermaps where the path-contraction functor is taken to be given by specifying (up to cups and caps) the set of all  $\mathbf{P}$ -supermaps.  $\square$

**Theorem 8.** *For any path contraction category  $\mathbf{C}$  then  $\mathbf{srep}[\mathbf{C}] \subseteq \mathbf{pathcon}[\mathbf{C}]$  meaning that every single-party representable supermap defines a path-contraction supermap*

*Proof.* Concretely we must show that any single-party representable supermap  $S : [A_1, A'_1] \dots [A_n, A'_n] \rightarrow [B, B']$  on a path contraction category  $\mathbf{C}$  can be implemented in terms of a process  $S^{int} : A'_1 \dots A'_n B \rightarrow A_1 \dots A_n B'$  of  $\mathbf{C}$  and path-contractions in the following way:

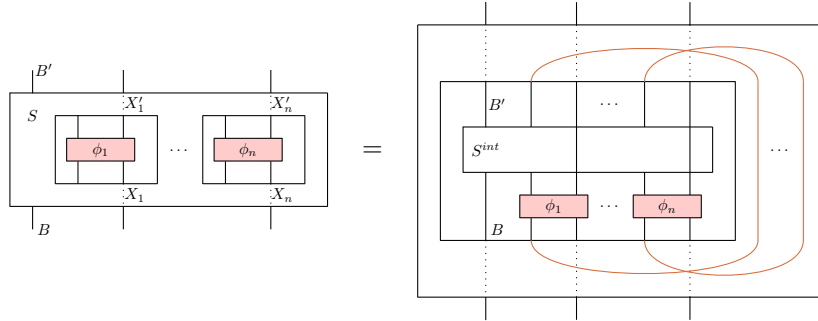

We give the proof for  $N = 2$ , the extension to general  $N$  is conceptually identical only heavier in notation. Define the required internal process by

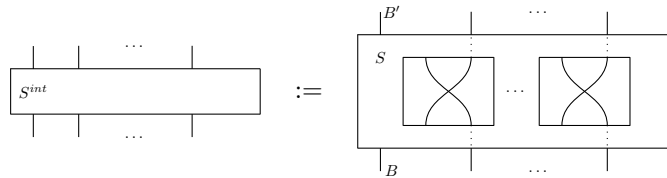

then consider the expression

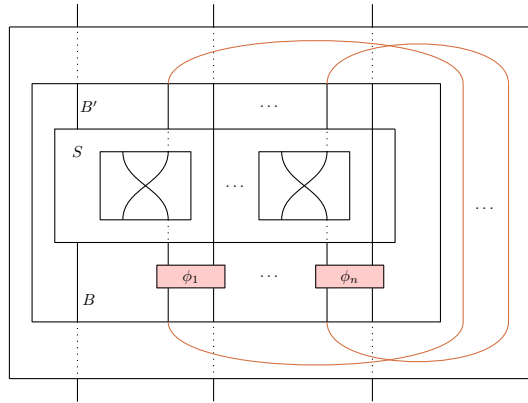

we must show that this is equal to  $S(\phi_1 \rightarrow \phi_n)$ . First by focusing on input 1 we can say that the above is equal to

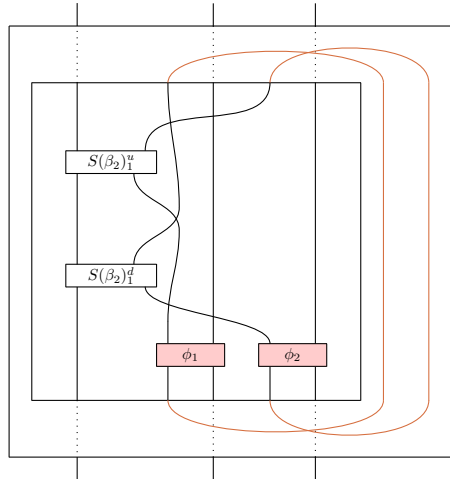



then undoing local-representability gives

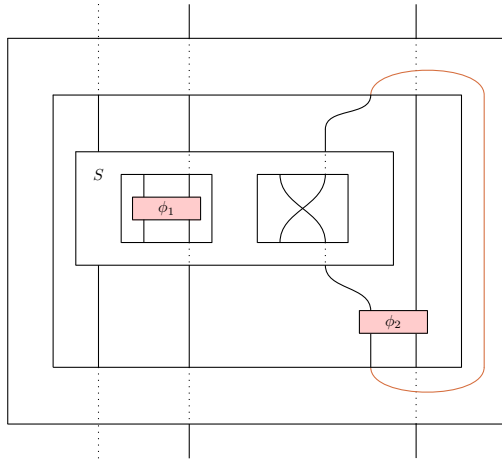

using analogous steps for  $\phi_2$  gives the result.  $\square$

## 6 Equivalence between slots, unitary supermaps, and single-party representable supermaps

Here we show that slots on path contraction groupoids can always be implemented by combs. We begin by showing that their action on swap morphisms always decomposes into a no-pathing morphism.

**Lemma 9** (Slots Preserve Signalling Constraints). *Let  $S : [A_1, A'_1] \rightarrow [A_2, A'_2]$  be a slot on a path-contraction groupoid  $\mathbf{G}$  then:*

$$\boxed{S} \text{ (swap)} \in \mathcal{E}_{\text{path}}(\uparrow \times \downarrow)$$

*Proof.* Assume that

$$\boxed{S} \text{ (swap)} \notin \mathcal{E}_{\text{path}}(\uparrow \times \downarrow)$$

then using commutativity of  $S$  with any  $S^V$  with  $V \neq id$  gives:

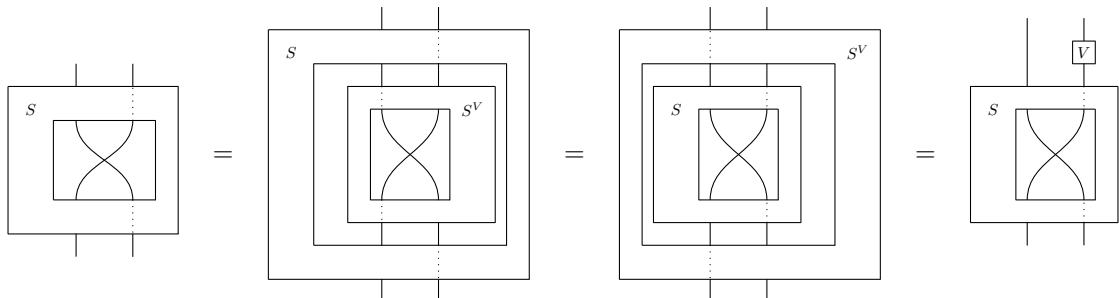

Using the fact that every morphism in  $\mathbf{G}$  is an isomorphism:

$$\Rightarrow \left| \begin{array}{c} | \\ | \\ | \end{array} \right| = \left| \begin{array}{c} | \\ \boxed{V} \\ | \end{array} \right|$$

and in any path-contraction groupoid  $\mathbf{G}$  we have  $i \otimes U = i \otimes W \implies U = W$ .  $\square$

Note that  $S^{loop}$  cannot be a slot, since it fails to satisfy the above condition, of preserving non-pathing constraints. Whilst the swap satisfies a non-pathing constraint:

$$\left( \begin{array}{c} \diagup \\ \diagdown \end{array} \right) \in \mathcal{E}_{path} \left( \left( \begin{array}{c} \uparrow \\ \downarrow \end{array} \right) \right)$$

The action of  $S^{loop}$  on the swap gives a signalling channel:

$$\boxed{S^{loop} \left( \begin{array}{c} \diagup \\ \diagdown \end{array} \right)} = \left| \begin{array}{c} | \\ | \\ | \end{array} \right| \notin \mathcal{E}_{path} \left( \left( \begin{array}{c} \uparrow \\ \downarrow \end{array} \right) \right)$$

We now give our main theorem, that slots on path-contraction groupoids are always combs, meaning that polyslots are always single-party representable.

**Theorem 9.** *For any path-contraction groupoid  $\mathbf{G}$  then  $\mathbf{pslot}[\mathbf{G}] = \mathbf{srep}[\mathbf{G}]$*

*Proof.* We use the fact that the action of  $S$  on the swap must be non-pathing, let  $U_1, U_2$  be morphisms which witness this non-pathing constraint, then using the fact that  $\mathbf{G}$  is a path-contraction category we can say that

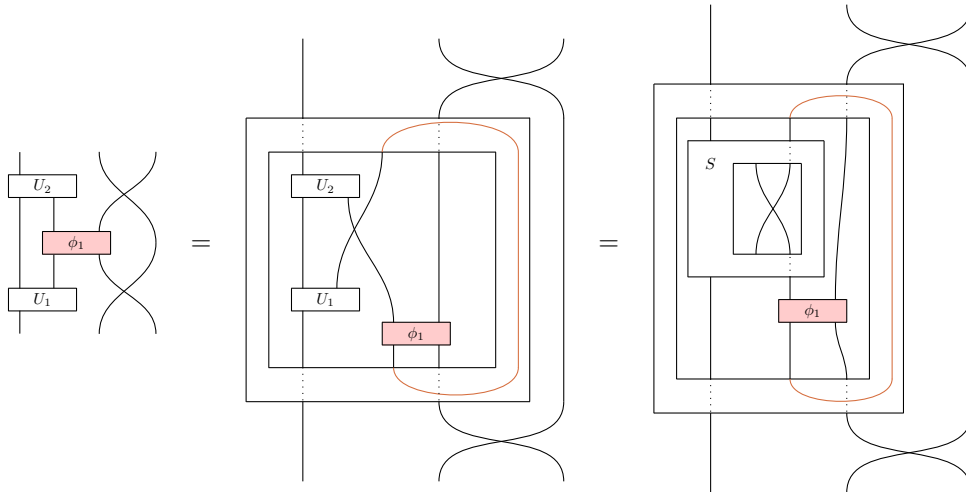

Now using the diagrammatic rules for locally-applicable transformations this in turn is equal to

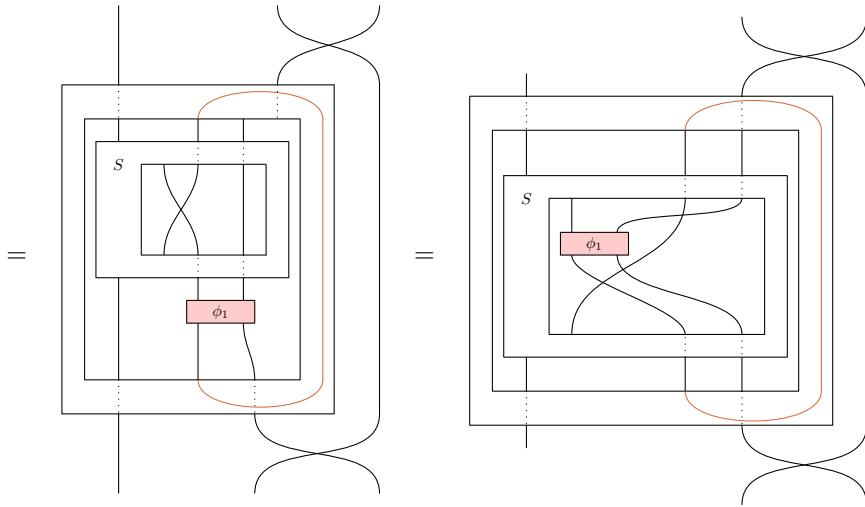

Then using the definition of  $S^{loop}$  and the fact that  $S$  is a slot

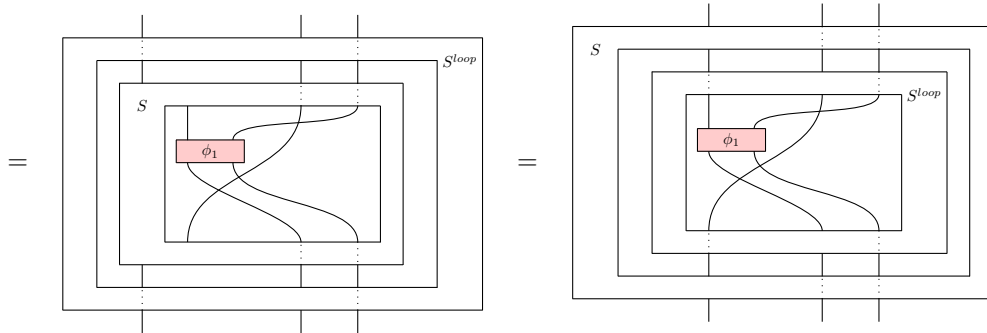

Then unpacking the definition of  $S^{loop}$  and using the laws for path-contraction categories and locally-applicable transformations gives

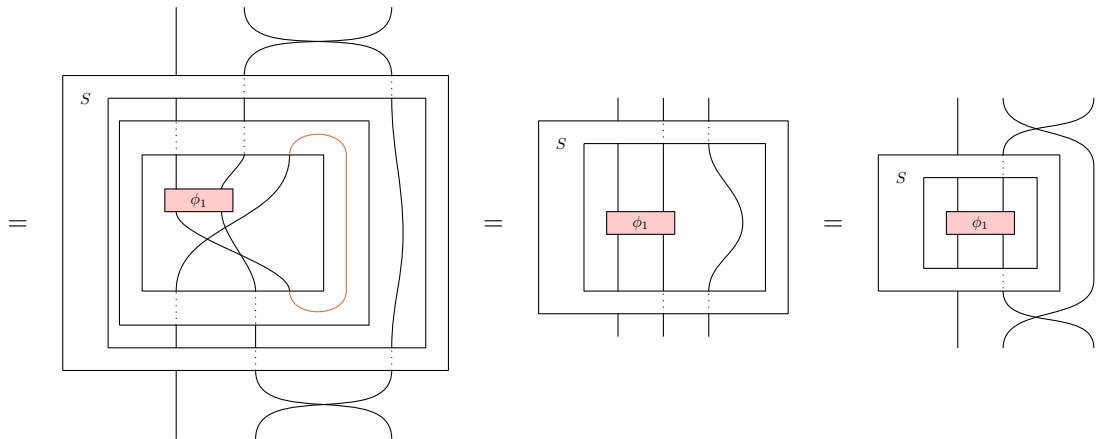

Finally since  $\mathbf{G}$  is a path contraction category this entails that

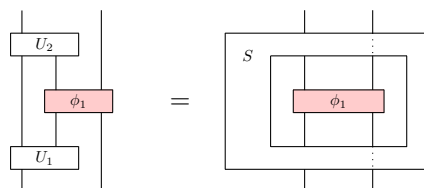

So far we have proven that any slot is given by a comb, now we consider a general multi-input polyslot. Focusing on some  $\phi_i$  we examine the family of functions  $S(\phi_{(1 \rightarrow n)_i})(\phi_i) := S(\phi_1 \dots \phi_i \dots \phi_n)$  with extensions  $X_i, X_i'$  omitted for readability and note that  $S(\phi_{(1 \rightarrow n)_i})(\phi_i)$  is up-to braiding a slot, and so by the previous lemma decomposes as a comb. This is true for all  $i$  so  $S$  is single-party representable.  $\square$

In general then, recalling that in any path-contraction category  $\mathbf{srep}[\mathbf{C}] \subseteq \mathbf{pathcon}[\mathbf{C}]$  we have that for any path-contraction groupoid  $\mathbf{pslot}[\mathbf{G}] = \mathbf{srep}[\mathbf{G}] \subseteq \mathbf{pathcon}[\mathbf{G}]$ . We now note that each of these constructions generalizes finite-dimensional unitary-preserving supermaps. Meaning that we have a generalization of unitary supermaps to arbitrary dimensions  $\mathbf{pslot}[\mathbf{C}]$  which (i) does not assume decomposition into combs at the single-party level (ii) only requires knowledge of the symmetric monoidal structure of  $\mathbf{C}$  to be specified (iii) when applied to finite-dimensional unitaries recovers the standard definition unitary-preserving supermaps. In combination with previous results for quantum channels, this observation constitutes our main result.

**Theorem 10.** *Polyslots generalize quantum supermaps on the quantum channels and on the unitaries to arbitrary symmetric monoidal categories. Formally, there is an equivalence*

$$\mathbf{pslot}[\mathbf{fU}] \cong \mathbf{uQS}$$

of polycategories for the unitary case and an equivalence

$$\mathbf{pslot}[\mathbf{fQC}] \cong \mathbf{QS}$$

of polycategories for the mixed case.

*Proof.* By earlier comments on equivalence between path-contraction supermaps and  $\mathbf{P}$ -supermaps with  $\mathbf{P}$  compact closed know that  $\mathbf{uQS} \cong \mathbf{pathcon}[\mathbf{fU}]$  and so  $\mathbf{pslot}[\mathbf{fU}] = \mathbf{srep}[\mathbf{fU}] \subseteq \mathbf{pathcon}[\mathbf{fU}] \cong \mathbf{uQS}$ . What remains is to show that  $\mathbf{uQS} \subseteq \mathbf{srep}[\mathbf{fU}]$ . In short, we must show that every unitary-preserving quantum supermap decomposes at the single-party level as a comb. Indeed, every quantum supermap of type  $[A, A'] \rightarrow [B, B']$  decomposes as a comb. In graphical terms meaning that any  $\mathbf{CP}$ -supermap on  $\mathbf{QC}$  decomposes as

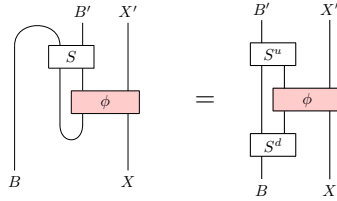

where  $S^u$  and  $S^d$  are quantum channels  $\in \mathbf{fQC}$ . A proof of this fact can be found in [2] which at its core relies on the causal decomposition theorem for no-signalling channels [42]. A first corollary of this result important for the following discussion is that the same may be said for unitary supermaps. Every single-party unitary supermap decomposes as a comb. In graphical terms meaning that any  $\mathbf{fHilb}$ -supermap on  $\mathbf{fU}$  decomposes as

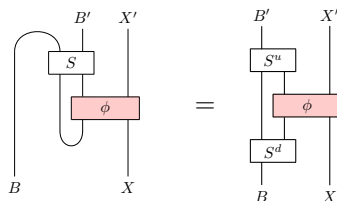



where  $S^u$  and  $S^d$  are unitaries  $\in \mathbf{fU}$ . Another consequence of this result is the following for multiparty supermaps. Every quantum supermap of type  $[A_1, A'_1] \dots [A_n, A'_n] \rightarrow [B, B']$  satisfies:

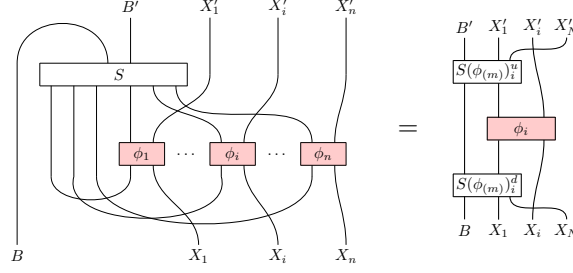

Where the  $S(\phi(m))_i^u$  and  $S(\phi(m))_i^d$  are quantum channels. The same may be said for unitary supermaps, which can be shown to be realized in the same way by unitary linear maps. This can be shown by noting that fixing all but  $\phi_i$ , the resulting map  $S(\phi_1, \dots, \phi_{i-1}(-)\phi_{i+1} \dots \phi_n)$  defines up to braiding a single party supermap, so by the previous lemma must decompose as a comb. Finally, the equivalence  $\mathbf{pslot}[\mathbf{fQC}] \cong \mathbf{QS}$  follows from noting that since the locally-applicable transformations of type  $\hat{S} : [A, A'] \rightarrow [B, B']$  are always given by  $\hat{S} = \mathcal{F}_{\mathbf{QC}}(S)$  for some quantum supermap of the same type, then the slot condition for  $\hat{S}$  (commutation) is inherited by the interchange law of  $\mathbf{fCP}$ .  $\square$

A key question which is the subject of current work by the authors is that of whether it is also the case that

$$\mathbf{pslot}[\mathbf{sepU}] \cong \mathbf{pathcon}[\mathbf{sepU}]$$

If this can be proven, then we can say confidently that there really is one-natural way to generalize unitary-preserving supermaps to infinite-dimensional quantum systems. Note that since  $\mathbf{sepU}$  is a path contraction groupoid we already know that

$$\mathbf{pslot}[\mathbf{sepU}] = \mathbf{srep}[\mathbf{sepU}] \subseteq \mathbf{pathcon}[\mathbf{sepU}]$$

So all that remains is to show, an infinite-dimensional analog of the canonical theorem of supermaps, that all possible path-contraction supermaps decompose at the single-party level as combs.

## 7 Application: Quantum Switch for Arbitrary Hilbert Spaces

On the category  $\mathbf{U}$  of unitaries between arbitrary Hilbert spaces, even beyond those which are separable, we can show that  $\mathbf{pslot}[\mathbf{U}]$  and  $\mathbf{srep}[\mathbf{U}]$  are broad enough to include generalisations of the quantum switch. We call a set  $\{\pi_k\} \subseteq \mathbf{Hilb}(Q, Q)$  a *control* if  $\pi_k \circ \pi_l = \delta_{k,l}$ .

**Definition 19** (The Quantum Switch for Arbitrary Hilbert Spaces). *The quantum switch on  $\mathbf{U}$  with control  $\{\pi_0, \pi_1\}$  is defined as a polyslot of type *Switch*:  $[A, A][A, A] \rightarrow [Q \otimes A, Q \otimes A]$  given*

by:

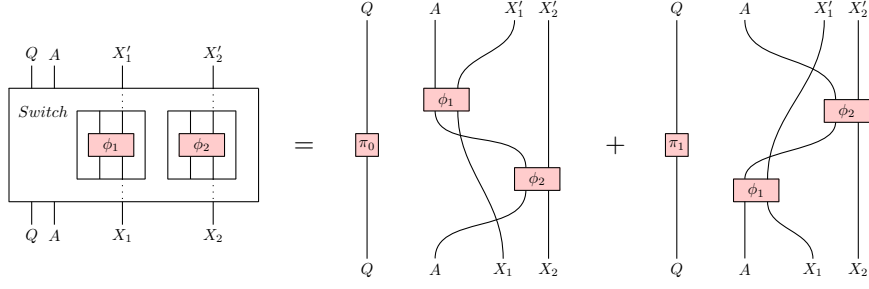

Where  $\pi_0 = |0\rangle\langle 0|$  and  $\pi_1 = |1\rangle\langle 1|$ .

Switch is a single-party representable polyslot since its action on  $\phi_2$  can be written as:

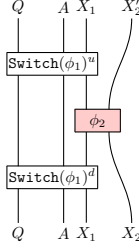

Where

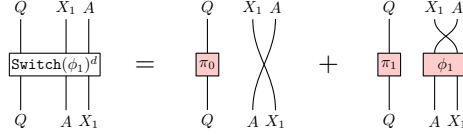

and

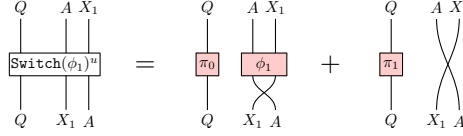

and similarly for the action on  $\phi_1$ . This definition naturally extends to N-party switches of type  $[A, A] \dots [A, A] \rightarrow [Q \otimes A, Q \otimes A]$ , it is the conjecture of the authors that all unitary preserving supermaps including those with break causal inequalities admit indefinite dimensional analogues which are polyslots and so single-party representable.

## 8 Summary

The construction  $\mathbf{pslot}[\mathbf{C}]$  satisfies a series of conditions which makes it a suitable generalization of the construction of quantum supermaps to arbitrary symmetric monoidal categories.

- The definition of  $\mathbf{pslot}[\mathbf{C}]$  only references the symmetric monoidal structure of  $\mathbf{C}$
- The definition of  $\mathbf{pslot}[\mathbf{C}]$  does not assume the decomposition of supermaps into combs when viewed by individual parties, instead, this property is derived by the principle of locality
- The structure  $\mathbf{pslot}[\mathbf{C}]$  has enriched polycategorical semantics, which allows for sequential and parallel composition without allowing the formation of time-loops.
- $\mathbf{pslot}[\mathbf{C}]$  generalises the construction of unitary and standard quantum supermaps to arbitrary symmetric monoidal categories in the sense that  $\mathbf{pslot}[\mathbf{fU}] = \mathbf{uQS}$  and  $\mathbf{pslot}[\mathbf{fQC}] = \mathbf{QS}$ .

Consequently, polyslots have a variety of properties making them suitable for the analysis and definition of supermaps for infinite-dimensional systems. A series of structural theorems guarantee the local realisability of polyslots as combs and the global realisability of polyslots by general internal processes with path-contraction, along with their inherited linearity. Left open is the question of whether in the case of  $\mathbf{C} = \mathbf{sepU}$  the polyslots include all possible supermaps that could be defined by applying time-loops to unitaries on Hilbert spaces of separable dimension. Finally, polyslots are broad enough to include infinite-dimensional generalizations of canonical processes of interest such as the quantum switch, consequently polyslots provide a theory-independent definition of supermap with nice enough properties in the quantum realm to provide a potentially handy toolbox in the extension of the study of indefinite causal structure to infinite dimensions.

## 9 Outlook

There are at least 6 natural ways in which the work of this paper could be built upon

- Whilst the language used in this paper is that of category theory, the theorems proven use the technology of string diagram rewriting. It is an open question as to whether the results of this paper can be viewed as consequences of more powerful categorical theorems.
- There are important compositional features of supermaps beyond those inherited by poly-categorical semantics, as discovered in [30]. It is again an open question as to whether such rich compositional semantics is available to the abstract constructions developed here, or whether instead, those compositional features are specific to the structure of quantum theory.
- Now that we have a well-behaved definition of supermaps for arbitrary OPTs including infinite-dimensional quantum theory, there is the question of whether the multitude of information processing advantages of supermaps with indefinite causal structure [3, 43–50] extend past the finite-dimensional quantum-theoretic setting. This question will allow us to develop our understanding of the information processing advantages afforded by theories of quantum gravity.
- Further to the above point, it will be important to discover whether the construction of unitary-preserving supermaps from routed graphs [51] extends to the construction of polyslots in  $\mathbf{sepU}$ , so that canonical processes studied in quantum foundations can be lifted to the infinite-dimensional setting. This will require a generalization of polyslots to those which act on compositionally constrained spaces [52, 53]
- It is unclear in the infinite-dimensional case whether one can find further physically reasonable supermaps by the generalization of the definition of supermaps in compact closed category to a definition of path-contraction supermaps. A proof of the conjecture that path-contraction supermaps in unitary quantum theory are equivalent to polyslots would suggest that a stable, circuit theoretic definition of supermap has been found. A proof of the converse would suggest that more work could be done to find a less strong circuit-theoretic definition of locality. In the mixed setting, there is, even more, to be understood. All that

can be known from the results of this paper for the case of the category  $\mathbf{sepQC}$  of quantum channels on separable Hilbert spaces is that  $\mathbf{srep}[\mathbf{sepQC}] \subseteq \mathbf{pslot}[\mathbf{sepQC}]$  and that  $\mathbf{srep}[\mathbf{sepQC}] \subseteq \mathbf{pathcon}[\mathbf{sepQC}]$ . Namely, the precise relationship between  $\mathbf{pslot}[\mathbf{sepQC}]$  and  $\mathbf{pathcon}[\mathbf{sepQC}]$  is unknown, if they differ then there may not be one most-appropriate definition of supermap for separable dimensions.

- Another open question is whether the relationship between the causal box framework [54] and the process matrix framework used to establish the possibility of embedding of processes with indefinite causal structure into a definitely ordered spacetime [55], extends to infinite-dimensional polyslots. The causal box framework, being phrased in terms of Fock space is indeed already expressed in a form suitable for the consideration of infinite dimensions.
- It is an open question as to whether polyslots as defined here either appear in, or are of use to, the other scientific disciplines in which black-box holes are studied.
- Whilst polyslots freely reconstruct supermaps, they cannot be used in the current form to freely construct all iterated layers of higher order quantum theory [27, 28]. A generalization of polyslots to those which in-fact act on polycategories appears to be required for such an iteration. The formalization of this point, when iterated to produce an infinite tower of enriched categories [41] is expected by the authors to result in a freely constructed closed structure for higher order  $\mathbf{C}$ -theory with  $\mathbf{C}$  any arbitrary possibly non-quantum symmetric monoidal category

Broadly speaking, a circuit-theoretic black-box approach to holes in diagrams, with appropriate compositional semantics has been proposed. This approach can be used to phrase new questions and problems about the properties of a wide variety of circuit theories, both practical and physical in nature.

#### Acknowledgements

MW is grateful to A Vanreitelde for suggesting use of single-party representability as an axiom from which supermaps could be reconstructed, and to A Kissinger for useful conversations. GC is supported by Grant No. 61466 from the John Templeton Foundation as part of the QISS project. The opinions expressed in this publication are those of the authors and do not necessarily reflect the views of the John Templeton Foundation. GC was supported by the Croucher Foundation and by the Hong Kong Research Grant Council (RGC) through the Senior Research Fellowship Scheme SRFS2021-7S02. MW was supported by University College London and the EPSRC Doctoral Training Centre for Delivering Quantum Technologies.

#### Note Added

The observation of the polycategorical composition rule for polyslots and proofs of associativity were made independently for the specialized case of N-combs in [19].

## References

- [1] G. Chiribella, G. M. D’Ariano, and P. Perinotti, “Quantum circuit architecture,” *Physical Review Letters* **101** no. 6, (8, 2008) 060401, arXiv:0712.1325 [quant-ph].
- [2] G. Chiribella, G. M. D’Ariano, and P. Perinotti, “Transforming quantum operations: Quantum supermaps,” *EPL (Europhysics Letters)* **83** no. 3, (7, 2008) 30004, arXiv:0804.0180 [quant-ph].
- [3] G. Chiribella, G. M. D’Ariano, P. Perinotti, and B. Valiron, “Quantum computations without definite causal structure,” *Physical Review A - Atomic, Molecular, and Optical Physics* **88** no. 2, (12, 2009) , arXiv:0912.0195 [quant-ph].
- [4] G. Chiribella, A. Toigo, and V. Umanità, “Normal completely positive maps on the space of quantum operations,” *Open Systems and Information Dynamics* **20** no. 1, (12, 2010) , arXiv:1012.3197 [quant-ph].
- [5] G. Chiribella, G. M. D’Ariano, and P. Perinotti, “Theoretical framework for quantum networks,” *Physical Review A - Atomic, Molecular, and Optical Physics* **80** no. 2, (4, 2009) , arXiv:0904.4483 [quant-ph].
- [6] O. Oreshkov, F. Costa, and Č. Brukner, “Quantum correlations with no causal order,” *Nature Communications* **3** (2012) , arXiv:1105.4464 [quant-ph].
- [7] M. Riley, “Categories of Optics,” arXiv:1809.00738.
- [8] G. Boisseau, “String Diagrams for Optics,” *Leibniz International Proceedings in Informatics, LIPICs* **167** (2, 2020) , arXiv:2002.11480.
- [9] G. Boisseau, C. Nester, and M. Roman, “Cornering Optics,” arXiv:2205.00842.
- [10] J. Hedges, “Coherence for lenses and open games,” arXiv:1704.02230.
- [11] J. Hedges, “The game semantics of game theory,” arXiv:1904.11287.
- [12] J. Bolt, J. Hedges, and P. Zahn, “Bayesian open games,” arXiv:1910.03656 [quant-ph].
- [13] N. Ghani, J. Hedges, V. Winschel, and P. Zahn, “Compositional game theory,” *Proceedings - Symposium on Logic in Computer Science* (3, 2016) 472–481, arXiv:1603.04641.
- [14] G. S. Cruttwell, B. Gavranović, N. Ghani, P. Wilson, and F. Zanasi, “Categorical Foundations of Gradient-Based Learning,” *Lecture Notes in Computer Science (including subseries Lecture Notes in Artificial Intelligence and Lecture Notes in Bioinformatics)* **13240 LNCS** (3, 2021) 1–28, arXiv:2103.01931.
- [15] F. van der Meulen and M. Schauer, “Automatic Backward Filtering Forward Guiding for Markov processes and graphical models,” arXiv:2010.03509 [quant-ph].
- [16] F. Genovese, F. Loregian, and D. Palombi, “Escrows are optics,” arXiv:2105.10028.
- [17] M. Román, “Comb Diagrams for Discrete-Time Feedback,” tech. rep., 2020. arXiv:2003.06214v1 [quant-ph].
- [18] M. Román, “Open Diagrams via Coend Calculus,” arXiv:2004.04526.
- [19] J. Hefford and C. Comfort, “Coend Optics for Quantum Combs,” arXiv:2205.09027.

- [20] G. Chiribella, G. M. D’Ariano, P. Perinotti, and B. Valiron, “Quantum computations without definite causal structure,” *Physical Review A - Atomic, Molecular, and Optical Physics* **88** no. 2, (8, 2013) 022318, arXiv:0912.0195 [quant-ph].
- [21] G. Chiribella, G. M. D’Ariano, and P. Perinotti, “Probabilistic theories with purification,” *Physical Review A - Atomic, Molecular, and Optical Physics* **81** no. 6, (8, 2009) , arXiv:0908.1583v5 [quant-ph].
- [22] G. Chiribella, G. M. D’Ariano, and P. Perinotti, “Quantum from Principles,” arXiv:1506.00398 [quant-ph].
- [23] F. Giacomini, E. Castro-Ruiz, and Č. Brukner, “Indefinite causal structures for continuous-variable systems,” *New Journal of Physics* **18** no. 11, (10, 2015) .
- [24] M. Wilson, G. Chiribella, and A. Kissinger, “Quantum Supermaps are Characterized by Locality,” arXiv:2205.09844 [quant-ph].
- [25] S. Gogioso and F. Genovese, “Quantum field theory in categorical quantum mechanics,” arXiv:1805.12087 [quant-ph].
- [26] S. Gogioso and F. Genovese, “Towards quantum field theory in categorical quantum mechanics,” arXiv:1703.09594 [quant-ph].
- [27] A. Kissinger and S. Uijlen, “A categorical semantics for causal structure,” *Logical Methods in Computer Science* **15** no. 3, (2019) , arXiv:1701.04732 [quant-ph].
- [28] A. Bisio and P. Perinotti, “Theoretical framework for higher-order quantum theory,” *Proceedings of the Royal Society A: Mathematical, Physical and Engineering Sciences* **475** no. 2225, (5, 2019) 20180706, arXiv:1806.09554 [quant-ph].
- [29] W. Simmons and A. Kissinger, “Higher-order causal theories are models of BV-logic,” arXiv:2205.11219 [quant-ph].
- [30] L. Apadula, A. Bisio, and P. Perinotti, “No-signalling constrains quantum computation with indefinite causal structure,” arXiv:2202.10214v1 [quant-ph].
- [31] L. Hardy, “Towards Quantum Gravity: A Framework for Probabilistic Theories with Non-Fixed Causal Structure,” *Journal of Physics A: Mathematical and Theoretical* **40** no. 12, (8, 2006) 3081–3099, arXiv:gr-qc/0608043v1 [quant-ph].
- [32] S. M. Lane, *Categories for the Working Mathematician*, vol. 5 of *Graduate Texts in Mathematics*. Springer New York, 1971. 10.1007/978-1-4612-9839-7.
- [33] M. Szabo, “Polycategories,” *Communications in Algebra* **3** no. 8, (1975) 663–689.
- [34] S. Gogioso, “A Process-Theoretic Church of the Larger Hilbert Space,” arXiv:1905.13117 [quant-ph].
- [35] P. Perinotti, “Causal structures and the classification of higher order quantum computations,” arXiv:1612.05099 [quant-ph].
- [36] B. Coecke and A. Kissinger, *Picturing quantum processes: A first course in quantum theory and diagrammatic reasoning*. Cambridge University Press, 3, 2017.
- [37] B. Coecke, “Quantum pictorialism,” *Contemporary Physics* **51** no. 1, (1, 2010) 59–83, arXiv:0908.1787 [quant-ph].

- [38] B. Coecke, “Kindergarten quantum mechanics: Lecture notes,”.
- [39] M. M. Wilde, “From Classical to Quantum Shannon Theory,” [arXiv:arxiv:1106.1445](#) [quant-ph].
- [40] M. D. Choi, “Completely positive linear maps on complex matrices,” *Linear Algebra and its Applications* **10** no. 3, (6, 1975) 285–290.
- [41] M. Wilson and G. Chiribella, “A Mathematical Framework for Transformations of Physical Processes,” [arXiv:2204.04319](#) [quant-ph].
- [42] T. Eggeling, D. Schlingemann, and R. F. Werner, “Semicausal operations are semilocalizable,” *Europhysics Letters* **57** no. 6, (2002) 782–788.
- [43] D. Ebler, S. Salek, and G. Chiribella, “Enhanced Communication with the Assistance of Indefinite Causal Order,” *Physical Review Letters* **120** no. 12, (3, 2018) 120502.
- [44] M. Araújo, A. Feix, F. Costa, and Č. Brukner, “Quantum circuits cannot control unknown operations,” *New Journal of Physics* **16** (9, 2014) .
- [45] G. Chiribella, “Perfect discrimination of no-signalling channels via quantum superposition of causal structures,” *Physical Review A - Atomic, Molecular, and Optical Physics* **86** no. 4, (10, 2012) 040301, [arXiv:1109.5154](#) [quant-ph].
- [46] S. Salek, D. Ebler, and G. Chiribella, “Quantum communication in a superposition of causal orders,” [arXiv:1809.06655](#) [quant-ph].
- [47] G. Chiribella, M. Banik, S. S. Bhattacharya, T. Guha, M. Alimuddin, A. Roy, S. Saha, S. Agrawal, and G. Kar, “Indefinite causal order enables perfect quantum communication with zero capacity channel,” [arXiv:1810.10457v2](#) [quant-ph].
- [48] M. Wilson and G. Chiribella, “A Diagrammatic Approach to Information Transmission in Generalised Switches,” [arXiv:2003.08224](#) [quant-ph].
- [49] G. Chiribella, M. Wilson, and H. F. Chau, “Quantum and Classical Data Transmission Through Completely Depolarising Channels in a Superposition of Cyclic Orders,” *arXiv* (5, 2020) , [arXiv:2005.00618](#) [quant-ph].
- [50] S. Sazim, K. Singh, and A. K. Pati, “Classical Communications with Indefinite Causal Order for N completely depolarizing channels,” [arXiv:2004.14339](#) [quant-ph].
- [51] A. Vanrietvelde, N. Ormrod, H. Kristjánsson, and J. Barrett, “Consistent circuits for indefinite causal order,” [arXiv:2206.10042](#) [quant-ph].
- [52] A. Vanrietvelde, H. Kristjánsson, and J. Barrett, “Routed quantum circuits,” tech. rep. [arXiv:2001.07774](#) [quant-ph].
- [53] M. Wilson and A. Vanrietvelde, “Composable constraints,” [arXiv:2112.06818](#) [quant-ph].
- [54] C. Portmann, C. Matt, U. Maurer, R. Renner, and B. Tackmann, “Causal Boxes: Quantum Information-Processing Systems Closed under Composition,” *IEEE Transactions on Information Theory* **63** no. 5, (12, 2015) 3277–3305.
- [55] V. Vilasini and R. Renner, “Embedding cyclic causal structures in acyclic spacetimes: no-go results for process matrices,” [arXiv:2203.11245](#) [quant-ph].

[56] T. Leinster, “Higher Operads, Higher Categories,” *Higher Operads, Higher Categories* (5, 2003).

## Appendix

### A Polycategory of $\mathbf{P}$ -supermaps

We will find that when dealing with listed data naive diagrammatic representations become cumbersome, so for readability, we adopt a convention analogous to the convention used for genuine lists in multi/polycategories, choosing for instance to represent the above diagram by:

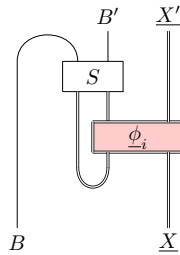

Such a language is not formalized but is used to convey the essence of proofs, with the unpacking of details left to the interested reader with access to larger pieces of paper.

**Lemma 10.** *A symmetric polycategory  $\mathbf{polysup}[\mathbf{P}, \mathbf{C}]$  can be defined with objects given by pairs  $[A, A']$  of objects of  $\mathbf{C}$  and morphisms of type  $S : \Gamma \rightarrow \Delta$  given by the  $\mathbf{P}$ -supermaps of type  $S : \Gamma \rightarrow \Delta$ , the composition rule is given by taking:*

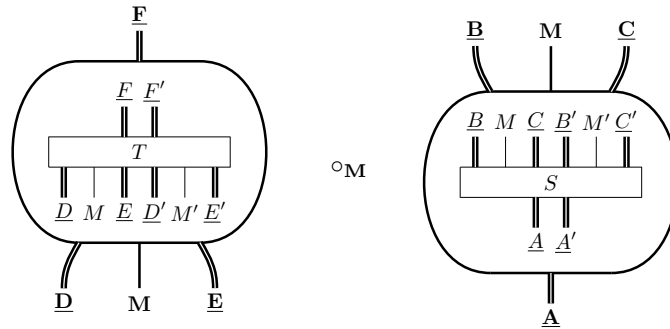

to be

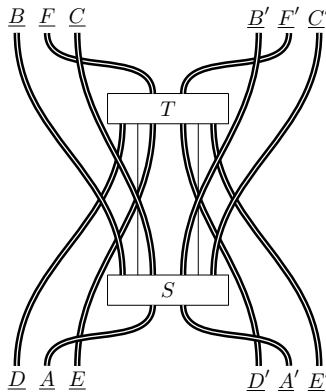



and with symmetric action by permutations given by:

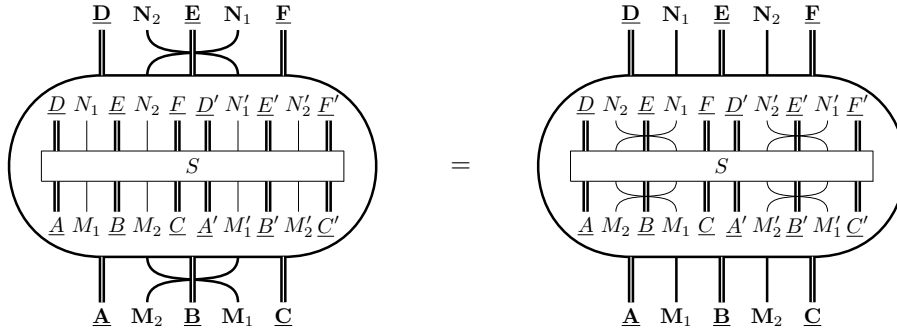

*Proof.* This composition rule returns a new  $\mathbf{P}$ -supermap since the application of  $T \circ_M S$  can be written

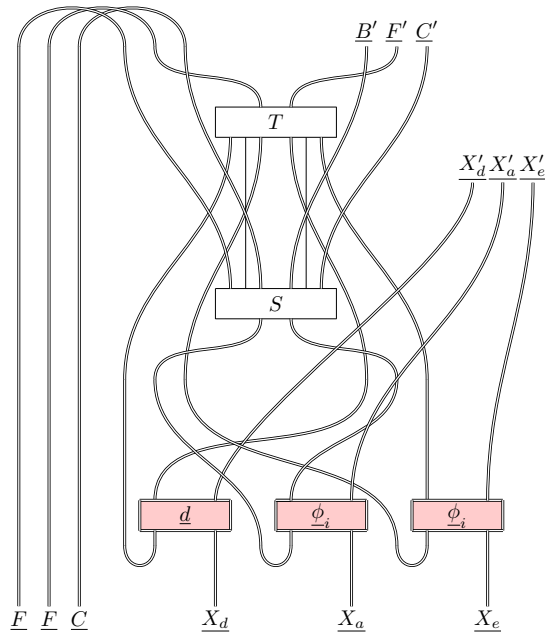

which by the interchange law for symmetric monoidal categories can be converted to

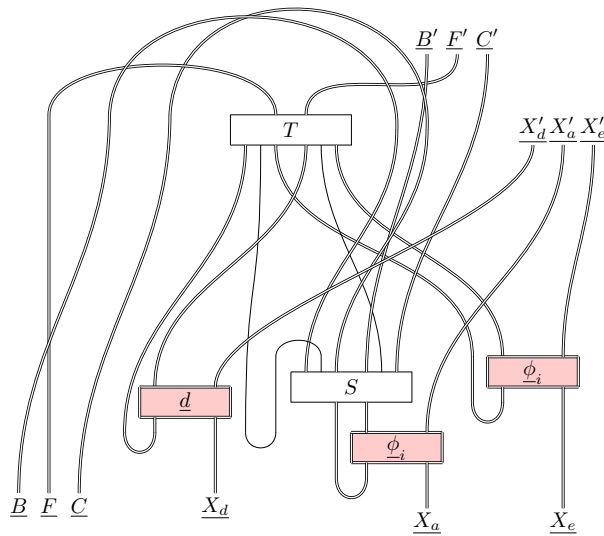

where since  $S$  is a  $\mathbf{P}$ -supermap we can replace the action of  $S$  by a new morphism  $S'(a)$  of  $\mathbf{C}$  to give

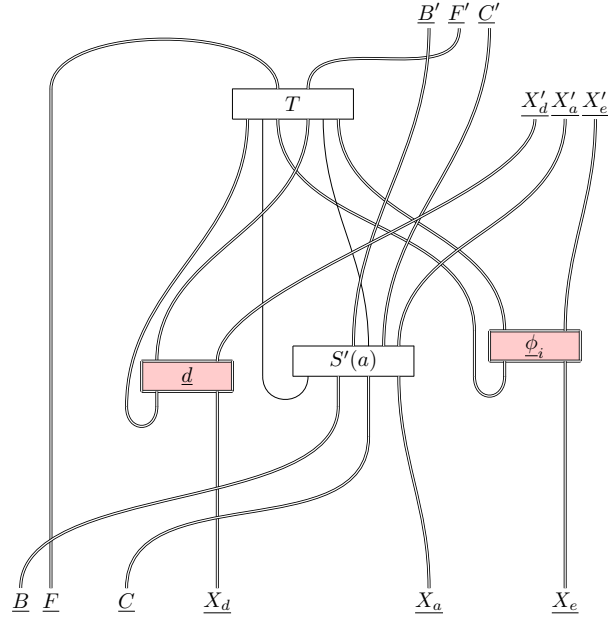

what remains is the actions of  $T$  on a series of channels with  $B, C$  considered as extensions of the morphism  $S'(a)$ , consequently, the entire global diagram is a morphism of  $\mathbf{C}$ . This requires interchange laws for symmetric polycategories are satisfied as they are inherited directly from the interchange laws and symmetry of the symmetric monoidal structure of  $\mathbf{P}$ .  $\square$

It is noted in the main text that composition along multiple wires ought not to be allowed, so as to avoid the creation of time-loops, this point can be made at a more technical level now an explicit definition of supermap has been given. A simple example demonstrates why two-wire composition rules are in general forbidden. Since  $\mathbf{C}$  is a symmetric monoidal category, for any  $\mathbf{C} \subseteq \mathbf{P}$  with  $\mathbf{P}$  compact closed then there exists a  $\mathbf{P}$ -supermap of type  $S : [A, A][A, A] \rightarrow [A, A]$  which performs sequential composition:

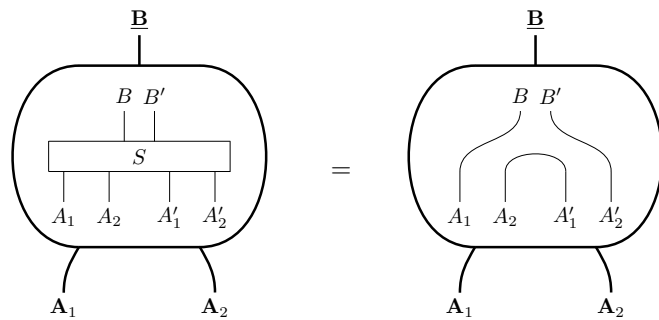

This is indeed a supermap since for all  $\phi_1, \phi_2$  then:

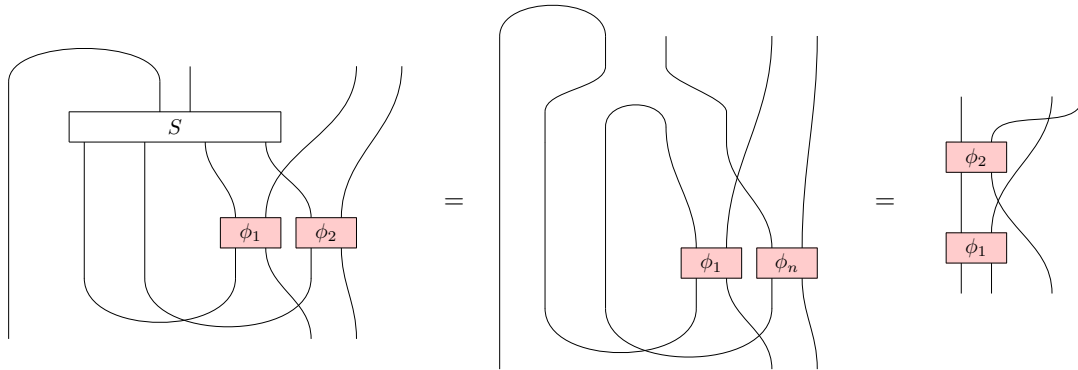

which since  $\mathbf{C}$  is a symmetric monoidal category must be in  $\mathbf{C}$ . Next note that there exists a  $\mathbf{P}$ -supermap of type  $\phi : \emptyset \rightarrow [A, A][A, A]$  given by:

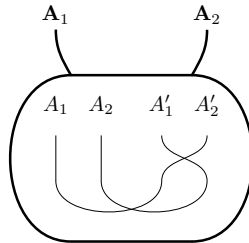

Indeed note that it is a supermap since the following

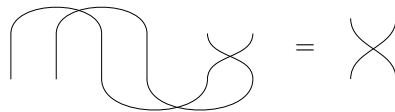

is a member of  $\mathbf{C}$  given that  $\mathbf{C}$  is symmetric monoidal. However, if we were to try to compose  $\phi$  and  $S$  along both of their output/input wires, to give meaning to the following diagram

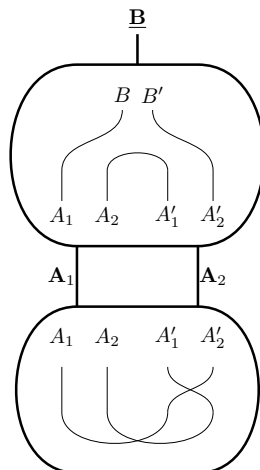

then a loop would be formed:

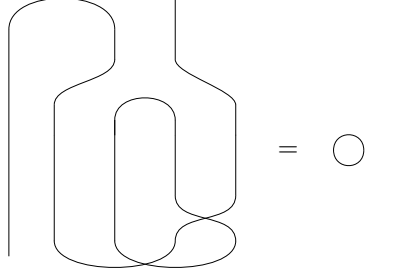

There is no guarantee that this re-normalisation by a scalar preserves membership of  $\mathbf{C}$ , indeed in the study of quantum causal structure such loops are often interpreted as time-loops, and in the category  $\mathbf{U}$  we find that such a re-normalisation does not preserve membership of  $\mathbf{U}$ . In the above sense we can see that the natural emergence of a polycategorical semantics can be understood as a compositional semantics which prevents the forming of time-loops.

## B Monoidal category of Slots

To express the slot condition algebraically and prove symmetric monoidal structure, we will find it easier to talk about for each  $T$  the induced transformation  $(\beta T \beta)_{A_1 X}^{A'_1 X'} := \beta_{B_2 A_1}^{B'_2 A'_1} T_{A_1 \otimes X}^{A'_1 \otimes X'} \beta_{A_1 B_1}^{A'_1 B'_1}$  defined by taking  $\beta_{ABX}^{A'B'X'} := \mathbf{C}(\beta_{AB} \otimes X, \beta_{A'B'} \otimes X)$  and so then:

$$\begin{array}{ccc}
 & \mathbf{C}(\beta_{A_1 B_1} \otimes X, \beta_{A'_1 B'_1} \otimes X) & \\
 & \curvearrowright & \\
 \mathbf{C}(A_1 \otimes B_1 \otimes X, A'_1 \otimes B'_1 \otimes X') & & \mathbf{C}(B_1 \otimes A_1 \otimes X, B'_1 \otimes A'_1 \otimes X') \\
 \downarrow (\beta T \beta)_{A_1 X}^{A'_1 X'} & & \downarrow T_{A_1 \otimes X}^{A'_1 \otimes X'} \\
 \mathbf{C}(A_1 \otimes B_2 \otimes X, A'_1 \otimes B'_2 \otimes X') & & \mathbf{C}(B_2 \otimes A_1 \otimes X, B'_2 \otimes A'_1 \otimes X') \\
 & \curvearrowleft & \\
 & \mathbf{C}(\beta_{B_2 A_1} \otimes X, \beta_{B'_2 A'_1} \otimes X) & 
 \end{array}$$

Note that for now we assume our underlying monoidal category is strict so that we do not have to keep track of associators and unitors.

**Theorem 11.** *A monoidal category  $\mathbf{slot}[\mathbf{C}]$  can be defined by taking morphisms  $(A_1, A'_1) \rightarrow (A_2, A'_2)$  to be natural transformations  $S : \mathbf{C}(A_1 \otimes -, A'_1 \otimes =) \rightarrow \mathbf{C}(A_2 \otimes -, A'_2 \otimes =)$  such that for every  $T : \mathbf{C}(B_1 \otimes -, B'_1 \otimes =) \Rightarrow \mathbf{C}(B_2 \otimes -, B'_2 \otimes =)$  then*

$$\begin{array}{ccc}
 \mathbf{C}(A_1 \otimes B_1 \otimes X, A'_1 \otimes B'_1 \otimes X') & \xrightarrow{S_{B_1 \otimes X, B'_1 \otimes X'}} & \mathbf{C}(A_2 \otimes B_1 \otimes X, A'_2 \otimes B'_1 \otimes X') \\
 \downarrow \beta T \beta_{A_1, X, A'_1, X'} & & \downarrow \beta T \beta_{A_2, X, A'_2, X'} \\
 \mathbf{C}(A_1 \otimes B_2 \otimes X, A'_1 \otimes B'_2 \otimes X') & \xrightarrow{S_{B_2 \otimes X, B'_2 \otimes X'}} & \mathbf{C}(A_2 \otimes B_2 \otimes X, A'_2 \otimes B'_2 \otimes X')
 \end{array}$$

*Proof.* From now on we omit indices on natural transformations. The assignment  $\boxtimes$  given by

- $[A, A'] \boxtimes [B, B'] = [A \otimes B, A' \otimes B']$



- Symmetric action by permutations given by taking

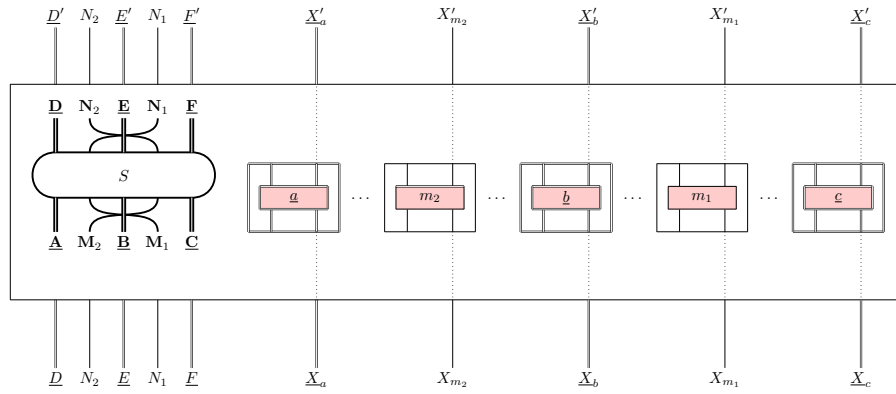

to be

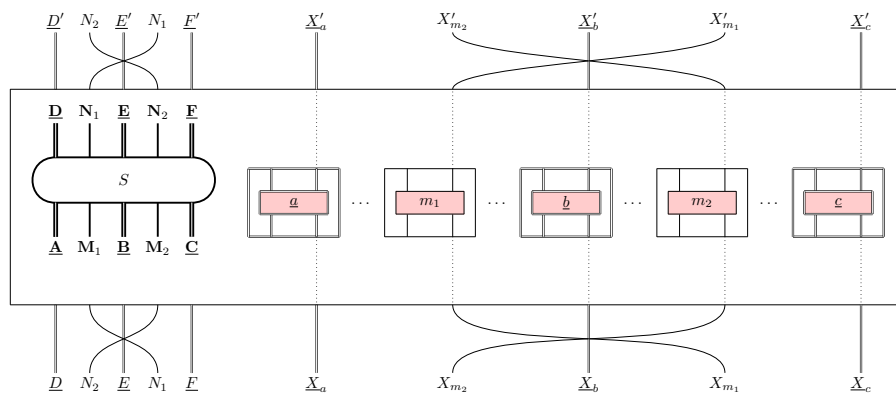

*Proof.* We confirm interchange laws for composition, that is, that:

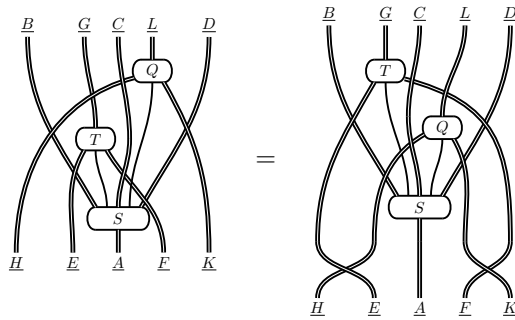

Indeed, consider

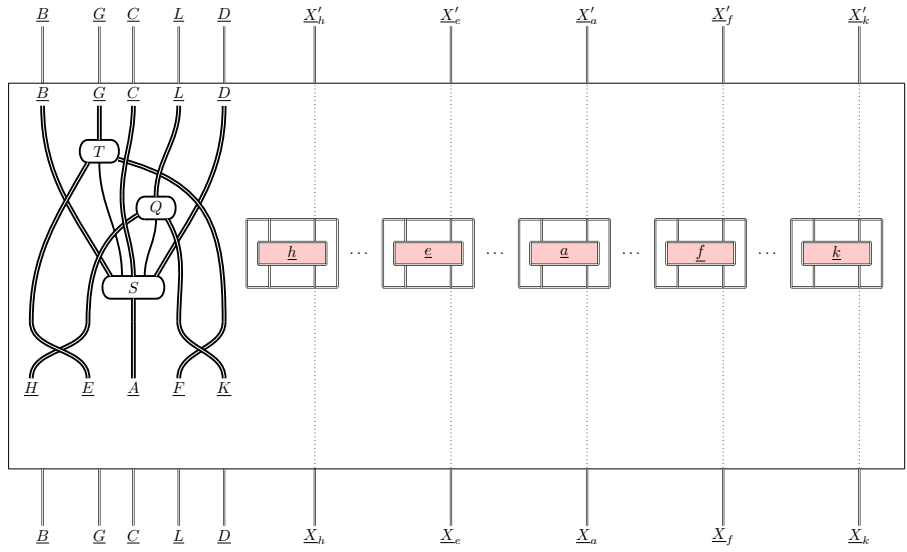

applying the symmetric action gives:

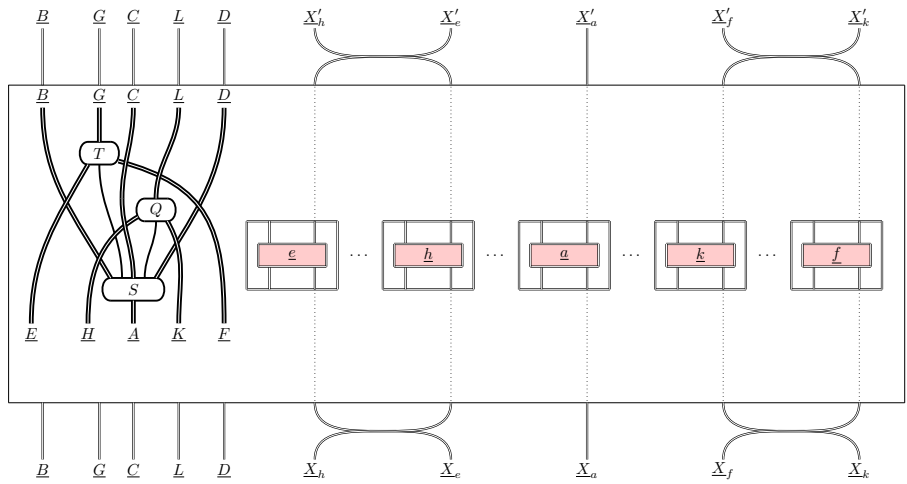

using the composition rule gives

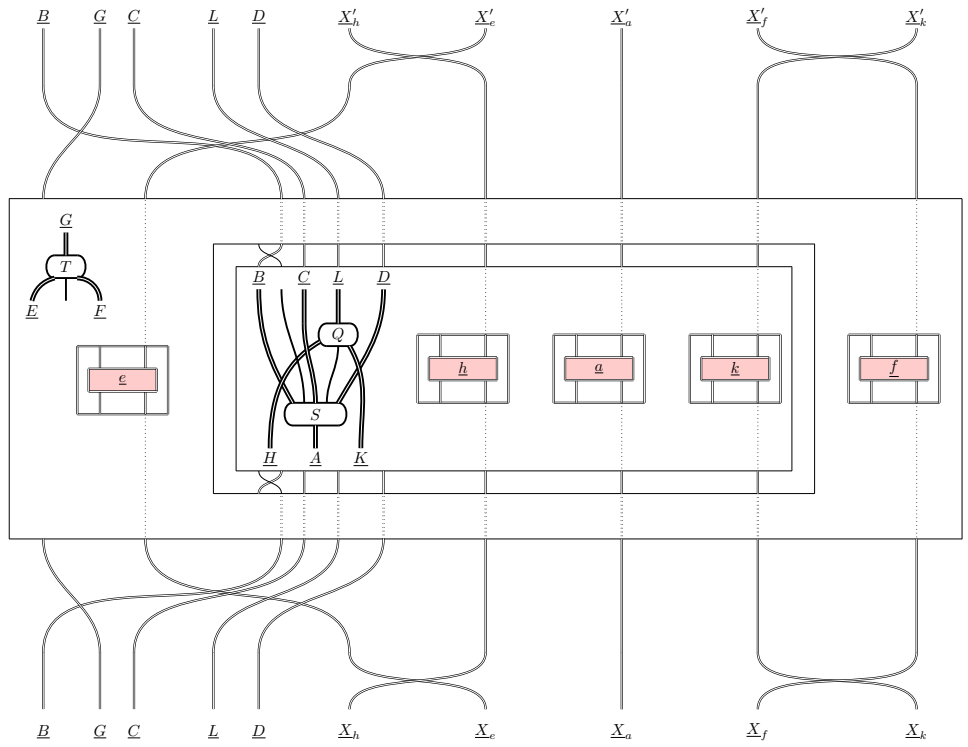

or equivalently using the definition of slot induced by a polyslot

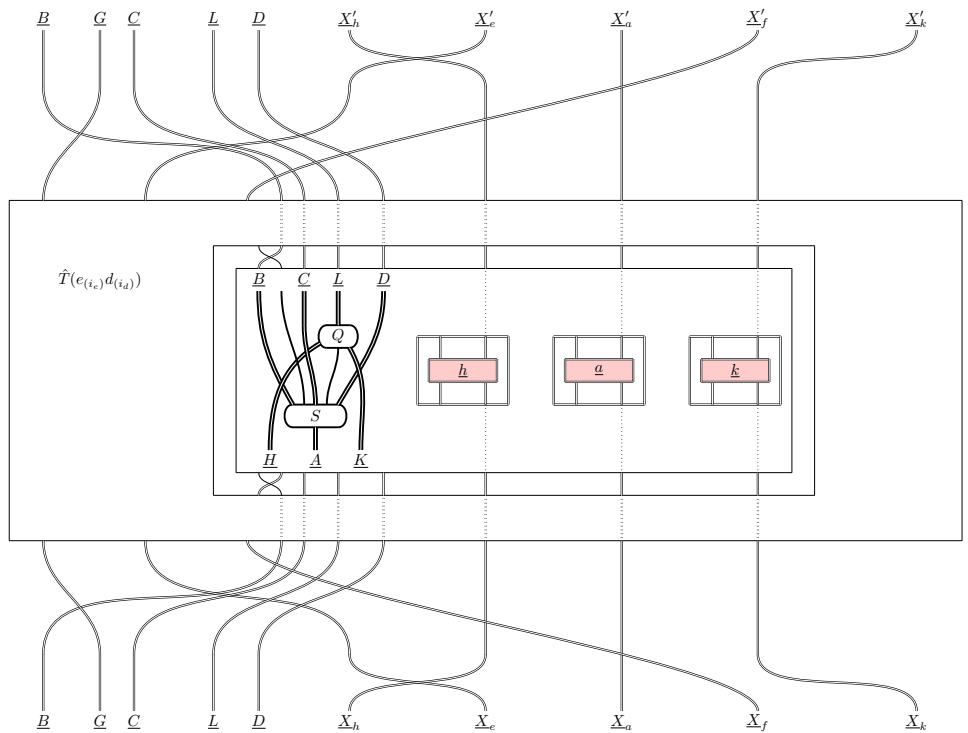



We then use the composition rule again to give

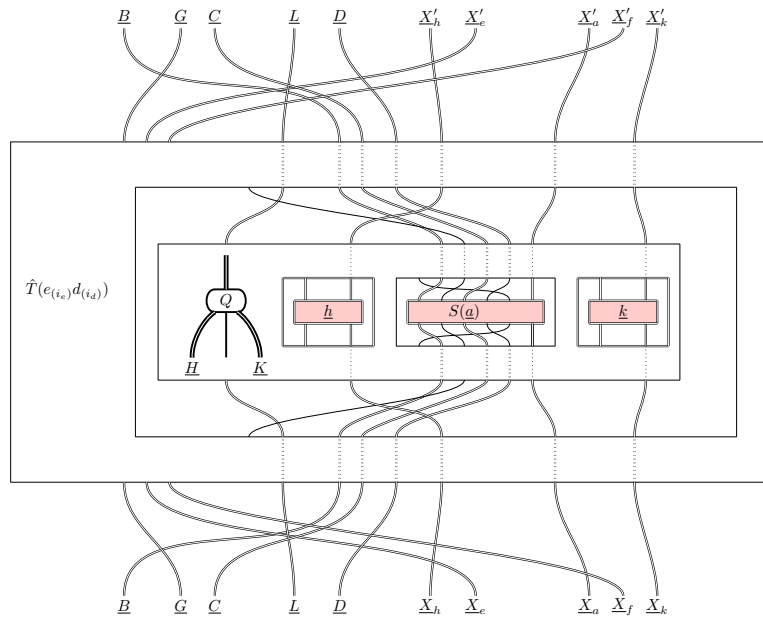

Again converting into slot form gives:

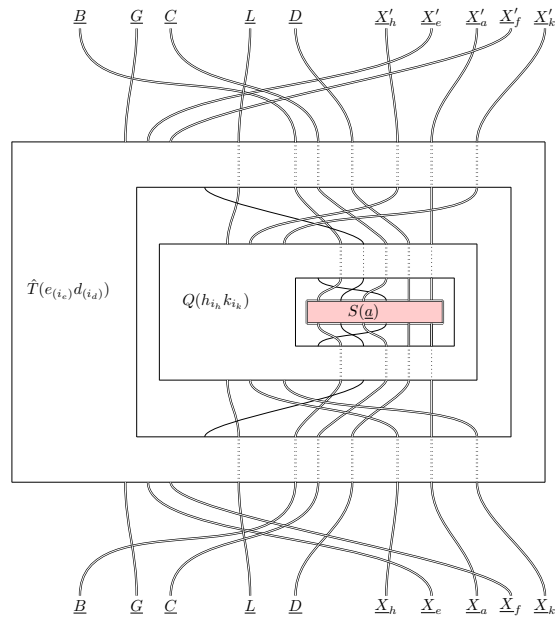

using a series of swaps to set up the defining condition for slots gives

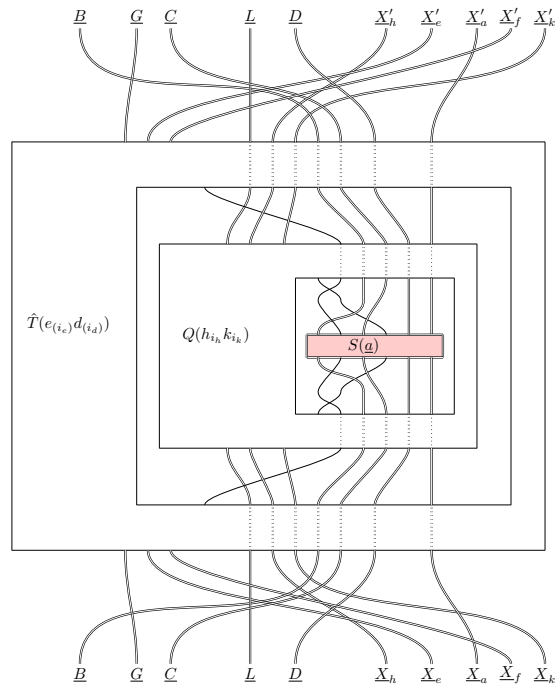

after-which the slot equation can finally be used to return

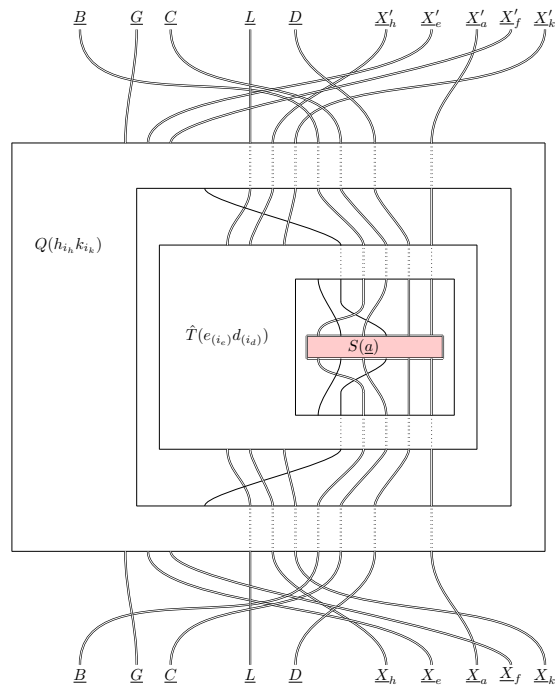

Unpacking the definition of  $\hat{T}$  gives

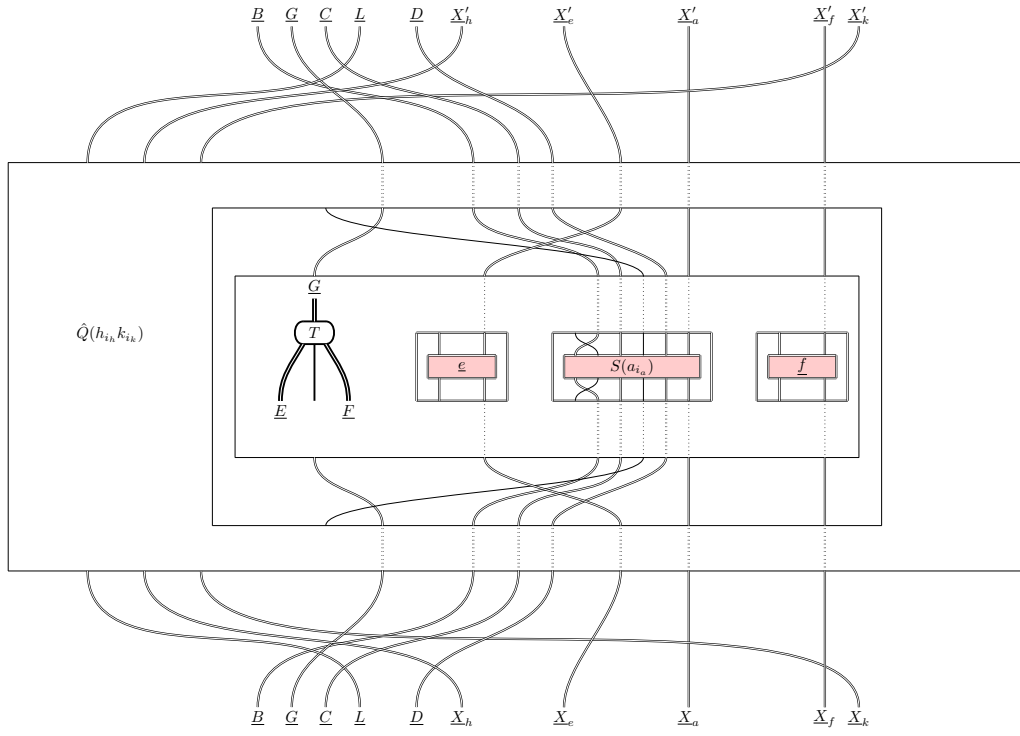

re-packaging the composition between  $T$  and  $S$  gives

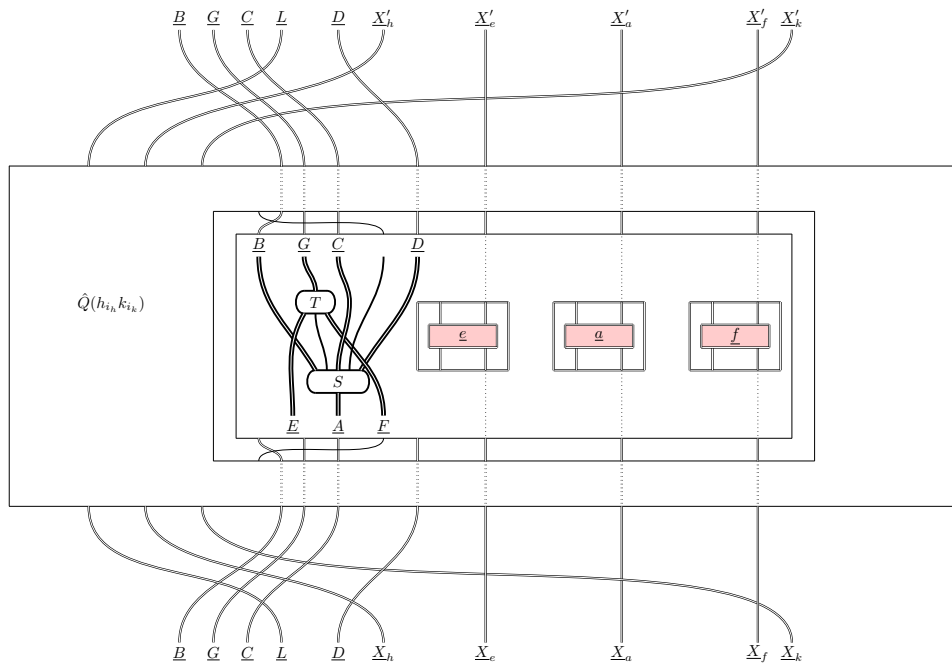

Unpacking the definition of  $\hat{Q}$  gives

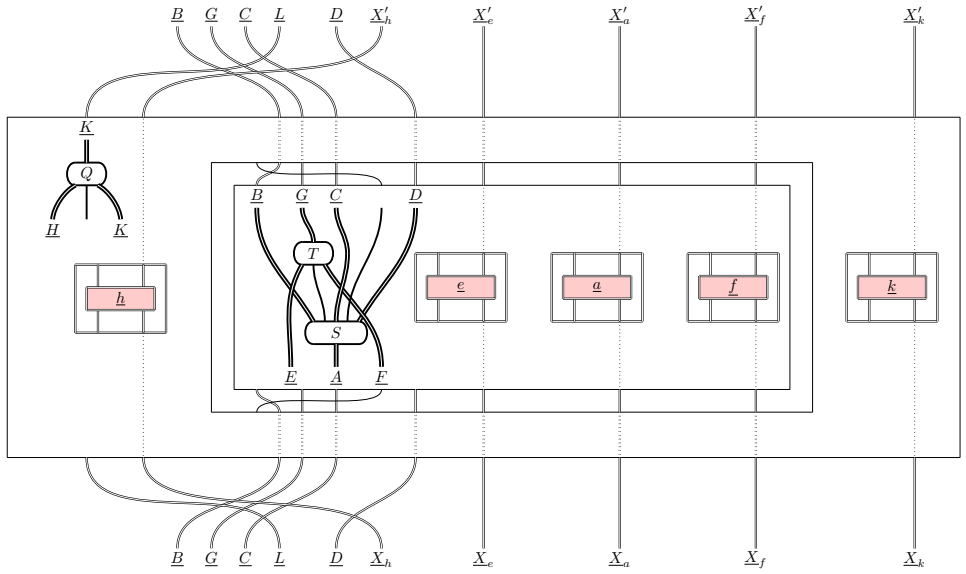

and finally repackaging the composition rule gives

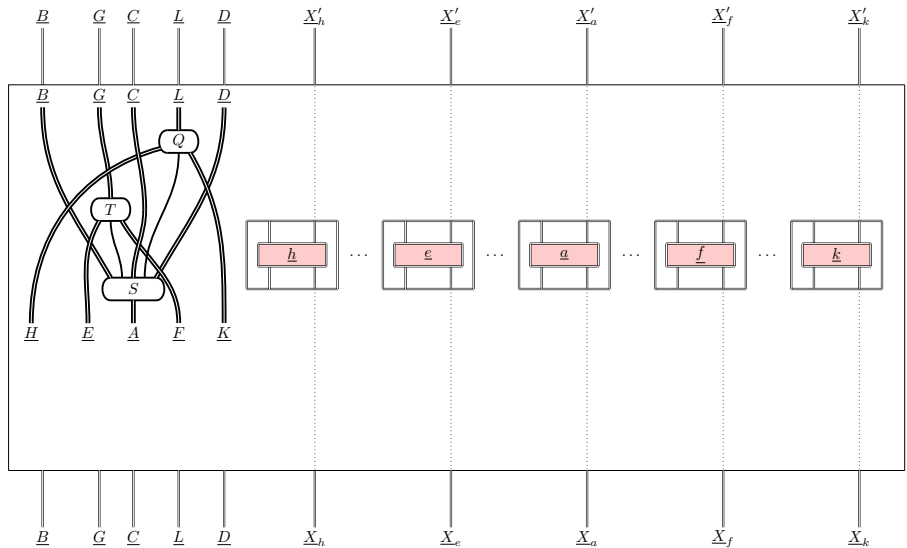

and so indeed the interchange law is satisfied. The other interchange law which needs to be checked is more straightforward:

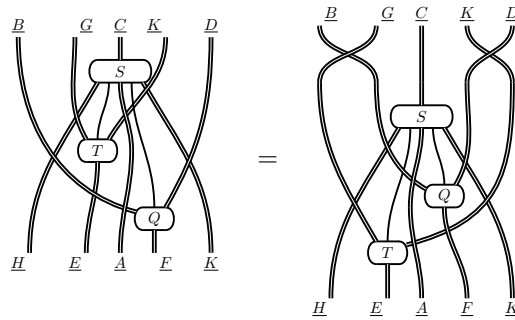

We first consider the latter term,

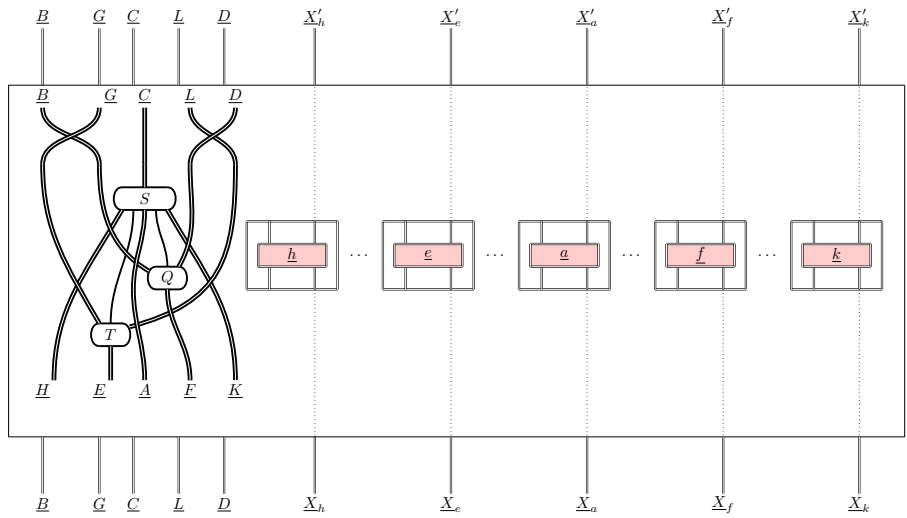

and then use the definition of the symmetric action

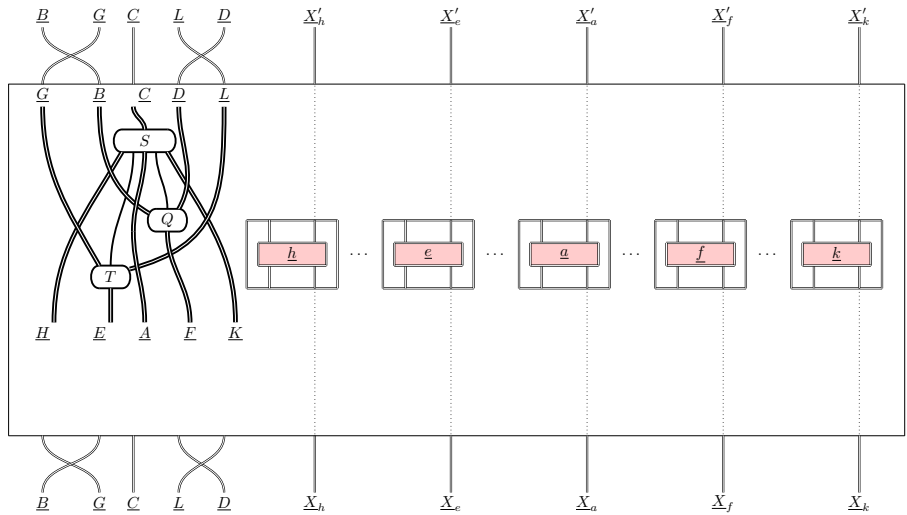

then we use the definition of composition along  $T$

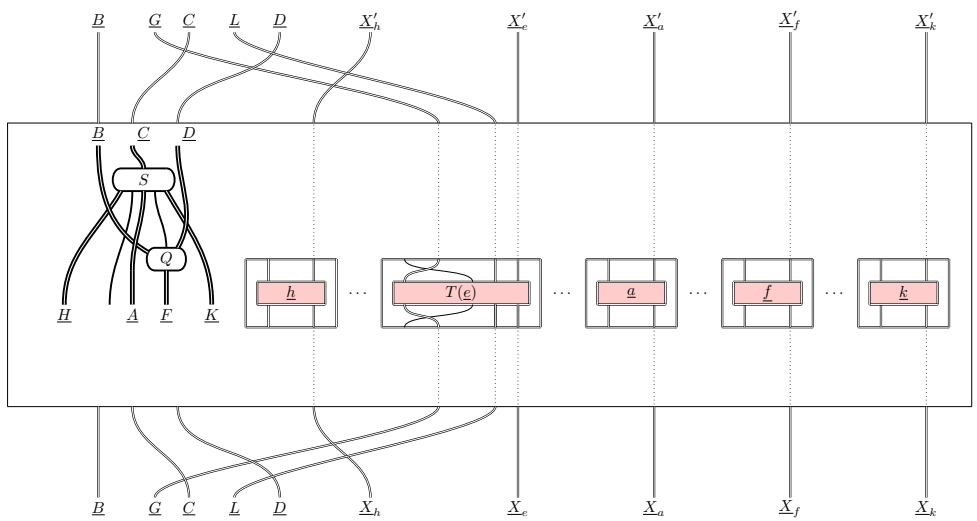

and then use the definition of composition along  $Q$

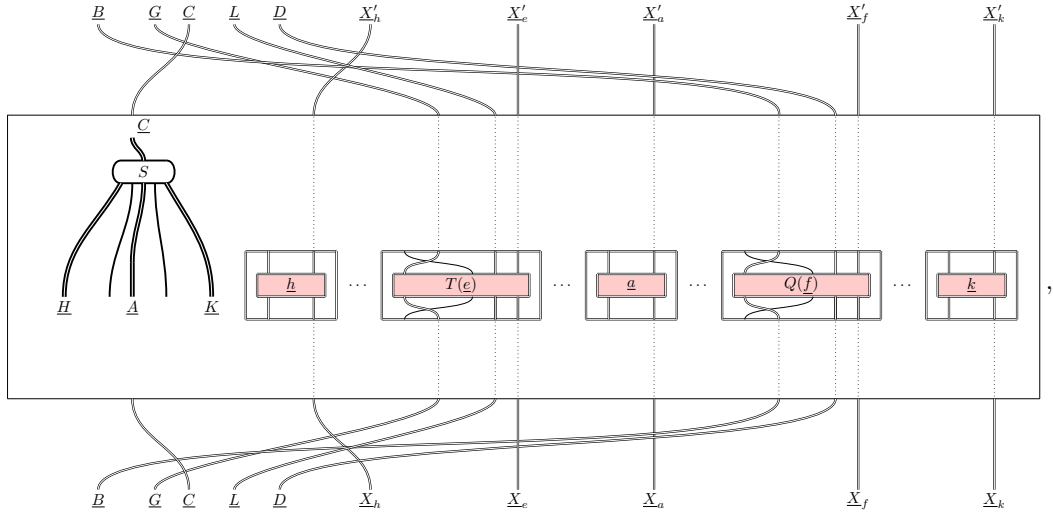

then using the definition of composition along  $T$ ,

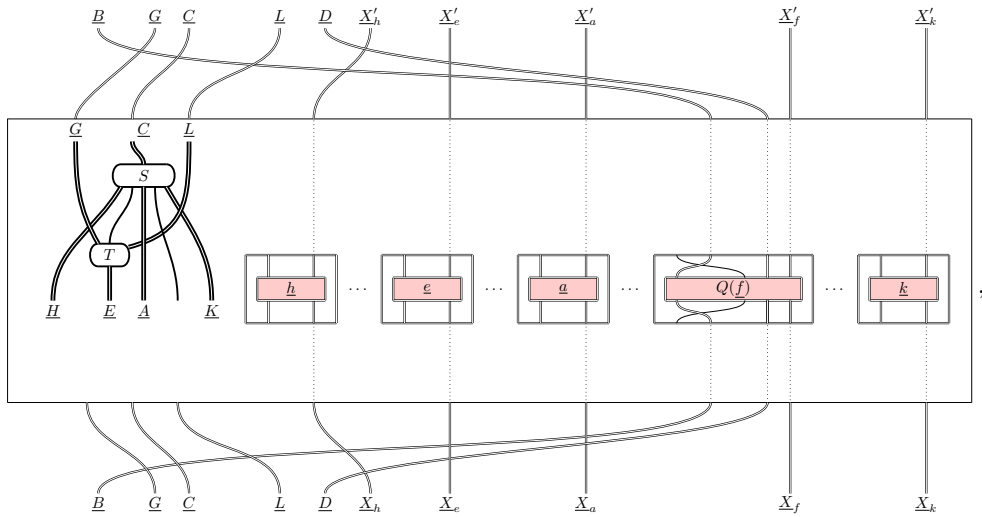

and finally the definition of composition along  $Q$  gives the result

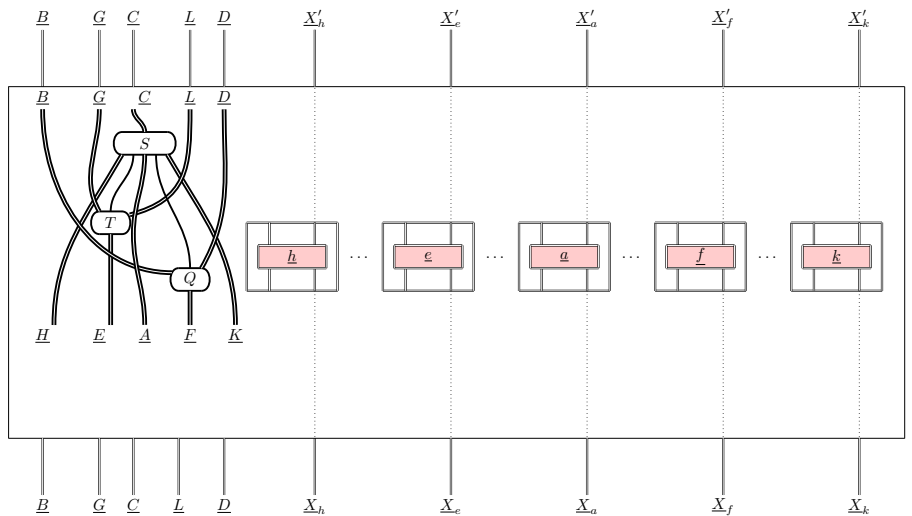

the unit polymorphism of type  $[A, A'] \rightarrow [A, A']$  is given by the slot with each  $X, X'$  component given by the identity function of type  $id : \mathbf{C}(AX, A'X')$ . The associativity of sequential

compositions is directly inherited from associativity of sequential composition for functions composition.  $\square$

**Corollary 1.** *The single-party representable supermaps on  $\mathbf{C}$  define a polycategory  $\mathbf{srep}[\mathbf{C}]$ .*

*Proof.* single-party representable supermaps are polyslots, so interchange laws need not be checked, all that needs to be checked is that local-representability is preserved under polyslot composition, which follows by applying locally the observation that the composition of two combs is itself a comb.  $\square$