

An Unbiased Quantum Random Number Generator Based on Boson Sampling

Jinjing Shi¹, Tongge Zhao¹, Yizhi Wang², Chunlin Yu³, Yuhu Lu¹, Ronghua Shi¹, Shichao Zhang¹, and Junjie Wu²

¹School of Computer Science and Engineering, Central South University, Changsha 410083, China.

²Institute for Quantum Information & State Key Laboratory of High Performance Computing, College of Computer Science and Technology, National University of Defense Technology, Changsha 410073, China.

³China Greatwall Quantum Laboratory, China Greatwall Technology Group CO.,LTD., Changsha 410073, China.

It has been proven that Boson sampling is a much promising model of optical quantum computation, which has been applied to designing quantum computer successfully, such as "*Jiuzhang*". However, the meaningful randomness of Boson sampling results, whose correctness and significance were proved from a specific quantum mechanical distribution, has not been utilized or exploited. In this research, Boson sampling is applied to design a novel Quantum Random Number Generator (QRNG) by fully exploiting the randomness of Boson sampling results, and its prototype system is constructed with the programmable silicon photonic processor, which can generate uniform and unbiased random sequences and overcome the shortcomings of the existing discrete QRNGs such as source-related, high demand for the photon number resolution capability of the detector and slow self-detection generator speed. Boson sampling is implemented as a random entropy source, and random bit strings with satisfactory randomness and uniformity can be obtained after post-processing the sampling results. It is the first approach for applying the randomness of Boson sampling results to develop a practical prototype system for actual tasks, and the experiment results demonstrate the designed Boson sampling-based QRNG prototype system pass 15 tests of the NIST SP 800-22 statistical test com-

ponent, which prove that Boson sampling has great potential for practical applications with desirable performance besides quantum advantage.

1 Introduction

Random numbers play an important role in different kinds of applications and provide essential resources [1], such as cryptography [2], lottery industry [3], genetics, scientific simulations [4, 5], etc. While the generation of good randomness is an obviously difficult problem [6, 7]. In the classical field, there are many random number generator (RNG) schemes, most of which involve deterministic algorithms and start from a small bit string called *seed*, such as the linear congruential RNG based on number theory [8], the Mersenne Twister based on linear shift feedback registers [9], etc. Those schemes can simply generate random numbers at an advantageous effective rate, while they cannot be considered as true RNGs, called pseudorandom number generators (PRNGs). When the small string random *seed* is leaked, the random numbers generated by those schemes may be exactly known. The important requirement for the unpredictability of random number generators limits the application scope of classical PRNGs.

Fortunately, the intrinsic randomness of quantum physics makes quantum systems a good source of RNG [10], and many quantum random number generators (QRNGs) [11] are proposed, including Branching path generator [12], Photon counting generator [13], etc. Branching path generator generates random numbers by measuring the path superposition state or polarization superposition state [12], which depends on the in-

Jinjing Shi: shijinjing@csu.edu.cn.

Shichao Zhang: zhangsc@mailbox.gxnu.edu.cn.

Junjie Wu: junjiewu@nudt.edu.cn

put source that once the superposition state is controlled by a third-party, the measurement result may be controlled as well. Photon counting generator obtains the random number by detecting the photon number of the coherent states [13], whose efficiency depends on the dead time and the photon resolving capability of photon detectors. The non-local correlation between two particles can also generate the randomness [14] which provides an important resource in RNG protocols, like randomness expansion [15, 16] and random amplification [17]. These methods for constructing QRNGs are called device independent or self-testing QRNGs [18, 19, 20], while their generation bit rate is relatively slow that they lack wide applications. In general, discrete QRNGs still have the following possible problems: source-related, high demand for the photon number resolution capability of the detector and slow self-detection generator speed. Thus the principle and implementation of QRNGs need to be improved urgently, and more and more new methods are expectively proposed to design QRNGs [21, 22, 23].

On the other hand, at the very beginning of noisy intermediate-scale quantum (NISQ) era [24], quantum supremacy [25] has been proposed that certain computing tasks may be executed exponentially faster on quantum computers than on classical computers [26]. Boson sampling is considered as a powerful candidate for experimental verification of quantum supremacy [27], which samples the probability distribution generated by the evolution of single photons through a linear optical network only including phase shifters and beam splitters. The application of Boson sampling has attracted the attention of researchers, e.g. Boson sampling-based one-way function [28], Boson sampling-based random unitary encryption [29] and Boson sampling-based hash function [30] have been proposed respectively. The branches of applications of Boson sampling shorten the research process of solving practical problems with Boson sampling. However, the meaningful randomness of Boson sampling results, whose correctness and significance were proved from a specific quantum mechanical distribution [31], has not been fully utilized or exploited.

We are so excited to discover that there are three favorable factors for taking advantages and

exploiting the randomness of Boson sampling to design QRNG. First, the Boson sampling result is a superposition state before the photon output detection that the output is random and independent of the input source. Second, we merely need a normal single-photon detector instead of a photon number resolver in concluding the output of Boson sampling since we only concern whether a mode has photons instead of the specific number of photons. Third, it is possible to generate multi-bit random numbers for sampling only once with multi-modes Boson sampling, which may be more efficient compared to the generators for single-bit random numbers with one sampling. Moreover, the Boson sampling-based QRNG corresponding to above three factors is capable to overcome the defects of the existing QRNGs for the requirements of reliable safe input source, high photon number resolution and improved bit rate potentially. Boson sampling is a sampling problem which is closely related to random number generation indeed. As early as 1999, Petrie *et al.* electronically amplified and sampled natural phenomena such as heat or shot noise signals to generate random numbers [32]. Zhou *et al.* sampled vacuum fluctuations to design practical quantum random number generation [33]. In 2021, Bai *et al.* performed homodyne detection and sampling on the vacuum state to realize the fastest and miniaturized QRNG at present [34]. In the field of experiments, many ingenious experiments have implemented small-scale Boson sampling [35, 36]. At the same time, the Boson sampling model has also been extended, i.e. Scattershot Boson sampling [37], Lossy Boson sampling [38, 39], Gaussian Boson sampling [40, 41] etc. In 2019, Wang *et al.* realized the 20-photons 60-modes Boson sampling experiment [42]. In 2020 and 2021, quantum computing prototypes *jiuzhang* and *jiuzhang 2.0* were proposed [43, 44], respectively, which proved the advantages of quantum computing in the optical quantum system.

In order to overcome the above shortcomings of the existing QRNGs and in the interest of fully exploiting the randomness of Boson sampling results, we present an exploratory work in this paper to utilize Boson sampling as an entropy source to generate quantum random numbers, where the sampling results are independent with the input source, only a normal single-photon detector is required without photon number resolution, and

the generator is quite efficient and effective with ideal post-processing. The Von Neumann correction method for post-processing is applied to generate uniform and unbiased random numbers. A Boson sampling-QRNG prototype system is constructed with the programmable silicon photonic processor to implement the experiments for NIST SP 800-22 statistical test [45] of the proposed scheme.

2 PRELIMINARIES

In this section, we first briefly review the basic knowledge of Boson sampling, and then introduce the design methods of using quantum optical systems to construct QRNGs.

tems to construct QRNGs.

2.1 Boson sampling model

The problem of Boson sampling is proposed by Aaronson and Arkhipov in 2013 [27], claiming that the fock state is input into the passive linear optical interferometer, and the output distribution is sampled with the photon detectors, as shown in the Fig.1(a). Without the exponential cost of time or resources, the sampling outcome cannot be predicted with a classical computer [46, 47]. For Boson sampling model of m -modes linear transformation and n indistinguishable Bosons, the output probability is calculated by a tricky matrix function called permanent

$$P_{I,O} = |\langle O|U \otimes U \dots \otimes U|I \rangle|^2 = \frac{|Per(U_{I,O})|^2}{j_1!j_2! \dots j_m!g_1!g_2! \dots g_m!}, \quad (1)$$

where $|I\rangle = |j_1j_2 \dots j_m\rangle$ is the input state satisfying $j_1 + j_2 + \dots + j_m = n$, j_i is the number of photons input to the i -th mode, $|O\rangle = |g_1g_2 \dots g_m\rangle$ is the output state, $U_{I,O}$ is the sub-matrix of the unitary transformation matrix U for the linear optical interferometer.

where α is a complex number, the amplitude $|\alpha|^2$ corresponds to the mean photon number of the state. The number of photons arriving at the detector in a fixed time follows a Poisson distribution. The probability of detecting n photons in T time is

2.2 Quantum random number generator

The uncertainty of quantum systems is guaranteed by the inherent randomness of quantum physics, where true randomness is a basic feature of quantum mechanics [48]. With the development of quantum optics, the inherent randomness in many parameters of the quantum states of light provides options for the realization of QRNGs [11].

Branching path QRNGs generate random numbers based on the measurement of path superposition state. The light source is input into a balanced beam splitter, where the transmittance and reflectivity are equal. The output is 0 when D_0 detects a photon, and the output is 1 when D_1 detects a photon [10], as shown in the Fig.1(b). Photon counting QRNGs generate random numbers based on the number of photons detected on the coherent state [13]. Coherent states can be described as a superposition of fork states

$$P(n) = \frac{(\lambda T)^n}{n!} e^{-\lambda T}. \quad (3)$$

Boson sampling can be handled with optical quantum systems, of which the necessary elements can be implemented with the current technologies, i.e. sources, linear evolution and detection. The result of Boson sampling is random and can be used as a method of realizing a QRNG.

3 Quantum random number generator based on Boson sampling

In this section, we describe the overall scheme and individual modules of the Boson sampling-based QRNG. The Boson sampling-based QRNG prototype system is constructed on a programmable silicon photonic processor.

3.1 The scheme of Boson sampling-based QRNG

The QRNGs are divided into well-defined independent modules according to their functions,

$$|\alpha\rangle = e^{-|\alpha|^2/2} \sum_{n=0}^{\infty} \frac{\alpha^n}{\sqrt{n!}} |n\rangle, \quad (2)$$

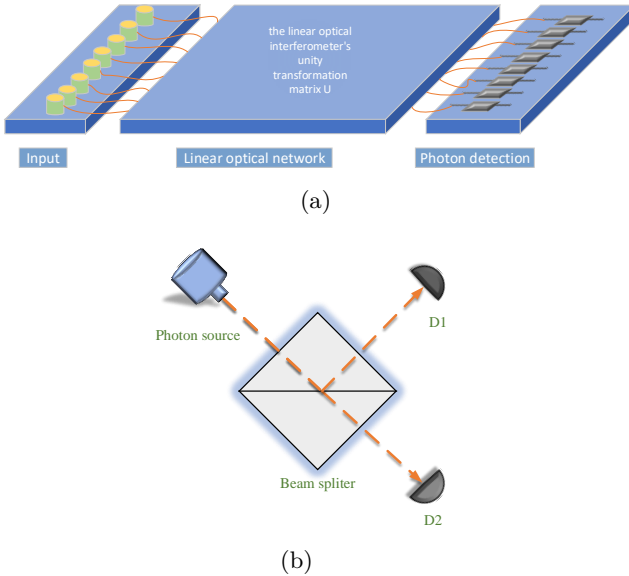

Figure 1: (a) n photons m modes Boson sampling model. n Bosons are input into the passive linear network of m modes, which is composed of beam splitters and phase shifters. After the interference effect of the network, the photons are detected and sampled by the detectors at the output modes. (b) The structure of Branching path QRNG. The photon is sent to a balanced beam splitter and the output is detected with the same probability.

as shown in Fig.2(a), where the most important parts are the entropy source and the post-processing. The entropy source is composed of a quantum system and measurement operations to output initial random data. Since noise exists in the entire system and the measurement process, the initial random data is not necessarily in the form of random bits. Therefore, post-processing operations are required, such as encoding, random extraction, random amplification, etc, ensuring the random sequence obtained at the final output can become a uniform random number sequence with unbiased and independent bit 0 and bit 1.

In the Boson sampling-based QRNG scheme we designed, five major components are included as described in Fig.2(b), i.e. input Boson source, linear optical network, photon detection, post-processing, and output. The entropy source is described by the Boson sampling, in which the quantum system is composed of the input Boson source and the linear optical network, and the measurement process is detected by the photon detectors.

With high probability, the Boson sampling dis-

tribution created by a haar-random matrix U is far away from the uniform distribution[49]. The Von Neumann correction method[50] as shown in Table 1 is applied to the random numbers obtained directly from the Boson sampling to get a completely uniform and unbiased random binary bit sequence. The specific steps of the post-processing are summarized as follows.

Step 1 Perform a Boson sampling and record the sampling result as S_1 .

Step 2 Perform Boson sampling again and record the result as S_2 .

Step 3 Comparing S_1 with S_2 , the output code of a mode is 0 bit if it detects photon in S_1 but does not detect photon in S_2 . Similarly, a mode does not detect photon in S_1 but detects photon in S_2 , then the output code of this mode is 1 bit. No coding in other cases.

Step 4 The coded bits of the modes numbered 1 to M are output in order to obtain the result of the random number generator.

Step 5 Repeat Step 1 to Step 4 until the required number of random numbers are generated

3.2 The Boson sampling-based QRNG prototype system

We have constructed the QRNG prototype system using a programmable silicon photonic processor [51] and observed two Bosons sampling statistics after a five-mode Haar random unitary process U_5 , as shown schematically in Fig.3. To simulate a state of two Bosons created in modes 1 and 2, we first generate the two-photon entangled state

$$\frac{1}{\sqrt{2}} (|1\rangle_s |2\rangle_i + |2\rangle_s |1\rangle_i), \quad (4)$$

where $|k\rangle$ ($k = 1, 2, 3, 4, 5$) denotes the path of a photon, s and i denote the signal and idler photon from coherently generated photon pairs. Each photon is then routed to a universal linear optical network, which applies the unitary transformation U_5 with fixed input. Finally, photons are detected off the chip, and two-photon coincidence events are recorded, from which we extract the correlated detection probability $P_{r,q}$ of

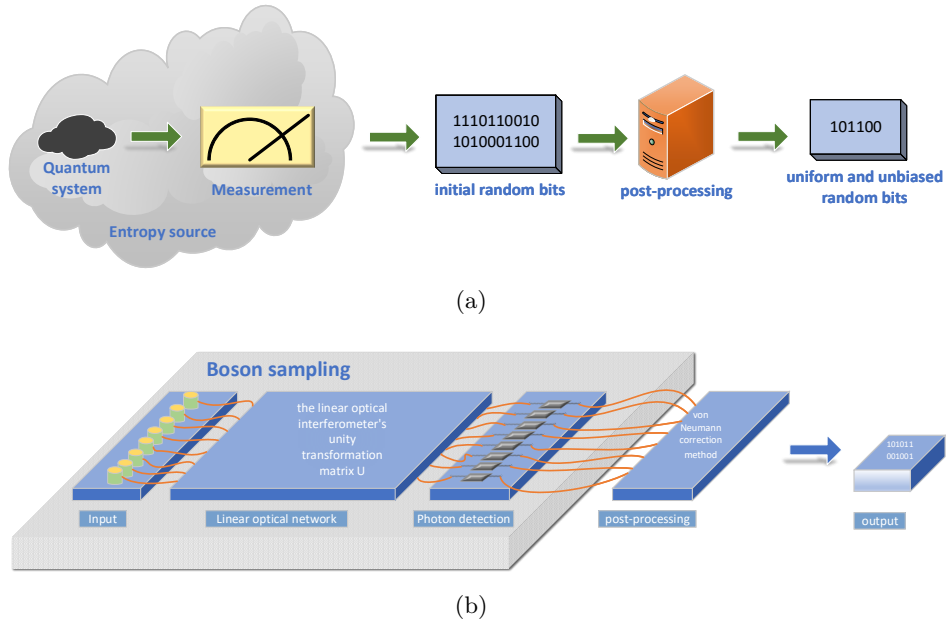

Figure 2: (a) Block structure of QRNG. The block structure consists of the entropy source and the post-processing. The entropy source includes the quantum system and the measurement process, generating the initial random numbers. The post-processing ensures the random number sequence can be uniform and unbiased with 0bit and 1bit derived on equal probability. (b) The structure of Boson sampling-based QRNG. The sampling results are post-processed with Von Neumann correction method to obtain a uniform 01-bit sequence.

mode	1	2	3	4	5	6	7	8	9	10	11	12	...	M
The first sampling result S_1	●	●	○	●	○	○	●	○	●	○	○	●	...	○
The second sampling result S_2	○	●	○	○	●	○	○	●	●	●	○	○	...	●
Coding	0	*	*	0	1	*	0	1	*	1	*	0	...	1
The final random number sequence	0010110...1													

● represents one or more photons is detected
○ represents no photon is detected

Table 1: The post-processing with the Von Neumann correction method

measuring a photon at output r and q of two networks, respectively. According to the simulating scheme, we obtain $\Gamma_{r,q}$, the probability to measure two Bosons occupying modes r and q after the unitary process U_5 , as $\Gamma_{r,q} = P_{r,q}$ (shown in the Fig.4(a)).

4 Experiments and Results

In this subsection, we use the Boson sampling-based QRNG prototype system to experimentally generate random numbers. Furthermore, the statistical test suite is performed on the random numbers obtained from experiments to test the randomness.

4.1 Experimental setup

Bright light with the wavelength of 1549.3 nm is collected from a continuous-wave tunable laser and further amplified up to 50 mW using an optical erbium-doped fiber amplifier. After spectrally filtered by a dense wavelength division multiplexing module and tuned by a polarization controller, the bright light is then injected into the silicon photonic chip (shown in Fig.3) via a V-Groove fiber array. The chip mainly integrates two spontaneous four-wave mixing spiral sources, 22 simultaneously running thermo-optic phase shifters, 32 multimode interferometer beam splitters, and 16 optical grating couplers. The two SFWM sources are pumped by 50:50 split laser and create possible (signal-idler) maximally

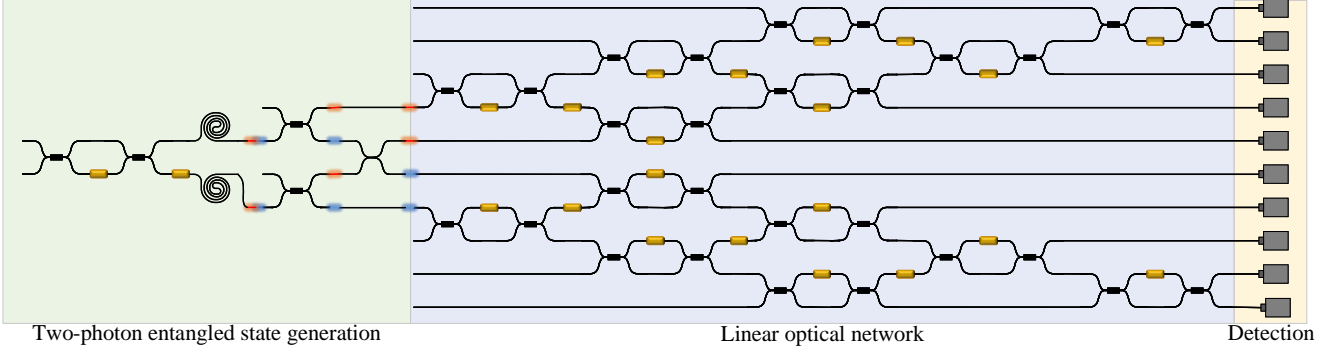

Figure 3: The programmable silicon photonic processor chip. The silicon chip integrates two functional parts: (i) creating two-photon entangled state through spontaneous four-wave mixing (SFWM) and (ii) applying arbitrary five-dimensional unitary transformations with fixed inputs through configurable linear optical networks.

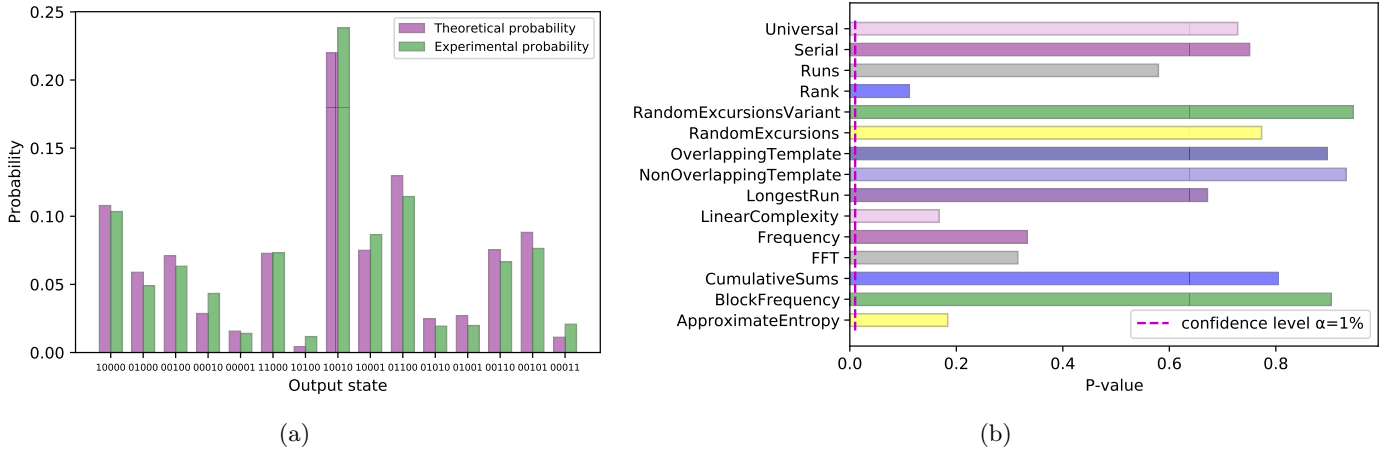

Figure 4: (a) The theoretical probability distribution and experimental probability distribution of each output state. (b) The experimental results pass the 15 tests of the NIST SP 800-22 random number statistical tests. The P -value of each test is greater than the confidence level $\alpha = 0.01$.

entangled photon pairs. The two five-mode universal linear optical networks comprised of beam splitters and phase shifters arranged in Reck *et*

al.-style are used to implement arbitrary five-mode unitary transformation with fixed inputs. In our prototype demonstration, we apply a Haar-random generated unitary operator U_5 as

$$\begin{pmatrix}
 0.01311 + 0.33011 * I & 0.65648 + 0.18793 * I & 0.05465 + 0.16879 * I & 0.49720 + 0.04980 * I & 0.18845 + 0.32849 * I \\
 0.14759 + 0.47792 * I & -0.24696 - 0.23840 * I & 0.34173 + 0.03745 * I & 0.25733 + 0.55151 * I & -0.05311 - 0.37496 * I \\
 0.32357 + 0.04518 * I & -0.10722 + 0.56648 * I & 0.50920 + 0.17247 * I & -0.29096 - 0.15241 * I & 0.39168 - 0.10264 * I \\
 0.35818 - 0.46781 * I & -0.13350 - 0.15289 * I & -0.09973 + 0.00157 * I & 0.07696 + 0.51280 * I & 0.42931 + 0.38538 * I \\
 -0.31110 + 0.30001 * I & -0.20562 + 0.00389 * I & 0.13427 - 0.73030 * I & -0.01605 - 0.05381 * I & 0.35379 + 0.30204 * I
 \end{pmatrix}. \quad (5)$$

Photons from different chip outputs are collected by the same fiber array and detected by superconducting nanowire single-photon detectors. With the coincidence counting logic, two-photon coincidences are recorded by using a time-

interval-analyzer in a 468.75ps integration window. During the continuous running time, a total of 914286 two-photon coincidence events are recorded.

number	Test
1	The Approximate Entropy Test
2	The Binary Matrix Rank Test
3	The Cumulative Sums Test
4	The Frequency (Monobit) Test
5	Frequency Test within a Block
6	The Runs Test
7	Tests for the Longest-Run-of-Ones in a Block
8	The Discrete Fourier Transform (Spectral) Test
9	The Non-overlapping Template Matching Test
10	The Overlapping Template Matching Test
11	Maurer's "Universal Statistical" Test
12	The Linear Complexity Test
13	The Serial Test
14	The Random Excursions Test
15	The Random Excursions Variant Test

Table 2: The 15 tests of NIST SP 800-22

4.2 Standard statistical randomness test

A total of 1.8772 Mbit 01bit sequences were obtained after post-processing using the Von Neumann correction method, where the probabilities of 0 and 1bit are 0.49999814 and 0.50000186, respectively, implementing an unbiased distribution of random number sequences. We use the NIST SP 800-22 statistical test suite to test the randomness [45], which is based on hypothesis testing, containing 15 tests in total, as shown in Table 2. A *p-value* is calculated for each test item summarizing the degree of evidence rejecting the null hypothesis, which is the function of data. Choosing the significance level $\alpha = 0.01$, if the *p-value* obtained by the statistical test is greater than or equal to 0.01, it indicates that the sequence has passed the test, and the resulting sequence is random. If the *p-value* is less than 0.01, it indicates that the sequence has failed the test. The *p-values* of all test items are showed in Fig.4(b), which are all greater than 0.01, indicating that the bit sequence obtained by the experiment has superior performance at random.

5 Discussion

In this section, we describe the influence of circuit parameters on QRNG randomness, and analyze some attractive properties of the Boson sampling-based QRNG.

5.1 Influence of Boson sampling circuit parameters on randomness

We use mathematical entropy function to measure the uncertainty and randomness of the Boson sampling circuit output in the information theory, where different entropy values reflect the degree of surprise for the result. Shannon entropy is calculated as $H(A) = -\sum_{a \in \chi} P_A(a) \log_2 P_A(a)$, where P_A is the probability distribution of random variable A , $P_A(a)$ is the probability of getting output a , and χ is a discrete set of values of random variable A . Rényi entropy is an extension of the usual Shannon entropy [52]. The Rényi entropy of order β is calculated as $H_\beta(A) = \frac{1}{1-\beta} \log_2 \sum_{a \in \chi} P_A(a)^\beta$. When $\beta \rightarrow 1$, the Rényi entropy corresponds to Shannon entropy. When $\beta \rightarrow \infty$, the Rényi entropy corresponds to the Min-entropy. In another way, the Min-entropy H_∞ can be defined as $H_\infty = -\log_2 [\max_{a \in \chi} P_A(a)]$. $2^{-H_\infty(A)}$ describes the probability of hitting the first guess from a random variable A with a known probability distribution.

In the case of fixed input Boson sampling, different linear interferometer unitary matrices are constructed to obtain the output probability distribution of Boson sampling by adjusting the rotation parameters of the linear optical network phase shifters. As shown in Fig.5 and Fig.6, the Shannon entropy and Min-entropy of the Boson sampling output distribution vary with different

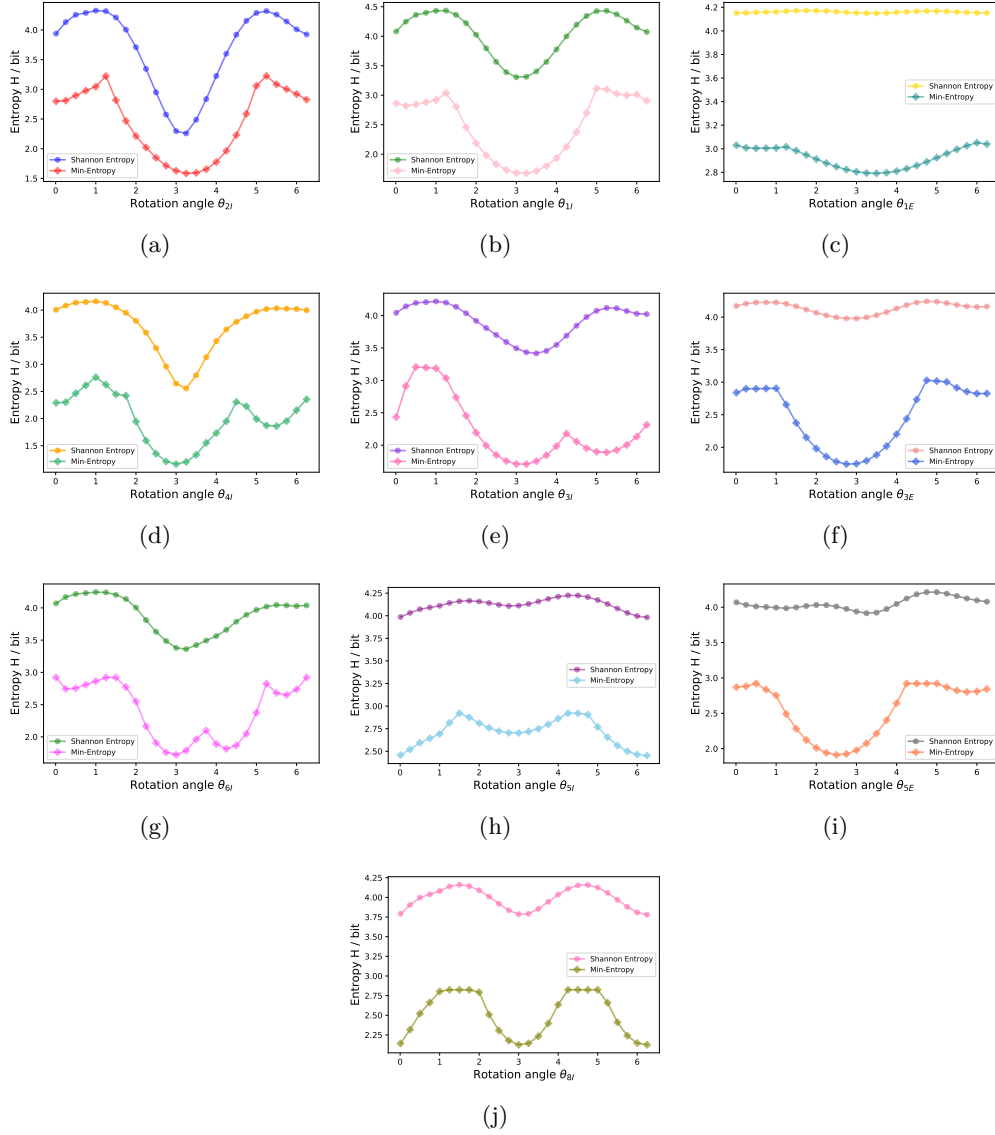

Figure 5: (a)-(j) present the curves of Shannon entropy and Min-entropy changing with circuit rotation angle parameters θ_{2I} , θ_{1I} , θ_{1E} , θ_{4I} , θ_{3I} , θ_{3E} , θ_{6I} , θ_{5I} , θ_{5E} , θ_{8I} , respectively.

circuit parameters in the range of $[0, 2\pi]$. The parameters of the 1I and 2I interferometers have a greater impact on the randomness of the circuit output probability distribution, which are the first optical device that the photons entering the optical network from the light source needed to pass. The general trend of each entropy curve is ascending, descending, ascending, descending and repeating. The experimental results show that for a fixed input 5 modes 2 photons Boson sampling, the randomness of the output of the Boson sampling system can be effectively increased by selecting appropriate linear optical network parameters to improve the ran-

dom numbers generation rate of Boson sampling-based QRNG.

5.2 Performance analysis

The output probability distribution of Boson sampling is not close to the uniform distribution in variation distance [49], which is the advantage of Boson sampling compared with other sampling distributions. A uniform distribution of 01 bits in the output sequence is an important feature required by the random number generator, where the probability of each bit being 0 or 1 is both 0.5, which is unbiased (otherwise the possibility of "guessing" successfully increases). The Von

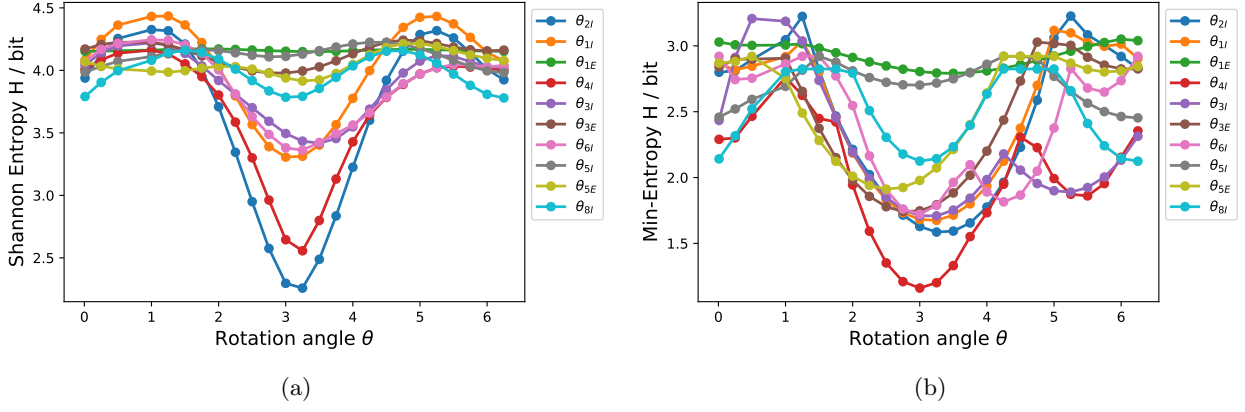

Figure 6: (a) denotes the curves of Shannon entropy changing with circuit rotation angle parameters.

Neumann correction method is used to achieve unbiasedness in the proposed scheme. However, we have not changed the output probability distribution generated by Boson sampling, which is still far from the uniform distribution. After finishing the post-processing, the probability of each mode coded as 0 and 1 is equivalent, the 01 bits in the final random number sequence are also a uniform distribution at the same time. Different from other schemes that directly change the probability distribution of quantum systems, this scheme has the advantage that it retains the non-uniform distribution of boson sampling. In addition, the Boson sampling-based QRNG has several attractive properties.

Unpredictability. The entire system is in a superposition state of $|\phi_{\text{out}}\rangle = \sum_i \lambda_i |n_1 n_2 \dots n_n\rangle$ before being detected by photon detectors, the measurement may destroy the coherence of the superposition state. According to the Born rule[53], when a quantum superposition state is observed and measured, the probability that the state collapses at a specified position is proportional to the square of the coefficient of the state. The measurement result of a quantum system is related to probability, which can never be predicted better than blindly guessing. At the same time, Boson sampling is a process of sampling in the probability distribution obtained by the evolution of the Boson through the beam splitters and the phase shifters, where the final output result is random and unpredictable.

Independent of input source. In the traditional QRNGs, the random numbers are generated by three stages: input source, measurement

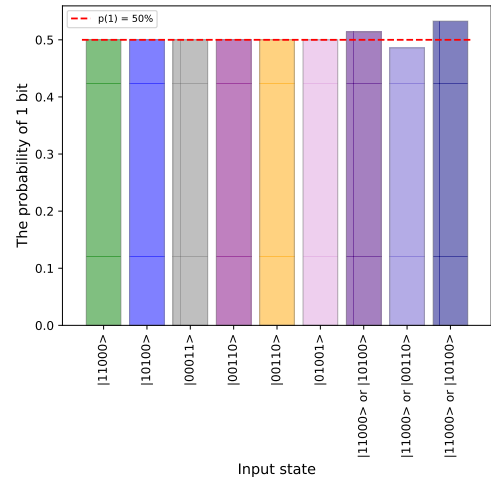

Figure 7: After changing different input states, the probability of 1bit in the random number sequence generated by QRNG.

operation, and post-processing, where the original input source of QRNGs must be fully trusted. If the input source is controlled by a third-party, for example, he/she fixes your source to a combination sequence of ground state $|0\rangle$ and $|1\rangle$ instead of the superposition state $|+\rangle$, when measuring the state on the Z basis, you may "look" to get "random" 0 and 1 bits which are controlled by the third-party. In the proposed Boson sampling-based QRNG, a haar random linear optical network is placed between the initial input source and the measurement operation, where the Boson source can be detected and measured by the photon detectors at the output modes after the evolution of the interference. Since the output state is an unknown superposition state ensured

by the interference effect, the result obtained after the measurement can not be completely determined. In addition, we can also increase the random sampling process before post-processing. Perform boson sampling T times to obtain T sample sets ($T > 2$), from which two sets of samples are randomly selected for post-processing to obtain the output sequence, avoiding the attack problems caused by continuously changing the input source. We change the input source to other states instead of $|11000\rangle$ state to simulate the situation that the input source is controlled by the third party. Evolving in the same unitary matrix of the linear optical network, the probabilities of 1 bit in the output random sequence are shown in Figure X, where the obtained random numbers are still unbiased, which are independent of changing input sources. On the other

$$P_x(0) = P(\text{detecting photon in } S_1) \times P_x(\text{not detecting photon in } S_2), \quad (6)$$

$$P_x(1) = P_x(\text{not detecting photon in } S_1) \times P_x(\text{detecting photon in } S_2). \quad (7)$$

In the case of the same input photon source and linear optical network, two consecutive Boson sampling experiments are independent, where $P_x(\text{detect photon in } S_1) = P_x(\text{detect photon in } S_2)$, so $P_x(0) = P_x(1)$. Therefore, the probability of 0 and 1 in the final random number sequence is both 50%, leading to a physically unbiased QRNG in this work.

Unsimulateability. The complexity theory analysis demonstrates that under the plausible conjectures about the permanent of i.i.d. Gaussian matrices[27], the problems of accurate and approximate Boson sampling can not be effectively solved by classical computers unless

$$PP = \text{PostBQP} = \text{PostBPP} \subseteq \text{BPP}^{\text{NP}}, \quad (8)$$

which means that the polynomial hierarchy collapses to the third level according to Toda's theorem [54]. The output probability distribution of Boson sampling is calculated by the permanent of the unitary transformation matrix of the linear optical network, which is a $\#P$ - hard task on classical computer. The time complexity of the classic algorithm to calculate the matrix permanent is $O(2^n n^2)$, where the demand for classical computer resources exponentially increases with n [55, 56]. Therefore, the Boson sampling-based QRNG can not be simulated classically.

hand, when the third-party controller alternately gives us different input sources, as shown in Fig.7, the probability of generating 1 bit in the random sequence has obvious deviations, which can be easily identified. The random bits will be discarded when there is a significant bias in the 01 bits. Therefore, regardless of whether the input source is mastered by a third-party, we can generate unbiased random numbers or identify the enemy and discard the generated random numbers, the proposed QRNG is independent of the input source.

Uniform (unbiased). After the Von Neumann correction post-processing, the probability of getting 0 bit and 1 bit in the random number sequences can be equivalent. For the x -th output mode of Boson sampling, the probability of outputting 0 (1) bit is

Multiphoton. In the post-processing process, we only record whether a certain mode detects photons instead of the specific number of detected photons. Compared with the photon counting QRNGs using photon number resolution detectors[13], the Boson sampling-based QRNG using single-photon detector is relatively easy to realise that it only requires a binary choice between no click (no photon has been detected) and click (one or more photons are detected). Most of the proposed Boson sampling-based applications rely on collision-free conditions ($n \ll m$), where the number of photons detected in each output mode is either 0 or 1[27], the probability of detecting multiple photons in a mode at the output is almost zero. However, the probability of multiphoton in a mode gradually increases with non-collision-free conditions, seen Fig.8(a). The scheme we proposed is not limited to collision-free conditions, where multi-photon and single-photon are handled at the same time in the post-processing, which is more universal.

Multiple random bits. Only one bit can be generated at a time in branching path QRNGs with limited generation rate. In the scheme mentioned in this article, the linear optical network of Boson sampling has m modes, each of which

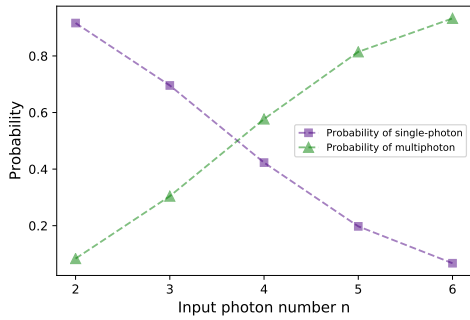

(a)

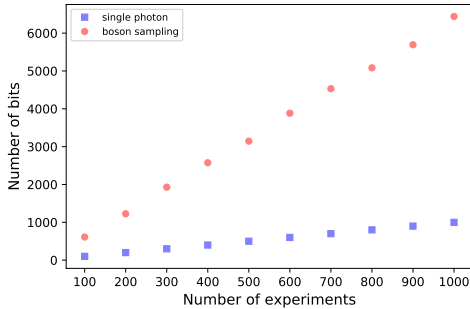

(b)

Figure 8: (a) In 10 modes Boson sampling with a fixed haar random U , the variation curve of the single-photon probability and the multi-photon probability with the number of photons n . Under collision-free conditions, the probability of multi-photon in a mode is almost zero. With the increase of the number of photons n , the probability of multi-photons gradually increases which cannot be ignored. (b) The number of random number bits generated single photon branching path QRNG and Boson sampling-based QRNG with $M = 16$, $N = 6$.

places a photon detector at the end. Multiple results of the presence or absence of photons can be obtained with one measurement. According to the post-processing principle, more than one random bit can be finally obtained through Boson sampling. We find that the Boson sampling-based QRNG generates random numbers at a faster rate and generates more random numbers at a time by simulating the number of random bits generated by QRNGs of single photon and Boson sampling with $M = 16$ and $N = 6$ respectively, as shown in Fig.8(b).

6 Conclusion

An available and unbiased quantum random number generator has been proposed by fully exploiting the meaningful randomness of Boson

sampling results, in which the sampling result of Boson sampling is encoded to generate binary random number sequences. The experimental results on the Boson sampling-based QRNG prototype system with programmable silicon photonic processor chip passed 15 NIST SP 800-22 statistical test component, indicating that the proposed QRNG scheme performs well in randomness. Performance analysis shows that this scheme can generate random numbers that are uniform, unbiased, unpredictable, source-independent, and non-classical simulation to guarantee security and generates random numbers with multiple bits at a time to speeds up the generation rate simultaneously, which can solve the problems of the existing discrete QRNGs for the high demand of reliable safe input source, strong photon number resolution and improved bit rate potentially. In addition, this scheme inherits the merits of Boson sampling, making use of the randomness of Boson sampling results to develop a physical prototype system. This fact provides additional evidence that Boson sampling is capable of solving practical application problems besides quantum advantage. At the same time, it inspires more potential applications of Boson sampling in quantum devices, such as quantum key distribution (QKD) which can be implemented by the synchronization of Boson sampling.

Acknowledgements

This work was supported by the National Natural Science Foundation of China under Grants 61972418 and 61872390, the Natural Science Foundation of Hunan Province under Grant 2020JJ4750, the Special Foundation for Distinguished Young Scientists of Changsha under Grant kq2106014, the CCF-Baidu Open Fund under Grants 2021PP15002000, and the Open Fund of Advanced Cryptography and System Security Key Laboratory of Sichuan Province under Grants SKLACSS-202107.

References

- [1] Russel E Cafilisch. Monte carlo and quasi-monte carlo methods. *Acta numerica*, 7:1–49, 1998.
- [2] Claude E Shannon. Communication theory

- of secrecy systems. *The Bell system technical journal*, 28(4):656–715, 1949.
- [3] Szczepan Chelkowski and André D Bandrauk. Visualizing electron delocalization, electron-proton correlations, and the einstein-podolsky-rosen paradox during the photodissociation of a diatomic molecule using two ultrashort laser pulses. *Physical Review A*, 81(6):062101, 2010.
- [4] Simon Milz and Kavan Modi. Quantum stochastic processes and quantum non-markovian phenomena. *PRX Quantum*, 2(3):030201, 2021.
- [5] Andrew D King, Jack Raymond, Trevor Lanting, Sergei V Isakov, Masoud Mohseni, Gabriel Poulin-Lamarre, Sara Ejtemaee, William Bernoudy, Isil Ozfidan, Anatoly Yu Smirnov, et al. Scaling advantage over path-integral monte carlo in quantum simulation of geometrically frustrated magnets. *Nature communications*, 12(1):1–6, 2021.
- [6] Roman Shakhovoy, Denis Sych, Violetta Sharoglazova, Alexander Udaltsov, Aleksey Fedorov, and Yury Kurochkin. Quantum noise extraction from the interference of laser pulses in an optical quantum random number generator. *Optics express*, 28(5):6209–6224, 2020.
- [7] Howard Dale, David Jennings, and Terry Rudolph. Provable quantum advantage in randomness processing. *Nature communications*, 6(1):1–4, 2015.
- [8] Otmar Scherzer. *Handbook of mathematical methods in imaging*. Springer Science & Business Media, 2010.
- [9] Makoto Matsumoto and Takuji Nishimura. Mersenne twister: a 623-dimensionally equidistributed uniform pseudo-random number generator. *ACM Transactions on Modeling and Computer Simulation (TOMACS)*, 8(1):3–30, 1998.
- [10] André Stefanov, Nicolas Gisin, Olivier Guinnard, Laurent Guinnard, and Hugo Zbinden. Optical quantum random number generator. *Journal of Modern Optics*, 47(4):595–598, 2000.
- [11] Miguel Herrero-Collantes and Juan Carlos Garcia-Escartin. Quantum random number generators. *Reviews of Modern Physics*, 89(1):015004, 2017.
- [12] Thomas Jennewein, Ulrich Achleitner, Gregor Weihs, Harald Weinfurter, and Anton Zeilinger. A fast and compact quantum random number generator. *Review of Scientific Instruments*, 71(4):1675–1680, 2000.
- [13] Min Ren, E Wu, Yan Liang, Yi Jian, Guang Wu, and Heping Zeng. Quantum random-number generator based on a photon-number-resolving detector. *Physical Review A*, 83(2):023820, 2011.
- [14] Stefano Pironio, Antonio Acín, Serge Massar, A Boyer de La Giroday, Dzmitry N Matsukevich, Peter Maunz, Steven Olmschenk, David Hayes, Le Luo, T Andrew Manning, et al. Random numbers certified by bell’s theorem. *Nature*, 464(7291):1021–1024, 2010.
- [15] Roger Colbeck and Adrian Kent. Private randomness expansion with untrusted devices. *Journal of Physics A: Mathematical and Theoretical*, 44(9):095305, 2011.
- [16] Matthew Coudron and Henry Yuen. Infinite randomness expansion with a constant number of devices. In *Proceedings of the forty-sixth annual ACM symposium on Theory of computing*, pages 427–436, 2014.
- [17] Mingfeng Xu, Wei Pan, Lianshan Yan, Bin Luo, Xihua Zou, Liyue Zhang, and Penghua Mu. An explicit non-malleable extraction scheme for quantum randomness amplification with two untrusted devices. *IEEE Communications Letters*, 22(1):85–88, 2017.
- [18] Xiongfeng Ma, Xiao Yuan, Zhu Cao, Bing Qi, and Zhen Zhang. Quantum random number generation. *npj Quantum Information*, 2(1):1–9, 2016.
- [19] Zhu Cao, Hongyi Zhou, Xiao Yuan, and Xiongfeng Ma. Source-independent quantum random number generation. *Physical Review X*, 6(1):011020, 2016.
- [20] Tommaso Lunghi, Jonatan Bohr Brask, Charles Ci Wen Lim, Quentin Lavigne, Joseph Bowles, Anthony Martin, Hugo Zbinden, and Nicolas Brunner. Self-testing quantum random number generator. *Physical review letters*, 114(15):150501, 2015.
- [21] Fabio Acerbi, Nicola Massari, Leonardo Gasparini, Alessandro Tomasi, Nicola Zorzi, Giorgio Fontana, Lorenzo Pavesi, and Alberto Gola. Structures and methods for fully-integrated quantum random number

- generators. *IEEE Journal of Selected Topics in Quantum Electronics*, 26(3):1–8, 2020.
- [22] Ziyong Zheng, Yichen Zhang, Weinan Huang, Song Yu, and Hong Guo. 6 gbps real-time optical quantum random number generator based on vacuum fluctuation. *Review of Scientific Instruments*, 90(4):043105, 2019.
- [23] A Prokhorov, V Kovalyuk, P An, A Golikov, R Shakhovoy, V Sharoglazova, A Udaltsov, Y Kurochkin, and G Goltsman. Silicon nitride mach-zehnder interferometer for on-chip quantum random number generation. In *Journal of Physics: Conference Series*, volume 1695, page 012118. IOP Publishing, IOP Publishing, 2020.
- [24] John Preskill. Quantum computing in the nisq era and beyond. *Quantum*, 2:79, 2018.
- [25] Sergio Boixo, Sergei V Isakov, Vadim N Smelyanskiy, Ryan Babbush, Nan Ding, Zhang Jiang, Michael J Bremner, John M Martinis, and Hartmut Neven. Characterizing quantum supremacy in near-term devices. *Nature Physics*, 14(6):595–600, 2018.
- [26] Aram W Harrow and Ashley Montanaro. Quantum computational supremacy. *Nature*, 549(7671):203–209, 2017.
- [27] Scott Aaronson and Alex Arkhipov. The computational complexity of linear optics. *Theory OF Computing*, 9(4):143–252, 2013.
- [28] Georgios M Nikolopoulos. Cryptographic one-way function based on boson sampling. *Quantum Information Processing*, 18(8):1–25, 2019.
- [29] Yanyan Feng, Ronghua Shi, Jinjing Shi, Wei Zhao, Yuhu Lu, and Yongze Tang. Arbitrated quantum signature protocol with boson sampling-based random unitary encryption. *Journal of Physics A: Mathematical and Theoretical*, 53(13):135301, 2020.
- [30] Jinjing Shi, Yuhu Lu, Yanyan Feng, Duan Huang, Xiaoping Lou, Qin Li, and Ronghua Shi. A quantum hash function with grouped coarse-grained boson sampling. *Quantum Information Processing*, 21(2):1–17, 2022.
- [31] Peter Clifford and Raphaël Clifford. The classical complexity of boson sampling. In *Proceedings of the Twenty-Ninth Annual ACM-SIAM Symposium on Discrete Algorithms*, pages 146–155. SIAM, 2018.
- [32] Craig S Petrie and J Alvin Connelly. The sampling of noise for random number generation. In *1999 IEEE International Symposium on Circuits and Systems (ISCAS)*, volume 6, pages 26–29. IEEE, 1999.
- [33] Qiang Zhou, Raju Valivarthi, Caleb John, and Wolfgang Tittel. Practical quantum random-number generation based on sampling vacuum fluctuations. *Quantum Engineering*, 1(1):e8, 2019.
- [34] Bing Bai, Jianyao Huang, Guan-Ru Qiao, You-Qi Nie, Weijie Tang, Tao Chu, Jun Zhang, and Jian-Wei Pan. 18.8 gbps real-time quantum random number generator with a photonic integrated chip. *Applied Physics Letters*, 118(26):264001, 2021.
- [35] Max Tillmann, Borivoje Dakić, René Heilmann, Stefan Nolte, Alexander Szameit, and Philip Walther. Experimental boson sampling. *Nature photonics*, 7(7):540–544, 2013.
- [36] Daniel J Brod, Ernesto F Galvão, Andrea Crespi, Roberto Osellame, Nicolò Spagnolo, and Fabio Sciarrino. Photonic implementation of boson sampling: a review. *Advanced Photonics*, 1(3):034001, 2019.
- [37] Marco Bentivegna, Nicolò Spagnolo, Chiara Vitelli, Fulvio Flamini, Niko Viggianiello, Ludovico Latmiral, Paolo Mataloni, Daniel J Brod, Ernesto F Galvão, Andrea Crespi, et al. Experimental scattershot boson sampling. *Science advances*, 1(3):e1400255, 2015.
- [38] Hui Wang, Wei Li, Xiao Jiang, Y-M He, Y-H Li, Xing Ding, M-C Chen, Jian Qin, C-Z Peng, Christian Schneider, et al. Toward scalable boson sampling with photon loss. *Physical review letters*, 120(23):230502, 2018.
- [39] Scott Aaronson and Daniel J Brod. Boson-sampling with lost photons. *Physical Review A*, 93(1):012335, 2016.
- [40] Craig S Hamilton, Regina Kruse, Linda Sansoni, Sonja Barkhofen, Christine Silberhorn, and Igor Jex. Gaussian boson sampling. *Physical review letters*, 119(17):170501, 2017.
- [41] Regina Kruse, Craig S Hamilton, Linda Sansoni, Sonja Barkhofen, Christine Silberhorn, and Igor Jex. Detailed study of gaussian boson sampling. *Physical Review A*, 100(3):032326, 2019.
- [42] Hui Wang, Jian Qin, Xing Ding, Ming-

- Cheng Chen, Si Chen, Xiang You, Yu-Ming He, Xiao Jiang, L You, Z Wang, et al. Boson sampling with 20 input photons and a 60-mode interferometer in a 1 0 14-dimensional hilbert space. *Physical review letters*, 123(25):250503, 2019.
- [43] Han-Sen Zhong, Hui Wang, Yu-Hao Deng, Ming-Cheng Chen, Li-Chao Peng, Yi-Han Luo, Jian Qin, Dian Wu, Xing Ding, Yi Hu, et al. Quantum computational advantage using photons. *Science*, 370(6523):1460–1463, 2020.
- [44] Qingling Zhu, Sirui Cao, Fusheng Chen, Ming-Cheng Chen, Xiawei Chen, Tung-Hsun Chung, Hui Deng, Yajie Du, Daojin Fan, Ming Gong, et al. Quantum computational advantage via 60-qubit 24-cycle random circuit sampling. *Science bulletin*, 67(3):240–245, 2022.
- [45] Lawrence E Bassham III, Andrew L Rukhin, Juan Soto, James R Nechvatal, Miles E Smid, Elaine B Barker, Stefan D Leigh, Mark Levenson, Mark Vangel, David L Banks, et al. *Sp 800-22 rev. 1a. a statistical test suite for random and pseudorandom number generators for cryptographic applications*. National Institute of Standards & Technology, 2010.
- [46] Scott Aaronson and Lijie Chen. Complexity-theoretic foundations of quantum supremacy experiments. *arXiv preprint arXiv:1612.05903*, 2016.
- [47] AP Lund, S Rahimi-Keshari, and TC Ralph. Exact boson sampling using gaussian continuous-variable measurements. *Physical Review A*, 96(2):022301, 2017.
- [48] Aleksandra Gočanin, Ivan Šupić, and Borivoje Dakić. Sample-efficient device-independent quantum state verification and certification. *PRX Quantum*, 3(1):010317, 2022.
- [49] S Aaronson and A Arkhipov. Bosonsampling is far from uniform. *Quantum Information and Computation*, 14(15-16):1383–1423, 2014.
- [50] John Von Neumann. 13. various techniques used in connection with random digits. *Appl. Math Ser*, 12(36-38):3, 1951.
- [51] Xiaogang Qiang, Yizhi Wang, Shichuan Xue, Renyou Ge, Lifeng Chen, Yingwen Liu, Anqi Huang, Xiang Fu, Ping Xu, Teng Yi, et al. Implementing graph-theoretic quantum algorithms on a silicon photonic quantum walk processor. *Science Advances*, 7(9):eabb8375, 2021.
- [52] Alfréd Rényi et al. On measures of entropy and information. In *Proceedings of the Fourth Berkeley Symposium on Mathematical Statistics and Probability, Volume 1: Contributions to the Theory of Statistics*. The Regents of the University of California, 1961.
- [53] Max Born and Emil Wolf. *Principles of optics: electromagnetic theory of propagation, interference and diffraction of light*. Elsevier, 2013.
- [54] Seinosuke Toda. Pp is as hard as the polynomial-time hierarchy. *SIAM Journal on Computing*, 20(5):865–877, 1991.
- [55] Junjie Wu, Yong Liu, Baida Zhang, Xianmin Jin, Yang Wang, Huiquan Wang, and Xuejun Yang. A benchmark test of boson sampling on tianhe-2 supercomputer. *National Science Review*, 5(5):715–720, 2018.
- [56] Xiaogang Qiang, Thomas Loke, Ashley Montanaro, Kanin Aungskunsiri, Xiaoqi Zhou, Jeremy L O’Brien, Jingbo B Wang, and Jonathan CF Matthews. Efficient quantum walk on a quantum processor. *Nature communications*, 7(1):1–6, 2016.