

**NECESSARY AND SUFFICIENT CONDITIONS
FOR ONE-DIMENSIONAL VARIATIONAL PROBLEMS
WITH APPLICATIONS TO ELASTICITY**

PAVOL QUITTNER

ABSTRACT. This paper deals with necessary and sufficient conditions for weak and strong minimizers of functionals $\Phi(u) = \int_a^b f(x, u(x), u'(x)) dx$, where $u \in C^1([a, b], \mathbb{R}^N)$. We first derive conditions which are simpler than the known ones, and then apply them to several particular problems, including stability problems in the elasticity theory. In particular, we solve some open problems in [A. Majumdar, A. Raisch: Stability of twisted rods, helices and buckling solutions in three dimensions, *Nonlinearity* 27 (2014), 2841–2867] by finding optimal conditions for the stability of a naturally straight Kirchhoff rod under various types of endpoint constraints.

1. INTRODUCTION

This paper deals with necessary and sufficient conditions for local minimizers of one-dimensional variational problems for vector-valued functions. We consider the functional

$$\Phi : C^1([a, b], \mathbb{R}^N) \rightarrow \mathbb{R} : u \mapsto \int_a^b f(x, u(x), u'(x)) dx, \quad (1)$$

where $-\infty < a < b < \infty$, $u = (u_1, u_2, \dots, u_N)$, and the Lagrangian¹

$$f : [a, b] \times \mathbb{R}^N \times \mathbb{R}^N \rightarrow \mathbb{R} : (x, u, p) \mapsto f(x, u, p)$$

is sufficiently smooth ($f \in C^3$ or $f \in C^2$). We also fix a function $u^0 \in C^1([a, b], \mathbb{R}^N)$ and (possibly empty) subsets $I_a^{\mathcal{D}}, I_b^{\mathcal{D}}$ of the index set $I := \{1, 2, \dots, N\}$, and we look for conditions guaranteeing that u^0 is a local minimizer of Φ in the set

$$\mathcal{M} := \{u \in C^1([a, b], \mathbb{R}^N) : (u_i - u_i^0)(a) = 0 \text{ for } i \in I_a^{\mathcal{D}}, (u_i - u_i^0)(b) = 0 \text{ for } i \in I_b^{\mathcal{D}}\}. \quad (2)$$

This means that at $x = a$ we consider Dirichlet endpoint constraints for the components u_i with $i \in I_a^{\mathcal{D}}$, while the endpoints of the remaining components u_j with $j \in I \setminus I_a^{\mathcal{D}}$ are free; similarly for $x = b$. It is well known (see Proposition 1) that if u^0 is a local minimizer of this problem, then u^0 has to satisfy the natural boundary conditions

$$\frac{\partial f}{\partial p_j}(a, u^0(a), (u^0)'(a)) = 0 \text{ for } j \notin I_a^{\mathcal{D}} \quad \text{and} \quad \frac{\partial f}{\partial p_j}(b, u^0(b), (u^0)'(b)) = 0 \text{ for } j \notin I_b^{\mathcal{D}}.$$

2020 *Mathematics Subject Classification.* 49K05, 74K10, 74G65, 34B15.

Key words and phrases. Minimizers; natural boundary conditions; conjugate points; field of extremals; elastica.

¹As in [8, pp. 11–12], by u we denote both the functions $[a, b] \rightarrow \mathbb{R}^N$ and the independent variable in \mathbb{R}^N , and by p we denote the last argument of f ; see also similar notation $L(t, x(t), \dot{x}(t))$ vs. $L(t, x, v)$ in [15], for example.

We say that u^0 is a weak (or strong, resp.) local minimizer if there exists $\varepsilon > 0$ such that $\Phi(u^0) \leq \Phi(u)$ for any $u \in \mathcal{M}$ satisfying $\|u - u^0\|_{C^1} < \varepsilon$ (or $\|u - u^0\|_C < \varepsilon$, resp.), where $\|\cdot\|_{C^1}$ and $\|\cdot\|_C$ are the usual norms in C^1 and C , respectively (see Definition 2 and the subsequent comments for more details). If u^0 is a steady state of a mechanical system with potential energy Φ , and u^0 is a weak (or strong) local minimizer of Φ , then u^0 is stable with respect to perturbations which are small in C^1 (or C), respectively. On the other hand, if u^0 is not a minimizer, then u^0 is unstable.

If $I_a^D = I_b^D = I$, i.e. if one considers the Dirichlet endpoint constraints for all components and both ends, then necessary and sufficient conditions for u^0 to be a minimizer belong to the classical results in the calculus of variations, see [7, 5, 8], for example. They are based on the Jacobi theory (conjugate points) or the Weierstrass theory (field of extremals and excess function). In the general case such conditions are also known (see [15, 16] and the references therein, and cf. also [17]); however, they use the notion of a *coupled point* which is more complicated than the classical notion of a *conjugate point*. This might be the reason why — as far as the author is aware — that general theory has not yet been applied in the elasticity theory, for example. In the scalar case, another approach to problems with variable endpoints (and a special class of Lagrangians) can be found in [12] but the conditions there are even more complicated than those in [15, 16]. Reference [12] has been cited by several papers dealing with problems in the elasticity theory: Some of those papers use the complicated theory in [12] for scalar problems with special Lagrangians (see [10], for example), some use various ad-hoc estimates to obtain at least partial results in the vector-valued case (when the theory in [12] does not seem to apply, see [11], for example) and some refrain from considering variable endpoints because of the complexity of the theory in [12], see [3], for example, where the authors write: “. . . the application of the conjugate point test with nonclamped ends is a delicate issue . . .”. Difficulties arising in a scalar problem with variable endpoints have also been analyzed in [14], for example.

The main purpose of this paper is to derive simple conditions for u^0 to be a minimizer, and to show how they can be applied to particular problems.

In Section 3 we derive necessary and sufficient conditions for weak minimizers by modifying the Jacobi theory (see Theorem 8 and also Remark 24 for the comparison of our conditions with those in [15, 16]). In Section 4 we use the results from Section 3 to find optimal conditions for the stability of a naturally straight Kirchhoff rod under various types of endpoint constraints. The reasons for this particular application are the following:

- We show that our general results can easily be applied to vector-valued problems in the elasticity theory.
- We solve some open problems (and correct an erroneous result) in [11].
- We show how the choice of endpoint constraints influences the stability of the rod.

In Section 5 we use the Weierstrass theory to derive conditions for weak, strong and global minimizers, see Theorem 15. In this case we restrict our applications in Section 6 to the scalar case $N = 1$. The reason for this restriction is the following: If $N = 1$ and the Lagrangian f is independent of its first variable x , then the phase plane analysis of the corresponding Du Bois-Reymond equation yields a very simple and efficient way to prove (or disprove) the existence of a suitable field of extremals; hence it is sufficient to verify the nonnegativity of the excess function in order to check our conditions. In particular, this approach does not require the verification of sufficient conditions based

on the Jacobi theory and it can be used even if we do not know an explicit formula for u^0 . In Section 6 we first determine the stability of a planar weightless inextensible and unshearable rod (see Example 20). This problem has already been analyzed in [10, 1], for example, but our analysis is simpler than that in [10] and more complete than that in [1]. The notions of weak and strong minimizers are equivalent for functionals Φ in Section 4 and Example 20 (see Remark 12(vi) and Proposition 3, respectively). To illustrate various interesting features of minimizers in a more general case and demonstrate the applicability of our theory, in Example 22 we consider Lagrangians of the form $f(u, p) = u^2 + g(p)$, where g is a double-well function. In particular, the corresponding functional can possess both strong (even global) minimizers and minimizers which are weak but not strong.

Some of our results in the scalar case $N = 1$ have been obtained in the Master thesis [2].

2. PRELIMINARIES

Throughout this paper we will use the symbols $\Phi, f, u^0, a, b, N, I, I_a^{\mathcal{D}}$ and $I_b^{\mathcal{D}}$ introduced in the Introduction. The partial derivatives of f will be denoted by $f_x, f_{u_i}, f_{p_i}, f_{p_i p_j}, \dots$. Given $\mathfrak{f} \in \{f, f_x, f_{u_i}, f_{p_i}, f_{p_i p_j}, \dots\}$, we will use the notation²

$$\mathfrak{f}^0(x) := \mathfrak{f}(x, u^0(x), (u^0)'(x)).$$

If $x \in \{a, b\}$ and W is a space of functions $[a, b] \rightarrow \mathbb{R}^N$, then we set

$$\begin{aligned} I_x^{\mathcal{N}} &:= I \setminus I_x^{\mathcal{D}}, \\ \mathbb{R}_{\mathcal{D},x}^{\mathcal{N}} &:= \{\xi \in \mathbb{R}^N : \xi_i = 0 \text{ for } i \in I_x^{\mathcal{D}}\}, \\ \mathbb{R}_{\mathcal{N},x}^{\mathcal{N}} &:= \{\xi \in \mathbb{R}^N : \xi_i = 0 \text{ for } i \in I_x^{\mathcal{N}}\}, \\ W_{\mathcal{D},x} &:= \{v \in W : v(x) \in \mathbb{R}_{\mathcal{D},x}^{\mathcal{N}}\}, \\ W_{\mathcal{D}} &:= W_{\mathcal{D},a} \cap W_{\mathcal{D},b}. \end{aligned}$$

In particular, if $W = C^1 = C^1([a, b], \mathbb{R}^N)$, then

$$C_{\mathcal{D}}^1 = \{v \in C^1([a, b], \mathbb{R}^N) : v_i(a) = 0 \text{ for } i \in I_a^{\mathcal{D}}, v_i(b) = 0 \text{ for } i \in I_b^{\mathcal{D}}\} \quad (3)$$

is the space of C^1 -test functions. (Notice that the set \mathcal{M} in (2) satisfies $\mathcal{M} = u^0 + C_{\mathcal{D}}^1$.)

The norm in a general Banach space X will be denoted by $\|\cdot\|_X$; the norm in $W^{1,2}$ will also be denoted by $\|\cdot\|_{1,2}$. In particular, if $X = C^1 = C^1([a, b], \mathbb{R}^N)$ or $X = C = C([a, b], \mathbb{R}^N)$, then $\|u\|_{C^1} = \max_{x \in [a, b]} |u(x)| + \max_{x \in [a, b]} |u'(x)|$ or $\|u\|_C = \max_{x \in [a, b]} |u(x)|$, respectively, where $|u(x)|$ denotes the Euclidean norm of $u(x) \in \mathbb{R}^N$. We also set $B_\varepsilon := \{\xi \in \mathbb{R}^N : |\xi| < \varepsilon\}$.

We will assume that u^0 is a critical point of Φ in the set $u^0 + C_{\mathcal{D}}^1$, i.e. $\Phi'(u^0)h = 0$ for any test function $h \in C_{\mathcal{D}}^1$, where Φ' denotes the Fréchet derivative of Φ . The following proposition is well known, but for the reader's convenience we explain the idea of its proof in the Appendix.

²The superscript 0 in \mathfrak{f}^0 denotes evaluation of \mathfrak{f} along the reference arc u^0 ; cf. similar notation $\hat{L}(t) = L(t, \hat{x}(t), \hat{x}'(t))$ in [15] or $\hat{f}(x) = f(x, u(x), u'(x))$ in [8, formulas (30), (39) in Section 2.3, pp. 114–116]. The advantages of our notation will become evident in Section 6: See the notation introduced in Theorem 18.

Proposition 1. *Let $f \in C^1$ and let u^0 be a critical point of Φ in $u^0 + C_D^1$. Then u^0 is an extremal (i.e. it satisfies the Euler equations $\frac{d}{dx}(f_{p_i}^0) = f_{u_i}^0$, $i = 1, 2, \dots, N$), and u^0 also has to satisfy the natural boundary conditions*

$$f_{p_j}^0(a) = 0 \quad \text{for } j \in I_a^N \quad \text{and} \quad f_{p_j}^0(b) = 0 \quad \text{for } j \in I_b^N. \quad (4)$$

If $f_{p_i} \in C^1$ for $i = 1, 2, \dots, N$, and the strengthened Legendre condition

$$(\exists c^0 > 0) \quad \sum_{i,j=1}^N f_{p_i p_j}^0(x) \xi_i \xi_j \geq c^0 |\xi|^2, \quad \xi \in \mathbb{R}^N, \quad x \in [a, b], \quad (5)$$

is true, then $u^0 \in C^2$.

It is known that the Legendre condition (i.e. condition (5) with $c^0 = 0$) is necessary for u^0 to be a minimizer, but even the strengthened Legendre condition is not sufficient, in general. Assuming that

$$f \in C^3 \text{ satisfies (5), where } u^0 \in C^1([a, b], \mathbb{R}^N) \text{ is an extremal satisfying (4),} \quad (6)$$

and denoting $\sum_k = \sum_{k=1}^N$, we set

$$\Psi(h) := \int_a^b \mathfrak{F}(x, h(x), h'(x)) dx, \quad h \in W^{1,2}([a, b], \mathbb{R}^N), \quad (7)$$

where

$$\mathfrak{F} = \mathfrak{F}(x, u, p) := \sum_{i,j} \left(f_{p_i p_j}^0(x) p_i p_j + f_{p_i u_j}^0(x) p_i u_j + f_{u_i p_j}^0(x) u_i p_j + f_{u_i u_j}^0(x) u_i u_j \right). \quad (8)$$

If $h \in C^1$, then $\Psi(h) = \Phi''(u^0)(h, h)$, i.e. Ψ is the second variation of Φ at u^0 . In addition, if $h \in C^2$, then integration by parts yields

$$\Psi(h) = \int_a^b \sum_i (\mathcal{A}_i h) h_i dx + \sum_i (\mathcal{B}_i h) h_i \Big|_a^b, \quad (9)$$

where

$$\mathcal{A}_i h := -\frac{d}{dx}(\mathcal{B}_i h) + \mathcal{C}_i h, \quad \mathcal{B}_i h := \sum_j \left(f_{p_i p_j}^0 h_j' + f_{p_i u_j}^0 h_j \right), \quad \mathcal{C}_i h := \sum_j \left(f_{u_i p_j}^0 h_j' + f_{u_i u_j}^0 h_j \right). \quad (10)$$

Set also

$$\mathcal{A}h := (\mathcal{A}_1 h, \dots, \mathcal{A}_N h), \quad \mathcal{B}h := (\mathcal{B}_1 h, \dots, \mathcal{B}_N h), \quad f_p := (f_{p_1}, \dots, f_{p_N}), \quad f_u = (f_{u_1}, \dots, f_{u_N}).$$

The (vector-valued) second-order linear differential equation $\mathcal{A}h = 0$ is called the *Jacobi equation* (for Φ and u^0): It will play a fundamental role in the study of positive definiteness of Ψ . Notice also that the Jacobi equation is the Euler equation for functional Ψ . More precisely, by using the symmetry relations $f_{p_i p_j} = f_{p_j p_i}$, $f_{p_i u_j} = f_{u_j p_i}$ and $f_{u_i u_j} = f_{u_j u_i}$ we obtain

$$\mathfrak{F}_{p_i}(x, h(x), h'(x)) = 2\mathcal{B}_i h(x), \quad \mathfrak{F}_{u_i}(x, h(x), h'(x)) = 2\mathcal{C}_i h(x), \quad (11)$$

hence

$$2\mathcal{A}_i h(x) = -\frac{d}{dx} \mathfrak{F}_{p_i}(x, h(x), h'(x)) + \mathfrak{F}_{u_i}(x, h(x), h'(x)). \quad (12)$$

Notice also that, given $h, w \in W^{1,2}$, (11) and the symmetry of the second-order derivatives of f mentioned above imply

$$\begin{aligned} \Psi'(h)w &= \int_a^b \sum_i (\mathfrak{F}_{p_i}(x, h(x), h'(x))w'_i(x) + \mathfrak{F}_{u_i}(x, h(x), h'(x))w_i(x)) dx \\ &= 2 \int_a^b \sum_i (\mathcal{B}_i h \cdot w'_i + \mathcal{C}_i h \cdot w_i) dx = 2 \int_a^b \sum_i (\mathcal{B}_i w \cdot h'_i + \mathcal{C}_i w \cdot h_i) dx = \Psi'(w)h. \end{aligned} \quad (13)$$

Definition 2. Let $w \in \mathcal{M}$, where \mathcal{M} is a subset of $C^1([a, b], \mathbb{R}^N)$. The function w is called a *weak* or *strong local minimizer* in \mathcal{M} if there exists $\varepsilon > 0$ such that $\Phi(v) \geq \Phi(w)$ for any $v \in \mathcal{M}$ satisfying $\|v - w\|_{C^1} < \varepsilon$ or $\|v - w\|_C < \varepsilon$, respectively.

Let $w \in \mathcal{N}$, where \mathcal{N} is a subset of $W^{1,2}([a, b], \mathbb{R}^N)$. The function w is called a *local minimizer* in \mathcal{N} if there exists $\varepsilon > 0$ such that $\Phi(v) \geq \Phi(w)$ for any $v \in \mathcal{N}$ satisfying $\|v\|_{1,2} < \varepsilon$.

If the inequalities $\Phi(v) \geq \Phi(w)$ in the definitions above are strict for $v \neq w$, then the minimizer w is called *strict*.

Since the adjectives *weak* and *strong* are not meaningful in the case of global minimizers, we often omit the word “local” in the notions of weak and strong local minimizers. Each strong minimizer is a weak minimizer but the opposite is not true, in general. For example, if $N = 1$ and $f(x, u, p) = p^2 + p^3$, then $u^0 \equiv 0$ is a weak but not strong minimizer of Φ in $u^0 + C^1_{\mathcal{D}}$ for any choice of $a, b, I_a^{\mathcal{D}}$ and $I_b^{\mathcal{D}}$ (see also Example 22 for a less trivial example). On the other hand, the following Proposition 3 and Remark 12(vi) show that in some cases the notions of weak and strong minimizers are equivalent. The choice of the class of Lagrangians in Proposition 3 is motivated by Example 20, where we consider the stability of a planar rod. Proposition 3 is true for any choice of $a, b, I_a^{\mathcal{D}}$ and $I_b^{\mathcal{D}}$; its proof is postponed to the Appendix.

Proposition 3. Let $N = 1$ and $f(x, u, p) = (p - K)^2 + g(u)$, where $K \in \mathbb{R}$ and $g \in C^1(\mathbb{R})$. If $u^0 \in C^1$ is a weak minimizer, then it is a strong minimizer.

The following proposition is a consequence of well known facts (see [8, 5], for example). The assumptions in that proposition are much stronger than necessary, but the proposition will be sufficient for our purposes (see Remark 12(vi), Section 6 and the proof of Proposition 9).

Proposition 4. (i) Let $f \in C^k$, $k \geq 2$.

If $u^0 \in C^1$ is a critical point of Φ in $u^0 + C^1_{\mathcal{D}}$ and (5) is true, then $u^0 \in C^k$ and u^0 satisfies the Du Bois-Reymond equation

$$\frac{d}{dx}(f^0 - (u^0)' \cdot f_p^0) = f_x^0 \quad \text{in } [a, b]. \quad (14)$$

Conversely, if $u^0 \in C^2$ satisfies (14) and $(u^0)' \neq 0$ a.e., then u^0 is an extremal.

(ii) Let $f \in C^1$ satisfy the growth condition $(1 + |p|)|f_p| + |f_u| \leq M(|u|)(1 + |p|)^2$, where $M : [0, \infty) \rightarrow [0, \infty)$ is nondecreasing. Then $\Phi \in C^1(W^{1,2})$. In addition, if $u^0 \in W^{1,2}$ is a local minimizer of Φ in $u^0 + W^{1,2}_{\mathcal{D}}$, then there exists $C \in \mathbb{R}^N$ such that

$$f_p^0(x) = \int_a^x f_u^0(\xi) d\xi + C \quad \text{for a.e. } x \in [a, b].$$

3. JACOBI THEORY

In this section we will prove necessary and sufficient conditions for weak minimizers by modifying the classical Jacobi theory. Throughout this section we assume (6).

The following proposition is well known, but for the reader's convenience we provide its proof in the Appendix.

Proposition 5. *Assume (6) and let Ψ be defined by (7).*

- (i) *If Ψ is positive definite in $W_{\mathcal{D}}^{1,2}$, then u^0 is a strict weak minimizer in $u^0 + C_{\mathcal{D}}^1$.*
- (ii) *If $\Psi(h) < 0$ for some $h \in W_{\mathcal{D}}^{1,2}$, then u^0 is not a weak minimizer in $u^0 + C_{\mathcal{D}}^1$.*

We will consider the scalar case first. Assume that

$$h \text{ is a nontrivial solution of the Jacobi equation } \mathcal{A}h = 0. \quad (15)$$

Then the following classical result for problems with Dirichlet endpoint constraints is well known.

Theorem 6. *Assume (6) with $N = 1$ and (15). Let $I_a^{\mathcal{N}} = I_b^{\mathcal{N}} = \emptyset$ and $h(a) = 0$.*

- (i) *If $h(y) = 0$ for some $y \in (a, b)$, then u^0 is not a weak minimizer.*
- (ii) *If $h(y) \neq 0$ for any $y \in (a, b]$, then u^0 is a strict weak minimizer.*

Our analogue in the case of variable endpoints is the following theorem.

Theorem 7. *Assume (6) with $N = 1$ and (15). Let $I_a^{\mathcal{N}} = I_b^{\mathcal{N}} = \{1\}$ and $\mathcal{B}h(a) = 0$.*

- (i) *If $h(y) = 0$ for some $y \in (a, b]$ or $\mathcal{B}h(b)h(b) < 0$, then u^0 is not a weak minimizer.*
- (ii) *If $h(y) \neq 0$ for any $y \in (a, b]$ and $\mathcal{B}h(b)h(b) > 0$, then u^0 is a strict weak minimizer.*

In fact, a slight generalization of Theorem 7(ii) has been proved in [2]: The initial condition $\mathcal{B}h(a) = 0$ can be replaced with $\mathcal{B}h(a)h(a) \leq 0$. Unfortunately, the method of the proof in [2] does not seem to be easily extendable to the vector-valued case.

Theorems 6 and 7 are special cases of the following general theorem.

Theorem 8. *Assume (6). Let $h^{(1)}, \dots, h^{(N)}$ be linearly independent solutions of the Jacobi equation $\mathcal{A}h = 0$ satisfying the initial conditions $h(a) \in \mathbb{R}_{\mathcal{D},a}^N$, $\mathcal{B}h(a) \in \mathbb{R}_{\mathcal{N},a}^N$. Set*

$$D(x) := \det(h^{(1)}(x), \dots, h^{(N)}(x)), \quad H := \text{span}(h^{(1)}, \dots, h^{(N)}), \quad H_0 := \{h \in H : h(b) = 0\}.$$

- (i) *If $D(x) = 0$ for some $x \in (a, b)$ or*

$$I_b^{\mathcal{N}} \neq \emptyset \quad \text{and} \quad \mathcal{B}h(b) \cdot h(b) < 0 \quad \text{for some } h \in H_{\mathcal{D},b},$$

then u^0 is not a weak minimizer.

- (ii) *If $D \neq 0$ in $(a, b]$ and*

$$\text{either } I_b^{\mathcal{N}} = \emptyset \quad \text{or} \quad \mathcal{B}h(b) \cdot h(b) > 0 \quad \text{for any } h \in H_{\mathcal{D},b} \setminus \{0\},$$

then u^0 is a strict weak minimizer.

- (iii) *Let $D \neq 0$ in (a, b) , $D(b) = 0$ (hence $H_0 \neq \{0\}$), and $I_b^{\mathcal{N}} \neq \emptyset$. If*

$$\text{there exists } h \in H_0 \text{ such that } \mathcal{B}_i h(b) \neq 0 \text{ for some } i \in I_b^{\mathcal{N}}, \quad (16)$$

then u^0 is not a weak minimizer. If $I_b^{\mathcal{D}} = \emptyset$, then (16) is always true.

The proof of Theorem 8 is based on a modification of the classical Jacobi theory, and this is also true in the case of the corresponding proof in [16]. However, our conditions in Theorem 8 are simpler than those in [15, 16], see Remark 24 in the Appendix.

In order to prove Theorem 8, we need some preparation. Given $y \in (a, b]$, let

$$X_y := \{h \in W^{1,2}([a, b], \mathbb{R}^N) : h(a) \in \mathbb{R}_{\mathcal{D}, a}^N, h(x) = 0 \text{ for } x \geq y\}$$

be endowed with the norm $\|h\|_{X_y} := (\int_a^b \sum_{i,j} f_{p_i p_j}^0 h_i' h_j' dx)^{1/2}$ (which is equivalent to the standard norm in $W^{1,2}$ for $h \in X_y$ due to (5) and the boundary condition $h(b) = 0$), and let S_y denote the unit sphere in X_y . If $\tilde{y} \in (y, b]$, then $X_y \subset X_{\tilde{y}}$, hence $S_y \subset S_{\tilde{y}}$. Set also

$$\lambda_1 = \lambda_1(y) := \inf_{h \in S_y} \Psi(h) = 1 + \inf_{h \in S_y} \hat{\Psi}(h), \quad (17)$$

where

$$\hat{\Psi}(h) := \int_a^b \sum_{i,j} (f_{p_i u_j}^0 h_i' h_j + f_{u_i p_j}^0 h_i h_j' + f_{u_i u_j}^0 h_i h_j') dx.$$

Since $S_y \subset S_{\tilde{y}}$ if $y < \tilde{y}$, the function λ_1 is nonincreasing. In addition, one can easily show that λ_1 is continuous, and the estimate

$$\begin{aligned} |h(x)| &= \left| \int_x^y h'(\xi) d\xi \right| \leq \left(\int_x^y |h'(\xi)|^2 d\xi \right)^{1/2} \sqrt{y-x} \\ &\leq \frac{1}{\sqrt{c^0}} \left(\int_a^b \sum_{i,j} f_{p_i p_j}^0 h_i' h_j' d\xi \right)^{1/2} \sqrt{y-a} = \frac{1}{\sqrt{c^0}} \sqrt{y-a} \end{aligned}$$

for $h \in S_y$ and $x \in (a, y)$ implies $\lim_{y \rightarrow a^+} \lambda_1(y) = 1$.

Proposition 9. *Let D be as in Theorem 8 and $y \in (a, b]$.*

(i) *If $\lambda_1(y) = 0$, then $D(y) = 0$ and $\lambda_1(z) < 0$ for $z \in (y, b]$. If $D(y) = 0$, then $\lambda_1(y) \leq 0$.*

(ii) *If $h \in X_b$, then $\Psi(h) \geq \lambda_1(b) \|h\|_{X_b}^2$. If $\lambda_1(b) < 0$, then there exists $h \in X_b$ such that $\Psi(h) < 0$.*

Proof. Let $\lambda_1(y) = 0$ and let B_y denote the closed unit ball in X_y . Since $\hat{\Psi}$ is weakly sequentially continuous, there exists $h_y \in B_y$ such that $\hat{\Psi}(h_y) = \inf_{B_y} \hat{\Psi} = -1$. We have $h_y \in S_y$ (otherwise $th_y \in B_y$ for some $t > 1$, and $\hat{\Psi}(th_y) = t^2 \hat{\Psi}(h_y) < \inf_{B_y} \hat{\Psi}$, which yields a contradiction). Since $\Psi(h_y) = \inf_{S_y} \Psi = 0$, h_y is a global minimizer of Ψ in X_y . Notice that $\mathfrak{F} \in C^1$ satisfies the growth condition

$$(1 + |p|)|\mathfrak{F}_p(x, u, p)| + |\mathfrak{F}_u(x, u, p)| \leq C(1 + |p|)(|u| + |p|) \leq 2C(1 + |u|^2)(1 + |p|^2),$$

where C depends only on the sup-norm of $f_{p_i p_j}^0, f_{p_i u_j}^0, f_{u_i p_j}^0, f_{u_i u_j}^0$, hence Proposition 4(ii) and (11) imply

$$2\mathcal{B}_i h_y(x) = \mathfrak{F}_{p_i}(x, h_y(x), h_y'(x)) = \int_a^x \mathfrak{F}_{u_i}(\xi, h_y(\xi), h_y'(\xi)) d\xi + c_i = \int_a^x 2\mathcal{C}_i h_y d\xi + c_i \quad (18)$$

for a.e. $x \in [a, y]$. Since the right-hand side of (18) is a continuous function of x , $f \in C^3$ and (5) is true (hence the matrix $f_{p_i p_j}^0$ is invertible and the inverse matrix is a continuous function of x), we see that the restriction of h_y to $[a, y]$ is C^1 . Denote this restriction by \bar{h}_y and set $C_y^1 := \{w \in C^1([a, y]) : w(a) \in \mathbb{R}_{\mathcal{D}, a}^N, w(y) = 0\}$, $\Psi_y(h) = \int_a^y \mathfrak{F}(x, h(x), h'(x)) dx$.

Then \bar{h}_y is a critical point of Ψ_y in $\bar{h}_y + C_y^1 = C_y^1$. Now Proposition 1, (12) and (11) imply that \bar{h}_y is C^2 , it satisfies the Jacobi equation $\mathcal{A}h = 0$ in $[a, y]$ and the natural boundary conditions $\mathcal{B}h(a) \in \mathbb{R}_{\mathcal{N},a}^N$. Since we also have $h_y(a) \in \mathbb{R}_{\mathcal{D},a}^N$, there exists $\alpha \in \mathbb{R}^N \setminus \{0\}$ such that $h_y = \sum_k \alpha_k h^{(k)}$ on $[a, y]$, where $h^{(k)}$ are as in Theorem 8. Since $h_y(y) = 0$, we have $D(y) = 0$.

Next assume on the contrary that $\lambda_1(y) = 0 = \lambda_1(z)$ for some $z \in (y, b]$. Then the minimizer h_y is a global minimizer of Ψ in X_z . Similarly as above we deduce that $h_y \in C^2([a, z])$ and h_y solves the Jacobi equation in $[a, z]$. Consequently, $h_y(y) = h'_y(y) = 0$, which yields a contradiction with the uniqueness of solutions of the initial value problem for the Jacobi equation.

Next assume that $D(y) = 0$. Then there exists $\alpha = (\alpha_1, \dots, \alpha_N) \in \mathbb{R}^N \setminus \{0\}$ such that $h := \sum_k \alpha_k h^{(k)}$ satisfies $h(y) = 0$, hence if we set $\tilde{h}(x) := h(x)$ for $x \leq y$ and $\tilde{h}(x) := 0$ otherwise, then $\tilde{h} \in X_y$. In addition, using $\mathcal{A}_i h = 0$, $\mathcal{B}_i h(a) \in \mathbb{R}_{\mathcal{N},a}^N$, $h(a) \in \mathbb{R}_{\mathcal{D},a}^N$ and $h(y) = 0$ we obtain

$$\begin{aligned} \Psi(\tilde{h}) &= \int_a^b \mathfrak{F}(x, \tilde{h}(x), \tilde{h}'(x)) dx = \int_a^y \mathfrak{F}(x, h(x), h'(x)) dx \\ &= \int_a^y \sum_i (\mathcal{A}_i h) h_i dx + \sum_i (\mathcal{B}_i h) h_i \Big|_a^y = 0, \end{aligned}$$

hence $\lambda_1(y) \leq 0$.

If $h \in X_b \setminus \{0\}$, then $\Psi(h) = \|h\|_{X_b}^2 \Psi(h/\|h\|_{X_b}) \geq \lambda_1(b) \|h\|_{X_b}^2$ by the definition of λ_1 . If $\lambda_1(b) < 0$, then the definition of λ_1 implies the existence of $h \in S_b$ such that $\Psi(h) < 0$. \square

Proof of Theorem 8. We will show that

$$\text{the assumptions in (i) (or (iii)) imply } \Psi(h) < 0 \text{ for some } h \in W_{\mathcal{D}}^{1,2}, \quad (19)$$

while

$$\text{the assumptions in (ii) guarantee that } \Psi \text{ is positive definite in } W_{\mathcal{D}}^{1,2}, \quad (20)$$

hence the assertions in Theorem 8 will follow from Proposition 5.

(i) If $D(x) = 0$ for some $x \in (a, b)$, then Proposition 9(i) implies $\lambda_1(x) \leq 0$ and $\lambda_1(b) < 0$, hence Proposition 9(ii) implies the existence of $h \in X_b \subset W_{\mathcal{D}}^{1,2}$ such that $\Psi(h) < 0$.

If $I_b^{\mathcal{N}} \neq \emptyset$ and $\mathcal{B}h(b) \cdot h(b) < 0$ for some $h \in H_{\mathcal{D},b} \subset W_{\mathcal{D}}^{1,2}$, then $\mathcal{A}h = 0$, $h_i(a) = 0$ for $i \in I_a^{\mathcal{D}}$ and $\mathcal{B}_i h(a) = 0$ for $i \in I_a^{\mathcal{N}}$, hence (9) implies

$$\Psi(h) = \mathcal{B}h \cdot h \Big|_a^b = \mathcal{B}h(b) \cdot h(b) < 0.$$

(ii) Assume that $D \neq 0$ in $(a, b]$. Then Proposition 9 implies $\lambda_1(b) > 0$ and $\Psi(h) \geq \lambda_1(b) \|h\|_{X_b}^2$ for $h \in X_b$. If $I_b^{\mathcal{N}} = \emptyset$, then $X_b = W_{\mathcal{D}}^{1,2}$, hence we are done.

Next assume that $I_b^{\mathcal{N}} \neq \emptyset$ and $\mathcal{B}\tilde{h}(b) \cdot \tilde{h}(b) > 0$ for any $\tilde{h} \in H_{\mathcal{D},b} \setminus \{0\}$ (hence $\mathcal{B}\tilde{h}(b) \cdot \tilde{h}(b) \geq c_1 \|\tilde{h}\|_{1,2}^2$ for some $c_1 > 0$ due to $\dim H_{\mathcal{D},b} < \infty$), and let $h \in W_{\mathcal{D}}^{1,2}$ be fixed. Since $D(b) \neq 0$, there exists $\alpha \in \mathbb{R}^N$ such that $\tilde{h} := \sum_k \alpha_k h^{(k)}$ satisfies $\tilde{h}(b) = h(b)$. In particular, $\tilde{h} \in H_{\mathcal{D},b}$. Set $\hat{h} := h - \tilde{h}$. Then $\hat{h} \in X_b$, hence $\Psi(\hat{h}) \geq \lambda_1(b) \|\hat{h}\|_{X_b}^2$. In addition, $\Psi(\tilde{h}) = \mathcal{B}\tilde{h}(b) \cdot \tilde{h}(b) \geq c_1 \|\tilde{h}\|_{1,2}^2$. Since Ψ is a quadratic functional, we have

$\Psi''(\tilde{h})(\hat{h}, \hat{h}) = 2\Psi(\hat{h})$ and $\Psi''' = 0$. Using (13) and integration by parts we also obtain

$$\Psi'(\hat{h})\tilde{h} = \Psi'(\tilde{h})\hat{h} = 2 \int_a^b \mathcal{A}\tilde{h} \cdot \hat{h} \, dx + 2\mathcal{B}\tilde{h} \cdot \hat{h} \Big|_a^b = 0,$$

hence there exists $c > 0$ such that

$$\Psi(h) = \Psi(\tilde{h} + \hat{h}) = \Psi(\tilde{h}) + \Psi'(\tilde{h})\hat{h} + \frac{1}{2}\Psi''(\tilde{h})(\hat{h}, \hat{h}) = \Psi(\tilde{h}) + \Psi(\hat{h}) \geq c\|h\|_{1,2}^2.$$

(iii) Let $h \in H_0$ and $\mathcal{B}_i h(b) \neq 0$ for some $i \in I_b^N$. Then $\mathcal{A}h = 0$, $h(a) \in \mathbb{R}_{\mathcal{D},a}^N$, $\mathcal{B}h(a) \in \mathbb{R}_{\mathcal{N},a}^N$ and $h(b) = 0$, hence

$$\Psi(h) = \int_a^b \mathcal{A}h \cdot h \, dx + \mathcal{B}h \cdot h \Big|_a^b = 0.$$

Notice also that $h \neq 0$ due to $\mathcal{B}_i h(b) \neq 0$. Since $D \neq 0$ in (a, b) , $D(b) = 0$, $\lim_{y \rightarrow a^+} \lambda_1(y) = 1$ and λ_1 is continuous and nonincreasing, Proposition 9(i) implies $\lambda_1(b) = 0$, hence h is a global minimizer of Ψ in X_b . Choose $\tilde{h} \in C_1^{\mathcal{D}}$ with $\tilde{h}(a) = 0$, $\tilde{h}_j(b) = \delta_{ij}$ for $j = 1, 2, \dots, N$. Then

$$\Psi'(h)\tilde{h} = 2 \int_a^b \mathcal{A}h \cdot \tilde{h} \, dx + 2\mathcal{B}h \cdot \tilde{h} \Big|_a^b = 2\mathcal{B}_i h(b) \neq 0,$$

hence

$$\Psi(h + \varepsilon\tilde{h}) = \varepsilon\Psi'(h)\tilde{h} + o(\varepsilon) < 0$$

provided $|\varepsilon|$ is small enough and $\varepsilon\mathcal{B}_i h(b) < 0$.

If $I_b^{\mathcal{D}} = \emptyset$ and $h \in H_0 \setminus \{0\}$, then $\mathcal{A}h = 0$ and $h(b) = 0$, hence the uniqueness of the initial value problem for the Jacobi equation implies the existence of $i \in I_b^N = I$ such that $\mathcal{B}_i h(b) \neq 0$. \square

Remark 10. (i) If Ψ is positive semidefinite but not positive definite, then there exists $h^* \in W_{\mathcal{D}}^{1,2} \setminus \{0\}$ such that $0 = \Psi(h^*) = \inf_{W_{\mathcal{D}}^{1,2}} \Psi$ and h^* can be determined from our analysis. For example, if $N = 1$ and $I_a^{\mathcal{D}} = I_b^{\mathcal{D}} = \emptyset$ (cf. Theorem 7), then h^* is a positive (or negative) solution of the Jacobi equation satisfying $\mathcal{B}h^*(a) = \mathcal{B}h^*(b) = 0$. If Φ depends smoothly on a parameter θ , u^0 is a critical point of Φ for any θ , and u^0 is (or is not, respectively) a weak minimizer for $\theta > \theta^*$ (or $\theta < \theta^*$, respectively), then the critical parameter θ^* corresponds to the case where h^* exists. (Such situation occurs, for example, in the study of stability of a twisted rod in Section 4.) In this case one can expect bifurcation for the problem $\Phi'(u) = 0$ at $\theta = \theta^*$ in the direction of h^* , cf. [6, Theorem 5.6].

(ii) Let $h^{(k)}$, $k = 1, 2, \dots, N$, be as in Theorem 8, $\xi \in \mathbb{R}^N$ and $h^\xi := \sum_k \xi_k h^{(k)}$. Set $\mathfrak{A} := (a_{kl})_{k,l=1}^N$, where $a_{kl} = \mathcal{B}h^{(k)}(b) \cdot h^{(l)}(b)$, and

$$\Xi_{\mathcal{D}} := \{\xi \in \mathbb{R}^N : h^\xi(b) \in \mathbb{R}_{\mathcal{D},b}^N\}.$$

Then $\mathcal{B}h^\xi(b) \cdot h^\xi(b) = \mathfrak{A}\xi \cdot \xi$, i.e. the condition $\mathcal{B}h(b) \cdot h(b) > 0$ for any $h \in H_{\mathcal{D},b} \setminus \{0\}$ in Theorem 8(ii), for example, is equivalent to $\mathfrak{A}\xi \cdot \xi > 0$ for any $\xi \in \Xi_{\mathcal{D}} \setminus \{0\}$. In particular, if $I_b^{\mathcal{D}} = \emptyset$ (and $D(b) \neq 0$), then that condition is equivalent to the positive definiteness of the matrix \mathfrak{A} . Notice also that $a_{kl} = a_{lk}$ due to $2a_{kl} = \Psi'(h^{(k)})h^{(l)}$ and $\Psi'(h^{(k)})h^{(l)} = \Psi'(h^{(l)})h^{(k)}$.

(iii) Assertions (20) or (19) show that some of the assumptions in Theorem 8 are sufficient for the positivity or the negativity of Ψ , respectively. We will show that those assumptions are also necessary, at least in some cases.

Let Ψ be positive definite in $W_{\mathcal{D}}^{1,2}$. Since $X_b \subset W_{\mathcal{D}}^{1,2}$, Ψ is also positive definite in X_b and Proposition 9(i) implies $D \neq 0$ in $[a, b]$. If $I_b^{\mathcal{N}} \neq \emptyset$ and $h \in H_{\mathcal{D},b} \setminus \{0\}$, then $h \in W_{\mathcal{D}}^{1,2}$, $\mathcal{B}h(a) \in \mathbb{R}_{\mathcal{N},a}^{\mathcal{N}}$, $\mathcal{A}h = 0$, hence

$$0 < \Psi(h) = \int_a^b \mathcal{A}h \cdot h \, dx + \mathcal{B}h \cdot h \Big|_a^b = \mathcal{B}h(b) \cdot h(b),$$

so that the assumptions in Theorem 8(ii) are satisfied. This fact and (20) show that the positive definiteness of Ψ in $W_{\mathcal{D}}^{1,2}$ and the assumptions of Theorem 8(ii) are equivalent.

Let $\Psi(\bar{h}) < 0$ for some $\bar{h} \in W_{\mathcal{D}}^{1,2}$ and

$$I_b^{\mathcal{D}} = \emptyset \quad \text{or} \quad I_b^{\mathcal{N}} = \emptyset. \quad (21)$$

Assume that the assumptions of Theorem 8(i) are not satisfied. Then $D \neq 0$ in (a, b) (hence $\lambda_1(b) \geq 0$ due to Proposition 9(i)) and either $I_b^{\mathcal{N}} = \emptyset$ or $\mathcal{B}h(b) \cdot h(b) \geq 0$ for any $h \in H_{\mathcal{D},b}$. If $I_b^{\mathcal{N}} = \emptyset$, then $W_{\mathcal{D}}^{1,2} = X_b$, hence $\Psi \geq 0$ in $W_{\mathcal{D}}^{1,2}$, which is a contradiction. Consequently, $I_b^{\mathcal{N}} \neq \emptyset$, $\mathcal{B}h(b) \cdot h(b) \geq 0$ for any $h \in H_{\mathcal{D},b}$ and $I_b^{\mathcal{D}} = \emptyset$ (due to (21)). If $D(b) \neq 0$, then there exists $\tilde{h} \in H_{\mathcal{D},b}$ such that $\tilde{h}(b) = \bar{h}(b)$. Set $\hat{h} := \bar{h} - \tilde{h} \in X_b$. Then similarly as in the proof of Theorem 8(ii) we obtain

$$0 > \Psi(\bar{h}) = \Psi(\tilde{h} + \hat{h}) = \Psi(\tilde{h}) + \Psi(\hat{h}) \geq \mathcal{B}\tilde{h}(b) \cdot \tilde{h}(b) + \lambda_1(b) \|\hat{h}\|_{X_b}^2 \geq 0,$$

which is a contradiction. Consequently, $D(b) = 0$. Since $I_b^{\mathcal{D}} = \emptyset$ implies (16), all assumptions of Theorem 8(iii) are satisfied. These considerations and (19) show that if (21) is true, then the condition $\Psi(\bar{h}) < 0$ for some $\bar{h} \in W_{\mathcal{D}}^{1,2}$ is satisfied if and only if the assumptions of Theorem 8(i) or the assumptions of Theorem 8(iii) are satisfied. \square

4. STABILITY OF A TWISTED ROD

In this section we use Theorem 8 in order to determine the stability of an unbuckled state of an inextensible, unshearable, isotropic Kirchhoff rod. Under suitable assumptions the strain energy of the rod is given by

$$\Phi(u) = \int_0^1 \left(\frac{A}{2} ((u'_1)^2 + (u'_2)^2 \sin^2 u_1) + \frac{C}{2} (u'_3 + u'_2 \cos u_1)^2 + FL^2 \sin u_1 \cos u_2 \right) dx,$$

where u_1, u_2, u_3 are so called Euler angles describing the orientation of the director basis, $A, C > 0$ are constants, L is the rod-length and $F \in \mathbb{R}$ is an external terminal load; the rod is oriented horizontally (along the x axis), see [11, (9)]. The unbuckled state is given by $u^0(x) := (\frac{\pi}{2}, 0, 2\pi Mx)$ where M is a twist parameter. Notice that u^0 is an extremal satisfying the natural boundary conditions $f_{p_i}^0(x) = 0$ for $i = 1, 2$ and $x = 0, 1$. The stability of u^0 was studied in [11] under the Dirichlet boundary conditions $u_3(x) = u_3^0(x)$ for $x = 0, 1$, and one of the following sets of boundary conditions for u_1, u_2 :

$$u_1(0) = u_1(1) = \pi/2, \quad u_2(0) = u_2(1) = 0, \quad (22)$$

$$u_1(0) = u_1(1) = \pi/2, \quad u'_2(0) = u'_2(1) = 0, \quad (23)$$

$$u'_1(0) = u'_1(1) = 0, \quad u'_2(0) = u'_2(1) = 0. \quad (24)$$

The results in [11] are essentially optimal in case (22), but the results in cases (23) and (24) are only partial, leaving several open problems. Notice that the Neumann boundary conditions are not the same as the natural boundary conditions in general (see [13] for related issues), but one can easily show (see Proposition 25 and Remark 26 in the Appendix) that the problem of stability of u^0 considered in [11] in cases (23) and (24) is equivalent to the question whether u^0 is a weak minimizer of Φ in $u^0 + C_{\mathcal{D}}^1$ with $I_0^{\mathcal{N}} = I_1^{\mathcal{N}} = \{2\}$ and $I_0^{\mathcal{N}} = I_1^{\mathcal{N}} = \{1, 2\}$, respectively; hence we can use Theorem 8 in order to solve those problems. In fact, we will consider all possible subsets $I_0^{\mathcal{N}}, I_1^{\mathcal{N}}$ of $\{1, 2\}$, and in each case we will find the borderline between the stability and instability (i.e. between the situations when u^0 is and is not a weak minimizer, respectively). On the other hand, we will always assume $3 \in I_0^{\mathcal{D}} \cap I_1^{\mathcal{D}}$, i.e. we will always consider the Dirichlet boundary conditions for the third component u_3 .

In order to have a more graphic notation, given $I_0^{\mathcal{N}}, I_1^{\mathcal{N}} \subset \{1, 2\}$, we denote the corresponding case by $\binom{c_0^1 c_1^1}{c_0^2 c_1^2}$, where $c_j^i = \mathcal{N}$ if $i \in I_j^{\mathcal{N}}$, $c_j^i = \mathcal{D}$ if $i \in I_j^{\mathcal{D}}$, $i = 1, 2, j = 0, 1$. For example, $\binom{\mathcal{D}\mathcal{D}}{\mathcal{N}\mathcal{N}}$ corresponds to the case $I_0^{\mathcal{N}} = I_1^{\mathcal{N}} = \{2\}$, i.e. (23), and $\binom{\mathcal{N}\mathcal{N}}{\mathcal{N}\mathcal{N}}$ corresponds to the case $I_0^{\mathcal{N}} = I_1^{\mathcal{N}} = \{1, 2\}$, i.e. (24). Set also

$$\alpha := \frac{2\pi CM}{A}, \quad \beta := -\frac{FL^2}{A}, \quad \gamma := \sqrt{\left|\beta - \frac{1}{4}\alpha^2\right|}, \quad \delta := \frac{\alpha}{2}, \quad \theta := \frac{2\gamma\delta}{\gamma^2 + \delta^2}. \quad (25)$$

We will show that we may assume $\alpha > 0$, and for any $\binom{c_0^1 c_1^1}{c_0^2 c_1^2}$ with $c_j^i \in \{\mathcal{D}, \mathcal{N}\}$ we will find a function $g = g_{\binom{c_0^1 c_1^1}{c_0^2 c_1^2}} : (0, \infty) \rightarrow \mathbb{R} : \alpha \mapsto \beta$ which describes the borderline between stability and instability. In the particular cases (22), (23) and (24) we will also use the notation

$$g_{\mathcal{D}} := g_{\mathcal{D}\mathcal{D}}, \quad g_{\mathcal{M}} := g_{\mathcal{D}\mathcal{N}}, \quad \text{and} \quad g_{\mathcal{N}} := g_{\mathcal{N}\mathcal{N}},$$

respectively (the notation $g_{\mathcal{M}}$ reflects the fact that case (23) is called ‘‘Mixed’’ in [11, (13)]).

Proposition 11. *Let u^0 be as above, $\alpha > 0$, and let $I_0^{\mathcal{N}}, I_1^{\mathcal{N}} \subset \{1, 2\}$ be fixed. Then there exists a continuous function $g : (0, \infty) \rightarrow \mathbb{R}$ having the properties mentioned above, i.e. if $\beta > g(\alpha)$ (or $\beta < g(\alpha)$, resp.), then u^0 is a strict weak minimizer (or is not a weak minimizer, resp.).*

(i) *Let $I_0^{\mathcal{D}} \cap \{1, 2\} \neq \emptyset \neq I_1^{\mathcal{D}} \cap \{1, 2\}$. Then*

$$g_{\mathcal{N}\mathcal{D}}^{\mathcal{D}\mathcal{D}} = g_{\mathcal{D}\mathcal{N}}^{\mathcal{D}\mathcal{D}} = g_{\mathcal{D}\mathcal{D}}^{\mathcal{D}\mathcal{N}} = g_{\mathcal{D}\mathcal{D}}^{\mathcal{N}\mathcal{D}}, \quad g_{\mathcal{N}\mathcal{D}}^{\mathcal{D}\mathcal{N}} = g_{\mathcal{D}\mathcal{N}}^{\mathcal{N}\mathcal{D}}, \quad g_{\mathcal{N}\mathcal{N}}^{\mathcal{D}\mathcal{D}} = g_{\mathcal{D}\mathcal{D}}^{\mathcal{N}\mathcal{N}} (= g_{\mathcal{M}}), \quad (26)$$

$$\left. \begin{aligned} g_{\mathcal{D}}(\alpha) &= \frac{\alpha^2}{4} - \pi^2, & g_{\mathcal{N}\mathcal{D}}^{\mathcal{D}\mathcal{D}}(\alpha) &= \frac{\alpha^2}{4} - \frac{\pi^2}{4}, \\ g_{\mathcal{N}\mathcal{D}}^{\mathcal{D}\mathcal{N}}(\alpha) &= (k + \frac{1}{2})\pi(\alpha - (k + \frac{1}{2})\pi) & \text{if } \alpha \in [2k\pi, 2(k+1)\pi], & \quad k = 0, 1, 2, \dots, \\ g_{\mathcal{M}}(\alpha) &= k\pi(\alpha - k\pi) & \text{if } \alpha \in [(2k-1)\pi, (2k+1)\pi], & \quad k = 0, 1, 2, \dots \end{aligned} \right\} \quad (27)$$

(ii) *Let either $I_0^{\mathcal{D}} \cap \{1, 2\} = \emptyset$ or $I_1^{\mathcal{D}} \cap \{1, 2\} = \emptyset$. Then*

$$g_{\mathcal{N}\mathcal{D}}^{\mathcal{N}\mathcal{D}} = g_{\mathcal{D}\mathcal{N}}^{\mathcal{D}\mathcal{N}}, \quad g_{\mathcal{N}\mathcal{D}}^{\mathcal{N}\mathcal{N}} = g_{\mathcal{D}\mathcal{N}}^{\mathcal{N}\mathcal{N}}, \quad g_{\mathcal{N}\mathcal{N}}^{\mathcal{N}\mathcal{D}} = g_{\mathcal{D}\mathcal{N}}^{\mathcal{D}\mathcal{N}}, \quad (28)$$

$$\begin{aligned}
g_N(\alpha) &= \inf\{\beta \geq \frac{1}{2}\alpha^2 : (1 - \theta^2) \cosh(2\gamma) + \theta^2 \cos(2\delta) = 1\} \in [\frac{1}{2}\alpha^2, \alpha^2], \\
g_{\mathcal{N}\mathcal{D}}^{\mathcal{N}\mathcal{D}}(\alpha) &= \begin{cases} \sup\{\beta \in (\frac{1}{4}\alpha^2, \frac{1}{2}\alpha^2) : (\alpha^2 - 2\beta) \cosh(2\gamma) = 2\beta\} & \text{if } \alpha > 2, \\ \frac{1}{4}\alpha^2 & \text{if } \alpha = 2, \\ \sup\{\beta \in (\frac{1}{4}(\alpha^2 - \pi^2), \frac{1}{4}\alpha^2) : (\alpha^2 - 2\beta) \cos(2\gamma) = 2\beta\} & \text{if } \alpha \in (0, 2), \end{cases} \\
g_{\mathcal{N}\mathcal{D}}^{\mathcal{N}\mathcal{N}}(\alpha) &= \inf\{\beta \geq \beta_\alpha : (\gamma^2 - \delta^2) \sinh(2\gamma) = 2\gamma\delta \sin(2\delta)\}, \quad \beta_\alpha := \begin{cases} \frac{1}{2}\alpha^2 & \text{if } \alpha \leq \pi, \\ g_{\mathcal{N}\mathcal{D}}^{\mathcal{N}\mathcal{D}}(\alpha) & \text{if } \alpha > \pi, \end{cases} \\
g_{\mathcal{N}\mathcal{N}}^{\mathcal{N}\mathcal{D}}(\alpha) &= \begin{cases} \inf\{\beta \geq g_{\mathcal{N}\mathcal{D}}^{\mathcal{N}\mathcal{D}}(\alpha) : (\gamma^2 - \delta^2) \sinh(2\gamma) = -2\gamma\delta \sin(2\delta)\} & \text{if } \alpha \geq \alpha_0, \\ \inf\{\beta \geq g_{\mathcal{N}\mathcal{D}}^{\mathcal{N}\mathcal{D}}(\alpha) : \xi_1^2 \sin \xi_2 \cos \xi_1 = \xi_2^2 \sin \xi_1 \cos \xi_2\} & \text{if } \alpha \in (\frac{1}{2}\pi, \alpha_0), \\ 0 & \text{if } \alpha \in (0, \frac{1}{2}\pi], \end{cases}
\end{aligned}$$

where $\xi_i := -\frac{1}{2}\alpha \pm \gamma$ and $\alpha_0 > 0$ is defined by $\alpha_0 = 2 \sin \alpha_0$.

Remark 12. (i) If u^0 is a weak minimizer of Φ with given $I_0^{\mathcal{N}}, I_1^{\mathcal{N}}$ (and the borderline function g), then it remains a weak minimizer if we replace $I_x^{\mathcal{N}}$ with any subset of $I_x^{\mathcal{N}}$ for $x = 0, 1$, since the set $C_{\mathcal{D}}^1$ becomes smaller. Therefore the new borderline function \tilde{g} has to satisfy $\tilde{g} \leq g$. In particular, $g_{\mathcal{D}} \leq g \leq g_N$ for any borderline function g , $g_{\mathcal{N}\mathcal{D}}^{\mathcal{N}\mathcal{D}} \leq \min(g_{\mathcal{N}\mathcal{D}}^{\mathcal{N}\mathcal{N}}, g_{\mathcal{N}\mathcal{N}}^{\mathcal{N}\mathcal{D}})$, and $g_{\mathcal{N}\mathcal{D}}^{\mathcal{N}\mathcal{D}}(\alpha) \geq g_{\mathcal{N}\mathcal{D}}^{\mathcal{D}\mathcal{D}}(\alpha) = \frac{1}{4}(\alpha^2 - \pi^2)$. We also have $g_N(\alpha) \leq \alpha^2$ since the Cauchy inequality implies that the corresponding functional Ψ is positive definite for $\beta > \alpha^2$.

(ii) If $\alpha \in (0, \alpha_0)$ is fixed, then the function $\Xi(\beta) := \xi_1^2 \sin \xi_2 \cos \xi_1 - \xi_2^2 \sin \xi_1 \cos \xi_2$ appearing in the formula for $g_{\mathcal{N}\mathcal{N}}^{\mathcal{N}\mathcal{D}}$ in Proposition 11 has a unique root β^* in the interval $[g_{\mathcal{N}\mathcal{D}}^{\mathcal{N}\mathcal{D}}(\alpha), \frac{1}{4}\alpha^2)$: This follows from our proof, since any root in that interval corresponds to the case when the corresponding functional Ψ is positive semidefinite but not positive definite, and the form of Ψ guarantees that, given α , this can happen only for one β . Consequently,

$$g_{\mathcal{N}\mathcal{N}}^{\mathcal{N}\mathcal{D}}(\alpha) = \sup\{\beta < \frac{1}{4}\alpha^2 : \xi_1^2 \sin \xi_2 \cos \xi_1 = \xi_2^2 \sin \xi_1 \cos \xi_2\} \quad \text{if } \alpha \in (0, \alpha_0).$$

In addition, our proof implies that if $\beta^* > g_{\mathcal{N}\mathcal{D}}^{\mathcal{N}\mathcal{D}}(\alpha)$, then Ξ changes sign at β^* . Similarly, if $\alpha > \alpha_0$ (or $\alpha > 0$, resp.), then the function $(\gamma^2 - \delta^2) \sinh(2\gamma) + 2\gamma\delta \sin(2\delta)$ (or $(\gamma^2 - \delta^2) \sinh(2\gamma) - 2\gamma\delta \sin(2\delta)$, resp.) has a unique root β^* in the interval $[g_{\mathcal{N}\mathcal{D}}^{\mathcal{N}\mathcal{D}}(\alpha), \infty)$ (or $[\beta_\alpha, \infty)$, resp.), and it changes sign at β^* if $\beta^* > g_{\mathcal{N}\mathcal{D}}^{\mathcal{N}\mathcal{D}}(\alpha)$ (or $\beta^* > \beta_\alpha$, resp.). In addition, the estimates in (i) guarantee that that root β^* satisfies $\beta^* \leq g_N(\alpha) \leq \alpha^2$. Analogous statements are true in the case of g_N .

(iii) Our definition of α and β in (25) implies that the borderline function g_M was estimated above and below in [11, Proposition 6] by functions

$$\overline{g_M}(\alpha) := \max(0, \alpha^2 - \pi^2) \quad \text{and} \quad \underline{g_M}(\alpha) := \pi^2(\alpha^2 - \pi^2)/(\alpha^2 + \pi^2),$$

respectively, see Figure 1. Let us also mention that the the upper bound $\overline{g_N}(\alpha) := \frac{1}{4}\alpha^2$ for $g_N(\alpha)$ in [11, Proposition 5] is incorrect: The error is explained below.

(iv) The function $\hat{g}(\alpha) := \frac{1}{2}\alpha^2$ is a good approximation of functions g in Proposition 11(ii) for α large, see Table 1 and Figure 2. The functions $g_{\mathcal{N}\mathcal{N}}^{\mathcal{N}\mathcal{D}}, g_{\mathcal{N}\mathcal{D}}^{\mathcal{N}\mathcal{N}}$ oscillate between g_N and $g_{\mathcal{N}\mathcal{D}}^{\mathcal{N}\mathcal{D}}$, they intersect each other whenever $\alpha = k\pi$, $k = 1, 2, \dots$, and then their common values equal $\hat{g}(\alpha)$ (and also $g_N(\alpha)$ if k is even). Similarly,

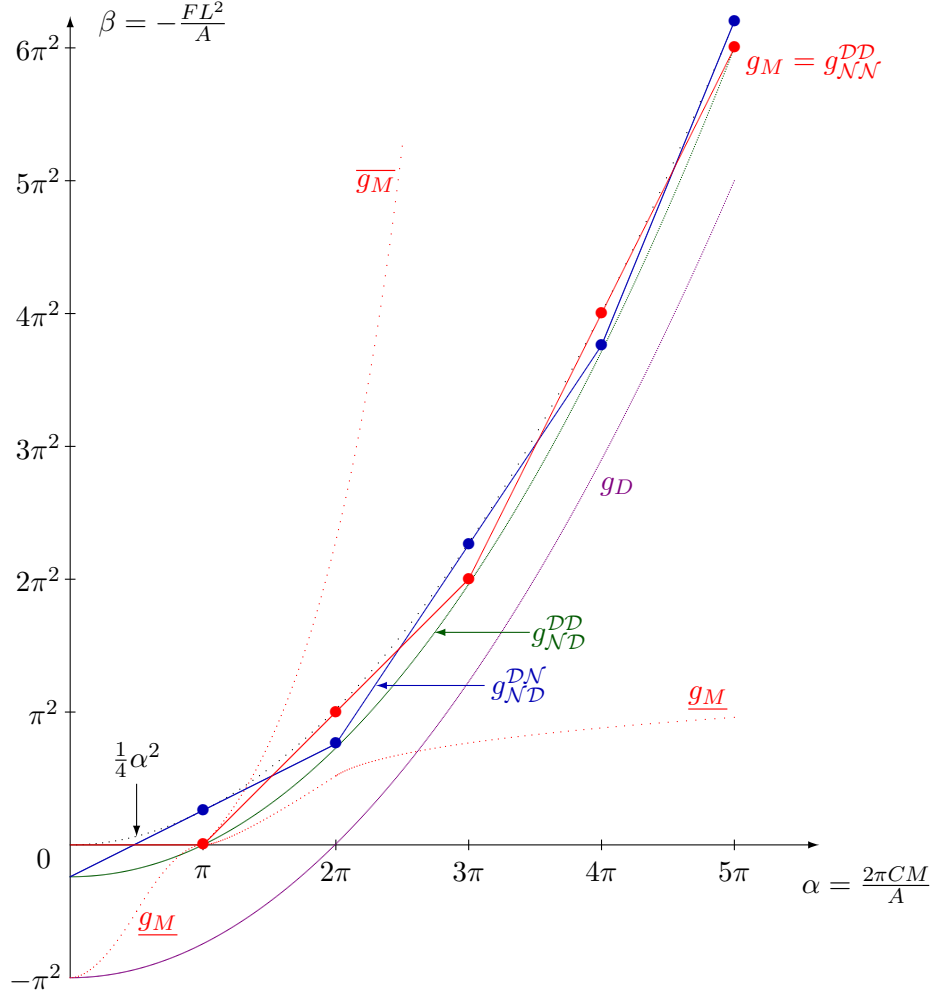
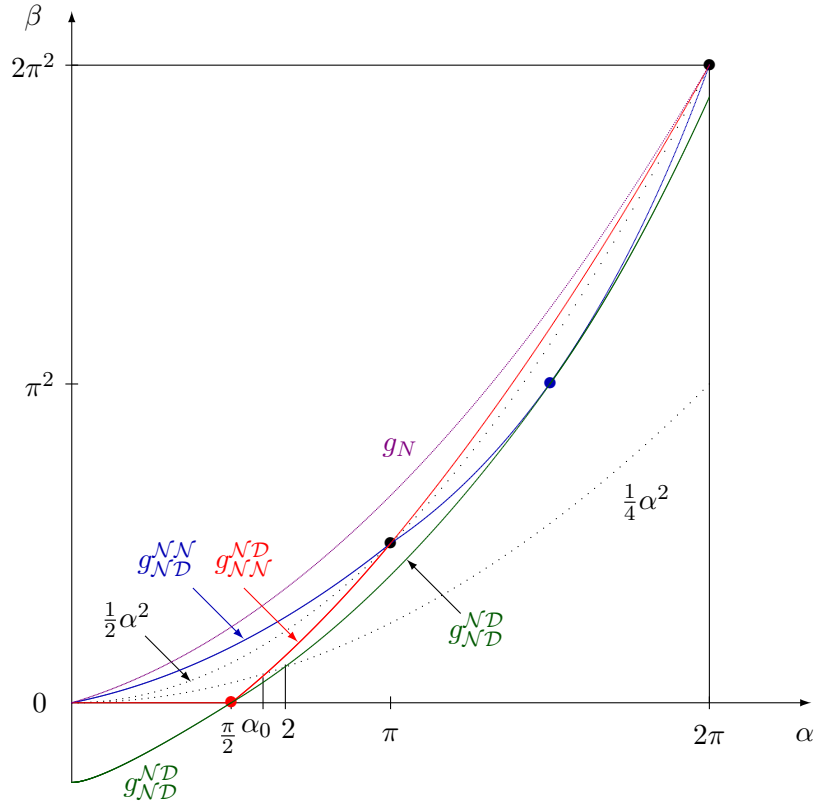

FIGURE 1. The case $I_0^D \cap \{1, 2\} \neq \emptyset \neq I_1^D \cap \{1, 2\}$.

$\min(g_{NN}^{\mathcal{D}}(\alpha), g_{N\mathcal{D}}^{\mathcal{N}}(\alpha)) = g_{N\mathcal{D}}^{\mathcal{N}}(\alpha)$ if $\alpha = (k + \frac{1}{2})\pi$, $k = 0, 1, 2, \dots$. Similar behavior of functions $\tilde{g}(\alpha) = \frac{1}{4}\alpha^2$ and g_M , $g_{N\mathcal{D}}^{\mathcal{D}\mathcal{N}}$, $g_{N\mathcal{D}}^{\mathcal{D}\mathcal{D}}$ can be observed in Figure 1. The formulas for functions g in Proposition 11(ii) can be used in the numerical computations of g , but they also can be used in the study of the asymptotic or qualitative behavior of g . For example, they imply that $\lim_{\alpha \rightarrow 0^+} \frac{g_N(\alpha)}{\alpha^2} = 1$, $\lim_{\alpha \rightarrow \infty} (\hat{g} - g_{N\mathcal{D}}^{\mathcal{D}\mathcal{N}})(\alpha) = 0$, $g_{N\mathcal{D}}^{\mathcal{D}\mathcal{N}}$ is $C^1 \setminus C^2$ at $\alpha = 2$, and g_N is $C \setminus C^1$ at $\alpha = 2k\pi$, $k = 1, 2, \dots$.

(v) Numerical computations determining the borderlines for stability could be used also if we did not know the formulas for functions g in Proposition 11. If $\beta_0 < \beta_1$ and the problem with parameters (α_0, β_0) or (α_0, β_1) is unstable or stable, respectively, then one can set $\beta_2 := (\beta_0 + \beta_1)/2$ and numerically solve the Jacobi equations with suitable initial conditions and parameters (α_0, β_2) (by the Euler method, for example). If that problem is stable or unstable, then one can set $\beta_3 := (\beta_0 + \beta_2)/2$ or $\beta_3 := (\beta_2 + \beta_1)/2$, respectively, and solve the problem with parameters (α_0, β_3) etc. In fact, we used such general approach to

FIGURE 2. The case $I_0^{\mathcal{D}} \cap \{1, 2\} = \emptyset$.

α/π	$g_N(\alpha)/\pi^2$	$g_{NN}^{ND}(\alpha)/\pi^2$	$\hat{g}(\alpha)/\pi^2$	$g_{NN}^{ND}(\alpha)/\pi^2$	$g_{ND}^{ND}(\alpha)/\pi^2$	$\Delta_{\max}(\alpha)/\pi^2$
0	0	0	0	0	-0.25	0.25
0.3	0.0842	0.0732	0.045	0.0000	-0.1222	0.2064
0.5	0.2137	0.1679	0.125	0.0000	0.0000	0.2137
0.7	0.3792	0.2820	0.245	0.1826	0.1533	0.2258
1.0	0.6717	0.5000	0.500	0.5000	0.4446	0.2271
1.3	1.0067	0.8197	0.845	0.8663	0.8129	0.1938
1.5	1.2549	1.1032	1.125	1.1440	1.1032	0.1516
1.7	1.5279	1.4334	1.445	1.4558	1.4305	0.0973
2.0	2.0000	2.0000	2.000	2.0000	1.9923	0.0076
2.5	3.2058	3.1274	3.125	3.1225	3.1225	0.0832
3.0	4.5759	4.5000	4.500	4.5000	4.4992	0.0767
3.5	6.1596	6.1248	6.125	6.1252	6.1248	0.0348
4.0	8.0000	8.0000	8.000	8.0000	7.9999	0.0001

TABLE 1. Numerical values of functions g and $\Delta_{\max} := g_N - g_{ND}^{ND}$ if $I_0^{\mathcal{D}} \cap \{1, 2\} = \emptyset$.

compute the numerical values of functions g_N and $g_{N\mathcal{D}}^{\mathcal{D}}$ first, and we verified a posteriori that the computed critical parameters correspond to the critical values determined by Proposition 11.

(vi) Let u^0 be a weak minimizer. Then a straightforward modification of the proof of Proposition 3 shows that u^0 is also a strong minimizer. In fact, assume first that there exist $v^k \in W_{\mathcal{D}}^{1,2}$ such that $r_k := \|v^k\|_{1,2} \rightarrow 0$ and $\Phi(u^0 + v^k) < \Phi(u^0)$. Since $\Phi \in C^1(W^{1,2})$ is weakly sequentially lower semicontinuous, we can find a minimizer u^k of Φ in $\{u \in u^0 + W_{\mathcal{D}}^{1,2} : \|u - u^0\|_{1,2} \leq r_k\}$ and Lagrange multipliers $\lambda_k \leq 0$ such that $\Phi'(u^k)h = \lambda_k \Theta'(u^k)h$ for any $h \in W_{\mathcal{D}}^{1,2}$, where $\Theta(u) = \|u - u^0\|_{1,2}^2$. The arguments in [5, Section 2.6] guarantee that $u^k \in C^2$ and u^k satisfy the Euler equations $(F_p^k(x))' = F_u^k(x)$, where $F_p^k(x) := F_p(\lambda_k, x, u^k(x), (u^k)'(x))$ (similarly F_u^k) and $F(\lambda, x, u, p) := f(x, u, p) - \lambda(|p - (u^0)'(x)|^2 + |u - u^0(x)|^2)$. These equations, the particular form of f, u^0 , the positive definiteness of F_{pp}^k and the convergence $u^k \rightarrow u^0$ in $W^{1,2}$ guarantee that $\{u^k\}$ is a Cauchy sequence in $W^{2,1}$, hence in C^1 , thus $u^k \rightarrow u^0$ in C^1 . However, this contradicts our assumption that u^0 is a weak minimizer. Consequently, u^0 is a local minimizer in $u^0 + W_{\mathcal{D}}^{1,2}$. Next assume that there exist $v^k \in C_{\mathcal{D}}^1$ such that $\|v^k\|_C \rightarrow 0$ and $\Phi(u^0 + v^k) < \Phi(u^0)$. Then it is not difficult to show that there exists $c > 0$ such that $0 > \Phi(u^0 + v^k) - \Phi(u^0) \geq c\|v^k\|_{1,2}^2 + o(1)$, hence $\|v^k\|_{1,2} \rightarrow 0$, which yields a contradiction and concludes the proof. \square

Proof of Proposition 11. Notice that u^0 is a critical point of Φ for any choice of $I_0^N, I_1^N \subset \{1, 2\}$. By Proposition 5, we have to determine the positivity of functional Ψ in $W_{\mathcal{D}}^{1,2}$. We have $\Psi(h) = \Psi_1(h_1, h_2) + \Psi_2(h_3)$, where

$$\Psi_1(h_1, h_2) = A \int_0^1 ((h_1')^2 + (h_2')^2 - 2\alpha h_2' h_1 + \beta(h_1^2 + h_2^2)) dx, \quad \Psi_2(h_3) = C \int_0^1 (h_3')^2 dx.$$

Since the positivity of Ψ does not change if we replace α by $-\alpha$ (consider $-h_1$ instead of h_1), we may assume $\alpha \geq 0$. Since the case $\alpha = 0$ is trivial, we assume $\alpha > 0$. Since Ψ_2 is positive definite in $W_0^{1,2}([0, 1])$, it is sufficient to study the positivity of the functional

$$\tilde{\Psi}(h_1, h_2) := \frac{1}{2A} \Psi_1(h_1, h_2) = \frac{1}{2} \int_0^1 ((h_1')^2 + (h_2')^2 - 2\alpha h_2' h_1 + \beta(h_1^2 + h_2^2)) dx \quad (29)$$

in the space

$$\tilde{W}_{\mathcal{D}} := \{h \in W^{1,2}([0, 1], \mathbb{R}^2) : h_i(j) = 0 \text{ for } i \in I_j^{\mathcal{D}}, i = 1, 2, j = 0, 1\}. \quad (30)$$

In fact, Ψ is positive definite (or semidefinite, resp.) in $W_{\mathcal{D}}^{1,2}$ if and only if $\tilde{\Psi}$ is positive definite (or semidefinite, resp.) in $\tilde{W}_{\mathcal{D}}$. Therefore, in what follows, we will apply the Jacobi theory from Section 3 to the functional $\tilde{\Psi}$ with $\alpha > 0$. Notice that the assumptions in Theorem 8 depend only on the corresponding functional Ψ , and the conclusions can also be formulated in terms of Ψ , see (19), (20). We will use Theorem 8 in this way. More precisely, we will use assertions (19), (20) (with Ψ and $W_{\mathcal{D}}^{1,2}$ replaced by $\tilde{\Psi}$ and $\tilde{W}_{\mathcal{D}}$, respectively) to determine the positivity of $\tilde{\Psi}$ (hence the positivity of Ψ) and then we will use Proposition 5 (with $\Psi(h) = \Psi(h_1, h_2, h_3)$) to conclude that u^0 is (or is not) a minimizer of Φ .

Notice that the index sets for functional $\tilde{\Psi}$ satisfy $\tilde{I}_j^{\mathcal{D}} = I_j^{\mathcal{D}} \cap \{1, 2\}$ and $\tilde{I}_j^{\mathcal{N}} = I_j^{\mathcal{N}} \cap \{1, 2\} = I_j^{\mathcal{N}}$ for $j = 1, 2$, hence we will use the notation $I_j^{\mathcal{N}}$ instead of $\tilde{I}_j^{\mathcal{N}}$. Similarly, the corresponding operators $\tilde{\mathcal{B}}_i$, $i = 1, 2$ (cf. (10)), satisfy $\tilde{\mathcal{B}}_i(h_1, h_2) = \mathcal{B}_i(h_1, h_2, 0)$ for $i = 1, 2$, and — without fearing confusion — we will use the notation $\mathcal{B}_i h$ instead of $\tilde{\mathcal{B}}_i h$ and $\mathcal{B}h := (\mathcal{B}_1 h, \mathcal{B}_2 h)$ if $h = (h_1, h_2)$ and $i = 1, 2$. The same applies to operators \mathcal{C}_i and \mathcal{A}_i . Since

$$\mathcal{B}_1 h = h'_1, \quad \mathcal{B}_2 h = -\alpha h_1 + h'_2, \quad \mathcal{C}_1 h = \beta h_1 - \alpha h'_2, \quad \mathcal{C}_2 h = \beta h_2, \quad (31)$$

the corresponding system of Jacobi equations is

$$\left. \begin{aligned} h''_1 + \alpha h'_2 - \beta h_1 &= 0, \\ h''_2 - \alpha h'_1 - \beta h_2 &= 0, \end{aligned} \right\} \quad \text{in } (0, 1), \quad (32)$$

and the initial conditions for $h^{(1)}, h^{(2)}$ in Theorem 8 (with $N = 2$) are $h_i(0) = 0$ if $i \in \tilde{I}_0^{\mathcal{D}}$ and $i = 1, 2$, $h'_1(0) = 0$ if $1 \in I_0^{\mathcal{N}}$, and $h'_2(0) = \alpha h_1(0)$ if $2 \in I_0^{\mathcal{N}}$.

The existence of continuous borderline functions g follows from the form of $\tilde{\Psi}$. Notice that if the index sets $\tilde{I}_0^{\mathcal{D}}$ and $\tilde{I}_1^{\mathcal{D}}$ are nonempty, then $h_1 h_2(0) = h_1 h_2(1) = 0$ for any $h \in \tilde{W}_{\mathcal{D}}$, hence

$$\int_0^1 h'_2 h_1 dx = - \int_0^1 h'_1 h_2 dx. \quad (33)$$

Identity (33) shows that the value of $\tilde{\Psi}$ does not change if we replace h_1 with h_2 and α with $-\alpha$. In general, the value of $\tilde{\Psi}$ does not change if we replace h_i with $\tilde{h}_i(x) = h_i(1-x)$ and α with $-\alpha$. These two observations guarantee (26) and (28).

Let us first consider the cases in Proposition 11(i), i.e. $\tilde{I}_0^{\mathcal{D}} \neq \emptyset \neq \tilde{I}_1^{\mathcal{D}}$. Then (33) guarantees $\int_0^1 2h'_2 h_1 dx = \int_0^1 (h'_2 h_1 - h'_1 h_2) dx$ and the Cauchy inequality implies that

$$\tilde{\Psi} \text{ is positive definite if } \alpha^2 < 4\beta. \quad (34)$$

Hence it is sufficient to study the case $\alpha^2 \geq 4\beta$.

Case $\binom{\mathcal{D}\mathcal{D}}{\mathcal{D}\mathcal{D}}$ has already been solved in [11, Proposition 3], but Theorem 8 enables us to show $g_{\mathcal{D}}(\alpha) = \frac{\alpha^2}{4} - \pi^2$ in a simpler way. Assume $\alpha^2 > 4\beta$. We can set $h^{(1)}(x) = (\sin \xi_1 x - \sin \xi_2 x, \cos \xi_1 x - \cos \xi_2 x)$ and $h^{(2)}(x) = (-\cos \xi_1 x + \cos \xi_2 x, \sin \xi_1 x - \sin \xi_2 x)$, where $\xi_{1,2} = -\frac{1}{2}\alpha \pm \gamma$. The function D in Theorem 8 satisfies $D(x) = 2 - 2\cos(\xi_1 - \xi_2)x$, hence $D \neq 0$ in $(0, 1]$ if and only if $|\xi_1 - \xi_2| < 2\pi$, i.e. if $\beta > g_{\mathcal{D}}(\alpha)$. Consequently, if $\beta > g_{\mathcal{D}}(\alpha)$, then u^0 is a strict weak minimizer (this remains true also if $4\beta = \alpha^2$ due to the monotonicity of $\tilde{\Psi}$ with respect to β), and if $\beta < g_{\mathcal{D}}(\alpha)$, then u^0 is not a weak minimizer.

The remaining cases in Proposition 11(i) are $\binom{\mathcal{D}\mathcal{D}}{\mathcal{N}\mathcal{D}}$, $\binom{\mathcal{D}\mathcal{N}}{\mathcal{N}\mathcal{D}}$, and $\binom{\mathcal{D}\mathcal{D}}{\mathcal{N}\mathcal{N}}$. Assume $\alpha^2 > 4\beta$. Since $I_0^{\mathcal{N}} = \{2\}$, the initial conditions for $h^{(1)}, h^{(2)}$ in Theorem 8 are $h_1(0) = 0$ and $h'_2(0) = 0$. One can easily check that we can set $h^{(i)}(x) := (\sin \xi_i x, \cos \xi_i x)$, $i = 1, 2$, where $\xi_{1,2} := -\frac{1}{2}\alpha \pm \gamma$. The function D in Theorem 8 satisfies

$$D(x) = \sin(\xi_1 - \xi_2)x = \sin 2\gamma x = \sin \sqrt{\alpha^2 - 4\beta} x,$$

hence

$$\text{if } \alpha^2 - 4\beta > \pi^2, \text{ then } D(x) = 0 \text{ for some } x \in (0, 1), \quad (35)$$

$$\text{if } 0 < \alpha^2 - 4\beta < \pi^2, \text{ then } D(x) \neq 0 \text{ in } (0, 1]. \quad (36)$$

Theorem 8(i) (more precisely, assertion (19)) and (35) imply that

$$\tilde{\Psi} \text{ is not positive semidefinite if } \alpha^2 - 4\beta > \pi^2. \quad (37)$$

Let $I_1^{\mathcal{N}} = \emptyset$. If $0 < \alpha^2 - 4\beta < \pi^2$, then (36) and Theorem 8(ii) (more precisely, assertion (20)) guarantee that $\tilde{\Psi}$ is positive definite. If $0 = \alpha^2 - 4\beta < \pi^2$ and we replace β by $\tilde{\beta} := \beta - \varepsilon$ with $\varepsilon > 0$ small, then $0 < \alpha^2 - 4\tilde{\beta} < \pi^2$, hence the modified functional $\tilde{\Psi}^{\tilde{\beta}}$ (with β replaced by $\tilde{\beta}$) is positive definite, and the monotonicity of $\tilde{\Psi}$ with respect to β implies that $\tilde{\Psi}$ is positive definite as well. These facts together with (34) and (37) imply $g_{\mathcal{N}\mathcal{D}}^{\mathcal{D}\mathcal{D}}(\alpha) = \frac{\alpha^2}{4} - \frac{\pi^2}{4}$.

If $I_1^{\mathcal{N}} = \{2\}$ and $\alpha^2 > 4\beta$, then $H_{\mathcal{D},b} = \{\tilde{h} \in \text{span}(h^{(1)}, h^{(2)}) : \tilde{h}_1(1) = 0\}$ is spanned by $h := \sin \xi_2 h^{(1)} - \sin \xi_1 h^{(2)}$. We have

$$B := \mathcal{B}h(1) \cdot h(1) = h_2'(1)h_2(1) = (\xi_2 - \xi_1) \sin(\xi_2 - \xi_1) \sin \xi_1 \sin \xi_2$$

and, assuming $\alpha \in [(2k-1)\pi, (2k+1)\pi]$, $k = 0, 1, 2, \dots$, $\alpha > 0$, we have $B > 0$ or $B < 0$ if and only if β is greater or less than $k\pi(\alpha - k\pi)$, respectively. Notice that

$$\alpha^2/4 \geq k\pi(\alpha - k\pi) \geq (\alpha^2 - \pi^2)/4. \quad (38)$$

These facts, Theorem 8(ii) and (34) imply that $\tilde{\Psi}$ is positive definite if $\beta > k\pi(\alpha - k\pi)$, $\beta \neq \alpha^2/4$. The assumption $\beta \neq \alpha^2/4$ can be removed by the same argument as above (by considering $\tilde{\beta} = \beta - \varepsilon$). If $\beta < k\pi(\alpha - k\pi)$, then $\alpha^2 > 4\beta$ due to (38), hence $B < 0$ and Theorem 8(i) imply that $\tilde{\Psi}$ is not positive semidefinite. Consequently, the formula for $g_M = g_{\mathcal{N}\mathcal{N}}^{\mathcal{D}\mathcal{D}}$ in (27) is true.

If $I_1^{\mathcal{N}} = \{1\}$, then we can use the same arguments as in the case $I_1^{\mathcal{N}} = \{2\}$ to show that the formula for $g_{\mathcal{N}\mathcal{D}}^{\mathcal{D}\mathcal{N}}$ in (27) is true. In particular, if $\alpha^2 > 4\beta$, then $H_{\mathcal{D},b} = \{\tilde{h} \in \text{span}(h^{(1)}, h^{(2)}) : \tilde{h}_2(1) = 0\}$ is spanned by $h := \cos \xi_2 h^{(1)} - \cos \xi_1 h^{(2)}$ and we have

$$B := \mathcal{B}h(1) \cdot h(1) = h_1'(1)h_1(1) = (\xi_1 - \xi_2) \sin(\xi_1 - \xi_2) \cos \xi_1 \cos \xi_2,$$

hence assuming $\alpha \in [2k\pi, 2(k+1)\pi]$, $k = 0, 1, 2, \dots$, we obtain $B > 0$ or $B < 0$ if and only if β is greater or less than $(k + \frac{1}{2})\pi(\alpha - (k + \frac{1}{2})\pi)$, respectively.

Next consider the cases in Proposition 11(ii), i.e. $\binom{\mathcal{N}\mathcal{D}}{\mathcal{N}\mathcal{D}}$, $\binom{\mathcal{N}\mathcal{N}}{\mathcal{N}\mathcal{D}}$, $\binom{\mathcal{N}\mathcal{D}}{\mathcal{N}\mathcal{N}}$ and $\binom{\mathcal{N}\mathcal{N}}{\mathcal{N}\mathcal{N}}$. Since $I_0^{\mathcal{N}} = \{1, 2\}$, the initial conditions for $h^{(1)}, h^{(2)}$ in Theorem 8 are $h_1'(0) = 0$ and $h_2'(0) = \alpha h_1(0)$. We will distinguish the following four subcases:

- (ii-1) $\beta = \frac{1}{2}\alpha^2$,
- (ii-2) $\beta = \frac{1}{4}\alpha^2$,
- (ii-3) $\beta > \frac{1}{4}\alpha^2$ and $\beta \neq \frac{1}{2}\alpha^2$,
- (ii-4) $\beta < \frac{1}{4}\alpha^2$.

(ii-1) Assume that $\beta = \frac{1}{2}\alpha^2$. We will show that $\tilde{\Psi}$ is positive definite (hence u^0 is a strict weak minimizer) in case $\binom{\mathcal{N}\mathcal{D}}{\mathcal{N}\mathcal{D}}$ and $\tilde{\Psi}$ is not positive semidefinite (hence u^0 is not a weak minimizer) in case $\binom{\mathcal{N}\mathcal{N}}{\mathcal{N}\mathcal{N}}$ if $\alpha \neq 2k\pi$. In addition, in case $\binom{\mathcal{N}\mathcal{N}}{\mathcal{N}\mathcal{D}}$, u^0 is or is not a weak minimizer if $\alpha \in ((2k-1)\pi, 2k\pi)$ or $\alpha \in (2k\pi, (2k+1)\pi)$, respectively, and the opposite is true in case $\binom{\mathcal{N}\mathcal{D}}{\mathcal{N}\mathcal{N}}$.

Recall that $\delta = \alpha/2$. If we set

$$\begin{aligned} h^{(1)}(x) &:= (e^{\delta x}(\cos(\delta x) - \sin(\delta x)), e^{\delta x}(\cos(\delta x) + \sin(\delta x))), \\ h^{(2)}(x) &:= (e^{-\delta x}(\cos(\delta x) + \sin(\delta x)), e^{-\delta x}(-\cos(\delta x) + \sin(\delta x))), \end{aligned}$$

then we obtain $D \equiv -2$, hence $\tilde{\Psi}$ is positive definite in case $\binom{\mathcal{N}\mathcal{D}}{\mathcal{N}\mathcal{N}}$ due to Theorem 8(ii).

Considering case $\binom{\mathcal{N}\mathcal{N}}{\mathcal{N}\mathcal{N}}$, one can check that the matrix $\mathfrak{A} = (a_{kl})$ in Remark 10(ii) satisfies

$$a_{11} = 4\delta e^{2\delta} \sin^2 \delta, \quad a_{22} = -4\delta e^{-2\delta} \sin^2 \delta, \quad a_{12} = a_{21} = -4\delta \sin \delta \cos \delta.$$

If $\delta \neq k\pi$, then choosing $\xi := (0, 1)$ and $h := \sum_{k=1}^2 \xi_k h^{(k)} = h^{(2)} \in H_{\mathcal{D},1} = H$ we obtain $\mathcal{B}h(1) \cdot h(1) = \mathfrak{A}\xi \cdot \xi = a_{22} < 0$, i.e. $\tilde{\Psi}$ is not positive semidefinite due to Theorem 8(i). Notice also that $\mathcal{B}h(0) = 0$, hence

$$\tilde{\Psi}(h) = \mathcal{B}h \cdot h \Big|_0^1 < 0. \quad (39)$$

If $\delta = k\pi$, then $\mathfrak{A} = 0$ (degenerate case). Already these facts contradict [11, Proposition 5] which claims the stability for $\beta > \frac{1}{4}\alpha^2$. In fact, the authors of [11] mention in their proof that ‘‘We have not used any integration by parts ...’’, but they seem to use [11, (35)–(37)], and [11, (35)] does use an integration by parts requiring the boundary conditions $h_1 h_2(0) = h_1 h_2(1)$.

In case $\binom{\mathcal{N}\mathcal{D}}{\mathcal{N}\mathcal{N}}$ we set

$$h := e^{-\delta}(\cos \delta + \sin \delta)h^{(1)} - e^{\delta}(\cos \delta - \sin \delta)h^{(2)}.$$

Since at least one of the numbers $h_1^{(1)}(1)$ and $h_1^{(2)}(1)$ is non-zero, we have $\dim H_{\mathcal{D},1} \leq 1$. Since $h_1(1) = 0$, we obtain $H_{\mathcal{D},1} = \text{span}(h)$, and

$$\mathcal{B}h(1) \cdot h(1) = \mathcal{B}_2 h(1) \cdot h_2(1) = (-\alpha h_1 + h'_2)(1) \cdot h_2(1) = 2\alpha \sin \alpha$$

due to $h_2(1) = 2$ and $h'_2(1) = \alpha \sin \alpha$. Consequently, $\mathcal{B}h(1) \cdot h(1) > 0$ if $\alpha \in (2k\pi, (2k+1)\pi)$ and $\mathcal{B}h(1) \cdot h(1) < 0$ if $\alpha \in ((2k-1)\pi, 2k\pi)$, so that our assertion follows from Theorem 8(ii) and Theorem 8(i), respectively.

Similarly, in case $\binom{\mathcal{N}\mathcal{N}}{\mathcal{N}\mathcal{D}}$ we set

$$h := e^{-\delta}(\cos \delta - \sin \delta)h^{(1)} + e^{\delta}(\cos \delta + \sin \delta)h^{(2)}.$$

Then $h_2(1) = 0$ and $H_{\mathcal{D},1} = \text{span}(h)$;

$$\mathcal{B}h(1) \cdot h(1) = \mathcal{B}_1 h(1) \cdot h(1) = h'_1(1)h_1(1) = -2\alpha \sin \alpha \quad (40)$$

due to $h_1(1) = 2$ and $h'_1(1) = -\alpha \sin \alpha$. The rest of the proof is the same as in case $\binom{\mathcal{N}\mathcal{D}}{\mathcal{N}\mathcal{N}}$. Notice also that (similarly as in the case of (39)), (40) implies

$$\tilde{\Psi}(h) = \mathcal{B}h \cdot h \Big|_0^1 < 0 \quad (41)$$

provided $\alpha \in (2k\pi, (2k+1)\pi)$.

(ii-2) Assume that $\beta = \frac{1}{4}\alpha^2$. Set $\xi := -\frac{1}{2}\alpha$ and

$$\begin{aligned} h^{(1)}(x) &:= (\sin(\xi x) - \xi x \cos(\xi x), \cos(\xi x) + \xi x \sin(\xi x)), \\ h^{(2)}(x) &:= (\cos(\xi x) - \xi x \sin(\xi x), -\sin(\xi x) - \xi x \cos(\xi x)). \end{aligned}$$

Notice that the function D in Theorem 8 satisfies $D(x) = \xi^2 x^2 - 1$, hence $D < 0$ in $[0, 1]$ if $\alpha < 2$, and $D(x) = 0$ for some $x \in (0, 1)$ if $\alpha > 2$. This shows that $\frac{1}{4}\alpha^2 < g_{\mathcal{N}\mathcal{D}}^{\mathcal{N}\mathcal{D}}(\alpha) \leq \min(g_{\mathcal{N}\mathcal{D}}^{\mathcal{N}\mathcal{N}}(\alpha), g_{\mathcal{N}\mathcal{N}}^{\mathcal{N}\mathcal{D}}(\alpha), g_{\mathcal{N}}(\alpha))$ if $\alpha > 2$, i.e. u^0 cannot be a weak minimizer in any case.

Let $\alpha < 2$. Then u^0 is a strict weak minimizer in case $\binom{\mathcal{N}\mathcal{D}}{\mathcal{N}\mathcal{D}}$. Next consider case $\binom{\mathcal{N}\mathcal{N}}{\mathcal{N}\mathcal{N}}$. If $\beta = \alpha^2/2$, then (39) implies that $\tilde{\Psi}$ is not positive semidefinite. The monotonicity of $\tilde{\Psi}$ with respect to β shows that $\tilde{\Psi}$ cannot be positive semidefinite if $\beta = \alpha^2/4$ either, hence u_0 is not a weak minimizer. The same arguments show that u_0 is not a weak minimizer in case $\binom{\mathcal{N}\mathcal{N}}{\mathcal{N}\mathcal{D}}$, see (41). It remains to consider case $\binom{\mathcal{N}\mathcal{D}}{\mathcal{N}\mathcal{N}}$. Set

$$h := (\cos \xi - \xi \sin \xi)h^{(1)} - (\sin \xi - \xi \cos \xi)h^{(2)},$$

so that $h_1(1) = 0$. Then the restriction $\alpha < 2$ implies $h_2(1) = 1 - \xi^2 > 0$. Since $h_2'(1) = -\xi^2 + \xi \sin(2\xi)$, we see that $h_2'(1)h_2(1) > 0$ only if $\alpha < \alpha_0$, where α_0 is defined by $\alpha_0 = 2 \sin \alpha_0$ ($\alpha_0 \approx 0.6\pi$).

(ii-3) Assume $\beta > \frac{1}{4}\alpha^2$, $\beta \neq \frac{1}{2}\alpha^2$, and set

$$\varphi(x) := e^{\gamma x}(\gamma^2 - \delta^2), \quad \psi_{\pm}(x) := e^{-\gamma x}(\gamma \pm \delta)^2.$$

Then we can take

$$\begin{aligned} h^{(1)}(x) &:= [(\varphi(x) + \psi_+(x))(\cos(\delta x) + \sin(\delta x)), (\varphi(x) + \psi_+(x))(-\cos(\delta x) + \sin(\delta x))], \\ h^{(2)}(x) &:= [(\varphi(x) + \psi_-(x))(\cos(\delta x) - \sin(\delta x)), (\varphi(x) + \psi_-(x))(\cos(\delta x) + \sin(\delta x))], \end{aligned}$$

and an easy computation yields

$$D(x) = 4(\gamma^2 - \delta^2) \left((\gamma^2 - \delta^2) \cosh(2\gamma x) + \gamma^2 + \delta^2 \right). \quad (42)$$

The function D does not vanish in $(0, 1]$ if and only if $\gamma > \delta$ (i.e. $\beta > \frac{1}{2}\alpha^2$), or $\gamma < \delta$ and $\cosh(2\gamma) < \frac{\gamma^2 + \delta^2}{\delta^2 - \gamma^2}$. The last inequality can be written in the form

$$(\alpha^2 - 2\beta) \cosh(2\gamma) < 2\beta. \quad (43)$$

In case $\binom{\mathcal{N}\mathcal{N}}{\mathcal{N}\mathcal{N}}$, one has to consider the numbers a_{kl} in Remark 10(ii):

$$\begin{aligned} a_{11} &= 2\gamma(\varphi^2 - \psi_+^2)(1) + 2\delta(\varphi + \psi_+)^2(1) \cos(2\delta), \\ a_{22} &= 2\gamma(\varphi^2 - \psi_-^2)(1) - 2\delta(\varphi + \psi_-)^2(1) \cos(2\delta), \\ a_{12} &= a_{21} = -2\delta(\varphi + \psi_+)(\varphi + \psi_-)(1) \sin(2\delta). \end{aligned}$$

If $\gamma > \delta$ (i.e. $\beta > \frac{1}{2}\alpha^2$), then

$$a_{11}(\gamma + \delta)^{-2} + a_{22}(\gamma - \delta)^{-2} = 8(\gamma^2 + \delta^2)(\gamma - \theta\delta \cos(2\delta)) \sinh(2\gamma) > 0,$$

hence the matrix \mathfrak{A} is positive definite if and only if $a_{11}a_{22} > a_{12}^2$, which is equivalent to

$$(1 - \theta^2) \cosh(2\gamma) + \theta^2 \cos(2\delta) > 1. \quad (44)$$

We used the assumption $\beta > \frac{1}{2}\alpha^2$ in order to derive (44), but this is not restrictive, since we know that u^0 can only be a weak minimizer of our problem in case $\binom{\mathcal{N}\mathcal{N}}{\mathcal{N}\mathcal{N}}$ when $\beta > \frac{1}{2}\alpha^2$. Hence in this case the condition (44) determines the domain of stability.

In cases $\binom{\mathcal{N}\mathcal{N}}{\mathcal{N}\mathcal{D}}$ and $\binom{\mathcal{N}\mathcal{D}}{\mathcal{N}\mathcal{N}}$, we set

$$h := (\varphi(1) + \psi_-(1))(\cos \delta + \sin \delta)h^{(1)} + (\varphi(1) + \psi_+(1))(\cos \delta - \sin \delta)h^{(2)}$$

and

$$h := (\varphi(1) + \psi_-(1))(\cos \delta - \sin \delta)h^{(1)} - (\varphi(1) + \psi_+(1))(\cos \delta + \sin \delta)h^{(2)},$$

respectively. Then $h_2(1) = 0$, $h_1(1) = D(1)$,

$$\mathcal{B}h(1) \cdot h(1) = h'_1 h_1(1) = 4\gamma(\gamma^2 - \delta^2)D(1)((\gamma^2 - \delta^2) \sinh(2\gamma) - 2\gamma\delta \sin(2\delta)),$$

and $h_1(1) = 0$, $h_2(1) = -D(1)$,

$$\mathcal{B}h(1) \cdot h(1) = h'_2 h_2(1) = 4\gamma(\gamma^2 - \delta^2)D(1)((\gamma^2 - \delta^2) \sinh(2\gamma) + 2\gamma\delta \sin(2\delta)),$$

respectively, where D is as in (42). Consequently, assuming that D does not vanish in $[0, 1]$ (i.e. (43) is true), the stability conditions are

$$(\gamma^2 - \delta^2) \sinh(2\gamma) - 2\gamma\delta \sin(2\delta) > 0 \quad (45)$$

and

$$(\gamma^2 - \delta^2) \sinh(2\gamma) + 2\gamma\delta \sin(2\delta) > 0, \quad (46)$$

respectively. Notice that if $\beta = \frac{1}{2}\alpha^2$ (hence $\gamma = \delta$), then (45) and (46) are equivalent to the corresponding stability conditions in case (ii-1).

(ii-4) If $\beta < \frac{1}{4}\alpha^2$, then we can set

$$\begin{aligned} h^{(1)}(x) &:= (\xi_2 \sin(\xi_1 x) - \xi_1 \sin(\xi_2 x), \xi_2 \cos(\xi_1 x) - \xi_1 \cos(\xi_2 x)), \\ h^{(2)}(x) &:= (\xi_1 \cos(\xi_1 x) - \xi_2 \cos(\xi_2 x), -\xi_1 \sin(\xi_1 x) + \xi_2 \sin(\xi_2 x)), \end{aligned}$$

where $\xi_{1,2} = -\frac{1}{2}\alpha \pm \gamma$, and we obtain

$$D(x) = -2\beta + (\alpha^2 - 2\beta) \cos(2\gamma x). \quad (47)$$

If $\alpha^2 - 4\beta \geq \pi^2$, then D changes sign in $[0, 1]$. Hence the condition $D > 0$ in $[0, 1]$ is equivalent to

$$\alpha^2 - 4\beta < \pi^2 \quad \text{and} \quad (\alpha^2 - 2\beta) \cos(2\gamma) > 2\beta. \quad (48)$$

It is not difficult to check (cf. case (ii-2)) that if $\alpha < 2$ or $\alpha > 2$, then (48) or (43), respectively, is the (essentially optimal) sufficient condition for the stability in our problem in case $(\frac{\mathcal{N}\mathcal{D}}{\mathcal{N}\mathcal{D}})$. If $\alpha = 2$, then that sufficient condition is $\beta > 1$.

Case (ii-2) shows that it remains to consider only case $(\frac{\mathcal{N}\mathcal{D}}{\mathcal{N}\mathcal{N}})$ and $\alpha < \alpha_0$. Take

$$h := (\xi_1 \cos \xi_1 - \xi_2 \cos \xi_2)h^{(1)} - (\xi_2 \sin \xi_1 - \xi_1 \sin \xi_2)h^{(2)}.$$

Then $h_1(1) = 0$, $h_2(1) = -D(1)$ (where D is as in (47)), and

$$h'_2(1) = (\xi_1^2 \sin \xi_2 \cos \xi_1 - \xi_2^2 \sin \xi_1 \cos \xi_2)(\xi_2 - \xi_1).$$

Assuming $D > 0$ in $[0, 1]$ (i.e. (48)), the condition $h'_2 h_2(1) > 0$ is equivalent to

$$\xi_1^2 \sin \xi_2 \cos \xi_1 > \xi_2^2 \sin \xi_1 \cos \xi_2. \quad (49)$$

Since $\xi_1 = 0$ if $\beta = 0$, (49) can only be true if $\beta > 0$. It is not difficult to see that $g_{\mathcal{N}\mathcal{N}}^{\mathcal{N}\mathcal{D}}(\alpha) = 0$ for $\alpha \leq \frac{1}{2}\pi$ and $g_{\mathcal{N}\mathcal{N}}^{\mathcal{N}\mathcal{D}}(\alpha_0) = \frac{1}{4}\alpha_0^2$. If $\alpha > \alpha_0$, then (46) determines $g_{\mathcal{N}\mathcal{N}}^{\mathcal{N}\mathcal{D}}(\alpha)$.

The formulas for functions g in Proposition 11(ii) follow from the stability conditions (43),(44),(45),(46),(48),(49). \square

Remark 13. Consider case $(\frac{\mathcal{D}\mathcal{D}}{\mathcal{N}\mathcal{N}})$. We have $g_{\mathcal{N}\mathcal{N}}^{\mathcal{D}\mathcal{D}}(\alpha) = g_M(\alpha) > g_{\mathcal{N}\mathcal{D}}^{\mathcal{D}\mathcal{D}}(\alpha)$ except for $\alpha = \alpha_k := (2k - 1)\pi$, $k = 1, 2, \dots$. If $\alpha = \alpha_k$ and $\beta = g_M(\alpha) = g_{\mathcal{N}\mathcal{D}}^{\mathcal{D}\mathcal{D}}(\alpha)$, then the function D in Theorem 8 satisfies $D \neq 0$ in $(0, 1)$, $D(1) = 0$, hence condition (16) cannot be satisfied (otherwise (19) would imply $\tilde{\Psi}(\bar{h}) < 0$ for some $\bar{h} \in \tilde{W}_{\mathcal{D}}$, so that $\tilde{\Psi}(\bar{h}) < 0$ also if β is slightly greater than $g_M(\alpha)$, which is a contradiction). For example, if $k = 2$ (i.e. $\alpha = 3\pi$, $\beta = 2\pi^2$), then our proof shows that H_0 is spanned by $h(x) := (-\sin(\pi x) - \sin(2\pi x), \cos(\pi x) + \cos(2\pi x))$ and $\mathcal{B}_2 h(1) = h_2(1) = h_1(1) = 0$ which violates (16). This degeneracy seems to be also responsible for the non-smooth behavior of g_M at $\alpha = \alpha_k$. \square

5. FIELD OF EXTREMALS

In this section we modify the Weierstrass theory to provide necessary and sufficient conditions for weak, strong and global minimizers. Recall that $B_\varepsilon := \{\xi \in \mathbb{R}^N : |\xi| < \varepsilon\}$.

Definition 14. Let $f \in C^2$, $\tilde{\varepsilon} > 0$, and let $u^0 \in C^2$ be an extremal. The image \mathcal{P} of a C^1 -diffeomorphism $P : [a, b] \times B_{\tilde{\varepsilon}} \rightarrow [a, b] \times \mathbb{R}^N : (x, \alpha) \mapsto (x, \varphi(x, \alpha))$ is called a *field of extremals for u^0* if $\varphi_x \in C^1$, $\varphi(\cdot, \alpha)$ is an extremal for each α , and $\varphi(\cdot, 0) = u^0$. The *slope* of the field of extremals \mathcal{P} is defined as $\psi : \mathcal{P} \rightarrow \mathbb{R}^N : (x, v) \mapsto \varphi_x(x, \alpha(x, v))$, where $\alpha(x, v)$ is defined by $\varphi(x, \alpha(x, v)) = v$.

It is known that in the case of the Dirichlet boundary conditions, the existence of a field of extremals $\varphi(x, \alpha)$ satisfying the self-adjointness condition (50), and the nonnegativity of the excess function

$$E(x, u, p, q) := f(x, u, q) - f(x, u, p) - (q - p) \cdot f_p(x, u, p)$$

for suitable (x, u, p, q) imply that u^0 is a strong minimizer. In addition, the existence of the field is guaranteed by the sufficient condition for the weak minimizer in Theorem 8(ii). In the general case we have the following analogue (see Theorem 18 for a simpler version in the scalar case $N = 1$):

Theorem 15. *Let $f \in C^2$, $\varepsilon > 0$, and let $u^0 \in C^2$ be an extremal satisfying (4).*

(i) *Let there exist a field of extremals \mathcal{P} for u^0 satisfying the conditions*

$$\frac{\partial f_{p_i}(a, v, \psi(a, v))}{\partial v_j} = \frac{\partial f_{p_j}(a, v, \psi(a, v))}{\partial v_i} \quad \text{whenever } i, j \in I, v - u^0(a) \in B_\varepsilon, \quad (50)$$

$$f_p(a, v, \psi(a, v)) \cdot (v - u^0(a)) \leq 0, \quad \text{whenever } v - u^0(a) \in \mathbb{R}_{\mathcal{D}, a}^N \cap B_\varepsilon, \quad (51)$$

$$f_p(b, v, \psi(b, v)) \cdot (v - u^0(b)) \geq 0, \quad \text{whenever } v - u^0(b) \in \mathbb{R}_{\mathcal{D}, b}^N \cap B_\varepsilon, \quad (52)$$

where ψ denotes the slope of the field. Assume also

$$E(x, v, \psi(x, v), q) \geq 0 \quad \text{for all } ((x, v), q) \in \mathcal{P} \times \mathbb{R}^N. \quad (53)$$

Then u^0 is a strong minimizer.

If (53) is only true for all $(x, v) \in \mathcal{P}$ and $q = q(x, v)$ satisfying $|q - \psi(x, v)| \leq \eta$ for some $\eta > 0$, then u^0 is a weak minimizer.

If the field is global (i.e. $\mathcal{P} = [a, b] \times \mathbb{R}^N$) and (50), (51), (52) are true with B_ε replaced by \mathbb{R}^N , then u^0 is a global minimizer.

(ii) Assume $I_a^{\mathcal{D}} = \emptyset$ and let there exist a field of extremals satisfying (50). If the reversed inequality " \geq " is true in (51), and the reversed strict inequality " $<$ " is true in (52) for $v = u^0(b) + tw^0$, where $t \in (0, 1)$ and $w^0 \in \mathbb{R}_{\mathcal{D}, b}^N$ is fixed, then u_0 is not a weak minimizer.

(iii) Assume (6) and let the sufficient conditions for a weak minimizer in Theorem 8(ii) be satisfied. If $I_a^{\mathcal{D}} = \emptyset$ or $I_a^{\mathcal{N}} = \emptyset$ or

$$\left. \begin{aligned} f_{p_i}(a, u, p) \text{ for } i \in I_a^{\mathcal{D}} \text{ does not depend on } u_j, p_j \text{ with } j \notin I_a^{\mathcal{D}}, \\ f_{p_i u_j} = f_{p_j u_i} \text{ for } i, j \in I_a^{\mathcal{D}}, \end{aligned} \right\} \quad (54)$$

then a field of extremals satisfying (50),(51),(52) exists.

Remark 16. The well known Weierstrass necessary condition for minimizers asserts that the inequality $E(x, u^0(x), (u^0)'(x), q) \geq 0$ for all $q \in \mathbb{R}^N$ or $q = q(x)$ satisfying $|q - (u^0)'(x)| \leq \eta$ is necessary for u^0 to be a strong or weak minimizer, respectively, hence the nonnegativity conditions on E in Theorem 15 are not far from optimal. Similarly, Theorem 15(ii) shows that the sufficient conditions (51)–(52) in Theorem 15(i) are also necessary in some sense, at least if $I_a^{\mathcal{D}} = \emptyset$. \square

The proof of part (iii) of Theorem 15 is quite technical and, in addition, we will not need that part in our examples (since we will prove the existence of the field required by Theorem 15(i)–(ii) by other arguments). Therefore the proof of part (iii) is postponed to the Appendix.

In what follows we assume that

$$\begin{aligned} f \in C^2, u^0 \in C^2 \text{ is an extremal,} \\ \mathcal{P} \text{ is a field of extremals for } u^0 \text{ with slope } \psi, \text{ and (50) is true.} \end{aligned} \quad (55)$$

Given $v \in C^1([a, b], \mathbb{R}^N)$ such that $\text{graph}(v) := \{(x, v(x)) : x \in [a, b]\} \subset \mathcal{P}$, we define the Hilbert invariant integral

$$I(v) := \int_a^b [f(x, v(x), \psi(x, v(x))) + (v'(x) - \psi(x, v(x))) \cdot f_p(x, v(x), \psi(x, v(x)))] dx.$$

The following proposition is well known, but for the reader's convenience we provide its proof in the Appendix.

Proposition 17. Assume (55). Then there exists $S \in C^2(\mathcal{P})$ such that

$$\begin{aligned} I(v) = S(b, v(b)) - S(a, v(a)) \quad \text{for any } v \in C^1([a, b], \mathbb{R}^N) \text{ with } \text{graph}(v) \subset \mathcal{P}, \\ S_v(x, v) = f_p(x, v, \psi(x, v)) \quad \text{for any } (x, v) \in \mathcal{P}. \end{aligned} \quad (56)$$

Proof of Theorem 15. (i) Let $u - u^0 \in C_D^1$, $\text{graph}(u) \subset \mathcal{P}$, and let S be the function from Proposition 17. If u is close to u^0 in the sup-norm, then the assumptions (51)–(52) guarantee

$$S(a, u(a)) - S(a, u^0(a)) = \int_0^1 S_v(a, u^0(a) + t(u(a) - u^0(a))) \cdot (u(a) - u^0(a)) dt \leq 0,$$

and similarly $S(b, u(b)) - S(b, u^0(b)) \geq 0$, hence $I(u^0) \leq I(u)$ due to Proposition 17. This fact and assumption (53) imply

$$\Phi(u) - \Phi(u^0) = \Phi(u) - I(u^0) \geq \Phi(u) - I(u) = \int_a^b E(x, u(x), \psi(x, u(x)), u'(x)) dx \geq 0,$$

hence u^0 is a strong minimizer. The remaining assertions in (i) are obvious.

(ii) Choose $t_k \rightarrow 0+$ and let α_k be such that $\varphi(b, \alpha_k) = u^0(b) + t_k w^0$. Then $u^k := \varphi(\cdot, \alpha_k) \rightarrow u^0$ in C^1 , $u^k - u^0 \in C^1_{\mathcal{D}}$ due to $I_a^{\mathcal{D}} = \emptyset$ and $w^0 \in \mathbb{R}^N_{\mathcal{D}, b}$, and, similarly as in (i), we obtain

$$\Phi(u^k) = I(u^k) = S(b, u^k(b)) - S(a, u^k(a)) < S(b, u^0(b)) - S(a, u^0(a)) = I(u^0) = \Phi(u^0),$$

hence u^0 is not a minimizer. \square

6. SCALAR EXAMPLES WITH VARIABLE ENDPOINTS

Throughout this section (except for Remark 21) we assume $N = 1$ and $I_a^{\mathcal{D}} = I_b^{\mathcal{D}} = \emptyset$. Since we will often use Theorem 15, let us first reformulate it in this special case. Notice that the extremals in the field of extremals satisfy $\varphi_\alpha(x, \alpha) \neq 0$, hence we can assume $\varphi_\alpha > 0$ without loss of generality.

Theorem 18. *Let $N = 1$, $I_a^{\mathcal{D}} = I_b^{\mathcal{D}} = \emptyset$, $f \in C^2$ and let $u^0 \in C^2$ be an extremal satisfying (4).*

(i) *Let there exist a field of extremals $\mathcal{P} = \{(x, \varphi(x, \alpha)) : x \in [a, b], \alpha \in (-\varepsilon, \varepsilon)\}$ for u^0 satisfying the conditions $\varphi_\alpha > 0$ and*

$$f_p^\alpha(a)\alpha \leq 0 \leq f_p^\alpha(b)\alpha, \quad \alpha \in (-\varepsilon, \varepsilon), \quad (57)$$

where $f_p^\alpha(x) := f_p(x, \varphi(x, \alpha), \varphi_x(x, \alpha))$. Assume also

$$E(x, v, \psi(x, v), q) \geq 0 \quad \text{for all } ((x, v), q) \in \mathcal{P} \times \mathbb{R}. \quad (58)$$

Then u^0 is a strong minimizer.

If (58) is only true for all $(x, v) \in \mathcal{P}$ and $q = q(x, v)$ satisfying $|q - \psi(x, v)| \leq \eta$ for some $\eta > 0$, then u^0 is a weak minimizer.

If $\mathcal{P} = [a, b] \times \mathbb{R}$, then u^0 is a global minimizer.

(ii) *Let there exist a field of extremals satisfying $\varphi_\alpha > 0$. If, for $\alpha > 0$ or $\alpha < 0$, the reversed inequalities in (57) are true and one of them is strict (for example, if $f_p^\alpha(a) \geq 0 > f_p^\alpha(b)$ for $\alpha > 0$), then u_0 is not a weak minimizer.*

(iii) *Assume (6) and let the sufficient conditions for a weak minimizer in Theorem 7(ii) be satisfied. Then a field of extremals satisfying $\varphi_\alpha > 0$ and (57) exists.*

Remark 19. If $f_{up}^0 = 0$ and we set $P := f_{pp}^0$, $Q := f_{uu}^0$, then $\Psi(h) = \int_a^b (P(h')^2 + Qh^2) dx$ and the Jacobi equation has the form $-\frac{d}{dx}(Ph') + Qh = 0$. Notice also that if $P, Q > 0$, then Ψ is positive definite in $W^{1,2}$. Consequently, Remark 10(iii) implies that the sufficient conditions for a weak minimizer in Theorem 7(ii) are satisfied and Theorem 18(iii) implies the existence of a field of extremals satisfying $\varphi_\alpha > 0$ and (57). \square

In the following examples we will consider Lagrangians $f = f(u, p)$ and we will use the phase plane analysis for the Du Bois-Reymond equation $f^0 - (u^0)' f_p^0 = C$.

Example 20. The study of the deformation of a planar weightless inextensible and un-shearable rod (satisfying suitable boundary conditions) leads to the minimization of the functional

$$\Phi(u) = \int_0^1 \left(\frac{1}{2}(u' - K)^2 + M \cos u \right) dx, \quad u \in C^1([0, 1]), \quad (59)$$

where $K \in \mathbb{R}$, $M > 0$, and u denotes the angle between the tangent to the rod and a suitable vertical, see [10, (97)] and cf. also [1]. Functional Φ possesses multiple critical

points, i.e. extremals satisfying the natural boundary conditions $u'(0) = u'(1) = K$; see [10] for their detailed analysis. Their stability was also analyzed in [10], but that analysis based on the approach from [12] is unnecessarily complicated. Somewhat simpler arguments were used in [1], but those arguments cannot be used for all critical points. We will show that Theorems 7 and 18 yield a very simple way to determine the stability of any critical point.

Proposition 3 implies that u^0 is a weak minimizer of Φ if and only if it is a strong minimizer. Therefore we will only speak about minimizers. Notice also that $f_{pp} = 1$ and the excess function satisfies $E(x, u, p, q) = \frac{1}{2}(q-p)^2 \geq 0$. Proposition 4 guarantees that any critical point of Φ is C^∞ and satisfies the Du Bois-Reymond equation $(u')^2 = 2M \cos u + C$, where C is a constant. Conversely, any non-constant solution of the Du Bois-Reymond equation is an extremal.

We consider the phase plane (u, v) , where $v = u'$, and set

$$\phi_C := \{(u, v) : v^2 = 2M \cos u + C\}, \quad C \in (-2M, \infty)$$

(see Figure 3). The considerations above show that given any non-constant critical point u^0 , there exists $C^0 > -2M$ such that $(u^0(x), (u^0)'(x)) \in \phi_{C^0}$ for $x \in [0, 1]$, $(u^0)'(0) = (u^0)'(1) = K$. On the other hand, if $(A_0, K), (A_1, K) \in \Phi_{C^0}$ for some $C^0 \in (2M, \infty)$, $A_0 \neq A_1$, and $u^0 \in C^1$ satisfies $(u^0(x), (u^0)'(x)) \in \phi_{C^0}$ for $x \in [0, 1]$, $(u^0(0), (u^0)'(0)) = (A_0, K)$ and $(u^0(b), (u^0)'(b)) = (A_1, K)$ for some $b > 0$, then u^0 is a critical point if and only if $b = 1$ (the value of b is uniquely determined in this case since $(u^0)' \neq 0$). Similar assertion is true if $C^0 \in (-2M, 2M]$ ($K \neq 0$ if $C^0 = 2M$), but this time one can have $(u^0(b), (u^0)'(b)) = (A_1, K)$ for multiple values of b (since u^0 need not be monotone), and one has to allow $A_1 = A_0$.

The phase plane analysis can be used to find critical points of Φ (see [2] for a particular case), but since those critical points are known (see [10], for example), we will restrict ourselves to the determination of their stability. More precisely, considering the case $K \geq 0$ (the case $K \leq 0$ being symmetric), we will show the following: A critical point of Φ is a minimizer if and only if either $u^0(x) \equiv (2k+1)\pi$ for some integer k or u^0 is a part of curve ϕ_{C^0} with $C^0 > 2M$ and $(u^0)''(0) < 0 < (u^0)''(1)$.

Let us first consider a critical point u^0 being a part of curve ϕ_{C^0} with $C^0 > 2M$, and let (A_i, K) be as above. For symmetry reasons we may assume $K > 0$. Notice that $u'' = -M \sin u$, $|(u^0)''(0)| = |(u^0)''(1)|$, and that $u^0(x)$ can also be defined (as an extremal, hence a part of ϕ_{C^0}) for $x \notin [0, 1]$.

If $(u^0)''(0) < 0 < (u^0)''(1)$ (i.e. $u^0(0) \in (2k\pi, (2k+1)\pi)$ and $u^0(1) \in ((2m+1)\pi, (2m+2)\pi)$ for some $m \geq k$; see the extremal u^0 with $(u^0)'(0) = K_1$ in Figure 3), then $\varphi(x, \alpha) := u^0(x + \alpha)$, $x \in [0, 1]$, $\alpha \in (-\varepsilon, \varepsilon)$, is a field of extremals for u^0 satisfying (57), hence Theorem 18(i) guarantees that u^0 is a minimizer. If $(u^0)''(0) > 0 > (u^0)''(1)$, then the same argument and Theorem 18(ii) show that u^0 is not a minimizer.

Next assume that $(u^0)''(0) \cdot (u^0)''(1) \geq 0$. We will show that u^0 is not a minimizer.

Assume $(u^0)''(0) < 0$, or $(u^0)''(0) = 0$ and $(u^0)'''(0) < 0$ (the cases $(u^0)''(0) > 0$, or $(u^0)''(0) = 0$ and $(u^0)'''(0) > 0$ are analogous). We necessarily have $A_1 = A_0 + 2k_0\pi$ for some $k_0 \in \{1, 2, \dots\}$. Let $\varphi(\cdot, \alpha)$ (with $|\alpha|$ being small) be the extremal with initial values $Z_0 := (\varphi(0, \alpha), \varphi_x(0, \alpha)) = (A_0 + \alpha, K)$ (see the extremal u^0 with $(u^0)'(0) = K_2$ in Figure 3). Then φ is a field of extremals for u^0 , and $\varphi(\cdot, \alpha)$ is a part of the curve ϕ_{C^α} , where C^α is close to C^0 , $C^\alpha > C^0$ if $\alpha > 0$.

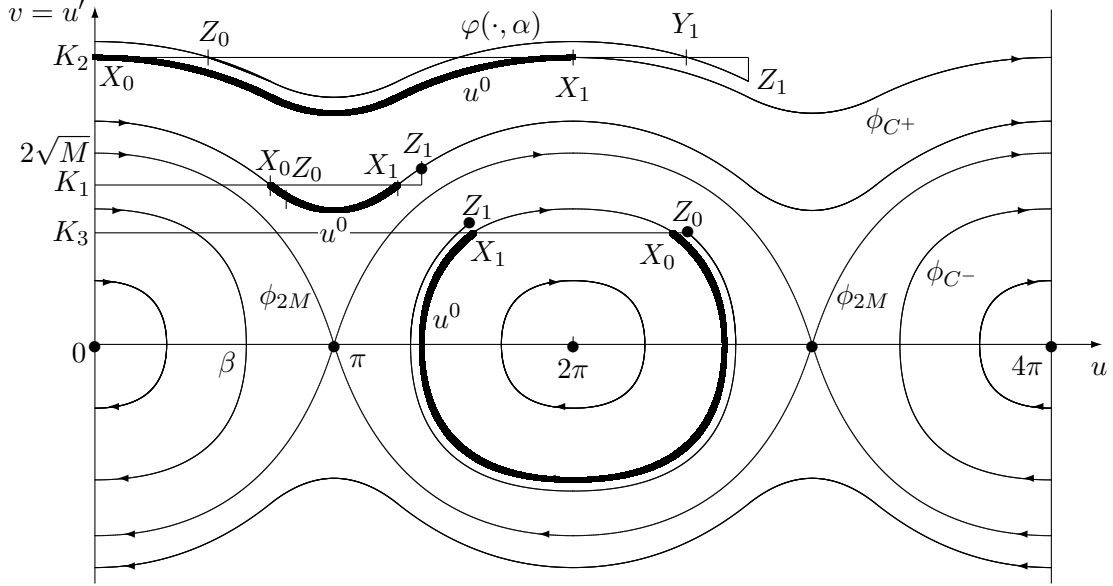

FIGURE 3. Phase plane and extremals for Example 20 and $0 \leq u \leq 4\pi$;
 $C^- < 2M < C^+$, $Z_i = (\varphi(i, \alpha), \varphi_x(i, \alpha))$, $i = 0, 1$, $Y_1 = (A_1 + \alpha, K)$,
 $X_i = (A_i, K) = (u^0(i), (u^0)'(i))$, $i = 0, 1$.

Let $\alpha > 0$ be small. If u^1 and u^2 are extremals in ϕ_{C^0} and ϕ_{C^α} , respectively, and $u^1(0) = u^2(0) = 0$, then $u^1(b_1) = u^2(b_2) = 2\pi$ for some $0 < b_1 < b_2$ (due to $(u^2)' > (u^1)'$ whenever $u^2 = u^1$). This fact and the 2π -periodicity of the problem guarantee that $\varphi(b, \alpha) = A_1 + \alpha$ for some $b < 1$, hence $\varphi_x(1, \alpha) < (u^0)'(1)$, and Theorem 18(ii) implies that u^0 is not a minimizer.

Next consider the case $C^0 \in (-2M, 2M]$ and $K \geq 0$; $K \neq 0$ if $C^0 = 2M$. If $K > 0$ and $(u^0)''(0) > 0 > (u^0)''(1)$, then the same arguments as above guarantee that u^0 is not a minimizer. If $K = 0$ or $(u^0)''(0) < 0 < (u^0)''(1)$ (hence $A_1 < A_0$) or $(u^0)''(0) \cdot (u^0)''(1) \geq 0$ (hence $A_0 = A_1 = 2k\pi$), then choosing $\varphi(\cdot, \alpha)$ to be an extremal satisfying initial conditions $(\varphi(0, \alpha), \varphi_x(0, \alpha)) = (A_0 + \alpha, K)$ we see from the phase plane that $\varphi(\cdot, \alpha)$ and u^0 intersect in $(0, 1)$ for any $\alpha \neq 0$ small (if, for example, $(u^0)''(0) < 0 < (u^0)''(1)$ and $\alpha > 0$ is small, then there exists $y \in (0, 1)$ such that $\varphi(y, \alpha) = \min \varphi(\cdot, \alpha) < \min u^0$, and the inequalities $\varphi(0, \alpha) > u^0(0)$, $\varphi(y, \alpha) < u^0(y)$ imply that $\varphi(\cdot, \alpha)$ and u^0 intersect in $(0, y)$; see the extremal u^0 with $(u^0)'(0) = K_3$ in Figure 3). Consequently, $h := \varphi_x(\cdot, 0)$ is a solution of the Jacobi equation satisfying $h(0) = 1$, $h'(0) = 0$, $h(y) = 0$ for some $y \in (0, 1]$, and Theorem 7 guarantees that u^0 is not a minimizer.

Similar considerations as above can be used in the case of constant extremals $k\pi$, but we will use a different argument: If $u^0 \equiv (2k+1)\pi$, then $P = 1$, $Q = -M \cos u^0 = M$, and the solution $h(x) = e^{\sqrt{M}x} + e^{-\sqrt{M}x}$ of the Jacobi equation satisfies $h > 0$, $h'(0) = 0$, $h'(1) > 0$, hence u^0 is a minimizer. If $u^0 \equiv 2k\pi$, then $P = 1$, $Q = -M$ and the solution $h(x) = \cos(\sqrt{M}x)$ of the Jacobi equation satisfies $h(0) > 0$, $h'(0) = 0$ and either $h(x) = 0$ for some $x \in (0, 1]$ or $h'(1) < 0$, hence u^0 is not a minimizer. \square

Remark 21. The author of [9] considers the functional Φ in (59) with $K = 0$, $[a, b] = [-1/2, 1/2]$ (instead of $[a, b] = [0, 1]$), and the Dirichlet boundary conditions $u(-1/2) = u(1/2) = 0$, see [9, (6)]. He considers the extremal u^0 satisfying $u^0(0) = \beta$ and $(u^0)'(0) = 0$, i.e. the extremal passing through the point $(\beta, 0)$ in Figure 3, and he provides explicit formulas for this extremal, its field of extremals φ and the derivative φ_α (see [9, (8),(9),(13),(14) and (16)]; functions u^0, φ and φ_α are denoted by θ, y and $\partial y / \partial \gamma$, respectively). The nonnegativity of the excess function then implies that u^0 is a strong minimizer. In [9, Introduction], the author claims that “Based on the Jacobian test, potential energy of Euler elasticas ... was proved to hold a weak minimum value...”, but “...it is an open problem to find sufficient conditions for the potential energy for these Euler elasticas to hold a strong minimum.” However, Proposition 3 shows that weak and strong minimizers of functional Φ in (59) are equivalent. In addition, Theorem 15(iii) implies that the positive definiteness of the second variation ψ in $W_0^{1,2}(-1/2, 1/2)$ (i.e. the sufficient condition for a weak minimizer) guarantees the existence of the required field φ , hence the technical construction of the field in [9] is not necessary even if we do not consider Proposition 3. \square

Example 22. Consider the functional $\Phi(u) = \int_a^b f(u, u') dx$ in $C^1([a, b])$, where $f(u, p) = g(p) + u^2$ and g is a double-well function. More precisely, we will consider the following two cases (see Figure 4):

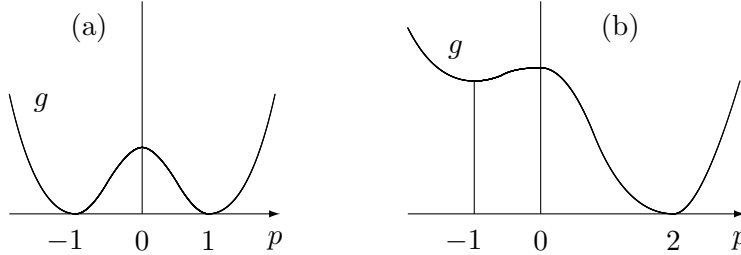

FIGURE 4. Graphs of g in the symmetric and non-symmetric cases.

- (a) $g(p) = (p^2 - 1)^2$ (hence $g'(p) = 4p(p^2 - 1)$, $g''(p) = 4(3p^2 - 1)$),
 (b) $g(p) = \frac{1}{4}p^4 - \frac{1}{3}p^3 - p^2 + \frac{8}{3}$ (hence $g'(p) = (p + 1)p(p - 2)$, $g''(p) = 3p^2 - 2p - 2$).

Let us consider the symmetric case (a) first. The Du Bois-Reymond equation has the form

$$u^2 = C + h(u'), \quad \text{where } h(p) := 3p^4 - 2p^2,$$

see Figures 5 and 6 for the graph of h and the phase plane (u, u') , respectively. All minimizers have to satisfy $u'(a), u'(b) \in \{0, \pm 1\}$; the only constant extremal is $u \equiv 0$. Functional Φ does not possess local maximizers since $\Phi''(u^0)(1, 1) > 0$ for any u^0 .

Since $f_{pp}(u, p) = 4(3p^2 - 1)$, the extremals in the region $|u'| \leq 1/\sqrt{3}$ (satisfying $(u^0)'(a) = (u^0)'(b) = 0$) cannot be local minimizers. The extremal u^* with $(u^*)'(a) = 1$ and $\min(u^*)' = 1/\sqrt{3}$ (see Figure 6) satisfies $u^*(b^*) = 1$ for some $b^* > a$. If $b \in (a, b^*)$, then there exists a unique extremal u^0 satisfying $(u^0)'(a) = (u^0)'(b) = 1$ (and a unique extremal u^1 satisfying $(u^1)'(a) = (u^1)'(b) = -1$); in addition $(u^0)' > 1/\sqrt{3}$ (and $(u^1)' < -1/\sqrt{3}$). Since $P, Q > 0$ and the excess function $E = (q - p)^2((q + p)^2 + 2(p^2 - 1))$ considered as a function of q changes sign if $|p| < 1$, Remarks 19 and 16 show that the extremals u^0, u^1

FIGURE 5. Graph of h in the symmetric case.

FIGURE 6. Phase plane in the symmetric case.

are weak but not strong minimizers. (Remark 19 also guarantees the existence of a field of extremals, but this fact is not needed here: The Weierstrass necessary condition for strong minimizers in Remark 16 does not require the existence of a field of extremals.) Notice also that $\inf \Phi = 0$ is not attained (neither in C^1 , nor in $W^{1,4}$): A minimizing sequence in C^1 can be obtained by suitable smooth approximation of piecewise C^1 -functions u_ε satisfying $|u'_\varepsilon| = 1$ a.e. and $|u_\varepsilon| \leq \varepsilon$.

Next consider the nonsymmetric case (b). The Du Bois-Reymond equation has the form

$$u^2 = C + h(u'), \quad \text{where} \quad h(p) := \frac{3}{4}p^4 - \frac{2}{3}p^3 - p^2,$$

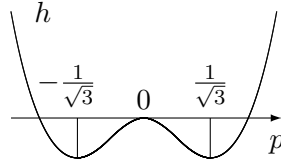
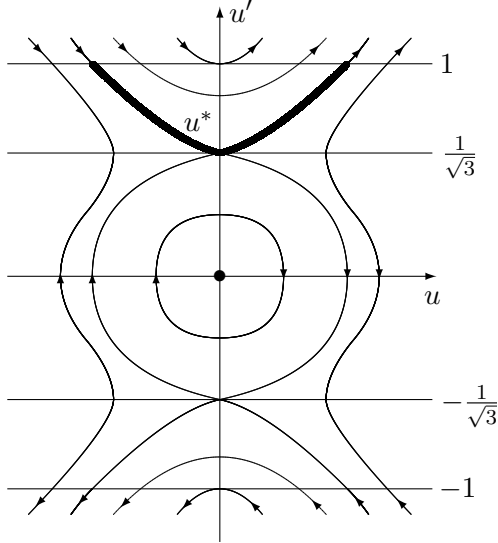
see Figures 7 and 8 for the graph of h and the phase plane (u, u') , respectively. All minimizers have to satisfy $u'(a), u'(b) \in \{0, -1, 2\}$; the only constant extremal is $u \equiv 0$.

Since $f_{pp}(u, p) = 3p^2 - 2p - 2$, similarly as in case (a) we see that the extremals in the region $u' \in [\frac{1-\sqrt{7}}{3}, \frac{1+\sqrt{7}}{3}]$ are neither local minimizers nor local maximizers. The extremal u^* with $(u^*)'(a) = 2$ and $\min(u^*)' = \frac{1+\sqrt{7}}{3}$ (see Figure 8) satisfies $u^*(b^*) = 2$ for some $b^* > a$. If $b \in (a, b^*)$, then there exists a unique extremal u^0 satisfying $(u^0)'(a) = (u^0)'(b) = 2$ and, as above, this extremal is a weak local minimizer. However, now $E = \frac{1}{12}(q-p)^2((\sqrt{3}(q+p) - \frac{2}{\sqrt{3}})^2 + 6p^2 - 4p - 13\frac{1}{3}) \geq 0$ for all q if $p \leq p_1$ or $p \geq p_2$, where if $p_1 = \frac{1}{3}(1 - \sqrt{21}) < -1$, $p_2 = \frac{1}{3}(1 + \sqrt{21}) \in (\frac{1}{3}(1 + \sqrt{7}), 2)$, and Remark 19

FIGURE 7. Graph of h in the non-symmetric case.

FIGURE 8. Phase plane in the non-symmetric case.

guarantees the existence of a field of extremals satisfying $\varphi_\alpha > 0$ and (57), hence u^0 is a strong local minimizer provided $\min(u^0)' > p_2$ (and it is not if $\min(u^0)' < p_2$). In fact, if $\min(u^0)' > p_2$, then Proposition 23 below shows the existence of a global field of extremals for u^0 satisfying the assumptions of Theorem 18(i), with slope $\psi > p_2$, hence u^0 is a global minimizer.

An analogous analysis as in the case $u' > \frac{1+\sqrt{7}}{3}$ shows that the extremals in the region $u' < \frac{1-\sqrt{7}}{3}$ are weak but not strong local minimizers. \square

Proposition 23. *Let Φ and p_2 be as in Example 22(b), and let u^0 be a critical point of Φ satisfying $\min(u^0)' > p_2$. Then there exists a global field of extremals for u^0 satisfying the assumptions of Theorem 18(i), with slope $\psi > p_2$.*

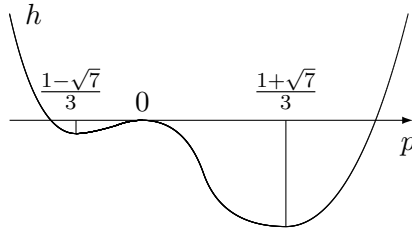
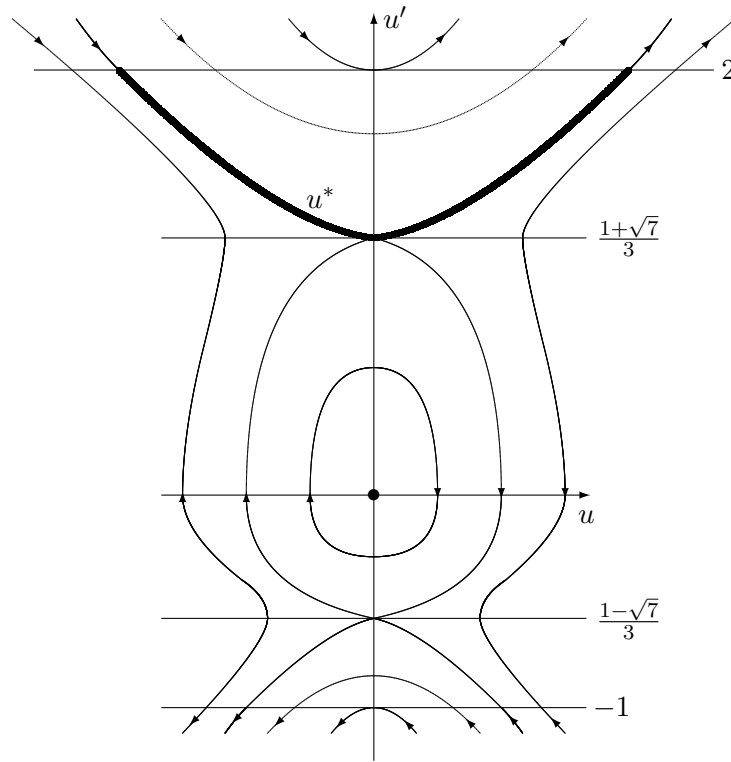
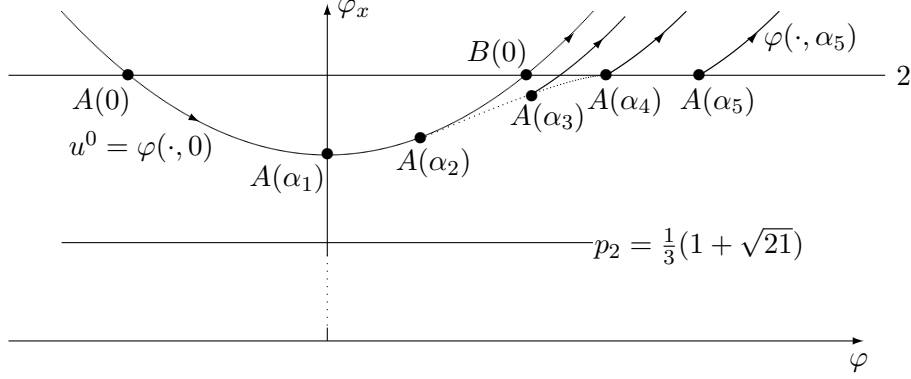

FIGURE 9. Global field of extremals: $A(\alpha) = (\varphi(a, \alpha), \varphi_x(a, \alpha))$, $B(\alpha) = (\varphi(b, \alpha), \varphi_x(b, \alpha))$, $(b-a)/2 = \alpha_1 < b-a-\varepsilon = \alpha_2 < \alpha_3 < \alpha_4 = b-a+\varepsilon < \alpha_5$.

Proof. Assume first $\alpha \geq 0$. Then we choose the extremals $u^\alpha := \varphi(\cdot, \alpha)$ in the global field such that $\varphi(\cdot, \alpha)$ is the solution of the Du Bois-Reymond equation satisfying

$$(\varphi(a, \alpha), \varphi_x(a, \alpha)) = A(\alpha),$$

where $A(\alpha) = (A_1(\alpha), A_2(\alpha)) : (0, \infty) \rightarrow \mathbb{R}^2$ is smooth,

$$A(\alpha) = \begin{cases} (u^0(a + \alpha), (u^0)'(a + \alpha)) & \text{if } \alpha \leq b - a - \varepsilon, \\ (u^0(b) + \alpha - (b - a), 2) & \text{if } \alpha \geq b - a + \varepsilon, \end{cases} \quad (60)$$

$A'_1(\alpha) \geq 1$, $A'_2(\alpha) > 0$ for $\alpha \in (b - a - \varepsilon, b - a + \varepsilon)$, where $\varepsilon \in (0, (b - a)/2)$, (61) see Figure 9. Notice that $A'_1(b - a - \varepsilon) = (u^0)'(b - \varepsilon) > p_2 > 1$, $A'_2(b - a - \varepsilon) = (u^0)''(b - \varepsilon) > 0$, $A'_1(b - a + \varepsilon) = 1$, $A'_2(b - a + \varepsilon) = 0$, $A_1(b - a + \varepsilon) - A_1(b - a - \varepsilon) > 2\varepsilon$ (since $A_1(b - a + \varepsilon) = u^0(b) + \varepsilon$, $A_1(b - a - \varepsilon) = u^0(b - \varepsilon)$, $u^0(b) - u^0(b - \varepsilon) = (u^0)'(b - \theta\varepsilon)\varepsilon > p_2\varepsilon$), $A_2(b - a + \varepsilon) > A_2(b - a - \varepsilon)$, so that (61) can be satisfied.

Let us show that $\varphi_\alpha > 0$. Since $\varphi(x, \alpha) = u^0(x + \alpha)$ for $\alpha \leq b - a - \varepsilon$ and $(u^0)' > 0$, we may assume $\alpha > b - a - \varepsilon$, hence $\varphi > 0$. Set $w(x, \alpha) = \varphi_\alpha(x, \alpha)$. Then (60)–(61) imply $w(a, \alpha) \geq 1$. Let h^{-1} denote the inverse of the increasing function $h|_{(p_2, \infty)}$. Since $\varphi(\cdot, \alpha)$ solves the Du Bois-Reymond equation, there exists $C(\alpha)$ such that $\varphi(x, \alpha)^2 = C(\alpha) + h(\varphi_x(x, \alpha))$. Consequently,

$$w_x = \frac{\partial}{\partial x}(\varphi_\alpha) = \frac{\partial}{\partial \alpha}(\varphi_x) = \frac{\partial}{\partial \alpha}(h^{-1}(\varphi^2 - C(\alpha))) = \underbrace{(h^{-1})'(\varphi^2 - C(\alpha))}_{>0} [2\varphi w - C'(\alpha)]. \quad (62)$$

If $w_x(a, \alpha) > 0$ (which is true for $\alpha < b - a + \varepsilon$ due to (60)–(61)), then $\varphi_x > 0$ and (62) guarantee $w_x(x, \alpha) > 0$ for $x > a$, hence $w(x, \alpha) \geq w(a, \alpha) \geq 1$. If $w_x(a, \alpha) = 0$ (which is true for $\alpha \geq b - a + \varepsilon$ due to (60)), then $(2\varphi w)(a, \alpha) = C'(\alpha)$ and

$$\frac{d}{dx}(2\varphi w - C'(\alpha))(a, \alpha) = 2\varphi_x w + 2\varphi w_x = 2\varphi_x w > 2p_2 > 0$$

hence $w_x(x, \alpha) > 0$ for $x > a$ close to a , and (62) implies $w_x(x, \alpha) > 0$ for all $x > a$. As before, this implies $w(x, \alpha) \geq 1$.

If $\alpha < 0$, then the choice of $\varphi(\cdot, \alpha)$ is symmetric: The extremal $\varphi(\cdot, \alpha)$ solves the Du Bois-Reymond equation in $[a, b]$ and $(\varphi(b, \alpha), \varphi_x(b, \alpha)) = B(\alpha) := (-A_1(-\alpha), A_2(-\alpha))$.

As an alternative to the technical construction of the global field above, we could also set $(\varphi(a, \alpha), \varphi_x(a, \alpha)) = A(\alpha)$, where

$$A(\alpha) = \begin{cases} (u^0(a + \alpha), (u^0)'(a + \alpha)) & \text{if } 0 \leq \alpha \leq b - a, \\ (u^0(b) + \alpha - (b - a), 2) & \text{if } \alpha > b - a, \end{cases}$$

and analogously for $\alpha < 0$. Then the field $\varphi(\cdot, \alpha)$ is not sufficiently smooth if $|\alpha| = b - a$, but a simple generalization of Theorem 18 shows that this does not matter. In fact, denote $v^\pm := \varphi(\cdot, \pm(b - a))$. Let $u \in C^1([a, b])$; we want to show $\Phi(u) \geq \Phi(u^0)$. Approximating u suitably, we may assume that the set $\{x \in [a, b] : u(x) = v^+(x) \text{ or } u(x) = v^-(x)\}$ is finite. Set $\tilde{u} := \max(v^-, \min(v^+, u))$ and approximate \tilde{u} by a sequence of C^1 -functions u^k such that $\text{graph}(u^k) \subset \mathcal{P}_1 := \{(x, \varphi(x, \alpha)) : x \in [a, b], |\alpha| \leq b - a\}$ and $u^k \rightarrow \tilde{u}$ in $W^{1,4}$. Then Theorem 18 shows that $\Phi(u^k) \geq \Phi(u^0)$, hence $\Phi(\tilde{u}) \geq \Phi(u^0)$ due to the continuity of Φ in $W^{1,4}$. Let $[x_1, x_2]$ be any maximal interval where $\tilde{u} = v^+$ (i.e. $u \geq v^+$) or $\tilde{u} = v^-$. Notice that either $x_1 = a$ or $u(x_1) = v^\pm(x_1)$, and either $x_2 = b$ or $u(x_2) = v^\pm(x_2)$. Denote $\Phi_{x_1}^{x_2}(u) = \int_{x_1}^{x_2} f(x, u(x), u'(x)) dx$. Then the proof of Theorem 18 shows $\Phi_{x_1}^{x_2}(u) \geq \Phi_{x_1}^{x_2}(v^+)$ (if $u \geq v^+$ in $[x_1, x_2]$) or $\Phi_{x_1}^{x_2}(u) \geq \Phi_{x_1}^{x_2}(v^-)$, hence $\Phi(u) \geq \Phi(\tilde{u}) \geq \Phi(u^0)$. \square

7. APPENDIX

Proof of Proposition 1. We will consider only the special case $N = 1$, $I_a^{\mathcal{D}} = \emptyset$, $I_b^{\mathcal{N}} = \emptyset$, but the arguments in our proof can also be used in the general case.

If $h \in C_{\mathcal{D}}^1 = \{\varphi \in C^1([a, b]) : \varphi(b) = 0\}$, then integration by parts yields

$$\begin{aligned} 0 &= \Phi'(u^0)h = \int_a^b (f_p^0(x)h'(x) + f_u^0(x)h(x)) dx \\ &= gh \Big|_a^b + \int_a^b (f_p^0(x) - g(x))h'(x) dx, \end{aligned} \tag{63}$$

where $g(x) := \int_a^x f_u^0(\xi) d\xi$ is C^1 . Considering test functions h with compact support in (a, b) , the Du Bois-Reymond Lemma and (63) yield the existence of a constant C such that $f_p^0(x) = g(x) + C$, hence $f_p^0 \in C^1$ and the Euler equation $\frac{d}{dx}(f_p^0) = f_u^0$ is satisfied. This equation and the choice of h with $h(a) = 1$ in (63) imply

$$\begin{aligned} 0 &= \Phi'(u^0)h = \int_a^b (f_p^0(x)h'(x) + f_u^0(x)h(x)) dx \\ &= f_p^0 h \Big|_a^b + \int_a^b \left(-\frac{d}{dx}(f_p^0(x)) + f_u^0(x) \right) h(x) dx = -f_p^0(a), \end{aligned}$$

which concludes the proof of the first part. If $f_p \in C^1$ and $f_{pp}^0 \geq c^0 > 0$, then the function $F(x, p) := f_p(x, u^0(x), p) - g(x) - C$ is C^1 , $F(x, (u^0)'(x)) = 0$, $F_p(x, (u^0)'(x)) > 0$, hence the Implicit Function Theorem implies $u^0 \in C^2$. \square

Proof of Proposition 3. The proof is based on an idea due to [4].

Let $u^0 \in C^1$ be a weak minimizer of Φ in $u^0 + C_{\mathcal{D}}^1$. Assume first that there exist $v^k \in W_{\mathcal{D}}^{1,2}$, $k = 1, 2, \dots$, such that $r_k := \|v^k\|_{1,2} \rightarrow 0$ and $\Phi(u^0 + v^k) < \Phi(u^0)$. Since Φ is weakly lower semicontinuous in $W^{1,2}$, there exists a minimizer u^k of Φ in the set

$\{u \in u^0 + W_{\mathcal{D}}^{1,2} : \|u - u^0\|_{1,2} \leq r_k\}$, hence $\Phi(u^k) \leq \Phi(u^0 + v^k) < \Phi(u^0)$. Set $\Theta(u) := \|u - u^0\|_{1,2}^2$. Then there exists a Lagrange multiplier λ_k such that $\Phi'(u^k)h = \lambda_k \Theta'(u^k)h$ for any $h \in W_{\mathcal{D}}^{1,2}$ (where the derivatives are considered in $W^{1,2}$). Since $\Phi'(u^k)(u^k - u^0) \leq 0$, we have $\lambda_k \leq 0$. Standard theory implies that $u^0, u^k \in C^2$ solve the Euler equation

$$2(1 - \lambda_k)(u^k)'' = g'(u^k) - 2\lambda_k((u^0)'' + u^k - u^0),$$

which shows that the sequence u^k is bounded in C^2 . Since $u^k \rightarrow u^0$ in $W^{1,2}$, the boundedness in C^2 implies $u^k \rightarrow u^0$ in C^1 which contradicts the fact, that u^0 is a weak minimizer. Consequently, u^0 is a local minimizer in $u^0 + W_{\mathcal{D}}^{1,2}$.

Next assume that there exist $v^k \in C_{\mathcal{D}}^1$ such that $\|v^k\|_C \rightarrow 0$ and $\Phi(u^0 + v_k) < \Phi(u^0)$. Since $\Phi'(u^0)h = \int_a^b (2((u^0)' - K)h' + g'(u^0)h) dx = 0$ for $h \in C_{\mathcal{D}}^1$, we have

$$\begin{aligned} 0 < \Phi(u^0) - \Phi(u^0 + v^k) &= \int_a^b [((u^0)' - K)^2 - ((u^0)' + (v^k)' - K)^2] dx + o(1) \\ &= - \int_a^b (v^k)'[(v^k)' + 2((u^0)' - K)] dx + o(1) \\ &= -\|v^k\|_{1,2}^2 + \int_a^b g'(u^0)v^k dx + o(1) = -\|v^k\|_{1,2}^2 + o(1), \end{aligned}$$

hence $v^k \rightarrow 0$ in $W^{1,2}$, which yields a contradiction. Consequently, u^0 is a strong minimizer. \square

Proof of Proposition 5. Assume that $\Psi(h) \geq c\|h\|_{1,2}^2$ for some $c > 0$ and all $h \in W_{\mathcal{D}}^{1,2}$ and recall that $\Psi(h) = \Phi''(u^0)(h, h)$ if $h \in C^1$. If u^1 is close u^0 in C^1 and Ψ^1 denotes the functional Ψ with u^0 replaced by u^1 , then one can easily check that $\Psi^1(h) = \Phi''(u^1)(h, h) \geq \frac{c}{2}\|h\|_{1,2}^2$ for $h \in C_{\mathcal{D}}^1$, and the Mean Value Theorem implies the existence of $\theta \in (0, 1)$ such that

$$\Phi(u^0 + h) - \Phi(u^0) = \frac{1}{2}\Phi''(u^0 + \theta h)(h, h) \geq \frac{c}{4}\|h\|_{1,2}^2$$

whenever $h \in C_{\mathcal{D}}^1$ is small enough. Consequently, u^0 is a strict weak minimizer in $u^0 + C_{\mathcal{D}}^1$.

If $\Psi(h) < 0$ for some $h \in W_{\mathcal{D}}^{1,2}$, then the density of $C_{\mathcal{D}}^1$ in $W_{\mathcal{D}}^{1,2}$ and the continuity of Ψ in $W_{\mathcal{D}}^{1,2}$ guarantee the existence of $\tilde{h} \in C_{\mathcal{D}}^1$ such that $0 > \Psi(\tilde{h}) = \Phi''(u^0)(\tilde{h}, \tilde{h})$, which shows that u^0 is not a weak minimizer $u^0 + C_{\mathcal{D}}^1$. \square

Proof of Theorem 15(iii). First assume that $I_a^N = \emptyset$. If $I_b^N = \emptyset$, then the assertion is well known (see [7] or [8], for example), hence we may assume $I_b^N \neq \emptyset$. Our assumptions imply $D \neq 0$ in $(a, b]$ and $\mathcal{B}h(b) \cdot h(b) > 0$ for any $h \in H_{\mathcal{D},b} \setminus \{0\}$. We may also assume that f is defined and of class C^3 in an open neighbourhood of $\{(x, u^0(x), (u^0)'(x)) : x \in [a, b]\}$ in $\mathbb{R} \times \mathbb{R}^N \times \mathbb{R}^N$ (see [2] for a detailed proof if $N = 1$). Consequently, there exists $\varepsilon > 0$ small such that u^0 can be extended (as an extremal) for $x \in [a - \varepsilon, a]$, f^0 satisfies (5) in $[a - \varepsilon, b]$, and the solutions $h^{(k)}$, $k = 1, 2, \dots, N$ of the Jacobi equation in $[a - \varepsilon, b]$ with initial conditions $h^{(k)}(a - \varepsilon) = 0$, $(h_i^{(k)})'(a - \varepsilon) = \delta_{ik}$, satisfy $D > 0$ in $(a - \varepsilon, b]$ and $\mathcal{B}h(b) \cdot h(b) > 0$ for any $h \in H_{\mathcal{D},b} \setminus \{0\}$ due to the continuous dependence of solutions of ODEs on initial values. Let $\varphi(\cdot, \alpha)$ be the extremal satisfying the initial conditions $\varphi(a - \varepsilon, \alpha) = u^0(a - \varepsilon)$, $\varphi_x(a, \alpha) = (u^0)'(a - \varepsilon) + \alpha$. The arguments in [7, 8] guarantee that such extremals define a field of extremals for u^0 (in $[a, b]$) satisfying (50). Condition

(51) is empty, hence we only have to show that (52) is true. Thus assume that $v - u^0(b) \in \mathbb{R}_{\mathcal{D},b}^N \cap B_\varepsilon \setminus \{0\}$. We have $v = \varphi(b, \alpha)$ for some α small. Set $h^\alpha := \sum_k \alpha_k h^{(k)}$. If $i \in I_b^{\mathcal{D}}$, then $0 = \varphi_i(b, \alpha) - u_i^0(b) = h_i^\alpha(b) + o(\alpha)$, hence $h^\alpha = h^{\tilde{\alpha}} + o(\alpha)$ for some $h^{\tilde{\alpha}} \in H_{\mathcal{D},b} \setminus \{0\}$ and $\tilde{\alpha} = \alpha + o(\alpha)$. Since our assumptions imply $\mathcal{B}h^{\tilde{\alpha}}(b) \cdot h^{\tilde{\alpha}}(b) = \sum_{i \in I_b^{\mathcal{N}}} \mathcal{B}_i h^{\tilde{\alpha}}(b) h_i^{\tilde{\alpha}}(b) > 0$, we also have

$$\begin{aligned} f_p(b, v, \psi(b, v)) \cdot (v - u^0(b)) &= \sum_{i \in I_b^{\mathcal{N}}} f_{p_i}(b, \varphi(b, \alpha), \varphi_x(b, \alpha)) (\varphi_i(b, \alpha) - u_i^0(b)) \\ &= \sum_{i \in I_b^{\mathcal{N}}} (\mathcal{B}_i h^\alpha(b) + o(\alpha)) (h_i^\alpha(b) + o(\alpha)) \\ &= \sum_{i \in I_b^{\mathcal{N}}} (\mathcal{B}_i h^{\tilde{\alpha}}(b) + o(\tilde{\alpha})) (h_i^{\tilde{\alpha}}(b) + o(\tilde{\alpha})) > 0. \end{aligned}$$

Next assume $I_a^{\mathcal{D}} = \emptyset$. Since our proof in this case uses similar arguments as in the case $I_a^{\mathcal{N}} = \emptyset$ (and a very detailed proof in the case $N = 1$ can be found in [2]), we will be brief. Given $\alpha \in \mathbb{R}^N$ small and $v = v(\alpha) := u^0(a) + \alpha$, the Implicit Function Theorem implies the existence of a unique $w = w(\alpha) \in \mathbb{R}^N$ close to $(u^0)'(a)$ such $f_p(a, v(\alpha), w(\alpha)) = 0$. Let $\varphi(\cdot, \alpha)$ be the extremal satisfying the initial conditions $\varphi(a, \alpha) = v(\alpha)$, $\varphi_x(a, \alpha) = w(\alpha)$. We claim that such extremals $\varphi(\cdot, \alpha)$ define the required field. In fact, the function P in Definition 14 is a C^1 -diffeomorphism and $\varphi_x \in C^1$ due to the differentiability of solutions of ODEs on initial values and the fact that $h^{(k)} := \frac{\partial \varphi}{\partial \alpha_k}(\cdot, 0)$, $k = 1, \dots, N$, are linearly independent solutions of the Jacobi equation $\mathcal{A}h = 0$ satisfying the initial conditions $\mathcal{B}h(a) = 0$, hence $\det(h^{(1)}, \dots, h^{(N)}) \neq 0$ in $[a, b]$ due to our assumptions. Properties (50) and (51) follow from $f_p(a, v, \psi(a, v)) = 0$ and the proof of (52) is the same as in the case $I_a^{\mathcal{N}} = \emptyset$.

Finally assume (54). Let $h^{(1)}, \dots, h^{(N)}$ be solutions of the Jacobi equation $\mathcal{A}h = 0$ in $[a, b]$ satisfying the initial conditions

$$\begin{aligned} h_i^{(k)}(a) &= \eta \delta_{ik} & \text{for } k \in I_a^{\mathcal{D}}, i \in I, & & (h_i^{(k)})'(a) &= \delta_{ik} & \text{for } k \in I, i \in I_a^{\mathcal{D}}, \\ h_i^{(k)}(a) &= \delta_{ik} & \text{for } k \in I_a^{\mathcal{N}}, i \in I, & & \mathcal{B}_i h^{(k)}(a) &= 0 & \text{for } k \in I, i \in I_a^{\mathcal{N}}, \end{aligned}$$

where $\eta \in [0, 1]$. If $\zeta \geq 0$ is small, then

$$\begin{aligned} h_i^{(k)}(a + \zeta) &= (\eta + \zeta) \delta_{ik} + o(\zeta) & \text{if } k, i \in I_a^{\mathcal{D}}, \\ h_i^{(k)}(a + \zeta) &= \delta_{ik} + O(\zeta) & \text{otherwise,} \end{aligned}$$

hence $D(x) := \det(h^{(1)}(x), \dots, h^{(N)}(x)) > 0$ for $x \in [a, a + \zeta]$ and $\eta \in (0, 1]$. If $\eta = 0$, then our assumptions imply $D(x) > 0$ for $x \in [a + \zeta, b]$ and $\mathcal{B}h(b) \cdot h(b) > 0$ for any $h := \sum_k \beta_k h^{(k)}$ satisfying $h_i(b) = 0$ for $i \in I_b^{\mathcal{D}}$ and $h \neq 0$. Those properties remain true for $\eta > 0$ small and we fix such $\eta > 0$. Set $v_i(\alpha) = u_i^0(a) + \eta \alpha_i$ if $i \in I_a^{\mathcal{D}}$, $v_i(\alpha) = u_i^0(a) + \alpha_i$ if $i \in I_a^{\mathcal{N}}$ and $w_i(\alpha) = (u_i^0)'(a) + \alpha_i$ if $i \in I_a^{\mathcal{D}}$. The Implicit Function Theorem guarantees that there exist unique $w_i(\alpha)$ for $i \in I_a^{\mathcal{N}}$ (close to $(u_i^0)'(a)$) such that $f_{p_i}(a, v(\alpha), w(\alpha)) = 0$ for $i \in I_a^{\mathcal{N}}$ and α small. Let $\varphi(\cdot, \alpha)$ be extremals satisfying the initial conditions $\varphi(a, \alpha) = v(\alpha)$, $\varphi_x(a, \alpha) = w(\alpha)$. Then $\varphi_{\alpha_k}(a, 0) = h^{(k)}(a)$ and $\varphi_{x\alpha_k}(a, 0) = (h^{(k)})'(a)$, which shows that these extremals define a field of extremals for α small. The same arguments as above guarantee that properties (51),(52) are satisfied. Let us show that (50) is true. If $i, j \in I_a^{\mathcal{N}}$,

then this follows from $f_{p_i}(a, v, \psi(a, v)) = f_{p_j}(a, v, \psi(a, v)) = 0$. Let $i \in I_a^{\mathcal{D}}$. If $j \in I_a^{\mathcal{N}}$, then the left-hand side in (50) is zero due to $f_{p_i u_j} = f_{p_i p_j} = 0$. If $j \in I_a^{\mathcal{D}}$, then that left-hand side equals $f_{p_i u_j}(a, v, \psi(a, v)) + \sum_{k \in I} f_{p_i p_k}(a, v, \psi(a, v)) \psi_{k, v_j}(a, v)$. Since $f_{p_i u_j} = f_{p_j u_i}$, $f_{p_i p_k}(a, v, \psi(a, v)) = 0$ for $k \in I_a^{\mathcal{N}}$ and $\psi_{k, v_j}(a, v) = \frac{1}{\eta} \delta_{kj}$ if $k \in I_a^{\mathcal{D}}$, we see that that left-hand side equals to the right-hand side. \square

Proof of Proposition 17. If $w = (w_1, \dots, w_N)$ depends on θ , then we denote $w_{i, \theta} := \frac{\partial w_i}{\partial \theta}$. By differentiating the identity $\varphi_x(x, \alpha) = \psi(x, \varphi(x, \alpha))$ we obtain

$$\varphi_{j, xx} = \psi_{j, x} + \sum_k \psi_{j, v_k} \varphi_{k, x} = \psi_{j, x} + \sum_k \psi_{j, v_k} \psi_k.$$

If we substitute this relation into the Euler equations

$$\sum_j (f_{p_i p_j} \varphi_{j, xx} + f_{p_i u_j} \varphi_{j, x}) + f_{p_i x} - f_{u_i} = 0,$$

(where the arguments of the derivatives of f and φ are $(x, \varphi(x, \alpha), \varphi_x(x, \alpha))$ and (x, α) , respectively), then we obtain

$$\sum_j (f_{p_i p_j} (\psi_{j, x} + \sum_k \psi_{j, v_k} \psi_k) + f_{p_i u_j} \psi_j) + f_{p_i x} - f_{u_i} = 0, \quad (64)$$

where the arguments of the derivatives of f and ψ are $(x, v, \psi(x, v))$ and (x, v) , respectively. For $(x, v) \in \mathcal{P}$ we set

$$\begin{aligned} V(x, v) &:= f(x, v, \psi(x, v)) - f_p(x, v, \psi(x, v)) \cdot \psi(x, v), \\ W(x, v) &:= f_p(x, v, \psi(x, v)). \end{aligned} \quad (65)$$

We claim that

$$(W_{i, v_j} - W_{j, v_i})(x, v) = \frac{\partial f_{p_i}(x, v, \psi(x, v))}{\partial v_j} - \frac{\partial f_{p_j}(x, v, \psi(x, v))}{\partial v_i} = 0, \quad i, j \in I. \quad (66)$$

In fact, if f and φ are of class C^3 , then setting $v = \varphi(x, \alpha)$ and $\psi(x, v) = \varphi_x(x, \alpha)$ in (66), the Euler equations imply that the d/dx -derivative of the resulting expression vanishes, hence the conclusion follows from (50). Such argument can also be used without the additional smoothness assumptions on f, φ , see the proof of [8, Proposition 6.1.1.4].

Now (66) and (64) imply $V_v = W_x$. This fact and (66) guarantee the existence of $S \in C^2(\mathcal{P})$ such that $S_x = V$ and $S_v = W$. Finally,

$$\begin{aligned} I(v) &= \int_a^b (V + W \cdot v') dx = \int_a^b (S_x + S_v \cdot v') dx = \int_a^b \frac{d}{dx} S(x, v(x)) dx \\ &= S(b, v(b)) - S(a, v(a)). \end{aligned}$$

\square

Remark 24. Necessary and sufficient conditions for weak minimizers in [15, 16] are formulated in terms of (semi-)coupled points and seem to be more complicated than our conditions. In order to compare them, let us consider the scalar case with variable endpoints (i.e. $I_a^{\mathcal{D}} = I_b^{\mathcal{D}} = \emptyset$), and let h be the solution of the Jacobi equation satisfying the

initial conditions $h(a) = 1$, $\mathcal{B}h(a) = 0$. Let us also denote $Q := f_{uu}^0$. Then our sufficient condition for a weak minimizer in Theorem 7 is equivalent to

$$h(y) \neq 0 \text{ for } y \in (a, b] \quad \text{and} \quad \mathcal{B}h(b) > 0, \quad (67)$$

while the sufficient condition for a weak minimizer in [15, 16] is equivalent to

$$-\mathcal{B}h(y) \neq \left(\int_y^b Q \right) h(y) \text{ for } y \in (a, b] \quad \text{and} \quad \int_a^b Q > 0. \quad (68)$$

The proofs of the sufficiency guarantee that (67) is equivalent to (68). Let us show this equivalence directly: For simplicity, consider just Lagrangians of the form $2f(x, u, p) = p^2 + Q(x)u^2$. Then $\mathcal{B}h = h'$ and the Jacobi equation has the form $h'' = Qh$. Let h be the solution of this equation with initial conditions $h(a) = 1$, $h'(a) = 0$.

First assume that (67) is true. Then integration by parts yields

$$\int_a^b Q = \int_a^b \frac{h''}{h} = \frac{h'}{h} \Big|_a^b + \int_a^b \frac{(h')^2}{h^2} > 0. \quad (69)$$

Assume to the contrary that $-h'(y) = \left(\int_y^b Q \right) h(y)$ for some $y \in (a, b]$. Then

$$-\int_y^b Q = \frac{h'(y)}{h(y)} = \frac{h'}{h} \Big|_a^y = \int_a^y \left(\frac{h''}{h} - \frac{(h')^2}{h^2} \right) = \int_a^y \left(Q - \frac{(h')^2}{h^2} \right). \quad (70)$$

Now (70) and (69) imply

$$\int_a^b Q = \int_a^y \frac{(h')^2}{h^2} < \frac{h'}{h} \Big|_a^b + \int_a^b \frac{(h')^2}{h^2} = \int_a^b Q,$$

which yields a contradiction.

Next assume that (67) fails, i.e. either $h(y) = 0$ for some $y \in (a, b]$ or $h'(b) \leq 0$, and assume also to the contrary (68) is true. If $h(y) = 0$ for some $y \in (a, b]$ and $h > 0$ on $[a, y]$, then $h'(y) < 0$, hence

$$\begin{aligned} -h'(a) &= 0 < \left(\int_a^b Q \right) h(a), \\ -h'(y) &> 0 &= \left(\int_y^b Q \right) h(y), \end{aligned}$$

so that there exists $z \in (a, y)$ such that $-h'(z) = \left(\int_z^b Q \right) h(z)$, which yields a contradiction. If $h > 0$ and $h'(b) \leq 0$, then

$$\begin{aligned} -h'(a) &= 0 < \left(\int_a^b Q \right) h(a), \\ -h'(b) &\geq 0 = \left(\int_b^b Q \right) h(b), \end{aligned}$$

so that there exists $z \in (a, b]$ such that $-h'(z) = \left(\int_z^b Q \right) h(z)$ and we arrive at contradiction again.

The proof above shows that if y_1 is the first (= smallest) zero of h , then the smallest solution z_1 of the equation $-h'(z) = \left(\int_z^b Q \right) h(z)$ satisfies $z_1 < y_1$. The inequality $z_1 \leq y_1$ also follows from the proof of Theorem 8 and the corresponding proof in [16]. In fact, those proofs show that y_1 and z_1 correspond to the zeroes of the continuous nonincreasing

functions $\lambda_1(y) = \inf_{S_y} \Psi$ and $\tilde{\lambda}_1(z) = \inf_{\tilde{S}_z} \Psi$, respectively, where S_y is the unit sphere in X_y (see (17)) and \tilde{S}_z is the unit sphere in $\tilde{X}_z = \{h \in W^{1,2}([a, b]) : h(x) = h(z) \text{ for } x \geq z\}$. Since $X_y \subset \tilde{X}_y$ and the norm in X_y is equivalent to the norm in $W^{1,2}$, we have $\tilde{\lambda}_1 \leq \max\{C\lambda_1, 0\}$. \square

The following proposition is motivated by [11] and Section 4. Given $u^0 \in C^1([a, b], \mathbb{R}^N)$, we will use the following notation (cf. (2)):

$$\mathcal{M} := u^0 + C_D^1 = \{u \in C^1([a, b]) : (u_i - u_i^0)(x) = 0 \text{ for } i \in I_x^D \text{ and } x \in \{a, b\}\},$$

$$\mathcal{M}_{\mathcal{N}} := \{u \in \mathcal{M} : u'_i(x) = 0 \text{ for } i \in I_x^{\mathcal{N}} \text{ and } x \in \{a, b\}\}.$$

Proposition 25. *Let $f \in C^1$ and let u^0 be a weak minimizer of Φ in $\mathcal{M}_{\mathcal{N}}$. Then u^0 is a weak minimizer in \mathcal{M} . Conversely, if u is a weak minimizer in \mathcal{M} and $u^0 \in \mathcal{M}_{\mathcal{N}}$, then u^0 is a weak minimizer in $\mathcal{M}_{\mathcal{N}}$.*

Proof. For simplicity, we will prove the assertion only in the special case $N = 1$, $I_a^D = \emptyset$, $I_b^{\mathcal{N}} = \emptyset$, but it will be clear from the proof that our arguments can also be used in the general case.

Hence assume first that u^0 is a weak minimizer of Φ in

$$\mathcal{M}_{\mathcal{N}} = \{u \in C^1([a, b]) : (u - u^0)(b) = 0, u'(a) = 0\}.$$

Then there exists $\varepsilon > 0$ such that u^0 is a (global) minimizer of Φ in the set

$$\mathcal{M}_{\mathcal{N}}^\varepsilon := \{u \in \mathcal{M}_{\mathcal{N}} : \|u - u^0\|_{C^1} < \varepsilon\}.$$

We will show that u^0 is a (global) minimizer in the set $\mathcal{M}^{\varepsilon/4}$, where

$$\mathcal{M}^\varepsilon := \{u \in \mathcal{M} : \|u - u^0\|_{C^1} < \varepsilon\},$$

hence u^0 is a weak minimizer of Φ in $\mathcal{M} = \{u \in C^1([a, b]) : (u - u^0)(b) = 0\}$.

Fix $u \in \mathcal{M}^{\varepsilon/4}$. Since $(u^0)'(a) = 0$, given $k \in \mathbb{N}$, there exists $\delta_k \in (0, 1/k)$ such that

$$|(u^0)'(x)| < 1/k \text{ for } x \in J_k := [a, a + \delta_k].$$

Since $\|u - u^0\|_{C^1} < \varepsilon/4$, we also have $|u'(x)| < \varepsilon/4 + 1/k$ for $x \in J_k$. Consequently, we can modify the function u in J_k such that the modified function $u^k \in C^1([a, b])$ satisfies $u^k = u$ on $[a + \delta_k, b]$, $(u^k)'(a) = 0$ and $|(u^k)'(x)| < \varepsilon/4 + 1/k$ for $x \in J_k$ (for example, we can choose $(u^k)'(x) = u'(\delta_k)(x - a)/(\delta_k - a)$ for $x \in J_k$). Then

$$|(u^k)' - (u^0)'| \leq |(u^k)'| + |(u^0)'| < \varepsilon/4 + 2/k \text{ on } J_k$$

and the Mean Value Theorem implies

$$|u^k - u^0| \leq |u^k - u| + |u - u^0| < \max_{J_k} |(u^k - u)'| \delta_k + \varepsilon/4 < (\varepsilon/2 + 2/k)/k + \varepsilon/4 \text{ on } J_k,$$

hence $u^k \in \mathcal{M}_{\mathcal{N}}^\varepsilon$ for k large, which implies $\Phi(u^k) \geq \Phi(u^0)$. Since $\Phi(u^k) \rightarrow \Phi(u)$, we have $\Phi(u) \geq \Phi(u^0)$.

The converse assertion is trivial. \square

Remark 26. In [11, Propositions 5 and 6] the authors consider the function u^0 and the functional Φ from our Section 4, and they provide conditions guaranteeing that u^0 is a weak minimizer subject to the Neumann boundary conditions for some of its components (see (24) and (23) above). Proposition 25 shows that the Neumann boundary conditions do not play any role in such assertions, i.e. u^0 remains a weak minimizer if we replace

“the Neumann boundary conditions” with “no boundary conditions”. Consequently (see Proposition 1), u^0 then has to satisfy the corresponding natural boundary conditions (instead of the Neumann boundary conditions). The Neumann boundary conditions are different from the natural boundary conditions in general, but the first two components of the function u^0 in Section 4 satisfy both the Neumann and the natural boundary conditions. \square

ACKNOWLEDGEMENTS

This work was supported in part by VEGA grant 1/0245/24. The author thanks the anonymous referee for many helpful comments.

REFERENCES

- [1] Batista M., *On stability of non-inflectional elastica*, C. R. Mécanique **348** (2020), 137–148.
- [2] Bednárík D., *Weak and strong minimizers of variational integrals*, Master thesis, Comenius University, Bratislava 2022 (<http://www.iam.fmph.uniba.sk/institute/quittner/bednarik.pdf>).
- [3] Borum A. and Bretl T., *When is a helix stable?*, Phys. Rev. Letters **125** (2020), #088001.
- [4] Brezis H. and Nirenberg L., *H^1 versus C^1 local minimizers*, C. R. Acad. Sci. Paris **317** (1993), 465–472.
- [5] Cesari L., *Optimization - theory and applications*, Springer, Berlin 1983.
- [6] Cicalese M., Ruf M. and Solombrino F., *On global and local minimizers of prestrained thin elastic rods*, Calc. Var. **56** (2017), #115.
- [7] Gelfand I. M. and Fomin S. V., *Calculus of Variations*, Prentice Hall, Englewood Cliffs, N.J., 1963.
- [8] Giaquinta M. and Hildebrandt S., *Calculus of Variations I*, Springer, Berlin - Heidelberg, 2004.
- [9] Jin M., *Stability to discontinuous perturbations for one inflexion Euler elastica with one end fixed and the other clamped in rotation*, Eur. J. Mech. A Solids **81** (2020), #103954.
- [10] Lessinnes T. and Goriely A., *Geometric conditions for the positive definiteness of the second variation in one-dimensional problems*, Nonlinearity **30** (2017), 2023–2062.
- [11] Majumdar A. and Raisch A., *Stability of twisted rods, helices and buckling solutions in three dimensions*, Nonlinearity **27** (2014), 2841–2867.
- [12] Manning R. S., *Conjugate points revisited and Neumann-Neumann problems*, SIAM Review **51** (2009), 193–212.
- [13] Olver P. J., *Boundary conditions and null Lagrangians in the calculus of variations and elasticity*, J. Elast., to appear (<https://doi.org/10.1007/s10659-022-09912-5>).
- [14] O’Reilly O. M. and Peters D. M., *On stability analyses of three classical buckling problems for the elastic strut*, J. Elast. **105** (2011), 117–136.
- [15] Zeidan V., *Sufficient conditions for variational problems with variable endpoints: Coupled points*, App. Math. Optim. **27** (1993), 191–209.
- [16] Zezza P., *Jacobi condition for elliptic forms in Hilbert spaces*, J. Optim. Theory Appl. **76** (1993), 357–380.
- [17] Zezza P., *Errata corrige: “Jacobi condition for elliptic forms in Hilbert spaces”*, J. Optim. Theory Appl. **95** (1997), 741–742.

DEPARTMENT OF APPLIED MATHEMATICS AND STATISTICS, COMENIUS UNIVERSITY, MLYNSKÁ DOLINA, 84248 BRATISLAVA, SLOVAKIA

Email address: quittner@fmph.uniba.sk