

Storage and retrieval of von Neumann measurements

Paulina Lewandowska,^{1,*} Ryszard Kukulski,¹ Łukasz Paweła,¹ and Zbigniew Puchała¹

¹*Institute of Theoretical and Applied Informatics,
Polish Academy of Sciences, Baltycka 5, 44-100 Gliwice, Poland*

This work examines the problem of learning an unknown von Neumann measurement of dimension d from a finite number of copies. To obtain a faithful approximation of the given measurement we are allowed to use it N times. Our main goal is to estimate the asymptotic behavior of the maximum value of the average fidelity function F_d for a general $N \rightarrow 1$ learning scheme. We show that $F_d = 1 - \Theta\left(\frac{1}{N^2}\right)$ for arbitrary but fixed dimension d . In addition to that, we compared various learning schemes for $d = 2$. We observed that the learning scheme based on deterministic port-based teleportation is asymptotically optimal but performs poorly for low N . In particular, we discovered a parallel learning scheme, which despite its lack of asymptotic optimality, provides a high value of the fidelity for low values of N and uses only two-qubit entangled memory states.

I. INTRODUCTION

In the general approach of storage and retrieval (SAR) of quantum operations, we want to approximate a given, unknown operation, which we were able to perform N times experimentally. Such a scheme is called $N \rightarrow 1$ learning scheme. This strategy usually consists of preparing some initial quantum state, applying the unknown operation for later use, and finally, a retrieval operation that applies an approximation of the black box on some arbitrary quantum state. Additionally, each application of the operation contained within the black box can be followed by some arbitrary processing operations. If that is the case, the optimal strategy should also contain their description. The scheme is optimal when it achieves the highest possible fidelity of the approximation [1, 2].

The obstacle standing in the way of achieving unit fidelity lies in the no-cloning theorem [3] and even further, the no-programming theorem [4]. It states that a general processor, which performs a program based on some input state is not possible. There is no doubt that programmable devices would represent an instrumental piece of quantum technology. Hence, their approximate realizations are of common interest [5–9]. Nevertheless, one should keep in mind the difference between programming and learning. A learning protocol can be used to generate a program, but the program does not have to be generated by learning. Although, in some cases, the performances of programming and learning are equal [7].

The seminal work in this field was the paper by Bisio and Chiribella [10]. It was devoted to learning an unknown unitary transformation. Therein, the authors focused on storing the unitary operation in a quantum memory while having limited resources. They proved that unitary operations could be learned optimally in the parallel scheme, meaning there is no additional processing after using the unknown unitary transformation.

Hence, all the required uses of the black box can be performed in parallel. They also provide an upper bound on the fidelity of $N \rightarrow 1$ learning scheme that is equal $1 - \Theta\left(\frac{1}{N^2}\right)$. A probabilistic version of SAR (PSAR) problem was also considered in [11, 12]. There, they showed the optimal success probability of $N \rightarrow 1$ PSAR of unitary channels on d -dimensional quantum systems is equal to $N/(N - 1 + d^2)$.

It is worth mentioning that the SAR of unitary operations is also closely related to port-based teleportation (PBT) [13, 14]. One may take the PBT protocol to define a learning scheme. In particular, the entanglement fidelity of the deterministic PBT protocol matches the fidelity of learning unitary operations [10, 15]. Similarly, the probability of successful teleportation is equal to the performance of PSAR [11]. Finally, the task of learning unknown operations fits into the paradigm of quantum machine learning, when both the data and the algorithms are quantum [16–22].

Subsequent works build upon these results but focus on different classes of operations, for example, the von Neumann measurements [23]. In contrast to previous works, they showed that, in general, the optimal algorithm for quantum measurement learning cannot be parallel and found the optimal learning algorithm for arbitrary von Neumann measurements for the case $1 \rightarrow 1$ and $2 \rightarrow 1$. Nevertheless, a general optimal scheme $N \rightarrow 1$ of measurement learning still remains an open problem, even for low-dimensional quantum systems. Hence, despite some partial results, the investigation of SAR for von Neumann measurements is still an open question.

In this work, we address the unsolved problem of learning an unknown von Neumann measurement defined in [23]. We focus on $N \rightarrow 1$ learning scheme of von Neumann measurements. We investigate a value of the average fidelity in the asymptotic regime. By using the deterministic PBT protocol we state a lower bound which behaves as $1 - \Theta\left(\frac{1}{N^2}\right)$. Moreover, we provide an upper bound for the average fidelity function, which matches the lower bound and hence provides a solution to the problem.

Additionally, we compare different learning schemes for

* plewandowska@iitis.pl

the qubit case. Although, the learning scheme based on PBT is asymptotically optimal, it can be outperformed for low values of N . To show this, we introduce a scheme, which we call *pretty good learning scheme* (PGLS). This scheme is a particular case of a parallel learning scheme which uses only two-qubit entangled memory states. The fidelity function calculated for the pretty good learning scheme is uniform over all qubit von Neumann measurements and behaves as $1 - \Theta(\frac{1}{N})$.

This paper is organized as follows. In Section II we formulate the problem of von Neumann measurement learning. In Section II A we introduce necessary mathematical concepts. Our main result is then presented in Section II B (Theorem 1). To prove this theorem, we first address the case of lower bound (Section III A), and subsequently, upper bound (Section III B). In Section IV we compare the performance of different learning schemes for a qubit case. In particular, we introduce the pretty good learning scheme and present numerical results about the most efficient parallel and adaptive learning schemes. Finally, Section V concludes the article with a summary of the main results. In the Appendix, we provide technical details of proofs.

II. PROBLEM FORMULATION

This section presents the formulation of the problem of learning an unknown von Neumann measurement. We provide an overview of a learning scheme in Fig. 1, along with its description in Subsection II B.

A. Mathematical framework

Let us introduce the following notation. Consider a d -dimensional complex Euclidean space \mathbb{C}^d and denote it by \mathcal{H}_d . Let $M(\mathcal{H}_{d_1}, \mathcal{H}_{d_2})$ be the set of all matrices of dimension $d_1 \times d_2$. As a shorthand we put $M(\mathcal{H}_d) := M(\mathcal{H}_d, \mathcal{H}_d)$. The set of quantum states defined on space \mathcal{H}_d , that is the set of positive semidefinite operators having unit trace, will be denoted by $\Omega(\mathcal{H}_d)$. We will also need a linear mapping transforming $M(\mathcal{H}_{d_1})$ into $M(\mathcal{H}_{d_2})$ as $\mathcal{T} : M(\mathcal{H}_{d_1}) \mapsto M(\mathcal{H}_{d_2})$. There exists a bijection between introduced linear mappings \mathcal{T} and set of matrices $M(\mathcal{H}_{d_1 d_2})$, known as the Choi-Jamiołkowski isomorphism [24, 25]. Its explicit form is $T = \sum_{i,j=0}^{d_1-1} \mathcal{T}(|i\rangle\langle j|) \otimes |i\rangle\langle j|$. We will denote linear mappings with calligraphic font $\mathcal{L}, \mathcal{S}, \mathcal{T}$ etc., whereas the corresponding Choi-Jamiołkowski matrices as plain symbols: L, S, T etc. Moreover, we introduce the vectorization operation of a matrix $X \in M(\mathcal{H}_{d_1}, \mathcal{H}_{d_2})$, defined by $|X\rangle\rangle := \sum_{i=0}^{d_2-1} (X|i\rangle) \otimes |i\rangle$.

A general quantum measurement (POVM) \mathcal{Q} can be viewed as a set of positive semidefinite operators $\mathcal{Q} = \{Q_i\}_i$ such that $\sum_i Q_i = \mathbb{1}$. These operators are usually called effects. The von Neumann measurements, \mathcal{P}_U , are a special subclass of measurements whose all effects

are rank-one projections given by $\mathcal{P}_U = \{P_{U,i}\}_{i=0}^{d-1} = \{U|i\rangle\langle i|U^\dagger\}_{i=0}^{d-1}$ for some unitary matrix $U \in M(\mathcal{H}_d)$.

Quantum channels are completely positive and trace preserving (CPTP) linear maps. Generally, \mathcal{C} is a quantum channel which maps $M(\mathcal{H}^{(in)})$ to $M(\mathcal{H}^{(out)})$ if its Choi-Jamiołkowski operator C is a positive semidefinite and $\text{tr}_{\mathcal{H}^{(out)}}(C) = \mathbb{1}$, where $\text{tr}_{\mathcal{H}^{(out)}}$ denotes a partial trace over the output system $\mathcal{H}^{(out)}$. Given a von Neumann measurement \mathcal{P}_U , it can be seen as a measure-and-prepare quantum channel $\mathcal{P}_U(\rho) = \sum_i \text{tr}(P_{U,i}\rho) |i\rangle\langle i|$, $\rho \in \Omega(\mathcal{H}_d)$. The Choi matrix of \mathcal{P}_U is $P_U = \sum_i |i\rangle\langle i| \otimes \overline{P_{U,i}}$, which will be utilized throughout this work. Finally, we will use the notation Φ_U to indicate unitary channel given by $\Phi_U(X) = UXU^\dagger$ and the shortcut $\mathcal{I}_d := \Phi_{\mathbb{1}_d}$ for the identity channel.

B. Learning setup

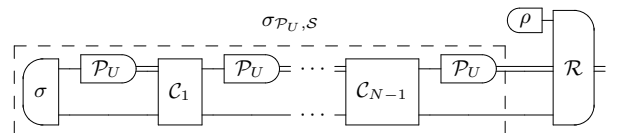

Figure 1: Schematic representations of the setup for learning of von Neumann measurements \mathcal{P}_U in the $N \rightarrow 1$ scheme.

Imagine we are given a black box with the promise that it contains some von Neumann measurement, \mathcal{P}_U , parameterized by a unitary matrix U . The exact value of U is unknown to us. We are allowed to use the black box N times. Our goal is to prepare some initial memory state σ , some intermediate processing channels $\mathcal{C}_1, \dots, \mathcal{C}_{N-1}$ and a measurement \mathcal{R} such that we are able to approximate \mathcal{P}_U on an arbitrary state ρ . This approximation will be denoted throughout this work as \mathcal{Q}_U . We would like to point out that, generally, \mathcal{Q}_U will *not* be a von Neumann measurement.

The initial memory state σ and entire sequence of processing channels $\{\mathcal{C}_i\}$ can be viewed as *storing* the unknown operation and will be denoted as \mathcal{S} whereas the measurement \mathcal{R} we will call as *retrieval*. During the storing stage, we apply \mathcal{S} on N copies of \mathcal{P}_U . As a result, the initial memory state σ is transferred to the memory state $\sigma_{\mathcal{P}_U, \mathcal{S}}$. After that, we measure an arbitrary quantum state ρ and the memory state $\sigma_{\mathcal{P}_U, \mathcal{S}}$ by using \mathcal{R} . Equivalently, we can say that during retrieval stage, we apply the measurement \mathcal{Q}_U on the state ρ . The entire learning scheme will be denoted by \mathcal{L} and considered as a triple $\mathcal{L} = (\sigma, \{\mathcal{C}_i\}_{i=1}^{N-1}, \mathcal{R})$. We emphasize that the procedure allows us to use as much quantum memory as necessary.

As a measure of quality of approximating a von Neumann measurement $\mathcal{P}_U = \{P_{U,i}\}_i$ with a POVM $\mathcal{Q}_U = \{Q_{U,i}\}_i$ we choose the fidelity function [1], which is de-

defined as follows

$$\mathcal{F}_d(\mathcal{P}_U, \mathcal{Q}_U) := \frac{1}{d} \sum_i \text{tr}(P_{U,i} Q_{U,i}), \quad (1)$$

where d is the dimension of the measured system. Note that in the case when \mathcal{P}_U is a von Neumann measurement we obtain the value of fidelity function \mathcal{F}_d belongs to the interval $[0, 1]$ and equals one if and only if $P_{U,i} = Q_{U,i}$ for all i . As there is no prior information about \mathcal{P}_U provided, we assume that U is sampled from a distribution pertaining to the Haar measure. Therefore, considering a von Neumann measurement \mathcal{P}_U and its approximation \mathcal{Q}_U we introduce the *average fidelity function* [26] with respect to Haar measure as

$$\mathcal{F}_d^{\text{avg}}(\mathcal{L}) := \int_U dU \mathcal{F}_d(\mathcal{P}_U, \mathcal{Q}_U). \quad (2)$$

Our main goal is to maximize $\mathcal{F}_d^{\text{avg}}$ over all possible learning schemes $\mathcal{L} = (\sigma, \{\mathcal{C}_i\}_{i=1}^{N-1}, \mathcal{R})$. We introduce the notation of the maximum value of the average fidelity function

$$F_d := \max_{\mathcal{L}} \mathcal{F}_d^{\text{avg}}(\mathcal{L}). \quad (3)$$

In this work, we analyze the asymptotic behavior of F_d with $N \rightarrow \infty$. Our main result can be summarized as the following theorem.

Theorem 1. *Let F_d be the maximum value of the average fidelity function, defined in Eq. (3) for $N \rightarrow 1$ learning scheme of von Neumann measurements. Then, for arbitrary but fixed dimension d we obtain*

$$F_d = 1 - \Theta\left(\frac{1}{N^2}\right). \quad (4)$$

III. FIDELITY BOUNDS

This section provides a sketch of the proof of Theorem 1, along with a general intuition behind our result. The full proofs are postponed to the Appendix A, B and C due to their technical nature.

A. Lower bound

The proof of the lower bound for F_d is constructive. We will construct the learning scheme \mathcal{L} of von Neumann measurements, which achieves the scaling $\mathcal{F}_d^{\text{avg}}(\mathcal{L}) = 1 - \Theta\left(\frac{1}{N^2}\right)$.

The construction is based on deterministic port-based teleportation (DPBT) [13–15, 27, 28]. In this scheme (see Fig. 2), two individuals – Alice and Bob, share an entangled state $|\psi\rangle\langle\psi|_{A,B} \in \Omega(\mathcal{H}_{dN}^{(A)} \otimes \mathcal{H}_{dN}^{(B)})$. Bob perceives his compound system $\mathcal{H}_{dN}^{(B)}$ as a tensor product of

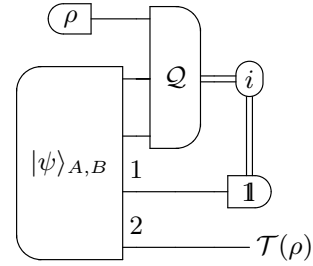

Figure 2: Schematic representation of DPBT for $N = 2$. In this case, the output label $i = 2$ of the measurement \mathcal{Q} determines the partial trace of the first system of the remaining quantum state.

N systems (ports) of the form $\mathcal{H}_{dN}^{(B)} = \mathcal{H}_d^{(1)} \otimes \dots \otimes \mathcal{H}_d^{(N)}$. Their goal is to teleport an unknown state $\rho \in \mathcal{H}_d^{(in)}$ from Alice to Bob in a way that this state appears in one of Bob's ports. To achieve this, Alice performs appropriate measurement $\mathcal{Q} = \{Q_i\}_{i=1}^N$ on $\rho \otimes |\psi\rangle\langle\psi|_A$, receives one of the labels $\{1, \dots, N\}$ and communicates this label to Bob. By using the label i , Bob chooses i -th system of his state $|\psi\rangle\langle\psi|_B$ as the one which contains the state ρ . The output of this procedure can be written as

$$\sum_{i=1}^N \text{tr}_{\mathcal{H}_d^{(in)} \otimes \mathcal{H}_{dN}^{(A)} \otimes \mathcal{H}_{dN-1}^{(B_i)}} \left((Q_i \otimes \mathbb{1}_{dN}) (\rho \otimes |\psi\rangle\langle\psi|_{A,B}) \right), \quad (5)$$

where $\mathcal{H}_{dN-1}^{(B_i)} := \mathcal{H}_d^{(1)} \otimes \dots \otimes \mathcal{H}_d^{(i-1)} \otimes \mathcal{H}_d^{(i+1)} \otimes \dots \otimes \mathcal{H}_d^{(N)}$. In short, the output of this procedure will be denoted as $\mathcal{T}(\rho)$, where \mathcal{T} is a channel describing DPBT, depending on the choice of $|\psi\rangle\langle\psi|_{A,B}$ and \mathcal{Q} . It is known [15], that the best teleportation procedure \mathcal{T}_0 approximates \mathcal{I}_d with the entanglement fidelity

$$F_* := \frac{1}{d^2} \text{tr}(T_0 |\mathbb{1}_d\rangle\langle\mathbb{1}_d|) = 1 - \Theta\left(\frac{1}{N^2}\right). \quad (6)$$

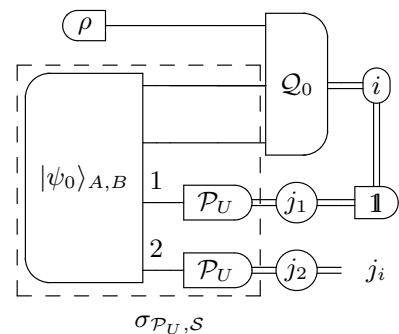

Figure 3: Schematic representation of the learning scheme for $N = 2$ based on DPBT. In this case, the label $i = 2$ of the measurement \mathcal{Q}_0 indicates that the output of the learning procedure equals $j_i = j_2$.

We can use DPBT to construct a learning scheme (see Fig. 3). Let $|\psi_0\rangle\langle\psi_0|_{A,B}$ and \mathcal{Q}_0 realize the optimal

teleportation strategy \mathcal{T}_0 . We take $\sigma = |\psi_0\rangle\langle\psi_0|_{A,B}$ as an initial memory state and consider a parallel learning scheme [10] with N copies of the von Neumann measurement \mathcal{P}_U . The result of the storage is a memory state $\sigma_{\mathcal{P}_U,S} = (\mathcal{I}_{d^N} \otimes \mathcal{P}_U^{\otimes N})(\sigma)$, which consists of the remaining quantum state τ , and a tuple of measurements' results $(j_1, \dots, j_N) \in \{0, \dots, d-1\}^N$. The retrieval \mathcal{R} is a composition of a measurement \mathcal{Q}_0 and classical postprocessing. In details, first, we apply \mathcal{Q}_0 on $\rho \otimes \tau$ to obtain the label $i \in \{1, \dots, N\}$. Second, we return the result j_i as the output of \mathcal{R} . This procedure determines a learning scheme \mathcal{L} which achieves the average fidelity

$$\mathcal{F}_d^{\text{avg}}(\mathcal{L}) = 1 - \Theta\left(\frac{1}{N^2}\right). \quad (7)$$

We postponed the details of the proof to Appendix A.

B. Upper bound

To show the upper bound for F_d , we will construct a different learning scheme based on the learning of unitary maps. It will provide the desired inequality, at first for $d = 2$, then for arbitrary d .

Lemma 1. *For $d = 2$ the maximum value of the average fidelity function defined in Eq. (3) is upper bounded by*

$$F_2 \leq 1 - \Theta\left(\frac{1}{N^2}\right). \quad (8)$$

The complete proof of Lemma 1 is shown in Appendix B. As in the previous section, here we will only sketch the key steps.

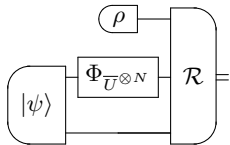

Figure 4: Schematic representation of the setup, which we use to calculate the upper bound for F_2 . In this scenario, we are given N copies of a unitary channel $\Phi_{\bar{U}}$ in parallel. Our objective is to approximate the von Neumann measurement \mathcal{P}_U .

Let us consider a new learning scheme presented in Fig. 4 for $d = 2$. In this scheme, we are given N copies of unitary channel $\Phi_{\bar{U}}$, which we can use in parallel. We want to approximate the measurement \mathcal{P}_U , but using the black box with the unitary channel $\Phi_{\bar{U}}$ inside. We will choose the appropriate initial memory state $|\psi\rangle$ and retrieval binary measurement $\mathcal{R} = \{R_0, R_1\}$. We use the same measures of quality as before, namely \mathcal{F}_2 defined in Eq. (1) and $\mathcal{F}_2^{\text{avg}}$ defined in Eq. (2). The goal is to maximize the value of the average fidelity function, which in

this case, we will denote as \widetilde{F}_2 . In the Appendix B1 we derived the formula for \widetilde{F}_2 , which is given by

$$\widetilde{F}_2 = \max_{\mathcal{R}, |\psi\rangle\langle\psi|} \int_U dU \sum_{i=0}^1 \frac{\text{tr} \left[R_i \left(P_{U,i} \otimes \left(\Phi_{\bar{U}^{\otimes N}} \otimes \mathcal{I} \right) (|\psi\rangle\langle\psi|) \right) \right]}{2}. \quad (9)$$

Calculating the value of \widetilde{F}_2 is the crux of the proof, because we managed to show that $F_2 \leq \widetilde{F}_2$ (see Lemma 3 in Appendix B). We derived the thesis of Lemma 1 by achieving the inequality $\widetilde{F}_2 \leq 1 - \Theta\left(\frac{1}{N^2}\right)$.

The proof of the upper bound for arbitrary d relies on the qubit case. Let us take the optimal learning scheme \mathcal{L} such that it achieves $\mathcal{F}_d^{\text{avg}}(\mathcal{L}) = F_d$ and satisfies the following commutation relation

$$[L, \mathbb{1}_d \otimes U \otimes (\mathbb{1}_d \otimes \bar{U})]^{\otimes N} = 0 \quad (10)$$

for any unitary matrix $U \in M(\mathcal{H}_d)$. We can use \mathcal{L} to construct a learning scheme \mathcal{L}' of qubit von Neumann measurements, such that it holds $\mathcal{F}_2^{\text{avg}}(\mathcal{L}') \geq dF_d - (d-1)$. It directly implies that $F_d \leq 1 - \Theta\left(\frac{1}{N^2}\right)$. We postponed the technical details to Appendix C.

Corollary 1. *There is no perfect learning scheme for von Neumann measurements, i.e. for any $N \in \mathbb{N}$ the value of $F_d < 1$.*

IV. QUBIT CASE

In this subsection we investigate more deeply the behavior of $\mathcal{F}_2^{\text{avg}}$ for different types of learning schemes \mathcal{L} .

A. Pretty good learning scheme

The first scheme which we analyze will be called the *pretty good learning scheme*. Despite its lack of optimality, it provides a relatively high value for the average fidelity function asymptotically behaving as $\mathcal{F}_2^{\text{avg}}(\mathcal{L}_{PGLS}) = 1 - \Theta\left(\frac{1}{N}\right)$. This scheme employs a simple storage strategy, which uses only two-qubit entangled memory states and the learning process is done in parallel. Moreover, the achieved value of the fidelity function is uniform over all qubit von Neumann measurements.

Let us consider a parallel learning scheme with N copies of the von Neumann measurement \mathcal{P}_U . A sketch of our scheme is shown in Fig. 5 and here we present the algorithm describing the procedure:

1. We prepare the initial memory state σ as a tensor product of N maximally entangled states $|\omega\rangle := \frac{1}{\sqrt{2}} |\mathbb{1}_2\rangle$.
2. We partially measure each state $|\omega\rangle$ using \mathcal{P}_U , obtaining the state $(\mathcal{P}_U \otimes \mathcal{I}_2)(|\omega\rangle\langle\omega|)$.

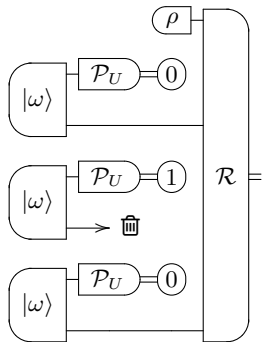

Figure 5: Schematic representations of the pretty good learning scheme for $N = 3$. In the learning process we obtained three labels: 0, 1, 0. As labels “0” are in majority, we reject the label “1” and the associated quantum part.

3. For each measurement \mathcal{P}_U , we obtain one of two possible measurement results: “0” or “1”. In consequence, we get N_0 outcomes “0” and N_1 outcomes “1”, $N_0 + N_1 = N$. The state of the remaining quantum part is equal to $\overline{P_{U,0}}^{\otimes N_0} \otimes \overline{P_{U,1}}^{\otimes N_1}$ (up to permutation of subsystems). Without loss of a generality (w.l.o.g.), we may assume that $N_0 \geq N_1$.
4. By majority vote we reject minority report, *i.e.* we reject all outcomes “1” and quantum states associated with them. As a result the memory state is given by $\sigma_{\mathcal{P}_U, S} = \overline{P_{U,0}}^{\otimes N_0}$.
5. We prepare an arbitrary state $\rho \in \Omega(\mathcal{H}_2)$.
6. We perform a binary retrieval measurement $\mathcal{R} = \{R, \mathbb{1} - R\}$ on $\rho \otimes \sigma_{\mathcal{P}_U, S}$.

To construct the effect R , let us fix N_0 and let $n = N_0 - 1$. We introduce the family of Dicke states [29]. The Dicke state $|D_k^n\rangle$ is the n -qubit state, which is equal to the superposition state of all $\binom{n}{k}$ basis states of weight k . For example, $|D_1^3\rangle = \frac{1}{\sqrt{3}}(|100\rangle + |010\rangle + |001\rangle)$. Let us also define

$$s_n(k, m) := \sum_{i=0}^k \sum_{j=0}^{n-k} \delta_{i+j-m} \binom{k}{i} \binom{n-k}{j} (-1)^{n-k-j} \quad (11)$$

being the convolution of binomial coefficients. Consider the effect R of the form

$$R = \sum_{k=0}^n |R_k\rangle\langle R_k|, \quad (12)$$

where $|R_k\rangle := \frac{|M_k\rangle}{\|M_k\|_2}$ and matrices $M_k \in M(\mathcal{H}_2, \mathcal{H}_{2^{n+1}})$ are given by

$$M_k = \sum_{m=0}^{n+1} \frac{s_n(k, n-m) |0\rangle + s_n(k, n+1-m) |1\rangle}{\sqrt{\binom{n+1}{m}}} \langle D_m^{n+1}| \quad (13)$$

for $k = 0, \dots, n$. The proof that R is a valid effect is relegated to Lemma 11 in Appendix D. In this learning scheme the approximation $\mathcal{Q}_U = \{Q_{U,0}, \mathbb{1} - Q_{U,0}\}$ is determined by relation $\text{tr}(\rho Q_{U,0}) = \text{tr}\left(\left(\rho \otimes \overline{P_{U,0}}^{\otimes N_0}\right) R\right)$. Basing on Lemma 12 in Appendix D, the effect $Q_{U,0}$ has the form

$$Q_{U,0} = \frac{N_0}{N_0 + 1} P_{U,0}. \quad (14)$$

Provided we observed N_0 outcomes “0”, we have that $\mathcal{F}_2(\mathcal{P}_U, \mathcal{Q}_U) = \frac{2N_0+1}{2N_0+2}$, where N_0 satisfies $N_0 \geq \lceil \frac{N}{2} \rceil$. Note, that the value of $\mathcal{F}_2(\mathcal{P}_U, \mathcal{Q}_U)$ does not depend on the choice of U . The average fidelity function $\mathcal{F}_2^{\text{avg}}(\mathcal{L}_{PGLS})$ defined for the pretty good learning scheme of qubit von Neumann measurements satisfies

$$\mathcal{F}_2^{\text{avg}}(\mathcal{L}_{PGLS}) = \begin{cases} \frac{1}{2^N} \sum_{l=k}^N 2 \binom{N}{l} \frac{2l+1}{2l+2}, & N = 2k - 1, \\ \frac{1}{2^N} \left(\binom{N}{k} \frac{2k+1}{2k+2} + \sum_{l=k+1}^N 2 \binom{N}{l} \frac{2l+1}{2l+2} \right), & N = 2k. \end{cases} \quad (15)$$

In the asymptotic regime, we may simplify the calculations to obtain

$$\mathcal{F}_2^{\text{avg}}(\mathcal{L}_{PGLS}) \geq \frac{2\lceil \frac{N}{2} \rceil + 1}{2\lceil \frac{N}{2} \rceil + 2} = 1 - \Theta\left(\frac{1}{N}\right). \quad (16)$$

Corollary 2. *In the pretty good learning scheme $\mathcal{L}_{PGLS} = (\sigma, \{\mathcal{C}_i\}_{i=1}^{N-1}, \mathcal{R})$ the initial state σ is defined as a product of N copies of maximally entangled state $|\omega\rangle$, processing channels $\{\mathcal{C}_i\}_{i=1}^{N-1}$ are responsible for majority voting and the measurement $\mathcal{R} = \{R, \mathbb{1} - R\}$ is defined by Eq.(12).*

Finally, averaging the construction of \mathcal{Q}_U over all possible combinations of measurements’ results $\{0, 1\}^N$ leads to the following approximation of \mathcal{P}_U .

Corollary 3. *The approximation \mathcal{Q}_U is a convex combination of the original measurement \mathcal{P}_U and the maximally depolarizing channel Φ_* . More precisely,*

$$\mathcal{Q}_U = p_0 \mathcal{P}_U + (1 - p_0) \Phi_*, \quad (17)$$

where $p_0 = 2\mathcal{F}_2^{\text{avg}}(\mathcal{L}_{PGLS}) - 1$.

In the pretty good learning scheme, to keep the calculation simple, we assumed that the retrieval measurement \mathcal{R} uses a memory state that is a tensor product of N_0 copies of the same state ($\overline{P_{U,0}}$ or $\overline{P_{U,1}}$). The same approach was investigated in the paper [30], where the value of the average fidelity function was originally derived $\mathcal{F}_2(\mathcal{P}_U, \mathcal{Q}_U) = \frac{2N_0+1}{2N_0+2}$. However, one may improve the learning scheme by using all available output states $\overline{P_{U,0}}$ and $\overline{P_{U,1}}$. In that case, we expect to obtain a higher value of the fidelity function. Such an intuition was confirmed by Gisin and Popescu [31], who proved that a memory state $\overline{P_{U,0}} \otimes \overline{P_{U,1}}$ encodes more information of the effect $P_{U,0}$, than a state $\overline{P_{U,0}} \otimes \overline{P_{U,0}}$.

B. Learning based on port-based teleportation

We have observed in Section III A that learning scheme based on DPBT achieves the average fidelity $\mathcal{F}_2^{\text{avg}}(\mathcal{L}_{DPBT}) = 1 - \Theta\left(\frac{1}{N^2}\right)$. More precisely, from the proof presented in Appendix A, we get $\mathcal{F}_2^{\text{avg}}(\mathcal{L}_{DPBT}) = \frac{1}{3} + \frac{2}{3}F_*$, where F_* is the entanglement fidelity of DPBT protocol. For $d = 2$ it is known [14] that $F_* = \cos^2\left(\frac{\pi}{N+2}\right)$. Hence,

$$\mathcal{F}_2^{\text{avg}}(\mathcal{L}_{DPBT}) = \frac{1}{3} + \frac{2}{3} \cos^2\left(\frac{\pi}{N+2}\right). \quad (18)$$

The learning scheme can also be constructed using probabilistic port-based teleportation (PPBT) (see for instance [15]). This protocol works similarly to \mathcal{L}_{DPBT} presented in Fig. 3. The difference is that the final measurement \mathcal{Q}_0 returns a label $i \in \{0, \dots, N\}$, where the label $i > 0$ indicates the success of the teleportation procedure – the initial state is in i -th port and the label $i = 0$ indicates the protocol's failure. The result from [27] says that the corresponding optimal probability of success teleportation is $p_0 = \frac{N}{N+3}$. That means the approximation \mathcal{Q}_U achieved by the learning scheme \mathcal{L}_{PPBT} is given by

$$\mathcal{Q}_U = p_0 \mathcal{P}_U + (1 - p_0) \Phi_*, \quad (19)$$

which implies

$$\mathcal{F}_2^{\text{avg}}(\mathcal{L}_{PPBT}) = \frac{2N+3}{2N+6}. \quad (20)$$

C. Numerical investigation

In is generally difficult to find an optimal procedure for quantum operations learning. It is worth mentioning that the parallel learning schemes match adaptive ones for $N = 1, 2$ but for $N \geq 3$ adaptive strategies achieve slight advantage [23].

In the numerical analysis, we compared average fidelity for the optimal parallel learning strategy $\mathcal{L}_{\text{Parallel}}$ with the optimal adaptive strategy $\mathcal{L}_{\text{Adaptive}}$. The scheme $\mathcal{L}_{\text{Adaptive}}$ is also the best possible scheme available, which is causally structured that is $\mathcal{F}_2^{\text{avg}}(\mathcal{L}_{\text{Adaptive}}) = F_2$.

N	1	2	3	4	5
$\mathcal{F}_2^{\text{avg}}(\mathcal{L}_{\text{Adaptive}})$	0.7499	0.8114	0.8684	0.8968	0.9189
$\mathcal{F}_2^{\text{avg}}(\mathcal{L}_{\text{Parallel}})$	0.7499	0.8114	0.8676	0.8955	0.9187
$\mathcal{F}_2^{\text{avg}}(\mathcal{L}_{\text{DPBT}})$	0.5000	0.6667	0.7697	0.8333	0.8745
$\mathcal{F}_2^{\text{avg}}(\mathcal{L}_{\text{PGLS}})$	0.7500	0.7917	0.8438	0.8625	0.8854
$\mathcal{F}_2^{\text{avg}}(\mathcal{L}_{\text{PPBT}})$	0.6250	0.7000	0.7500	0.7857	0.8125

To optimize this problem we used the Julia programming language along with quantum package `QuantumInformation.jl`[32] and SDP optimization via

SCS solver [33, 34] with a precision $\epsilon = 10^{-8}$. The code is available on GitHub [35].

We compare the results obtained in this section in the Figure 6.

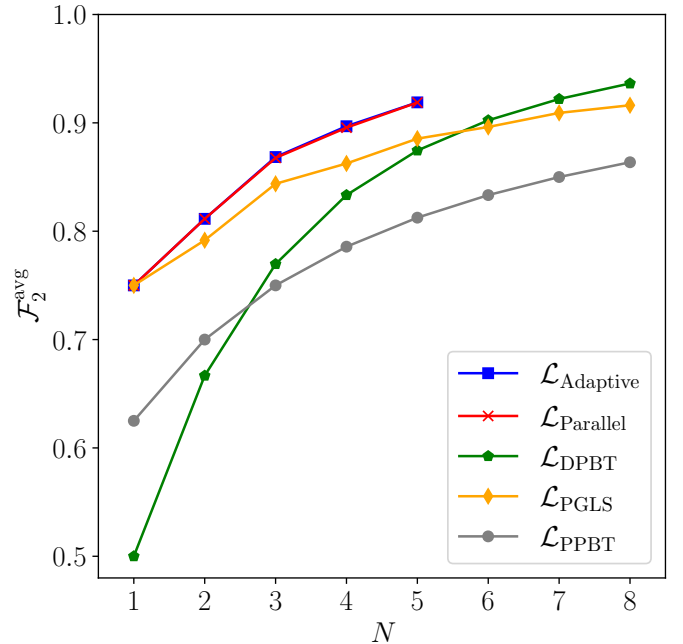

Figure 6: The average fidelity function (dimensionless) $\mathcal{F}_2^{\text{avg}}$ calculated for $N \rightarrow 1$ learning scheme: optimal adaptive strategy, $\mathcal{L}_{\text{Adaptive}}$ (numerical value, blue squares); optimal parallel scheme, $\mathcal{L}_{\text{Parallel}}$ (numerical value, red crosses); learning scheme based on DPBT, $\mathcal{L}_{\text{DPBT}}$ (green pentagons); pretty good learning scheme, $\mathcal{L}_{\text{PGLS}}$ (orange diamonds); learning scheme based on PPBT, $\mathcal{L}_{\text{PPBT}}$ (gray circles).

V. CONCLUSIONS AND DISCUSSION

In this work, we studied the problem of learning an unknown von Neumann measurement of dimension d from a finite number of copies. Our goal was to find the asymptotic behavior of the maximum value for the average fidelity function F_d . This value was maximized over all possible learning schemes, and the average was taken over all von Neumann measurements. By using the deterministic PBT protocol, we were able to state the lower bound $1 - \Theta\left(\frac{1}{N^2}\right)$, which matched the obtained upper bound and hence, solved the given problem.

In the qubit case, we introduced a scheme called the pretty good learning scheme. This scheme was a particular case of a parallel learning protocol, and it used only two-qubit entangled memory states. The average fidelity function calculated for the pretty good learning scheme behaved as $1 - \Theta\left(\frac{1}{N}\right)$. Moreover, we compared the performance of different learning schemes: adaptive, parallel, based on DPBT, based on PPBT and the pretty

good learning scheme for the qubit case. Although, the learning scheme based on PBT were asymptotically optimal, we showed that the pretty good learning scheme outperforms it for low values of N .

This work paves the way toward a complete description of the capabilities of von Neumann measurement learning schemes. One potential way forward is the probabilistic storage and retrieval approach, widely studied for unitary operations and phase rotations in [11, 12]. According to our numerical results, the probability of retrieval of a quantum measurement in a parallel scheme is exactly $N/(N+3)$, which corresponds to the value obtained in [11] for unitary channels, while adaptive strategies for quantum measurements learning to provide slightly higher probability, starting from $N \geq 3$.

ACKNOWLEDGMENTS

We would like to thank the anonymous reviewer for insightful comments and suggestions, especially for

introducing us the concept of port-based teleportation, which provided the asymptotically optimal lower bound for the fidelity value. This work was supported by the project „Near-term quantum computers Challenges, optimal implementations and applications” Grant No. POIR.04.04.00-00-17C1/18-00, which is carried out within the Team-Net programme of the Foundation for Polish Science co-financed by the European Union under the European Regional Development Fund. Paulina Lewandowska and Ryszard Kukulski are holders of European Union scholarship through the European Social Fund, grant InterPOWER (POWR.03.05.00-00-Z305).

-
- [1] M. Raginsky, “A fidelity measure for quantum channels,” *Physics Letters A*, vol. 290, no. 1-2, pp. 11–18, 2001.
 - [2] V. P. Belavkin, G. M. D’Ariano, and M. Raginsky, “Operational distance and fidelity for quantum channels,” *Journal of Mathematical Physics*, vol. 46, no. 6, p. 062106, 2005.
 - [3] W. K. Wootters and W. H. Zurek, “A single quantum cannot be cloned,” *Nature*, vol. 299, no. 5886, pp. 802–803, 1982.
 - [4] M. A. Nielsen and I. L. Chuang, “Programmable quantum gate arrays,” *Physical Review Letters*, vol. 79, no. 2, p. 032324, 1997.
 - [5] V. Bužek and M. Hillery, “Quantum copying: Beyond the no-cloning theorem,” *Physical Review A*, vol. 54, no. 3, p. 1844, 1996.
 - [6] M. Hillery, V. Bužek, and M. Ziman, “Probabilistic implementation of universal quantum processors,” *Physical Review A*, vol. 65, no. 2, p. 022301, 2002.
 - [7] Y. Yang, R. Renner, and G. Chiribella, “Optimal universal programming of unitary gates,” *Physical Review Letters*, vol. 125, no. 21, p. 210501, 2020.
 - [8] M. Gschwendtner, A. Bluhm, and A. Winter, “Programmability of covariant quantum channels,” *Quantum*, vol. 5, p. 488, 2021.
 - [9] A. Peres and P. F. Scudo, “Unspeakable quantum information,” *arXiv preprint quant-ph/0201017*, 2002.
 - [10] A. Bisio, G. Chiribella, G. M. D’Ariano, S. Facchini, and P. Perinotti, “Optimal quantum learning of a unitary transformation,” *Physical Review A*, vol. 81, no. 3, p. 032324, 2010.
 - [11] M. Sedlák, A. Bisio, and M. Ziman, “Optimal probabilistic storage and retrieval of unitary channels,” *Physical Review Letters*, vol. 122, no. 17, p. 170502, 2019.
 - [12] M. Sedlák and M. Ziman, “Probabilistic storage and retrieval of qubit phase gates,” *Physical Review A*, vol. 102, no. 3, p. 032618, 2020.
 - [13] S. Ishizaka and T. Hiroshima, “Asymptotic teleportation scheme as a universal programmable quantum processor,” *Physical Review Letters*, vol. 101, no. 24, p. 240501, 2008.
 - [14] S. Ishizaka and T. Hiroshima, “Quantum teleportation scheme by selecting one of multiple output ports,” *Physical Review A*, vol. 79, no. 4, p. 042306, 2009.
 - [15] M. Christandl, F. Leditzky, C. Majenz, G. Smith, F. Speelman, and M. Walter, “Asymptotic performance of port-based teleportation,” *Communications in Mathematical Physics*, vol. 381, no. 1, pp. 379–451, 2021.
 - [16] M. Sasaki and A. Carlini, “Quantum learning and universal quantum matching machine,” *Physical Review A*, vol. 66, no. 2, p. 022303, 2002.
 - [17] G. Sentís, J. Calsamiglia, R. Muñoz-Tapia, and E. Bagan, “Quantum learning without quantum memory,” *Scientific Reports*, vol. 2, no. 1, pp. 1–8, 2012.
 - [18] V. Dunjko, J. M. Taylor, and H. J. Briegel, “Quantum-enhanced machine learning,” *Physical Review Letters*, vol. 117, no. 13, p. 130501, 2016.
 - [19] A. Monras, G. Sentís, and P. Wittek, “Inductive supervised quantum learning,” *Physical Review Letters*, vol. 118, no. 19, p. 190503, 2017.
 - [20] U. Alvarez-Rodriguez, L. Lamata, P. Escandell-Montero, J. D. Martín-Guerrero, and E. Solano, “Supervised quantum learning without measurements,” *Scientific Reports*, vol. 7, no. 1, pp. 1–9, 2017.
 - [21] M. H. Amin, E. Andriyash, J. Rolfe, B. Kulchytskyy, and R. Melko, “Quantum boltzmann machine,” *Physical Review X*, vol. 8, no. 2, p. 021050, 2018.
 - [22] G. Sentís, A. Monras, R. Muñoz-Tapia, J. Calsamiglia, and E. Bagan, “Unsupervised classification of quantum data,” *Physical Review X*, vol. 9, no. 4, p. 041029, 2019.
 - [23] A. Bisio, G. M. D’Ariano, P. Perinotti, and M. Sedlák, “Quantum learning algorithms for quantum measurements,” *Physics Letters A*, vol. 375, no. 39, pp. 3425–

- 3434, 2011.
- [24] M.-D. Choi, “Completely positive linear maps on complex matrices,” *Linear Algebra and its Applications*, vol. 10, no. 3, pp. 285–290, 1975.
- [25] A. Jamiolkowski, “Linear transformations which preserve trace and positive semidefiniteness of operators,” *Reports on Mathematical Physics*, vol. 3, no. 4, pp. 275–278, 1972.
- [26] A. Bisio, G. Chiribella, G. D’Ariano, and P. Perinotti, “Quantum networks: general theory and applications,” *Acta Physica Slovaca*, vol. 61, no. 3, pp. 273–390, 2011.
- [27] M. Studziński, S. Strelchuk, M. Mozrzyk, and M. Horodecki, “Port-based teleportation in arbitrary dimension,” *Scientific reports*, vol. 7, no. 1, pp. 1–11, 2017.
- [28] M. Mozrzyk, M. Studziński, S. Strelchuk, and M. Horodecki, “Optimal port-based teleportation,” *New Journal of Physics*, vol. 20, no. 5, p. 053006, 2018.
- [29] C. S. Mukherjee, S. Maitra, V. Gaurav, and D. Roy, “Preparing dicke states on a quantum computer,” *IEEE Transactions on Quantum Engineering*, vol. 1, pp. 1–17, 2020.
- [30] J. Fiurásek, M. Dušek, and R. Filip, “Universal measurement apparatus controlled by quantum software,” *Physical Review Letters*, vol. 89, no. 19, p. 190401, 2002.
- [31] N. Gisin and S. Popescu, “Spin flips and quantum information for antiparallel spins,” *Physical Review Letters*, vol. 83, no. 2, p. 432, 1999.
- [32] P. Gawron, D. Kurzyk, and Ł. Pawela, “QuantumInformation.jl—a julia package for numerical computation in quantum information theory,” *PLOS ONE*, vol. 13, p. e0209358, dec 2018.
- [33] B. O’Donoghue, E. Chu, N. Parikh, and S. Boyd, “Conic optimization via operator splitting and homogeneous self-dual embedding,” *Journal of Optimization Theory and Applications*, vol. 169, pp. 1042–1068, June 2016.
- [34] B. O’Donoghue, E. Chu, N. Parikh, and S. Boyd, “SCS: Splitting conic solver, version 3.2.1.” <https://github.com/cvxgrp/scs>, Nov. 2021.
- [35] <https://github.com/iitis/storage-and-retrieval-of-von-Neumann-measurements>. Permanent link to code/repository, Accessed: 2022-09-21.
- [36] J. Watrous, *The Theory of Quantum Information*. Cambridge University Press, 2018.

Appendix A: Proof of lower bound

Lemma 2. Let us fix $d \in \mathbb{N}$ and let \mathcal{L} be a parallel learning scheme based on the DPBT protocol introduced in Section III A. It holds that

$$\mathcal{F}_d^{\text{avg}}(\mathcal{L}) = 1 - \Theta\left(\frac{1}{N^2}\right). \quad (\text{A1})$$

Proof. Let $|\psi_0\rangle\langle\psi_0|$ and $\mathcal{Q}_0 = \{Q_{0,i}\}_{i=1}^N$ be a realization of the optimal teleportation strategy \mathcal{T}_0 , such that [15]

$$F_* = \frac{1}{d^2} \text{tr}(T_0 | \mathbb{1}_d\rangle\langle\mathbb{1}_d|) = 1 - \Theta\left(\frac{1}{N^2}\right). \quad (\text{A2})$$

Let us introduce the operations $\mathcal{Q}_{0,i}(\sigma) = \sqrt{Q_{0,i}}\sigma\sqrt{Q_{0,i}}$. Then, the approximation \mathcal{Q}_U acting on an arbitrary state ρ can be expressed as

$$\begin{aligned} \mathcal{Q}_U(\rho) &= \sum_{i=1}^N \text{tr}_{\mathcal{H}_d^{(in)} \otimes \mathcal{H}_{d^N}^{(A)} \otimes \mathcal{H}_{d^{N-1}}^{(B_i)}} ((\mathcal{Q}_{0,i} \otimes \mathcal{P}_U^{\otimes N})(\rho \otimes |\psi_0\rangle\langle\psi_0|)) \\ &= \mathcal{P}_U \left(\sum_{i=1}^N \text{tr}_{\mathcal{H}_d^{(in)} \otimes \mathcal{H}_{d^N}^{(A)} \otimes \mathcal{H}_{d^{N-1}}^{(B_i)}} ((\mathcal{Q}_{0,i} \otimes \mathcal{I}_{d^N})(\rho \otimes |\psi_0\rangle\langle\psi_0|)) \right) = \mathcal{P}_U(\mathcal{T}_0(\rho)). \end{aligned} \quad (\text{A3})$$

Let $J_\Delta = \sum_{i=0}^{d-1} |i\rangle\langle i| \otimes |i\rangle\langle i|$ be the Choi matrix of the completely dephasing channel Δ . By using the equality $\mathcal{F}_d(\mathcal{P}_U, \mathcal{Q}_U) = \frac{1}{d} \text{tr}(P_U Q_U)$ we obtain

$$\begin{aligned} \mathcal{F}_d^{\text{avg}}(\mathcal{L}) &= \frac{1}{d} \int_U dU \text{tr}(P_U Q_U) = \frac{1}{d} \int_U dU \text{tr}((U \otimes \bar{U}) J_\Delta (U \otimes \bar{U})^\dagger T_0) \\ &= \frac{1}{d} \text{tr} \left(\frac{1}{d+1} (\mathbb{1}_{d^2} + |\mathbb{1}_d\rangle\langle\mathbb{1}_d|) T_0 \right) = \frac{1}{d+1} + \frac{d}{d+1} F_* \\ &= 1 - \Theta\left(\frac{1}{N^2}\right), \end{aligned} \quad (\text{A4})$$

which completes the proof. \square

Appendix B: Proof of Lemma 1

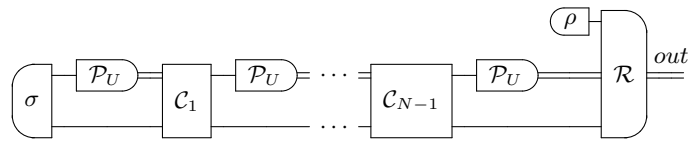

Figure 7: The schematic representation of a learning scheme $\mathcal{L} = (\sigma, \{\mathcal{C}_i\}_{i=1}^{N-1}, \mathcal{R})$.

Let $d = 2$ and let us fix $N \in \mathbb{N}$. In the $N \rightarrow 1$ learning scheme of single-qubit von Neumann measurements we have access to N copies of a given measurement \mathcal{P}_U , which is parameterized by some unitary matrix $U \in M(\mathcal{H}_2)$. Let us consider a general single-qubit von Neumann measurement learning scheme \mathcal{L} , which is depicted in Fig. 7. The Choi-Jamiolkowski representation of \mathcal{L} is given as $L = \sum_{i=0}^1 |i\rangle\langle i| \otimes L_i$, where $|i\rangle \in \mathcal{H}_2^{(out)}$. The result of composition of all copies of \mathcal{P}_U and the scheme \mathcal{L} is a measurement $\mathcal{Q}_U = \{Q_{U,0}, Q_{U,1}\}$, which is an approximation of \mathcal{P}_U . To define the effects $Q_{U,i}$ we use the link product [26] in the following way $\text{tr}(\rho Q_{U,i}) = \text{tr}(L_i^\top (\rho \otimes P_U^{\otimes N}))$ for $\rho \in \Omega(\mathcal{H}_2)$ and $i = 0, 1$. Thus, we can calculate the fidelity defined in Eq. (1) between \mathcal{P}_U and \mathcal{Q}_U

$$\mathcal{F}_2(\mathcal{P}_U, \mathcal{Q}_U) = \frac{1}{2} \sum_{i=0}^1 \text{tr}(P_{U,i} Q_{U,i}) = \frac{1}{2} \sum_{i=0}^1 \text{tr}[L_i^\top (P_{U,i} \otimes P_U^{\otimes N})]. \quad (\text{B1})$$

Finally, we can express the maximum value of the average fidelity function F_2 defined in Eq. (3) as

$$F_2 = \max_{\mathcal{L}} \int_U dU \frac{1}{2} \sum_{i=0}^1 \text{tr} [L_i^\top (P_{U,i} \otimes P_U^{\otimes N})]. \quad (\text{B2})$$

In the following subsections we will upper bound F_2 by using this simplified maximization formula.

1. Measurement learning via parallel storage of unitary transformations

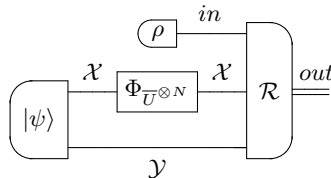

Figure 8: Schematic representation of the setup, which we use to upper bound F_2 . In this scenario, we are given N copies of unitary channel $\Phi_{\bar{U}}$ in parallel. Our objective is to approximate the von Neumann measurement \mathcal{P}_U .

In this section we consider a new learning scheme, presented in Fig. 8. In this scheme, we are given N copies of a unitary channel, $\Phi_{\bar{U}}$, which we can use in parallel. Our goal is to approximate the measurement \mathcal{P}_U using the black box with the unitary channel $\Phi_{\bar{U}}$ inside. To achieve this, we choose an initial memory state $|\psi\rangle \in \mathcal{X} \otimes \mathcal{Y}$ and a retrieval binary measurement $\mathcal{R} = \{R_0, R_1\}$, such that $R_i \in \mathcal{M}(\mathcal{Z} \otimes \mathcal{X} \otimes \mathcal{Y})$, where $\mathcal{Z} = \mathcal{H}_2^{(in)}$, $\mathcal{X} = \mathcal{H}_{2^N}$ and $\mathcal{Y} = \mathcal{H}_{2^N}$. We maximize the value of the average fidelity function, which will be denoted as \widetilde{F}_2 . To calculate \widetilde{F}_2 we may observe that for a given $\rho \in \Omega(\mathcal{Z})$, the probability that outcome i occurs is equal $\text{tr} \left(R_i \left(\rho \otimes (\bar{U}^{\otimes N} \otimes \mathbb{1}_a) |\psi\rangle\langle\psi| (U^{\top \otimes N} \otimes \mathbb{1}_a) \right) \right)$, where $a := 2^N$. Therefore, we obtain

$$\widetilde{F}_2 = \max_{\substack{\mathcal{R}=\{R_0, R_1\} \\ |\psi\rangle\langle\psi| \in \Omega(\mathcal{X} \otimes \mathcal{Y})}} \int_U dU \frac{1}{2} \sum_{i=0}^1 \text{tr} \left[R_i \left((U \otimes \bar{U}^{\otimes N} \otimes \mathbb{1}_a) (|i\rangle\langle i| \otimes |\psi\rangle\langle\psi|) (U^\dagger \otimes U^{\top \otimes N} \otimes \mathbb{1}_a) \right) \right]. \quad (\text{B3})$$

Lemma 3. Let F_2 be the fidelity function defined in Eq. (B2) and \widetilde{F}_2 be the fidelity function defined in Eq. (B3). Then, it holds that $F_2 \leq \widetilde{F}_2$.

Proof. First, we observe that each von Neumann measurement \mathcal{P}_U can be written as a composition of the completely dephasing channel Δ given by $\Delta(X) = \sum_{i=0}^1 |i\rangle\langle i| X |i\rangle\langle i|$, and a unitary channel Φ_{U^\dagger} . Equivalently, that means $\mathcal{P}_U = (\Delta \otimes \mathcal{I}_2) (|U^\dagger\rangle\langle U^\dagger|)$. Due to the fact that the channel Δ is self-adjoint, we obtain

$$\text{tr} [L_i^\top (P_{U,i} \otimes P_U^{\otimes N})] = \text{tr} \left[((\mathcal{I}_2 \otimes (\Delta \otimes \mathcal{I}_2)^{\otimes N}) (L_i))^\top \left(P_{U,i} \otimes |U^\dagger\rangle\langle U^\dagger|^{\otimes N} \right) \right]. \quad (\text{B4})$$

Note that $\sum_{i=0}^1 |i\rangle\langle i| \otimes (\mathcal{I}_2 \otimes (\Delta \otimes \mathcal{I}_2)^{\otimes N}) (L_i)$ represents the composition of the learning scheme \mathcal{L} and N copies of channels Δ . If we omit processing channels Δ , we get the following upper bound on F_2 defined in Eq. (B2)

$$\begin{aligned} F_2 &\leq \max_{\mathcal{L}} \int_U dU \frac{1}{2} \sum_{i=0}^1 \text{tr} \left[L_i^\top \left(P_{U,i} \otimes |U^\dagger\rangle\langle U^\dagger|^{\otimes N} \right) \right] \\ &= \frac{1}{2} \max_{\mathcal{L}} \int_U dU \text{tr} \left[L^\top \left((\mathbb{1}_2 \otimes U) J_\Delta (\mathbb{1}_2 \otimes U^\dagger) \otimes |U^\dagger\rangle\langle U^\dagger|^{\otimes N} \right) \right], \end{aligned} \quad (\text{B5})$$

where J_Δ is Choi-Jamiołkowski representation of Δ . Observe that the maximal value of the integral in above equation is achievable by networks \mathcal{L} which satisfy the following commutation relation

$$[L, \mathbb{1}_2 \otimes \bar{U} \otimes (\mathbb{1}_2 \otimes U)^{\otimes N}] = 0, \quad (\text{B6})$$

for any unitary matrix U . To argue this fact, for any \mathcal{L} one can define a learning network $\tilde{\mathcal{L}}$ given by

$$\tilde{L} = \int_U dU \left((\mathbb{1}_2 \otimes \bar{U}) \otimes (\mathbb{1}_2 \otimes U)^{\otimes N} \right) L \left((\mathbb{1}_2 \otimes U^\top) \otimes (\mathbb{1}_2 \otimes U^\dagger)^{\otimes N} \right). \quad (\text{B7})$$

It is not difficult to see that \tilde{L} is a correctly defined Choi-Jamiołkowski representation of a quantum learning network [26, Theorem 2.5], which satisfies the relation Eq. (B6). Moreover, for both L and \tilde{L} the value of the integral in Eq. (B5) remains the same.

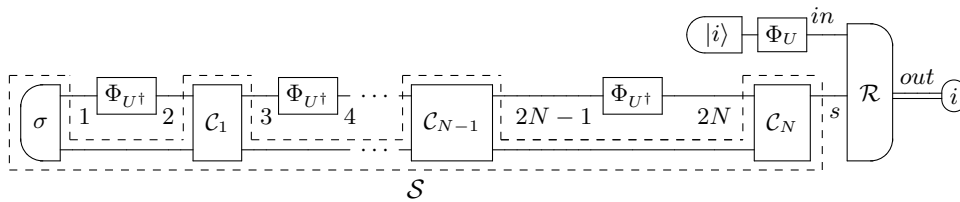

Figure 9: Schematic representations of the right-hand side of Eq. (B5). With probability $1/2$ we prepare one of basis states $|0\rangle$ or $|1\rangle$ and calculate the probability that we obtain output i . Eq. (B5) is then the cumulative probability that provided the state $|i\rangle\langle i|$ we measure i . The learning scheme \mathcal{L} is given as $\mathcal{L} = (\sigma, \{\mathcal{C}_i\}_{i=1}^N, \mathcal{R})$ and the storage \mathcal{S} (marked with a dashed line) is defined as a composition of an initial memory state σ and processing channels $\{\mathcal{C}_i\}_{i=1}^N$.

Let us divide \mathcal{L} into a storage network \mathcal{S} and a retrieval measurement \mathcal{R} , as shown in Fig. 9. We introduce the input space $\mathcal{X}_I := \bigotimes_{i=1}^N \mathcal{H}_2^{(2k)}$ (denoted with numbers $2, 4, \dots, 2N$ on Fig. 9) and the output space $\mathcal{X}_O := \bigotimes_{i=1}^N \mathcal{H}_2^{(2k-1)}$ (denoted with numbers $1, 3, \dots, 2N-1$). Additionally, we define spaces $\mathcal{H}_2^{(in)}, \mathcal{H}_2^{(out)}$ and \mathcal{H}_s . The space \mathcal{H}_s has arbitrary dimension s , but not smaller than the dimension of $\mathcal{X}_I \otimes \mathcal{X}_O$. The storage \mathcal{S} can be realized as a sequence of isometry channels followed by a partial trace operation [26, Theorem 2.6]. Therefore, by moving the partial trace operation to the retrieval part, \mathcal{R} , we may assume that the storage \mathcal{S} consists of an initial pure state followed by a sequence of isometry channels. In consequence, the Choi-Jamiołkowski matrix of \mathcal{S} has the form $S = |X\rangle\langle X|$. There exists an isometry $V \in M(\mathcal{H}_s, \mathcal{X}_I \otimes \mathcal{X}_O)$, such that $X = \sqrt{\text{tr}_{\mathcal{H}_s} S} V^\top$. In this notation, S is the solution of $S = (\mathbb{1}_{4N} \otimes V) |\sqrt{\text{tr}_{\mathcal{H}_s} S}\rangle\langle\sqrt{\text{tr}_{\mathcal{H}_s} S}| (\mathbb{1}_{4N} \otimes V)^\dagger$. Hence, the isometry channel $V \cdot V^\dagger$ can be treated as a postprocessing of the storage \mathcal{S} and also viewed as a part of the retrieval \mathcal{R} . In summary, after all changes, the storage \mathcal{S} is of the form $S = |\sqrt{\text{tr}_{\mathcal{H}_s} S}\rangle\langle\sqrt{\text{tr}_{\mathcal{H}_s} S}|$. By using the normalization property [26, Theorem 2.5] for the network presented in Fig. 9, we obtain $\text{tr}_{\mathcal{H}_2^{(out)}} L = \mathbb{1}_2 \otimes \text{tr}_{\mathcal{H}_s} S$. Therefore, using the property Eq. (B6) we have

$$[\text{tr}_{\mathcal{H}_s} S, (\mathbb{1}_2 \otimes U)^{\otimes N}] = 0. \quad (\text{B8})$$

Let us define the memory state $\sigma_{\Phi_{U^\dagger}, \mathcal{S}}$ as an application of the storage \mathcal{S} on N copies of Φ_{U^\dagger} . Then, we have

$$\begin{aligned} \sigma_{\Phi_{U^\dagger}, \mathcal{S}} &= \text{tr}_{\mathcal{X}_I \otimes \mathcal{X}_O} \left[|\sqrt{\text{tr}_{\mathcal{H}_s} S}\rangle\langle\sqrt{\text{tr}_{\mathcal{H}_s} S}| \left(|U^\top\rangle\langle U^\top|^{\otimes N} \otimes \mathbb{1}_{4N} \right) \right] \\ &= \text{tr}_{\mathcal{X}_I \otimes \mathcal{X}_O} \left[(\mathbb{1}_2 \otimes U^\dagger)^{\otimes N} \sqrt{\text{tr}_{\mathcal{H}_s} S} \rangle\langle\sqrt{\text{tr}_{\mathcal{H}_s} S} \left(|\mathbb{1}_2\rangle\langle\mathbb{1}_2|^{\otimes N} \otimes \mathbb{1}_{4N} \right) \right] \\ &= (\mathbb{1}_2 \otimes \bar{U})^{\otimes N} |\psi\rangle\langle\psi| (\mathbb{1}_2 \otimes U^\top)^{\otimes N}, \end{aligned} \quad (\text{B9})$$

where the last equality uses the property Eq. (B8) and introduced $|\psi\rangle := \left(|\mathbb{1}_2\rangle\langle\mathbb{1}_2|^{\otimes N} \otimes \mathbb{1}_{4N} \right) |\sqrt{\text{tr}_{\mathcal{H}_s} S}\rangle$. It means that an arbitrary storage strategy \mathcal{S} , which has access to N copies of a unitary channel Φ_{U^\dagger} can be replaced with parallel storage strategy of N copies of a unitary channel $\Phi_{\bar{U}}$. By exploiting this property to Eq. (B5) we obtain

$$\begin{aligned} F_2 &\leq \frac{1}{2} \max_{\mathcal{L}} \int_U dU \text{tr} \left[L^\top \left((\mathbb{1}_2 \otimes U) J_\Delta (\mathbb{1}_2 \otimes U^\dagger) \otimes |U^\dagger\rangle\langle U^\dagger|^{\otimes N} \right) \right] \\ &= \frac{1}{2} \max_{\mathcal{R}=\{R_0, R_1\}} \int_U dU \sum_{i=0}^1 \text{tr} [R_i (U |i\rangle\langle i| U^\dagger \otimes \sigma_{\Phi_{U^\dagger}, \mathcal{S}})] \\ &= \frac{1}{2} \max_{\substack{\mathcal{R}=\{R_0, R_1\} \\ |\psi\rangle\langle\psi| \in \Omega(\mathcal{X}_I \otimes \mathcal{X}_O)}} \int_U dU \sum_{i=0}^1 \text{tr} [R_i (U |i\rangle\langle i| U^\dagger \otimes (\mathbb{1}_2 \otimes \bar{U})^{\otimes N} |\psi\rangle\langle\psi| (\mathbb{1}_2 \otimes U^\top)^{\otimes N})] = \widetilde{F}_2. \end{aligned} \quad (\text{B10})$$

□

2. Objective function simplification

The aim of this section is to simplify the maximization of the fidelity function \widetilde{F}_2 defined in Eq. (B3). Let us consider a binary measurement $\mathcal{R} = \{R_0, R_1\}$ taken from the maximization domain in Eq. (B3). It holds that $R_0 + R_1 = \mathbb{1}_{2^{2N+1}}$, and hence we may write

$$\begin{aligned} \widetilde{F}_2 &= \max_{\substack{\mathcal{R}=\{R_0, R_1\} \\ |\psi\rangle\langle\psi| \in \Omega(\mathcal{X} \otimes \mathcal{Y})}} \int_U dU \frac{1}{2} \sum_{i=0}^1 \text{tr} \left[R_i \left((U \otimes \bar{U}^{\otimes N} \otimes \mathbb{1}_a) (|i\rangle\langle i| \otimes |\psi\rangle\langle\psi|) (U^\dagger \otimes U^{\top \otimes N} \otimes \mathbb{1}_a) \right) \right] \\ &= \frac{1}{2} + \frac{1}{2} \max_{\substack{\mathcal{R}=\{R_0, R_1\} \\ |\psi\rangle\langle\psi| \in \Omega(\mathcal{X} \otimes \mathcal{Y})}} \int_U dU \text{tr} \left[R_0 \left((U \otimes \bar{U}^{\otimes N} \otimes \mathbb{1}_a) (\sigma_z \otimes |\psi\rangle\langle\psi|) (U^\dagger \otimes U^{\top \otimes N} \otimes \mathbb{1}_a) \right) \right] \\ &= \frac{1}{2} + \frac{1}{2} \max_{\substack{\mathcal{R}=\{R_0, R_1\} \\ |\psi\rangle\langle\psi| \in \Omega(\mathcal{X} \otimes \mathcal{Y})}} \text{tr} \left[\int_U dU (U^\dagger \otimes U^{\top \otimes N} \otimes \mathbb{1}_a) R_0 (U \otimes \bar{U}^{\otimes N} \otimes \mathbb{1}_a) (\sigma_z \otimes |\psi\rangle\langle\psi|) \right], \end{aligned} \quad (\text{B11})$$

where $\sigma_z = |0\rangle\langle 0| - |1\rangle\langle 1|$. Observe that, taking the average value of the matrix R_0 over the unitary group $\{U \otimes \bar{U}^{\otimes N} \otimes \mathbb{1}_a\}_U$ is equivalent to taking R such that $0 \leq R \leq \mathbb{1}_{2^{2N+1}}$ and $[R, U \otimes \bar{U}^{\otimes N} \otimes \mathbb{1}_a] = 0$ for any qubit unitary matrix U . Equivalently, we may write $[R^{\top \mathcal{Z}}, U^{\otimes N+1} \otimes \mathbb{1}_a] = 0$, where $\cdot^{\top \mathcal{Z}}$ represents the partial transposition over subsystem \mathcal{Z} . According to [36, Theorem 7.15] the matrix $R^{\top \mathcal{Z}}$ commutes with $U^{\otimes N+1} \otimes \mathbb{1}_a$ if and only if it is of the form

$$R^{\top \mathcal{Z}} = \sum_{\pi} W_{\pi} \otimes M_{\pi}, \quad (\text{B12})$$

where matrices $W_{\pi} \in M(\mathcal{Z} \otimes \mathcal{X})$ represent subsystem permutation matrices acting on $N+1$ qubit systems, according to the equation

$$W_{\pi} |b_0, b_1, \dots, b_N\rangle = |b_{\pi(0)}, b_{\pi(1)}, \dots, b_{\pi(N)}\rangle, \quad b_k \in \{0, 1\}. \quad (\text{B13})$$

The matrices M_{π} belong to the set $M(\mathcal{Y})$ and the index π goes over all permutations of the set $\{0, \dots, N\}$. Hence, we may simplify calculation of \widetilde{F}_2

$$\widetilde{F}_2 = \frac{1}{2} + \frac{1}{2} \max_{\substack{R: 0 \leq R \leq \mathbb{1}_{2^{2N+1}} \\ R = \sum_{\pi} W_{\pi}^{\top \mathcal{Z}} \otimes M_{\pi} \\ |\psi\rangle\langle\psi| \in \Omega(\mathcal{X} \otimes \mathcal{Y})}} \text{tr} [R (\sigma_z \otimes |\psi\rangle\langle\psi|)]. \quad (\text{B14})$$

To simplify the calculation of \widetilde{F}_2 even further, we introduce the following notation of basis states defined on $N+1$ qubit system with fixed weight. We enumerate qubit subsystems with numbers $0, 1, \dots, N$. For any subset $A_k \subset \{1, \dots, N\}$, such that $|A_k| = k$ we define:

$$\mathcal{H}_{2^N} \ni |A_k\rangle := \bigotimes_{i=1}^N (\delta(i \in A_k) |1\rangle + \delta(i \notin A_k) |0\rangle). \quad (\text{B15})$$

Consider the following subspaces of the $N+1$ qubit space:

$$\mathcal{H}^{(k)} := \text{span}(|0\rangle |A_k\rangle, |1\rangle |A_{k+1}\rangle : A_k, A_{k+1} \subset \{1, \dots, N\}) \quad (\text{B16})$$

for $k = -1, \dots, N$, where the vectors exist if and only if the expression is well-defined (for instance, the vectors $|A_{-1}\rangle, |A_{N+1}\rangle$ do not exist). In this notation, subspaces $\mathcal{H}^{(k)}$ constitute a decomposition of $N+1$ qubit space, $\mathcal{H}_{2^{N+1}} = \bigoplus_{k=-1}^N \mathcal{H}^{(k)}$. One may observe, that the matrix R appearing in the maximization domain of Eq. (B14) is block diagonal in the introduced decomposition (in the partition $\mathcal{Z} \otimes \mathcal{X}/\mathcal{Y}$). For such retrieval R , let us consider

$$H_R = \text{tr}_{\mathcal{Z}} (R (\sigma_z \otimes \mathbb{1}_{4^N})). \quad (\text{B17})$$

Observe that the matrix H_R is block diagonal in the decomposition

$$\mathcal{H}_{2^N} = \bigoplus_{k=0}^N \text{span}(|A_k\rangle : A_k \subset \{1, \dots, N\}). \quad (\text{B18})$$

Hence, we will write H_R as

$$H_R = \bigoplus_{k=0}^N H_{R,k}. \quad (\text{B19})$$

Utilizing the above observations, the maximization problem Eq. (B14) can be written as

$$\begin{aligned} \widetilde{F}_2 &= \frac{1}{2} + \frac{1}{2} \max_{\substack{R: 0 \leq R \leq \mathbf{1} \\ R = \sum_{\pi} W_{\pi}^{\top Z} \otimes M_{\pi} \\ |\psi\rangle\langle\psi| \in \Omega(\mathcal{X} \otimes \mathcal{Y})}} \text{tr} [R(\sigma_z \otimes |\psi\rangle\langle\psi|)] = \frac{1}{2} + \frac{1}{2} \max_{\substack{R: 0 \leq R \leq \mathbf{1} \\ R = \sum_{\pi} W_{\pi}^{\top Z} \otimes M_{\pi} \\ |\psi\rangle\langle\psi| \in \Omega(\mathcal{X} \otimes \mathcal{Y})}} \langle\psi| H_R |\psi\rangle \\ &= \frac{1}{2} + \frac{1}{2} \max_{k=0, \dots, N} \max_{\substack{R: 0 \leq R \leq \mathbf{1} \\ R = \sum_{\pi} W_{\pi}^{\top Z} \otimes M_{\pi}}} \lambda_1(H_{R,k}) \end{aligned} \quad (\text{B20})$$

where $\lambda_1(\cdot)$ stands for the largest eigenvalue and we used shortcut $\mathbf{1} = \mathbb{1}_{2^{2N+1}}$. Finally, we observe that $H_R = -(\sigma_x^{\otimes N} \otimes \mathbb{1}_a) H_R (\sigma_x^{\otimes N} \otimes \mathbb{1}_a)$, where $\sigma_x = |0\rangle\langle 1| + |1\rangle\langle 0|$. It implies that $H_{R,k}$ is unitarily equivalent to $-H_{R,N-k}$ for any k . We use this fact to write the final simplification of \widetilde{F}_2 . The following lemma sums up all the considerations presented in this section.

Lemma 4. *For the fidelity function \widetilde{F}_2 defined in Eq. (B3) it holds that*

$$\widetilde{F}_2 = \frac{1}{2} + \frac{1}{2} \max_{k=0, \dots, \lfloor N/2 \rfloor} \max_{\substack{R: 0 \leq R \leq \mathbf{1} \\ R = \sum_{\pi} W_{\pi}^{\top Z} \otimes M_{\pi}}} \|H_{R,k}\|_{\infty}. \quad (\text{B21})$$

3. Technical lemmas

In the following lemma we will observe that optimization problem in Eq. (B21) can be reduced to the case $k \in \mathbb{N}$, $N = 2k$.

Lemma 5. *Let $N \in \mathbb{N}$ and take k , such that $k \leq N/2$. It holds that*

$$\max_{\substack{R: 0 \leq R \leq \mathbf{1} \\ R = \sum_{\pi} W_{\pi}^{\top Z} \otimes M_{\pi}}} \|H_{R,k}\|_{\infty} \leq \max_{\substack{\tilde{R}: 0 \leq \tilde{R} \leq \mathbf{1} \\ \tilde{R} = \sum_{\pi} \tilde{W}_{\pi}^{\top Z} \otimes \tilde{M}_{\pi}}} \|\tilde{H}_{\tilde{R}, N-k}\|_{\infty}, \quad (\text{B22})$$

where the matrix \tilde{R} is defined for $\tilde{N} = 2(N - k)$ and hence the number of systems on which the matrix \tilde{W}_{π} acts is $\tilde{N} + 1$.

Proof. Let us fix R such that $0 \leq R \leq \mathbf{1}$ and $R = \sum_{\pi} W_{\pi}^{\top Z} \otimes M_{\pi}$. Define

$$\tilde{R} := \sum_{\pi} (W_{\pi}^{\top Z} \otimes \mathbb{1}_{2^{N-2k}}) \otimes (M_{\pi} \otimes \mathbb{1}_{2^{N-2k}}). \quad (\text{B23})$$

We see that matrix \tilde{R} is in the maximization domain of the right-hand side of Eq. (B22). Then, we have $\tilde{H}_{\tilde{R}} = \text{tr}_Z(\tilde{R}(\sigma_z \otimes \mathbb{1})) = \bigoplus_l \tilde{H}_{\tilde{R}, l}$. The matrix $\tilde{H}_{\tilde{R}, N-k}$ is defined on the space spanned by the vectors $|A_{N-k}\rangle \in \mathcal{H}_{2^{\tilde{N}}}$ for $A_{N-k} \subset \{1, \dots, \tilde{N}\}$. These vectors can be expressed in the form $|A_{N-k}\rangle = |B_i\rangle |B_{N-k-i}\rangle$, where $|B_i\rangle \in \mathcal{H}_{2^N}$ for B_i such that $|B_i| = i$, $B_i \subset \{1, \dots, N\}$, and $|B_{N-k-i}\rangle \in \mathcal{H}_{2^{N-2k}}$, $B_{N-k-i} \subset \{N+1, \dots, \tilde{N}\}$. Then, we have

$$\langle\langle A_{N-k} | \otimes \mathbb{1} \rangle \tilde{H}_{\tilde{R}, N-k} (|A'_{N-k}\rangle \otimes \mathbb{1}) = \langle B_{N-k-i} | B'_{N-k-i'} \rangle (\langle B_i | \otimes \mathbb{1}) H_R (|B'_{i'}\rangle \otimes \mathbb{1}) \otimes \mathbb{1}. \quad (\text{B24})$$

The non-zero blocks exist if and only if $i = i'$ and $B_{N-k-i} = B'_{N-k-i'}$, so

$$\tilde{H}_{\tilde{R}, N-k} = \bigoplus_{i=k}^{N-k} \bigoplus_{\substack{B_{N-k-i}: \\ B_{N-k-i} \subset \{N+1, \dots, \tilde{N}\}}} H_{R,i} \otimes \mathbb{1}. \quad (\text{B25})$$

That means

$$\|\tilde{H}_{\tilde{R}, N-k}\|_\infty = \max_{i=k, \dots, N-k} \|H_{R,i}\|_\infty \geq \|H_{R,k}\|_\infty. \quad (\text{B26})$$

□

In the next lemma we will find the upper bound for Eq. (B21) in the case $N = 2k$ for $k \in \mathbb{N}$.

Lemma 6. *Let $k \in \mathbb{N}$ and $N = 2k$. For matrices R and $H_{R,k}$ defined in Subsection B 2 we have*

$$\max_{\substack{R: 0 \leq R \leq \mathbb{1} \\ R = \sum_{\pi} W_{\pi}^{\top z} \otimes M_{\pi}}} \|H_{R,k}\|_\infty \leq 1 - \Theta\left(\frac{1}{k^2}\right). \quad (\text{B27})$$

Proof. Let us fix R such that $0 \leq R \leq \mathbb{1}$ and $R = \sum_{\pi} W_{\pi}^{\top z} \otimes M_{\pi}$. Through the rest of the proof, by B_l we denote subsets of $\{1, \dots, 2k\}$, such that $|B_l| = l$, for $l = 0, \dots, 2k$. Following the notation introduced in Subsection B 2, we define four types of vectors:

1. $|+_{A_k}\rangle = x|0\rangle|A_k\rangle + \sum_{\substack{B_{k+1}: \\ |B_{k+1} \cap A_k| = k}} |1\rangle|B_{k+1}\rangle,$
2. $|-_{A_k}\rangle = x|1\rangle|A_k\rangle + \sum_{\substack{B_{k-1}: \\ |B_{k-1} \cap A_k| = k-1}} |0\rangle|B_{k-1}\rangle,$
3. $|\oplus_{A_k}\rangle = \sum_{\substack{B_{k+1}: \\ |B_{k+1} \cap A_k| = 1}} |1\rangle|B_{k+1}\rangle,$
4. $|\ominus_{A_k}\rangle = \sum_{\substack{B_{k-1}: \\ |B_{k-1} \cap A_k| = 0}} |0\rangle|B_{k-1}\rangle,$

for each $A_k \subset \{1, \dots, 2k\}$ and some $x > 0$. Now we define the following matrices:

1. $I_+ = \sum_{A_k} |+_{A_k}\rangle\langle A_k|,$
2. $I_- = \sum_{A_k} |-_{A_k}\rangle\langle A_k|,$
3. $I_{\oplus} = \sum_{A_k} |\oplus_{A_k}\rangle\langle A_k|,$
4. $I_{\ominus} = \sum_{A_k} |\ominus_{A_k}\rangle\langle A_k|.$

For arbitrary $A_k, A'_k \subset \{1, \dots, 2k\}$ we have

1. $\langle +_{A_k} | +_{A'_k} \rangle = x^2 \delta(A_k = A'_k) + |\{B_{k+1} : |B_{k+1} \cap A_k| = k, |B_{k+1} \cap A'_k| = k\}|,$
2. $\langle -_{A_k} | -_{A'_k} \rangle = x^2 \delta(A_k = A'_k) + |\{B_{k-1} : |B_{k-1} \cap A_k| = k-1, |B_{k-1} \cap A'_k| = k-1\}|,$
3. $\langle \oplus_{A_k} | \oplus_{A'_k} \rangle = |\{B_{k+1} : |B_{k+1} \cap A_k| = 1, |B_{k+1} \cap A'_k| = 1\}|,$
4. $\langle \ominus_{A_k} | \ominus_{A'_k} \rangle = |\{B_{k-1} : |B_{k-1} \cap A_k| = 0, |B_{k-1} \cap A'_k| = 0\}|.$

We can observe that if $A_k = A'_k$, then the above inner products are x^2+k, x^2+k, k, k , respectively. If $|A_k \cap A'_k| = k-1$ then all the inner products are equal to one. Finally, if $|A_k \cap A'_k| < k-1$ then we obtain all the inner products are equal to zero. We note two useful facts about matrices $I_+, I_-, I_{\oplus}, I_{\ominus}$. Firstly, we have

$$I_+^\dagger I_+ + I_{\oplus}^\dagger I_{\oplus} = I_-^\dagger I_- + I_{\ominus}^\dagger I_{\ominus}. \quad (\text{B28})$$

Secondly, one can show that

$$\|I_+^\dagger I_+ + I_{\oplus}^\dagger I_{\oplus}\|_\infty = x^2 + 2k + 2k^2. \quad (\text{B29})$$

As far as the first equality is straightforward, to show the second one, note that for each A_k there is exactly k^2 sets A'_k such that $|A_k \cap A'_k| = k - 1$. This means that by the Birkhoff's Theorem we can express $I_+^\dagger I_+ + I_\oplus^\dagger I_\oplus$ in the basis given by vectors $|A_k\rangle$ as $I_+^\dagger I_+ + I_\oplus^\dagger I_\oplus = (x^2 + 2k)\mathbb{1} + 2\sum_{i=1}^{k^2} \Pi_i$, where Π_i are permutation matrices. By the triangle inequality we have that the spectral norm is no greater than $x^2 + 2k + 2k^2$. By taking the normalized vector $|x\rangle \propto \sum_{A_k} |A_k\rangle$ we get $\langle x | (I_+^\dagger I_+ + I_\oplus^\dagger I_\oplus) | x \rangle = x^2 + 2k + 2k^2$.

To state the upper bound for $\|H_{R,k}\|_\infty$ we will use the definition of H_R from Eq. (B17) and the decomposition from Eq. (B19). For a given $A_k, A'_k \subset \{1, \dots, 2k\}$ we have that

$$(\langle A_k | \otimes \mathbb{1}_a) H_{R,k} (|A'_k\rangle \otimes \mathbb{1}_a) = \sum_{\substack{\pi: \\ \pi(A_k)=A'_k}} M_\pi - \sum_{\substack{\pi: \\ \pi(0, A_k)=0, A'_k}} M_\pi = \sum_{\substack{\pi: \\ \pi(0) \neq 0, \\ \pi(A_k)=A'_k}} M_\pi - \sum_{\substack{\pi: \\ \pi(0) \neq 0, \\ \pi(0, A_k)=0, A'_k}} M_\pi. \quad (\text{B30})$$

Let us now define

$$G_{R,k} = (I_+^\dagger \otimes \mathbb{1}_a) R(I_+ \otimes \mathbb{1}_a) + (I_\oplus^\dagger \otimes \mathbb{1}_a) R(I_\oplus \otimes \mathbb{1}_a) - (I_-^\dagger \otimes \mathbb{1}_a) R(I_- \otimes \mathbb{1}_a) - (I_\ominus^\dagger \otimes \mathbb{1}_a) R(I_\ominus \otimes \mathbb{1}_a). \quad (\text{B31})$$

Taking $A_k, A'_k \subset \{1, \dots, 2k\}$ we have:

$$\begin{aligned} & (\langle A_k | \otimes \mathbb{1}_a) G_{R,k} (|A'_k\rangle \otimes \mathbb{1}_a) \\ &= \left(\begin{aligned} & x^2 \sum_{\substack{\pi: \\ \pi(A_k)=A'_k}} M_\pi + x \sum_{\substack{B'_{k+1}, \pi: \\ |B'_{k+1} \cap A'_k|=k, \\ \pi(0, A_k)=B'_{k+1}}} M_\pi + x \sum_{\substack{B_{k+1}, \pi: \\ |B_{k+1} \cap A_k|=k, \\ \pi(B_{k+1})=0, A'_k}} M_\pi + \sum_{\substack{B_{k+1}, B'_{k+1}, \pi: \\ |B_{k+1} \cap A_k|=k, \\ |B'_{k+1} \cap A'_k|=k, \\ \pi(0, B_{k+1})=0, B'_{k+1}}} M_\pi + \sum_{\substack{B_{k+1}, B'_{k+1}, \pi: \\ |B_{k+1} \cap A_k|=1, \\ |B'_{k+1} \cap A'_k|=1, \\ \pi(0, B_{k+1})=0, B'_{k+1}}} M_\pi \end{aligned} \right) \\ &- \left(\begin{aligned} & x^2 \sum_{\substack{\pi: \\ \pi(0, A_k)=0, A'_k}} M_\pi + x \sum_{\substack{B'_{k-1}, \pi: \\ |B'_{k-1} \cap A'_k|=k-1, \\ \pi(A_k)=0, B'_{k-1}}} M_\pi + x \sum_{\substack{B_{k-1}, \pi: \\ |B_{k-1} \cap A_k|=k-1, \\ \pi(0, B_{k-1})=A'_k}} M_\pi + \sum_{\substack{B_{k-1}, B'_{k-1}, \pi: \\ |B_{k-1} \cap A_k|=k-1, \\ |B'_{k-1} \cap A'_k|=k-1, \\ \pi(B_{k-1})=B'_{k-1}}} M_\pi + \sum_{\substack{B_{k-1}, B'_{k-1}, \pi: \\ |B_{k-1} \cap A_k|=0, \\ |B'_{k-1} \cap A'_k|=0, \\ \pi(B_{k-1})=B'_{k-1}}} M_\pi \end{aligned} \right). \quad (\text{B32}) \end{aligned}$$

This can be simplified to

$$\begin{aligned} & (\langle A_k | \otimes \mathbb{1}_a) G_{R,k} (|A'_k\rangle \otimes \mathbb{1}_a) \\ &= \left(\begin{aligned} & x^2 \sum_{\substack{\pi: \\ \pi(A_k)=A'_k}} M_\pi + x \sum_{\substack{B'_{k+1}, \pi: \\ |B'_{k+1} \cap A'_k|=k, \\ \pi(0, A_k)=B'_{k+1}}} M_\pi + x \sum_{\substack{B_{k+1}, \pi: \\ |B_{k+1} \cap A_k|=k, \\ \pi(B_{k+1})=0, A'_k}} M_\pi \end{aligned} \right) \\ &- \left(\begin{aligned} & x^2 \sum_{\substack{\pi: \\ \pi(0, A_k)=0, A'_k}} M_\pi + x \sum_{\substack{B'_{k-1}, \pi: \\ |B'_{k-1} \cap A'_k|=k-1, \\ \pi(A_k)=0, B'_{k-1}}} M_\pi + x \sum_{\substack{B_{k-1}, \pi: \\ |B_{k-1} \cap A_k|=k-1, \\ \pi(0, B_{k-1})=A'_k}} M_\pi \end{aligned} \right). \quad (\text{B33}) \end{aligned}$$

Let us write the above as $(\langle A_k | \otimes \mathbb{1}_a) G_{R,k} (|A'_k\rangle \otimes \mathbb{1}_a) = \sum_\pi c_\pi M_\pi$, where c_π are some constants. For each π , let us determine the value of c_π :

- For π such that $\pi(0) = 0, \pi(A_k) = A'_k$ we have $c_\pi = x^2 - x^2 = 0$.
- For π such that $\pi(0) = 0, \pi(A_k) \neq A'_k$ we have $c_\pi = 0$.
- For π such that $\pi(0) \neq 0, \pi(A_k) = A'_k$ we have $c_\pi = x^2 + x + x = x^2 + 2x$.
- For π such that $\pi(0) \neq 0, \pi(A_k) \neq A'_k, \pi(0, A_k) \neq 0, A'_k$ there exists $a_0 \notin \{0\} \cup A_k$, such that $\pi(a_0) \in \{0\} \cup A'_k$. Therefore, we consider two sub-cases:
 - If for each $a \notin \{0\} \cup A_k$ it holds $\pi(a) \notin A'_k$, then $\pi(a_0) = 0, \pi(0) \in A'_k$ and $A'_k \subset \pi(0, A_k)$. Then, $c_\pi = x - x = 0$.
 - If $\pi(a_0) \in A'_k$, then we have two options:
 - * If $\pi(a_0, A_k) = 0, A'_k$, then $c_\pi = x - x = 0$.
 - * If $\pi(a_0, A_k) \neq 0, A'_k$, then $c_\pi = 0$.
- For π such that $\pi(0) \neq 0, \pi(0, A_k) = 0, A'_k$ we have $c_\pi = -x^2 - x - x = -(x^2 + 2x)$.

Therefore, we can see that $G_{R,k} = (x^2 + 2x)H_{R,k}$. Then, utilizing Eq. (B28), Eq. (B29) and Eq. (B31) we get

$$-(x^2 + 2k + 2k^2)\mathbb{1} \leq G_{R,k} \leq (x^2 + 2k + 2k^2)\mathbb{1}, \quad (\text{B34})$$

and finally we obtain $\|H_{R,k}\|_\infty \leq \frac{x^2 + 2k + 2k^2}{x^2 + 2x}$. Minimizing over $x > 0$, we get for $x \approx 2k^2$ that $\|H_{R,k}\|_\infty \leq 1 - \Theta(1/k^2)$, which finishes this case of the proof. \square

4. Proof of Lemma 1

Proof of Lemma 1. We have the following sequence of conclusions

$$\begin{aligned}
 F_2 &\leq \widetilde{F}_2 && \text{(by Eq. (B2), Eq. (B3), Lemma 3)} \\
 &= \frac{1}{2} + \frac{1}{2} \max_{k=0, \dots, \lfloor N/2 \rfloor} \max_{\substack{R: 0 \leq R \leq 1 \\ R = \sum_{\pi} W_{\pi}^{\top} Z \otimes M_{\pi}}} \|H_{R,k}\|_{\infty} && \text{(by Lemma 4)} \\
 &\leq \frac{1}{2} + \frac{1}{2} \max_{k=0, \dots, \lfloor N/2 \rfloor} \max_{\substack{\widetilde{R}: 0 \leq \widetilde{R} \leq 1 \\ \widetilde{R} = \sum_{\pi} \widetilde{W}_{\pi}^{\top} Z \otimes \widetilde{M}_{\pi}}} \|\widetilde{H}_{\widetilde{R}, N-k}\|_{\infty} && \text{(by Lemma 5)} \\
 &\leq \frac{1}{2} + \frac{1}{2} \max_{k=0, \dots, \lfloor N/2 \rfloor} 1 - \Theta\left(\frac{1}{(N-k)^2}\right) && \text{(by Lemma 6)} \\
 &= 1 - \Theta\left(\frac{1}{N^2}\right).
 \end{aligned}$$

\square

Appendix C: Proof of upper bound

Lemma 7. *The maximum value of the average fidelity function, defined in Eq. (3) is upper bounded by*

$$F_d \leq 1 - \Theta\left(\frac{1}{N^2}\right). \quad (\text{C1})$$

Proof. The thesis is true for $d = 2$ which follows from Lemma 1. Let us fix $d \in \mathbb{N}$. Take the optimal learning scheme \mathcal{L} such that it achieves $\mathcal{F}_d^{\text{avg}}(\mathcal{L}) = F_d$. Without loss of the generality we assume that \mathcal{L} satisfies

$$[L, \mathbb{1}_d \otimes U \otimes (\mathbb{1}_d \otimes \bar{U})]^{\otimes N} = 0 \quad (\text{C2})$$

for any unitary matrix $U \in \text{M}(\mathcal{H}_d)$. Then, for any U , we have

$$F_d = \mathcal{F}_d(\mathcal{P}_U, \mathcal{Q}_U) \leq \frac{d-1}{d} + \frac{1}{d} \min_i \text{tr}(P_{U,i} Q_{U,i}). \quad (\text{C3})$$

Moreover, for $j_1 \neq j_2$ it holds

$$\mathrm{tr}(P_{U,j_1} Q_{U,j_2}) \leq \mathrm{tr}(P_{U,j_1} (\mathbb{1}_d - Q_{U,j_1})) \leq 1 - \min_i \mathrm{tr}(P_{U,i} Q_{U,i}). \quad (\text{C4})$$

Now, we use \mathcal{L} to construct a new learning scheme \mathcal{L}' of qubit von Neumann measurements in the following way.

Let $\Pi \in M(\mathcal{H}_d)$ be a projector onto $|0\rangle, |1\rangle$ and define an isometry matrix $V = \sum_{i=0}^1 |i\rangle\langle i| \in M(\mathcal{H}_d, \mathcal{H}_2)$. Having access to unknown qubit von Neumann measurement \mathcal{P}_U we may use it to implement von Neumann measurement $\mathcal{P}_{U \oplus \mathbf{1}_{d-2}}$ acting on $\Omega(\mathcal{H}_d)$. To do that, we take $\sigma \in \Omega(\mathcal{H}_d)$ and measure it in the following way

$$|0\rangle\langle 0| \otimes \Pi \sigma \Pi + |1\rangle\langle 1| \otimes \sum_{i=2}^{d-1} \mathrm{tr}(\sigma |i\rangle\langle i|) |i\rangle\langle i|. \quad (\text{C5})$$

If on the first system we measure “0”, then we can project the state $V^\dagger(\Pi \sigma \Pi)V$ into $\Omega(\mathcal{H}_2)$ and measure it by using \mathcal{P}_U . Otherwise, we do nothing. As a result we implemented the measurement of the form

$$\sum_{i=0}^1 \mathrm{tr}(V^\dagger \sigma V U |i\rangle\langle i| U^\dagger) |i\rangle\langle i| + \sum_{i=2}^{d-1} \mathrm{tr}(\sigma |i\rangle\langle i|) |i\rangle\langle i| = \mathcal{P}_{U \oplus \mathbf{1}_{d-2}}(\sigma). \quad (\text{C6})$$

During the retrieval stage, we project the input state $\rho \in \Omega(\mathcal{H}_2)$ into $V \rho V^\dagger$. Moreover, as the output of \mathcal{L} is a classical label “0”, ..., “ $d-1$ ”, to finalize the construction of \mathcal{L}' , all the labels “1”, ..., “ $d-1$ ” are returned as “1”.

For a given unitary matrix $U \in M(\mathcal{H}_2)$ and the learning network \mathcal{L}' we may calculate

$$\begin{aligned} \mathcal{F}_2(\mathcal{P}_U, \mathcal{Q}_U) &= \frac{1}{2} (\mathrm{tr}(V P_{U,0} V^\dagger Q_{U \oplus \mathbf{1}_{d-2},0}) + \mathrm{tr}(V P_{U,1} V^\dagger (\mathbb{1}_d - Q_{U \oplus \mathbf{1}_{d-2},0}))) \\ &\geq \frac{1}{2} \min_i \mathrm{tr}(P_{U \oplus \mathbf{1}_{d-2},i} Q_{U \oplus \mathbf{1}_{d-2},i}) + \frac{1}{2} (1 - \mathrm{tr}(P_{U \oplus \mathbf{1}_{d-2},1} Q_{U \oplus \mathbf{1}_{d-2},0})) \\ &\geq \min_i \mathrm{tr}(P_{U \oplus \mathbf{1}_{d-2},i} Q_{U \oplus \mathbf{1}_{d-2},i}) \geq dF_d - (d-1). \end{aligned} \quad (\text{C7})$$

Therefore, we get

$$dF_d - (d-1) \leq \mathcal{F}_2^{\mathrm{avg}}(\mathcal{L}') \leq F_2 \leq 1 - \Theta\left(\frac{1}{N^2}\right), \quad (\text{C8})$$

which ends the proof. \square

Appendix D: Pretty good learning scheme

The pretty good learning scheme $\mathcal{L}_{PGLS} = (\sigma, \{\mathcal{C}_i\}_{i=1}^{N-1}, \mathcal{R})$ consists of the initial state σ , which is a tensor product of N copies of the maximally entangled state $|\omega\rangle = \frac{1}{\sqrt{2}} |\mathbb{1}_2\rangle$, processing channels $\{\mathcal{C}_i\}_{i=1}^{N-1}$ that are responsible for majority voting (see Section IV A) and the measurement $\mathcal{R} = \{R, \mathbb{1} - R\}$. To construct the effect R , we fix $N_0 \in \mathbb{N}$ and take $n = N_0 - 1$. Let us define

$$s_n(k, m) := \sum_{i=0}^k \sum_{j=0}^{n-k} \delta_{i+j-m} \binom{k}{i} \binom{n-k}{j} (-1)^{n-k-j}, \quad (\text{D1})$$

being the convolution of binomial coefficients. We consider the effect R of the form

$$\begin{aligned} R &= \sum_{k=0}^n |R_k\rangle\langle R_k|, \quad \text{such that } |R_k\rangle = \frac{|M_k\rangle}{\|M_k\|_2}, \\ \mathbb{M}(\mathcal{H}_2, \mathcal{H}_{2^{n+1}}) \ni M_k &= \sum_{m=0}^{n+1} \frac{s_n(k, n-m) |0\rangle + s_n(k, n+1-m) |1\rangle}{\sqrt{\binom{n+1}{m}}} \langle D_m^{n+1}|, \end{aligned} \quad (\text{D2})$$

for $k = 0, \dots, n$.

Lemma 8. Let $|x\rangle = \begin{bmatrix} a \\ b \end{bmatrix}$, $a, b \in \mathbb{C}$. Then, we have $M_k |x\rangle^{\otimes n+1} = (a+b)^k (a-b)^{n-k} |x\rangle$.

Proof. Direct calculations reveal

$$\begin{aligned} M_k |x\rangle^{\otimes n+1} &= \begin{bmatrix} \sum_{m=0}^n \binom{n+1}{n-m} \cdot \frac{s_n(k,m)}{\binom{n+1}{n-m}} a^{m+1} b^{n-m} \\ \sum_{m=0}^n \binom{n+1}{n+1-m} \cdot \frac{s_n(k,m)}{\binom{n+1}{n+1-m}} a^m b^{n+1-m} \end{bmatrix} = \sum_{m=0}^n s_n(k,m) a^m b^{n-m} |x\rangle \\ &= (a+b)^k (a-b)^{n-k} |x\rangle. \end{aligned} \quad (\text{D3})$$

□

To prove that R is a valid effect, let us now define

$$M := [s_n(k, m)]_{k,m=0}^n \quad (\text{D4})$$

and a diagonal matrix

$$D := \sum_{m=0}^n \frac{1}{\binom{n}{m}} |m\rangle\langle m|. \quad (\text{D5})$$

Lemma 9. With the notation given above, it holds that $M^2 = 2^n \mathbf{1}_{n+1}$.

Proof. First, observe that $\mathbb{C}^{n+1} = \text{span}([x^k]_{k=0}^n : x \in \mathbb{C})$. Let us take any vector of the form $|x\rangle := [x^k]_{k=0}^n$, where $x \in \mathbb{C}$. We have

$$M |x\rangle = \left[\sum_{m=0}^n s_n(k, m) x^m \right]_{k=0}^n = [(x+1)^k (x-1)^{n-k}]_{k=0}^n = (x-1)^n \left[\left(\frac{x+1}{x-1} \right)^k \right]_{k=0}^n. \quad (\text{D6})$$

Finally, we calculate

$$M^2 |x\rangle = (x-1)^n \left(\frac{x+1}{x-1} - 1 \right)^n \left[\left(\frac{\frac{x+1}{x-1} + 1}{\frac{x+1}{x-1} - 1} \right)^k \right]_{k=0}^n = 2^n |x\rangle. \quad (\text{D7})$$

□

Lemma 10. Using the notation presented above, we have the following equation $MD = (MD)^\top$.

Proof. We will show that $\langle k | MD | m \rangle = \langle m | MD | k \rangle$ for any $m, k = 0, \dots, n$. W.l.o.g. we can assume that $k < m$. On the one hand, it holds that

$$\begin{aligned} \langle k | MD | m \rangle &= \frac{s_n(k, m)}{\binom{n}{m}} = \sum_{\substack{i=0, \dots, k \\ j=0, \dots, n-k \\ i+j=m}} \frac{(-1)^{n-k-j} \binom{k}{i} \binom{n-k}{j}}{\binom{n}{m}} = \sum_{i=\max(0, m+k-n)}^k \frac{(-1)^{n-k-m+i} \binom{k}{i} \binom{n-k}{m-i}}{\binom{n}{m}} \\ &= (-1)^{n-k-m} \sum_{i=\max(0, m+k-n)}^k (-1)^i \frac{k! m! (n-k)! (n-m)!}{n! i! (k-i)! (m-i)! (n-k-m+i)!}. \end{aligned} \quad (\text{D8})$$

On the other hand, we can calculate

$$\begin{aligned} \langle m | MD | k \rangle &= \frac{s_n(m, k)}{\binom{n}{k}} = \sum_{\substack{i=0, \dots, m \\ j=0, \dots, n-m \\ i+j=k}} \frac{(-1)^{n-m-j} \binom{m}{i} \binom{n-m}{j}}{\binom{n}{k}} = \sum_{i=\max(0, m+k-n)}^k \frac{(-1)^{n-k-m+i} \binom{m}{i} \binom{n-m}{k-i}}{\binom{n}{k}} \\ &= (-1)^{n-k-m} \sum_{i=\max(0, m+k-n)}^k (-1)^i \frac{k! m! (n-k)! (n-m)!}{n! i! (k-i)! (m-i)! (n-k-m+i)!}, \end{aligned} \quad (\text{D9})$$

which gives us the desired equality and completes the proof. □

Lemma 11. *The operator R defined in Eq. (D2) satisfies $0 \leq R \leq \mathbb{1}_{2^{n+2}}$ and therefore $\mathcal{R} = \{R, \mathbb{1} - R\}$ is a valid POVM.*

Proof. Let us fix $N_0 \in \mathbb{N}$ and take $n = N_0 - 1$. Let us consider a matrix $X := \frac{n+2}{n+1}MDM^\top$. On the one hand, by using Lemma 9 and Lemma 10, we get

$$X = \frac{n+2}{n+1}(MD)^\top M^\top = \frac{n+2}{n+1}D(M^2)^\top = \frac{n+2}{n+1}2^n D. \quad (\text{D10})$$

On the other hand, we have

$$\begin{aligned} \text{tr} \left(M_k^\dagger M_{k'} \right) &= \sum_{m=0}^n \frac{s_n(k, m)s_n(k', m)}{\binom{n+1}{n-m}} + \sum_{m=0}^n \frac{s_n(k, m)s_n(k', m)}{\binom{n+1}{n+1-m}} \\ &= \sum_{m=0}^n s_n(k, m)s_n(k', m) \left[\frac{1}{\binom{n+1}{n-m}} + \frac{1}{\binom{n+1}{n-m+1}} \right] \\ &= \frac{n+2}{n+1} \sum_{m=0}^n \frac{s_n(k, m)s_n(k', m)}{\binom{n}{m}} = \langle k | X | k' \rangle. \end{aligned} \quad (\text{D11})$$

Therefore, for all $k \neq k'$ we get $\text{tr} \left(M_k^\dagger M_{k'} \right) = 0$. According to the definition Eq. (D2), we get $\langle R_k | R_{k'} \rangle = \delta_{k, k'}$, which gives us $0 \leq R \leq \mathbb{1}_{2^{n+2}}$. \square

Lemma 12. *Let us fix $N_0 \in \mathbb{N}$. The approximation $\mathcal{Q}_U = \{Q_{U,0}, \mathbb{1}_2 - Q_{U,0}\}$ of the von Neumann measurement \mathcal{P}_U obtained in the pretty good learning scheme is of the form*

$$Q_{U,0} = \frac{N_0}{N_0 + 1} P_{U,0}. \quad (\text{D12})$$

Proof. Given a unitary matrix U we take $P_{U,0} = |x\rangle\langle x|$ for some unit vector $|x\rangle \in \mathcal{H}_2$. Let us decompose the $(n+2)$ -qubit space in the following way $\mathcal{H}_{2^{n+2}} = \mathcal{Z} \otimes \mathcal{X}$, where $\mathcal{Z} = \mathcal{H}_2$ and $\mathcal{X} = \mathcal{H}_{2^{n+1}}$. In the proof of Lemma 11 we defined the matrix $X = \frac{n+2}{n+1}MDM^\top$ and showed that $X = \frac{n+2}{n+1}2^n D$, and $\text{tr} \left(M_k^\dagger M_{k'} \right) = \langle k | X | k' \rangle$. Therefore, for any $k = 0, \dots, n$ we have $\|M_k\|_2^2 = \frac{n+2}{n+1} \frac{2^n}{\binom{n}{k}}$. Due to this fact and by Lemma 8, we may express the effect $Q_{U,0}$ as

$$\begin{aligned} Q_{U,0} &= \text{tr}_{\mathcal{X}} \left(\left(\mathbb{1}_2 \otimes \overline{P_{U,0}}^{\otimes n+1} \right) R \right) = \left(\mathbb{1}_2 \otimes \overline{|x\rangle}^{\otimes n+1} \right) R \left(\mathbb{1}_2 \otimes |x\rangle^{\otimes n+1} \right) = \sum_{k=0}^n \frac{1}{\|M_k\|_2^2} M_k |x\rangle\langle x|^{\otimes n+1} M_k^\dagger \\ &= \sum_{k=0}^n \frac{1}{\|M_k\|_2^2} |a + b|^{2k} |a - b|^{2(n-k)} |x\rangle\langle x| = \frac{n+1}{n+2} \sum_{k=0}^n \frac{\binom{n}{k}}{2^n} |a + b|^{2k} |a - b|^{2(n-k)} |x\rangle\langle x| \\ &= \frac{n+1}{n+2} \frac{(|a + b|^2 + |a - b|^2)^n}{2^n} |x\rangle\langle x| = \frac{n+1}{n+2} |x\rangle\langle x|, \end{aligned} \quad (\text{D13})$$

which completes the proof. \square