

Computing Light-Front Wave Functions Without Light-Front Quantization: A Large-Momentum Effective Theory Approach

Xiangdong Ji^{1,2,*} and Yizhuang Liu^{3,†}

¹*Center for Nuclear Femtography, SURA, 1201 New York Avenue. NW, Washington, DC 20005, USA*

²*Maryland Center for Fundamental Physics, Department of Physics,
University of Maryland, College Park, Maryland 20742, USA*

³*Institute of Theoretical Physics, Jagiellonian University, 30-348 Kraków, Poland*

(Dated: June 11, 2021)

Light-front wave functions play a fundamental role in the light-front quantization approach to QCD and hadron structure. However, a naive implementation of the light-front quantization suffers from various subtleties including the well-known zero-mode problem, the associated rapidity divergences which mixes ultra-violet divergences with infrared physics, as well as breaking of spatial rotational symmetry. We advocate that the light-front quantization should be viewed as an effective theory in which small k^+ modes have been effectively “integrated out”, with an infinite number of renormalization constants. Instead of solving light-front quantized field theories directly, we make the large momentum expansion of the equal-time Euclidean correlation functions in instant quantization as an effective way to systematically calculate light-front correlations, including the light-front wave function amplitudes. This large-momentum effective theory accomplishes an effective light-front quantization through lattice QCD calculations. We demonstrate our approach using an example of a pseudo-scalar meson wave function.

I. INTRODUCTION

Light-front (LF) quantization (LFQ) or formalism is a natural language for parton physics in which partons are made manifest in all stages of calculations. The goal of the Hamilton formulation of LFQ is to solve non-perturbative quantum chromodynamics (QCD) just like a non-relativistic quantum mechanical system, i.e., diagonalizing the Hamiltonian and obtaining the wave-functions for the QCD bound states [1],

$$\hat{P}^- |\Psi_n\rangle = \frac{M_n^2}{2P^+} |\Psi_n\rangle \quad (1)$$

where P^+ is the LF momentum (see Eq. (5) below for light-front coordinate definition) and \hat{P}^- is the LF Hamiltonian, and M_n and $|\Psi_n\rangle$ are a hadron mass and wave function, respectively. Then all the partonic densities and correlations functions may be calculated as the expectation values of the LF wave-functions (LFWF). Moreover, like in condensed matter physics, knowing quantum many-body wave-functions allows one to understand interesting aspects of quantum coherence and entanglement, as well as the fundamental nature of quantum systems. Therefore, a practical realization of LFQ program clearly would be a big step forward in understanding the fundamental structure of hadrons, particularly the nucleon (proton and neutron), which are the fundamental building blocks of visible matter.

To be sure, wave-functions for the hadron bound states are not the most natural objects in quantum field theory

(QFT) due to the non-trivial QCD vacuum, ultra-violet (UV) divergences as well as Lorentz symmetry, according to the latter the space and time shall be treated on the equal footing. The proton and other hadrons are excitations of the QCD vacuum which by themselves are very complicated because of the well-known phenomena of chiral symmetry breaking and color confinement. To build a proton on the top of this vacuum, one naturally has a question about what part of the wave-function reflects the property of the bound state and what reflects the QCD vacuum: It is the difference which yields the properties of the proton that are experimentally measurable. There is no clean way to make this separation unless one builds the proton out of elementary excitations or quasi-particles that do not exist in the vacuum, as often have been done in condensed matter systems.

The parton degrees of freedom in the infinite momentum frame (IMF) fulfill the above purpose to some degree. Due to the kinematic effects, all partons in the vacuum have longitudinal momentum $k^+ = 0$, and to some degree of accuracy (incorrect for higher-twist observables as we will discuss), the proton is made of partons with $k^+ \neq 0$. This separation of degrees of freedom is particularly welcome, making a wave-function description of the proton more natural and interesting than in any other frame. Moreover, one can impose an infrared (IR) cut-off on the $k^+ \geq \epsilon$ in the effective Hilbert space, such that all physics below $k^+ = \epsilon$ are taken into account through renormalization procedures. The result is an effective LF theory with “trivial” vacuum,

$$a_{k\lambda}|0\rangle = b_{p\sigma}|0\rangle = d_{p\sigma}|0\rangle = 0. \quad (2)$$

where $|0\rangle$ is the vacuum of QCD, $a_{k\lambda}$ is an annihilation operator for a gluon with momentum k and polarization λ , and similarly the annihilation operators $b_{p\sigma}$ and $d_{p\sigma}$ for quark and anti-quarks. Therefore schematically one

* xji@umd.edu

† yizhuang.liu@uj.edu.pl

can write down the Fock-space expansion for the proton state in LF gauge $A^+ = 0$,

$$|P\rangle = \sum_{n=1}^{\infty} \int d\Gamma_n \psi_n(x_i, \vec{k}_{i\perp}) \prod a_i^\dagger(x_i, \vec{k}_{i\perp}) |0\rangle. \quad (3)$$

where we use the generic notation a^\dagger to denote quarks and gluon quanta on the LF, the phase-space integral reads $d\Gamma_n = \prod \frac{dk_i^+ d^2 k_{i\perp}}{2k_i^+ (2\pi)^3}$, with $x_i = k_i^+/P^+$, $\psi_n(x_i, \vec{k}_{i\perp})$ are LFWF or LFWF amplitudes or simply LF amplitudes. The latter are a complete set of non-perturbative quantities which describe the partonic landscape of the proton.

The nature of QCD vacuum in LFQ has been continuously debated in the literature. One knows a priori that in relativistic QFT, the vacuum state is boost-invariant and frame independent, and hence it shall be independent of quantization formalism. In fact, it have been proved in Ref. [2, 3] that not only the non-trivial QFT vacuum can not be simple, not all Green's functions of the theory can not poses generic meaningful restrictions to the null-planes $\xi^+ = \text{constant}$. Therefore, zero modes do contain non-trivial dynamics and contribute to the high-twist properties of the proton, such as mass and transverse spin [4]. As we explain in the next section, an effective theory view of LFQ simply cuts off the zero-mode complication and relegates these physics to renormalization constants, although in some cases, the zero-modes can be treated explicitly in the literature [5, 6].

With the above caveat, it is possible to invert the LF quantum state, by express the LFWFs in terms of invariant matrix element amplitudes,

$$\psi_n(x_i, \vec{k}_{i\perp}) = \langle 0 | \prod a_i(x_i, \vec{k}_{i\perp}) | P \rangle. \quad (4)$$

By properly restoring gauge-invariance through LF gauge links $\exp(ig \int A^+ d\lambda)$ and imposing regularizations, the above amplitudes can be calculated not only in LF theory but can also be accessed through the large momentum effective theory (LaMET) approach [7–10]. Therefore, one can actually obtain a LF picture of the proton without going through the explicit LFQ, or one can effectively obtain the results of LFQ through instant quantization at a large momentum frame.

The LFWFs also naturally arise in high-energy processes. For exclusive processes [11, 12], one usually probe a given Fock component and the non-perturbative distributions for these components are exactly LFWFs and the \vec{k}_\perp integrated LFWF or the Distribution Amplitude (DA). They have been applied to various form factors such as the pion electro-magnetic form factor [13, 14], the proton form factors [15–18] and exclusive processes such as B decays [11, 12, 19, 20]. A good introduction to hadronic form factors in perturbative QCD is given in [21].

In this paper, we will show how the generic rapidity-renormalized LFWFs can be obtained from LaMET in a

way similar to the transverse-momentum dependent parton distribution functions (TMDPDFs) [22]. The organization of the paper is as follows. In Sec.II, we review the LF quantization and its conceptual difficulties, especially the rapidity divergences. We emphasise that there is an implicit infinite rapidity limit behind the LF quantization which adds additional transcendentality to LF formulation of QFT in comparison to the equal time formulation. Due to the effective theory nature of LFQ, the rapidity divergences appear in a way similar to the emergence of UV divergences in the continuum limit and require a proper treatment. In the LF formulation, however, it is very difficult to regulate the rapidity divergence consistently due to breaking of Lorentz invariance. We argue that it is simpler to stay in the instant-quantized theory and treat the LF quantities as gauge-invariant correlation functions with rapidity regulators. In the spirit of LaMET, using rapidities of external states as physical off-light-cone regulator, one can obtain the LF quantities without LF quantization.

In Sec.III, we formulate LFWF amplitudes as gauge-invariant correlation functions with light-like gauge-links attached to maintain gauge invariance. These gauge-links lead to rapidity divergences which must be regularized using rapidity regulators. The naive LFWF amplitudes depend on these regulators and contain additional soft contributions. We introduce the generalized soft functions to remove these additional soft contributions and define the physical LFWF amplitudes that can be used in factorization theorems.

In Sec.IV, we present the LaMET formulation of LFWF amplitudes. We first introduce the quasi-LFWF amplitudes defined similar to the quasi parton distribution functions (PDF) and quasi-TMDPDF. The large hadron momentum P^z plays the role of a physical off-light-cone regulator. At large P^z , the quasi-LFWF amplitudes can be matched to the physical LFWF amplitudes with the help of reduced soft functions. We introduce the generalized off-light-cone soft function and present the factorization theorem of quasi-WF amplitudes. A sketch of its proof is included. As an application of the factorization formula, we show that the Collins-Soper (CS) rapidity evolution kernels can be extracted from ratio of quasi-WF amplitudes in which the soft function contribution cancels.

In Sec. V, we use the leading LFWF amplitude of a pseudo-scalar meson as an example to demonstrate to illustrate the large momentum expansion formalism. And we conclude the paper in Sec. VI.

II. PARTONS AND LIGHT-FRONT QUANTIZATION AS EFFECTIVE THEORY

Partons are an idealized concept which has been motivated from high-energy scattering, in which the constituents of hadrons all travel collinearly at large momenta, which can be taken to the limit of infinity on

the scale of the strong interaction scale Λ_{QCD} . These are specialized modes of QCD whose dynamics can be described by an effective theory of soft and collinear degrees of freedom from which the individual hadrons can be constructed. By choosing a particular direction of collinear modes, one can construct a Hamiltonian formulation of the theory, which has been called light-front quantization. In this view, LFQ of a theory is actually an effective theory, just like the heavy quark effective theory in which a particular set of modes is selected to describe the quark of infinite mass. As such, the LFQ cannot describe well the soft-gluon physics at very small k^+ which are part of the hadrons.

In this section, we will review the standard formalism of the light-front quantization and explain why one shall take the view that it is an effective theory of QCD and hadron structure.

A. Basics of Light-Front Quantization

As early as 1949, Dirac had advocated three forms of dynamics, with light-front being one of them [23]. In light-front theory, one defines two coordinates,

$$\xi^\pm = (\xi^0 \pm \xi^3)/\sqrt{2}, \quad (5)$$

where ξ^+ is the light-front ‘‘time’’, and ξ^- is the light-front ‘‘spatial coordinate’’. And any four-vector A^μ will be now written as $(A^+, A^-, \vec{A}_\perp)$. Dynamical degrees of freedom are defined on the $\xi^+ = 0$ plane with arbitrary ξ^- and $\vec{\xi}_\perp$, with conjugate momentum k^+ and \vec{k}_\perp . Dynamics is generated by light-cone Hamiltonian $H_{\text{LC}} = P^-$. For a free particle, with 3-momentum (k^+, \vec{k}_\perp) , the on-shell LF energy is $k^- = (\vec{k}_\perp^2 + m^2)/2k^+$.

For theories like QCD, the dynamical degrees of freedoms are defined as ψ_+ and A_\perp . Defining Dirac matrices $\gamma^\pm = 1/\sqrt{2}(\gamma^0 \pm \gamma^3)$, the projection operators for Dirac fields are defined as $P_\pm = (1/2)\gamma^\mp \gamma^\pm$. Any Dirac field ψ can be decomposed into $\psi = \psi_+ + \psi_-$ with $\psi_\pm = P_\pm \psi$, and ψ_+ is considered as a dynamical degree of freedom. For the gauge field, A^+ is fixed by choosing the LF gauge $A^+ = 0$ and \vec{A}_\perp are dynamical degrees of freedom. The physics of the LF correlation becomes manifest if one introduces the LF quantization conditions for dynamical fields

$$\{\psi_+^\dagger(\vec{\xi}), \psi_+(0)\} = P_+ \delta^3(\vec{\xi}), \quad (6)$$

$$[A^i(\vec{\xi}), \partial^+ A^j(0)] = \frac{i}{2} \delta^{ij} \delta^3(\vec{\xi}), \quad (7)$$

where three-vectors and delta-functions are all in the sense of LF coordinates. To solve the commutator relation, one starts with the canonical expansion,

$$\begin{aligned} \psi_+(\xi^+ = 0, \xi^-, \xi_\perp) &= \int \frac{d^2 k_\perp}{(2\pi)^3} \frac{dk^+}{2k^+} \sum_\sigma \left[b_\sigma(k) u(k\sigma) \right. \\ &\times e^{-i(k^+ \xi^- - \vec{k}_\perp \cdot \vec{\xi}_\perp)} + d_\sigma^\dagger(k) v(k\sigma) e^{i(k^+ \xi^- - \vec{k}_\perp \cdot \vec{\xi}_\perp)} \left. \right], \quad (8) \end{aligned}$$

where $b^\dagger(b)$ and $d^\dagger(d)$ are quark and antiquark creation (annihilation) operators, respectively. We adopt covariant normalization for the particle states and the creation and annihilation operators, i.e.,

$$\begin{aligned} \{b_\sigma(k), b_{\sigma'}^\dagger(k')\} &= \{d_\sigma(k), d_{\sigma'}^\dagger(k')\} \\ &= (2\pi)^3 \delta_{\sigma\sigma'} 2k^+ \delta(k^+ - k'^+) \delta^{(2)}(\vec{k}_\perp - \vec{k}'_\perp), \quad (9) \end{aligned}$$

where σ is the light-cone helicity of the quarks which can take $+1/2$ or $-1/2$. We ignore the masses of the light up and down quarks.

Likewise, for the gluon fields in the light-cone gauge $A^+ = 0$, \vec{A}_\perp is dynamical and has the expansion,

$$\begin{aligned} \vec{A}_\perp(\xi^+ = 0, \xi^-, \xi_\perp) &= \int \frac{d^2 k_\perp}{(2\pi)^3} \frac{dk^+}{2k^+} \\ &\times \sum_\lambda \left[a_\lambda(k) \vec{\epsilon}_\lambda(k) e^{-i(k^+ \xi^- - \vec{k}_\perp \cdot \vec{\xi}_\perp)} + \text{h.c.} \right]. \quad (10) \end{aligned}$$

And we have the following covariant normalization for the creation and annihilation operators for gluon,

$$[a_\lambda(k), a_{\lambda'}^\dagger(k')] = (2\pi)^3 \delta_{\lambda\lambda'} 2k^+ \delta(k^+ - k'^+) \delta^{(2)}(\vec{k}_\perp - \vec{k}'_\perp). \quad (11)$$

Implicitly, the gauge fields A^μ is a traceless 3×3 matrix with $A^\mu = \sum_a A^{a\mu} T^a$, where T^a are the $SU(3)$ Gell-Mann matrices satisfying $[T^a, T^b] = if^{abc} T^c$ and $\{T^a, T^b\} = \frac{1}{3} \delta_{ab} + d_{abc} T^c$, where f^{abc} and d^{abc} are the group constants.

Given ψ_+ and \vec{A}_\perp , using equation of motions ψ_- and A^- can be expressed in terms of ψ_+ and A_\perp [24]. In terms of these light-cone free fields, the LF Hamiltonian can be decomposed into a free part $H_{\text{LC}}^{\text{free}}$ and an interaction part $V + V_{\text{instan}}$

$$\begin{aligned} H_{\text{LC}} &= \int d\xi^- d^2 \vec{\xi}_\perp T^{-+}(\xi^+ = 0, \xi^-, \vec{\xi}_\perp), \\ &= H_{\text{LC}}^{\text{free}} + V + V_{\text{inst}}, \quad (12) \end{aligned}$$

where $H_{\text{LC}}^{\text{free}}$ is the free kinematic energy on the light-cone, and the interaction V contains the standard quark-gluon vertex and the 3-gluon, 4-gluon interactions. The new feature of the light-cone quantization lies in the *instantaneous interactions* V_{inst} [1] similar to the static Coulomb interactions in Coulomb gauge quantum electrodynamics.

Given the LF Hamiltonian, bound states in QCD can be formulated in a way similar to standard eigenvalue problem in quantum mechanics. The expansion coefficients of the hadronic functions in the above free Fock states are called LFWF amplitudes. Perturbatively, one can apply the old-fashioned perturbation theory to H_{LC} to calculate the LFWFs. The resulting perturbative series is called light-front perturbation theory (LFPT) and can be formally obtained from Feynman perturbation theory in light-cone gauge by integrating out k^- first [25]. A major feature of LFPT is that naively looking, due to the $k^+ \geq 0$ constraints, no particle can be created out

of or annihilated into the vacuum, therefore there is a clear separation between particles with $k^+ > 0$ and the vacuum. This is in sharp contrast with the equal-time quantization where particles can be created from vacuum and there is no clear separation between particles and the vacuum.

The hope of LFQ for QCD is not about perturbation theory, but to solve the hadron states on the light-front [1]. The discretized light-cone quantization was proposed in [26] to solve the bound state problem. This non-perturbative framework allows one to treat the zero-mode problem explicitly in [5, 6, 27] and turns out to be successful for models in 1+1 dimension, such as the Schwinger model [5, 28–30], the 1+1 QCD [31–33], the 1+1 ϕ^4 theory [34] and the sine-Gordon model [27].

B. Zero Modes, Rapidity Divergences and LFQ as Effective Field Theory

However, as one realized later, the simplification due to LFQ is not as trivial as one might thought about at a first glance. Even in 1 + 1 dimensions, the triviality of the vacuum is invalid [3] due to the presence of non-negligible light-cone zero modes (modes with $k^+ = 0$). They corresponds to long-wave length fluctuations at large light-cone separation and are sensitive to the vacuum structure [6]. A proper treatment of such modes requires an IR regulator such as a finite box in ξ^- direction that was adopted in the “discrete light-cone quantization” [26]. In LFPT, naively neglecting light-cone zero modes will also leads to inconsistent results for certain Feynman diagrams where the + components of certain external momenta become zero. For example, as argued in Ref. [35], the vacuum bubble diagram for the 1+1 ϕ^4 theory is non-zero at $P^+ = 0$. This contribution is entirely due to light-cone zero modes. Integrating out the k^- at $P^+ = 0$ in a way that leads to LFPT will omit the zero modes contribution and produce incorrect result.

The light-cone zero modes problem that serves as a conceptual “back-door” against vacuum triviality of LFQ is not the only severe problem of LFQ. It has been found [36] that the standard power-counting method that works in equal-time or Euclidean formalism failed to produce a simple pattern of UV divergences in LFQ. In fact, in 4-D gauge theory, a new type of divergence at small k^+ called “light-cone divergence” appears due to presence of $\frac{1}{k^+}$ in the phase space measures and in the instantaneous vertices. In LFPT, the individual diagrams can diverge even more than logarithmically. One might think that the light-cone divergence is simply an artifact of LFQ and should cancel at the final step of calculation for physical quantities such as S matrix elements. However, there are quantities for which the cancellation of light-cone divergences are not complete. Among them are LFWF amplitudes and the associated eigenvalue Eq. (1). We will show in Sec. III that by expressing the LFWF amplitudes as gauge-invariant correlations functions in covari-

ant gauge, one can identify the non-cancelling light-cone divergences as the famous *rapidity divergences* known in the literature of transverse momentum dependent (TMD) phenomenon [37–39]. In covariant gauge, they are caused by light-like gauge links extending to infinities and can be regulated efficiently by introducing *rapidity regulators* to the gauge-links, but in LFQ and LFPT they appears in all diagrams. The appearance of the light-cone or light-front divergences is a signal that LFQ theory is an effective one in the sense that the theory serves to emphasizes the infinite-momentum collinear modes.

Due to the above reasons, LFPT has not been used for any beyond one-loop calculations, except for two-loop anomalous magnetic moment in QED [40]. In fact, the common wisdom of using dimensional regularization (DR) for the transverse-momentum integral, and cut-off for longitudinal momentum has not been proven useful for multi-loop calculations. However, a successful use of the LFPT has been the derivation of the Balitsky-Fadin-Kuraev-Lipatov evolution [41–43] by Mueller for quarkonium wave functions, for which the rapidity divergence structure is relatively simple [44].

Due to the complication caused by the LF divergences, there appear infinite number of counter terms in the LF Hamiltonian [36], which describe the interactions of zero-modes with non-zero modes. This is the price that one pays for an effective theory to truncate away the zero modes which contain infrared physics as well. Even without these problems, one has to use a severe truncation in the number of Fock states to solve Eq. (1). Such truncation usually breaks simple rotational symmetry in the sense that the states belonging the same angular momentum multiplets will have different energies. Moreover, there has been no demonstration so far that the Fock truncation converges well in QCD [36].

Thus, the LFQ provides a great way to understand the parton physics, but is difficult to solve it directly due to the complicated LF divergences and their renormalization.

C. An Effective Approach to Light-Front Quantization

We have emphasized that LFQ is an effective theory of high energy scattering in which the infinite-momentum limit is taken before UV renormalization. This is also the spirit of the soft-collinear effective theory (SCET) [45, 46]. On the other hand, one can perform UV renormalization first before taking the infinite-momentum limit. One can obtain the former result from the latter by simple EFT matching. This is the spirit of the large momentum expansion or effective theory [7, 47].

More specifically, there is a procedure to obtain the LF correlators from Euclidean correlation functions in instant formalism. Let’s consider for simplicity the following two-point function inside a fast-moving hadron state

$|P\rangle$ with large but finite hadron momentum P^μ

$$\tilde{f}_O(\lambda, \vec{b}_\perp, \zeta_\xi = \frac{\xi \cdot P}{\sqrt{\xi^2}}, \mu) = \langle P | O(\xi) O(0) | P \rangle, \quad (13)$$

where $\lambda = \xi \cdot P$ is the longitudinal invariant length and \vec{b}_\perp is the transverse separation. The large rapidity gap between the separation ξ and the hadron is characterized by the variable $\zeta_\xi = \frac{\xi \cdot P}{\sqrt{\xi^2}}$ that plays the role of a hard scale as well. In order to obtain the corresponding LF version $f_O(\lambda, \vec{b}_\perp, \zeta, \mu)$ at rapidity scale ζ , two non-trivial operations need to be performed to obtain the corresponding light-cone version

- An operation in UV which removes the contributions in \tilde{f} that are due to fluctuations at the hard scale ζ_ξ . This process is usually called *matching*. After performing the matching, the hard scale ζ_ξ dependency “transmutes” into the renormalization scale μ dependence of the LF-correlator.
- An operation in small k^+ region, the *rapidity renormalization*, that removes all the contributions from the small k^+ fluctuation. After rapidity renormalization, the physical rapidity dependence “transmutes” into the rapidity renormalization scale ζ dependence of the LF-correlator.

Schematically we have the relation :

$$f_O(\lambda, \vec{b}_\perp, \zeta, \mu) = \lim_{\zeta_v \rightarrow \infty} Z_{\text{RD}}\left(\frac{\zeta}{\zeta_\xi}\right) \otimes C_{\text{UV}}\left(\frac{\zeta_\xi}{\mu}\right) \otimes \tilde{f}_O(\lambda, \vec{b}_\perp, \zeta_\xi, \mu). \quad (14)$$

The Z_{RD} is the rapidity renormalization factor and the C_{UV} is the matching kernel. Therefore, in this sense *the light-cone theory is obtained from the full theory by “integrating out” UV modes above ζ_v and the small k^+ modes below Λ_{QCD} , and can be viewed as an effective theory to the full theory*. As expected, the LF quantum fields ϕ are not the original quantum fields of the full theory.

III. WAVE-FUNCTION AMPLITUDES AND RAPIDITY DIVERGENCES

In this section, we first express the naive WF amplitudes as LF correlation functions between hadron state and the QCD vacuum, in which light-like gauge-links extending to infinities are required to maintain gauge-invariance. This also allows the identification of LF divergences as the rapidity divergences, known in the literature of TMD physics, which we will review after introducing the LF amplitudes. We then introduce the generalized soft functions composed of $N + 1$ Wilson-line cusps that remove the regulator dependency in naive LF amplitudes (or defining a universal regulator scheme consistent with DR). The physical LFWF amplitudes and their evolution equations will also be discussed.

A. WF Amplitudes as LF Correlation Function

As we have pointed out before, the WF amplitudes can be expressed in the form of Eq. (4). By inverting the LF creation-annihilation operators in term of LF fields in Eqs. (8) and (10), one can express the WF amplitudes as LF correlation functions with quark and gluon fields separated in $\vec{\xi}_\perp$ and ξ^- directions. Here we present a precise definition of the LFWF amplitudes in terms of the matrix elements of non-local LF operators between the hadron states and the QCD vacuum.

We first introduce the dimensionful light-cone vectors $p = \frac{1}{\sqrt{2}P^+}(1, 0, 0, 1)$ and $n = \frac{P^+}{\sqrt{2}}(1, 0, 0, -1)$ in convention $A^\mu = (A^0, A^1, A^2, A^3)$. They satisfy $p \cdot n = 1$. P^+ is a mass dimension-1 parameter which will be chosen appropriately in specific applications. We use a generic notation ϕ_i to denote dynamical parts of the quark and gluon fields ψ and A^μ , with indices i to label field types, and any other features such as color representation, flavor, etc. We introduce gauge-invariant version of the field Φ_i which contains gauge-link along the light-cone direction n , pointing to positive or negative infinity:

$$\Phi_i^\pm(\xi) = W_n^\pm(\xi) \phi(\xi), \quad (15)$$

with light-like gauge-link $W_n^\pm(\xi)$ defined as

$$W_n^\pm(\xi) = \mathcal{P} \exp \left[-ig \int_0^{\pm\infty} d\lambda n \cdot A(\xi + \lambda n) \right], \quad (16)$$

where \mathcal{P} is a path order. In the LF gauge $n \cdot A = 0$, the gauge-links formally disappears and the Φ_i simply reduces to local LF fields ϕ_i in Eqs. (8) and (10). From these fields, one can construct the generic naive LFWF amplitudes,

$$\begin{aligned} \psi_N^{\pm 0}(x_i, \vec{b}_{i\perp}, \mu) &= \int \prod_{i=1}^N d\lambda_i e^{i\lambda_i x_i} \times e^{+i\lambda_0 x_0} \quad (17) \\ &\times \langle 0 | \mathcal{P}_N \prod_{i=1}^N \Phi_i^\pm(\lambda_i n + \vec{b}_{i\perp}) \Phi_0^\pm(\lambda_0 n + \vec{b}_{0\perp}) | P \rangle. \end{aligned}$$

where $x_0 = 1 - \sum_i x_i$, $\lambda_0 = -\sum_i \lambda_i$, and all longitudinal momentum fractions carried by partons satisfy $0 < x_i < 1$. We single out a field labelled with 0 with a fixed longitudinal coordinate λ_0 and conjugation momentum x_0 . We choose the sum of the all longitudinal coordinate λ_i as 0 due to translational symmetry. Likewise, when \vec{P} has no transverse momentum $\vec{P}_\perp = 0$, the transverse coordinate \vec{b}_\perp can be shifted by an overall constant without any effect. The 0 superscript on the amplitude indicates that rapidity divergences have not been regularized. However, regular UV divergences are regularized in dimensional regularization (DR) with renormalization scale μ and in the modified minimal subtraction ($\overline{\text{MS}}$)-scheme.

All fields are properly coupled to the quantum numbers of the hadron under consideration. The projection

One can choose, for instance, to deform the gauge-links into the space-like region:

$$n \rightarrow n_Y = n - e^{-2Y} \frac{P}{(P^+)^2}. \quad (21)$$

Here Y plays the role of a rapidity regulator, as when $Y \rightarrow \infty$, $n_Y \rightarrow n$. In certain cases one can also deform n_Y into time-like region [60].

The on-light-cone regulators are consistent with the spirit of parton physics, and therefore are useful to define residual-momentum-independent parton densities. The off-light-cone regulators, on the other hand, are in a similar spirit as LaMET, and therefore can be exploited for practical lattice QCD calculations, as we shall see in the next subsection.

To avoid light-cone divergences, from now on we include the rapidity regulator in the definition of the LFWF amplitudes. The gauge-invariant fields Φ_i are regularized as

$$\Phi_i^\pm(\xi; \delta^-) = W_n^\pm(\xi)|_{\delta^-} \phi(\xi), \quad (22)$$

in terms of which the un-subtracted LFWF amplitudes becomes

$$\begin{aligned} \psi_N^{\pm 0}(x_i, \vec{b}_{i\perp}, \mu, \delta^-) &= \int \prod_{i=1}^N d\lambda_i e^{i\lambda_i x_i} \times e^{i\lambda_0 x_0} \quad (23) \\ &\times \langle 0 | \mathcal{P}_N \prod_{i=1}^N \Phi_i^\pm(\lambda_i n + \vec{b}_{i\perp}; \delta^-) \Phi_0^\pm(\lambda_0 n + \vec{b}_{0\perp}; \delta^-) | P \rangle. \end{aligned}$$

The subscript δ^- denotes that the gauge-links in Φ_i are regulated by the δ regulator in the light-cone minus direction. Similar to the case of TMDPDFs, as $\delta^- \rightarrow 0$, ψ diverges logarithmically, and the finite part also depends on the rapidity regulator. Therefore, the naive amplitudes in Eq. (23) can not appear in factorization formulas for physical observable by themselves. One must remove all divergences and rapidity regularization scheme dependencies in ψ , in a way similar to removing UV divergences in physical quantities. These can be accomplished with the help of *soft functions* to be introduced in the next subsection.

We should mention that the rapidity divergence in gauge theory is not simply an artifact, it reflects the deep fact that as one boost a hadron to faster and faster speed, soft gluons at long-wave length are continually generated with larger and larger population. Therefore, the rapidity divergence is closely related to the small- x physics. Here we simply mention a famous example of Mueller for the onium wave function. Assuming the initial wave function is given by $\psi_0(x, b_T)$, let us consider the radioactive correction to the wave function at order α_s^2 . This calculation have been performed by Mueller in [44], see also [61]. For the valence component consists of one quark and one anti-quark we simply need the virtual part of

his result. The divergent piece is given by:

$$\begin{aligned} &\psi_{\bar{q}q}(x, x_{\min}, b_\perp, \mu)|_{\text{div}} \\ &\approx -\frac{\alpha_s C_F}{\pi} \ln \mu^2 b_\perp^2 \int_{x_{\min}}^{1-x} \frac{dx_g}{x_g} \psi_0(x, b_T). \quad (24) \end{aligned}$$

The coefficient of the divergence is nothing but the one-loop Collins-Soper evolution kernel for TMDPDF. If we probe real emissions with Glauber exchanges as normally happens in the real collision, then the rapidity divergence simply can not be captured by a linear evolution equation. Instead, at large N_c the rapidity evolution for the generating functional for the soft-gluon wave functions is controlled by the non-linear Balitsky-Kovchegov (BK) equation [62, 63], which can be mapped to the Banfi-Marchesini-Smye (BMS) equation [64] associated to those ‘‘non-global’’ infrared logarithms. A thorough discussion on the small- x evolution equation and the BMS equation is beyond the scope of this paper.

C. Generalized Soft functions for LFWF Amplitudes

Similar to the case of TMDPDFs, the rapidity divergences as well as scheme dependencies in Eq. (23) can be renormalized with the help of generalized soft functions, introducing a new rapidity scale ζ . Specifically, the generalized soft function for the ψ_N in Eq. (23) is composed of $N+1$ Wilson-line cusp operators in the representation set $\mathcal{R} = \{R_i; i \in (0, N)\}$ where R_i denote the color representation of the i th cusped Wilson-line. The Wilson-line cusp operator is defined as

$$\mathcal{C}^\pm(\vec{b}_\perp, \delta^\pm, \delta^\mp) = W_n^\pm(\vec{b}_\perp)|_{\delta^-} W_p^\dagger(\vec{b}_\perp)|_{\delta^+}, \quad (25)$$

where W_p is defined as

$$W_p^\pm(\vec{b}_\perp) = \mathcal{P} \exp \left[-ig \int_0^{\pm\infty} d\lambda' p \cdot A(\lambda' p + \vec{b}_\perp) \right]. \quad (26)$$

Here the λ' has mass dimension -2 . And the \pm for the minus direction in W_n^\pm should be chosen the same as that of the WF amplitudes.

With the above, we define the generalized soft function as

$$S_{N, \mathcal{R}}^\pm(\vec{b}_{i\perp}, \mu, \delta^+, \delta^-) = \langle 0 | \mathcal{T} \mathcal{P}_N \prod_{i=0}^N \mathcal{C}^\pm(\vec{b}_{i\perp}, \delta^+, \delta^-) | 0 \rangle, \quad (27)$$

where \mathcal{T} is a time-ordered product for quantum fields. Notice that the time and path orderings are operating on different spaces of operators. For $N=1$ and $\mathcal{R} = \{f, \bar{f}\}$ where f, \bar{f} denote fundamental and conjugate fundamental representations, the definition reduces to the standard TMD soft function for quark-TMDPDF [37]. See Fig. 2 for a depiction of the above generalized soft function. In

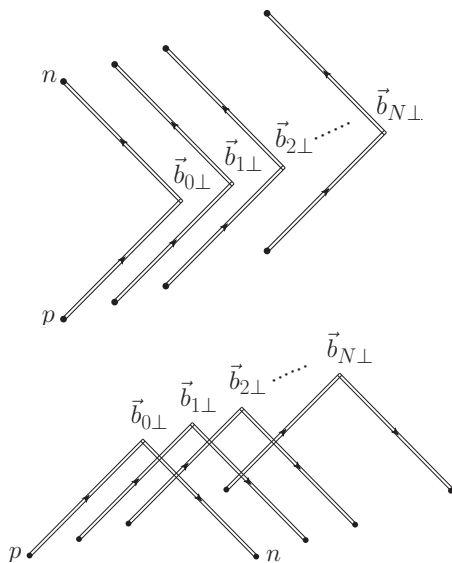

FIG. 2. The soft function S_N^+ (upper) and S_N^- (lower) which can be used to renormalize the light-cone rapidity divergences in LFWF amplitudes.

the following discussion, we will always omit the label \mathcal{R} for the color-representation of the generalized soft functions unless otherwise mentioned. We will also omit the “generalized” from their names and call the case with $N = 1$ and $N > 1$ generically as soft functions.

Intuitively, the soft functions are obtained from the WF amplitudes by performing eikonal approximations to the incoming parton lines. They re-sum all the soft-gluon radiations from the bare WF amplitudes and suffer from rapidity divergences. Therefore, the generic rapidity regulator is also imposed on the soft function. Since the soft function contains two light-like directions, the scheme dependencies of the soft function are expected to “double” that of the WF amplitudes, therefore a square root is introduced in the next subsection to ensure the renormalized WF amplitude is scheme independent.

Indeed, it has been argued in [39] based on conformal transformation that the rapidity divergences in the un-subtracted WF amplitude and the soft functions are indeed multiplicative and is controlled by the generalization of the Collins-Soper kernel, labelled here by $K_N(\vec{b}_{i\perp}, \mu)$ [57]. As $\delta^\pm \rightarrow 0$, one has

$$S_N^\pm(\vec{b}_{i\perp}, \mu, \delta^+, \delta^-) = \exp \left[K_N(\vec{b}_{i\perp}, \mu) \ln \frac{\mu^2/(P^+)^2}{\mp 2\delta^+\delta^- - i0} + \mathcal{D}_{2,N}(\vec{b}_{i\perp}, \mu) \right], \quad (28)$$

where only the product $\delta^+\delta^-$ appears due to boost invariance and $(P^+)^2$ comes from the definition of dimensionful light-cone vectors. In principle, the mass parameters in the light-cone vectors can be chosen differently from that of the hadron, but here we chose them to be the same for simplicity. As a result of this choice, the

hadron momentum dependency is entirely transmuted to the soft functions. The generalized rapidity evolution kernel depends on the color representations \mathcal{R} and reduces to the standard Collins-Soper kernel for $N = 1$ and $\mathcal{R} = \{f, \bar{f}\}$. $K_N(\vec{b}_{i\perp}, \mu)$ is independent of rapidity regularization scheme. On the other hand, the finite part $\mathcal{D}_{2,N}(\vec{b}_{i\perp}, \mu)$ (where subscript 2 indicates the definition depending on the two on-light-cone vectors) is scheme-dependent.

Similar to the $N = 1$ case, the soft-function in δ regularization satisfies the renormalization group equation

$$\begin{aligned} \mu^2 \frac{d}{d\mu^2} \ln S_N^\pm(\vec{b}_{i\perp}, \mu, \delta^+, \delta^-) \\ = -\frac{N+1}{2} \Gamma_{\text{cusp}}(\alpha_s) \ln \frac{\mu^2/(P^+)^2}{\mp 2\delta^+\delta^- - i0} + \frac{N+1}{2} \gamma_s(\alpha_s), \end{aligned} \quad (29)$$

where $\Gamma_{\text{cusp}}(\alpha_s)$ is the light-like cusp anomalous dimension [65, 66] and the $\gamma_s(\alpha_s)$ is the soft anomalous dimension independent of N [67]. But they all depends on the color representation \mathcal{R} . The generalized Collins-Soper kernel satisfy the renormalization group equation (RGEs):

$$\mu^2 \frac{d}{d\mu^2} K_N(\vec{b}_{i\perp}, \mu) = -\frac{N+1}{2} \Gamma_{\text{cusp}}(\alpha_s). \quad (30)$$

It is worth pointing out that S_N^- and K_N in some special cases have been calculated to two loops in [38].

One should notice that the \pm sign in the logarithms in Eq. (28) is related to the analyticity structure of the soft functions. Notice that the $e^{-\lambda\delta^\pm}$ in the definition of the delta-regulator can be viewed as residual imaginary external momenta $\delta k_p = i\delta^-p$ and $\delta k_n = i\delta^+(P^+)^2n$ carried by the corresponding gauge-links in p and n direction, respectively. For the S_N^- space-time picture, both of them are incoming and the residual momentum transfer equals to $Q^2 = (\delta k_p + \delta k_n)^2 = -(P^+)^2\delta^+\delta^-$, which is space-like. Therefore the corresponding soft functions S_N^- are purely real. On the other hand, for the S_N^+ picture one residual momentum is incoming while another is outgoing and the residual momentum transfer $(\delta k_p - \delta k_n)^2$ becomes time-like, which will generate an imaginary part. In fact, one can show that the two versions of the soft functions are related through analytic continuation

$$S_N^+(\vec{b}_{i\perp}, \mu, \delta^+\delta^-) = S_N^-(\vec{b}_{i\perp}, \mu, -\delta^+\delta^- + i0). \quad (31)$$

This is similar to the relation between space-like and time-like form-factors [68] where the momentum transfer Q^2 equals to $-(P^+)^2\delta^+\delta^-$.

D. Rapidity-Renormalized LFWF Amplitudes and Rapidity-Scale Evolutions

With the above soft functions, we take its square root to perform the rapidity renormalization of ψ_N^0 in Eq. (23)

and define the ‘‘physical’’ LFWF amplitudes as

$$\psi_N^\pm(x_i, \vec{b}_{i\perp}, \mu, \zeta) = \lim_{\delta^- \rightarrow 0} \frac{\psi_N^{\pm 0}(x_i, \vec{b}_{i\perp}, \mu, \delta^-)}{\sqrt{S_{N,\mathcal{R}}^\pm(\vec{b}_{i\perp}, \mu, \delta^- e^{2y_n}, \delta^-)}}. \quad (32)$$

where $S_{N,\mathcal{R}}$ is the generalized TMD soft function defined in Eq. (27).

Similar to the case of TMDPDF [37], We also introduced a dimensionless rapidity parameter y_n for the renormalized WF amplitude. The rapidity divergences cancel between the bare or un-subtracted WF amplitudes and the soft function, leading to the explicit dependence of WF amplitudes on a set of rapidity scales ζ defined as

$$\zeta = 2(P^+)^2 e^{2y_n}. \quad (33)$$

Sometimes it is also useful to introduce $N + 1$ rapidity scales related to ζ and x_i through

$$\zeta_i \equiv \zeta x_i^2. \quad (34)$$

Given x_i and ζ , they are not independent variables, but they are the most natural hard scales around the $N + 1$ link-field vertices. The rapidity evolution equation for the rapidity-renormalized WF amplitudes reads

$$2\zeta \frac{d}{d\zeta} \ln \psi_N^\pm(x_i, \vec{b}_{i\perp}, \mu, \zeta) = K_N(\vec{b}_{i\perp}, \mu). \quad (35)$$

where the generalized Collins-Soper kernel is non-perturbative for large $\vec{b}_{i\perp}$. The proof of the above equation is similar to TMDPDF and will not be discussed here. See Refs. [47, 57] for further details.

The RGE for the UV-renormalized WF amplitude can be derived easily,

$$\begin{aligned} & \mu^2 \frac{d}{d\mu^2} \ln \psi_N^\pm(x_i, \vec{b}_{i\perp}, \mu, \zeta) \\ &= \frac{1}{4} \sum_{i=0}^N \Gamma_{\text{cusp}} \ln \frac{\mu^2}{\pm \zeta x_i^2 - i0} - \frac{N+1}{2} \gamma_H(\alpha_s), \end{aligned} \quad (36)$$

where γ_H is the hard-anomalous dimension that depends on the specific field operators Φ_i . We will give an example for meson amplitude later.

One should notice that for unpolarized TMDPDFs, the imaginary parts cancel between different diagrams as they are real quantities, but for WF amplitudes there are no such cancellations. The imaginary parts are caused by rapidity logarithms of P^+ and various rapidity regulators. The proper \pm in the $\pm \zeta_i - i0$ term is determined by the $i0$ prescriptions in the gauge-link propagators for the unsubtracted or bare WF amplitudes and the soft functions. A correct prescription must guarantee its exponential decay at light-front infinities. The standard set of the LFWF amplitudes defined above can serve in factorization of experimental processes or comparing with various theoretical calculations.

IV. QUASI LFWF AMPLITUDES AND FACTORIZATION IN LAMET

The standard LFWF amplitudes are natural quantities to solve in LFQ if a viable approach can be found to implement a non-perturbative solution of Eq. (1). The rapidity dependence will appear naturally when the LF Hamiltonian is implemented with a rapidity regulator, such as finite length in the LF coordinate, without breaking the manifest Lorentz symmetry. Alternatively, they can be calculated using the effective large-momentum expansion approach once the instant-form solutions of some Euclidean matrix elements in a large momentum state are found [10]. The goal of this section is to show how to implement this.

We first need to find a Euclidean version of the WF amplitudes which contain the same collinear and soft physics as that of the LFWF amplitudes. Similar to the case of TMDPDFs, the collinear part can be taken into account by boosting the gauge links in the standard amplitudes without time dependence, and the light-front time dependence can be taken into account by the large rapidity external hadron states. Thus all the ingredients required to reproduce the correct collinear and soft physics for WF amplitudes are available on a Euclidean lattice.

In this section, we first define the quasi-WF amplitudes in general. We then introduce the reduced soft functions as the rapidity independent part of the generalized off-light-cone soft functions. They are required to cancel the off-light-cone scheme dependencies from the quasi-WF amplitudes and match to the standard LFWF amplitudes. We then discuss the factorization of quasi-WF amplitudes and present the matching formula.

A. Quasi-WF Amplitudes

Let us denote the unit four-vector in z direction as $n_z = (0, 0, 0, 1)$. We consider the ordinary equal-time (also named as Euclidean) quasi-LFWF amplitudes or simply quasi-WF amplitudes in a large momentum hadron,

$$\begin{aligned} \tilde{\psi}_N^\pm(x_i, \vec{b}_{i\perp}, \mu, \zeta_z) &= \lim_{L \rightarrow \infty} \int d\lambda_i e^{-i\lambda_i x_i - i\lambda_0 x_0} \quad (37) \\ & \frac{\langle 0 | \mathcal{P}_N \prod_{i=1}^N \Phi_i^\pm(\lambda_i n_z + \vec{b}_{i\perp}; L) \Phi_0^\pm(\lambda_0 n_z; L) | P \rangle}{\sqrt{Z_E(2L, \vec{b}_{i\perp}, \mu)}} \end{aligned}$$

where $\lambda_0 = -\sum_{i=1}^N \lambda_i$ and $x_0 = 1 - \sum_{i=1}^N x_i$. The $\Phi_i^\pm(\lambda_i n_z + \vec{b}_{i\perp}; L)$ is the gauge-invariant field with gauge-links along z directions (extended to length L) being attached

$$\Phi_i^\pm(\xi; L) = \mathcal{P} \exp \left[ig \int_0^{\mp L \pm \xi^z} d\lambda A^z(\xi + \lambda n_z) \right] \phi(\xi), \quad (38)$$

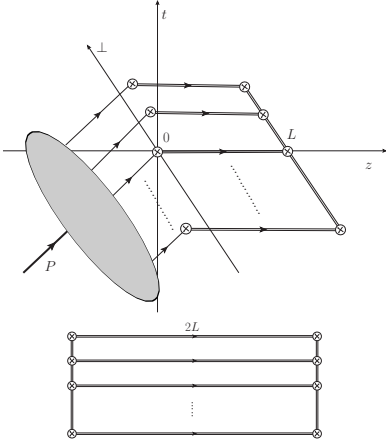

FIG. 3. The quasi-LFWF amplitudes $\tilde{\psi}_N^-$ (upper) and Z_E (lower). The crossed circles denotes the operator insertion Φ_i or junctions of gauge-links. Notice that the connection of the gauge-links at $z = L$ is not unique, however, the contribution at $z = L$ should cancel after taking ratio with $\sqrt{Z_E}$.

with $\xi^z = -\xi \cdot n_z$ and the $\pm L$ corresponds to the \mp choices for the WF amplitude. The $\zeta_z = (2P \cdot n_z)^2$ are the Collins-Soper rapidity scale similar to that of the quasi-TMDPDFs. One also needs the $N + 1$ rapidity scales $\zeta_{z,i} \equiv \zeta_z x_i^2$ similar to the ζ_i . Clearly the above quantity is the external momentum $P^\mu = (P^0, 0, 0, P^z)$ -dependent. The choices of the fields and couplings in the quasi WF are not unique, for a given LFWF amplitude to be reproduced. This is the universality principle of LaMET discussed in Ref. [10]. $Z_E(L, b_{i\perp}, \mu)$ is the vacuum expectation of a set of space-like Wilson-lines along z direction and separated in the transverse plane :

$$Z_E(L, \vec{b}_{i\perp}, \mu) = \langle 0 | \mathcal{P}_N \mathcal{T} \prod_{i=0}^N \mathcal{P} \exp \left[ig \int_0^L d\lambda A^z(\vec{b}_{i\perp} + \lambda n_z) \right] | 0 \rangle. \quad (39)$$

The connection in the transverse plane is needed for gauge invariance and might not be unique and shall be in accordance with that in the standard LFWF amplitudes to be reproduced. The purpose of the factor Z_E in the quasi-LFWF amplitudes is the same as for quasi-TMDPDFs, in addition to cancel the Wilson line self-energy. See Fig. 3 for a depiction of the quasi-LFWF amplitudes and the Z_E .

The external momentum-dependence of the quasi-WF amplitudes can be calculated when the hadron momentum is large. The momentum RG equation can be shown in a way similar to [57] as

$$P^z \frac{d}{dP^z} \ln \tilde{\psi}_N^\pm(x_i, \vec{b}_{i\perp}, \mu, \zeta_z) = K_N(\vec{b}_{i\perp}, \mu) + \sum_{i=0}^N \frac{1}{2} \mathcal{G}^\pm(\zeta_z x_i^2, \mu), \quad (40)$$

where we have omitted terms of higher powers in $(1/P^z)^2$, and the $K_N(\vec{b}_{i\perp}, \mu)$ is the non-perturbative rapidity evolution factor same in Eq. (35) and $\mathcal{G}^\pm(\zeta_z x_i^2, \mu)$ are perturbative kernels. From the rapidity evolution equation, one clearly see that as $P^z \rightarrow \infty$, there are large logarithms in P^z , part of it being non-perturbative and part of it being perturbative. Therefore, to match to the WF amplitude one needs a hard kernel H to take into account the perturbative logarithms, and an exponential of K_N to take into account the non-perturbative rapidity logarithms.

B. Generalized Off-light-cone Soft Functions

In the previous subsection, we have introduced the gauge-invariant quasi-WF amplitude. However, it still suffers from implicit scheme dependency since they are defined with an off-light-cone regulator along the z direction. To match them to the physical WF amplitudes introduced in Sec. III, one needs the (generalized) off-light-cone soft functions $S_N^\pm(\vec{b}_{i\perp}, \mu, Y, Y')$ composed of $N + 1$ Wilson-line cusps which we now introduce.

We first define the off-light-cone space-like vectors as $p \rightarrow p_Y = p - e^{-2Y}(P^+)^2 n$, $n \rightarrow n_{Y'} = n - e^{-2Y'} \frac{p}{(P^+)^2}$ and the off-light-cone Wilson-line cusps $\mathcal{C}^\pm(b, Y, Y')$:

$$\mathcal{C}^\pm(\vec{b}_\perp, Y, Y') = W_{n_{Y'}}^\pm(\vec{b}_\perp) W_{p_Y}^\dagger(\vec{b}_\perp), \quad (41)$$

where the off-light-cone gauge-links W_{p_Y} and $W_{n_{Y'}}$ are defined as

$$W_{p_Y}(\vec{b}_\perp) = \mathcal{P} \exp \left[-ig \int_0^{-\infty} d\lambda' p_Y \cdot A(\lambda' p_Y + \vec{b}_\perp) \right], \quad (42)$$

and

$$W_{n_{Y'}}^\pm(\vec{b}_\perp) = \mathcal{P} \exp \left[-ig \int_0^{\pm\infty} d\lambda n_{Y'} \cdot A(\lambda n_{Y'} + \vec{b}_\perp) \right], \quad (43)$$

respectively. With the off-light-cone Wilson-line cusps, the soft functions are defined in a way similar to Eq. (27):

$$S_N^\pm(\vec{b}_{i\perp}, \mu, Y, Y') = \frac{\langle 0 | \mathcal{P}_N \mathcal{T} \prod_{i=0}^N \mathcal{C}^\pm(\vec{b}_{i\perp}, Y, Y') | 0 \rangle}{\sqrt{Z_E(Y)} \sqrt{Z_E(Y')}}}, \quad (44)$$

where $\sqrt{Z_E}$ is introduced similar as in Eq. (39) to subtract the pinch-pole singularities and power divergences of the off-light-cone gauge-links. In terms of $\ln \rho^2 = 2(Y + Y')$, we can also write the off-light-cone soft functions as $S_N^\pm(\vec{b}_{i\perp}, \mu, \rho)$.

In the light-cone limit $Y + Y' \rightarrow \infty$, we have:

$$S_N^\pm(\vec{b}_{i\perp}, \mu, Y, Y') = \exp \left[K_N(\vec{b}_{i\perp}, \mu) \ln(\mp e^{Y+Y'} - i0) + \mathcal{D}_N(\vec{b}_{i\perp}, \mu) \right], \quad (45)$$

where K_N is the same Collins-Soper kernel as in Eq. (28), but \mathcal{D}_N is different from the on-light-cone version $\mathcal{D}_{2,N}$. Similar to the case of δ regulator, imaginary part appears in the S_N^+ case due to analyticity property. In fact, one can show that the off-light-cone soft function depends only on the (complex) hyperbolic angle for the directions vectors from which the imaginary part can be generated. The rapidity-independent part is defined as the generalized reduced soft function:

$$S_{rN}(b_{i\perp}, \mu) = e^{-\mathcal{D}_N(\vec{b}_{i\perp}, \mu)}, \quad (46)$$

which is independent of the $\pm\infty$ choice. Based on the renormalization property of non-light-like Wilson-loops, the reduced soft function satisfies the RG equation

$$\mu^2 \frac{d}{d\mu^2} \ln S_{rN}(\vec{b}_{i\perp}, \mu) = -\frac{N+1}{2} \Gamma_S(\alpha_s), \quad (47)$$

where Γ_S is the constant part of the cusp-anomalous dimension at large hyperbolic cusp angle $Y + Y'$ for the off-light-cone soft function:

$$\begin{aligned} \mu^2 \frac{d}{d\mu^2} \ln S_N^-(\vec{b}_{i\perp}, \mu, Y, Y') \\ = -(Y + Y') \frac{N+1}{2} \Gamma_{\text{cusp}}(\alpha_s) + \frac{N+1}{2} \Gamma_S(\alpha_s). \end{aligned} \quad (48)$$

Notice that Γ_S depends on the color representation \mathcal{R} .

Similar to the $N = 1$ case [22], the off-light-cone soft function $S_N^-(\vec{b}_{i\perp}, \mu, Y, Y')$ equals to a time-independent form factor of fast-moving color-charged state. Thus it can be simulated using the Euclidean formalism of heavy-quark effective theory (HQET). The explicit form of the HQET implementation depends on the color-representations of the Wilson-line cusps. We will not go into the details here for general case.

In the next subsection, we will show that similar to the case of quasi-TMDPDFs [69], the corresponding non-perturbative rapidity independent part that cancels the off-light-cone scheme dependencies in quasi-WF amplitudes is exactly the reduced soft function.

C. Factorization of Quasi-WF Amplitudes

Given the reduced soft function, we can state the matching formula between the quasi-WF amplitudes at finite momentum and that in LF theory :

$$\tilde{\psi}_N^\pm(x_i, \vec{b}_{i\perp}, \mu, \zeta_z) \sqrt{S_{rN}(\vec{b}_{i\perp}, \mu)} = e^{\ln \frac{\mp \zeta_z - i0}{\zeta}} K_N(\vec{b}_{i\perp}, \mu) \quad (49)$$

$$\times H_N^\pm(\zeta_{z,i}/\mu^2) \psi_N^\pm(x_i, \vec{b}_{i\perp}, \mu, \zeta) + \dots,$$

where $H_N^\pm(\zeta_{z,i}/\mu^2)$ is the perturbative matching kernel which is responsible for the large logarithms of P^z generated by the perturbative \mathcal{G}^\pm part of the momentum

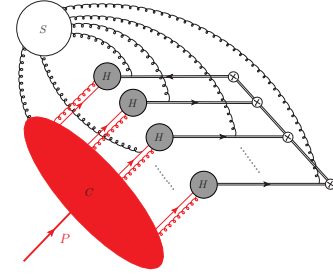

FIG. 4. The leading region for quasi-WF amplitude $\tilde{\psi}_N^-$, where C is the collinear sub-diagram, S is the soft sub-diagram and H are the hard sub-diagrams. The $N + 1$ hard-cores are disconnected with each-other, therefore the momentum fractions of the quasi-WF amplitudes and physical WF amplitudes are the same.

evolution equation. The H_N^+ and H_N^- relates with each other through analytic continuation in ζ_z . Similar to the quasi-TMDPDFs, the momentum fractions of the quasi-WF amplitudes and the LFWF amplitudes are the same since the momentum fractions can only be modified by collinear modes when $|\vec{k}_\perp| \ll P^z$. And $e^{\ln \frac{\mp \zeta_z - i0}{\zeta}} K_N(\vec{b}_{i\perp}, \mu)$ is the part involving the non-perturbative rapidity evolution kernel. The imaginary part is required again in the S_N^+ case due to our definition of S_{rN} . As in the case of quasi-TMDPDFs, this factor is required to cancel the non-perturbative logarithms in P^z . The omitted terms are the power-corrections which are of order $\mathcal{O}\left(\Lambda_{\text{QCD}}^2/\zeta_{z,i}, M^2/\zeta_{z,i}, 1/(\delta\vec{b}_{ij,\perp}^2 \zeta_{z,i})\right)$ with M being the hadron mass and $\delta\vec{b}_{ij,\perp} = \vec{b}_{i\perp} - \vec{b}_{j\perp}$.

Similar to the case of quasi-TMDPDF [69], a sketch of mathematical proof for the factorization formula Eq. (49) can be provided with the help of the leading regions for quasi-LFWF amplitudes, shown in Fig. 4. There are collinear, soft and hard contributions captured by the corresponding collinear (C), soft (S) and hard (H) sub-diagrams. The collinear contributions are the same as the WF amplitudes defined with LF correlators, while the soft contribution can be factorized using off-light-cone soft functions. At large P^z and large $|\vec{b}_{i\perp} - \vec{b}_{j\perp}|$, hard exchanges between vertices at different $\vec{b}_{i\perp}$ are power-suppressed, therefore the hard contributions are confined near the $N + 1$ vertices. The hard natural scales for the hard sub-diagrams are given by $\zeta_{z,i} = \zeta_z x_i^2$, which are Lorentz-invariant combinations of the gauge-link direction n^z and the parton's momenta $k_i = x_i P$. As a result, the momentum fractions x_i only receive collinear contributions and remain the same between the quasi-WF amplitude and the physical LFWF amplitudes.

Given the leading region, a standard application of Ward-identity argument [37] will leads to the factorization formula Eq. (49). We use off-light-cone regulator in all the soft functions as in [37]. The reduced soft function S_{rN} emerges at the final step as the non-cancelling soft function combination that appears when the factoriza-

tion formula is expressed in terms of the physical LFWF amplitudes through the combination in Eq. (32). Similar to the case of quasi-TMDPDFs, $S_{r,N}$ serves to compensate the rapidity independent part between ψ_N and $\tilde{\psi}_N$. The Collins-Soper kernel appears to compensate the rapidity mismatch between ψ_N at ζ and $\tilde{\psi}_N$ at ζ_z .

Here we should mention that when performing the factorization of quasi-WF amplitude using off-light-cone regulators, the emergence of $S_{r,N}$ is expected since it is defined exactly through the off-light-cone soft functions. However, in the SCET style approach one can use on-light-cone regulators to do the factorization as well. As shown in Ref. [10], if one perform factorization of $\tilde{\psi}$ using on-light-cone regulators, the $S_{r,N}$ can also be defined through the following type of combination

$$S_{r,N}(\vec{b}_{i\perp}, \mu) = \lim_{\delta^+, \delta^- \rightarrow 0} \frac{S_N^-(\vec{b}_{i\perp}, \mu, \delta^+ \delta^-)}{S_N^-(\vec{b}_{i\perp}, \mu, \delta^+) S_N^-(\vec{b}_{i\perp}, \mu, \delta^-)}, \quad (50)$$

where the $S_N^-(\vec{b}_{i\perp}, \mu, \delta^+ \delta^-)$ in the numerator is the on-light-cone soft function defined in Eq. (28). The $S_N^-(\vec{b}_{i\perp}, \mu, \delta^\pm)$ in the denominator is defined similarly, but with one on-light-cone gauge-link direction along p or n , and another off-light-cone one along n^z . The light-cone regulator for the on-light-cone gauge-link directions are denoted by δ^\pm . Notice that the combination in Eq. (50) also appears in Ref. [70] in the special case $N = 1$ and is equivalent to their ‘‘instant-jet TMD distribution’’ $\Psi(\xi)$ at special ξ .

D. Collins-Soper Kernel From Quasi-LFWF Amplitudes

As an application of the factorization formula Eq. (49), we show that the Collins-Soper rapidity evolution kernel can be calculated from the large-momentum dependence of the quasi-WF amplitude, just like the case of quasi-TMDPDF [47].

Notice that by taking the ratio of two quasi-LFWFs, the reduced soft function $S_{r,N}$ cancels. Furthermore, if we chose the quasi-LFWFs to have different sets of Collins-Soper scale, ζ_z and ζ'_z but with the same x_i , the LFWF amplitudes will also cancel. This allows the Collins Soper kernel to be extract in the following way

$$K_N(\vec{b}_{i\perp}, \mu) = \frac{1}{\ln \frac{\zeta'_z}{\zeta_z}} \ln \frac{H_N^\pm(\zeta'_z/\mu^2) \tilde{\psi}_N^\pm(x_i, \vec{b}_{i\perp}, \mu, \zeta_z)}{H_N^\pm(\zeta_z/\mu^2) \tilde{\psi}_N^\pm(x_i, \vec{b}_{i\perp}, \mu, \zeta'_z)}. \quad (51)$$

It is clear that this is a result of the rapidity evolution equation for quasi-LFWFs. The same method was first obtained in the context of quasi-TMDPDF in [71] by taking ratio of quasi-TMDPDFs at different P^z . Notice that the matching kernel and the quasi-LFWF amplitudes all

have imaginary parts in general, but after taking the ratio, the imaginary parts cancels, left with a purely real K_N .

V. LEADING WAVE FUNCTION AMPLITUDE FOR PSEUDO-SCALAR MESON

In previous sections, we have presented the general theoretical framework to calculate LFWF amplitudes using LaMET formulations. As an application of the general principles, we present in this section the example for the leading $\bar{q}q$ component wave function for a pseudo-scalar meson. As usual, we first present the standard definition in terms of the light-front formulation, then introduce the corresponding Euclidean formulation in large momentum expansion.

A. The Light-Front Formulation

According to the general rules, the leading unsubtracted wave-function amplitude for a pseudo-scalar meson is defined by

$$\psi_{\bar{q}q}^{\pm 0}(x, b_\perp, \mu, \delta^-) = \frac{1}{2} \int \frac{d\lambda}{2\pi} e^{ix_r \lambda} \times \langle 0 | \bar{\Psi}_n^\pm(\lambda n/2 + \vec{b}_\perp) \gamma^+ \gamma^5 \Psi_n^\pm(-\lambda n/2) | P \rangle \Big|_{\delta^-}, \quad (52)$$

where x_r is related to the standard definition of x by $x_r = x - 1/2$, and the ‘‘gauge-invariant’’ quark field is

$$\Psi_n^\pm(\xi) = W_n^\pm(\xi) |_{\delta^-} \psi(\xi). \quad (53)$$

Due to rotational invariance, the amplitude defined above is a function of $b_\perp = |\vec{b}_\perp|$, thus we have omitted the vector arrow for \vec{b}_\perp , and we will do so throughout the section for the $N = 1$ case. See Fig. 5 for a depiction of the meson wave functions.

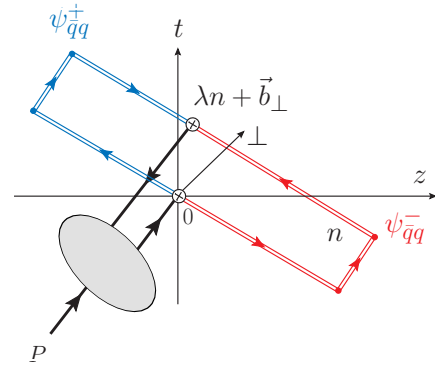

FIG. 5. The $\bar{q}q$ wave function for a pseudo-scalar meson. Again, the red case corresponds to $\psi_{\bar{q}q}^-$ and the blue case corresponds to $\psi_{\bar{q}q}^+$.

We now present the perturbative one-loop calculation for the above amplitude. We consider a system where the

incoming quark and anti-quark momenta are $x_0 P^+$ and $(1-x_0)P^+$, respectively. The spin projection operator for the incoming state is proportional to $\gamma^5 \gamma^-$ and the tree-level wave-function amplitude is normalized to $\delta(x-x_0)$. Evaluated in the δ regularization scheme, the bare WF amplitude reads

$$\begin{aligned} & \psi_{q\bar{q}}^{\pm 0}(x, b_\perp, \mu, \delta^-) \\ &= \frac{\alpha_s C_F}{2\pi} [F(x, x_0, b_\perp, \mu)]_+ + \frac{\alpha_s C_F}{2\pi} \delta(x-x_0) \\ & \times \left\{ L_b \left(\frac{3}{2} + \ln \frac{-(\delta^-)^2 \mp i0}{x_0 \bar{x}_0} \right) + \frac{1}{2} \right\}, \end{aligned} \quad (54)$$

where $C_F = (N_c^2 - 1)/2N_c$ and $L_b = \ln \frac{\mu^2 b_\perp^2}{4e^{-2\gamma_E}}$ and

$$\begin{aligned} & F(x, x_0, b_\perp, \mu) \\ &= \left[- \left(\frac{1}{\epsilon_{\text{IR}}} + L_b \right) \left(\frac{x}{x_0(x_0-x)} + \frac{x}{x_0} \right) + \frac{x}{x_0} \right] \\ & \times \theta(x)\theta(x_0-x) + (x \rightarrow \bar{x}, x_0 \rightarrow \bar{x}_0), \end{aligned} \quad (55)$$

where $\frac{1}{\epsilon_{\text{IR}}}$ indicates that there is an IR divergence. Notice that x and $\bar{x} = 1-x$ are the momentum fractions carried by the quark and the anti-quark.

The soft function with $N=1$ and $\mathcal{R} = \{f, \bar{f}\}$ is defined with two Wilson-line cusps explicitly as

$$\begin{aligned} S_1^\pm(b_\perp, \mu, \delta^+ \delta^-) &= \frac{1}{N_c} \text{tr} \langle 0 | \mathcal{T} W_p^{-\dagger}(b) |_{\delta^+} \\ & \times W_n^\pm(b) |_{\delta^-} W_n^{\pm\dagger}(0) |_{\delta^-} W_p^-(0) |_{\delta^+} | 0 \rangle. \end{aligned} \quad (56)$$

At one-loop, the soft function $S_1^\pm(b_\perp, \mu, \delta^+, \delta^-)$ is given by [72]:

$$\begin{aligned} & S_1^-(b_\perp, \mu, \delta^+ \delta^-) \\ &= 1 + \frac{\alpha_s C_F}{2\pi} \left(L_b^2 - 2L_b \ln \frac{\mu^2}{2(P^+)^2 \delta^+ \delta^-} + \frac{\pi^2}{6} \right), \end{aligned} \quad (57)$$

$$\begin{aligned} & S_1^+(b_\perp, \mu, \delta^+ \delta^-) \\ &= 1 + \frac{\alpha_s C_F}{2\pi} \left(L_b^2 - 2L_b \left(\ln \frac{\mu^2}{2(P^+)^2 \delta^+ \delta^-} + i\pi \right) + \frac{\pi^2}{6} \right). \end{aligned} \quad (58)$$

where S^+ contains an imaginary part. Therefore, we can extract at the leading order the CS kernel and reduced soft function,

$$K_1(b_\perp, \mu) = -\frac{\alpha_s C_F}{\pi} L_b, \quad (59)$$

$$\mathcal{D}_{2,1}(b_\perp, \mu) = \frac{\alpha_s C_F}{2\pi} \left(L_b^2 + \frac{\pi^2}{6} \right). \quad (60)$$

They are consistent with the case for TMDPDFs. The rapidity dependence coming from the initial-state quark radiation is intrinsic and nonperturbative for large b_\perp .

In term of these, the renormalized WF amplitude is defined explicitly as

$$\psi_{q\bar{q}}^\pm(x, b_\perp, \mu, \zeta) = \lim_{\delta^- \rightarrow 0} \frac{\psi_{q\bar{q}}^{\pm 0}(x, b_\perp, \mu, \delta^-)}{\sqrt{S_1^\pm(b_\perp, \mu, \delta^- e^{2y_n}, \delta^-)}}, \quad (61)$$

where we have chosen $\delta^+ = e^{2y_n} \delta^-$ with y_n as a dimensionless parameter. While both ψ^0 and S_1 depend on the regulator δ^\pm , the combination ψ is regularization independent and gives rise to the dependencies on the universal rapidity variables $\zeta = 2(xP^+)^2 e^{2y_n}$ and $\bar{\zeta} = 2(\bar{x}P^+)e^{2y_n}$, with the dependence on the latter being omitted. Combining the results above, the one-loop WF amplitude reads

$$\begin{aligned} & \psi_{q\bar{q}}^\pm(x, b_\perp, \mu, \zeta) \\ &= \frac{\alpha_s C_F}{2\pi} [F(x, x_0, b_\perp, \mu)]_+ + \frac{\alpha_s C_F}{2\pi} \delta(x-x_0) \\ & \times \left\{ -\frac{L_b^2}{2} + L_b \left(\frac{3}{2} + \ln \frac{\mu^2}{\pm \sqrt{\zeta \bar{\zeta}} - i0} \right) + \frac{1}{2} - \frac{\pi^2}{12} \right\}, \end{aligned} \quad (62)$$

which effectively replaces the rapidity regulator δ by the rapidity scale ζ . It is important to note that the above result is now independent of the light-cone regulator δ .

The renormalized WF amplitude satisfies the rapidity (momentum) evolution equation

$$2\zeta \frac{d}{d\zeta} \ln \psi_{q\bar{q}}^\pm(x, b_\perp, \mu, \zeta) = K_1(b_\perp, \mu), \quad (63)$$

and the RGE:

$$\begin{aligned} & \mu^2 \frac{d}{d\mu^2} \ln \psi_{q\bar{q}}^\pm(x, b_\perp, \mu, \zeta) \\ &= \frac{1}{2} \Gamma_{\text{cusp}}(\alpha_s) \ln \frac{\mu^2}{\pm \sqrt{\zeta \bar{\zeta}} - i0} - \gamma_H(\alpha_s). \end{aligned} \quad (64)$$

In the above equations, the evolution kernel $K_1(b_\perp, \mu)$ and the anomalous dimensions are the same as those of the TMDPDFs. At one-loop, the above cusp and hard anomalous dimensions read

$$\Gamma_{\text{cusp}}(\alpha_s) = \frac{\alpha_s C_F}{\pi}; \quad \gamma_H(\alpha_s) = -\frac{3\alpha_s C_F}{4\pi}. \quad (65)$$

Recently the cusp anomalous dimension have been calculated to 4-loops [73, 74].

B. LaMET Expansion

To calculate the above $q\bar{q}$ WF amplitude, we define the un-subtracted quasi-WF amplitude as

$$\begin{aligned} & \tilde{\psi}_{q\bar{q}}^\pm(x, b_\perp, \mu, \zeta_z) \\ &= \lim_{L \rightarrow \infty} \int \frac{d\lambda}{4\pi} e^{-ix_r \lambda} \frac{\langle 0 | \bar{\Psi}_{\mp n_z}(\frac{\lambda n_z}{2} + \vec{b}_\perp) \Gamma \Psi_{\mp n_z}(-\frac{\lambda n_z}{2}) | PS \rangle}{\sqrt{Z_E(2L, b_\perp, \mu)}}, \end{aligned} \quad (66)$$

where $x_r = x - \frac{1}{2}$ and $\Psi_{\mp n_z}$ now contains a gauge-link along the $\mp z$ direction pointing to $\mp L n_z$, similar to Eq. (38). The Wilson-line self-energy and interaction are subtracted, which is also similar to the case for quasi-TMDPDF. See Fig. 6 for a depiction of the quasi-LFWF amplitudes $\psi_{q\bar{q}}^\pm$ and Z_E for pseudo-scalar meson. Note

that $\tilde{\psi}$ depends on $\zeta_z = (2xP \cdot n_z)^2$, $\bar{\zeta}_z = (2\bar{x}P \cdot n_z)^2$ and the renormalization scale μ . More generally, the quasi-WF amplitude satisfies the renormalization group equation

$$\mu^2 \frac{d}{d\mu^2} \ln \tilde{\psi}_{\bar{q}q}^{\pm}(x, b_{\perp}, \mu, \zeta_z) = \gamma_F(\alpha_s), \quad (67)$$

where γ_F is the anomalous dimension for a heavy-light current. This is due to the fact that the quasi-WF amplitude, after the self-energy and corner-divergence subtraction contains only logarithmic UV divergences associated with quark-link vertices. The one-loop quasi-WF ampli-

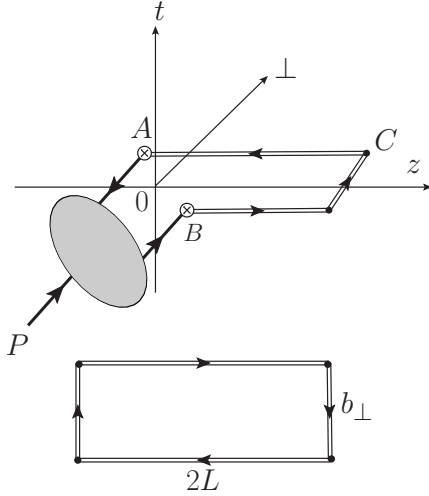

FIG. 6. The quasi-LFWF $\tilde{\psi}_{\bar{q}q}^{\pm}$ (upper) and the Z_E (lower). In the figure, $A = \lambda n_z/2 + \vec{b}_{\perp}/2$, $B = -\lambda n_z/2 - \vec{b}_{\perp}/2$ and $C = \lambda n_z + \vec{b}_{\perp}$. The crosses denote the quark-link vertices.

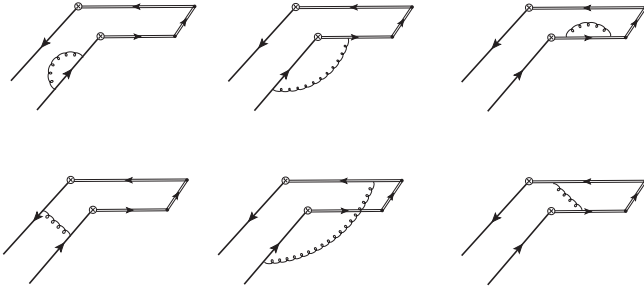

FIG. 7. One-loop diagrams for mesonic LFWF amplitudes and quasi-LFWF amplitudes. The meson state is treated as a pair of free quark and antiquark. The first line represents “virtual” diagram and the second line represents “real” diagram.

tude receives contribution from more diagrams compared to the WF amplitude. Unlike the LFWF amplitude, all the “virtual” diagrams and gauge-link self-interactions

are non-vanishing. The total result reads

$$\begin{aligned} \tilde{\psi}_{\bar{q}q}^{\pm}(x, b_{\perp}, \mu, \zeta_z) & \quad (68) \\ &= \frac{\alpha_s C_F}{2\pi} [F(x, x_0, b_{\perp}, \mu)]_+ + \frac{\alpha_s C_F}{2\pi} \delta(x - x_0) \\ &\times \left\{ -\frac{L_b^2}{2} + L_b \left[\frac{5}{2} + \ln \frac{\mu^2}{-\sqrt{\zeta_z \bar{\zeta}_z} \pm i0} \right] - \frac{3}{2} - \frac{\pi^2}{2} \right. \\ &\left. + \left[-\frac{1}{4} \ln^2 \frac{-\zeta_z \pm i0}{\mu^2} + \frac{1}{2} \ln \frac{-\zeta_z \pm i0}{\mu^2} + (\zeta_z \rightarrow \bar{\zeta}_z) \right] \right\}. \end{aligned}$$

The imaginary parts are all caused by the rapidity logarithms in terms of $\frac{(2xP \cdot n_z)^2}{n_z^2} = -(2xP^z)^2$, and the proper $i0$ choices are again determined by the $i0$ prescriptions in the gauge-link propagators that guarantee exponential decay at infinities. The results here are consistent with the off-light-cone WF amplitudes calculated in Ref. [75] through analytic continuation where gauge-links are chosen to be time-like.

The one-loop off-light-cone soft function reads [50],

$$\begin{aligned} S_1^{-(1)}(b_{\perp}, \mu, Y, Y') &= \frac{\alpha_s C_F}{\pi} [1 - (Y + Y')] L_b, \quad (69) \\ S_1^{+(1)}(b_{\perp}, \mu, Y, Y') &= \frac{\alpha_s C_F}{\pi} [1 - i\pi - (Y + Y')] L_b, \quad (70) \end{aligned}$$

from which the reduced soft function can be extracted as

$$S_{r1}^{(1)}(b_{\perp}, \mu) = -\frac{\alpha_s C_F}{\pi} L_b. \quad (71)$$

These results are the same as the case of TMDPDFs. From these one can extract the one-loop value of $\Gamma_S = \alpha_s C_F/\pi$, while and at two-loop level one has

$$\Gamma_S^{(2)} = \frac{\alpha_s^2}{\pi^2} \left[C_F C_A \left(-\frac{49}{36} + \frac{\pi^2}{12} - \frac{\zeta_3}{2} \right) + C_F N_F \frac{5}{18} \right], \quad (72)$$

which can be extracted from the generic results in [76].

The matching formula between the quasi-LFWF amplitude and the light-front one at large P_z is:

$$\begin{aligned} \tilde{\psi}_{\bar{q}q}^{\pm}(x, b_{\perp}, \mu, \zeta_z) S_{r1}^{\frac{1}{2}}(b_{\perp}, \mu) & \quad (73) \\ &= H_1^{\pm}(\zeta_z/\mu^2, \bar{\zeta}_z/\mu^2) e^{\ln \frac{\pm \zeta_z - i0}{\zeta} K(b_{\perp}, \mu)} \psi_{\bar{q}q}^{\pm}(x, b_{\perp}, \mu, \zeta), \end{aligned}$$

where H_1 is the perturbative matching kernel. The physics reason for this factorization formula is similar to that for the TMDPDF: Our un-subtracted quasi-WF amplitude is defined the off-light-cone scheme. By comparing the TMD factorization in both off and on-the-light-cone schemes, one obtains the matching formula above. See Fig. 8 for a depiction of the corresponding leading region.

Combining the RGEs for the WF amplitude, the reduced soft function, and the quasi-WF amplitude, the

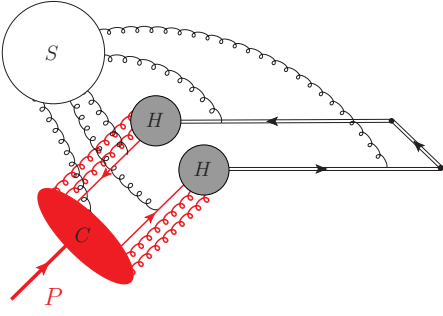

FIG. 8. The leading region for quasi-WF amplitude $\tilde{\psi}_{\bar{q}q}^-$ for a pseudo-scalar meson, where C is the collinear sub-diagram, S is the soft sub-diagram and H are the hard sub-diagrams. Similar to the general cases, the two hard-cores are disconnected with each-other, therefore the momentum fractions of the quasi-WF amplitudes and physical WF amplitudes are the same.

matching kernel satisfies a simple renormalization group equation:

$$\begin{aligned} & \mu^2 \frac{d}{d\mu^2} \ln H_1^\pm(\zeta_z/\mu^2, \bar{\zeta}_z/\mu^2) \\ &= \frac{1}{2} \Gamma_{\text{cusp}}(\alpha_s) \ln \frac{-\sqrt{\zeta_z \bar{\zeta}_z} \pm i0}{\mu^2} + \frac{1}{2} \gamma_C(\alpha_s), \end{aligned} \quad (74)$$

where $\gamma_C(\alpha_s) = 2\gamma_F(\alpha_s) - \Gamma_S(\alpha_s) + 2\gamma_H(\alpha_s)$ with $\gamma_F(\alpha_s)$ the anomalous dimension for heavy-light current and $\Gamma_S(\alpha_s)$ the constant part for the cusp anomalous dimension at large cusp angle, and $\gamma_H(\alpha_s)$ the hard-anomalous dimension.

It is convenient to write the matching kernel in the exponential form, $H = e^h$. At one-loop level, h can be extracted as:

$$\begin{aligned} & h_1^{\pm(1)}(\zeta_z/\mu^2, \bar{\zeta}_z/\mu^2) \\ &= \alpha_s \left\{ c_1 + \frac{C_F}{4\pi} \left[\ell_\pm + \bar{\ell}_\pm - \frac{1}{2}(\ell_\pm^2 + \bar{\ell}_\pm^2) \right] \right\}. \end{aligned} \quad (75)$$

At two-loop level, we anticipate

$$\begin{aligned} & h_1^{\pm(2)}(\zeta_z/\mu^2, \bar{\zeta}_z/\mu^2) \\ &= \alpha_s^2 c_2 - \frac{1}{4} \left[\gamma_C^{(2)} - \alpha_s^2 \beta_0 c_1 \right] (\ell_\pm + \bar{\ell}_\pm) \\ & - \frac{1}{8} \left[\Gamma_{\text{cusp}}^{(2)} - \frac{\alpha_s^2 \beta_0 C_F}{2\pi} \right] (\ell_\pm^2 + \bar{\ell}_\pm^2) - \frac{\alpha_s^2 \beta_0 C_F}{48\pi} (\ell_\pm^3 + \bar{\ell}_\pm^3), \end{aligned} \quad (76)$$

where we have $\ell_\pm = \ln \frac{-\zeta_z \pm i0}{\mu^2}$ and $\bar{\ell}_\pm = \ln \frac{-\bar{\zeta}_z \pm i0}{\mu^2}$. $\beta_0 = -(\frac{11}{3}C_A - \frac{4}{3}N_f T_F)/(2\pi)$ is the coefficient of one-loop β -function, $c_1 = \frac{C_F}{2\pi} \left(-\frac{5\pi^2}{12} - 2 \right)$ and c_2 are constants.

The generalization to the lowest Fock component of the nucleon state can be done similarly [48]. The WF amplitudes depend on two transverse separations $\vec{b}_{1\perp}, \vec{b}_{2\perp}$ and three momentum fractions $x_1 + x_2 + x_3 = 1$. And the soft function S_2 in each light-cone direction now consists of

three gauge-links in fundamental representation, piecing together by the SU(3) invariant tensor ϵ^{ijk} . Previous discussions on the nucleon form factors and wave-functions can be found in [15–18, 21]. The nucleon WF amplitude has also been discussed and calculated in various LF phenomenology models [77, 78]. The LaMET formalism allows a first-principle determination of the amplitude following the general procedures discussed above.

VI. CONCLUSION

In this paper, we present the LaMET formulation for computing LFWF amplitudes in QCD. We first reviewed the LFQ approach to QCD and its conceptual difficulties, especially the LF divergence related to small k^+ modes. These difficulties signals that the QFT on the LF must be viewed as an effective theory in which small k^+ modes are “integrated out”. The LaMET provides a “two-step” approach to the LFQ physics and achieves the goal of LFQ without performing the LFQ explicitly.

We then formulate the LFWF amplitudes as gauge-invariant LF correlators. To maintain gauge-invariance, light-like gauge-links extending to infinities are required in their definitions and leads to rapidity divergences which must be regulated through rapidity regulators. The naive LFWF amplitudes depends on the non-physical rapidity regulator, which must be removed with the help of generalized soft functions composed of arbitrary numbers of Wilson-line cusps. By combining the un-subtracted WF amplitudes with square-root of generalized soft functions, one can construct the scheme-independent WF amplitudes that can be used in factorization formulas for physical quantities. Similar to the TMDPDFs, the physical WF amplitudes depends on additional rapidity scales the evolution of which is controlled by the CS kernels. Results for the $q\bar{q}$ wave function for a pseudo-scalar meson are presented in detail as an application of the general principles.

After introducing a standard version of LFWF amplitudes, we start to present their LaMET formulation. We carefully define the quasi-LF amplitudes in which operator and gauge-links are all time-independent. The large hadron momentum P^z plays the role of a physical off-light-cone regulator. At large P^z , the quasi-LFWF amplitudes can be matched to the physical LFWF amplitudes by subtracting out the off-light-cone scheme dependency with the help of reduced soft functions. We introduce the generalized off-light-cone soft function and their properties, and study the factorization of quasi-WF amplitudes. The factorization formula is presented and supported by a sketch of its proof. As an application of the factorization formula, we show that the Collins-Soper kernels can be extracted from ratio of quasi-WF amplitudes in which the soft function contribution cancels. Again, results for the pseudo-scalar meson wave functions are presented in details, including a prediction of two-loop matching kernel.

Acknowledgment.—We thank M. Burkhardt, W. Wang, Feng Yuan, Jianhui Zhang and Yong Zhao for

valuable discussions. This work is supported partially by the US DOE, Office of Science, grant DE-SC0020682.

-
- [1] Stanley J. Brodsky, Hans-Christian Pauli, and Stephen S. Pinsky, “Quantum chromodynamics and other field theories on the light cone,” *Phys. Rept.* **301**, 299–486 (1998), arXiv:hep-ph/9705477 [hep-ph].
- [2] Noboru Nakanishi and Haruichi Yabuki, “Null-Plane Quantization and Haag’s Theorem,” *Lett. Math. Phys.* **1**, 371–374 (1977).
- [3] Noboru Nakanishi and Koichi Yamawaki, “A Consistent Formulation of the Null-Plane Quantum Field Theory,” *Nucl. Phys.* **B122**, 15–28 (1977).
- [4] Xiangdong Ji, “Fundamental Properties of the Proton in Light-Front Zero Modes,” *Nucl. Phys.* **B**, 115181 (2020), arXiv:2003.04478 [hep-ph].
- [5] Th. Heinzl, St. Krusche, and E. Warner, “Non-trivial vacuum structure in light-cone quantum field theory,” *Nucl. Phys.* **A532**, 429–434 (1991).
- [6] Koichi Yamawaki, “Zero mode problem on the light front,” in *QCD, light cone physics and hadron phenomenology. Proceedings, 10th Nuclear Summer School and Symposium, NuSS’97, Seoul, Korea, June 23-28, 1997* (1998) pp. 116–199, arXiv:hep-th/9802037 [hep-th].
- [7] Xiangdong Ji, “Parton Physics on a Euclidean Lattice,” *Phys. Rev. Lett.* **110**, 262002 (2013), arXiv:1305.1539 [hep-ph].
- [8] Xiangdong Ji, “Parton Physics from Large-Momentum Effective Field Theory,” *Sci. China Phys. Mech. Astron.* **57**, 1407–1412 (2014), arXiv:1404.6680 [hep-ph].
- [9] Krzysztof Cichy and Martha Constantinou, “A guide to light-cone PDFs from Lattice QCD: an overview of approaches, techniques and results,” *Adv. High Energy Phys.* **2019**, 3036904 (2019), arXiv:1811.07248 [hep-lat].
- [10] Xiangdong Ji, Yizhuang Liu, Yu-Sheng Liu, Jian-Hui Zhang, and Yong Zhao, “Large-Momentum Effective Theory,” (2020), arXiv:2004.03543 [hep-ph].
- [11] G. Peter Lepage and Stanley J. Brodsky, “Exclusive Processes in Quantum Chromodynamics: Evolution Equations for Hadronic Wave Functions and the Form-Factors of Mesons,” *Phys. Lett.* **87B**, 359–365 (1979).
- [12] G. Peter Lepage and Stanley J. Brodsky, “Exclusive Processes in Perturbative Quantum Chromodynamics,” *Phys. Rev.* **D22**, 2157 (1980).
- [13] Hsiang-nan Li and George F. Sterman, “The Perturbative pion form-factor with Sudakov suppression,” *Nucl. Phys.* **B381**, 129–140 (1992).
- [14] A. V. Efremov and A. V. Radyushkin, “Factorization and Asymptotical Behavior of Pion Form-Factor in QCD,” *Phys. Lett.* **94B**, 245–250 (1980).
- [15] I. G. Aznaurian, S. V. Esaibegian, and N. L. Ter-Isaakian, “On the asymptotics of the nucleon form factors in the quark-gluon model,” *Phys. Lett.* **90B**, 151 (1980), [Erratum: *Phys. Lett.* **92B**, 371 (1980)].
- [16] Hsiang-nan Li, “Sudakov suppression and the proton form-factor in QCD,” *Phys. Rev.* **D48**, 4243–4254 (1993).
- [17] A. Duncan and Alfred H. Mueller, “Asymptotic Behavior of Composite Particle Form-Factors and the Renormalization Group,” *Phys. Rev.* **D21**, 1636 (1980).
- [18] G. Peter Lepage and Stanley J. Brodsky, “Exclusive Processes in Quantum Chromodynamics: The Form-Factors of Baryons at Large Momentum Transfer,” *Phys. Rev. Lett.* **43**, 545–549 (1979), [Erratum: *Phys. Rev. Lett.* **43**, 1625 (1979)].
- [19] Hsiang-nan Li and Hoi-Lai Yu, “Perturbative QCD analysis of B meson decays,” *Phys. Rev.* **D53**, 2480–2490 (1996), arXiv:hep-ph/9411308 [hep-ph].
- [20] Hsiang-nan Li, Yue-Long Shen, and Yu-Ming Wang, “Next-to-leading-order corrections to $B \rightarrow \pi$ form factors in k_T factorization,” *Phys. Rev.* **D85**, 074004 (2012), arXiv:1201.5066 [hep-ph].
- [21] George F. Sterman and Paul Stoler, “Hadronic form-factors and perturbative QCD,” *Ann. Rev. Nucl. Part. Sci.* **47**, 193–233 (1997), arXiv:hep-ph/9708370 [hep-ph].
- [22] Xiangdong Ji, Yizhuang Liu, and Yu-Sheng Liu, “TMD soft function from large-momentum effective theory,” *Nucl. Phys. B* **955**, 115054 (2020), arXiv:1910.11415 [hep-ph].
- [23] Paul A. M. Dirac, “Forms of Relativistic Dynamics,” *Rev. Mod. Phys.* **21**, 392–399 (1949).
- [24] John B. Kogut and Davison E. Soper, “Quantum Electrodynamics in the Infinite Momentum Frame,” *Phys. Rev.* **D1**, 2901–2913 (1970).
- [25] John Collins, “New definition of TMD parton densities,” *Proceedings, QCD Evolution Workshop on From Collinear to Non-Collinear Case: Newport News, Virginia, April 8-9, 2011*, *Int. J. Mod. Phys. Conf. Ser.* **4**, 85–96 (2011), arXiv:1107.4123 [hep-ph].
- [26] Hans Christian Pauli and Stanley J. Brodsky, “Discretized Light Cone Quantization: Solution to a Field Theory in One Space One Time Dimensions,” *Phys. Rev.* **D32**, 2001 (1985).
- [27] Matthias Burkardt, “Light front quantization of the Sine-Gordon model,” *Phys. Rev.* **D47**, 4628–4633 (1993).
- [28] Gary McCartor, “Schwinger model in the light cone representation,” *Z. Phys.* **C64**, 349–354 (1994), arXiv:hep-th/9406094 [hep-th].
- [29] Koji Harada, Atsushi Okazaki, and Masa-aki Taniguchi, “Mesons in the massive Schwinger model on the light cone,” *Phys. Rev.* **D54**, 7656–7663 (1996), arXiv:hep-th/9509136 [hep-th].
- [30] Alex C. Kalloniatis and David G. Robertson, “Theta vacua in the light cone Schwinger model,” *Phys. Lett.* **B381**, 209–215 (1996), arXiv:hep-th/9602006 [hep-th].
- [31] A. R. Zhitnitsky, “On Chiral Symmetry Breaking in QCD in Two-dimensions ($N_c \rightarrow$ Infinity),” *Phys. Lett.* **165B**, 405–409 (1985), [*Sov. J. Nucl. Phys.* **43**, 999 (1986); *Yad. Fiz.* **43**, 1553 (1986)].
- [32] M. Burkardt, “The Virial Theorem and the Structure of the Deuteron in (1+1)-dimensional QCD on the Light Cone,” *Nucl. Phys.* **A504**, 762–776 (1989).
- [33] Prem P. Srivastava and Stanley J. Brodsky, “Light front quantized QCD in light cone gauge,” *Phys. Rev.* **D64**, 045006 (2001), arXiv:hep-ph/0011372 [hep-ph].
- [34] A. Harindranath and J. P. Vary, “SOLVING TWO-DIMENSIONAL Φ^4 THEORY BY DISCRETIZED LIGHT FRONT QUANTIZATION,” *Phys. Rev.* **D36**,

- 1141–1147 (1987).
- [35] John Collins, “The non-triviality of the vacuum in light-front quantization: An elementary treatment,” (2018), arXiv:1801.03960 [hep-ph].
- [36] Kenneth G. Wilson, Timothy S. Walhout, Avaroth Harindranath, Wei-Min Zhang, Robert J. Perry, and Stanislaw D. Glazek, “Nonperturbative QCD: A Weak coupling treatment on the light front,” *Phys. Rev.* **D49**, 6720–6766 (1994), arXiv:hep-th/9401153 [hep-th].
- [37] John Collins, “Foundations of perturbative QCD,” *Camb. Monogr. Part. Phys. Nucl. Phys. Cosmol.* **32**, 1–624 (2011).
- [38] Alexey Vladimirov, “Soft factors for double parton scattering at NNLO,” *JHEP* **12**, 038 (2016), arXiv:1608.04920 [hep-ph].
- [39] Alexey Vladimirov, “Structure of rapidity divergences in multi-parton scattering soft factors,” *JHEP* **04**, 045 (2018), arXiv:1707.07606 [hep-ph].
- [40] Alex Langnau and M. Burkardt, “Ultraviolet regularization of light cone Hamiltonian perturbation theory: Application to the anomalous magnetic moment of the electron ($g-2$) in light cone gauge,” *Phys. Rev.* **D47**, 3452–3464 (1993).
- [41] E. A. Kuraev, L. N. Lipatov, and Victor S. Fadin, “Multi - Reggeon Processes in the Yang-Mills Theory,” *Sov. Phys. JETP* **44**, 443–450 (1976).
- [42] I. I. Balitsky and L. N. Lipatov, “The Pomernchuk Singularity in Quantum Chromodynamics,” *Sov. J. Nucl. Phys.* **28**, 822–829 (1978).
- [43] L. N. Lipatov, “The Bare Pomeron in Quantum Chromodynamics,” *Sov. Phys. JETP* **63**, 904–912 (1986).
- [44] Alfred H. Mueller, “Soft gluons in the infinite momentum wave function and the BFKL pomeron,” *Nucl. Phys.* **B415**, 373–385 (1994).
- [45] Christian W. Bauer, Sean Fleming, Dan Pirjol, and Iain W. Stewart, “An Effective field theory for collinear and soft gluons: Heavy to light decays,” *Phys. Rev. D* **63**, 114020 (2001), arXiv:hep-ph/0011336.
- [46] Christian W. Bauer, Dan Pirjol, and Iain W. Stewart, “Soft collinear factorization in effective field theory,” *Phys. Rev. D* **65**, 054022 (2002), arXiv:hep-ph/0109045.
- [47] Xiangdong Ji, Peng Sun, Xiaonu Xiong, and Feng Yuan, “Soft factor subtraction and transverse momentum dependent parton distributions on the lattice,” *Phys. Rev.* **D91**, 074009 (2015), arXiv:1405.7640 [hep-ph].
- [48] Xiang-dong Ji, Jian-Ping Ma, and Feng Yuan, “Three quark light cone amplitudes of the proton and quark orbital motion dependent observables,” *Nucl. Phys. B* **652**, 383–404 (2003), arXiv:hep-ph/0210430.
- [49] Andrei V. Belitsky, X. Ji, and F. Yuan, “Final state interactions and gauge invariant parton distributions,” *Nucl. Phys. B* **656**, 165–198 (2003), arXiv:hep-ph/0208038.
- [50] Markus A. Ebert, Iain W. Stewart, and Yong Zhao, “Towards Quasi-Transverse Momentum Dependent PDFs Computable on the Lattice,” *JHEP* **09**, 037 (2019), arXiv:1901.03685 [hep-ph].
- [51] Miguel G. Echevarria, Ignazio Scimemi, and Alexey Vladimirov, “Transverse momentum dependent fragmentation function at next-to-next-to-leading order,” *Phys. Rev. D* **93**, 011502 (2016), [Erratum: *Phys. Rev. D* **94**, 099904 (2016)], arXiv:1509.06392 [hep-ph].
- [52] Miguel G. Echevarria, Ignazio Scimemi, and Alexey Vladimirov, “Universal transverse momentum dependent soft function at NNLO,” *Phys. Rev.* **D93**, 054004 (2016), arXiv:1511.05590 [hep-ph].
- [53] Alexey A. Vladimirov, “Self-contained definition of the Collins-Soper kernel,” *Phys. Rev. Lett.* **125**, 192002 (2020), arXiv:2003.02288 [hep-ph].
- [54] Ye Li, Duff Neill, and Hua Xing Zhu, “An exponential regulator for rapidity divergences,” *Nucl. Phys. B* **960**, 115193 (2020), arXiv:1604.00392 [hep-ph].
- [55] Jui-Yu Chiu, Ambar Jain, Duff Neill, and Ira Z. Rothstein, “A Formalism for the Systematic Treatment of Rapidity Logarithms in Quantum Field Theory,” *JHEP* **05**, 084 (2012), arXiv:1202.0814 [hep-ph].
- [56] Thomas Becher and Matthias Neubert, “Drell-Yan Production at Small q_T , Transverse Parton Distributions and the Collinear Anomaly,” *Eur. Phys. J. C* **71**, 1665 (2011), arXiv:1007.4005 [hep-ph].
- [57] John C. Collins and Davison E. Soper, “Back-To-Back Jets in QCD,” *Nucl. Phys.* **B193**, 381 (1981), [Erratum: *Nucl. Phys.* **B213**, 545 (1983)].
- [58] Xiang-dong Ji, Jian-ping Ma, and Feng Yuan, “QCD factorization for semi-inclusive deep-inelastic scattering at low transverse momentum,” *Phys. Rev. D* **71**, 034005 (2005), arXiv:hep-ph/0404183.
- [59] Xiang-dong Ji, Jian-Ping Ma, and Feng Yuan, “QCD factorization for spin-dependent cross sections in DIS and Drell-Yan processes at low transverse momentum,” *Phys. Lett. B* **597**, 299–308 (2004), arXiv:hep-ph/0405085.
- [60] John C. Collins and Andreas Metz, “Universality of soft and collinear factors in hard-scattering factorization,” *Phys. Rev. Lett.* **93**, 252001 (2004), arXiv:hep-ph/0408249 [hep-ph].
- [61] Yuri V. Kovchegov and Eugene Levin, “Quantum chromodynamics at high energy,” *Camb. Monogr. Part. Phys. Nucl. Phys. Cosmol.* **33**, 1–350 (2012).
- [62] I. Balitsky, “Operator expansion for high-energy scattering,” *Nucl. Phys. B* **463**, 99–160 (1996), arXiv:hep-ph/9509348.
- [63] Yuri V. Kovchegov, “Unitarization of the BFKL pomeron on a nucleus,” *Phys. Rev. D* **61**, 074018 (2000), arXiv:hep-ph/9905214.
- [64] A. Banfi, G. Marchesini, and G. Smye, “Away from jet energy flow,” *JHEP* **08**, 006 (2002), arXiv:hep-ph/0206076.
- [65] Alexander M. Polyakov, “Gauge Fields as Rings of Glue,” *Nucl. Phys. B* **164**, 171–188 (1980).
- [66] G. P. Korchemsky and A. V. Radyushkin, “Renormalization of the Wilson Loops Beyond the Leading Order,” *Nucl. Phys.* **B283**, 342–364 (1987).
- [67] I. A. Korchemskaya and G. P. Korchemsky, “On lightlike Wilson loops,” *Phys. Lett. B* **287**, 169–175 (1992).
- [68] J. Collins, L. Gamberg, A. Prokudin, T. C. Rogers, N. Sato, and B. Wang, “Relating Transverse Momentum Dependent and Collinear Factorization Theorems in a Generalized Formalism,” *Phys. Rev. D* **94**, 034014 (2016), arXiv:1605.00671 [hep-ph].
- [69] Xiangdong Ji, Yizhuang Liu, and Yu-Sheng Liu, “Transverse-momentum-dependent parton distribution functions from large-momentum effective theory,” *Phys. Lett. B* **811**, 135946 (2020), arXiv:1911.03840 [hep-ph].
- [70] Alexey A. Vladimirov and Andreas Schäfer, “Transverse momentum dependent factorization for lattice observables,” *Phys. Rev. D* **101**, 074517 (2020), arXiv:2002.07527 [hep-ph].
- [71] Markus A. Ebert, Iain W. Stewart, and Yong Zhao,

- “Determining the Nonperturbative Collins-Soper Kernel From Lattice QCD,” *Phys. Rev.* **D99**, 034505 (2019), arXiv:1811.00026 [hep-ph].
- [72] Miguel G. Echevarría, Ahmad Idilbi, and Ignazio Scimemi, “Soft and Collinear Factorization and Transverse Momentum Dependent Parton Distribution Functions,” *Phys. Lett. B* **726**, 795–801 (2013), arXiv:1211.1947 [hep-ph].
- [73] Johannes M. Henn, Gregory P. Korchemsky, and Bernhard Mistlberger, “The full four-loop cusp anomalous dimension in $\mathcal{N} = 4$ super Yang-Mills and QCD,” *JHEP* **04**, 018 (2020), arXiv:1911.10174 [hep-th].
- [74] Andreas von Manteuffel, Erik Panzer, and Robert M. Schabinger, “Cusp and collinear anomalous dimensions in four-loop QCD from form factors,” *Phys. Rev. Lett.* **124**, 162001 (2020), arXiv:2002.04617 [hep-ph].
- [75] J. P. Ma and Q. Wang, “On Transverse-Momentum Dependent Light-Cone Wave Functions of Light Mesons,” *Phys. Lett.* **B642**, 232–237 (2006), arXiv:hep-ph/0605075 [hep-ph].
- [76] Andrey Grozin, Johannes M. Henn, Gregory P. Korchemsky, and Peter Marquard, “The three-loop cusp anomalous dimension in QCD and its supersymmetric extensions,” *JHEP* **01**, 140 (2016), arXiv:1510.07803 [hep-ph].
- [77] Chandan Mondal, Siqi Xu, Jiangshan Lan, Xingbo Zhao, Yang Li, Dipankar Chakrabarti, and James P. Vary, “Basis light-front quantization approach to nucleon,” in *Light Cone 2019 (LC2019) Palaiseau, France, September 16-20, 2019* (2020) arXiv:2001.04414 [hep-ph].
- [78] Weijie Du, Yang Li, Xingbo Zhao, and James P. Vary, “Dynamical Nucleon-Pion System via Basis Light-Front Quantization,” in *6th International Conference Nuclear Theory in the Supercomputing Era (NTSE-2018) Daejeon, Korea, October 29-November 2, 2018* (2019) arXiv:1908.02237 [nucl-th].