

Quasi-polynomial time approximation of output probabilities of geometrically-local, shallow quantum circuits.

Nolan J. Coble^{*†}, Matthew Coudron[‡]

June 8, 2021

Abstract

We present a classical algorithm that, for any 3D geometrically-local, polylogarithmic-depth quantum circuit C acting on n qubits, and any bit string $x \in \{0, 1\}^n$, can compute the quantity $|\langle x | C | 0^{\otimes n} \rangle|^2$ to within any inverse-polynomial additive error in quasi-polynomial time. It is known that it is $\#P$ -hard to compute this same quantity to within 2^{-n^2} additive error [Mov20, KMM21]. The previous best known algorithm for this problem used $O(2^{n^{1/3}} \text{poly}(1/\epsilon))$ time to compute probabilities to within additive error ϵ [BGM20]. Notably, the [BGM20] paper included an elegant polynomial time algorithm for this estimation task restricted to 2D circuits, which makes a novel use of 1D Matrix Product States (MPS) carefully tailored to the 2D geometry of the circuit in question. Surprisingly, it is not clear that it is possible to extend this use of MPS to address the case of 3D circuits in polynomial time. This raises a natural question as to whether the computational complexity of the 3D problem might be drastically higher than that of the 2D problem. In this work we address this question by exhibiting a quasi-polynomial time algorithm for the 3D case. In order to surpass the technical barriers encountered by previously known techniques we are forced to pursue a novel approach: instead of using MPS techniques, we construct a recursive sub-division of the given 3D circuit using carefully designed block-encodings. To our knowledge this is the first use of the block-encoding technique in a purely classical algorithm.

Our algorithm has a Divide-and-Conquer structure, demonstrating how to approximate the desired quantity via several instantiations of the same problem type, each involving 3D-local circuits on about half the number of qubits as the original. This division step is then applied recursively, expressing the original quantity as a weighted combination of smaller and smaller 3D-local quantum circuits. A central technical challenge is to control correlations arising from entanglement that may exist between the different circuit “pieces” produced this way. We believe that the division step, which makes use of block-encodings [GSLW19, LC16, AG19], together with an Inclusion-Exclusion argument to reduce error in each recursive approximation, may be of independent interest.

*Authors are listed alphabetically.

[†]ncoble@terpmail.umd.edu

[‡]mcoudron@umd.edu - Corresponding Author

1 Introduction

Many schemes for obtaining a quantum computational advantage with near-term quantum hardware are motivated by mathematical results proving the computational hardness of sampling from near-term quantum circuits. In this work we consider quantum circuits which are geometrically local and have polylogarithmic circuit-depth. It is known to be $\#P$ -hard to compute output probabilities of n -qubit, geometrically-local, constant-depth quantum circuits to within 2^{-n^2} additive error [Mov20], a result which builds on an extensive line of research focusing on the hardness of sampling from quantum circuits [AA11, BJS11, BMS17, NSC⁺17, BFN19]. It has even been shown, under several computational assumptions, that there is no classical polynomial time algorithm which, given a geometrically-local, constant-depth quantum circuit, K , can produce samples whose distribution lies within a constant, in the ℓ_1 distance, of the output distribution of K in the computational basis [BVHS⁺18].

On the other hand, a series of works on the classical complexity of sampling from near-term quantum circuits, and related tasks, highlights the subtle nature of identifying an actual quantum advantage based on these tasks [DHKLP20, HZN⁺20, NPD⁺20]. These results frame the significance of the algorithm presented as Theorem 5 in [BGM20], which estimates output probabilities of 2D-local constant depth circuits to inverse polynomial additive error in polynomial time. In fact, the original algorithm in [BGM20], actually estimates quantities of the form $\langle 0^{\otimes n} | C^\dagger (\otimes_{i=1}^n P_i) C | 0^{\otimes n} \rangle$, where each $P_i \in \{X, Y, Z, I\}$ is a single-qubit Pauli observable operator. However, it is straightforward to convert their algorithm to compute the quantity $\langle 0^{\otimes n} | C^\dagger (\otimes_{i=1}^n |x_i\rangle \langle x_i|) C | 0^{\otimes n} \rangle = |\langle x | C | 0^{\otimes n} \rangle|^2$, $x \in \{0, 1\}^n$, instead. Theorem 5 of [BGM20] constitutes a pertinent observation. While it is hard to sample from constant-depth quantum circuits, it is still unresolved whether it is hard to estimate any property of such a circuit which could have been computed using a polynomial number of samples from the output of the quantum circuit itself. In particular: A polynomial number of samples from a 2D-local, constant-depth quantum circuit only allows one to estimate output probabilities of that circuit to inverse polynomial additive error. But, it is shown in Theorem 5 of [BGM20] that this same task can be done in classical polynomial time! One might ask: Is there a well-defined Decision problem which can be solved using only a polynomial number of samples from such a quantum circuit, together with classical post-processing, and yet cannot also be efficiently solved using classical computing alone? This is unknown.

We note, at this point, some basic facts about the task of computing the quantity $|\langle 0^{\otimes n} | C | 0^{\otimes n} \rangle|^2$ which explain why we can focus on this task WLOG, and may motivate our interest in it:

- If there is an algorithm to estimate the quantity $|\langle 0^{\otimes n} | C | 0^{\otimes n} \rangle|^2$, for any 3D-local depth- d quantum circuit C , then that algorithm can be used to estimate $|\langle x | C | 0^{\otimes n} \rangle|^2$ for any $x \in \{0, 1\}^n$. The reason is that $|\langle x | C | 0^{\otimes n} \rangle|^2 = |\langle 0^{\otimes n} | G | 0^{\otimes n} \rangle|^2$ where G is taken to be the 3D-local circuit $G \equiv C (\otimes_{i=1}^n X^{x_i})$. Here X represents the single qubit Pauli operator σ_X . Note that G is still a depth- $O(d)$ quantum circuit.
- Any such algorithm can also estimate $|\langle 0^{\otimes n} | CZ^n C^\dagger | 0^{\otimes n} \rangle|^2$, which is the magnitude of the expected bias of the Parity of the output bits of C , when measured in the computational basis. This is true by virtue of the fact that $CZ^n C^\dagger$ is, itself, a 3D local, depth- $O(d)$ circuit. So, this type of computational problem allows us to study the power of depth- d geometrically-local, quantum circuits combined with certain limited types of classical post-processing, like the Parity function.

- The algorithm we present in this work can easily be modified to approximate marginal probabilities (e.g., the probability that $x_1 = 1$ for $x \in \{0, 1\}^n$ sampled from the given circuit, etc). Consequently, it is straightforward to use this algorithm to search for all $x \in \{0, 1\}^n$ which have probability at least δ in the output distribution of a given depth- d geometrically-local circuit C . That is, searching for all of the “ δ -heavy” strings of C . When $\delta = 1/\text{poly}(n)$ there can be at most $\text{poly}(n)$ such strings and our algorithm can find them all in quasi-polynomial time.

The algorithm for 2D circuits presented in Theorem 5 of [BGM20] makes a novel use of 1D Matrix Product States, carefully tailored to the 2D geometry of the circuit in question. However, the authors of [BGM20] point out that it is not clear that it is possible to extend this use of MPS to address the case of 3D circuits in polynomial time. Instead they provide a sub-exponential time algorithm for the 3D case, which has time complexity $O(2^{n^{1/3}} \text{poly}(1/\epsilon))$ for computing the desired quantity to within additive error ϵ . In this work we introduce a new set of techniques culminating in a divide-and-conquer algorithm which solves the 3D case in quasi-polynomial time.

Our algorithm has a divide-and-conquer structure with the goal being to divide the circuit C into pieces, and reduce the original problem to a small number of new 3D-circuit problems involving circuits on only a fraction of the number of qubits as the original. This division step requires the ability to construct Schmidt vectors of the state $C |0^{\otimes n}\rangle$, across a given cut, via a depth- d geometrically-local quantum circuit, so that the new subproblems can be expressed as smaller instantiations of the original problem type. We accomplish this through the use of block-encodings, a technique designed for quantum algorithms [GSLW19, LC16, AG19, LMR14, KLL⁺17], but used here as a subroutine of a classical simulation algorithm instead. However, to date, we are only able to construct, as a block-encoding circuit, the *leading* Schmidt vector across certain “heavy” cuts. Due to this restriction we are forced to use a novel division step in our Divide-and-Conquer approach. Instead of dividing about a single cut and constructing many of its Schmidt vectors as depth- d geometrically-local block-encodings, we must divide across many cuts and construct only their leading Schmidt vectors. Interestingly, this process can still lead to low approximation error via an Inclusion-Exclusion style argument, as shown in Lemma 18.

These techniques culminate in a worst-case quasi-polynomial time algorithm for 3D circuits, which is our main result:

Theorem 1. *There exists a classical algorithm which, for any 3D geometrically-local, depth- d quantum circuit C on n qubits, can compute the scalar quantity $|\langle 0^{\otimes n} | C |0^{\otimes n}\rangle|^2$ to within $1/n^{\log(n)}$ additive error in time*

$$T(n) = 2^{d^3 \text{polylog}(n)} \tag{1}$$

See Algorithm 1 in Section 5 for a precise definition of this classical algorithm.

Note that our Theorem statement gives an inverse quasi-polynomial additive error approximation. This is, therefore, asymptotically better than an inverse polynomial additive approximation for any polynomial. There is a more explicit trade-off between runtime and approximation error given in Theorem 28, and in fact, Theorem 1 follows from Theorem 28 with $\delta = 1/n^{\log(n)}$, but we use the above statement here for simplicity. Note also, when the depth, d , is polylogarithmic our algorithm runs in quasi-polynomial time.

2 Dividing the Cube: Some Notation

Given a 3D-local, depth- d circuit C , we wish to estimate the quantity $|\langle 0^{\otimes n} | C |0^{\otimes n}\rangle|^2$. To begin our divide-and-conquer approach we will divide the circuit C in half via a cut through the center

as shown in Figure 1. The width of the cut is dependent on d , and we will discuss how to select this width below. To begin with, we make the width large enough to have the non-empty sets B , M , and F defined below.

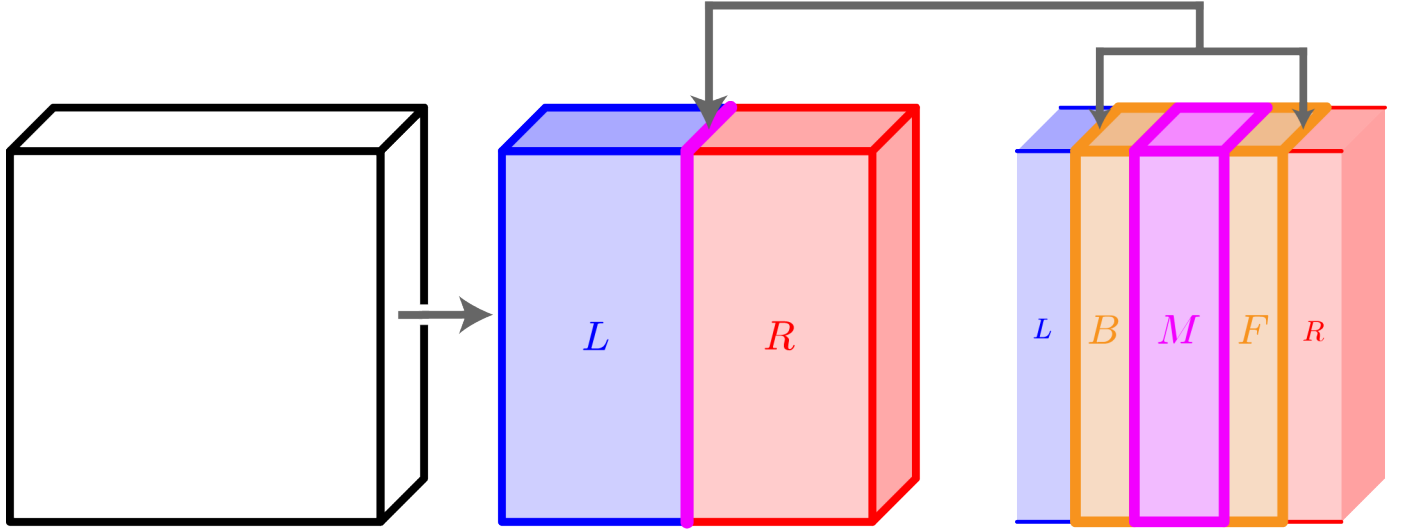

Figure 1: Cutting the Cube: (left) 3D cube of qubits. (center) Choose a location to cut the qubits. The qubits to the left and right of the cut are denoted by L and R , respectively. (right) Within the cut there are three regions: a center region M and regions to the left and right of M , denoted by B and F , respectively.

Definition 2 (M , B , F , R , and L (see Figure 1)). Let M be the set of all qubits in the “Middle of the cut” (the middle part of the cut which is not in the lightcone of qubits from outside the cut). Let B be the set of all qubits within the cut which are to the left of M . Let F be the set of all qubits within the cut which are to the right of M . We will choose the width of M to be $O(d)$ such that the lightcones of B and F are disjoint. We will choose the widths of B and F to be $O(d)$ such that the lightcone of M is contained in $B \cup M \cup F$. For concreteness we set the width of each of B , M , F to be $10d$. Since C is geometrically-local, this is sufficiently large width to satisfy the above conditions on lightcones.

Let L be all qubits outside the cut which are to the left of the cut (that is, to the left of B). The set L is colored blue. Let R be the set of all qubits outside to the right of the cut (that is, to the right of F). The set R is colored red.

We will now define a 2D geometrically local, depth- d circuit C_{BUMUF} which can be thought of as the sub-circuit of C which lies within the light-cone of M . Intuitively this circuit captures all of the local information that must be accounted for in the division step across this particular slice in our divide-and-conquer algorithm.

Definition 3 (C_{BUMUF}). Now, let us begin with the all zeroes state on all the qubits $|0\rangle_{LUBUMUFUR} = |0_{ALL}\rangle$, and apply the minimum number of gates from the circuit C such that every gate on the qubits within M has been applied. We will call this unitary C_{BUMUF} . Note that this unitary does not act on any qubits outside of $B \cup M \cup F$. This is because the lightcone of M is contained in $B \cup M \cup F$ by Definition 2. Note that C_{BUMUF} can be thought of as an approximately 2D (not

3D) geometrically-local, depth- d circuit, since the third dimension of the circuit is $O(d)$ which for $d = \text{polylog}(n)$ grows asymptotically slower than $O(n^{1/3})$.

We define C_{LUR} to be the unitary composed of the remainder of the gates of C not yet applied in C_{BUMUF} , so that $C = C_{LUR} \circ C_{BUMUF}$. We define C_L (resp. C_R) to be the unitaries composed of the remainder of the gates of C not yet applied in C_{BUMUF} and which lie to the left (resp. right) of the M . Note that $C_L \circ C_R = C_{LUR}$ since none of the circuits C_L, C_R, C_{LUR} act non-trivially on M . See Figure 2 for an illustration of these unitaries with a 1D geometrically-local circuit, and Figure 3 for an illustration in a 2D circuit.

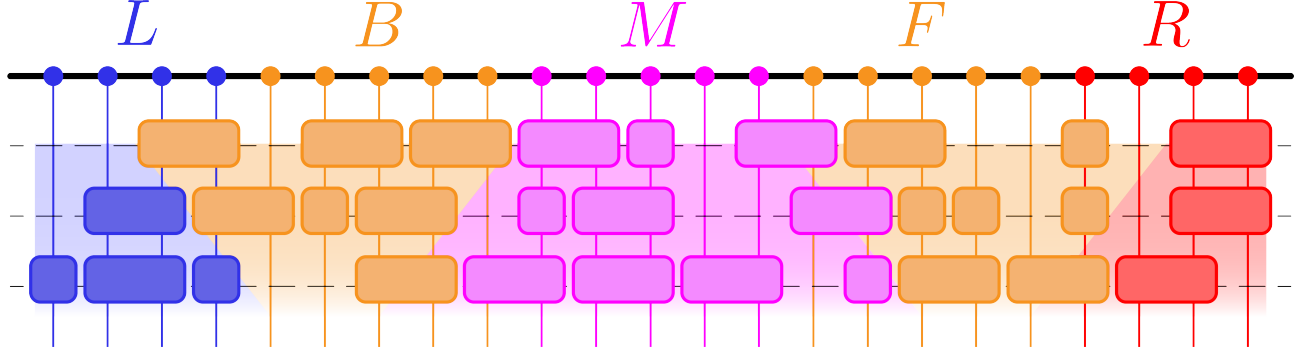

Figure 2: Block depiction of the unitaries defined in Definition 3 and Definition 5 for the case of a 1D geometrically-local constant-depth circuit C . Here the vertical dimension represents the depth of the circuit, so the rectangle has the same dimensions as the circuit diagram would. C_{BUMUF} is defined to be the unitary produced by the gates in the lightcone of M , which are colored **magenta** in this diagram. The unitaries $C_{wrap}, C_{L-wrap}, C_{R-wrap}$, formally defined in Definition 5, are also depicted here. C_{wrap} is the unitary consisting of all the **orange** gates in the diagram, and C_{L-wrap} (resp. C_{R-wrap}) is the unitary consisting of all the **orange** gates acting on the left (resp. right) of M . Furthermore, C'_L (resp. C'_R) denote the unitaries consisting of all the **blue** (resp. **red**) gates to the left (resp. right) of M in the diagram. We also illustrate the 2D case in Figure 3 below.

The sub-normalized quantum state produced by C_{BUMUF} , defined below, is the state whose Schmidt decomposition we consider in our division step.

Definition 4. Let $|\psi\rangle_{BUF} \equiv \langle 0|_M C_{BUMUF} |0\rangle_{BUMUF}$.

Note that, $\langle 0|_{ALL} C_{LUR} |0\rangle_{LUR} \otimes |\psi\rangle_{BUF} = \langle 0|_{ALL} C |0\rangle_{ALL}$.

(Throughout this document, the notation $|0_{ALL}\rangle$ will refer to the zero state on all unmeasured qubits for a given state. It's meaning will be clear from context.)

Definition 5 (C_{Wrap}). Define a new unitary C_{Wrap} which consists of all the gates from C which are in the reverse light-cone of $B \cup M \cup F$, but not in C_{BUMUF} itself. That is, let C_{L-wrap} (resp. C_{R-wrap}) be the unitary consisting of all the of the gates in C which are in the reverse light-cone of B (resp. F), but not in C_{BUMUF} itself, and let $C_{Wrap} \equiv C_{L-wrap} \circ C_{R-wrap}$. Therefore,

$$C_{Wrap}^\dagger \circ C = C'_L \circ C_{BUMUF} \circ C'_R \quad (2)$$

Where $C'_L \equiv C_{L-wrap}^\dagger \circ C_L$ (see Definition 3 for the definition of C_L) is a unitary acting only on L (the remaining, untouched gates of C within L), and $C'_R \equiv C_{R-wrap}^\dagger \circ C_R$ (see Definition 3 for

the definition of C_R) is a unitary acting only on R (the remaining, untouched gates of C within R). Since C is depth- d it is clear that every qubit in the non-trivial support of C_{Wrap} lies within some $O(d)$ distance of M . Let R^{Wrap} (resp. L^{Wrap}) be the subset of qubits in R (resp. L) that lie in the non-trivial support of C_{Wrap} . In other words, R^{Wrap} (resp. L^{Wrap}) is the non-trivial support of C_{R-Wrap} (resp. C_{L-Wrap}). See Figure 2 for an illustration of these unitaries with a 1D geometrically-local circuit, and Figure 3 for an illustration in a 2D circuit.

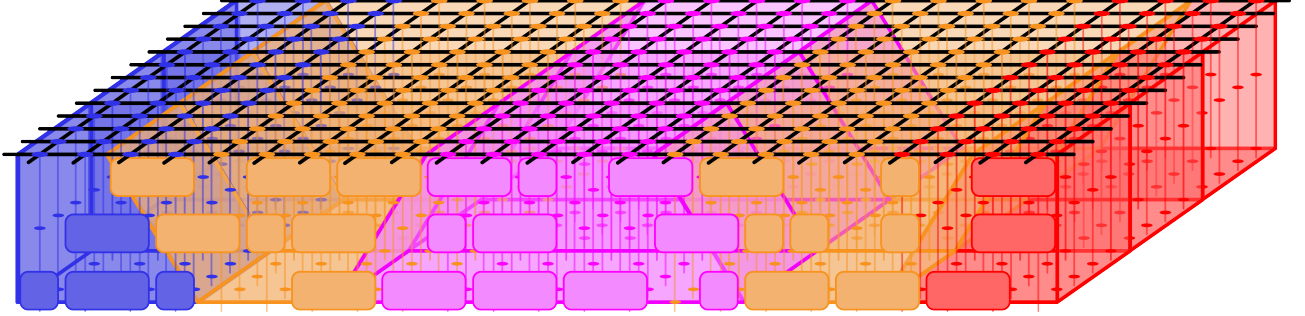

Figure 3: Geometric depiction of the unitaries defined in Definition 3 and Definition 5 for the case of a 2D grid of qubits. Here the vertical dimension represents the depth of the circuit, so the rectangular prism has the same dimensions as the circuit diagram would. We do not have an analogous figure for 3D circuits, which are the main focus of this work, because it would require 4 dimensions to illustrate. However, we believe the reader will gain sufficient intuition for the definitions from the 1D and 2D diagrams.

3 Divide and Conquer: Schmidt Vectors and Block Encodings

In this section we will show how to construct a geometrically-local, shallow quantum circuit for the largest Schmidt vector of the unnormalized state $\langle 0_M | C | 0_{ALL} \rangle$ across the cut M , in the case that the largest Schmidt coefficient is very large. Let us begin, however, by outlining the intuition behind our divide-and-conquer approach, which explains why we are interested in approximating Schmidt vectors via shallow quantum circuits in the first place. Consider expanding the quantity $\langle 0_{ALL} | C | 0_{ALL} \rangle = \langle 0_{ALL} | C_{LUR} | 0 \rangle_{LUR} \otimes |\psi \rangle_{BUF}$ as a sum over the Schmidt decomposition of $|\psi \rangle_{BUF}$ across the cut M . Suppose, that $|\psi \rangle_{BUF}$ has almost all of its weight on the top polynomially many Schmidt vectors (In Section 4 we will show that, in fact, we can restrict this part of the analysis WLOG to cases where $|\psi \rangle_{BUF}$ has a large fraction of its weight on λ_1). Then $|\psi \rangle_{BUF} \approx \sum_{i=1}^{p(n)} \lambda_i |v_i \rangle_B \otimes |w_i \rangle_F$, and we have:

$$\langle 0_{ALL} | C_{LUR} | 0 \rangle_{LUR} \otimes |\psi \rangle_{BUF} \approx \sum_{i=1}^{p(n)} \lambda_i \langle 0_{ALL} | C_{LUR} | 0 \rangle_{LUR} \otimes |v_i \rangle_B \otimes |w_i \rangle_F \quad (3)$$

$$= \sum_{i=1}^{p(n)} \lambda_i \langle 0_{LUB} | C_L | 0 \rangle_L \otimes |v_i \rangle_B \cdot \langle 0_{FUR} | C_R | 0 \rangle_R \otimes |w_i \rangle_F, \quad (4)$$

where $\text{ALL} \equiv L \cup B \cup F \cup R$.

Suppose we could produce approximations for the Schmidt vectors $|v_i\rangle_B$ and $|w_i\rangle_F$ via 2D geometrically-local, shallow quantum circuits. Then, the quantity in Equation 4 would be a sum of polynomially many scalar quantities, each of which is the product of output probabilities of two new 3D geometrically-local circuit problems (C_L and C_R). Furthermore, these new 3D circuit problems involve about half the number of qubits as the original problem we were trying to solve. This leads to a divide-and-conquer recursion which can yield a more efficient runtime for the original problem. The base case in this divide-and-conquer algorithm consists of estimating output probabilities of 3D-local, depth- d quantum circuits which have small width (width at most $w = \text{polylog}(n)$) in one of their dimensions. This base case can be solved efficiently using the algorithm from Theorem 5 of [BGM20], as discussed in Remark 6 below.

Note that this divide-and-conquer approach only works if we can produce explicit approximations for the Schmidt vectors $|v_i\rangle_B$ and $|w_i\rangle_F$ via 2D geometrically-local, shallow quantum circuits. In the case when λ_1 is sufficiently large, it turns out that we can at least produce the top Schmidt vectors $|v_1\rangle_B$ and $|w_1\rangle_F$ in this way. (Note, we will also need to compute λ_1 efficiently, and this can also be done using Theorem 5 of [BGM20], as described in Definition 25 and Remark 6.) However, we do not know how to construct 2D geometrically-local, shallow quantum circuits that approximate $|v_i\rangle_B$ and $|w_i\rangle_F$ for $i > 1$, and so we cannot pursue the divide-and-conquer approach described in Equation 4 verbatim. Nonetheless, we will see in Section 4 that just approximating the top Schmidt vectors $|v_1\rangle_B$ and $|w_1\rangle_F$ is already sufficient to produce a (more involved) divide-and-conquer algorithm for the whole estimation problem. The complete algorithm is explicitly written out in Section 5 (see Algorithms 1 and 2). The key additional insight is to combine the intuition from Equation 4 above, with an additional expansion trick, expressed in Lemma 18.

Remark 6. Theorem 5 of [BGM20] shows that the output probabilities of 2D constant-depth circuits can be computed to inverse polynomial additive error in polynomial time. Technically, this does not exactly cover the base case of our divide-and-conquer approach because our base case will consist of circuits which are 3D, but have a small width in the third dimension. One might say that the base case circuits have a 2D structure with small “thickness” in the third dimension. Fortunately, this extended case is also covered by additional analysis from the [BGM20] paper, in which the authors show, on pages 25 and 26 (of the arXiv version), that a slightly modified version of their algorithm can, in fact, compute output probabilities of 3D-local, depth- d circuits to additive error ϵ in time $n\epsilon^{-2}2^{O(d^2 \cdot w)}$, where w is the width of the third dimension of the circuit. For convenience, throughout the remainder of this paper every reference to Theorem 5 of [BGM20] will refer instead to this modified algorithm which can handle these “small-width” 3D-local, depth- d circuits. Additionally, when we refer to 2D-local circuits we are including, within that definition, 3D-local circuits where the width in the third dimension is $w = \text{polylog}(n)$. The reason that this is a reasonable use of terminology in the context of this paper is that Theorem 5 of [BGM20], and the subsequent discussion, can handle these small-width 3D-local circuits in time exponential in the size of w (which, for $w = \text{polylog}(n)$, is quasi-polynomial).

Our approach for explicitly constructing $|w_1\rangle_F$ is based on a tool called a “block-encoding”, which aims to generate a unitary whose top left corner contains the Hermitian matrix $\rho_F \equiv \text{tr}_B(|\psi\rangle\langle\psi|_{B \cup F})$, or the integer powers ρ_F^K for $K = \text{polylog}(n)$. In fact, under an assumption that λ_1 is sufficiently large, $\frac{1}{\lambda_1^K} \rho_F^K$ is already very close to a projector onto $|w_1\rangle_F$ (see Lemma 15 for the explicit scaling).

Lemma 7 (Lemma 45 of [GSLW19]). *The following is a 2D-local (see Remark 6), depth- d circuit which gives a block encoding for $\rho_F \equiv \text{tr}_B(|\psi\rangle\langle\psi|_{B \cup F})$:*

$$(C_{BUMUF}^+ \otimes I_{F'}) (I_{BUM} \otimes SWAP_{FF'}) (C_{BUMUF} \otimes I_{F'})$$

Proof. From Lemma 45 of [GSLW19] it follows that the circuit $(C_{BUMUF}^+ \otimes I_{F'}) (I_{BUM} \otimes SWAP_{FF'}) (C_{BUMUF} \otimes I_{F'})$ is a block-encoding of ρ_F . Here F' is a fresh register which is identical in size to F . Note that SWAP is not geometrically local a priori, but if we interleave the qubits of F and F' in the geometrically appropriate way, which we are free to do, then the $SWAP_{FF'}$ can be implemented in a geometrically local, depth-1 manner. Thus the entire block-encoding is still given by a depth- d 2D-local circuit.

One additional subtlety: We are neglecting to measure the M register in the $|0\rangle$ basis here, but this is still a block-encoding for ρ_F nonetheless. The reason is that that measurement can be absorbed into the definition of block-encoding. \square

Following Lemma 53 of [GSLW19], we can now create a block encoding for the K^{th} power of ρ_F by creating K distinct F registers F_1, \dots, F_K (interwoven in the geometrically appropriate way just as in the proof of Lemma 7), and multiplying K different block encodings for ρ_F , each using a different one of the registers F_i , as so:

$$\prod_{i=1}^K (C_{BUMUF}^+ \otimes I_{F_1, \dots, F_K}) (I_{BUM} \otimes SWAP_{FF_i}) (C_{BUMUF} \otimes I_{F_1, \dots, F_K}) \quad (5)$$

We therefore have the following Lemma.

Lemma 8 (Lemma 53 of [GSLW19]). *For any constant integer $K > 0$, the following is a 2D-local (see Remark 6) quantum circuit which gives a block encoding for ρ_F^K , and has depth $O(dK^2)$:*

$$\prod_{i=1}^K (C_{BUMUF}^+ \otimes I_{F_1, \dots, F_K}) (I_{BUM} \otimes SWAP_{FF_i}) (C_{BUMUF} \otimes I_{F_1, \dots, F_K}) \quad (6)$$

Proof. The fact that Equation 6 gives a block encoding of ρ_F^K follows by repeated application of Lemma 53 of [GSLW19]. The circuit in Equation 6, disregarding geometric locality, has depth $O(dK)$ because it is a composition of $3K$ circuits each having depth $O(d)$. The circuit can be made 2D-local if we choose, WLOG, for the F_j registers to be interleaved with the other qubits in a manner that matches the 2D geometry. Since there are now K different F_j registers, this can increase the depth of our circuit by another factor of K (adding nearest-neighbor SWAP gates to ensure that every gate is exactly 2D-local at each step). So the depth of the geometrically-local version of the circuit is $O(dK^2)$.

For brevity we do not include a more explicit description of this process for interleaving registers in order to make the circuit geometrically local because we believe that the reader will understand this process from the above description. We note that, in any case, the scaling of the depth of the circuit in Equation 6 could be any polynomial in K and our final result in Theorem 1 would still hold. \square

Stated concretely, the fact that the circuit in Equation (6) is a block encoding for ρ_F^K simply means that, if we define $|0_{\text{ancilla}}\rangle = |0_{F_1, \dots, F_K, M, B}\rangle$, then:

$$\rho_F^K = \langle 0_{\text{ancilla}} | \prod_{i=1}^K (C_{BUMUF}^+ \otimes I_{F_1, \dots, F_K}) (I_{BUM} \otimes SWAP_{FF_i}) (C_{BUMUF} \otimes I_{F_1, \dots, F_K}) | 0_{\text{ancilla}} \rangle. \quad (7)$$

4 Divide and Conquer: Splitting Over Heavy Slices

In this section we will prove a set of results which will allow us to precisely define and analyze the division step in our divide-and-conquer algorithm. The process begins by identifying slices of the depth- d circuit C which are appropriate division points. Those are the slices which have “heavy weight” as defined below.

Consider a set of $O(d)$ -width 2D slices $K = \{K_i\}$ of the qubits of C , where each slice K_i is parallel to the cut $B \cup M \cup F$ shown in Figure 1, and is made up of three analogous sections B_i, M_i, F_i (see Figure 4). Let the slices in K be evenly spaced at an $O(d)$ distance apart, where this value is chosen to be large enough that the light cones of K_i and K_j are disjoint when $i \neq j$. For concreteness we will say that the distance between slices K_i is equal to $10d$. We will also set the width of each of the sections B_i, M_i, F_i to be $10d$, just as discussed in Definition 2. This ensures that the properties stipulated by Definition 2 are satisfied by B_i, M_i, F_i .

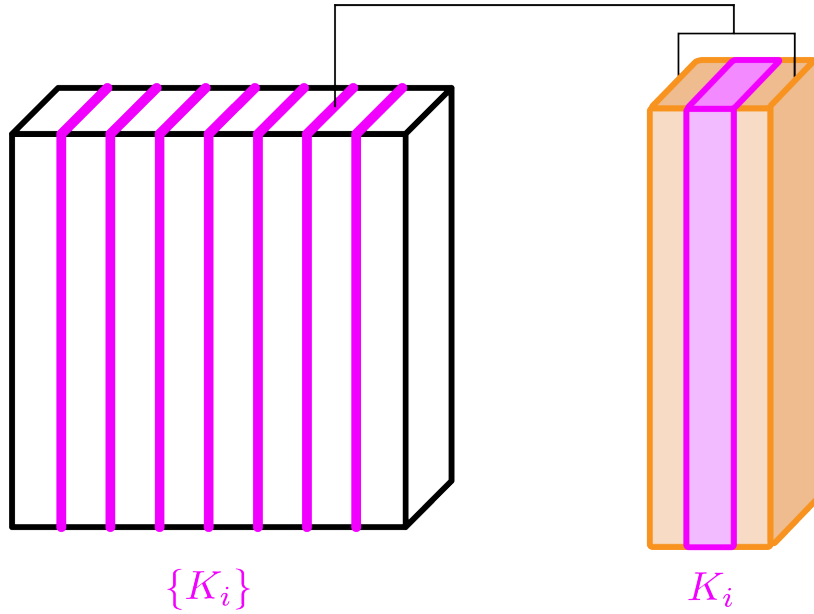

Figure 4: Set of slices $\{K_i\}$

Definition 9. Let $I[M_i = 0]$ be the indicator random variable for the event that all of the qubits in M_i collapse to 0 when measured in the computational basis. Here joint probabilities are defined according to the probability distribution p_{total} produced by measuring $C |0^{\otimes n}\rangle$ in the computational basis. Let $p_{M_i=0} := \mathbb{E}_{p_{total}}[I[M_i = 0]]$ be the probability that all of the bits in K_i evaluate to 0 according to the distribution p_{total} .

Lemma 10. *The $I[M_i = 0]$ are independent random variables. Therefore,*

$$p_{total}(M_i = 0 \forall i) = \prod_i p_{total}(M_i = 0).$$

Proof. The $I[M_i = 0]$ are independent random variables because the cuts K_i are light-cone separated by definition. The desired results follows. \square

Note that the variables $I[M_i = 0]$ may well be *conditionally* dependent when conditioned on the outcomes of measuring the qubits in between the K_i slices. Indeed, that’s what makes the

global problem non-trivial in the first place. But, when measuring the K_i slices alone we see that the $I[M_i = 0]$ are independent as stated in Lemma 10.

Lemma 11. *If $|\langle 0^{\otimes n} | C | 0^{\otimes n} \rangle| > |1/q(n)|$, then, for any $0 \leq h \leq 1$, $h|K|$ of the slices K_i in K have the property that:*

$$p_{total}(M_i = 0) \geq (|1/q(n)|)^{\frac{1}{(1-h)|K|}} \quad (8)$$

We will let K_{heavy} be the subset of K consisting of those K_i satisfying Equation (8).

Proof. The proof of Lemma 11 is given in Appendix A. □

Definition 12. We define any particular slice K_i as $K_i = B_i \cup M_i \cup F_i$, where B_i, M_i, F_i are the analogous regions to B, M, F (respectively) in Figure 1. These slices are depicted in Figure 4. Let $|\psi\rangle_{B_i \cup F_i}$ be analogous to $|\psi\rangle_{B \cup F} \equiv \langle 0 |_M C_{B \cup M \cup F} | 0 \rangle_{B \cup M \cup F}$. Let L_i and R_i be sets of qubits analogous to the sets L and R . We define the unitaries $C_{B_i \cup M_i \cup F_i}$, C_{wrap_i} , $C'_{L_i} \equiv C_{L_i}^+ \circ C_{L_i}$, and $C'_{R_i} \equiv C_{R_i}^+ \circ C_{R_i}$ exactly as given in Definition 5 for the case of a single cut.

Lemma 13. *For any slice $K_i \in K_{heavy}$ satisfying:*

$$p_{total}(M_i = 0) \geq 1 - e(n), \quad (9)$$

the top Schmidt coefficient of $|\psi\rangle_{B_i \cup F_i}$ satisfies $\lambda_1^i \geq 1 - O(e(n))$. (Where the Schmidt decomposition is taken across the partition B_i, F_i .)

Proof. The proof of Lemma 13 is given in Appendix A. □

The proof of Lemma 13 (See Appendix A) suggests a way to perform a division step, dividing the original computational problem into the product of two new problems, but at the cost of an additive error that scales like $\Theta(e(n))$. But, note that, if we want, say, $1/n^d$ additive error for $d \geq 2$, then this additive error term is way too large (in some cases $e(n)$ scales like $1/\log(n)$). This means that, a priori, we cannot even afford to make use of Lemma 13 one single time! However, Lemma 20 below shows how we can use this type of division step to divide the circuit at Δ different, light-cone separated cuts, K_i , simultaneously, and thereby achieve additive error that scales like $e(n)^\Delta$.

Definition 14. For any K_i define the following two operators inspired by the block-encoding approach in Section 3:

$$P_{F_i}^K \equiv \frac{1}{\lambda_1^K} \left\langle 0^{B_i, M_i, F_i^1, \dots, F_i^K} \left| \prod_{j=1}^K (C_{B_i \cup M_i \cup F_i}^+ \otimes I_{F_i^1, \dots, F_i^K}) (I_{B_i \cup M_i} \otimes \text{SWAP}_{F_i^j}) (C_{B_i \cup M_i \cup F_i} \otimes I_{F_i^1, \dots, F_i^K}) \right| 0^{B_i, M_i, F_i^1, \dots, F_i^K} \right\rangle$$

(10)

and

$$P_{B_i}^K \equiv \frac{1}{\lambda_1^K} \left\langle 0^{F_i, M_i, B_i^1, \dots, B_i^K} \left| \prod_{j=1}^K (C_{B_i \cup M_i \cup F_i}^+ \otimes I_{B_i^1, \dots, B_i^K}) (I_{F_i \cup M_i} \otimes \text{SWAP}_{B_i^j}) (C_{B_i \cup M_i \cup F_i} \otimes I_{B_i^1, \dots, B_i^K}) \right| 0^{F_i, M_i, B_i^1, \dots, B_i^K} \right\rangle$$

Here the first equation gives a linear operator on F_i , and the second equation gives a linear operator on B_i . The registers F_i^j (resp. B_i^j) are dummy registers that are used to create K block encodings of the density matrix of the F_i (resp. B_i) register of the state $C_{B_i \cup M_i \cup F_i} | 0^{F_i, M_i, B_i} \rangle$. These K block encodings are then composed (multiplied) with each other in such a manner that they produce the block encoding of the K^{th} power of the density matrix, as described in Section 3.

Lemma 15. For any $K_i \in K_{heavy}$,

$$\|P_{F_i}^K - |w_1\rangle\langle w_1|_{F_i}\|_1 \leq g(n) \quad (11)$$

and

$$\|P_{B_i}^K - |v_1\rangle\langle v_1|_{B_i}\|_1 \leq g(n) \quad (12)$$

where $g(n) \equiv \left(\frac{1-\lambda_1^i}{\lambda_1^i}\right)^K$, and $|w_1\rangle\langle w_1|_{F_i}$, $|v_1\rangle\langle v_1|_{B_i}$ are the projectors onto the top Schmidt vectors of $|\psi\rangle_{B_i \cup F_i}$ in F_i and B_i respectively.

Proof. The proof of Lemma 15 is given in Appendix A. \square

Definition 16. Define $\Pi_{F_i}^K \equiv C_{Wrap_i} P_{F_i}^K C_{Wrap_i}^\dagger$.

Note that the operator $\Pi_{F_i}^K$ is in tensor product with $|0_{M_i}\rangle$ (it acts as the identity on the M_i register since C_{Wrap_i} and $P_{F_i}^K$ act trivially on that register).

Definition 17. Let $\sigma \in \mathcal{P}[\Delta] \setminus \emptyset$ where $[\Delta] = \{1, \dots, \Delta\}$. Define the unnormalized states

$$|\Psi_\sigma\rangle = \otimes_{j \in \sigma} \Pi_{F_j}^K \otimes_{i \in [\Delta]} \langle 0_{M_i} | C | 0_{ALL} \rangle$$

And,

$$|\Psi_\emptyset\rangle = \otimes_{i \in [\Delta]} \langle 0_{M_i} | C | 0_{ALL} \rangle$$

Lemma 18. Consider a set K_{heavy} of slices such that, for every $K_i \in K_{heavy}$, $|\psi\rangle_{B_i \cup F_i}$ satisfies $\lambda_1^i \geq 1 - e(n)$, and such that for any $K_i, K_j \in K_{heavy}$, the operators $\Pi_{F_i}^K$ and $\Pi_{F_j}^K$ are light-cone separated whenever $i \neq j$. Then, for any set of Δ slices, $\{K_i\}_{i \in [\Delta]} \subseteq K_{heavy}$, we have that:

$$\left\| \sum_{\sigma \in \mathcal{P}([\Delta])} (-1)^{|\sigma|} |\Psi_\sigma\rangle \langle \Psi_\sigma| \right\| = \left\| |\Psi_\emptyset\rangle \langle \Psi_\emptyset| - \sum_{\sigma \in \mathcal{P}([\Delta]) \setminus \emptyset} (-1)^{|\sigma|+1} |\Psi_\sigma\rangle \langle \Psi_\sigma| \right\| \leq (2e(n) + 2g(n))^\Delta, \quad (13)$$

where $g(n) \equiv \left(\frac{1-\lambda_1^i}{\lambda_1^i}\right)^K$.

Proof. The proof of Lemma 18 is given in Appendix A. \square

Intuition for the statements of Lemmas 18 and 20: We will show, in Lemma 20 below, that each of the states $|\Psi_\sigma\rangle \langle \Psi_\sigma|$, with $\sigma \neq \emptyset$, is very close to a product state about at least one of the Δ slices. Thus, Lemma 18 gives us a way to approximate $|\Psi_\emptyset\rangle \langle \Psi_\emptyset|$ (which is the original state of interest) by a linear combination of product states $|\Psi_\sigma\rangle \langle \Psi_\sigma|$. Lemma 20 and Definition 14 then provide us with a way of constructing the corresponding product states using low-depth quantum circuits acting on approximately half as many qubits as the original circuit (this process is also further formalized in Definition 23). This combined use of Lemmas 18 and 20 forms the backbone of our divide-and-conquer approach.

In order to state Lemma 20 we now define three new states that are dependent on a particular choice of K_i .

Definition 19. Given a shallow, 3D geometrically local quantum circuit C , and given a slice K_i of C , define the states:

$$|\Omega_i\rangle = \Pi_{F_i}^K \langle 0_{M_i} | C | 0_{ALL} \rangle \quad (14)$$

$$|\Xi_{L_i}\rangle = P_{F_i}^K \langle 0_{M_i} | C_{L_i} C_{B_i \cup M_i \cup F_i} | 0_{L_i \cup B_i \cup M_i \cup F_i} \rangle \quad (15)$$

$$|\Xi_{R_i}\rangle = P_{B_i}^K \langle 0_{M_i} | C_{R_i} C_{B_i \cup M_i \cup F_i} | 0_{R_i \cup B_i \cup M_i \cup F_i} \rangle \quad (16)$$

At this point it is pertinent to state Lemma 20:

Lemma 20. For any $K_i \in K_{heavy}$ (recall this means that $|\psi\rangle_{B_i \cup F_i}$ satisfies $\lambda_1^i \geq 1 - e(n)$), the state $|\Omega_i\rangle \langle \Omega_i|$ is within $6g(n)$ of an unnormalized product state about M_i , described as follows:

$$\left\| |\Omega_i\rangle \langle \Omega_i| - 1/\lambda_1^i \text{tr}_{F_i} (|\Xi_{L_i}\rangle \langle \Xi_{L_i}|) \otimes \text{tr}_{B_i} (|\Xi_{R_i}\rangle \langle \Xi_{R_i}|) \right\| \leq 6g(n) \quad (17)$$

Here $g(n) \equiv \left(\frac{1-\lambda_1^i}{\lambda_1^i}\right)^K \leq \left(\frac{e(n)}{1-e(n)}\right)^K$ just as in Lemma 15.

Proof. The proof of Lemma 20 is given in Appendix A. □

Definition 21 (Synthesis). We say that an unnormalized quantum state ϕ is *synthesized* by a quantum circuit Γ , if Γ has three registers of qubits L, M, N such that:

$$\phi = \phi_{(\Gamma, L, M, N)} = \text{tr}_{LUM} (\langle 0_M | \Gamma | 0_{LUMUN} \rangle \langle 0_{LUMUN} | \Gamma^\dagger | 0_M \rangle). \quad (18)$$

In this case we say that the circuit Γ together with a specification of the registers L, M, N constitutes a *synthesis* of ϕ . When ϕ is implicit we will call this collection (Γ, L, M, N) a *synthesis*.

When Γ is a 3D geometrically-local, depth- d circuit, and the register N is one contiguous cubic subset of the qubits that Γ acts on, with L , and M only containing qubits on the “edges”, we call (Γ, L, M, N) a 3D geometrically-local, depth- d *synthesis*.

Definition 22. [The Circuits $\Gamma_{i,j}, \Gamma_{L,i}, \Gamma_{R,j}$] Recall, from Definition 3, that $\Gamma_{B_k \cup M_k \cup F_k}$ ($k \in \{i, j\}$) is defined to be the circuit containing the minimal number of gates of Γ such that every gate acting on M_k is included. Taking this definition for both $k = i$ and $k = j$, we now define $\Gamma_{i,j}$ to be a sub-circuit of Γ consisting of the minimal number of gates of Γ such that $\Gamma_{i,j} \circ \Gamma_{B_i \cup M_i \cup F_i} \circ \Gamma_{B_j \cup M_j \cup F_j}$ contains all of the gates of Γ that lie between M_i and M_j . Similarly define Γ_{L_i} (resp. Γ_{R_j}) to be te sub-circuit of Γ consisting of the minimal number of gates of Γ such that $\Gamma_{L_i} \circ \Gamma_{B_i \cup M_i \cup F_i}$ (resp. $\Gamma_{R_j} \circ \Gamma_{B_j \cup M_j \cup F_j}$) contains all of the gates of Γ that lie between M_i (resp. M_j) and the left-hand side (resp. right-hand side) of the Cube.

Definition 23. Let $S = (\Gamma, G, H, N)$ be a 3D local, depth- d synthesis, and let K_i, K_j ($i < j$) be two slices on the register N , as described in Definition 12. Let M_i, F_i, B_i , and M_j, F_j, B_j be the subregisters of slices K_i and K_j respectively, as defined in Definition 12. Recall, from Definition 21, that the state synthesized by S is:

$$\phi_S = \text{tr}_{GUH} (\langle 0_H | \Gamma | 0_{GUHUN} \rangle \langle 0_{GUHUN} | \Gamma^\dagger | 0_H \rangle).$$

We define three new pure states as follows:

$$\begin{aligned}
|\varphi_{L,i}\rangle &= (\lambda_1^i)^K P_{F_i}^K \langle 0_{M_i,H} | \Gamma_{L_i} \Gamma_{B_i \cup M_i \cup F_i} | 0_{L_i \cup B_i \cup M_i \cup F_i \cup G \cup H} \rangle \\
|\varphi_{j,R}\rangle &= (\lambda_1^j)^K P_{B_j}^K \langle 0_{M_j,H} | \Gamma_{R_j} \Gamma_{B_j \cup M_j \cup F_j} | 0_{R_j \cup B_j \cup M_j \cup F_j \cup G \cup H} \rangle \\
|\varphi_{i,j}\rangle &= (\lambda_1^i \lambda_1^j)^K P_{B_i}^K \circ P_{F_j}^K \langle 0_{M_i, M_j, H} | \Gamma_{i,j} \circ \Gamma_{B_i \cup M_i \cup F_i} \circ \Gamma_{B_j \cup M_j \cup F_j} | 0_{N_{i,j} \cup B_i \cup M_i \cup F_i \cup B_j \cup M_j \cup F_j \cup G \cup H} \rangle \quad (19)
\end{aligned}$$

Here $P_{F_i}^K, P_{B_j}^K$ are defined as in Definition 14. In the above the notation $N_{i,j}$ is defined to be the sub-register of N containing all of the qubits between F_i and B_j .

From these, we define three new synthesized states (with corresponding syntheses) as follows:

$$\begin{aligned}
\phi_{L,i} &= \text{tr}_{F_i \cup M_i \cup G \cup H} (|\varphi_{L,i}\rangle \langle \varphi_{L,i}|) \\
\phi_{j,R} &= \text{tr}_{B_j \cup M_j \cup G \cup H} (|\varphi_{j,R}\rangle \langle \varphi_{j,R}|) \\
\phi_{i,j} &= \text{tr}_{B_i \cup M_i \cup M_j \cup F_j \cup G \cup H} (|\varphi_{i,j}\rangle \langle \varphi_{i,j}|) \quad (20)
\end{aligned}$$

We can now write out the explicit synthesis for each of these synthesized states as follows:

Recalling, from Definition 14 that,

$$P_{F_i}^K \equiv \frac{1}{(\lambda_1^i)^K} \langle 0^{B_i, M_i, F_i^1, \dots, F_i^K} | \prod_{j=1}^K (\Gamma_{B_i \cup M_i \cup F_i}^\dagger \otimes I_{F_i^1, \dots, F_i^K}) (I_{B_i \cup M_i} \otimes \text{SWAP}_{F_i F_i^j}) (\Gamma_{B_i \cup M_i \cup F_i} \otimes I_{F_i^1, \dots, F_i^K}) | 0^{B_i, M_i, F_i^1, \dots, F_i^K} \rangle \quad (21)$$

We have that the explicit synthesis corresponding to $\phi_{L,i}$ is:

$$\begin{aligned}
S_{L,i} \equiv & \left(\Gamma_{P_{F_i}^K} \circ \Gamma_{L_i} \circ \Gamma_{B_i \cup M_i \cup F_i}, (F_i \cup G), (M_i \cup M'_i \cup B'_i \cup F_i^1, \dots \cup F_i^K \cup H) \right. \\
& \left. , (L_i \cup B_i \cup M_i \cup F_i \cup M'_i \cup B'_i \cup G \cup H \cup F_i^1, \dots \cup F_i^K) \right),
\end{aligned}$$

where $\Gamma_{P_{F_i}^K}$ is defined as

$$\Gamma_{P_{F_i}^K} \equiv \prod_{j=1}^K (\Gamma_{B'_i \cup M'_i \cup F_i}^\dagger \otimes I_{F_i^1, \dots, F_i^K}) (I_{B'_i \cup M'_i} \otimes \text{SWAP}_{F_i F_i^j}) (\Gamma_{B'_i \cup M'_i \cup F_i} \otimes I_{F_i^1, \dots, F_i^K}), \quad (22)$$

where $\Gamma_{B'_i \cup M'_i \cup F_i}$ is the same as $\Gamma_{B_i \cup M_i \cup F_i}$ except that it does not act on registers B_i or M_i at all, but instead, acts on dummy registers B'_i and M'_i in their place.

Symmetrically, for the explicit synthesis for $|\phi_{j,R}\rangle$, recall that:

$$P_{B_i}^K \equiv \frac{1}{(\lambda_1^i)^K} \langle 0^{F_i, M_i, B_i^1, \dots, B_i^K} | \prod_{j=1}^K (C_{B_i \cup M_i \cup F_i}^\dagger \otimes I_{B_i^1, \dots, B_i^K}) (I_{F_i \cup M_i} \otimes \text{SWAP}_{B_i B_i^j}) (C_{B_i \cup M_i \cup F_i} \otimes I_{B_i^1, \dots, B_i^K}) | 0^{F_i, M_i, B_i^1, \dots, B_i^K} \rangle, \quad (23)$$

and, therefore, we have that the explicit synthesis corresponding to $|\phi_{j,R}\rangle$ is:

$$S_{j,R} \equiv \left(\Gamma_{P_{B_j}^K} \circ \Gamma_{R_j} \circ \Gamma_{B_j \cup M_j \cup F_j}, (B_j \cup G), (M_j \cup M'_j \cup F'_j \cup B_j^1, \dots \cup B_j^K \cup H) \right. \\ \left. , (R_j \cup B_j \cup M_j \cup F_j \cup M'_j \cup F'_j \cup G \cup H \cup B_j^1, \dots \cup B_j^K) \right),$$

where $\Gamma_{P_{B_j}^K}$ is defined as

$$\Gamma_{P_{B_j}^K} \equiv \prod_{l=1}^K (C_{B_j \cup M'_j \cup F'_j}^+ \otimes I_{B_j^1, \dots, B_j^K}) (I_{F'_j \cup M'_j} \otimes \text{SWAP}_{B_j B'_j}) (C_{B_j \cup M'_j \cup F'_j} \otimes I_{B_j^1, \dots, B_j^K}), \quad (24)$$

where $\Gamma_{B_j \cup M'_j \cup F'_j}$ is the same as $\Gamma_{B_j \cup M_j \cup F_j}$ except that it acts on new dummy registers F'_j and M'_j instead of the original registers F_j or M_j .

Finally, reusing Equations 21, 22, 23, and 24, the explicit synthesis for $|\phi_{i,j}\rangle$ can be written as (See Equation 19 for definition of $|\phi_{i,j}\rangle$):

$$S_{i,j} \equiv \left(\Gamma_{P_{B_i}^K} \circ \Gamma_{P_{F_j}^K} \circ \Gamma_{i,j} \circ \Gamma_{B_i \cup M_i \cup F_i} \circ \Gamma_{B_j \cup M_j \cup F_j}, (B_i \cup F_j \cup G), \right. \\ (M_i \cup M'_i \cup F'_i \cup B_i^1, \dots \cup B_i^K \cup M_j \cup M'_j \cup B'_j \cup F_j^1, \dots \cup F_j^K \cup H) \\ \left. , (N_{i,j} \cup F_i \cup B_j \cup B_i \cup F_j \cup G \cup M_i \cup M'_i \cup F'_i \cup B_i^1, \dots \cup B_i^K \cup M_j \cup M'_j \cup B'_j \cup F_j^1, \dots \cup F_j^K \cup H) \right),$$

where $N_{i,j}$ is defined in the same manner as before: the register containing all of the qubits between K_i and K_j .

Definition 24. Define syntheses

$$\Lambda_1^{j,T} \equiv \left(\Gamma_{P_{B_j}^T} \circ \Gamma_{B_j \cup M_j \cup F_j}, (B_j \cup F_j), (M_j \cup M'_j \cup F'_j \cup B_j^1, \dots \cup B_j^T) \right. \\ \left. , (B_j \cup M_j \cup F_j \cup M'_j \cup F'_j \cup B_j^1, \dots \cup B_j^T) \right),$$

$$Z_j^T \equiv \left(\Gamma_{P_{B_j}^T}, (B_j), (M'_j \cup F'_j \cup B_j^1, \dots \cup B_j^T) \right. \\ \left. , (B_j \cup M'_j \cup F'_j \cup B_j^1, \dots \cup B_j^T) \right),$$

Note that these two objects are, in this case, scalars (see Definition 21 to understand why). In fact,

$$Z_j^T = \text{tr}(\rho_{B_j}^T),$$

and (25)

$$\Lambda_1^{j,T} = \text{tr}(\rho_{B_j}^T |\psi\rangle \langle \psi|_{B_j \cup M_j \cup F_j} \rho_{B_j}^T) \quad (26)$$

where

$$\rho_{B_i}^K \equiv \left\langle 0^{F_i, M_i, B_i^1, \dots, B_i^K} \left| \prod_{j=1}^K (C_{B_i \cup M_j \cup F_i}^\dagger \otimes I_{B_i^1, \dots, B_i^K}) (I_{F_i \cup M_i} \otimes \text{SWAP}_{B_i B_i^j}) (C_{B_i \cup M_i \cup F_i} \otimes I_{B_i^1, \dots, B_i^K}) \right| 0^{F_i, M_i, B_i^1, \dots, B_i^K} \right\rangle$$

as in Lemma 8.

We write the scalars $Z_j^T, \Lambda_1^{j,T}$ as 2D geometrically-local, shallow depth syntheses to emphasize that they can be computed by any algorithm which computes the probability of zero being output by a 2D geometrically-local, shallow depth synthesis. In the following analysis we will use the 2D algorithm in Theorem 5 of [BGM20] to compute these quantities to inverse polynomial additive error (see Remark 6).

Now we will give a definition of a scalar quantity κ_{T, ϵ_2}^i which is meant to be an approximation for the quantity λ_1^i that we can compute using the “base case” algorithm \mathcal{B} described below. We need this because we want to use λ_1^i to normalize terms in Algorithm 2 below. We will use its approximation, κ_{T, ϵ_2}^i , as a substitute, since it is a quantity that we can compute in quasi-polynomial time (even when $T = \log^c(n)$ and $\epsilon_2 = O(1/n^{\log(n)})$, see Definition 25). The quality of this approximation is the subject of Lemma 26.

Definition 25.

$$\kappa_{T, \epsilon_2}^j \equiv \frac{\mathcal{B}(\Lambda_1^{j,T}, \epsilon_2)}{\mathcal{B}(Z_j^{2T}, \epsilon_2)} = \frac{\text{tr}(\rho_{B_j}^T |\psi\rangle \langle \psi|_{B_j \cup M_j \cup F_j} \rho_{B_j}^T) \pm \epsilon_2}{\text{tr}(\rho_{B_j}^{2T}) \pm \epsilon_2}$$

Here the notation $\mathcal{B}(\Lambda_1^{j,T}, \epsilon_2)$ (resp. $\mathcal{B}(Z_j^{2T}, \epsilon_2)$) denotes a use of algorithm \mathcal{B} , which we define to be the algorithm from Theorem 5 of [BGM20] (applied according the prescription in Remark 6), to compute the scalar quantity $\Lambda_1^{j,T}$ (resp. Z_j^{2T}) to within additive error ϵ_2 . We will elaborate further on this computational task (time complexity, etc) in the analysis of Algorithm 2.

Lemma 26. *If $\lambda_1^i \geq 1 - e(n)$ then $|\kappa_{T, \epsilon_2}^i - \lambda_1^i| \leq O\left(\frac{(e(n))^{2T} + \epsilon_2}{(\lambda_1^i)^{2T+1}}\right)$.*

Proof. Starting with the definition:

$$\begin{aligned} \kappa_{T, \epsilon_2}^i &\equiv \frac{\mathcal{B}(\Lambda_1^{i,T}, \epsilon_2)}{\mathcal{B}(Z_i^{2T}, \epsilon_2)} = \frac{\text{tr}(\rho_{B_i}^T |\psi\rangle \langle \psi|_{B_i \cup M_i \cup F_i} \rho_{B_i}^T) \pm \epsilon_2}{\text{tr}(\rho_{B_i}^{2T}) \pm \epsilon_2} \\ &= \frac{(\lambda_1^i)^{2T+1} + O(e(n)^{2T}) + O(\epsilon_2)}{(\lambda_1^i)^{2T} + O(e(n)^{2T}) + O(\epsilon_2)} = \frac{(\lambda_1^i)^{2T+1} (1 + O(\frac{e(n)^{2T} + \epsilon_2}{(\lambda_1^i)^{2T+1}}))}{(\lambda_1^i)^{2T} (1 + O(\frac{e(n)^{2T} + \epsilon_2}{(\lambda_1^i)^{2T}}))} \\ &= \lambda_1^i \frac{(1 + O(\frac{e(n)^{2T} + \epsilon_2}{(\lambda_1^i)^{2T+1}}))}{(1 + O(\frac{e(n)^{2T} + \epsilon_2}{(\lambda_1^i)^{2T}}))} = \lambda_1^i \left(1 + O\left(\frac{e(n)^{2T} + \epsilon_2}{(\lambda_1^i)^{2T+1}}\right) \right) \\ &= \lambda_1^i + O\left(\frac{e(n)^{2T} + \epsilon_2}{(\lambda_1^i)^{2T+1}}\right) \end{aligned} \tag{27}$$

The desired result follows. □

Definition 27. For any natural number Δ , we define $[\Delta] \equiv \{1, \dots, \Delta\}$. We define $\mathcal{P}([\Delta])$ to be the set of all subsets of $[\Delta]$, that is, the power set of $[\Delta]$. For any set $\sigma \in \mathcal{P}([\Delta])$, we let σ_{max} denote the largest element of σ . We let $|\sigma|$ denote the size of the set σ , and for any $0 < i \leq |\sigma|$ we let $\sigma(i)$ denote the i^{th} smallest element of σ .

5 Estimating Amplitudes in Quasi-polynomial Time

In this section we define and analyze our algorithm for computing $|\langle 0^{\otimes n} | C | 0^{\otimes n} \rangle|^2$.

5.1 Run-Time and Error Analysis for Algorithm 1

Theorem 28. *Let C be any depth- d , 3D geometrically local quantum circuit on n qubits. Algorithm 1, $\mathcal{A}_{full}(C, \mathcal{B}, \delta)$, where \mathcal{B} is the base case algorithm specified in Theorem 5 of [BGM20], will produce the scalar quantity $|\langle 0^{\otimes n} | C | 0^{\otimes n} \rangle|^2$ to within δ error in time*

$$T(n) = \delta^{-2} 2^{d^3 \text{polylog}(n) (1/\delta)^{1/\log^2(n)}} \quad (31)$$

Proof of Theorem 28: The proof proceeds in two parts, the first bounding the approximation error obtained by the algorithm, and the second bounding the runtime. See Table 10 for a brief summary of the parameters used throughout Algorithms 1 and 2.

Approximation Error: The analysis of the approximation error obtained by $\mathcal{A}_{full}(C, \mathcal{B}, \delta)$ can be broken into four cases according to the IF statements on Lines 1, 3, 9, and 10 of Algorithm 1. The first three cases are easy. If the condition in Line 1 is satisfied, then the specified additive error δ is so small that we can compute the desired quantity, $|\langle 0_{ALL} | C | 0_{ALL} \rangle|^2$, exactly, by brute force, in $2^{O(n)}$ time, and this will still take less time than the guaranteed runtime:

$$T(n) = \delta^{-2} 2^{d^3 \text{polylog}(n) (1/\delta)^{1/\log^2(n)}}.$$

So, if the condition in Line 1 is satisfied, then we are done. If not, we proceed.

Next, if the condition in Line 3 is satisfied, then $\delta \geq 1/2$, in which case, outputting 0 is clearly a δ additive approximation of $|\langle 0_{ALL} | C | 0_{ALL} \rangle|^2$, since $0 \leq |\langle 0_{ALL} | C | 0_{ALL} \rangle|^2 \leq 1$. So, if this is the case, we are done, otherwise we proceed.

Next, if the condition in Line 9 is satisfied, then, either $\delta \geq 1/2$ (in which case, outputting $1/2$ is clearly a δ additive approximation of $|\langle 0_{ALL} | C | 0_{ALL} \rangle|^2$, since $0 \leq |\langle 0_{ALL} | C | 0_{ALL} \rangle|^2 \leq 1$), OR there is a set of slices $K_{lightweight}$ of size at least $h(n)$, such that every slice $K_i \in K_{lightweight}$ satisfies:

$$\| \langle 0_{M_i} | C | 0_{ALL} \rangle \|^2 = \text{tr} \left(\langle 0_{M_i} | C | 0_{ALL} \rangle \langle 0_{ALL} | C^\dagger | 0_{M_i} \rangle \right) < 2^{\frac{\log(\delta)}{h(n)}}.$$

In this case, since, for all $K_i, K_j \in K_{lightweight}$ with $K_i \neq K_j$ we know that K_i is lightcone separated from K_j . It follows that:

$$|\langle 0_{ALL} | C | 0_{ALL} \rangle| \leq \prod_{K_i \in K} \| \langle 0_{M_i} | C | 0_{ALL} \rangle \| \leq \left(2^{\frac{\log(\delta)}{2h(n)}} \right)^{h(n)} = 2^{\log(\delta)/2} = \sqrt{\delta}. \quad (32)$$

So,

$$|\langle 0_{ALL} | C | 0_{ALL} \rangle|^2 \leq \delta. \quad (33)$$

Algorithm 1: $\mathcal{A}_{full}(C, \mathcal{B}, \delta)$: Quasi-Polynomial Time Additive Error Approximation for $|\langle 0_{ALL} | C | 0_{ALL} \rangle|^2$.

Input : 3D Geometrically-Local, depth- d circuit C , base-case algorithm \mathcal{B} , approximation error δ

Output: An approximation of $|\langle 0_{ALL} | C | 0_{ALL} \rangle|^2$ to within additive error δ .

/* We begin by handling the case in which δ is so small that it trivializes our runtime, and the case in which δ is so large that it causes meaningless errors: */

1 **if** $\delta \leq 1/n^{\log^2(n)}$ **then**

2 **return** The value $|\langle 0_{ALL} | C | 0_{ALL} \rangle|^2$ computed with zero error by a “brute force” $2^{O(n)}$ -time algorithm.

3 **if** $\delta \geq 1/2$ **then return** $1/2$

/* Here begins the non-trivial part of the algorithm: */

4 Let N be the register containing all of the qubits on which C acts. Since these qubits are arranged in a cubic lattice, one of the sides of the cube N must have length at most $n^{\frac{1}{3}}$. We will call the length of this side the “width” and will now describe how to “cut” the cube N , and the circuit C , perpendicular to this particular side.

5 Select $\frac{1}{10d}n^{\frac{1}{3}}$ light-cone separated slices K_i of $10d$ width in N , with at most $10d$ distance between adjacent slices. Let $h(n) = \log^7(n)$. Use the base case algorithm \mathcal{B} to check if at least $\frac{1}{10d}n^{\frac{1}{3}} - h(n)$ of the slices obey:

6

$$\left| \text{tr} \left(\langle 0_{M_i} | C | 0_{ALL} \rangle \langle 0_{ALL} | C^\dagger | 0_{M_i} \rangle \right) \right| \geq 2^{\frac{\log(\delta)}{h(n)}}.$$

7 OR, there are fewer than $\frac{1}{10d}n^{\frac{1}{3}} - h(n)$ slices that obey:

8

$$\left| \text{tr} \left(\langle 0_{M_i} | C | 0_{ALL} \rangle \langle 0_{ALL} | C^\dagger | 0_{M_i} \rangle \right) \right| \geq 2^{\frac{\log(\delta)}{h(n)}}.$$

/* See the runtime analysis in the proof of Theorem 28 for a detailed explanation of how the base case algorithm \mathcal{B} can efficiently distinguish between the above two cases (via Remark 6). */

9 **if** Fewer than $\frac{1}{10d}n^{\frac{1}{3}} - h(n)$ of the slices obey Line 8 **then return** 0

10 **if** At least $\frac{1}{10d}n^{\frac{1}{3}} - h(n)$ of the slices obey Line 8 **then**

11 We will denote the set of these slices by K_{heavy} . Note that the maximum amount of width between any two adjacent slices in K_{heavy} is $10d \cdot h(n)$. Furthermore, the maximum amount of width collectively between Δ slices in K_{heavy} is $10d\Delta + 10d \cdot h(n)$. Now that the set K_{heavy} has been defined, we will use this fixed set in the recursive algorithm, Algorithm 2.

12 Define the geometrically-local, depth- d synthesis $S \equiv (C, L, M, N)$, where $L = M = \emptyset$, are empty registers, and N is the entire input register for the circuit C .

13 **return**

$$\mathcal{A}(S, \eta = \frac{\log(n)}{3 \log(4/3)}, \Delta = \log(n), \epsilon = \delta 2^{-10 \log(n) \log(\log(n))}, h(n) = \log^7(n), K_{heavy}, \mathcal{B})$$

Algorithm 2: $\mathcal{A}(S, \eta, \Delta, \epsilon, h(n), K_{heavy}, \mathcal{B})$: Recursive Divide-and-Conquer Subroutine for Algorithm 1.

Input : 3D Geometrically-Local, depth- d synthesis S , number of iterations η , number of cuts Δ , positive base-case error bound $\epsilon > 0$, base-case algorithm \mathcal{B} , a set of heavy slices K_{heavy}

Output: An approximation of the quantity $\langle 0_N | \phi_S | 0_N \rangle$ where ϕ_S is the un-normalized mixed state specified by the 3D geometrically-local, depth- d synthesis S , and $|0_N\rangle$ is the 0 state on the entire N register of that synthesis. The approximation error is bounded in the analysis below.

- 1 Given the geometrically-local, depth- d synthesis $S = (\Gamma, L, M, N)$, let us ignore the registers L and M as they have already been measured or traced-out.
- 2 Let ℓ be the width of the N register of the synthesis S . Define the stopping width $w_0 \equiv 20d(\Delta + h(n) + 2)$.
- 3 **if** $\ell < w_0 = 20d(\Delta + h(n) + 2)$ **OR** $\eta < 1$ **then**
- 4 Use the base-case algorithm \mathcal{B} to compute the quantity $\langle 0_N | \phi_S | 0_N \rangle$ to within error ϵ .
- 5 **return** $\mathcal{B}(S, \epsilon)$
- 6 **else**
- 7 We will “slice” the 3D geometrically-local, depth- d synthesis S in Δ different locations, as follows:
- 8 Since N is 3D we define a region $Z \subset N$ to be the sub-cube of N which has width $10d(\Delta + h(n) + 2)$, and is centered at the halfway point of N width-wise (about the point $\ell/2$ of the way across N). Since the maximum amount of width collectively between Δ slices in K_{heavy} is $10d\Delta + 10d \cdot h(n)$ (see Algorithm 1), we are guaranteed that the region Z will contain at least Δ slices, $K_1, K_2, \dots, K_\Delta$, from K_{heavy} . For any two slices $K_i, K_j \in K_{heavy}$, let the un-normalized states $|\varphi_{L,i}\rangle, |\varphi_{i,j}\rangle, |\varphi_{j,R}\rangle$, and corresponding sub-syntheses $S_{L,i}, S_{i,j}, S_{j,R}$ be as defined in Definition 23, with $K = \log^3(n)$. We will use these to describe the result of our division step below.
- 9 For each $K_i \in K_{heavy}$ pre-compute the quantity κ_{T,ϵ_2}^i , with $T = \log^3(n)$, and $\epsilon_2 = \delta 2^{-10 \log(n) \log(\log(n))}$.
- 10 **return**

$$\sum_{i=1}^{\Delta} \frac{1}{(\kappa_{T,\epsilon_2}^i)^{4K+1}} \mathcal{A}(S_{L,i}, \eta - 1) \cdot \mathcal{A}(S_{i,R}, \eta - 1) \quad (28)$$

$$- \sum_{i=1}^{\Delta} \sum_{j=i+1}^{\Delta} \frac{1}{(\kappa_{T,\epsilon_2}^i \kappa_{T,\epsilon_2}^j)^{4K+1}} \mathcal{A}(S_{L,i}, \eta - 1) \cdot \mathcal{B}(S_{i,j}, \epsilon) \cdot \mathcal{A}(S_{j,R}, \eta - 1) \quad (29)$$

$$+ \sum_{i=1}^{\Delta} \sum_{j=i+2}^{\Delta} \frac{1}{(\kappa_{T,\epsilon_2}^i \kappa_{T,\epsilon_2}^j)^{4K+1}} \mathcal{A}(S_{L,i}, \eta - 1) \cdot \mathcal{A}(S_{j,R}, \eta - 1) \cdot \left[\sum_{\sigma \in \mathcal{P}(\{i+1, \dots, j-1\}) \setminus \emptyset} (-1)^{|\sigma|+1} \mathcal{B} \left(\left(\otimes_{k \in \sigma} \Pi_{F_k}^K \langle 0_{M_k} | \right) \phi_{i,j} \left(\otimes_{k \in \sigma} |0_{M_k}\rangle \Pi_{F_k}^K \right), \frac{\epsilon}{2^\Delta} \right) \right] \quad (30)$$

/* In the above $\mathcal{B} \left(\left(\otimes_{k \in \sigma} \Pi_{F_k}^K \langle 0_{M_k} | \right) \phi_{i,j} \left(\otimes_{k \in \sigma} |0_{M_k}\rangle \Pi_{F_k}^K \right), \frac{\epsilon}{2^\Delta} \right)$ denotes an $\frac{\epsilon}{2^\Delta}$ approximation of the quantity $\left(\langle 0_{ALL} | \otimes_{k \in \sigma} \Pi_{F_k}^K \right) \phi_{i,j} \left(\otimes_{k \in \sigma} \Pi_{F_k}^K | 0_{ALL} \rangle \right)$ obtained via base case Algorithm \mathcal{B} . Note that for brevity it is implied that $\mathcal{A}(S, \eta) = \mathcal{A}(S, \eta, \Delta, \epsilon, h(n), K_{heavy}, \mathcal{B})$. */

Parameter	Value	Description
C	—	3D geometrically-local quantum circuit on n qubits. Recall that approximating $ \langle 0^{\otimes n} C 0^{\otimes n} \rangle ^2$ is the goal of Algorithm 1.
\mathcal{B}	—	Algorithm for 2D geometrically-local circuits to be used in the base case of Algorithm 2. See Remark 6 and Theorem 5 of [BGM20] for the base case algorithm used in our analysis.
δ	$1/n^{-\log(n)}$	Desired additive error for the approximation output by Algorithm 1. Note that this is better than inverse polynomial error, for any polynomial.
$h(n)$	$\log^7(n)$	Helps control the overall width of the central region Z (see Description of Z below).
K_{heavy}	—	Set of slices $\{K_i\}$ satisfying Line 8 of Algorithm 1. Existence of these slices follows from an application of Lemma 11.
S	—	Synthesis for a circuit Γ as described in Definition 23. During the first run of Algorithm 2 this will correspond to a synthesis for the circuit C .
η	$\frac{\log(n)}{3 \log(4/3)}$	Maximum depth for the recursive calls to Algorithm 2. $\eta = 0$ is one stopping condition for using the base case algorithm in Line 5 of Algorithm 2.
Δ	$\log(n)$	Number of slices from K_{heavy} that will be used in the division step for Algorithm 2.
ϵ	$\delta 2^{-10 \log(n) \log(\log(n))}$	Desired error for applications of the base-case algorithm in the return statement of Algorithm 2.
d	—	Depth of the circuit C
ℓ	—	Width of the N register of the synthesis S .
w_0	$20d(\Delta + h(n) + 2)$	Stopping width for Algorithm 2. $\ell < w_0$ is one stopping condition for using the base case algorithm in Line 5 of Algorithm 2.
Z	—	Subset of width $10d(\Delta + h(n) + 2)$ in the center of the N register, specified in Algorithm 2, from which Δ slices in K_{heavy} will be chosen. Note that any subproblems contained within Z will, by definition, satisfy the stopping condition $\ell < w_0$, and will consequently be handled by the base-case algorithm \mathcal{B} (see also Remark 6).
K	$\log^3(n)$	The number of repeated compositions of the block encoding for ρ_{F_i} used to produce the approximation $\rho_{F_i}^K$ for the top Schmidt vector $ w_1\rangle \langle w_1 _{F_i}$.
T	$\log^3(n)$	The number of repeated compositions of the block encoding for ρ_{B_i} used to produce the approximation κ_{T,ϵ_2}^i for the top Schmidt coefficient λ_1^i , as prescribed in Definition 25.
ϵ_2	$\delta 2^{-10 \log(n) \log(\log(n))}$	Desired error for applications of the base-case algorithm when computing the quantities κ_{T,ϵ_2}^i in Line 9 of Algorithm 2.

Table 1: Parameters used within Algorithms 1 and 2

Therefore, in this case, Algorithm 1 returns the quantity 0 as an answer, which is trivially a δ -additive error approximation of $|\langle 0_{ALL} | C | 0_{ALL} \rangle|^2$ by Equation 32.

On the other hand, if the IF statement on Line 9 of Algorithm 1 is not satisfied, then that means that the IF statement of Line 10 must be satisfied, by definition. In that case Algorithm 1 returns the quantity:

$$\mathcal{A}(S, \eta = \frac{\log(n)}{3 \log(4/3)}, \Delta = \log(n), \epsilon = \delta 2^{-10 \log(n) \log(\log(n))}, h(n) = \log^7(n), K_{heavy}, \mathcal{B})$$

which we know is an $f(S, \eta, \Delta, \epsilon)$ -additive error approximation of $|\langle 0_{ALL} | C | 0_{ALL} \rangle|^2$. With $\eta = \frac{\log(n)}{3 \log(4/3)}$, by Lemma 32 we know that:

$$\begin{aligned} f(S, \eta, \Delta, \epsilon) &\leq \eta 20^\eta \Delta^{2\eta} \left(E_3(n, K, T, \epsilon_2, \epsilon, \Delta) + (2e(n) + 2g(n))^\Delta \right) \\ &= \eta 20^\eta \Delta^{3\eta} O \left(2^\Delta (2e(n))^K + 2^\Delta K \left(e(n)^{2T} + \epsilon_2 \right) + \epsilon \right) \\ &= 1/3 \log(4/3) \cdot \log(n) 20^{\frac{\log(n)}{3 \log(4/3)}} (\log(n))^{3 \frac{\log(n)}{3 \log(4/3)}} O \left(2^{\log(n)} \left(2 \left(1 - 2^{\frac{\log(\delta)}{\log^7(n)}} \right) \log^3(n) \right. \right. \\ &\quad \left. \left. + 2^{\log(n)} \log^3(n) \left(\left(1 - 2^{\frac{\log(\delta)}{\log^7(n)}} \right) 2 \log^3(n) + \epsilon_2 \right) + \delta 2^{-10 \log(n) \log(\log(n))} \right) \right) \\ &\leq (\log(n))^{2 \log(n)} \cdot \text{poly}(n) \cdot \left(\left(2 \left(1 - 2^{\frac{\log(\delta)}{\log^7(n)}} \right) \right) \log^3(n) + \epsilon_2 + \delta 2^{-10 \log(n) \log(\log(n))} \right) \\ &\leq (\log(n))^{2 \log(n)} \cdot \text{poly}(n) \cdot \left(\left(O \left(\frac{1}{\log^4(n)} \right) \right)^{\log^3(n)} + 2 \cdot \delta 2^{-10 \log(n) \log(\log(n))} \right) \\ &\leq 2^{2 \log(n) \log(\log(n))} \cdot \text{poly}(n) \cdot \left(O \left(\frac{1}{\log^4(n)} \right) \right)^{\log^3(n)} + \delta 2^{-8 \log(n) \log(\log(n))} \\ &\leq o(1) \cdot \delta + o(1) \cdot \delta = o(1) \cdot \delta \end{aligned} \tag{34}$$

where the first inequality follows from Lemma 32 and the rest follows by calculation, noting that $E_3(n, K, T, \epsilon_2, \epsilon, \Delta) \geq (2e(n) + 2g(n))^\Delta$ for our specific choice of parameters (in particular $\Delta = \log(n)$), recalling that $e(n) \leq \left(1 - 2^{\frac{\log(\delta)}{\log^7(n)}} \right) = O(1/\log^4(n))$ (since $\delta \geq n^{-\log^2(n)} = 2^{-\log(n)^3}$ as verified in Algorithm 1), $K = \log^3(n)$, $T = \log^3(n)$, and $\epsilon_2 = \delta 2^{-10 \log(n) \log(\log(n))}$. The final inequality, which claims $2^{2 \log(n) \log(\log(n))} \cdot \text{poly}(n) \cdot \left(O \left(\frac{1}{\log^4(n)} \right) \right)^{\log^3(n)} = o(1) \cdot \delta$, again follows because $\delta \geq n^{-\log^2(n)}$ as verified in the driver algorithm, Algorithm 1.

Runtime: The runtime analysis of Algorithm 1, $\mathcal{A}_{full}(C, \mathcal{B}, \delta)$, proceeds by considering the same four cases in the IF statements on Lines 1, 3, 9, and 10, just as in the error analysis above. Just as before, the first three cases are easy. If the IF statement Line 1 is satisfied, then the specified additive error δ is so small that we can compute the desired quantity, $|\langle 0_{ALL} | C | 0_{ALL} \rangle|^2$, exactly, by brute force, in $2^{O(n)}$ time, and this will still take less time than the guaranteed runtime:

$$T(n) = \delta^{-2} 2^{d^3 \text{polylog}(n) (1/\delta)^{1/\log^2(n)}}.$$

So, if the IF statement on Line 1 is satisfied, then we are done.

If the the IF statement in Line 3 is satisfied then the algorithm outputs $1/2$, which is a constant time operation, and we are done.

On the other hand, in the case that these first two IF statements are not satisfied, we must bound the running time of Line 5. Line 5 can clearly be done in polynomial time, which is an additive cost that is significantly less than our ultimate quasi-polynomial running time upper bound, so we can absorb it into the $O(\cdot)$ notation, and continue without explicitly tracking it. Line 5 calls for the use of the base case algorithm \mathcal{B} (which we have specified to be the algorithm from Theorem 5 of [BGM20]) to estimate, for every slice K_i , the quantity:

$$\langle 0_{ALL} | C^\dagger | 0_{M_i} \rangle \langle 0_{M_i} | C | 0_{ALL} \rangle = \text{tr} \left(\langle 0_{M_i} | C | 0_{ALL} \rangle \langle 0_{ALL} | C^\dagger | 0_{M_i} \rangle \right),$$

In particular we use \mathcal{B} to estimate this quantity to within additive error $\tilde{\epsilon} \equiv 2^{\frac{\log(\delta)}{2h(n)}-1} - 2^{\frac{\log(\delta)}{h(n)}-1}$, and we count only those slices for which the approximation output by \mathcal{B} is at least $2^{\frac{\log(\delta)}{h(n)} + \tilde{\epsilon}}$. So, all the slices accepted by this count will necessarily have weight at least $2^{\frac{\log(\delta)}{h(n)} + \tilde{\epsilon} - \tilde{\epsilon}} = 2^{\frac{\log(\delta)}{h(n)}}$. Furthermore, any slice with weight at least $2^{\frac{\log(\delta)}{h(n)} + 2\tilde{\epsilon}} = 2^{\frac{\log(\delta)}{2h(n)}}$ will certainly be counted by this process. Therefore, this procedure is able to determine which of Line 5 or Line 7 is true. (As noted in a comment in the Algorithm, one of these two must be the case.) It remains to bound the running time cost of these uses of algorithm \mathcal{B} . The key observation here is that the quantity:

$$\text{tr} \left(\langle 0_{M_i} | C | 0_{ALL} \rangle \langle 0_{ALL} | C^\dagger | 0_{M_i} \rangle \right),$$

only depends on the part of the circuit C that lies in the lightcone of slice M_i . By definition the lightcone of M_i is contained in K_i , and K_i is a 2D slice with thickness $30d = O(d)$ in third dimension. By the discussion in Remark 6 it follows that the base case algorithm \mathcal{B} can compute the quantity:

$$\text{tr} \left(\langle 0_{M_i} | C | 0_{ALL} \rangle \langle 0_{ALL} | C^\dagger | 0_{M_i} \rangle \right),$$

to within additive error $\tilde{\epsilon} \equiv 2^{\frac{\log(\delta)}{2h(n)}-1} - 2^{\frac{\log(\delta)}{h(n)}-1}$ in time $O(\text{poly}(n)/\tilde{\epsilon}^2) = O(\text{poly}(n)/(1 - \delta^{1/2h(n)})^2) = O(2^{\text{polylog}(n)})$, where the final equality follows by straightforward calculation whenever $\delta \leq 1/2$ (recall that we previously established that $\delta \leq 1/2$ by checking that the IF statement in Line 3 was not satisfied).

Next, if the IF statement in Line 9 is satisfied, then our Algorithm 1 returns the quantity 0 as an answer, which is a constant time operation, and we are done.

On the other hand, if the IF statement on Line 9 of Algorithm 1 is not satisfied, then that means that the IF statement of Line 10 must be satisfied, by definition. In that case Algorithm 1 returns the quantity:

$$\mathcal{A}(S, \eta = 1/3 \log(n), \Delta = \log(n), \epsilon = \delta 2^{-10 \log(n) \log(\log(n))}, h(n) = \log^3(n), K_{heavy}, \mathcal{B})$$

which we know is an $f(S, \eta, \Delta, \epsilon)$ -additive error approximation of $|\langle 0_{ALL} | C | 0_{ALL} \rangle|^2$, and takes $T(n) < \delta^{-2} 2^{d^3 \text{polylog}(n)}$ time to compute. This time bound follows directly from the runtime bound on Algorithm 2, which is given in Theorem 33 of Subsection 5.3. All together, regardless of which IF statements are true, no step of Algorithm 1 exceeds a running time of $\delta^{-2} 2^{d^3 \text{polylog}(n) (1/\delta)^{1/\log^2(n)}}$, and so we are done. \square

5.2 Error Analysis for Algorithm 2

In this subsection we will derive, by induction, an error bound on the estimate produced by Algorithm 2, $\mathcal{A}(S, \eta, \Delta, \epsilon, \mathcal{B}, K_{heavy}, r)$. We will only pursue an error analysis of \mathcal{A} under the assumption that the driver algorithm, Algorithm 1, has actually called Algorithm 2, and has thus constructed the set K_{heavy} according to specification. This is because, if Algorithm 1 does not call Algorithm 2, that means that it has already found an easier approximation to the answer, and the output of \mathcal{A} (Algorithm 2) is not relevant. Recall that, given a synthesis S , the goal of Algorithm 2 is to compute the quantity $|\langle 0_N | \phi \rangle \langle \phi | 0_N \rangle|^2$ where $|\phi\rangle$ is the state synthesized by synthesis S , and N is the active register, as defined in Definition 21. The Algorithm $\mathcal{A}(S, \eta, \Delta, \epsilon, \mathcal{B}, K_{heavy}, r)$ is a recursive algorithm and, since the variables $\Delta, \epsilon, \mathcal{B}, K_{heavy}$, and r remain unchanged throughout, we will use a simplification $\mathcal{A}(S, \eta, \Delta, \epsilon, \mathcal{B}, K_{heavy}, r) = \mathcal{A}(S, \eta)$ throughout this analysis. The output of Algorithm 2 is the scalar quantity:

$$\begin{aligned}
\mathcal{A}(S, \eta) &\equiv \sum_{i=1}^{\Delta} \frac{1}{(\kappa_{T, \epsilon_2}^i)^{4K+1}} \mathcal{A}(S_{L,i}, \eta - 1) \cdot \mathcal{A}(S_{i,R}, \eta - 1) \\
&- \sum_{i=1}^{\Delta} \sum_{j=i+1}^{\Delta} \frac{1}{(\kappa_{T, \epsilon_2}^i \kappa_{T, \epsilon_2}^j)^{4K+1}} \mathcal{A}(S_{L,i}, \eta - 1) \cdot \mathcal{B}(S_{i,j}, \epsilon) \cdot \mathcal{A}(S_{j,R}, \eta - 1) \\
&+ \sum_{i=1}^{\Delta} \sum_{j=i+2}^{\Delta} \frac{1}{(\kappa_{T, \epsilon_2}^i \kappa_{T, \epsilon_2}^j)^{4K+1}} \mathcal{A}(S_{L,i}, \eta - 1) \cdot \mathcal{A}(S_{j,R}, \eta - 1) \\
&\cdot \left[\sum_{\sigma \in \mathcal{P}(\{i+1, \dots, j-1\}) \setminus \emptyset} (-1)^{|\sigma|+1} \mathcal{B} \left(\left(\otimes_{k \in \sigma} \Pi_{F_k}^K \langle 0_{M_k} | \right) \phi_{i,j} \left(\otimes_{k \in \sigma} |0_{M_k}\rangle \Pi_{F_k}^K \right), \frac{\epsilon}{2\Delta} \right) \right]
\end{aligned} \tag{35}$$

Here the notation $\mathcal{B}(T, \epsilon)$ denotes the use of the ‘‘base case’’ algorithm to estimate the quantity $|\langle 0_{ALL} | \phi_T \rangle \langle \phi_T | 0_{ALL} \rangle|^2$ to within a desired additive error ϵ , for the specified synthesis T . For us the ‘‘base case’’ algorithm will be defined to be the algorithm from Theorem 5 of [BGM20]. This algorithm can be used for middle sections of the circuit since these sections have a 2D geometry with a ‘‘thickness’’ of at most a polylogarithmic number of qubits in the third dimension. The algorithm from Theorem 5 of [BGM20] can compute an ϵ -additive-error approximation of output probabilities of such syntheses in $O(2^{\text{polylog}(n)} \text{poly}(\frac{1}{\epsilon}))$ time. Note this is not stated explicitly in [BGM20], which technically only handles true 2D circuits (in other words, circuits with ‘‘thickness’’ exactly 1 in the third dimension), but their techniques can be extended to the case of polylogarithmic thickness in a straightforward manner (to do so, increase the bond dimension of their Matrix Product States to polylogarithmic size account for the added ‘‘thickness’’ of qubits).

Since we have assumed that Algorithm 1 has called Algorithm 2, we know that every slice K_i in the input set K_{heavy} to $\mathcal{A}(S, \eta, \Delta, \omega_0, \epsilon, \mathcal{B}, K_{heavy}, r) = \mathcal{A}(S, \eta)$ satisfies:

$$\left| \text{tr} \left(\langle 0_{M_i} | C | 0_{ALL} \rangle \langle 0_{ALL} | C^\dagger | 0_{M_i} \rangle \right) \right| \geq 2^{\frac{\log(\delta)}{h(n)}} = 2^{\frac{-\log(1/\delta)}{h(n)}}.$$

Equivalently, $p_{total}(M_i = 0) \geq 1 - e(n)$, where we define:

$$e(n) \equiv \left(1 - 2^{\frac{-\log(1/\delta)}{h(n)}} \right). \tag{36}$$

It follows from Lemma 13 that, $\forall K_i \in K_{heavy}$, $\lambda_1^i \geq 1 - O(e(n))$.

We know, by Lemma 18 that,

$$\left\| \sum_{\sigma \in \mathcal{P}([\Delta])} (-1)^{|\sigma|} |\Psi_\sigma\rangle \langle \Psi_\sigma| \right\| = \left\| |\Psi_\emptyset\rangle \langle \Psi_\emptyset| - \sum_{\sigma \in \mathcal{P}([\Delta]) \setminus \emptyset} (-1)^{|\sigma|+1} |\Psi_\sigma\rangle \langle \Psi_\sigma| \right\| \leq (2e(n) + 2g(n))^\Delta \quad (37)$$

where $g(n) \equiv \left(\frac{1-\lambda_1^i}{\lambda_1^i}\right)^K \leq \left(\frac{e(n)}{1-O(e(n))}\right)^K$, and the states $|\Psi_\sigma\rangle$ are defined as:

$$\begin{aligned} |\Psi_\sigma\rangle &= \otimes_{j \in \sigma} \Pi_{F_j}^K \otimes_{i \in [\Delta]} \langle 0_{M_i} | C | 0_{ALL} \rangle, \\ |\Psi_\emptyset\rangle &= \otimes_{i \in [\Delta]} \langle 0_{M_i} | C | 0_{ALL} \rangle. \end{aligned}$$

Note that, $\langle 0_{ALL} | \Psi_\emptyset \rangle \langle \Psi_\emptyset | 0_{ALL} \rangle$ is exactly the quantity that we wish for Algorithm 2 to output! So, the error between the returned output of Algorithm 2, (defined on Line 10 of that algorithm), which we will denote by \mathcal{A} for short, and the desired output quantity $\langle 0_{ALL} | \Psi_\emptyset \rangle \langle \Psi_\emptyset | 0_{ALL} \rangle$ is:

$$f(S, \eta, \Delta, \epsilon) \leq \left\| \langle 0_{ALL} | \Psi_\emptyset \rangle \langle \Psi_\emptyset | 0_{ALL} \rangle - \mathcal{A} \right\| \quad (38)$$

$$\leq \left\| \langle 0_{ALL} | \Psi_\emptyset \rangle \langle \Psi_\emptyset | 0_{ALL} \rangle - \sum_{\sigma \in \mathcal{P}([\Delta]) \setminus \emptyset} (-1)^{|\sigma|+1} \langle 0_{ALL} | \Psi_\sigma \rangle \langle \Psi_\sigma | 0_{ALL} \rangle \right\| \quad (39)$$

$$+ \left\| \sum_{\sigma \in \mathcal{P}([\Delta]) \setminus \emptyset} (-1)^{|\sigma|+1} \langle 0_{ALL} | \Psi_\sigma \rangle \langle \Psi_\sigma | 0_{ALL} \rangle - \mathcal{A} \right\| \quad (40)$$

$$\leq (2e(n) + 2g(n))^\Delta + \left\| \sum_{\sigma \in \mathcal{P}([\Delta]) \setminus \emptyset} (-1)^{|\sigma|+1} \langle 0_{ALL} | \Psi_\sigma \rangle \langle \Psi_\sigma | 0_{ALL} \rangle - \mathcal{A} \right\|$$

$$= (2e(n) + 2g(n))^\Delta + \left\| \sum_{\sigma \in \mathcal{P}([\Delta]) \setminus \emptyset} (-1)^{|\sigma|+1} \langle 0_{ALL} | \Psi_\sigma \rangle \langle \Psi_\sigma | 0_{ALL} \rangle \right.$$

$$- \left(\sum_{i=1}^{\Delta} \frac{1}{(\kappa_{T, \epsilon_2}^i)^{4K+1}} \mathcal{A}(S_{L,i}, \eta - 1) \cdot \mathcal{A}(S_{i,R}, \eta - 1) \right) \quad (41)$$

$$- \sum_{i=1}^{\Delta} \sum_{j=i+1}^{\Delta} \frac{1}{(\kappa_{T, \epsilon_2}^i \kappa_{T, \epsilon_2}^j)^{4K+1}} \mathcal{A}(S_{L,i}, \eta - 1) \cdot \mathcal{B}(S_{i,j}, \epsilon) \cdot \mathcal{A}(S_{j,R}, \eta - 1)$$

$$+ \sum_{i=1}^{\Delta} \sum_{j=i+2}^{\Delta} \frac{1}{(\kappa_{T, \epsilon_2}^i \kappa_{T, \epsilon_2}^j)^{4K+1}} \mathcal{A}(S_{L,i}, \eta - 1) \cdot \mathcal{A}(S_{j,R}, \eta - 1)$$

$$\cdot \left[\sum_{\sigma \in \mathcal{P}(\{i+1, \dots, j-1\}) \setminus \emptyset} (-1)^{|\sigma|+1} \mathcal{B} \left(\left(\otimes_{k \in \sigma} \Pi_{F_k}^K \langle 0_{M_k} | \right) \phi_{i,j} \left(\otimes_{k \in \sigma} | 0_{M_k} \rangle \Pi_{F_k}^K \right), \frac{\epsilon}{2^\Delta} \right) \right] \right\|$$

Grouping analogous terms and using triangle inequality gives:

$$\begin{aligned}
f(S, \eta, \Delta, \epsilon) &\leq (2e(n) + 2g(n))^\Delta \\
&+ \left\| \sum_{i=1}^{\Delta} \left(\frac{1}{(\kappa_{T, \epsilon_2}^i)^{4K+1}} \mathcal{A}(S_{L,i}, \eta - 1) \cdot \mathcal{A}(S_{i,R}, \eta - 1) - \langle 0_{ALL} | \Psi_{\{i\}} \rangle \langle \Psi_{\{i\}} | 0_{ALL} \rangle \right) \right. \\
&- \sum_{i=1}^{\Delta} \sum_{j=i+1}^{\Delta} \left(\frac{1}{(\kappa_{T, \epsilon_2}^i \kappa_{T, \epsilon_2}^j)^{4K+1}} \mathcal{A}(S_{L,i}, \eta - 1) \cdot \mathcal{B}(S_{i,j}, \epsilon) \cdot \mathcal{A}(S_{j,R}, \eta - 1) - \langle 0_{ALL} | \Psi_{\{i,j\}} \rangle \langle \Psi_{\{i,j\}} | 0_{ALL} \rangle \right) \\
&+ \sum_{i=1}^{\Delta} \sum_{j=i+2}^{\Delta} \sum_{\sigma \in \mathcal{P}(\{i+1, \dots, j-1\}) \setminus \emptyset} \left(\frac{1}{(\kappa_{T, \epsilon_2}^i \kappa_{T, \epsilon_2}^j)^{4K+1}} \mathcal{A}(S_{L,i}, \eta - 1) \cdot \mathcal{A}(S_{j,R}, \eta - 1) \right. \\
&\cdot (-1)^{|\sigma|+1} \mathcal{B} \left(\left(\otimes_{k \in \sigma} \Pi_{F_k}^K \langle 0_{M_k} | \right) \phi_{i,j} \left(\otimes_{k \in \sigma} | 0_{M_k} \rangle \Pi_{F_k}^K \right), \frac{\epsilon}{2^\Delta} \right) \\
&- \left. \langle 0_{ALL} | \Psi_{\{i,j\} \cup \sigma} \rangle \langle \Psi_{\{i,j\} \cup \sigma} | 0_{ALL} \rangle \right\| \\
&\leq (2e(n) + 2g(n))^\Delta \\
&+ \sum_{i=1}^{\Delta} \left\| \left(\frac{1}{(\kappa_{T, \epsilon_2}^i)^{4K+1}} \mathcal{A}(S_{L,i}, \eta - 1) \cdot \mathcal{A}(S_{i,R}, \eta - 1) - \langle 0_{ALL} | \Psi_{\{i\}} \rangle \langle \Psi_{\{i\}} | 0_{ALL} \rangle \right) \right\| \\
&+ \sum_{i=1}^{\Delta} \sum_{j=i+1}^{\Delta} \left\| \left(\frac{1}{(\kappa_{T, \epsilon_2}^i \kappa_{T, \epsilon_2}^j)^{4K+1}} \mathcal{A}(S_{L,i}, \eta - 1) \cdot \mathcal{B}(S_{i,j}, \epsilon) \cdot \mathcal{A}(S_{j,R}, \eta - 1) - \langle 0_{ALL} | \Psi_{\{i,j\}} \rangle \langle \Psi_{\{i,j\}} | 0_{ALL} \rangle \right) \right\| \\
&+ \sum_{i=1}^{\Delta} \sum_{j=i+2}^{\Delta} \left\| \sum_{\sigma \in \mathcal{P}(\{i+1, \dots, j-1\}) \setminus \emptyset} (-1)^{|\sigma|+1} \left(\frac{1}{(\kappa_{T, \epsilon_2}^i \kappa_{T, \epsilon_2}^j)^{4K+1}} \mathcal{A}(S_{L,i}, \eta - 1) \cdot \mathcal{A}(S_{j,R}, \eta - 1) \right. \right. \\
&\cdot \mathcal{B} \left(\left(\otimes_{k \in \sigma} \Pi_{F_k}^K \langle 0_{M_k} | \right) \phi_{i,j} \left(\otimes_{k \in \sigma} | 0_{M_k} \rangle \Pi_{F_k}^K \right), \frac{\epsilon}{2^\Delta} \right) \\
&- \left. \left. \langle 0_{ALL} | \Psi_{\{i,j\} \cup \sigma} \rangle \langle \Psi_{\{i,j\} \cup \sigma} | 0_{ALL} \rangle \right) \right\| \tag{42}
\end{aligned}$$

The three summations in Equation 42 are written separately for notational convenience. The first summation includes all the terms corresponding to the case when the input synthesis is “sliced” at exactly one cut, and these terms are bounded in Lemma 29. The second summation includes all the terms involving “slices” at exactly 2 cuts, and these terms are bounded in Lemma 30. The third summation includes all the remaining terms, which cover all the cases involving “slices” at three or more of the Δ cuts. Each of these terms is bounded in Lemma 31. For a depiction of these three cases see Figure 5.

Lemma 29.

$$\begin{aligned}
&\left\| \left(\frac{1}{(\kappa_{T, \epsilon_2}^i)^{4K+1}} \mathcal{A}(S_{L,i}, \eta - 1) \cdot \mathcal{A}(S_{i,R}, \eta - 1) - \langle 0_{ALL} | \Psi_{\{i\}} \rangle \langle \Psi_{\{i\}} | 0_{ALL} \rangle \right) \right\| \\
&\leq E_1(n, K, T, \epsilon_2) + 2f(S, \eta - 1, \Delta, \epsilon),
\end{aligned}$$

where $E_1(n, K, T, \epsilon_2) \equiv 10K(e(n)^{2T} + 6g(n) + \epsilon_2)$.

Proof. The proof of this Lemma is a simpler special case of the proof of Lemma 31 below. It is simpler in that it follows by using Lemma 26, and Lemma 20, and does not require the use of

Lemma 18 as the proof of Lemma 31 does. For succinctness, instead of writing out this entire proof, we refer the reader to the proof of Lemma 31 in the Appendix, of which the proof of this Lemma is a special case. \square

Lemma 30.

$$\left\| \left(\frac{1}{(\kappa_{T,\epsilon_2}^i \kappa_{T,\epsilon_2}^j)^{4K+1}} \mathcal{A}(S_{L,i}, \eta - 1) \cdot \mathcal{B}(S_{i,j}, \epsilon) \cdot \mathcal{A}(S_{j,R}, \eta - 1) - \langle 0_{ALL} | \Psi_{\{i,j\}} \rangle \langle \Psi_{\{i,j\}} | 0_{ALL} \rangle \right) \right\| \quad (43)$$

$$\leq E_2(n, K, T, \epsilon_2, \epsilon) + 2f(S, \eta - 1, \Delta, \epsilon),$$

where $E_2(n, K, T, \epsilon_2, \epsilon) \equiv 10K(e(n)^{2T} + 6g(n) + \epsilon_2) + \epsilon$

Proof. The proof of this Lemma is a simpler special case of the proof of Lemma 31 below. It is simpler in that it follows by using Lemma 26, and Lemma 20, and does not require the use of Lemma 18 as the proof of Lemma 31 does. For succinctness, instead of writing out this entire proof, we refer the reader to the proof of Lemma 31 in the Appendix, of which the proof of this Lemma is a special case. \square

Lemma 31.

$$\left\| \sum_{\sigma \in \mathcal{P}(\{i+1, \dots, j-1\}) \setminus \emptyset} (-1)^{|\sigma|+1} \left(\frac{1}{(\kappa_{T,\epsilon_2}^i \kappa_{T,\epsilon_2}^j)^{4K+1}} \mathcal{A}(S_{L,i}, \eta - 1) \cdot \mathcal{A}(S_{j,R}, \eta - 1) \right. \right. \quad (44)$$

$$\cdot \mathcal{B} \left(\left(\otimes_{k \in \sigma} \Pi_{F_k}^K \langle 0_{M_k} | \right) \phi_{i,j} \left(\otimes_{k \in \sigma} | 0_{M_k} \rangle \Pi_{F_k}^K, \frac{\epsilon}{2\Delta} \right) - \langle 0_{ALL} | \Psi_{\{i,j\} \cup \sigma} \rangle \langle \Psi_{\{i,j\} \cup \sigma} | 0_{ALL} \rangle \right) \left. \right\|$$

$$\leq E_3(n, K, T, \epsilon_2, \epsilon, \Delta) + 16f(S, \eta - 1, \Delta, \epsilon),$$

where

$$E_3(n, K, T, \epsilon_2, \epsilon, \Delta) \equiv O \left(2^\Delta (6g(n)) + 2^\Delta K (e(n)^{2T} + \epsilon_2) + \epsilon \right)$$

Proof. The proof follows by two uses Lemma 20, Lemma 26, AND (unlike the previous two Lemmas) Lemma 18. See Appendix A for a full proof. \square

Returning to where we left off in Equation 42, using all three of the above Lemmas, we have

$$\begin{aligned} f(S, \eta, \Delta, \epsilon) &\leq (2e(n) + 2g(n))^\Delta + \Delta (E_1(n, K, T, \epsilon_2, \epsilon) + 2f(S, \eta - 1, \Delta, \epsilon)) \\ &\quad + \Delta^2 (E_2(n, K, T, \epsilon_2, \epsilon) + 2f(S, \eta - 1, \Delta, \epsilon)) + \Delta^2 (E_3(n, K, T, \epsilon_2, \epsilon, \Delta) + 16f(S, \eta - 1, \Delta, \epsilon)) \\ &\leq (2e(n) + 2g(n))^\Delta + 3\Delta^2 E_3(n, K, T, \epsilon_2, \epsilon, \Delta) + 20\Delta^2 f(S, \eta - 1, \Delta, \epsilon), \end{aligned} \quad (45)$$

where the final inequality follows because $E_3(n, K, T, \epsilon_2, \epsilon, \Delta) \geq E_2(n, K, T, \epsilon_2, \epsilon) \geq E_1(n, K, T, \epsilon_2, \epsilon)$.

We note that, when $\eta = 0$ we have $f(S, \eta, \Delta, \epsilon) = f(S, 0, \Delta, \epsilon) \leq \epsilon$. This is because, in the definition of Algorithm 2, if $\eta < 1$ the algorithm the calls subroutine $\mathcal{B}(S, \epsilon)$ and computes the final desired quantity with error ϵ . This gives us the base case that we need to bound $f(S, \eta, \Delta, \epsilon)$ via standard recursive analysis:

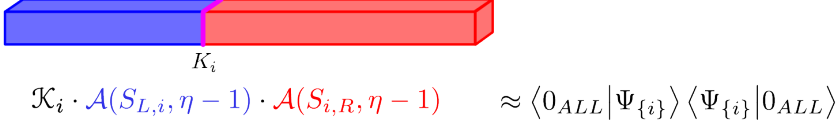
(a) 

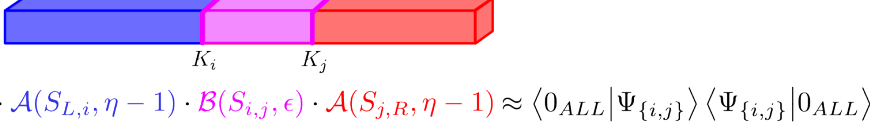
(b) 

(c) 

Figure 5: Depiction of the types of terms that appear in Equation 42: (a) those involving exactly one cut, $\{i\}$, (b) those involving exactly two cuts, $\{i, j\}$, and (c) those involved three or more of the Δ cuts, $\{i, j\} \cup \sigma$, for $\sigma \in \mathcal{P}(\{i + 1, \dots, j - 1\}) \setminus \emptyset$. For brevity we have denoted $\mathcal{K}_i \equiv \frac{1}{(\kappa_{T, \epsilon_2}^i)^{4K+1}}$ and $\mathcal{K}_{i,j} \equiv \frac{1}{(\kappa_{T, \epsilon_2}^i \kappa_{T, \epsilon_2}^j)^{4K+1}}$.

Lemma 32. *The error function $f(S, \eta, \Delta, \epsilon)$ obeys the following bound:*

$$f(S, \eta, \Delta, \epsilon) \leq \eta 20^\eta \Delta^{2\eta} \left(E_3(n, K, T, \epsilon_2, \epsilon \Delta) + (2e(n) + 2g(n))^\Delta \right) \quad (46)$$

Proof. The Lemma follows by using standard analysis of the recursion in Equation 45, and with the base case $f(S, 0, \Delta, \epsilon) \leq \epsilon \leq E_3(n, K, T, \epsilon_2, \epsilon)$. \square

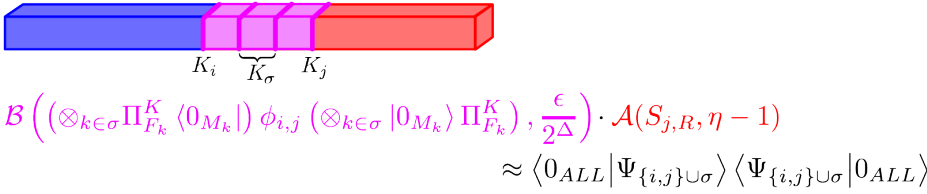
5.3 Run-Time Analysis for Algorithm 2

In this section we will derive a bound on the run-time for Algorithm 2. Recall that, given a synthesis S , the goal of Algorithm 2 is to compute the quantity $|\langle 0_N | \phi_S | 0_N \rangle|^2$ where ϕ_S is the state synthesized by synthesis S , and N is the active register, as defined in Definition 21. Recall that ℓ is defined, in Algorithm 2, to be the width of the N register for our input synthesis S . We use $T(\ell)$ to denote the run-time bound for our algorithm on a synthesis with an N register of width ℓ .

The main time cost for Algorithm 2 is accrued by the **return** line of the algorithm, which makes recursive calls to Algorithm 2 on a variety of smaller subproblems, as well as calls to the base case algorithm \mathcal{B} , and computing the κ_{T, ϵ_2}^i quantities. All of the steps performed in Algorithm 2 before the **return** line (selecting the region Z , etc), can easily be done in (lesser) polynomial time, and their total cost will be absorbed into the term $\mu(\cdot)$ in our calculations below.

Note that the **return** line of Algorithm 2 makes 2Δ distinct recursive calls to itself, which each only need to be computed once, even though they are reused multiple times in Equations 28, 29, and 30. Furthermore, the width of the active register of the synthesis input to each of the recursive

calls to Algorithm 2 is at most $\frac{\ell+|Z|}{2} \leq \frac{3}{4}\ell$ (where the inequality follows because, in the context of Algorithm 2, the relationship $|Z| \leq \frac{\ell}{2}$ is enforced by lines 3 and 8). Therefore, we know that our recursive time analysis will have the form:

$$T(\ell) < 2\Delta T\left(\frac{3}{4}\ell\right) + \zeta_1(n)$$

Where $\zeta_1(n)$ absorbs the time cost of all steps in Algorithm 2 other than the 2Δ recursive calls. We will now explicitly bound the term $\zeta_1(n)$ in order to obtain a complete runtime bound. The main time cost in $\zeta_1(n)$ comes from executing the calls to the base case algorithm \mathcal{B} in lines 29, and 30 of Algorithm 2, as well as computing the values κ_{T,ϵ_2}^i that appear throughout the **return** line of Algorithm 2. We will analyze the time cost of these two tasks separately in the two corresponding paragraphs below. The only remaining time cost then comes from the steps performed in Algorithm 2 before the **return** line (selecting the region Z , etc), and can easily be done with (less significant) polynomial time cost, which we will denote by $\mu(n)$.

Uses of \mathcal{B} in the return line of Algorithm 2: There are at most $2\Delta^2$ calls to the base case algorithm \mathcal{B} in the **return** line of Algorithm 2, which all occur in Equations 29 and 30 of the **return** line. The terms in Equation 29 have the form $\mathcal{B}(S_{i,j}, \epsilon)$, and the terms in Equation 30 have the form $\mathcal{B}\left(\left(\otimes_{k \in \sigma} \Pi_{F_k}^K \langle 0_{M_k} | \right) \phi_{i,j} \left(\otimes_{k \in \sigma} |0_{M_k}\rangle \Pi_{F_k}^K \right), \frac{\epsilon}{2\Delta}\right)$. By Remark 6 we know that, for any 3D geometrically-local, depth- D synthesis S (on n qubits, total) we can use the algorithm from Theorem 5 of [BGM20] to compute the quantity $\mathcal{B}(S, \epsilon) = |\langle 0_{ALL} | \phi_S |0_{ALL}\rangle|^2 \pm \epsilon$ in time $n\epsilon^{-2}2^{O(D^2 \cdot w)}$, where w is the width of the “active register”, N , of the synthesis S in the third dimension (see Definition 21 for the definitions of syntheses S , and the register N). Using Remark 6 in this way, we see that the quantities $\mathcal{B}(S_{i,j}, \epsilon) = |\langle 0_{ALL} | \phi_{i,j} |0_{ALL}\rangle|^2 \pm \epsilon$ from Equation 29 can each be computed in time $n\epsilon^{-2}2^{O((dK^2)^2 \cdot 10d(\Delta+h(n)+2))}$, because the synthesis $S_{i,j}$ has depth at most $O(dK^2)$ ¹, and has an active region of width at most $10d(\Delta+h(n)+2)$ in the third dimension (this width is enforced by line 8 of Algorithm 2, where $S_{i,j}$ is explicitly specified in conjunction with Definition 23).

Similarly, using Remark 6 in the same way, we see that the quantities:

$$\mathcal{B}\left(\left(\otimes_{k \in \sigma} \Pi_{F_k}^K \langle 0_{M_k} | \right) \phi_{i,j} \left(\otimes_{k \in \sigma} |0_{M_k}\rangle \Pi_{F_k}^K \right), \frac{\epsilon}{2\Delta}\right) = |\langle 0_{ALL} | \left(\otimes_{k \in \sigma} \Pi_{F_k}^K \langle 0_{M_k} | \right) \phi_{i,j} \left(\otimes_{k \in \sigma} |0_{M_k}\rangle \Pi_{F_k}^K \right) |0_{ALL}\rangle|^2 \pm \frac{\epsilon}{2\Delta},$$

can be computed in time $n2^{2\Delta}\epsilon^{-2}2^{O((dK^2+2dK^2)^2 \cdot 10d(\Delta+h(n)+2))}$, because the synthesis $\left(\otimes_{k \in \sigma} \Pi_{F_k}^K \langle 0_{M_k} | \right) \phi_{i,j} \left(\otimes_{k \in \sigma} |0_{M_k}\rangle \Pi_{F_k}^K \right)$ has an active region that is a subset of the active region of the synthesis $S_{i,j}$ for $\phi_{i,j}$, and therefore still has width at most $10d(\Delta+h(n)+2)$ in the third dimension. Additionally, the depth of the synthesis $\left(\otimes_{k \in \sigma} \Pi_{F_k}^K \langle 0_{M_k} | \right) \phi_{i,j} \left(\otimes_{k \in \sigma} |0_{M_k}\rangle \Pi_{F_k}^K \right)$ is at most $O(2dK^2)$ higher than the depth of the synthesis $S_{i,j}$ for $\phi_{i,j}$, because the depth of the operator $\otimes_{k \in \sigma} \Pi_{F_k}^K$ is at most the maximum depth of the operator $\Pi_{F_k}^K$ for any k , which is at most $O(dK^2)$, by Lemma 8 and Definitions 14 and 16. Note that we are making a slight abuse of notation in that we have always referred to the state $\left(\otimes_{k \in \sigma} \Pi_{F_k}^K \langle 0_{M_k} | \right) \phi_{i,j} \left(\otimes_{k \in \sigma} |0_{M_k}\rangle \Pi_{F_k}^K \right)$ as a synthesis, since

¹The reason that the depth of the synthesis $S_{i,j}$ is bounded by $O(dK^2)$ is that $S_{i,j}$ is constructed using the original depth- d circuit C , acted on by a number of operators $\Pi_{F_k}^K$. However, it is important to note that each $\Pi_{F_k}^K$ is always acts in tensor product with $\Pi_{F_j}^K$ on any other cut K_j for $j \neq k$. Also, each cut is only acted on at most once this way. It follows that these additive depths do not pile up during the course of Algorithm 2, and thus the total depth never exceeds $O(dK^2)$.

it's first appearance in the **return** line of Algorithm 2, even though we never wrote out the explicit synthesis structure for this state according to Definition 21. This was done in order to keep the statement of Algorithm 2 and the subsequent discussion succinct. We leave to the reader the exercise of expressing the state $\left(\otimes_{k \in \sigma} \Pi_{F_k}^K \langle 0_{M_k} | \right) \phi_{i,j} \left(\otimes_{k \in \sigma} |0_{M_k}\rangle \Pi_{F_k}^K\right)$ as a synthesis according to Definition 21, which is accomplished by a straightforward modification of the (already defined) synthesis $S_{i,j}$ for $\phi_{i,j}$, in order to include the operators and projections $\left(\otimes_{k \in \sigma} \Pi_{F_k}^K \langle 0_{M_k} | \right)$ into the synthesis (this is something that the definition of a synthesis was designed to do in the first place).

So, we are now ready to explicitly include, in our recursive time analysis, the time cost for the use of the base case algorithm \mathcal{B} in the **return** line of Algorithm 2. We now have:

$$T(\ell) < 2\Delta T \left(\frac{3}{4} \ell \right) + \Delta^2 n \epsilon^{-2} 2^{O((dK^2)^2 \cdot 10d(\Delta+h(n)+2))} + \Delta^2 n 2^{2\Delta} \epsilon^{-2} 2^{O((dK^2+2dK^2)^2 \cdot 10d(\Delta+h(n)+2))} + \zeta_2(n) + \mu(n)$$

Where $\zeta_2(n)$ denotes the time cost for computing the quantities κ_{T,ϵ_2}^i in the **return** line of Algorithm 2 (discussed below), and $\mu(n)$ denotes the (less significant) polynomial time cost that comes from the steps performed in Algorithm 2 before the **return** line (selecting the region Z , etc), as previously discussed.

Noting that, in Algorithm 2, the parameters are set as $\Delta = \log(n)$, $K = \log^3(n)$, $h(n) = \log^7(n)$, $\epsilon = \delta 2^{-10 \log(n) \log(\log(n))}$ we have:

$$T(\ell) < 2\Delta T \left(\frac{3}{4} \ell \right) + \delta^{-2} 2^{d^3 \text{polylog}(n)} + \zeta_2(n) + \mu(n)$$

We now bound the remaining time cost, $\zeta_2(n)$, in the following paragraph.

Computation of quantities κ_{T,ϵ_2}^i in the return line of Algorithm 2: The task of computing the κ_{T,ϵ_2}^i values in the **return** line of Algorithm 2 requires using the base case algorithm \mathcal{B} as specified and discussed in Definition 25 (via the usual prescription in Remark 6). In particular, according to Definition 25, we have that:

$$\kappa_{T,\epsilon_2}^i \equiv \frac{\mathcal{B}(\Lambda_1^{j,T}, \epsilon_2)}{\mathcal{B}(Z_j^{2T}, \epsilon_2)} = \frac{\text{tr}(\rho_{B_j}^T |\psi\rangle \langle \psi|_{B_j \cup M_j \cup F_j} \rho_{B_j}^T) \pm \epsilon_2}{\text{tr}(\rho_{B_j}^{2T}) \pm \epsilon_2}$$

where the syntheses $\Lambda_1^{j,T}$, and Z_j^{2T} are explicitly specified as

$$\Lambda_1^{j,T} \equiv \left(\Gamma_{P_{B_j}^T} \circ \Gamma_{B_j \cup M_j \cup F_j}, (B_j \cup F_j), (M_j \cup M_j' \cup F_j' \cup B_j^1, \dots \cup B_j^T), \right. \\ \left. , (B_j \cup M_j \cup F_j \cup M_j' \cup F_j' \cup B_j^1, \dots \cup B_j^T) \right),$$

$$Z_j^T \equiv \left(\Gamma_{P_{B_j}^T}, (B_j), (M_j' \cup F_j' \cup B_j^1, \dots \cup B_j^T) \right. \\ \left. , (B_j \cup M_j' \cup F_j' \cup B_j^1, \dots \cup B_j^T) \right),$$

Note that this is a different way of using syntheses that in other parts of Algorithm 2 because $\Lambda_1^{j,T}$, and Z_j^{2T} are scalars rather density matrices (see Definition 21 to understand why). These scalars can, nonetheless, be described, as above, by 3D geometrically-local, shallow depth syntheses as described above. In fact,

$$Z_j^T = \text{tr}\left(\rho_{B_j}^T\right),$$

and (47)

$$\Lambda_1^{j,T} = \text{tr}\left(\rho_{B_j}^T |\psi\rangle \langle \psi|_{B_j \cup M_j \cup F_j} \rho_{B_j}^T\right)$$
(48)

where

$$\rho_{B_i}^K \equiv \left\langle 0^{F_i, M_i, B_i^1, \dots, B_i^K} \left| \prod_{j=1}^K (C_{B_i \cup M_i \cup F_i}^\dagger \otimes I_{B_i^1, \dots, B_i^K}) (I_{F_i \cup M_i} \otimes \text{SWAP}_{B_i, B_i^j}) (C_{B_i \cup M_i \cup F_i} \otimes I_{B_i^1, \dots, B_i^K}) \right| 0^{F_i, M_i, B_i^1, \dots, B_i^K} \right\rangle$$

as in Lemma 8.

So, applying Theorem 5 of [BGM20] according to Remark 6, as usual, we see that the time cost of computing $\mathcal{B}(\Lambda_1^{j,T}, \epsilon_2) = \text{tr}\left(\rho_{B_j}^T |\psi\rangle \langle \psi|_{B_j \cup M_j \cup F_j} \rho_{B_j}^T\right) \pm \epsilon_2$ is at most $n\epsilon_2^{-2} 2^{O(D^2)w} = n\epsilon_2^{-2} 2^{O(d^2 T^2 K^4)30d}$ because the synthesis $\Lambda_1^{j,T}$ has depth $O(dTK^2)$, and width at most $30d$ (the width of the slice K_j) in the third dimension. The same depth and width bounds apply to the synthesis Z_j^{2T} , and so, the time cost of computing $\mathcal{B}(Z_j^{2T}, \epsilon_2) = \text{tr}\left(\rho_{B_j}^{2T}\right) \pm \epsilon_2$ is also bounded by $n\epsilon_2^{-2} 2^{O(d^2 T^2 K^4)30d}$. So, the total time cost of computing κ_{T, ϵ_2}^i according to Definition 25 is at most $2n\epsilon_2^{-2} 2^{O(d^2 T^2 K^4)30d} + \text{poly}(n)$. Since there are Δ distinct κ_{T, ϵ_2}^i values appearing in the **return** line of Algorithm 2, the total time $\zeta_2(n)$, for computing all of the κ_{T, ϵ_2}^i values, is $2\Delta n\epsilon_2^{-2} 2^{O(d^2 T^2 K^4)30d} + \Delta \text{poly}(n)$. We can now update our recursive time analysis for Algorithm 2 as follows:

$$T(\ell) < 2\Delta T \left(\frac{3}{4}\ell\right) + \delta^{-2} 2^{d^3 \text{polylog}(n)} + \zeta_2(n) + \mu(n)$$
(49)

$$= 2\Delta T \left(\frac{3}{4}\ell\right) + \delta^{-2} 2^{d^3 \text{polylog}(n)} + 2\Delta n\epsilon_2^{-2} 2^{O(d^2 T^2 K^4)30d} + \Delta \text{poly}(n) + \mu(n)$$
(50)

Recalling that, in Algorithm 2, we specify parameter scalings $\Delta = \log(n)$, $K = T = \log^3(n)$, $\epsilon_2 = \delta 2^{-10 \log(n) \log(\log(n))}$, this gives

$$T(\ell) < 2\Delta T \left(\frac{3}{4}\ell\right) + \delta^{-2} 2^{d^3 \text{polylog}(n)} + \delta^{-2} 2^{d^3 \text{polylog}(n)} + \mu(n)$$
(51)

$$= 2\Delta T \left(\frac{3}{4}\ell\right) + \delta^{-2} 2^{d^3 \text{polylog}(n)} + \text{poly}(n)$$
(52)

$$= 2\Delta T \left(\frac{3}{4}\ell\right) + \delta^{-2} 2^{d^3 \text{polylog}(n)}$$
(53)

Note that Equation 53 is a recursive run-time whereby, at each level, we have at most 2Δ subproblems, each with size at most $\frac{3}{4}$ of the original problem. This is a common formula, and we

can use the Master Theorem for divide-and-conquer algorithms to determine an upper bound for our run-time as

$$T(n^{1/3}) < (2\Delta)^\eta \cdot T\left(\left(\frac{3}{4}\right)^\eta n^{\frac{1}{3}}\right) + \sum_{i=0}^{\eta} (2\Delta)^i \delta^{-2} 2^{d^3 \text{polylog}(n)} \quad (54)$$

$$< (2\Delta)^\eta \cdot T\left(\left(\frac{3}{4}\right)^\eta n^{\frac{1}{3}}\right) + \frac{(2\Delta)^{\eta+1} - 1}{(2\Delta) - 1} \cdot \delta^{-2} 2^{d^3 \text{polylog}(n)} \quad (55)$$

$$< (2\Delta)^\eta \cdot T\left(\left(\frac{3}{4}\right)^\eta n^{\frac{1}{3}}\right) + (2\Delta)^{\eta+1} \cdot \delta^{-2} 2^{d^3 \text{polylog}(n)} \quad (56)$$

$$T(n^{1/3}) < (2\Delta)^\eta \left[T\left(\left(\frac{3}{4}\right)^\eta n^{\frac{1}{3}}\right) + 2\Delta \delta^{-2} 2^{d^3 \text{polylog}(n)} \right] \quad (57)$$

where η is the depth of our recursive calls. Note that the reason we start our recursion at $n^{1/3}$ instead of at n is because of the technical definition of $T(\ell)$. Recall that, we use $T(\ell)$ to denote the run-time bound for our algorithm on a synthesis with an N register of width ℓ . The starting point of our recursion is a cube of n qubits, which has side length $N^{1/3}$ in each dimension, and this is the reason that the total runtime for the original problem is bounded by $T(n^{1/3})$.

Theorem 33. *Suppose $\eta = \frac{\log(n)}{3 \log(4/3)}$ and $\Delta = \log n$. Given these values, the run-time for Algorithm 2 will be bounded by*

$$T(n) < \delta^{-2} 2^{d^3 \text{polylog}(n)} \quad (58)$$

Proof. Theorem 33 follows directly from the above calculations. □

Acknowledgments

MC thanks David Gosset and Sergey Bravyi for helpful discussions. Part of this work was completed while MC was attending the Simons Institute Quantum Wave in Computing workshop.

Appendices

A Proofs of Lemma Statements

A.1 Statements from Section 4

Lemma (Restatement of Lemma 11). *If $|\langle 0^{\otimes n} | C | 0^{\otimes n} \rangle| > |1/q(n)|$, then, for any $0 \leq h \leq 1$, $h|K|$ of the slices K_i in K have the property that:*

$$p_{total}(M_i = 0) \geq (|1/q(n)|)^{\frac{1}{(1-h)|K|}} \quad (59)$$

We will let K_{heavy} be the subset of K consisting of those K_i satisfying Equation (59).

Proof. Using 10 we have that:

$$p_{total}(M_i = 0 \forall i) = \prod_i p_{total}(M_i = 0) \geq |\langle 0^{\otimes n} | C | 0^{\otimes n} \rangle| > |1/q(n)| \quad (60)$$

So,

$$\log\left(\prod_i p_{total}(M_i = 0)\right) = \sum_i \log(p_{total}(M_i = 0)) \geq \log(|1/q(n)|) \quad (61)$$

Since every term on both sides of the equation is negative, it follows that at least $h|K|$ of the slices K_i in K must satisfy $\log(p_{total}(M_i = 0)) \geq \frac{1}{(1-h)|K|} \log(|1/q(n)|)$.

So, at least $h|K|$ of the slices K_i in K must satisfy

$$p_{total}(M_i = 0) \geq \exp\left\{\frac{1}{(1-h)|K|} \log(|1/q(n)|)\right\} = (|1/q(n)|)^{\frac{1}{(1-h)|K|}}$$

□

Lemma (Restatement of Lemma 13). *For any slice $K_i \in K_{heavy}$ satisfying:*

$$p_{total}(M_i = 0) \geq 1 - e(n), \quad (62)$$

the top Schmidt coefficient of $|\psi\rangle_{B_i \cup F_i}$ satisfies $\lambda_1^i \geq 1 - O(e(n))$. (Where the Schmidt decomposition is taken across the partition B_i, F_i .)

Proof. For any $K_i \in K_{heavy}$, recall that, by definition, the width of M_i is chosen large enough that B_i and F_i do not have any intersecting light cones (so the two halves of the circuit are lightcone separated). It follows that,

$$\begin{aligned} & \text{tr}_{M_i}(C_{B_i \cup M_i \cup F_i} | 0_{B_i \cup M_i \cup F_i}\rangle \langle 0_{B_i \cup M_i \cup F_i} | C_{B_i \cup M_i \cup F_i}^\dagger) = \\ & \text{tr}_{M_i \cup F_i}(C_{B_i \cup M_i \cup F_i} | 0_{B_i \cup M_i \cup F_i}\rangle \langle 0_{B_i \cup M_i \cup F_i} | C_{B_i \cup M_i \cup F_i}^\dagger) \otimes \text{tr}_{M_i \cup B_i}(C_{B_i \cup M_i \cup F_i} | 0_{B_i \cup M_i \cup F_i}\rangle \langle 0_{B_i \cup M_i \cup F_i} | C_{B_i \cup M_i \cup F_i}^\dagger) \end{aligned}$$

But, from Equation 62, which is an assumption of the Lemma, we see that,

$$\text{tr} \left(|0_{M_i}\rangle \langle 0_{M_i}| C_{B_i \cup M_i \cup F_i} |0_{B_i \cup M_i \cup F_i}\rangle \langle 0_{B_i \cup M_i \cup F_i}| C_{B_i \cup M_i \cup F_i}^\dagger |0_{M_i}\rangle \langle 0_{M_i}| \right) \quad (63)$$

$$= \text{tr} \left(|\psi\rangle \langle \psi|_{B_i \cup F_i} \right) = p_{total}(M_i = 0) \geq 1 - e(n), \quad (64)$$

and so,

$$\begin{aligned} & \left\| C_{B_i \cup M_i \cup F_i} |0_{B_i \cup M_i \cup F_i}\rangle \langle 0_{B_i \cup M_i \cup F_i}| C_{B_i \cup M_i \cup F_i}^\dagger \right. \\ & \left. - |0_{M_i}\rangle \langle 0_{M_i}| C_{B_i \cup M_i \cup F_i} |0_{B_i \cup M_i \cup F_i}\rangle \langle 0_{B_i \cup M_i \cup F_i}| C_{B_i \cup M_i \cup F_i}^\dagger |0_{M_i}\rangle \langle 0_{M_i}| \right\| \\ & \leq 1 - p_{total}(M_i = 0) \leq e(n) \end{aligned}$$

So,

$$\begin{aligned} |\psi\rangle \langle \psi|_{B_i \cup F_i} &= \text{tr}_{M_i} \left(|0_{M_i}\rangle \langle 0_{M_i}| C_{B_i \cup M_i \cup F_i} |0_{B_i \cup M_i \cup F_i}\rangle \langle 0_{B_i \cup M_i \cup F_i}| C_{B_i \cup M_i \cup F_i}^\dagger |0_{M_i}\rangle \langle 0_{M_i}| \right) \\ &= \text{tr}_{M_i} \left(C_{B_i \cup M_i \cup F_i} |0_{B_i \cup M_i \cup F_i}\rangle \langle 0_{B_i \cup M_i \cup F_i}| C_{B_i \cup M_i \cup F_i}^\dagger \right) + O(e(n)) \\ &= \text{tr}_{M_i \cup F_i} \left(C_{B_i \cup M_i \cup F_i} |0_{B_i \cup M_i \cup F_i}\rangle \langle 0_{B_i \cup M_i \cup F_i}| C_{B_i \cup M_i \cup F_i}^\dagger \right) \\ &\otimes \text{tr}_{M_i \cup B_i} \left(C_{B_i \cup M_i \cup F_i} |0_{B_i \cup M_i \cup F_i}\rangle \langle 0_{B_i \cup M_i \cup F_i}| C_{B_i \cup M_i \cup F_i}^\dagger \right) + O(e(n)) \\ &= \text{tr}_{M_i \cup F_i} \left(|0_{M_i}\rangle \langle 0_{M_i}| C_{B_i \cup M_i \cup F_i} |0_{B_i \cup M_i \cup F_i}\rangle \langle 0_{B_i \cup M_i \cup F_i}| C_{B_i \cup M_i \cup F_i}^\dagger |0_{M_i}\rangle \langle 0_{M_i}| \right) \\ &\otimes \text{tr}_{M_i \cup B_i} \left(|0_{M_i}\rangle \langle 0_{M_i}| C_{B_i \cup M_i \cup F_i} |0_{B_i \cup M_i \cup F_i}\rangle \langle 0_{B_i \cup M_i \cup F_i}| C_{B_i \cup M_i \cup F_i}^\dagger |0_{M_i}\rangle \langle 0_{M_i}| \right) + O(e(n)) \\ &= \text{tr}_{F_i} \left(|\psi\rangle \langle \psi|_{B_i \cup F_i} \right) \otimes \text{tr}_{B_i} \left(|\psi\rangle \langle \psi|_{B_i \cup F_i} \right) + O(e(n)) \end{aligned} \quad (65)$$

Now, by definition, the largest Schmidt coefficient λ_1^i of $|\psi\rangle_{B_i \cup F_i}$ is equal to the largest eigenvalue of the mixed state $\text{tr}_{F_i}(|\psi\rangle \langle \psi|_{B_i \cup F_i})$, which is equivalent to the largest eigenvalue of the mixed state $\text{tr}_{B_i}(|\psi\rangle \langle \psi|_{B_i \cup F_i})$ (since $|\psi\rangle \langle \psi|_{B_i \cup F_i}$ is an unnormalized pure state).

For notational brevity we define $\rho_{B_i} \equiv \text{tr}_{F_i}(|\psi\rangle \langle \psi|_{B_i \cup F_i})$ and $\rho_{F_i} \equiv \text{tr}_{B_i}(|\psi\rangle \langle \psi|_{B_i \cup F_i})$. By Holder's Inequality (with Holder parameters set to $p = 1$ and $q = \infty$) we have that:

$$\|\rho_{B_i}^2\|_1 \leq \|\rho_{B_i}\|_1 \|\rho_{B_i}\|_\infty = \|\rho_{B_i}\|_\infty = \lambda_1^i,$$

and,

$$\|\rho_{F_i}^2\|_1 \leq \|\rho_{F_i}\|_1 \|\rho_{F_i}\|_\infty = \|\rho_{F_i}\|_\infty = \lambda_1^i,$$

where the second to last inequality follows because $\|\rho_{B_i}\|_1 = \text{tr}(\rho_{B_i}) \leq 1$ (resp. $\|\rho_{F_i}\|_1 = \text{tr}(\rho_{F_i}) \leq 1$), and the last equality follows by the definition of λ_1^i . So, we have:

$$\begin{aligned} (\lambda_1^i)^2 &\geq \|\rho_{B_i}^2\|_1 \|\rho_{F_i}^2\|_1 = \text{tr}(\rho_{B_i}^2) \text{tr}(\rho_{F_i}^2) = \text{tr}(\rho_{B_i}^2 \otimes \rho_{F_i}^2) = \text{tr} \left((\rho_{B_i} \otimes \rho_{F_i})^2 \right) \\ &= \text{tr} \left(\left(|\psi\rangle \langle \psi|_{B_i \cup F_i} \right)^2 \right) + O(e(n)) \geq 1 - O(e(n)), \end{aligned} \quad (66)$$

Where the first three equalities follow by definition, the fourth equality follows by two uses of Equation 65 (and the fact that $\|\psi\rangle \langle \psi|_{B_i \cup F_i}\|_1 \leq 1$), and the final inequality follows by Equation 64. It follows that:

$$\lambda_1^i \geq 1 - O(e(n)) \quad (67)$$

□

Lemma (Restatement of Lemma 15). *For any $K_i \in K_{heavy}$,*

$$\|P_{F_i}^K - |w_1\rangle\langle w_1|_{F_i}\|_1 \leq g(n) \quad (68)$$

and

$$\|P_{B_i}^K - |v_1\rangle\langle v_1|_{B_i}\|_1 \leq g(n) \quad (69)$$

where $g(n) \equiv \left(\frac{1-\lambda_1^i}{\lambda_1^i}\right)^K$, and $|w_1\rangle\langle w_1|_{F_i}$, $|v_1\rangle\langle v_1|_{B_i}$ are the projectors onto the top Schmidt vectors of $|\psi\rangle_{B_i \cup F_i}$ in F_i and B_i respectively.

Proof. Here we will write the proof for Equation 68, but the proof for Equation 69 is exactly analogous. In particular, by Lemma 8 we have that:

For any constant integer $K > 0$, the following is a 2D-local circuit which gives a block encoding for $\rho_{F_i}^K$:

$$\prod_{j=1}^K (C_{B_i \cup M_i \cup F_i}^\dagger \otimes I_{F_i^1, \dots, F_i^K}) (I_{B_i \cup M_i} \otimes \text{SWAP}_{F_i F_i^j}) (C_{B_i \cup M_i \cup F_i} \otimes I_{F_i^1, \dots, F_i^K}).$$

It follows, by the definition of a block encoding, that,

$$\rho_{F_i}^K = \left\langle 0^{B_i, M_i, F_i^1, \dots, F_i^K} \left| \prod_{j=1}^K (C_{B_i \cup M_i \cup F_i}^\dagger \otimes I_{F_i^1, \dots, F_i^K}) (I_{B_i \cup M_i} \otimes \text{SWAP}_{F_i F_i^j}) (C_{B_i \cup M_i \cup F_i} \otimes I_{F_i^1, \dots, F_i^K}) \right| 0^{B_i, M_i, F_i^1, \dots, F_i^K} \right\rangle$$

Recall the definition of $P_{F_i}^K$:

$$P_{F_i}^K \equiv \frac{1}{(\lambda_1^i)^K} \left\langle 0^{B_i, M_i, F_i^1, \dots, F_i^K} \left| \prod_{j=1}^K (C_{B_i \cup M_i \cup F_i}^\dagger \otimes I_{F_i^1, \dots, F_i^K}) (I_{B_i \cup M_i} \otimes \text{SWAP}_{F_i F_i^j}) (C_{B_i \cup M_i \cup F_i} \otimes I_{F_i^1, \dots, F_i^K}) \right| 0^{B_i, M_i, F_i^1, \dots, F_i^K} \right\rangle.$$

And thus,

$$P_{F_i}^K = \frac{1}{(\lambda_1^i)^K} \rho_{F_i}^K = \left(\frac{\rho_{F_i}}{\lambda_1^i} \right)^K.$$

By the definition of λ_1^i and the leading Schmidt coefficient we have that:

$$\frac{\rho_{F_i}}{\lambda_1^i} = |w_1\rangle\langle w_1|_{F_i} + E,$$

where $E \equiv \left(\frac{\rho_{F_i}}{\lambda_1^i} - |w_1\rangle\langle w_1|_{F_i}\right)$ is a PSD operator with trace norm $\|E\| \leq \frac{1-\lambda_1^i}{\lambda_1^i}$, and which is orthogonal to $|w_1\rangle\langle w_1|_{F_i}$ (i.e. $|w_1\rangle\langle w_1|_{F_i} \cdot E = 0$). It follows that:

$$\left(\frac{\rho_{F_i}}{\lambda_1^i}\right)^K = (|w_1\rangle \langle w_1|_{F_i} + E)^K = (|w_1\rangle \langle w_1|_{F_i})^K + E^K. \quad (70)$$

So,

$$\left\| P_{F_i}^K - |w_1\rangle \langle w_1|_{F_i} \right\| = \left\| \left(\frac{\rho_{F_i}}{\lambda_1^i}\right)^K - |w_1\rangle \langle w_1|_{F_i} \right\| = \|E^K\| = \|E\|^K \leq \left(\frac{1 - \lambda_1^i}{\lambda_1^i}\right)^K \quad (71)$$

□

Lemma (Restatement of Lemma 18). *Consider a set K_{heavy} of slices such that, for every $K_i \in K_{heavy}$, $|\psi\rangle_{B_i \cup F_i}$ satisfies $\lambda_1^i \geq 1 - e(n)$, and such that for any $K_i, K_j \in K_{heavy}$, the operators $\Pi_{F_i}^K$ and $\Pi_{F_j}^K$ are light-cone separated whenever $i \neq j$. Then, for any set of Δ slices, $\{K_i\}_{i \in [\Delta]} \subseteq K_{heavy}$, we have that:*

$$\left\| \sum_{\sigma \in \mathcal{P}([\Delta])} (-1)^{|\sigma|} |\Psi_\sigma\rangle \langle \Psi_\sigma| \right\| = \left\| |\Psi_\emptyset\rangle \langle \Psi_\emptyset| - \sum_{\sigma \in \mathcal{P}([\Delta]) \setminus \emptyset} (-1)^{|\sigma|+1} |\Psi_\sigma\rangle \langle \Psi_\sigma| \right\| \leq (2e(n) + 2g(n))^\Delta, \quad (72)$$

where $g(n) \equiv \left(\frac{1 - \lambda_1^i}{\lambda_1^i}\right)^K$.

Proof. For the following, we use the shorthand $\rho_M(U)$ for the density matrix of the state prepared by linear operator U acting on the all 0 state of the M register. For instance, $\rho_{ALL}(U) = U |0_{ALL}\rangle \langle 0_{ALL}| U^\dagger$. Note that $\rho_M(VU) = V\rho_M(U)V^\dagger$.

Following the definition of $|\Psi_\sigma\rangle$ in Definition 17, we are trying to upper bound the quantity

$$\left\| \sum_{\sigma \in \mathcal{P}([\Delta])} (-1)^{|\sigma|} |\Psi_\sigma\rangle \langle \Psi_\sigma| \right\| = \left\| \sum_{\sigma \in \mathcal{P}([\Delta])} (-1)^{|\sigma|} \rho_{ALL} \left((\otimes_{j \in \sigma} \Pi_{F_j}^K) (\otimes_{i \in [\Delta]} \langle 0_{M_i} |) C \right) \right\|. \quad (73)$$

The proof proceeds in three parts. First, we consider Equation 73 without the post-selection on $\otimes_{i \in [\Delta]} \langle 0_{M_i} |$, and give an equivalent formulation in terms of a product of similar quantities. Second, we show this formulation holds under the post-selection. And lastly, we bound each term in this product formulation.

From the definition of C we have

$$\left\| \sum_{\sigma \in \mathcal{P}([\Delta])} (-1)^{|\sigma|} \rho_{ALL} \left((\otimes_{j \in \sigma} \Pi_{F_j}^K) C \right) \right\| = \quad (74)$$

$$\left\| \sum_{\sigma \in \mathcal{P}([\Delta])} (-1)^{|\sigma|} \rho_{ALL} \left((\otimes_{j \in \sigma} \Pi_{F_j}^K) (C_{L, \sigma_1} \circ \otimes_{j \in [|\sigma|-1]} C_{\sigma_j, \sigma_{j+1}} \circ C_{\sigma_{|\sigma|}, R} \circ \otimes_{j \in [|\sigma|]} C_{B_{\sigma_j} \cup M_{\sigma_j} \cup F_{\sigma_j}}) \right) \right\|, \quad (75)$$

and by the definitions of $\Pi_{F_j}^K$ and C_{wrap_i} we have

$$= \left\| \sum_{\sigma \in \mathcal{P}([\Delta])} (-1)^{|\sigma|} \rho_{ALL} \left(C_{L, \sigma_1} \circ \otimes_{j \in [|\sigma|-1]} C_{\sigma_j, \sigma_{j+1}} \circ C_{\sigma_{|\sigma|}, R} \circ \otimes_{j \in [|\sigma|]} P_{F_j}^K C_{B_{\sigma_j} \cup M_{\sigma_j} \cup F_{\sigma_j}} \right) \right\|. \quad (76)$$

We can rewrite this by expanding the summation and regrouping terms in tensor product

$$= \left\| (C_{L,1} \circ \otimes_{j \in [\Delta-1]} C_{\sigma_j, \sigma_{j+1}} \circ C_{\sigma_{\Delta}, R}) \circ \otimes_{j \in [\Delta]} \left(\rho_{B_j \cup M_j \cup F_j} (C_{B_j \cup M_j \cup F_j}) - \rho_{B_j \cup M_j \cup F_j} (P_{F_j}^K C_{B_j \cup M_j \cup F_j}) \right) \right\| \quad (77)$$

$$\otimes \rho_{ALL \setminus \cup_{j \in [\Delta]} B_j \cup M_j \cup F_j} (I) \circ (C_{L,1} \circ \otimes_{j \in [\Delta-1]} C_{\sigma_j, \sigma_{j+1}} \circ C_{\sigma_{\Delta}, R})^\dagger \left\| \right. \quad (78)$$

Lastly, by standard properties of the trace norm and noting that $C_{L,1} \circ \otimes_{j \in [\Delta-1]} C_{\sigma_j, \sigma_{j+1}} \circ C_{\sigma_{\Delta}, R}$ is a unitary operator, we have

$$\left\| \sum_{\sigma \in \mathcal{P}([\Delta])} (-1)^{|\sigma|} \rho_{ALL} \left(\left(\otimes_{j \in \sigma} \Pi_{F_j}^K \right) C \right) \right\| = \prod_{j \in [\Delta]} \left\| \rho_{B_j \cup M_j \cup F_j} (C_{B_j \cup M_j \cup F_j}) - \rho_{B_j \cup M_j \cup F_j} (P_{F_j}^K C_{B_j \cup M_j \cup F_j}) \right\|. \quad (79)$$

Now, since the terms $\otimes_{i \in [\Delta]} |0_{M_i}\rangle$, $\otimes_{i \in [\Delta]} \langle 0_{M_i}|$ commute with the terms $\otimes_{j \in \sigma} \Pi_{F_j}^K$, $P_{F_j}^K$ for all i, j , and σ , the form of Equation 79 holds even under post-selection:

$$\left\| \sum_{\sigma \in \mathcal{P}([\Delta])} (-1)^{|\sigma|} \rho_{ALL} \left(\left(\otimes_{j \in \sigma} \Pi_{F_j}^K \langle 0_{M_j} | \right) C \right) \right\| = \prod_{j \in [\Delta]} \left\| \rho_{B_j \cup M_j \cup F_j} \left(\langle 0_{M_j} | C_{B_j \cup M_j \cup F_j} \right) - \rho_{B_j \cup M_j \cup F_j} \left(P_{F_j}^K \langle 0_{M_j} | C_{B_j \cup M_j \cup F_j} \right) \right\|. \quad (80)$$

We now bound each term of this product. By adding and subtracting $\rho_{B_j \cup M_j \cup F_j} (|w_1\rangle \langle w_1|_{F_j} \langle 0_{M_j} | C_{B_j \cup M_j \cup F_j})$ (where $|w_1\rangle \langle w_1|_{F_j}$ is the projector onto the top Schmidt vector of $|\Psi\rangle_{B_j \cup F_j}$) and using the triangle inequality we have

$$\left\| \rho_{B_j \cup M_j \cup F_j} \left(\langle 0_{M_j} | C_{B_j \cup M_j \cup F_j} \right) - \rho_{B_j \cup M_j \cup F_j} \left(P_{F_j}^K \langle 0_{M_j} | C_{B_j \cup M_j \cup F_j} \right) \right\| \leq \quad (81)$$

$$\left\| \rho_{B_j \cup M_j \cup F_j} \left(\langle 0_{M_j} | C_{B_j \cup M_j \cup F_j} \right) - \rho_{B_j \cup M_j \cup F_j} \left(|w_1\rangle \langle w_1|_{F_j} \langle 0_{M_j} | C_{B_j \cup M_j \cup F_j} \right) \right\| + \left\| \rho_{B_j \cup M_j \cup F_j} \left(|w_1\rangle \langle w_1|_{F_j} \langle 0_{M_j} | C_{B_j \cup M_j \cup F_j} \right) - \rho_{B_j \cup M_j \cup F_j} \left(P_{F_j}^K \langle 0_{M_j} | C_{B_j \cup M_j \cup F_j} \right) \right\|. \quad (82)$$

By using Lemma 15 (twice) we can bound the right summand by $2g(n) \equiv 2 \left(\frac{1-\lambda_1^i}{\lambda_1^i} \right)^K$. By assumption in the lemma statement we have that the top Schmidt coefficient of $|\psi\rangle_{B_j \cup F_j}$ satisfies $\lambda_1^j \geq 1 - e(n)$ (for every j), and so (applying this bound twice) the left summand is bounded by $2e(n)$. Thus, we have

$$\left\| \rho_{B_j \cup M_j \cup F_j} \left(\langle 0_{M_j} | C_{B_j \cup M_j \cup F_j} \right) - \rho_{B_j \cup M_j \cup F_j} \left(P_{F_j}^K \langle 0_{M_j} | C_{B_j \cup M_j \cup F_j} \right) \right\| \leq 2(e) + 2f(n). \quad (83)$$

Combining Equations 80 with Equation 83 we have the desired

$$\left\| \sum_{\sigma \in \mathcal{P}([\Delta])} (-1)^{|\sigma|} \rho_{ALL} \left(\left(\otimes_{j \in \sigma} \Pi_{F_j}^K \langle 0_{M_j} | \right) C \right) \right\| \leq \prod_{j \in [\Delta]} (2(e) + 2g(n)) = (2(e) + 2g(n))^\Delta. \quad (84)$$

□

Lemma (Restatement of Lemma 20). *For any $K_i \in K_{heavy}$ (recall this means that $|\psi\rangle_{B_i \cup F_i}$ satisfies $\lambda_1^i \geq 1 - e(n)$), the state $|\Omega_i\rangle \langle \Omega_i|$ is within $6g(n)$ of an unnormalized product state about M_i , described as follows:*

$$\left\| |\Omega_i\rangle \langle \Omega_i| - 1/\lambda_1^i \text{tr}_{F_i} (|\Xi_{L_i}\rangle \langle \Xi_{L_i}|) \otimes \text{tr}_{B_i} (|\Xi_{R_i}\rangle \langle \Xi_{R_i}|) \right\| \leq 6g(n) \quad (85)$$

Here $g(n) \equiv \left(\frac{1-\lambda_1^i}{\lambda_1^i}\right)^K \leq \left(\frac{e(n)}{1-e(n)}\right)^K$ just as in Lemma 15. Recall the definitions:

$$\begin{aligned} |\Omega_i\rangle &\equiv \Pi_{F_i}^K \langle 0_{M_i} | C | 0_{ALL} \rangle \\ |\Xi_{L_i}\rangle &\equiv P_{F_i}^K \langle 0_{M_i} | C_{L_i} C_{B_i \cup M_i \cup F_i} | 0_{L_i \cup B_i \cup M_i \cup F_i} \rangle \\ |\Xi_{R_i}\rangle &\equiv P_{B_i}^K \langle 0_{M_i} | C_{R_i} C_{B_i \cup M_i \cup F_i} | 0_{R_i \cup B_i \cup M_i \cup F_i} \rangle \end{aligned}$$

Proof. The proof proceeds in two parts. First, we demonstrate that the quantity

$$|\Omega_i\rangle \langle \Omega_i| - 1/\lambda_1^i \text{tr}_{F_i} (|\Xi_{L_i}\rangle \langle \Xi_{L_i}|) \otimes \text{tr}_{B_i} (|\Xi_{R_i}\rangle \langle \Xi_{R_i}|)$$

is equal to the sum of three error terms, E , H_1 , and H_2 . We then bound the trace norm of each of these quantities using applications of Lemma 15. By definition of $|\Omega_i\rangle$ we have

$$|\Omega_i\rangle \langle \Omega_i| = \Pi_{F_i}^K \langle 0_{M_i} | C | 0_{ALL} \rangle \langle 0_{ALL} | C^\dagger | 0_{M_i} \rangle \Pi_{F_i}^K. \quad (86)$$

Now, recall by Definition 16, $\Pi_{F_i}^K \equiv C_{Wrap_i} P_{F_i}^K C_{Wrap_i}^\dagger$. So,

$$\begin{aligned} \Pi_{F_i}^K \langle 0_{M_i} | C | 0_{ALL} \rangle \langle 0_{ALL} | C^\dagger | 0_{M_i} \rangle \Pi_{F_i}^K &= \langle 0_{M_i} | \Pi_{F_i}^K C | 0_{ALL} \rangle \langle 0_{ALL} | C^\dagger \Pi_{F_i}^K | 0_{M_i} \rangle \\ &= \langle 0_{M_i} | C_{Wrap_i} P_{F_i}^K C_{Wrap_i}^\dagger C | 0_{ALL} \rangle \langle 0_{ALL} | C^\dagger C_{Wrap_i} P_{F_i}^K C_{Wrap_i}^\dagger | 0_{M_i} \rangle \\ &= \langle 0_{M_i} | C_{Wrap_i} \circ P_{F_i}^K \circ C'_{L_i} \circ C_{B_i \cup M_i \cup F_i} \circ C'_{R_i} | 0_{ALL} \rangle \langle 0_{ALL} | (C')_{L_i}^\dagger \circ C_{B_i \cup M_i \cup F_i}^\dagger \circ (C')_{R_i}^\dagger \circ P_{F_i}^K \circ C_{Wrap_i}^\dagger | 0_{M_i} \rangle \\ &= C_{Wrap_i} P_{F_i}^K \left(\langle 0_{M_i} | \circ C'_{L_i} \circ C_{B_i \cup M_i \cup F_i} \circ C'_{R_i} | 0_{ALL} \rangle \langle 0_{ALL} | (C')_{L_i}^\dagger \circ C_{B_i \cup M_i \cup F_i}^\dagger \circ (C')_{R_i}^\dagger | 0_{M_i} \rangle \right) P_{F_i}^K C_{Wrap_i}^\dagger \\ &= C_{Wrap_i} P_{F_i}^K \left(C'_{L_i} | 0_{L_i} \rangle \langle 0_{L_i} | (C')_{L_i}^\dagger \otimes \langle 0_{M_i} | C_{B_i \cup M_i \cup F_i} | 0_{B_i \cup M_i \cup F_i} \rangle \langle 0_{B_i \cup M_i \cup F_i} | C_{B_i \cup M_i \cup F_i}^\dagger | 0_{M_i} \rangle \right. \\ &\quad \left. \otimes C'_{R_i} | 0_{R_i} \rangle \langle 0_{R_i} | (C')_{R_i}^\dagger \right) P_{F_i}^K C_{Wrap_i}^\dagger \\ &= C_{Wrap_i} P_{F_i}^K \left(C'_{L_i} | 0_{L_i} \rangle \langle 0_{L_i} | (C')_{L_i}^\dagger \otimes |\psi\rangle \langle \psi|_{B_i \cup F_i} \otimes C'_{R_i} | 0_{R_i} \rangle \langle 0_{R_i} | (C')_{R_i}^\dagger \right) P_{F_i}^K C_{Wrap_i}^\dagger \\ &= C_{Wrap_i} \left(C'_{L_i} | 0_{L_i} \rangle \langle 0_{L_i} | (C')_{L_i}^\dagger \otimes P_{F_i}^K |\psi\rangle \langle \psi|_{B_i \cup F_i} P_{F_i}^K \otimes C'_{R_i} | 0_{R_i} \rangle \langle 0_{R_i} | (C')_{R_i}^\dagger \right) C_{Wrap_i}^\dagger \end{aligned} \quad (87)$$

Here the first equality holds because the $\Pi_{F_i}^K$ operators only act on register F_i , which is disjoint from register M_i . The second equality holds by the definition of $\Pi_{F_i}^K$, see Definition 16. The third equality holds by Equation 2, repeated below for the convenience of the reader.

$$C_{Wrap_i}^\dagger \circ C = C'_{L_i} \circ C_{B_i \cup M_i \cup F_i} \circ C'_{R_i}$$

The fourth equality holds because neither the operator C_{Wrap_i} , nor the operator $P_{F_i}^K$ act (non-trivially) on the register M_i . The fifth equality holds because the operators C'_{L_i} , C'_{R_i} , and $C_{B_i \cup M_i \cup F_i}$ all act on disjoint registers and are therefore in tensor product by definition. The sixth equality holds by the definition of $|\psi\rangle_{B_i \cup F_i}$. The seventh equality follows because $P_{F_i}^K$ only acts (non-trivially) on the register F_i , by definition.

Now, define:

$$\begin{aligned}
E &\equiv C_{Wrap_i} \left(C'_{L_i} |0_{L_i}\rangle \langle 0_{L_i}| (C')_{L_i}^\dagger \otimes |w_1\rangle \langle w_1|_{F_i} |\psi\rangle \langle \psi|_{B_i \cup F_i} |w_1\rangle \langle w_1|_{F_i} \otimes C'_{R_i} |0_{R_i}\rangle \langle 0_{R_i}| (C')_{R_i}^\dagger \right) C_{Wrap_i}^\dagger \\
&- C_{Wrap_i} \left(C'_{L_i} |0_{L_i}\rangle \langle 0_{L_i}| (C')_{L_i}^\dagger \otimes P_{F_i}^K |\psi\rangle \langle \psi|_{B_i \cup F_i} P_{F_i}^K \otimes C'_{R_i} |0_{R_i}\rangle \langle 0_{R_i}| (C')_{R_i}^\dagger \right) C_{Wrap_i}^\dagger \\
&= C_{Wrap_i} \left(C'_{L_i} |0_{L_i}\rangle \langle 0_{L_i}| (C')_{L_i}^\dagger \otimes \left(|w_1\rangle \langle w_1|_{F_i} |\psi\rangle \langle \psi|_{B_i \cup F_i} |w_1\rangle \langle w_1|_{F_i} - P_{F_i}^K |\psi\rangle \langle \psi|_{B_i \cup F_i} P_{F_i}^K \right) \right. \\
&\quad \left. \otimes C'_{R_i} |0_{R_i}\rangle \langle 0_{R_i}| (C')_{R_i}^\dagger \right) C_{Wrap_i}^\dagger \tag{88}
\end{aligned}$$

This error term quantifies the difference between using our block-encoding construction $P_{F_i}^K$ versus using the true projector onto the top Schmidt vector, $|w_1\rangle \langle w_1|_{F_i}$, which is $P_{F_i}^K$ is meant to approximate. We will show below, using Lemma 15, that the trace norm of E is small. We have, from Equation 87, that:

$$\begin{aligned}
&\Pi_{F_i}^K \langle 0_{M_i} | C | 0_{ALL} \rangle \langle 0_{ALL} | C^\dagger | 0_{M_i} \rangle \Pi_{F_i}^K \\
&= C_{Wrap_i} \left(C'_{L_i} |0_{L_i}\rangle \langle 0_{L_i}| (C')_{L_i}^\dagger \otimes P_{F_i}^K |\psi\rangle \langle \psi|_{B_i \cup F_i} P_{F_i}^K \otimes C'_{R_i} |0_{R_i}\rangle \langle 0_{R_i}| (C')_{R_i}^\dagger \right) C_{Wrap_i}^\dagger \\
&= C_{Wrap_i} \left(C'_{L_i} |0_{L_i}\rangle \langle 0_{L_i}| (C')_{L_i}^\dagger \otimes |w_1\rangle \langle w_1|_{F_i} |\psi\rangle \langle \psi|_{B_i \cup F_i} |w_1\rangle \langle w_1|_{F_i} \otimes C'_{R_i} |0_{R_i}\rangle \langle 0_{R_i}| (C')_{R_i}^\dagger \right) C_{Wrap_i}^\dagger + E \\
&= C_{Wrap_i} \left(C'_{L_i} |0_{L_i}\rangle \langle 0_{L_i}| (C')_{L_i}^\dagger \otimes \left(\lambda_1^i |v_1\rangle_{B_i} |w_1\rangle_{F_i} \langle v_1|_{B_i} \langle w_1|_{F_i} \right) \otimes C'_{R_i} |0_{R_i}\rangle \langle 0_{R_i}| (C')_{R_i}^\dagger \right) C_{Wrap_i}^\dagger + E \\
&= \lambda_1^i C_{Wrap_i} \left(C'_{L_i} |0_{L_i}\rangle \langle 0_{L_i}| (C')_{L_i}^\dagger \otimes \left(|v_1\rangle \langle v_1|_{B_i} \otimes |w_1\rangle \langle w_1|_{F_i} \right) \otimes C'_{R_i} |0_{R_i}\rangle \langle 0_{R_i}| (C')_{R_i}^\dagger \right) C_{Wrap_i}^\dagger + E \\
&= \lambda_1^i C_{L-Wrap_i} \left(C'_{L_i} |0_{L_i}\rangle \langle 0_{L_i}| (C')_{L_i}^\dagger \otimes |v_1\rangle \langle v_1|_{B_i} \right) C_{L-Wrap_i}^\dagger \\
&\quad \otimes C_{R-Wrap_i} \left(|w_1\rangle \langle w_1|_{F_i} \otimes C'_{R_i} |0_{R_i}\rangle \langle 0_{R_i}| (C')_{R_i}^\dagger \right) C_{R-Wrap_i}^\dagger + E \\
&= \lambda_1^i C_{L-Wrap_i} \text{tr}_{F_i} \left(C'_{L_i} |0_{L_i}\rangle \langle 0_{L_i}| (C')_{L_i}^\dagger \otimes |v_1\rangle \langle v_1|_{B_i} \otimes |w_1\rangle \langle w_1|_{F_i} \right) C_{L-Wrap_i}^\dagger \\
&\quad \otimes C_{R-Wrap_i} \text{tr}_{B_i} \left(|v_1\rangle \langle v_1|_{B_i} \otimes |w_1\rangle \langle w_1|_{F_i} \otimes C'_{R_i} |0_{R_i}\rangle \langle 0_{R_i}| (C')_{R_i}^\dagger \right) C_{R-Wrap_i}^\dagger + E \tag{89}
\end{aligned}$$

Now that we have successfully approximated the starting state by a product state (plus an error term E) we want to switch back from the true Schmidt vector projectors $|v_1\rangle \langle v_1|_{B_i}$, $|w_1\rangle \langle w_1|_{F_i}$, to the original block encoding approximations of those projectors $P_{B_i}^K, P_{F_i}^K$, in order to complete the proof. To do this we define two new error terms H_1 , and H_2 as follows:

$$\begin{aligned}
H_1 &\equiv \lambda_1^i C_{L-Wrap_i} \text{tr}_{F_i} \left(C'_{L_i} |0_{L_i}\rangle \langle 0_{L_i}| (C')_{L_i}^\dagger \otimes |v_1\rangle \langle v_1|_{B_i} \otimes |w_1\rangle \langle w_1|_{F_i} \right) C_{L-Wrap_i}^\dagger \\
&\quad \otimes C_{R-Wrap_i} \text{tr}_{B_i} \left(|v_1\rangle \langle v_1|_{B_i} \otimes |w_1\rangle \langle w_1|_{F_i} \otimes C'_{R_i} |0_{R_i}\rangle \langle 0_{R_i}| (C')_{R_i}^\dagger \right) C_{R-Wrap_i}^\dagger \\
&\quad - C_{L-Wrap_i} \text{tr}_{F_i} \left(C'_{L_i} |0_{L_i}\rangle \langle 0_{L_i}| (C')_{L_i}^\dagger \otimes P_{F_i}^K |\psi\rangle \langle \psi|_{B_i \cup F_i} P_{F_i}^K \right) C_{L-Wrap_i}^\dagger \\
&\quad \otimes C_{R-Wrap_i} \text{tr}_{B_i} \left(|v_1\rangle \langle v_1|_{B_i} \otimes |w_1\rangle \langle w_1|_{F_i} \otimes C'_{R_i} |0_{R_i}\rangle \langle 0_{R_i}| (C')_{R_i}^\dagger \right) C_{R-Wrap_i}^\dagger \tag{90}
\end{aligned}$$

and

$$\begin{aligned}
H_2 &= C_{L-Wrap_i} \text{tr}_{F_i} \left(C'_{L_i} |0_{L_i}\rangle \langle 0_{L_i}| (C')_{L_i}^\dagger \otimes P_{F_i}^K |\psi\rangle \langle \psi|_{B_i \cup F_i} P_{F_i}^K \right) C_{L-Wrap_i}^\dagger \\
&\otimes C_{R-Wrap_i} \text{tr}_{B_i} \left(|v_1\rangle \langle v_1|_{B_i} \otimes |w_1\rangle \langle w_1|_{F_i} \otimes C'_{R_i} |0_{R_i}\rangle \langle 0_{R_i}| (C')_{R_i}^\dagger \right) C_{R-Wrap_i}^\dagger \\
&- 1/\lambda_1^i C_{L-Wrap_i} \text{tr}_{F_i} \left(C'_{L_i} |0_{L_i}\rangle \langle 0_{L_i}| (C')_{L_i}^\dagger \otimes P_{F_i}^K |\psi\rangle \langle \psi|_{B_i \cup F_i} P_{F_i}^K \right) C_{L-Wrap_i}^\dagger \\
&\otimes C_{R-Wrap_i} \text{tr}_{B_i} \left(P_{B_i}^K |\psi\rangle \langle \psi|_{B_i \cup F_i} P_{B_i}^K \otimes C'_{R_i} |0_{R_i}\rangle \langle 0_{R_i}| (C')_{R_i}^\dagger \right) C_{R-Wrap_i}^\dagger
\end{aligned} \tag{91}$$

(we will later show that both error terms H_1 and H_2 are small in the trace norm) it follows from Equation 89 that:

$$\begin{aligned}
&\Pi_{F_i}^K \langle 0_{M_i} | C | 0_{ALL} \rangle \langle 0_{ALL} | C^\dagger | 0_{M_i} \rangle \Pi_{F_i}^K \\
&= \lambda_1^i C_{L-Wrap_i} \text{tr}_{F_i} \left(C'_{L_i} |0_{L_i}\rangle \langle 0_{L_i}| (C')_{L_i}^\dagger \otimes |v_1\rangle \langle v_1|_{B_i} \otimes |w_1\rangle \langle w_1|_{F_i} \right) C_{L-Wrap_i}^\dagger \\
&\otimes C_{R-Wrap_i} \text{tr}_{B_i} \left(|v_1\rangle \langle v_1|_{B_i} \otimes |w_1\rangle \langle w_1|_{F_i} \otimes C'_{R_i} |0_{R_i}\rangle \langle 0_{R_i}| (C')_{R_i}^\dagger \right) C_{R-Wrap_i}^\dagger + E \\
&= C_{L-Wrap_i} \text{tr}_{F_i} \left(C'_{L_i} |0_{L_i}\rangle \langle 0_{L_i}| (C')_{L_i}^\dagger \otimes P_{F_i}^K |\psi\rangle \langle \psi|_{B_i \cup F_i} P_{F_i}^K \right) C_{L-Wrap_i}^\dagger \\
&\otimes C_{R-Wrap_i} \text{tr}_{B_i} \left(|v_1\rangle \langle v_1|_{B_i} \otimes |w_1\rangle \langle w_1|_{F_i} \otimes C'_{R_i} |0_{R_i}\rangle \langle 0_{R_i}| (C')_{R_i}^\dagger \right) C_{R-Wrap_i}^\dagger + E + H_1 \\
&= 1/\lambda_1^i C_{L-Wrap_i} \text{tr}_{F_i} \left(C'_{L_i} |0_{L_i}\rangle \langle 0_{L_i}| (C')_{L_i}^\dagger \otimes P_{F_i}^K |\psi\rangle \langle \psi|_{B_i \cup F_i} P_{F_i}^K \right) C_{L-Wrap_i}^\dagger \\
&\otimes C_{R-Wrap_i} \text{tr}_{B_i} \left(P_{B_i}^K |\psi\rangle \langle \psi|_{B_i \cup F_i} P_{B_i}^K \otimes C'_{R_i} |0_{R_i}\rangle \langle 0_{R_i}| (C')_{R_i}^\dagger \right) C_{R-Wrap_i}^\dagger + E + H_1 + H_2 \\
&= 1/\lambda_1^i \text{tr}_{F_i} \left(P_{F_i}^K C_{L-Wrap_i} \left(C'_{L_i} |0_{L_i}\rangle \langle 0_{L_i}| (C')_{L_i}^\dagger \otimes |\psi\rangle \langle \psi|_{B_i \cup F_i} \right) C_{L-Wrap_i}^\dagger P_{F_i}^K \right) \\
&\otimes \text{tr}_{B_i} \left(P_{B_i}^K C_{R-Wrap_i} \left(|\psi\rangle \langle \psi|_{B_i \cup F_i} \otimes C'_{R_i} |0_{R_i}\rangle \langle 0_{R_i}| (C')_{R_i}^\dagger \right) C_{R-Wrap_i}^\dagger P_{B_i}^K \right) + E + H_1 + H_2 \\
&= 1/\lambda_1^i \text{tr}_{F_i} \left(P_{F_i}^K \langle 0_{M_i} | C_{L_i} C_{B_i \cup M_i \cup F_i} | 0_{L_i \cup B_i \cup M_i \cup F_i} \rangle \langle 0_{L_i \cup B_i \cup M_i \cup F_i} | C_{B_i \cup M_i \cup F_i}^\dagger C_{L_i}^\dagger | 0_{M_i} \rangle P_{F_i}^K \right) \\
&\otimes \text{tr}_{B_i} \left(P_{B_i}^K \langle 0_{M_i} | C_{R_i} C_{B_i \cup M_i \cup F_i} | 0_{R_i \cup B_i \cup M_i \cup F_i} \rangle \langle 0_{R_i \cup B_i \cup M_i \cup F_i} | C_{B_i \cup M_i \cup F_i}^\dagger C_{R_i}^\dagger | 0_{M_i} \rangle P_{B_i}^K \right) + E + H_1 + H_2 \\
&= 1/\lambda_1^i \text{tr}_{F_i} (|\Xi_{L_i}\rangle \langle \Xi_{L_i}|) \otimes \text{tr}_{B_i} (|\Xi_{R_i}\rangle \langle \Xi_{R_i}|) + E + H_1 + H_2
\end{aligned}$$

It follows, by triangle inequality, that:

$$\begin{aligned}
&\left\| \Pi_{F_i}^K \langle 0_{M_i} | C | 0_{ALL} \rangle \langle 0_{ALL} | C^\dagger | 0_{M_i} \rangle \Pi_{F_i}^K \right. \\
&\quad \left. - 1/\lambda_1^i \text{tr}_{F_i} \left(P_{F_i}^K \langle 0_{M_i} | C_{L_i} C_{B_i \cup M_i \cup F_i} | 0_{L_i \cup B_i \cup M_i \cup F_i} \rangle \langle 0_{L_i \cup B_i \cup M_i \cup F_i} | C_{B_i \cup M_i \cup F_i}^\dagger C_{L_i}^\dagger | 0_{M_i} \rangle P_{F_i}^K \right) \right. \\
&\quad \left. \otimes \text{tr}_{B_i} \left(P_{B_i}^K \langle 0_{M_i} | C_{R_i} C_{B_i \cup M_i \cup F_i} | 0_{R_i \cup B_i \cup M_i \cup F_i} \rangle \langle 0_{R_i \cup B_i \cup M_i \cup F_i} | C_{B_i \cup M_i \cup F_i}^\dagger C_{R_i}^\dagger | 0_{M_i} \rangle P_{B_i}^K \right) \right\|
\end{aligned} \tag{92}$$

$$= \left\| |\Omega_i\rangle \langle \Omega_i| - 1/\lambda_1^i \text{tr}_{F_i} (|\Xi_{L_i}\rangle \langle \Xi_{L_i}|) \otimes \text{tr}_{B_i} (|\Xi_{R_i}\rangle \langle \Xi_{R_i}|) \right\| \tag{93}$$

$$= \|E + H_1 + H_2\| \leq \|E\| + \|H_1\| + \|H_2\| \tag{94}$$

It remains to bound the norms (in this case the trace norm) of E, H_1, H_2 . We will start with E : From the definition of E (Equation 88) we see that:

$$\begin{aligned}
\|E\| &= \left\| C_{Wrap_i} \left(C'_{L_i} |0_{L_i}\rangle \langle 0_{L_i}| (C')_{L_i}^\dagger \otimes \left(|w_1\rangle \langle w_1|_{F_i} |\psi\rangle \langle \psi|_{B_i \cup F_i} |w_1\rangle \langle w_1|_{F_i} - P_{F_i}^K |\psi\rangle \langle \psi|_{B_i \cup F_i} P_{F_i}^K \right) \right. \right. \\
&\quad \left. \left. \otimes C'_{R_i} |0_{R_i}\rangle \langle 0_{R_i}| (C')_{R_i}^\dagger \right) C_{Wrap_i}^\dagger \right\| \\
&= \|C'_{L_i} |0_{L_i}\rangle \langle 0_{L_i}| (C')_{L_i}^\dagger\| \cdot \| |w_1\rangle \langle w_1|_{F_i} |\psi\rangle \langle \psi|_{B_i \cup F_i} |w_1\rangle \langle w_1|_{F_i} - P_{F_i}^K |\psi\rangle \langle \psi|_{B_i \cup F_i} P_{F_i}^K \| \\
&\quad \cdot \|C'_{R_i} |0_{R_i}\rangle \langle 0_{R_i}| (C')_{R_i}^\dagger\| \\
&= \| |0_{L_i}\rangle \langle 0_{L_i}| \| \cdot \| |w_1\rangle \langle w_1|_{F_i} |\psi\rangle \langle \psi|_{B_i \cup F_i} |w_1\rangle \langle w_1|_{F_i} - P_{F_i}^K |\psi\rangle \langle \psi|_{B_i \cup F_i} P_{F_i}^K \| \cdot \| |0_{R_i}\rangle \langle 0_{R_i}| \| \\
&= \| |w_1\rangle \langle w_1|_{F_i} |\psi\rangle \langle \psi|_{B_i \cup F_i} |w_1\rangle \langle w_1|_{F_i} - P_{F_i}^K |\psi\rangle \langle \psi|_{B_i \cup F_i} P_{F_i}^K \| \leq 2g(n) = 2 \left(\frac{1 - \lambda_1^i}{\lambda_1^i} \right)^K
\end{aligned}$$

Here the first equality follows by definition of E (Equation 88), the second equality follows because C_{Wrap_i} is unitary and by using the tensor product structure after C_{Wrap_i} is removed, the third equality follows because C'_{L_i} and C'_{R_i} are unitary, the fourth equality follows because $\| |0_{L_i}\rangle \langle 0_{L_i}| \| = \| |0_{R_i}\rangle \langle 0_{R_i}| \| = 1$, and the inequality follows by two sequential applications of Lemma 15.

Next we will bound $\|H_1\|$. From the definition of H_1 in Equation 90 we have that:

$$\begin{aligned}
\|H_1\| &\equiv \left\| \lambda_1^i C_{L-Wrap_i} \text{tr}_{F_i} \left(C'_{L_i} |0_{L_i}\rangle \langle 0_{L_i}| (C')_{L_i}^\dagger \otimes |v_1\rangle \langle v_1|_{B_i} \otimes |w_1\rangle \langle w_1|_{F_i} \right) C_{L-Wrap_i}^\dagger \right. \\
&\otimes C_{R-Wrap_i} \text{tr}_{B_i} \left(|v_1\rangle \langle v_1|_{B_i} \otimes |w_1\rangle \langle w_1|_{F_i} \otimes C'_{R_i} |0_{R_i}\rangle \langle 0_{R_i}| (C')_{R_i}^\dagger \right) C_{R-Wrap_i}^\dagger \\
&- C_{L-Wrap_i} \text{tr}_{F_i} \left(C'_{L_i} |0_{L_i}\rangle \langle 0_{L_i}| (C')_{L_i}^\dagger \otimes P_{F_i}^K |\psi\rangle \langle \psi|_{B_i \cup F_i} P_{F_i}^K \right) C_{L-Wrap_i}^\dagger \\
&\otimes C_{R-Wrap_i} \text{tr}_{B_i} \left(|v_1\rangle \langle v_1|_{B_i} \otimes |w_1\rangle \langle w_1|_{F_i} \otimes C'_{R_i} |0_{R_i}\rangle \langle 0_{R_i}| (C')_{R_i}^\dagger \right) C_{R-Wrap_i}^\dagger \left. \right\| \\
&= \left\| \left(\lambda_1^i C_{L-Wrap_i} \text{tr}_{F_i} \left(C'_{L_i} |0_{L_i}\rangle \langle 0_{L_i}| (C')_{L_i}^\dagger \otimes |v_1\rangle \langle v_1|_{B_i} \otimes |w_1\rangle \langle w_1|_{F_i} \right) C_{L-Wrap_i}^\dagger \right. \right. \\
&- C_{L-Wrap_i} \text{tr}_{F_i} \left(C'_{L_i} |0_{L_i}\rangle \langle 0_{L_i}| (C')_{L_i}^\dagger \otimes P_{F_i}^K |\psi\rangle \langle \psi|_{B_i \cup F_i} P_{F_i}^K \right) C_{L-Wrap_i}^\dagger \\
&\otimes C_{R-Wrap_i} \text{tr}_{B_i} \left(|v_1\rangle \langle v_1|_{B_i} \otimes |w_1\rangle \langle w_1|_{F_i} \otimes C'_{R_i} |0_{R_i}\rangle \langle 0_{R_i}| (C')_{R_i}^\dagger \right) C_{R-Wrap_i}^\dagger \left. \right\| \\
&= \left\| \left(\lambda_1^i C_{L-Wrap_i} \text{tr}_{F_i} \left(C'_{L_i} |0_{L_i}\rangle \langle 0_{L_i}| (C')_{L_i}^\dagger \otimes |v_1\rangle \langle v_1|_{B_i} \otimes |w_1\rangle \langle w_1|_{F_i} \right) C_{L-Wrap_i}^\dagger \right. \right. \\
&- C_{L-Wrap_i} \text{tr}_{F_i} \left(C'_{L_i} |0_{L_i}\rangle \langle 0_{L_i}| (C')_{L_i}^\dagger \otimes P_{F_i}^K |\psi\rangle \langle \psi|_{B_i \cup F_i} P_{F_i}^K \right) C_{L-Wrap_i}^\dagger \left. \right\| \\
&\cdot \left\| C_{R-Wrap_i} \text{tr}_{B_i} \left(|v_1\rangle \langle v_1|_{B_i} \otimes |w_1\rangle \langle w_1|_{F_i} \otimes C'_{R_i} |0_{R_i}\rangle \langle 0_{R_i}| (C')_{R_i}^\dagger \right) C_{R-Wrap_i}^\dagger \right\| \\
&= \left\| \left(\lambda_1^i \text{tr}_{F_i} \left(C'_{L_i} |0_{L_i}\rangle \langle 0_{L_i}| (C')_{L_i}^\dagger \otimes |v_1\rangle \langle v_1|_{B_i} \otimes |w_1\rangle \langle w_1|_{F_i} \right) \right. \right. \\
&- \left. \left. \text{tr}_{F_i} \left(C'_{L_i} |0_{L_i}\rangle \langle 0_{L_i}| (C')_{L_i}^\dagger \otimes P_{F_i}^K |\psi\rangle \langle \psi|_{B_i \cup F_i} P_{F_i}^K \right) \right) \right\| \\
&\cdot \left\| |w_1\rangle \langle w_1|_{F_i} \otimes C'_{R_i} |0_{R_i}\rangle \langle 0_{R_i}| (C')_{R_i}^\dagger \right\| \\
&= \left\| \text{tr}_{F_i} \left(C'_{L_i} |0_{L_i}\rangle \langle 0_{L_i}| (C')_{L_i}^\dagger \otimes \left(\lambda_1^i |v_1\rangle \langle v_1|_{B_i} \otimes |w_1\rangle \langle w_1|_{F_i} - P_{F_i}^K |\psi\rangle \langle \psi|_{B_i \cup F_i} P_{F_i}^K \right) \right) \right\| \\
&\cdot \left\| |w_1\rangle \langle w_1|_{F_i} \otimes |0_{R_i}\rangle \langle 0_{R_i}| \right\| \\
&\leq \left\| \lambda_1^i |v_1\rangle \langle v_1|_{B_i} \otimes |w_1\rangle \langle w_1|_{F_i} - P_{F_i}^K |\psi\rangle \langle \psi|_{B_i \cup F_i} P_{F_i}^K \right\| \\
&\leq 2\lambda_1^i g(n) \leq 2g(n) = 2 \left(\frac{1 - \lambda_1^i}{\lambda_1^i} \right)^K
\end{aligned}$$

Here the first equality follows by definition (Equation 90), the second equality follows by re-grouping terms, and the third equality follows by the tensor product structure.

The proof for the bound on H_2 is extremely similar to the bound on H_1 , and so we will not repeat the argument.

□

A.2 Proofs for Statements in Section 5

Lemma (Restatement of Lemma 31).

$$\begin{aligned}
& \left\| \sum_{\sigma \in \mathcal{P}(\{i+1, \dots, j-1\}) \setminus \emptyset} (-1)^{|\sigma|+1} \left(\frac{1}{(\kappa_{T, \epsilon_2}^i \kappa_{T, \epsilon_2}^j)^{4K+1}} \mathcal{A}(S_{L,i}, \eta - 1) \cdot \mathcal{A}(S_{j,R}, \eta - 1) \right. \right. \\
& \cdot \mathcal{B} \left(\left(\otimes_{k \in \sigma} \Pi_{F_k}^K \langle 0_{M_k} | \right) \phi_{i,j} \left(\otimes_{k \in \sigma} |0_{M_k}\rangle \Pi_{F_k}^K \right), \frac{\epsilon}{2\Delta} \right) - \langle 0_{ALL} | \Psi_{\{i,j\} \cup \sigma} \rangle \langle \Psi_{\{i,j\} \cup \sigma} | 0_{ALL} \rangle \left. \right) \left\| \quad (95) \\
& \leq E_3(n, K, T, \epsilon_2, \epsilon, \Delta) + 16f(S, \eta - 1, \Delta, \epsilon),
\end{aligned}$$

where

$$E_3(n, K, T, \epsilon_2, \epsilon, \Delta) \equiv O \left(2^\Delta (6g(n)) + 2^\Delta K \left(e(n)^{2T} + \epsilon_2 \right) + \epsilon \right)$$

Proof. The proof proceeds in two parts. First, we show by direct calculation that the desired error quantity can be upper bounded by the sum of four error quantities G_1 , G_2 , G_3 , and G_4 :

$$\begin{aligned}
& \left\| \sum_{\sigma \in \mathcal{P}(\{i+1, \dots, j-1\}) \setminus \emptyset} (-1)^{|\sigma|+1} \left(\frac{1}{(\kappa_{T, \epsilon_2}^i \kappa_{T, \epsilon_2}^j)^{4K+1}} \mathcal{A}(S_{L,i}, \eta - 1) \cdot \mathcal{A}(S_{j,R}, \eta - 1) \right. \right. \\
& \cdot \mathcal{B} \left(\left(\otimes_{k \in \sigma} \Pi_{F_k}^K \langle 0_{M_k} | \right) \phi_{i,j} \left(\otimes_{k \in \sigma} |0_{M_k}\rangle \Pi_{F_k}^K \right), \frac{\epsilon}{2\Delta} \right) - \langle 0_{ALL} | \Psi_{\{i,j\} \cup \sigma} \rangle \langle \Psi_{\{i,j\} \cup \sigma} | 0_{ALL} \rangle \left. \right) \left\| \quad (96) \\
& \leq G_1 + G_2 + G_3 + G_4.
\end{aligned}$$

We then bound these four terms individually. We begin by demonstrating Equation 96, and defining G_1 , G_2 , G_3 , and G_4 in the process.

$$\begin{aligned}
& \left\| \sum_{\sigma \in \mathcal{P}(\{i+1, \dots, j-1\}) \setminus \emptyset} (-1)^{|\sigma|+1} \left(\frac{1}{(\kappa_{T, \epsilon_2}^i \kappa_{T, \epsilon_2}^j)^{2K+1}} \mathcal{A}(S_{L,i}, \eta - 1) \cdot \mathcal{A}(S_{j,R}, \eta - 1) \right. \right. \\
& \cdot \mathcal{B} \left(\left(\otimes_{k \in \sigma} \Pi_{F_k}^K \langle 0_{M_k} | \right) \phi_{i,j} \left(\otimes_{k \in \sigma} |0_{M_k}\rangle \Pi_{F_k}^K \right), \frac{\epsilon}{2\Delta} \right) - \langle 0_{ALL} | \Psi_{\{i,j\} \cup \sigma} \rangle \langle \Psi_{\{i,j\} \cup \sigma} | 0_{ALL} \rangle \left. \right) \left\| \right. \\
& \leq \left\| \frac{1}{(\lambda_1^i \lambda_1^j)^{4K+1}} \sum_{\sigma \in \mathcal{P}(\{i+1, \dots, j-1\}) \setminus \emptyset} (-1)^{|\sigma|+1} \left(\mathcal{A}(S_{L,i}, \eta - 1) \cdot \mathcal{A}(S_{j,R}, \eta - 1) \right. \right. \\
& \cdot \mathcal{B} \left(\left(\otimes_{k \in \sigma} \Pi_{F_k}^K \langle 0_{M_k} | \right) \phi_{i,j} \left(\otimes_{k \in \sigma} |0_{M_k}\rangle \Pi_{F_k}^K \right), \frac{\epsilon}{2\Delta} \right) \\
& - \langle 0_{ALL} | \phi_{L,i} | 0_{ALL} \rangle \cdot \langle 0_{ALL} | \left(\otimes_{k \in \sigma} \Pi_{F_k}^K \langle 0_{M_k} | \right) \phi_{i,j} \left(\otimes_{k \in \sigma} |0_{M_k}\rangle \Pi_{F_k}^K \right) | 0_{ALL} \rangle \cdot \langle 0_{ALL} | \phi_{j,R} | 0_{ALL} \rangle \left. \right) \left\| \right. \\
& + \sum_{\sigma \in \mathcal{P}(\{i+1, \dots, j-1\}) \setminus \emptyset} \left\| \langle 0_{ALL} | \Psi_{\{i,j\} \cup \sigma} \rangle \langle \Psi_{\{i,j\} \cup \sigma} | 0_{ALL} \rangle \right. \\
& - \frac{1}{(\lambda_1^i \lambda_1^j)^{4K+1}} \langle 0_{ALL} | \phi_{L,i} | 0_{ALL} \rangle \cdot \langle 0_{ALL} | \left(\otimes_{k \in \sigma} \Pi_{F_k}^K \langle 0_{M_k} | \right) \phi_{i,j} \left(\otimes_{k \in \sigma} |0_{M_k}\rangle \Pi_{F_k}^K \right) | 0_{ALL} \rangle \cdot \langle 0_{ALL} | \phi_{j,R} | 0_{ALL} \rangle \left. \right\| \\
& + \sum_{\sigma \in \mathcal{P}(\{i+1, \dots, j-1\}) \setminus \emptyset} \left\| \left(\frac{1}{(\lambda_1^i \lambda_1^j)^{4K+1}} - \frac{1}{(\kappa_{T, \epsilon_2}^i \kappa_{T, \epsilon_2}^j)^{4K+1}} \right) \right. \\
& \cdot \mathcal{A}(S_{L,i}, \eta - 1) \cdot \mathcal{A}(S_{j,R}, \eta - 1) \cdot \mathcal{B} \left(\left(\otimes_{k \in \sigma} \Pi_{F_k}^K \langle 0_{M_k} | \right) \phi_{i,j} \left(\otimes_{k \in \sigma} |0_{M_k}\rangle \Pi_{F_k}^K \right), \frac{\epsilon}{2\Delta} \right) \left. \right\|
\end{aligned}$$

which is equal to

$$\begin{aligned}
& = \left\| \frac{1}{(\lambda_1^i \lambda_1^j)^{4K+1}} \sum_{\sigma \in \mathcal{P}(\{i+1, \dots, j-1\}) \setminus \emptyset} (-1)^{|\sigma|+1} \left(\mathcal{A}(S_{L,i}, \eta - 1) \cdot \mathcal{A}(S_{j,R}, \eta - 1) \right. \right. \\
& \cdot \mathcal{B} \left(\left(\otimes_{k \in \sigma} \Pi_{F_k}^K \langle 0_{M_k} | \right) \phi_{i,j} \left(\otimes_{k \in \sigma} |0_{M_k}\rangle \Pi_{F_k}^K \right), \frac{\epsilon}{2\Delta} \right) \\
& - \langle 0_{ALL} | \phi_{L,i} | 0_{ALL} \rangle \cdot \langle 0_{ALL} | \left(\otimes_{k \in \sigma} \Pi_{F_k}^K \langle 0_{M_k} | \right) \phi_{i,j} \left(\otimes_{k \in \sigma} |0_{M_k}\rangle \Pi_{F_k}^K \right) | 0_{ALL} \rangle \cdot \langle 0_{ALL} | \phi_{j,R} | 0_{ALL} \rangle \left. \right) \left\| \right. \\
& + G_1 + G_2 \tag{97}
\end{aligned}$$

where G_1 and G_2 are defined as the error quantities

$$\begin{aligned}
G_1 & \equiv \sum_{\sigma \in \mathcal{P}(\{i+1, \dots, j-1\}) \setminus \emptyset} \left\| \langle 0_{ALL} | \Psi_{\{i,j\} \cup \sigma} \rangle \langle \Psi_{\{i,j\} \cup \sigma} | 0_{ALL} \rangle \right. \\
& - \frac{1}{(\lambda_1^i \lambda_1^j)^{4K+1}} \langle 0_{ALL} | \phi_{L,i} | 0_{ALL} \rangle \cdot \langle 0_{ALL} | \left(\otimes_{k \in \sigma} \Pi_{F_k}^K \langle 0_{M_k} | \right) \phi_{i,j} \left(\otimes_{k \in \sigma} |0_{M_k}\rangle \Pi_{F_k}^K \right) | 0_{ALL} \rangle \cdot \langle 0_{ALL} | \phi_{j,R} | 0_{ALL} \rangle \left. \right\|
\end{aligned}$$

and

$$G_2 \equiv \sum_{\sigma \in \mathcal{P}(\{i+1, \dots, j-1\}) \setminus \emptyset} \left\| \left(\frac{1}{(\lambda_1^i \lambda_1^j)^{4K+1}} - \frac{1}{(\kappa_{T, \epsilon_2}^i \kappa_{T, \epsilon_2}^j)^{4K+1}} \right) \cdot \mathcal{A}(S_{L,i}, \eta - 1) \cdot \mathcal{A}(S_{j,R}, \eta - 1) \cdot \mathcal{B} \left(\left(\otimes_{k \in \sigma} \Pi_{F_k}^K \langle 0_{M_k} | \right) \phi_{i,j} \left(\otimes_{k \in \sigma} | 0_{M_k} \rangle \Pi_{F_k}^K \right), \frac{\epsilon}{2\Delta} \right) \right\|.$$

Later we will bound the size of G_1 and G_2 using Lemmas 20, and 26 respectively. For now we carry them along in our calculation. So, continuing where we left off in Equation 97:

$$\begin{aligned}
& \left\| \sum_{\sigma \in \mathcal{P}(\{i+1, \dots, j-1\}) \setminus \emptyset} (-1)^{|\sigma|+1} \left(\frac{1}{(\kappa_{T, \epsilon_2}^i \kappa_{T, \epsilon_2}^j)^{2K+1}} \mathcal{A}(S_{L,i}, \eta - 1) \cdot \mathcal{A}(S_{j,R}, \eta - 1) \right. \right. \\
& \cdot \mathcal{B} \left(\left(\otimes_{k \in \sigma} \Pi_{F_k}^K \langle 0_{M_k} | \right) \phi_{i,j} \left(\otimes_{k \in \sigma} |0_{M_k}\rangle \Pi_{F_k}^K \right), \frac{\epsilon}{2\Delta} \right) - \langle 0_{ALL} | \Psi_{\{i,j\} \cup \sigma} \rangle \langle \Psi_{\{i,j\} \cup \sigma} | 0_{ALL} \rangle \left. \right) \left\| \right. \\
& \leq \left\| \frac{1}{(\lambda_1^i \lambda_1^j)^{4K+1}} \sum_{\sigma \in \mathcal{P}(\{i+1, \dots, j-1\}) \setminus \emptyset} (-1)^{|\sigma|+1} (\mathcal{A}(S_{L,i}, \eta - 1) \cdot \mathcal{A}(S_{j,R}, \eta - 1) \right. \\
& \cdot \mathcal{B} \left(\left(\otimes_{k \in \sigma} \Pi_{F_k}^K \langle 0_{M_k} | \right) \phi_{i,j} \left(\otimes_{k \in \sigma} |0_{M_k}\rangle \Pi_{F_k}^K \right), \frac{\epsilon}{2\Delta} \right) \\
& - \langle 0_{ALL} | \phi_{L,i} | 0_{ALL} \rangle \cdot \langle 0_{ALL} | \left(\otimes_{k \in \sigma} \Pi_{F_k}^K \langle 0_{M_k} | \right) \phi_{i,j} \left(\otimes_{k \in \sigma} |0_{M_k}\rangle \Pi_{F_k}^K \right) | 0_{ALL} \rangle \cdot \langle 0_{ALL} | \phi_{j,R} | 0_{ALL} \rangle \left. \right) \left\| \right. \\
& + G_1 + G_2 \\
& \leq \left\| \frac{1}{(\lambda_1^i \lambda_1^j)^{4K+1}} \mathcal{A}(S_{L,i}, \eta - 1) \cdot \mathcal{A}(S_{j,R}, \eta - 1) \sum_{\sigma \in \mathcal{P}(\{i+1, \dots, j-1\}) \setminus \emptyset} (-1)^{|\sigma|+1} \left(\right. \right. \\
& \cdot \mathcal{B} \left(\left(\otimes_{k \in \sigma} \Pi_{F_k}^K \langle 0_{M_k} | \right) \phi_{i,j} \left(\otimes_{k \in \sigma} |0_{M_k}\rangle \Pi_{F_k}^K \right), \frac{\epsilon}{2\Delta} \right) \\
& - \langle 0_{ALL} | \left(\otimes_{k \in \sigma} \Pi_{F_k}^K \langle 0_{M_k} | \right) \phi_{i,j} \left(\otimes_{k \in \sigma} |0_{M_k}\rangle \Pi_{F_k}^K \right) | 0_{ALL} \rangle \left. \right) \left\| \right. \\
& + \left\| \frac{1}{(\lambda_1^i \lambda_1^j)^{4K+1}} \left(\mathcal{A}(S_{L,i}, \eta - 1) \cdot \mathcal{A}(S_{j,R}, \eta - 1) - \langle 0_{ALL} | \phi_{L,i} | 0_{ALL} \rangle \cdot \langle 0_{ALL} | \phi_{j,R} | 0_{ALL} \rangle \right) \right. \\
& \cdot \sum_{\sigma \in \mathcal{P}(\{i+1, \dots, j-1\}) \setminus \emptyset} (-1)^{|\sigma|+1} \langle 0_{ALL} | \left(\otimes_{k \in \sigma} \Pi_{F_k}^K \langle 0_{M_k} | \right) \phi_{i,j} \left(\otimes_{k \in \sigma} |0_{M_k}\rangle \Pi_{F_k}^K \right) | 0_{ALL} \rangle \left. \right\| \\
& + G_1 + G_2 \\
& \leq 2^\Delta \cdot \frac{\epsilon}{2^\Delta} \cdot \left\| \frac{1}{(\lambda_1^i \lambda_1^j)^{4K+1}} \mathcal{A}(S_{L,i}, \eta - 1) \cdot \mathcal{A}(S_{j,R}, \eta - 1) \right\| \\
& + \left\| \frac{1}{(\lambda_1^i \lambda_1^j)^{4K+1}} \left(\mathcal{A}(S_{L,i}, \eta - 1) \cdot \mathcal{A}(S_{j,R}, \eta - 1) - \langle 0_{ALL} | \phi_{L,i} | 0_{ALL} \rangle \cdot \langle 0_{ALL} | \phi_{j,R} | 0_{ALL} \rangle \right) \right. \\
& \cdot \sum_{\sigma \in \mathcal{P}(\{i+1, \dots, j-1\}) \setminus \emptyset} (-1)^{|\sigma|+1} \langle 0_{ALL} | \left(\otimes_{k \in \sigma} \Pi_{F_k}^K \langle 0_{M_k} | \right) \phi_{i,j} \left(\otimes_{k \in \sigma} |0_{M_k}\rangle \Pi_{F_k}^K \right) | 0_{ALL} \rangle \left. \right\| \\
& + G_1 + G_2
\end{aligned}$$

$$\begin{aligned}
&\leq \epsilon \cdot \left\| \frac{1}{(\lambda_1^i \lambda_1^j)^{4K+1}} \mathcal{A}(S_{L,i}, \eta - 1) \cdot \mathcal{A}(S_{j,R}, \eta - 1) \right\| \\
&+ \left\| \frac{1}{(\lambda_1^i \lambda_1^j)^{4K+1}} \left(\mathcal{A}(S_{L,i}, \eta - 1) \cdot \mathcal{A}(S_{j,R}, \eta - 1) - \langle 0_{ALL} | \phi_{L,i} | 0_{ALL} \rangle \cdot \langle 0_{ALL} | \phi_{j,R} | 0_{ALL} \rangle \right) \cdot \langle 0_{ALL} | \phi_{i,j} | 0_{ALL} \rangle \right\| \\
&+ \left\| \frac{1}{(\lambda_1^i \lambda_1^j)^{4K+1}} \left(\mathcal{A}(S_{L,i}, \eta - 1) \cdot \mathcal{A}(S_{j,R}, \eta - 1) - \langle 0_{ALL} | \phi_{L,i} | 0_{ALL} \rangle \cdot \langle 0_{ALL} | \phi_{j,R} | 0_{ALL} \rangle \right) \right. \\
&\cdot \left. \left(\langle 0_{ALL} | \phi_{i,j} | 0_{ALL} \rangle - \sum_{\sigma \in \mathcal{P}(\{i+1, \dots, j-1\}) \setminus \emptyset} (-1)^{|\sigma|+1} \langle 0_{ALL} | \left(\otimes_{k \in \sigma} \Pi_{F_k}^K \langle 0_{M_k} | \right) \phi_{i,j} \left(\otimes_{k \in \sigma} | 0_{M_k} \rangle \Pi_{F_k}^K \right) | 0_{ALL} \rangle \right) \right\| \\
&+ G_1 + G_2 \\
&\leq G_1 + G_2 + G_3 + \left\| \frac{1}{(\lambda_1^i \lambda_1^j)^{4K+1}} \left(\mathcal{A}(S_{L,i}, \eta - 1) \cdot \mathcal{A}(S_{j,R}, \eta - 1) - \langle 0_{ALL} | \phi_{L,i} | 0_{ALL} \rangle \cdot \langle 0_{ALL} | \phi_{j,R} | 0_{ALL} \rangle \right) \right\| \cdot \\
&\left(\left\| \langle 0_{ALL} | \phi_{i,j} | 0_{ALL} \rangle - \sum_{\sigma \in \mathcal{P}(\{i+1, \dots, j-1\}) \setminus \emptyset} (-1)^{|\sigma|+1} \langle 0_{ALL} | \left(\otimes_{k \in \sigma} \Pi_{F_k}^K \langle 0_{M_k} | \right) \phi_{i,j} \left(\otimes_{k \in \sigma} | 0_{M_k} \rangle \Pi_{F_k}^K \right) | 0_{ALL} \rangle \right\| + 1 \right) \\
&\leq G_1 + G_2 + G_3 + G_4
\end{aligned}$$

Where

$$G_3 \equiv \epsilon \cdot \left\| \frac{1}{(\lambda_1^i \lambda_1^j)^{4K+1}} \mathcal{A}(S_{L,i}, \eta - 1) \cdot \mathcal{A}(S_{j,R}, \eta - 1) \right\|$$

and

$$\begin{aligned}
G_4 &\equiv \left\| \frac{1}{(\lambda_1^i \lambda_1^j)^{4K+1}} \left(\mathcal{A}(S_{L,i}, \eta - 1) \cdot \mathcal{A}(S_{j,R}, \eta - 1) - \langle 0_{ALL} | \phi_{L,i} | 0_{ALL} \rangle \cdot \langle 0_{ALL} | \phi_{j,R} | 0_{ALL} \rangle \right) \right\| \cdot \\
&\left(\left\| \langle 0_{ALL} | \phi_{i,j} | 0_{ALL} \rangle - \sum_{\sigma \in \mathcal{P}(\{i+1, \dots, j-1\}) \setminus \emptyset} (-1)^{|\sigma|+1} \langle 0_{ALL} | \left(\otimes_{k \in \sigma} \Pi_{F_k}^K \langle 0_{M_k} | \right) \phi_{i,j} \left(\otimes_{k \in \sigma} | 0_{M_k} \rangle \Pi_{F_k}^K \right) | 0_{ALL} \rangle \right\| + 1 \right)
\end{aligned}$$

We will now prove the bounds: $G_1 \leq 2^\Delta (12g(n))$, $G_2 \leq O(2^\Delta K (e(n)^{2T} + \epsilon_2))$, $G_3 \leq O(\epsilon)$, $G_4 \leq 8(1 + (2e(n) + 2g(n))^{\Delta-2})f(S, \eta - 1, \Delta, \epsilon) \leq 16 \cdot f(S, \eta - 1, \Delta, \epsilon)$. The desired result follows from these bounds, so all that remains is to prove them, which we do below.

We begin by bounding G_1 . For any fixed subset $\sigma \in \mathcal{P}(\{j-1, \dots, i+1\})$ we know, by using two applications of Lemma 20 that:

$$\begin{aligned}
& \left\| \langle 0_{ALL} | \Psi_{\{i,j\} \cup \sigma} \rangle \langle \Psi_{\{i,j\} \cup \sigma} | 0_{ALL} \rangle \right. \\
& - \frac{1}{(\lambda_1^i \lambda_1^j)^{4K+1}} \langle 0_{ALL} | \phi_{L,i} | 0_{ALL} \rangle \cdot \langle 0_{ALL} | \left(\otimes_{k \in \sigma} \Pi_{F_k}^K \langle 0_{M_k} | \right) \phi_{i,j} \left(\otimes_{k \in \sigma} | 0_{M_k} \rangle \Pi_{F_k}^K \right) | 0_{ALL} \rangle \cdot \langle 0_{ALL} | \phi_{j,R} | 0_{ALL} \rangle \left. \right\| \\
& \leq \left\| \left| \Psi_{\{i,j\} \cup \sigma} \right\rangle \left\langle \Psi_{\{i,j\} \cup \sigma} \right| - \frac{1}{(\lambda_1^i \lambda_1^j)^{4K+1}} \phi_{L,i} \otimes \left(\otimes_{k \in \sigma} \Pi_{F_k}^K \langle 0_{M_k} | \right) \phi_{i,j} \left(\otimes_{k \in \sigma} | 0_{M_k} \rangle \Pi_{F_k}^K \right) \otimes \phi_{j,R} \right\| \\
& \leq 2 \cdot 6g(n) = 12g(n)
\end{aligned}$$

This follows because we can use Lemma 20 to “cut” the state $|\Psi_{\{i,j\} \cup \sigma}\rangle \langle \Psi_{\{i,j\} \cup \sigma}|$ twice, once at cut i and once at cut j , which produces the above product state, incurring error $2 \cdot 6f(n)$. It follows that:

$$\begin{aligned}
G_1 & \equiv \sum_{\sigma \in \mathcal{P}(\{i+1, \dots, j-1\}) \setminus \emptyset} \left\| \langle 0_{ALL} | \Psi_{\{i,j\} \cup \sigma} \rangle \langle \Psi_{\{i,j\} \cup \sigma} | 0_{ALL} \rangle \right. \\
& - \frac{1}{(\lambda_1^i \lambda_1^j)^{4K+1}} \langle 0_{ALL} | \phi_{L,i} | 0_{ALL} \rangle \cdot \langle 0_{ALL} | \left(\otimes_{k \in \sigma} \Pi_{F_k}^K \langle 0_{M_k} | \right) \phi_{i,j} \left(\otimes_{k \in \sigma} | 0_{M_k} \rangle \Pi_{F_k}^K \right) | 0_{ALL} \rangle \cdot \langle 0_{ALL} | \phi_{j,R} | 0_{ALL} \rangle \left. \right\| \\
& \leq 2^\Delta (12g(n)),
\end{aligned}$$

as desired.

For the next three bounds we will repeatedly use the fact that $(\lambda_1^i)^{4K+1} = \Theta(1) = (\lambda_1^j)^{4K+1}$, and thus, $\frac{1}{(\lambda_1^i \lambda_1^j)^{4K+1}} = \Theta(1)$. The reason for this is that, we know, from the use of Lemma 13 in the error analysis of Algorithm 2, that $(\lambda_1^i)^{4K+1}, (\lambda_1^j)^{4K+1} \geq 1 - O(e(n))$, where $e(n) \leq (1 - \frac{\log(\delta)}{2 \log^2(n)}) = O(1/\log^4(n))$ (since $\delta > n^{-\log^2(n)}$ as verified in the check in the driver Algorithm 1). Since $K = O(\log^3(n))$, as specified in Algorithm 2, it follows that $(\lambda_1^i)^{4K+1} = \Theta(1) = (\lambda_1^j)^{4K+1}$.

We now bound G_2 .

$$\begin{aligned}
G_2 &\equiv \sum_{\sigma \in \mathcal{P}(\{i+1, \dots, j-1\}) \setminus \emptyset} \left\| \left(\frac{1}{(\lambda_1^i \lambda_1^j)^{4K+1}} - \frac{1}{(\kappa_{T, \epsilon_2}^i \kappa_{T, \epsilon_2}^j)^{4K+1}} \right) \right. \\
&\quad \cdot \mathcal{A}(S_{L,i}, \eta - 1) \cdot \mathcal{A}(S_{j,R}, \eta - 1) \cdot \mathcal{B} \left(\left(\otimes_{k \in \sigma} \Pi_{F_k}^K \langle 0_{M_k} | \right) \phi_{i,j} \left(\otimes_{k \in \sigma} |0_{M_k}\rangle \Pi_{F_k}^K \right), \frac{\epsilon}{2^\Delta} \right) \left. \right\| \\
&\leq \sum_{\sigma \in \mathcal{P}(\{i+1, \dots, j-1\}) \setminus \emptyset} \left\| \left(\frac{1}{(\lambda_1^i \lambda_1^j)^{4K+1}} - \frac{1}{(\kappa_{T, \epsilon_2}^i \kappa_{T, \epsilon_2}^j)^{4K+1}} \right) \right\| \\
&= 2^{\Delta-2} \left\| \left(\frac{1}{(\lambda_1^i \lambda_1^j)^{4K+1}} - \frac{1}{(\kappa_{T, \epsilon_2}^i \kappa_{T, \epsilon_2}^j)^{4K+1}} \right) \right\| = 2^{\Delta-2} \left\| \left(\frac{(\lambda_1^i \lambda_1^j)^{4K+1} - (\kappa_{T, \epsilon_2}^i \kappa_{T, \epsilon_2}^j)^{4K+1}}{(\lambda_1^i \lambda_1^j)^{4K+1} (\kappa_{T, \epsilon_2}^i \kappa_{T, \epsilon_2}^j)^{4K+1}} \right) \right\| \\
&= O(2^\Delta) \left\| (\lambda_1^i \lambda_1^j)^{4K+1} - (\kappa_{T, \epsilon_2}^i \kappa_{T, \epsilon_2}^j)^{4K+1} \right\| = O \left(2^\Delta (4K+1) (|\lambda_1^i - \kappa_{T, \epsilon_2}^i| + |\lambda_1^j - \kappa_{T, \epsilon_2}^j|) \right) \\
&\leq O \left(2^\Delta K \left(\frac{e(n)^{2T} + \epsilon_2}{(\lambda_1^i)^{2T+1}} \right) \right) = O \left(2^\Delta K (e(n)^{2T} + \epsilon_2) \right)
\end{aligned}$$

Where the first inequality follows because, by definition, $\mathcal{A}(S_{L,i}, \eta - 1), \mathcal{A}(S_{j,R}, \eta - 1), \mathcal{B} \left(\left(\otimes_{k \in \sigma} \Pi_{F_k}^K \langle 0_{M_k} | \right) \phi_{i,j} \left(\otimes_{k \in \sigma} |0_{M_k}\rangle \Pi_{F_k}^K \right), \frac{\epsilon}{2^\Delta} \right) = O(1)$ (since each is a close approximation of a quantum state amplitude squared, which is at most 1 by definition). The remaining steps follow by using the fact that $(\lambda_1^i)^{4K+1} = \Theta(1) = (\lambda_1^j)^{4K+1}$ as discussed above (note that $(\lambda_1^i)^{2T} = \Theta(1)$ for the same reason, since $T = O(\log^3(n))$), and by using Lemma 26 which gives the error bound for how well the κ terms approximate the λ terms.

We now bound G_3 :

$$G_3 \equiv \epsilon \cdot \left\| \frac{1}{(\lambda_1^i \lambda_1^j)^{4K+1}} \mathcal{A}(S_{L,i}, \eta - 1) \cdot \mathcal{A}(S_{j,R}, \eta - 1) \right\| \leq O(\epsilon)$$

Where we have used that $(\lambda_1^i)^{4K+1} = \Theta(1) = (\lambda_1^j)^{4K+1}$, and $\mathcal{A}(S_{L,i}, \eta - 1), \mathcal{A}(S_{j,R}, \eta - 1) = O(1)$, for the same reasons as in the bound of G_2 .

We now bound G_4 :

$$\begin{aligned}
G_4 &\equiv \left\| \frac{1}{(\lambda_1^i \lambda_1^j)^{4K+1}} \left(\mathcal{A}(S_{L,i}, \eta - 1) \cdot \mathcal{A}(S_{j,R}, \eta - 1) - \langle 0_{ALL} | \phi_{L,i} | 0_{ALL} \rangle \cdot \langle 0_{ALL} | \phi_{j,R} | 0_{ALL} \rangle \right) \right\| \\
&\left(\left\| \langle 0_{ALL} | \phi_{i,j} | 0_{ALL} \rangle - \sum_{\sigma \in \mathcal{P}(\{i+1, \dots, j-1\}) \setminus \emptyset} (-1)^{|\sigma|+1} \langle 0_{ALL} | \left(\otimes_{k \in \sigma} \Pi_{F_k}^K \langle 0_{M_k} | \right) \phi_{i,j} \left(\otimes_{k \in \sigma} | 0_{M_k} \rangle \Pi_{F_k}^K \right) | 0_{ALL} \rangle \right\| + 1 \right) \\
&\leq 4 \left\| \mathcal{A}(S_{L,i}, \eta - 1) \cdot \mathcal{A}(S_{j,R}, \eta - 1) - \langle 0_{ALL} | \phi_{L,i} | 0_{ALL} \rangle \cdot \langle 0_{ALL} | \phi_{j,R} | 0_{ALL} \rangle \right\| \\
&\left((2e(n) + 2g(n))^{\Delta-2} + 1 \right) \\
&\leq 8 \left\| \mathcal{A}(S_{L,i}, \eta - 1) \cdot \mathcal{A}(S_{j,R}, \eta - 1) - \langle 0_{ALL} | \phi_{L,i} | 0_{ALL} \rangle \cdot \langle 0_{ALL} | \phi_{j,R} | 0_{ALL} \rangle \right\| \\
&\leq 8 \cdot 2 \cdot f(S, \eta - 1, \Delta, \epsilon) = 16f(S, \eta - 1, \Delta, \epsilon)
\end{aligned}$$

Here the first inequality follows by our previous argument that $\frac{1}{(\lambda_1^i \lambda_1^j)^{4K+1}} = \Theta(1)$, as well as Lemma 18. (In fact, since we find it desirable to have an explicit constant for this particular error term, we are using $\frac{1}{(\lambda_1^i \lambda_1^j)^{4K+1}} \leq 4$, which the reader may verify, although we emphasize that the value of this constant does not matter for the asymptotic scaling and is only used for simplicity of presentation elsewhere in this paper.) Note that our use of Lemma 18, while simple, was key here in order to avoid a factor of 2^Δ appearing in the bound of G_4 . The second inequality follows because the bound $(2e(n) + 2g(n))^{\Delta-2} = o(1)$ is immediate (in fact, since $e(n), f(n) = o(1)$, and $\Delta = \Theta(\log(n))$, this quantity actually quite small, but here we only need that it is $o(1)$). The final inequality follows by two uses of the definition of $f(S, \eta - 1, \Delta, \epsilon)$, which, we recall, is defined, recursively, to be the error bound on $\mathcal{A}(\cdot, \eta - 1)$, so that $f(S, \eta - 1, \Delta, \epsilon) \geq |\mathcal{A}(S_{L,i}, \eta - 1) - \langle 0_{ALL} | \phi_{L,i} | 0_{ALL} \rangle|$, and $f(S, \eta - 1, \Delta, \epsilon) \geq |\mathcal{A}(S_{j,R}, \eta - 1) - \langle 0_{ALL} | \phi_{j,R} | 0_{ALL} \rangle|$ by definition. (This final step also uses the triangle inequality, and the facts that $\mathcal{A}(S_{L,i}, \eta - 1), \mathcal{A}(S_{j,R}, \eta - 1) = O(1)$, etc).

Now that we have bounded G_1, G_2, G_3 , and G_4 , the proof is complete. \square

References

- [AA11] Scott Aaronson and Alex Arkhipov. The computational complexity of linear optics. In *Proceedings of the Forty-Third Annual ACM Symposium on Theory of Computing*, STOC '11, page 333–342, New York, NY, USA, 2011. Association for Computing Machinery. URL: <https://doi.org/10.1145/1993636.1993682>, doi:10.1145/1993636.1993682.
- [AG19] van Joran Apeldoorn and András Gilyén. Improvements in quantum sdp-solving with applications. *arXiv:1804.05058 [quant-ph]*, page 15 pages, 2019. arXiv: 1804.05058. doi:10.4230/LIPIcs.ICALP.2019.99.
- [BFNV19] Adam Bouland, Bill Fefferman, Chinmay Nirkhe, and Umesh Vazirani. On the complexity and verification of quantum random circuit sampling. *Nature Physics*, 15(2):159–163, Feb 2019. doi:10.1038/s41567-018-0318-2.

- [BGM20] Sergy Bravyi, David Gosset, and Ramis Movassagh. Classical algorithms for quantum mean values. *QIP*, 2020. URL: <https://arxiv.org/abs/1909.11485>.
- [BJS11] Michael J. Bremner, Richard Jozsa, and Dan J. Shepherd. Classical simulation of commuting quantum computations implies collapse of the polynomial hierarchy. *Proceedings of the Royal Society A: Mathematical, Physical and Engineering Sciences*, 467(2126):459–472, Feb 2011. doi:10.1098/rspa.2010.0301.
- [BMS17] Michael J. Bremner, Ashley Montanaro, and Dan J. Shepherd. Achieving quantum supremacy with sparse and noisy commuting quantum computations. *Quantum*, 1:8, Apr 2017. URL: <http://dx.doi.org/10.22331/q-2017-04-25-8>, doi:10.22331/q-2017-04-25-8.
- [BVHS⁺18] Juan Bermejo-Vega, Dominik Hangleiter, Martin Schwarz, Robert Raussendorf, and Jens Eisert. Architectures for quantum simulation showing a quantum speedup. *Phys. Rev. X*, 8:021010, Apr 2018. URL: <https://link.aps.org/doi/10.1103/PhysRevX.8.021010>, doi:10.1103/PhysRevX.8.021010.
- [DHKLP20] Alexander M. Dalzell, Aram W. Harrow, Dax Enshan Koh, and Rolando L. La Placa. How many qubits are needed for quantum computational supremacy? *Quantum*, 4:264, May 2020. URL: <http://dx.doi.org/10.22331/q-2020-05-11-264>, doi:10.22331/q-2020-05-11-264.
- [GSLW19] András Gilyén, Yuan Su, Guang Hao Low, and Nathan Wiebe. Quantum singular value transformation and beyond: exponential improvements for quantum matrix arithmetics. *STOC*, 2019. URL: <https://arxiv.org/pdf/1806.01838.pdf>.
- [HZN⁺20] Cupjin Huang, Fang Zhang, Michael Newman, Junjie Cai, Xun Gao, Zhengxiong Tian, Junyin Wu, Haihong Xu, Huanjun Yu, Bo Yuan, Mario Szegedy, Yaoyun Shi, and Jianxin Chen. Classical simulation of quantum supremacy circuits, 2020. [arXiv:2005.06787](https://arxiv.org/abs/2005.06787).
- [KLL⁺17] Shelby Kimmel, Cedric Yen-Yu Lin, Guang Hao Low, Maris Ozols, and Theodore J. Yoder. Hamiltonian simulation with optimal sample complexity. *npj Quantum Information*, 3(1):13, Mar 2017. doi:10.1038/s41534-017-0013-7.
- [KMM21] Yasuhiro Kondo, Ryuhei Mori, and Ramis Movassagh. Fine-grained analysis and improved robustness of quantum supremacy for random circuit sampling, 2021. [arXiv:2102.01960](https://arxiv.org/abs/2102.01960).
- [LC16] Guang Hao Low and Isaac L. Chuang. Hamiltonian simulation by qubitization. *Quantum*, 3:163, Oct 2016. arXiv:1610.06546. URL: <http://dx.doi.org/10.22331/q-2019-07-12-163>, doi:10.22331/q-2019-07-12-163.
- [LMR14] Seth Lloyd, Masoud Mohseni, and Patrick Rebentrost. Quantum principal component analysis. *Nature Physics*, 10(9):631–633, Jul 2014. URL: <http://dx.doi.org/10.1038/nphys3029>, doi:10.1038/nphys3029.
- [Mov20] Ramis Movassagh. Quantum supremacy and random circuits. *QIP*, 2020. URL: <https://arxiv.org/pdf/1909.06210.pdf>.

- [NPD⁺20] John Napp, Rolando L. La Placa, Alexander M. Dalzell, Fernando G. S. L. Brandao, and Aram W. Harrow. Efficient classical simulation of random shallow 2d quantum circuits, 2020. [arXiv:2001.00021](https://arxiv.org/abs/2001.00021).
- [NSC⁺17] Alex Neville, Chris Sparrow, Raphaël Clifford, Eric Johnston, Patrick M. Birchall, Ashley Montanaro, and Anthony Laing. Classical boson sampling algorithms with superior performance to near-term experiments. *Nature Physics*, 13(12):1153–1157, Dec 2017. [doi:10.1038/nphys4270](https://doi.org/10.1038/nphys4270).