

One-Shot Hybrid State Redistribution

Eyuri Wakakuwa^{1,2}, Yoshifumi Nakata^{3,4,5}, and Min-Hsiu Hsieh^{6,7}

¹Department of Communication Engineering and Informatics, Graduate School of Informatics and Engineering, The University of Electro-Communications, Tokyo 182-8585, Japan

²Department of Computer Science, Graduate School of Information Science and Technology, The University of Tokyo, Bunkyo-ku, Tokyo 113-8656, Japan

³Yukawa Institute for Theoretical Physics, Kyoto university, Kitashirakawa Oiwakecho, Sakyo-ku, Kyoto, 606-8502, Japan

⁴Photon Science Center, Graduate School of Engineering, The University of Tokyo, Bunkyo-ku, Tokyo 113-8656, Japan

⁵JST, PRESTO, 4-1-8 Honcho, Kawaguchi, Saitama, 332-0012, Japan

⁶Centre for Quantum Software & Information (UTS:QSI), University of Technology Sydney, Sydney NSW, Australia

⁷Hon Hai (Foxconn) Research Institute, Taipei, Taiwan

We consider state redistribution of a “hybrid” information source that has both classical and quantum components. The sender transmits classical and quantum information at the same time to the receiver, in the presence of classical and quantum side information both at the sender and at the decoder. The available resources are shared entanglement, and noiseless classical and quantum communication channels. We derive one-shot direct and converse bounds for these three resources, represented in terms of the smooth conditional entropies of the source state. Various coding theorems for two-party source coding problems are systematically obtained by reduction from our results, including the ones that have not been addressed in previous literatures.

1 Introduction

Quantum state redistribution is a task in which the sender aims at transmitting quantum states to the receiver, in the presence of quantum side information both at the sender and at the receiver. The costs of quantum communication and entanglement required for state redistribution have been analyzed in [35, 13, 36] for the asymptotic scenario of infinitely many copies and vanishingly small error, and in [7, 10, 2] for the one-shot scenario. Various coding theorems for

Eyuri Wakakuwa: e.wakakuwa@gmail.com

Yoshifumi Nakata: nakata@qi.t.u-tokyo.ac.jp

Min-Hsiu Hsieh: min-hsiu.hsieh@foxconn.com

two-party quantum source coding problems are obtained by reduction from these results as special cases, such as the Schumacher compression [24], quantum state merging [17] and the fully-quantum Slepian-Wolf [1, 9]. However, some of the well-known coding theorems cannot be obtained from those results, such as the (fully-classical) Slepian-Wolf (see e.g. [8]) and the classical data compression with quantum side information [11]. This is because the results in [35, 13, 36, 7] only cover the fully quantum scenario, in which the information to be transmitted and the available resources are both quantum.

In this paper, we generalize the one-shot state redistribution theorem in [7] to a “hybrid” situation. That is, we consider the task of state redistribution in which the information to be transmitted and the side information at the parties have both classical and quantum components. Not only quantum communication and shared entanglement, but also classical communication is available as a resource. Our goal is to derive trade-off relations among the costs of the three resources required for achieving the task within a small error. The main result is that we provide the direct and the converse bounds for the rate triplet to be achievable, in terms of the smooth conditional entropies of the source state and the error tolerance. For most of the special cases that have been analyzed in the previous literatures, the two bounds match in the asymptotic limit of infinitely many copies and vanishingly small error, providing the full characterization of the achievable rate region. Our result can be viewed as a one-shot generalization of the classically-

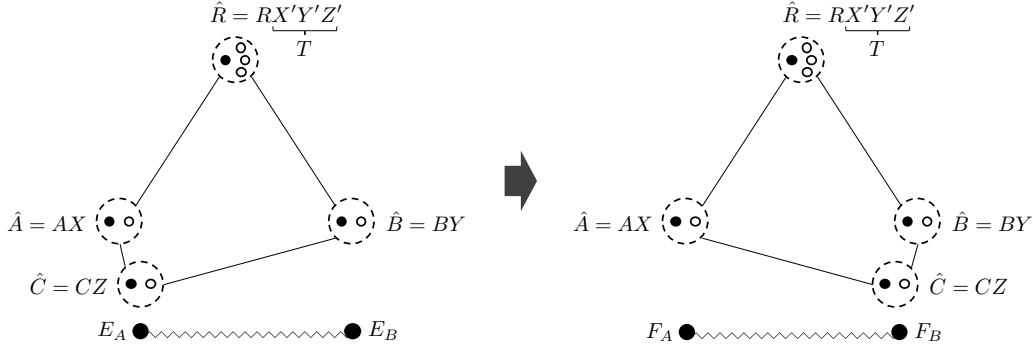

Figure 1: The task of state redistribution for the classical-quantum hybrid source is depicted. The black dots and the circles represent classical and quantum parts of the information source, respectively. The wavy line represents the entanglement resource.

assisted state redistribution protocol, proposed in [18].

Coding theorems for most of the redistribution-type protocols, not only for quantum or classical information source but also for hybrid one, in one-shot scenario are systematically obtained from our result by reduction. In this sense, our result completes the one-shot capacity theorems of the redistribution-type protocols in a standard setting. As examples, we show that the coding theorems for the fully quantum state redistribution, the fully quantum Slepian-Wolf, quantum state splitting, quantum state merging, classical data compression with quantum side information, quantum data compression with classical side information and the fully classical Slepian-Wolf and quantum state redistribution with classical side information only at the decoder [3] can be recovered. The last one would further lead to the family of quantum protocols in the presence of classical side information only at the decoder, along the same line as the one without classical side information [1, 12]. In addition, our result also covers some redistribution-type protocols that have not been addressed in the previous literatures.

We note that the cost of resources in the hybrid redistribution-type protocols cannot be fully analyzed by simply plugging the hybrid source and the hybrid channel into the fully quantum setting. This is because interconversion of classical and quantum communication channels requires the use of entanglement resource, which is not allowed e.g. in the fully classical scenario.

This paper is organized as follows. In Section 2, we introduce notations and definitions that will be used throughout this paper. In Section 3, we provide the formulation of the problem and

present the main results. The results are applied in Section 4 to special cases, and compared with the results in the previous literatures. The proofs of the direct part and the converse part are provided in Section 5 and 6, respectively. Conclusions are given in Section 7. The properties of the smooth entropies used in the proofs are summarized in Appendix A.

2 Preliminaries

We summarize notations and definitions that will be used throughout this paper.

2.1 Notations

We denote the set of linear operators on a Hilbert space \mathcal{H} by $\mathcal{L}(\mathcal{H})$. For normalized density operators and sub-normalized density operators, we use the following notations, respectively:

$$\mathcal{S}_=(\mathcal{H}) = \{\rho \in \mathcal{L}(\mathcal{H}) : \rho \geq 0, \text{Tr}[\rho] = 1\}, \quad (1)$$

$$\mathcal{S}_<(\mathcal{H}) = \{\rho \in \mathcal{L}(\mathcal{H}) : \rho \geq 0, \text{Tr}[\rho] \leq 1\}. \quad (2)$$

A Hilbert space associated with a quantum system A is denoted by \mathcal{H}^A , and its dimension is denoted by d_A . A system composed of two subsystems A and B is denoted by AB . When M and N are linear operators on \mathcal{H}^A and \mathcal{H}^B , respectively, we denote $M \otimes N$ as $M^A \otimes N^B$ for clarity. In the case of pure states, we abbreviate $|\psi\rangle^A \otimes |\phi\rangle^B$ as $|\psi\rangle^A |\phi\rangle^B$. We denote $|\psi\rangle\langle\psi|$ simply by ψ .

For $\rho^{AB} \in \mathcal{L}(\mathcal{H}^{AB})$, ρ^A represents $\text{Tr}_B[\rho^{AB}]$. The identity operator is denoted by I . We denote $(M^A \otimes I^B)|\psi\rangle^{AB}$ as $M^A|\psi\rangle^{AB}$ and $(M^A \otimes I^B)\rho^{AB}(M^A \otimes I^B)^\dagger$ as $M^A\rho^{AB}M^A^\dagger$. When \mathcal{E}

is a supermap from $\mathcal{L}(\mathcal{H}^A)$ to $\mathcal{L}(\mathcal{H}^B)$, we denote it by $\mathcal{E}^{A \rightarrow B}$. When $A = B$, we use \mathcal{E}^A for short. We also denote $(\mathcal{E}^{A \rightarrow B} \otimes \text{id}^C)(\rho^{AC})$ by $\mathcal{E}^{A \rightarrow B}(\rho^{AC})$. When a supermap is given by a conjugation of a unitary U^A or a linear operator $W^{A \rightarrow B}$, we especially denote it by its calligraphic font such as $\mathcal{U}^A(X^A) := (U^A)X^A(U^A)^\dagger$ and $\mathcal{W}^{A \rightarrow B}(X^A) := (W^{A \rightarrow B})X^A(W^{A \rightarrow B})^\dagger$.

The maximally entangled state between A and A' , where $\mathcal{H}^A \cong \mathcal{H}^{A'}$, is defined by

$$|\Phi\rangle^{AA'} := \frac{1}{\sqrt{d_A}} \sum_{\alpha=1}^{d_A} |\alpha\rangle^A |\alpha\rangle^{A'} \quad (3)$$

with respect to a fixed orthonormal basis $\{|\alpha\rangle\}_{\alpha=1}^{d_A}$. The maximally mixed state on A is defined by $\pi^A := I^A/d_A$.

For any linear CP map $\mathcal{T}^{A \rightarrow B}$, there exists a finite dimensional quantum system E and a linear operator $W_{\mathcal{T}}^{A \rightarrow BE}$ such that $\mathcal{T}^{A \rightarrow B}(\cdot) = \text{Tr}_E[W_{\mathcal{T}}(\cdot)W_{\mathcal{T}}^\dagger]$. The operator $W_{\mathcal{T}}$ is called a Stinespring dilation of $\mathcal{T}^{A \rightarrow B}$ [25], and the linear CP map defined by $\text{Tr}_B[W_{\mathcal{T}}(\cdot)W_{\mathcal{T}}^\dagger]$ is called a *complementary map* of $\mathcal{T}^{A \rightarrow B}$. With a slight abuse of notation, we denote the complementary map by $\mathcal{T}^{A \rightarrow E}$.

2.2 Norms and Distances

For a linear operator X , the trace norm is defined as $\|X\|_1 = \text{Tr}[\sqrt{X^\dagger X}]$. For subnormalized states $\rho, \sigma \in \mathcal{S}_{\leq}(\mathcal{H})$, the trace distance is defined by $\|\rho - \sigma\|_1$. The generalized fidelity and the purified distance are defined by

$$\bar{F}(\rho, \sigma) := \|\sqrt{\rho}\sqrt{\sigma}\|_1 + \sqrt{(1 - \text{Tr}[\rho])(1 - \text{Tr}[\sigma])} \quad (4)$$

and

$$P(\rho, \sigma) := \sqrt{1 - \bar{F}(\rho, \sigma)^2}, \quad (5)$$

respectively (see Lemma 3 in [29]). The trace distance and the purified distance are related as

$$\frac{1}{2}\|\rho - \sigma\|_1 \leq P(\rho, \sigma) \leq \sqrt{2\|\rho - \sigma\|_1} \quad (6)$$

for any $\rho, \sigma \in \mathcal{S}_{\leq}(\mathcal{H})$. The epsilon ball of a subnormalized state $\rho \in \mathcal{S}_{\leq}(\mathcal{H})$ is defined by

$$\mathcal{B}^\epsilon(\rho) := \{\tau \in \mathcal{S}_{\leq}(\mathcal{H}) \mid P(\rho, \tau) \leq \epsilon\}. \quad (7)$$

2.3 One-Shot Entropies

For any subnormalized state $\rho \in \mathcal{S}_{\leq}(\mathcal{H}^{AB})$ and normalized state $\varsigma \in \mathcal{S}_{=}(\mathcal{H}^B)$, define

$$H_{\min}(A|B)_{\rho|\varsigma} := \sup\{\lambda \in \mathbb{R} \mid 2^{-\lambda} I^A \otimes \varsigma^B \geq \rho^{AB}\} \quad (8)$$

and

$$H_{\max}(A|B)_{\rho|\varsigma} := \log \|\sqrt{\rho^{AB}}\sqrt{I^A \otimes \varsigma^B}\|_1^2. \quad (9)$$

The conditional min- and max- entropies (see e.g. [26]) are defined by

$$H_{\min}(A|B)_\rho := \sup_{\sigma^B \in \mathcal{S}_{=}(\mathcal{H}^B)} H_{\min}(A|B)_{\rho|\sigma}, \quad (10)$$

$$H_{\max}(A|B)_\rho := \sup_{\sigma^B \in \mathcal{S}_{=}(\mathcal{H}^B)} H_{\max}(A|B)_{\rho|\sigma}, \quad (11)$$

and the smoothed versions thereof are given by

$$H_{\min}^\epsilon(A|B)_\rho := \sup_{\hat{\rho}^{AB} \in \mathcal{B}^\epsilon(\rho)} H_{\min}(A|B)_{\hat{\rho}}, \quad (12)$$

$$H_{\max}^\epsilon(A|B)_\rho := \inf_{\hat{\rho}^{AB} \in \mathcal{B}^\epsilon(\rho)} H_{\max}(A|B)_{\hat{\rho}} \quad (13)$$

for $\epsilon \geq 0$. In the case where B is a trivial (one-dimensional) system, we simply denote them as $H_{\min}^\epsilon(A)_\rho$ and $H_{\max}^\epsilon(A)_\rho$, respectively. We define

$$H_*^{(\iota, \kappa)}(A|B)_\rho := \max\{H_{\min}^\iota(A|B)_\rho, H_{\max}^\kappa(A|B)_\rho\} \quad (14)$$

and

$$\tilde{I}_{\min}^\epsilon(A : C|B)_\rho := H_{\min}^\epsilon(A|B)_\rho - H_{\min}^\epsilon(A|BC)_\rho. \quad (15)$$

We will refer to (15) as the *smooth conditional min mutual information*. For $\tau \in \mathcal{S}(\mathcal{H}^A)$, we also use the ‘‘max entropy’’ in the version of [23] (see Section 3.1.1 therein). Taking the smoothing into account, it is defined by

$$H_{\max}^\epsilon(A)_\tau := \inf_{\Pi : \text{Tr}[\Pi\tau] \geq 1 - \epsilon} \log \text{rank}[\Pi], \quad (16)$$

where the infimum is taken over all projections Π such that $\text{Tr}[\Pi\tau] \geq 1 - \epsilon$. The von Neumann entropies and the quantum mutual information are defined by

$$H(A)_\rho := -\text{Tr}[\rho^A \log \rho^A], \quad (17)$$

$$H(A|B)_\rho := H(AB)_\rho - H(B)_\rho, \quad (18)$$

$$I(A : B)_\rho := H(A)_\rho - H(A|B)_\rho. \quad (19)$$

The properties of the smooth conditional entropies used in this paper are summarized in Appendix A.

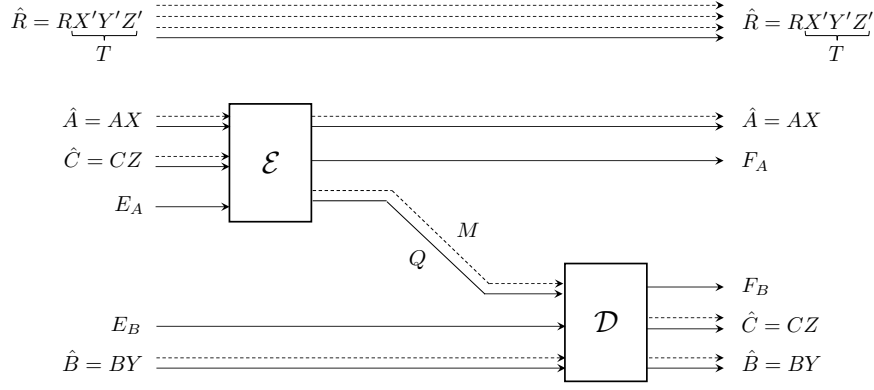

Figure 2: The task of state redistribution for the classical-quantum hybrid source is depicted in the diagram. The black lines and the dashed lines represent classical and quantum systems, respectively.

3 Formulation and Results

Consider a classical-quantum source state in the form of

$$\begin{aligned} \Psi_s^{ABCRXYZX'Y'Z'} := & \\ & \sum_{x,y,z} p_{xyz} |x\rangle\langle x|^X \otimes |y\rangle\langle y|^Y \otimes |z\rangle\langle z|^Z \\ & \otimes |\psi_{xyz}\rangle\langle\psi_{xyz}|^{ABCR} \otimes |xyz\rangle\langle xyz|^{X'Y'Z'}. \end{aligned} \quad (20)$$

Here, $\{p_{xyz}\}_{x,y,z}$ is a probability distribution, $|\psi_{xyz}\rangle$ are pure states, and $\{|x\rangle\}_x, \{|y\rangle\}_y, \{|z\rangle\}_z, \{|xyz\rangle\}_{x,y,z}$ are orthonormal bases. The systems X', Y' and Z' are assumed to be isomorphic to X, Y and Z , respectively. For the simplicity of notations, we denote $AX, BY, CZ, X'Y'Z'$ and $RX'Y'Z'$ by $\hat{A}, \hat{B}, \hat{C}, T$ and \hat{R} , respectively. Accordingly, we also denote the source state by $\Psi_s^{\hat{A}\hat{B}\hat{C}\hat{R}}$.

We consider a task in which the sender transmits \hat{C} to the receiver (see Figure 1 and 2). The sender and the receiver have access to systems \hat{A} and \hat{B} , respectively, as side information. The system \hat{R} is the reference system that is inaccessible to the sender and the receiver. The available resources for the task are the one-way noiseless classical and quantum channels from the sender to the receiver, and an entangled state shared in advance between the sender and the receiver. We describe the communication resources by a quantum system Q with dimension 2^q and a ‘‘classical’’ system M with dimension 2^c . The entanglement resources shared between the sender and the receiver, before and after the protocol, are given by the maximally entangled states $\Phi_{2^{e+e_0}}^{E_A E_B}$ and

$\Phi_{2^{e_0}}^{F_A F_B}$ with Schmidt rank 2^{e+e_0} and 2^{e_0} , respectively.

Definition 1 A tuple (c, q, e, e_0) is said to be achievable within an error δ for Ψ_s , if there exists a pair of an encoding CPTP map $\mathcal{E}^{\hat{A}\hat{C}E_A \rightarrow \hat{A}QMFA}$ and a decoding CPTP map $\mathcal{D}^{\hat{B}QME_B \rightarrow \hat{B}\hat{C}F_B}$, such that

$$\left\| \mathcal{D} \circ \mathcal{E}(\Psi_s^{\hat{A}\hat{B}\hat{C}\hat{R}} \otimes \Phi_{2^{e+e_0}}^{E_A E_B}) - \Psi_s^{\hat{A}\hat{B}\hat{C}\hat{R}} \otimes \Phi_{2^{e_0}}^{F_A F_B} \right\|_1 \leq \delta. \quad (21)$$

Note that, since M is a classical message, the encoding CPTP map \mathcal{E} must be such that for any input state τ , the output state $\mathcal{E}^{\hat{A}\hat{C}E_A \rightarrow \hat{A}QMFA}(\tau)$ is diagonal in M with respect to a fixed orthonormal basis. Note also that we implicitly assume that $c, q, e_0 \geq 0$, while the net entanglement cost e can be negative.

Our goal is to obtain necessary and sufficient conditions for a tuple (c, q, e, e_0) to be achievable within the error δ for a given source state Ψ_s . The direct and converse bounds are given by the following theorems:

Theorem 2 (Direct part.) A tuple (c, q, e, e_0) is achievable within an error $4\sqrt{12\epsilon + 6\delta} + \sqrt{2}\epsilon$ for Ψ_s if $d_C \geq 2$ and it holds that

$$c + 2q \geq \max\{\tilde{H}_I^{(3\epsilon/2, \epsilon/2)}, \tilde{H}_II^{(\epsilon/2)}\} - \log(\delta^4/2), \quad (22)$$

$$c + q + e \geq H_{\max}^{\epsilon/2}(CZ|BY)_{\Psi_s} - \log(\delta^2/2), \quad (23)$$

$$q + e \geq H_{\max}^{\epsilon/2}(C|BXYZ)_{\Psi_s} - \log \delta^2, \quad (24)$$

$$e_0 \geq \frac{1}{2}(H_{\max}^{\epsilon^2/8}(C)_{\Psi_s} - H_{\max}^{3\epsilon/2}(C|BXYZ)_{\Psi_s}) + \log \delta, \quad (25)$$

where

$$\begin{aligned} \tilde{H}_I^{(\iota, \kappa)} &:= H_*^{(\iota, \kappa)}(C|AXYZ)_{\Psi_s} \\ &\quad + H_{\max}^{\kappa}(CZ|BY)_{\Psi_s}, \end{aligned} \quad (26)$$

$$\begin{aligned} \tilde{H}_{II}^{(\iota)} &:= H_{\max}^{\iota}(C|AXZ)_{\Psi_s} \\ &\quad + H_{\max}^{\iota}(C|BXYZ)_{\Psi_s} \end{aligned} \quad (27)$$

and $H_*^{(\iota, \kappa)}$ is defined by (14).

In the case where $d_C = 1$, a tuple $(c, 0, 0, 0)$ is achievable for Ψ_s within the error δ if it holds that

$$c \geq H_{\max}^{\epsilon}(Z|BY)_{\Psi_s} - \log \frac{\delta^2}{2}. \quad (28)$$

Theorem 3 (Converse part.) *Suppose that a tuple (c, q, e, e_0) is achievable within the error δ for Ψ_s . Then, regardless of the value of e_0 , it holds that*

$$c + 2q \geq \max\{\tilde{H}_I^{(\epsilon, \delta)}, \tilde{H}_{II}^{(\epsilon, \delta)} - \Delta^{(\epsilon, \delta)}\} - 6f(\epsilon), \quad (29)$$

$$\begin{aligned} c + q + e &\geq H_{\min}^{\epsilon}(BYCZ)_{\Psi_s} \\ &\quad - H_{\min}^{12\epsilon+6\sqrt{\delta}}(BY)_{\Psi_s} - f(\epsilon), \end{aligned} \quad (30)$$

$$\begin{aligned} q + e &\geq H_{\min}^{\epsilon}(BC|XYZ)_{\Psi_s} \\ &\quad - H_{\min}^{11\epsilon+8\sqrt{\delta}}(B|XYZ)_{\Psi_s} - 2f(\epsilon) \end{aligned} \quad (31)$$

for any $\epsilon > 0$. Here, $f(x) := -\log(1 - \sqrt{1 - x^2})$,

$$\begin{aligned} \tilde{H}_I^{(\epsilon, \delta)} &:= H_{\min}^{\epsilon}(AC|XYZ)_{\Psi_s} \\ &\quad - H_{\max}^{\epsilon}(A|XYZ)_{\Psi_s} \\ &\quad + H_{\min}^{\epsilon}(BYCZ)_{\Psi_s} \\ &\quad - H_{\min}^{12\epsilon+6\sqrt{\delta}}(BY)_{\Psi_s}, \end{aligned} \quad (32)$$

$$\begin{aligned} \tilde{H}_{II}^{(\epsilon, \delta)} &:= H_{\min}^{\epsilon}(AXCZ)_{\Psi_s} \\ &\quad - H_{\max}^{\epsilon}(AXZ)_{\Psi_s} \\ &\quad + H_{\min}^{\epsilon}(BC|XYZ)_{\Psi_s} \\ &\quad - H_{\min}^{11\epsilon+8\sqrt{\delta}}(B|XYZ)_{\Psi_s} \end{aligned} \quad (33)$$

and

$$\Delta^{(\epsilon, \delta)} := \sup_{\mathcal{F}} \tilde{I}_{\min}^{\epsilon+4\sqrt{\delta}}(G_A : Y' | M_A A X' Z')_{\mathcal{F}(\Psi_s)}. \quad (34)$$

The supremum in (34) is taken over all CPTP maps $\mathcal{F} : \hat{A}\hat{C} \rightarrow AG_A M_A$ such that $\mathcal{F}(\tau)$ is diagonal in M_A with a fixed orthonormal basis for any $\tau \in \mathcal{S}(\mathcal{H}^{\hat{A}\hat{C}})$, and

$$\begin{aligned} \inf_{\{\omega_{xyz}\}} P \left(\mathcal{F}(\Psi_s^{\hat{A}\hat{C}\hat{R}}), \sum_{x,y,z} p_{xyz} \psi_{xyz}^{A\hat{R}} \otimes \omega_{xyz}^{G_A M_A} \right) \\ \leq 2\sqrt{\delta}, \end{aligned} \quad (35)$$

where we informally denoted $\psi_{xyz}^{AR} \otimes |xyz\rangle\langle xyz|^T$ by $\psi_{xyz}^{A\hat{R}}$.

The proofs of Theorem 2 and Theorem 3 will be provided in Section 5 and Section 6, respectively.

We also consider an asymptotic scenario of infinitely many copies and vanishingly small error. A rate triplet (c, q, e) is said to be *asymptotically achievable* if, for any $\delta > 0$ and sufficiently large $n \in \mathbb{N}$, there exists $e_0 \geq 0$ such that the tuple (nc, nq, ne, ne_0) is achievable within the error δ for the one-shot redistribution of the state $\Psi_s^{\otimes n}$. The achievable rate region is defined as the closure of the set of achievable rate triplets. The following theorem provides a characterization of the achievable rate region:

Theorem 4 (Asymptotic limit.) *In the asymptotic limit of infinitely many copies and vanishingly small error, the inner and outer bounds for the achievable rate region are given by*

$$c + 2q \geq \max\{\tilde{H}_I, \tilde{H}_{II}\}, \quad (36)$$

$$c + q + e \geq H(CZ|BY)_{\Psi_s}, \quad (37)$$

$$q + e \geq H(C|BXYZ)_{\Psi_s}, \quad (38)$$

$$e_0 \geq \frac{1}{2} I(C : BXYZ)_{\Psi_s} \quad (39)$$

and

$$c + 2q \geq \max\{\tilde{H}_I, \tilde{H}_{II} - \tilde{\Delta}\}, \quad (40)$$

$$c + q + e \geq H(CZ|BY)_{\Psi_s}, \quad (41)$$

$$q + e \geq H(C|BXYZ)_{\Psi_s}, \quad (42)$$

respectively. Here,

$$\tilde{H}_I := H(C|AXYZ)_{\Psi_s} + H(CZ|BY)_{\Psi_s}, \quad (43)$$

$$\tilde{H}_{II} := H(C|AXZ)_{\Psi_s} + H(C|BXYZ)_{\Psi_s} \quad (44)$$

and

$$\tilde{\Delta} := \lim_{\delta \rightarrow 0} \lim_{n \rightarrow \infty} \frac{1}{n} \Delta^{(\epsilon, \delta)}(\Psi_s^{\otimes n}), \quad (45)$$

where $\Delta^{(\epsilon, \delta)}$ is defined in Theorem 3.

Theorem 4 immediately follows from the one-shot direct and converse bounds (Theorem 2 and Theorem 3). This is due to the fully-quantum asymptotic equipartition property [28], which implies that the smooth conditional entropies are equal to the von Neumann conditional entropy in the asymptotic limit of infinitely many copies.

That is, for any $\rho \in \mathcal{S}_=(\mathcal{H}^{PQ})$ and $\epsilon > 0$, it holds that

$$\begin{aligned} & \lim_{n \rightarrow \infty} \frac{1}{n} H_{\min}^{\epsilon}(P^n|Q^n)_{\rho^{\otimes n}} \\ &= \lim_{n \rightarrow \infty} \frac{1}{n} H_{\max}^{\epsilon}(P^n|Q^n)_{\rho^{\otimes n}} \end{aligned} \quad (46)$$

$$= H(P|Q)_{\rho}. \quad (47)$$

A simple calculation using this relation and the chain rule of the conditional entropy implies that the R.H.S.s of (22)-(25) and (29)-(31) coincide with those of (36)-(39) and (40)-(42), respectively, in the asymptotic limit of infinitely many copies.

Due to the existence of the term $\tilde{\Delta}$ in Inequality (40), the direct and converse bounds in Theorem 4 do not match in general. In many cases, however, it holds that $\tilde{\Delta} = 0$ and thus the two bounds matches. This is due to the following lemma about the property of $\Delta^{(\epsilon, \delta)}$:

Lemma 5 *The quantity $\Delta^{(\epsilon, \delta)}$ defined in Theorem 3 is nonnegative, and is equal to zero if there is no classical side information at the decoder (i.e. $\dim Y = \dim Y' = 1$) or if there is neither quantum message nor quantum side information at the encoder (i.e. $\dim A = \dim C = 1$). The quantity $\tilde{\Delta}$ satisfies the same property due to the definition (45).*

A proof of Lemma 5 will be provided in Section 6.4. To clarify the general condition under which $\tilde{\Delta} = 0$ is left as an open problem.

Remark. The results presented in this section are applicable to the case where the sender and the receiver can make use of the resource of classical shared randomness. To this end, it is only necessary to incorporate the classical shared randomness as a part of classical side information X and Y .

4 Reduction to Special Cases

In this section, we apply the results presented in Section 3 to special cases of source coding (see Figure 3 in the next page). In principle, the results cover all special cases where some of the components A , B , C , X , Y or Z are assumed to be one-dimensional, and where c , q or e is assumed to be zero.

Among them, we particularly consider the cases with no classical component in the source state and with no side information at the encoder, which have been analyzed in previous literatures. We also consider quantum state redistribution with classical side information at the decoder, which has not been addressed before. We investigate both the one-shot and the asymptotic scenarios. The one-shot direct and converse bounds are obtained from Theorem 2 and Theorem 3, respectively, and the asymptotic rate region is obtained from Theorem 4. The analysis presented below shows that, for the tasks that have been analyzed in previous literatures, the bounds obtained from our results coincide with the ones obtained in the literatures. It should be noted, however, that the coincidence in the one-shot scenario is only up to changes of the types of entropies and the values of the smoothing parameters. All entropies are for the source state Ψ_s . We will use Lemma 21 in Appendix A for the calculation of entropies.

4.1 No Classical Component in The Source State

First, we consider the case where there is no classical component in the source state. It is described by setting $X = Y = Z = \emptyset$. By imposing several additional assumptions, the scenario reduces to different protocols.

4.1.1 Fully Quantum State Redistribution

Our hybrid scenario of state redistribution reduces to the fully quantum scenario, by additionally assuming that $c = 0$. The one-shot direct part is given by

$$2q \geq H_{*}^{(3\epsilon/2, \epsilon/2)}(C|A) + H_{\max}^{\epsilon/2}(C|B) - \log(\delta^4/2), \quad (48)$$

$$q + e \geq H_{\max}^{\epsilon/2}(C|B) - \log(\delta^2/2), \quad (49)$$

$$e_0 \geq \frac{1}{2}(H_{\max}^{\epsilon^2/8}(C) - H_{\max}^{3\epsilon/2}(C|B)) + \log \delta. \quad (50)$$

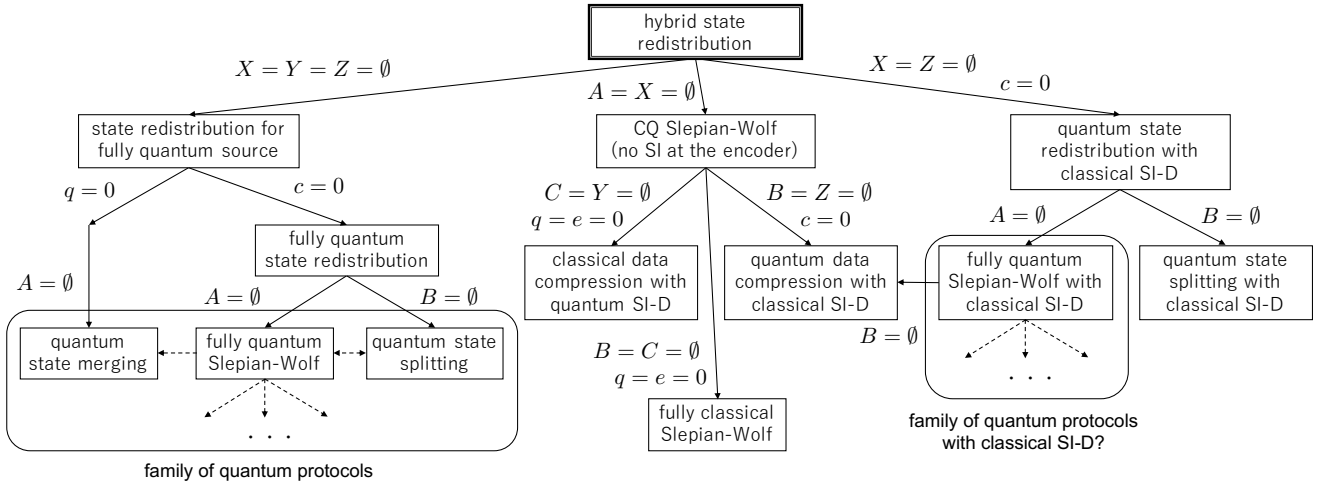

Figure 3: The relation among special cases of communication scenario analyzed in Section 4 are depicted. “SI” and “SI-D” stand for “side information” and “side information at the decoder”, respectively. See Table 1 below for the notations.

	information source			available resources	
	side information at the encoder	side information at the decoder	information to be transmitted	communication	shared correlation
quantum	A	B	C	q	e
classical	X	Y	Z	c	-

Table 1

An example of the tuple satisfying the above conditions is

$$q = \frac{1}{2} (H_*^{(3\epsilon/2, \epsilon/2)}(C|A) + H_{\max}^\epsilon(C|B) - \log(\delta^4/2)), \quad (51)$$

$$e = \frac{1}{2} (-H_{\max}^\epsilon(C|A) + H_{\max}^\epsilon(C|B) + 1), \quad (52)$$

$$e_0 = \frac{1}{2} (H_{\max'}^{\epsilon^2/8}(C) - H_{\max}^{3\epsilon/2}(C|B)) + \log \delta. \quad (53)$$

The achievability of q and e given by (51) and (52) coincides with the result of [7] (see also [2]). The one-shot converse bound is represented as

$$2q \geq H_{\min}^\epsilon(AC) - H_{\max}^\epsilon(A) + H_{\min}^\epsilon(BC) - H_{\min}^{12\epsilon+6\sqrt{\delta}}(B) - 8f(\epsilon), \quad (54)$$

$$q + e \geq H_{\min}^\epsilon(BC) - H_{\min}^{12\epsilon+6\sqrt{\delta}}(B) - f(\epsilon). \quad (55)$$

The condition (54) in the above coincides with Inequality (104) in [7]. The rate region for the asymptotic scenario is obtained from Theorem 4,

which yields

$$2q \geq H(C|A) + H(C|B), \quad (56)$$

$$q + e \geq H(C|B). \quad (57)$$

A simple calculation implies that the above rate region is equal to the one obtained in Ref. [13, 35].

4.1.2 Fully Quantum Slepian-Wolf

The fully-quantum Slepian-Wolf protocol is obtained by setting $A = \emptyset$, $c = 0$. The one-shot direct part obtained from Theorem 2 reads

$$2q \geq H_*^{(3\epsilon/2, \epsilon/2)}(C) + H_{\max}^{\epsilon/2}(C|B) - \log(\delta^4/2), \quad (58)$$

$$q + e \geq H_{\max}^{\epsilon/2}(C|B) - \log(\delta^2/2), \quad (59)$$

$$e_0 \geq \frac{1}{2} (H_{\max'}^{\epsilon^2/8}(C) - H_{\max}^{3\epsilon/2}(C|B)) + \log \delta. \quad (60)$$

An example of the rate triplet (q, e, e_0) satisfying the above inequalities is

$$q = \frac{1}{2}(H_*^{(3\epsilon/2, \epsilon/2)}(C) + H_{\max}^{\epsilon/2}(C|B) - \log(\delta^4/2)), \quad (61)$$

$$e = \frac{1}{2}(-H_*^{(3\epsilon/2, \epsilon/2)}(C) + H_{\max}^{\epsilon/2}(C|B) + 1), \quad (62)$$

$$e_0 = \frac{1}{2}(H_{\max'}^{\epsilon^2/8}(C) - H_{\max}^{3\epsilon/2}(C|B)) + \log \delta. \quad (63)$$

The result is equivalent to the one given by [9] (see Theorem 8 therein), with respect to q and e . Note, however, that our achievability bound requires the use of initial entanglement resource of $e + e_0$ ebits, whereas the one by [9] does not. The one-shot converse bound is obtained from Theorem 3, which yields

$$2q \geq H_{\min}^{\epsilon}(C) + H_{\min}^{\epsilon}(BC) - H_{\min}^{12\epsilon+6\sqrt{\delta}}(B) - 6f(\epsilon), \quad (64)$$

$$q + e \geq H_{\min}^{\epsilon}(BC) - H_{\min}^{12\epsilon+6\sqrt{\delta}}(B) - f(\epsilon). \quad (65)$$

From Theorem 4, the two-dimensional achievable rate region for the asymptotic scenario is given by

$$2q \geq H(C) + H(C|B), \quad (66)$$

$$q + e \geq H(C|B), \quad (67)$$

which coincides with the result obtained in [1]. It should be noted that various coding theorems for quantum protocols are obtained from that for the fully quantum Slepian-Wolf protocol, which is referred to as the family of quantum protocols [1, 12].

4.1.3 Quantum State Splitting

The task in which $B = \emptyset$, $c = 0$ is called quantum state splitting. The one-shot direct part is represented as

$$2q \geq H_*^{(3\epsilon/2, \epsilon/2)}(C|A) + H_{\max}^{\epsilon/2}(C) - \log(\delta^4/2), \quad (68)$$

$$q + e \geq H_{\max}^{\epsilon/2}(C) - \log(\delta^2/2), \quad (69)$$

$$e_0 \geq \frac{1}{2}(H_{\max'}^{\epsilon^2/8}(C) - H_{\max}^{3\epsilon/2}(C)) + \log \delta. \quad (70)$$

Note that if a triplet (q, e, e_0) is achievable, then $(q, e + e_0, 0)$ is also achievable. Thus, an example

of an achievable rate pair (q, e) is

$$q = \frac{1}{2}(H_*^{(3\epsilon/2, \epsilon/2)}(C|A) + H_{\max}^{\epsilon/2}(C) - \log(\delta^4/2)), \quad (71)$$

$$e = \frac{1}{2}(-H_*^{(3\epsilon/2, \epsilon/2)}(C|A) + H_{\max}^{\epsilon/2}(C) + 1) + \delta e_0, \quad (72)$$

where we have denoted the R.H.S. of (70) by δe_0 . This coincides with Lemma 3.5 in [6], up to an extra term δe_0 . The one-shot converse bound is given by

$$2q \geq H_{\min}^{\epsilon}(AC) - H_{\max}^{\epsilon}(A) + H_{\min}^{\epsilon}(C) + \log(1 - 22\epsilon - 16\sqrt{\delta}) - 6f(\epsilon), \quad (73)$$

$$q + e \geq H_{\min}^{\epsilon}(C) + \log(1 - 22\epsilon - 16\sqrt{\delta}) - f(\epsilon). \quad (74)$$

The rate region for the asymptotic scenario yields

$$2q \geq H(C|A) + H(C), \quad (75)$$

$$q + e \geq H(C). \quad (76)$$

An example of a rate pair satisfying this condition is

$$q = \frac{1}{2}(H(C) + H(C|A)), \quad (77)$$

$$e = \frac{1}{2}(H(C) - H(C|A)), \quad (78)$$

This result coincides with Equality (6.1) in [1], under the correspondence $|\Psi_s\rangle^{ACR} = U_{\mathcal{N}}^{R' \rightarrow AC} |\varphi\rangle^{R'R}$ with $U_{\mathcal{N}}^{R' \rightarrow AC}$ being some isometry.

4.1.4 Quantum State Merging

Quantum state merging is a task in which $A = \emptyset$, $q = 0$. The one-shot direct part is given by

$$c \geq H_*^{(3\epsilon/2, \epsilon/2)}(C) + H_{\max}^{\epsilon/2}(C|B) - \log(\delta^4/2), \quad (79)$$

$$e \geq H_{\max}^{\epsilon/2}(C|B) - \log \delta^2, \quad (80)$$

$$e_0 \geq \frac{1}{2}(H_{\max'}^{\epsilon^2/8}(C) - H_{\max}^{3\epsilon/2}(C|B)) + \log \delta. \quad (81)$$

The achievability of the entanglement cost (80) is equal to the one given by [15] (see Theorem 5.2 therein). The one-shot converse bound is obtained from Theorem 3, which yields

$$c \geq H_{\min}^{\epsilon}(C) + H_{\min}^{\epsilon}(BC) - H_{\min}^{12\epsilon+6\sqrt{\delta}}(B) - 6f(\epsilon), \quad (82)$$

$$e \geq H_{\min}^{\epsilon}(BC) - H_{\min}^{11\epsilon+8\sqrt{\delta}}(B) - 2f(\epsilon). \quad (83)$$

The rate region for the asymptotic setting is obtained from Theorem 4 as

$$c \geq H(C) + H(C|B), \quad (84)$$

$$e \geq H(C|B). \quad (85)$$

This rate region is equivalent to the results in [16, 17]. Note, however, that the protocols in [16, 17] are more efficient than ours, in that the catalytic use of entanglement resource is not required.

4.2 No Side Information At The Encoder

Next, we consider scenarios in which there is no classical or quantum side information at the encoder. This corresponds to the case where $A = X = \emptyset$. We consider three scenarios by imposing several additional assumptions.

4.2.1 Classical Data Compression with Quantum Side Information at The Decoder

The task of classical data compression with quantum side information was analyzed in [11]. This is obtained by additionally setting $Y = C = \emptyset$, $q = e = e_0 = 0$. The one-shot direct and converse bounds are given by

$$c \geq H_{\max}^{\epsilon}(Z|B) - \log \frac{\delta^2}{2}, \quad (86)$$

$$c \geq H_{\min}^{\epsilon}(BZ) - H_{\min}^{12\epsilon+6\sqrt{\delta}}(B) - f(\epsilon), \quad (87)$$

respectively. This result is equivalent to the one obtained in [21] (see also [27]). In the asymptotic limit, the achievable rate region is given by $c \geq H(Z|B)$, which coincides with the result by [11].

4.2.2 Quantum Data Compression with Classical Side Information at The Decoder

The task of quantum data compression with classical side information at the decoder was analyzed in [4]. This is obtained by imposing additional assumptions $Z = B = \emptyset$, $c = 0$. In the entanglement ‘‘unconsumed’’ scenario ($e = 0$), the direct bounds for the one-shot case is given by

$$q \geq \frac{1}{2}(H_*^{(3\epsilon/2, \epsilon/2)}(C) + H_{\max}^{\epsilon/2}(C|Y)) - \log \frac{\delta^4}{2}, \quad (88)$$

$$e_0 \geq \frac{1}{2}(H_{\max}^{\epsilon^2/8}(C) - H_{\max}^{3\epsilon/2}(C|Y)) + \log \delta. \quad (89)$$

Note that the entanglement is used only catalytically. Thus, in the asymptotic regime, the achievable quantum communication rate in the entanglement unassisted scenario ($e = e_0 = 0$) is obtained due to the cancellation lemma (Lemma 4.6 in [14]), which reads

$$q \geq \frac{1}{2}(H(C) + H(C|Y)). \quad (90)$$

In the case where the unlimited amount of entanglement is available, the converse bounds on the quantum communication cost in the one-shot and the asymptotic scenarios read

$$q \geq \frac{1}{2}(H_{\min}^{\epsilon}(C) + H_{\min}^{\epsilon}(C|Y) - \Delta^{\epsilon, \delta}) - 6f(\epsilon), \quad (91)$$

$$q \geq \frac{1}{2}(H(C) + H(C|Y) - \tilde{\Delta}) + \frac{1}{2} \log(1 - 22\epsilon - 16\sqrt{\delta}). \quad (92)$$

The asymptotic result (90) coincides with Theorem 7 in [4], and (92) is similar to Theorem 5 therein. It is left open, however, whether the quantity $\tilde{\Delta}$ is equal to the function $I_{(n, \delta)}$ that appears in Theorem 5 of [4] (see Definition 2 in the literature).

4.2.3 Fully Classical Slepian-Wolf

In the fully classical scenario, the Slepian-Wolf problem is given by $B = C = \emptyset$ in addition to $X = A = \emptyset$, and $q = e = e_0 = 0$. The one-shot achievability is given by

$$c \geq H_{\max}^{\epsilon}(Z|Y) - \log \frac{\delta^2}{2}, \quad (93)$$

and the one-shot converse bound reads

$$c \geq H_{\min}^{\epsilon}(YZ) - H_{\min}^{12\epsilon+6\sqrt{\delta}}(Y) - f(\epsilon), \quad (94)$$

which are equivalent to the result obtained in [22]. It is easy to show that the well-known achievable rate region $c \geq H(Z|Y)$ follows from Theorem 4.

4.3 Quantum State Redistribution with Classical Side Information at The Decoder

We consider a scenario in which $X = Z = \emptyset$ and $c = 0$. This scenario can be regarded as a generalization of the fully quantum state redistribution, that incorporates classical side information at the

decoder [3]. The one-shot direct bound is represented by

$$2q \geq \max\{\tilde{H}_I^{(3\epsilon/2, \epsilon/2)}, \tilde{H}_{II}^{(\epsilon/2)}\} - \log(\delta^4/2), \quad (95)$$

$$q + e \geq H_{\max}^{\epsilon/2}(C|BY) - \log(\delta^2/2), \quad (96)$$

$$e_0 \geq \frac{1}{2}(H_{\max}^{\epsilon^2/8}(C) - H_{\max}^{3\epsilon/2}(C|BY)) + \log \delta, \quad (97)$$

where

$$\tilde{H}_I^{(3\epsilon/2, \epsilon/2)} := H_*^{(3\epsilon/2, \epsilon/2)}(C|AY) + H_{\max}^{\epsilon/2}(C|BY), \quad (98)$$

$$\tilde{H}_{II}^{(\epsilon/2)} := H_{\max}^{\epsilon/2}(C|A) + H_{\max}^{\epsilon/2}(C|BY). \quad (99)$$

The converse bound is also obtained from Theorem 3. The inner and outer bounds for the achievable rate region in the asymptotic limit is given by

$$2q \geq \tilde{H}_{II}, \quad (100)$$

$$q + e \geq H(C|BY), \quad (101)$$

$$e_0 \geq \frac{1}{2}I(C : BY), \quad (102)$$

and

$$2q \geq \max\{\tilde{H}_I, \tilde{H}_{II} - \tilde{\Delta}\}, \quad (103)$$

$$q + e \geq H(C|BY), \quad (104)$$

respectively, where

$$\tilde{H}_I := H(C|AY) + H(C|BY), \quad (105)$$

$$\tilde{H}_{II} := H(C|A) + H(C|BY). \quad (106)$$

We may also obtain its descendants by further assuming $A = 0$ or $B = 0$, which are generalizations of the fully quantum Slepian-Wolf and quantum state splitting.

It is expected that various quantum communication protocols with classical side information only at the decoder are obtained by reduction from the above result, similarly to the family of quantum protocols [1, 12]. We, however, leave this problem as a future work.

5 Proof of The Direct Part (Theorem 2)

We prove Theorem 2 based on the following propositions:

Proposition 6 *A tuple (c, q, e, e_0) is achievable within the error $4\sqrt{12}\epsilon + 6\delta$ for Ψ_s if $d_C \geq 2$ and it holds that*

$$c + q - e \geq H_{\max}^{\epsilon}(CZ|AX)_{\Psi_s} - \log \frac{\delta^2}{2}, \quad (107)$$

$$q - e \geq H_{\max}^{\epsilon}(C|AXYZ)_{\Psi_s} - \log \delta^2, \quad (108)$$

$$c + q + e \geq H_{\max}^{\epsilon}(CZ|BY)_{\Psi_s} - \log \frac{\delta^2}{2}, \quad (109)$$

$$q + e \geq H_{\max}^{\epsilon}(C|BXYZ)_{\Psi_s} - \log \delta^2, \quad (110)$$

$$e_0 = \frac{1}{2}(\log d_C - q - e). \quad (111)$$

In the case where $d_C = 1$ and $q = e = e_0 = 0$, the classical communication rate c is achievable within the error δ if it holds that

$$c \geq \max\{H_{\max}^{\epsilon}(Z|AX)_{\Psi_s}, H_{\max}^{\epsilon}(Z|BY)_{\Psi_s}\} - \log \frac{\delta^2}{2}. \quad (112)$$

Proposition 7 *A tuple (c, q, e, e_0) is achievable within an error $4\sqrt{12}\epsilon + 6\delta$ for Ψ_s if $d_C \geq 2$ and it holds that*

$$c + 2q \geq \max\{\tilde{H}_I^{(\epsilon)}, \tilde{H}_{II}^{(\epsilon)}\} - \log(\delta^4/2), \quad (113)$$

$$c + q + e \geq H_{\max}^{\epsilon}(CZ|BY)_{\Psi_s} - \log(\delta^2/2), \quad (114)$$

$$q + e \geq H_{\max}^{\epsilon}(C|BXYZ)_{\Psi_s} - \log \delta^2, \quad (115)$$

$$e_0 \geq \frac{1}{2}(\log d_C - H_{\max}^{\epsilon}(C|BXYZ)_{\Psi_s}) + \log \delta, \quad (116)$$

where

$$\tilde{H}_I^{(\epsilon)} := H_*^{\epsilon}(C|AXYZ)_{\Psi_s} + H_{\max}^{\epsilon}(CZ|BY)_{\Psi_s}, \quad (117)$$

$$\tilde{H}_{II}^{(\epsilon)} := H_{\max}^{\epsilon}(C|AXZ)_{\Psi_s} + H_{\max}^{\epsilon}(C|BXYZ)_{\Psi_s} \quad (118)$$

and

$$H_*^{\epsilon}(C|AXYZ)_{\rho} := \max\{H_{\min}^{\epsilon}(C|AXYZ)_{\rho}, H_{\max}^{\epsilon}(C|AXYZ)_{\rho}\}. \quad (119)$$

In the case where $d_C = 1$, a tuple $(c, 0, 0, 0)$ is achievable for Ψ_s within the error δ if it holds that

$$c \geq H_{\max}^{\epsilon}(Z|BY)_{\Psi_s} - \log \frac{\delta^2}{2}. \quad (120)$$

Proofs of Proposition 6 and Proposition 7 will be given in the following subsections. In Section 5.1, we prove the *partial bi-decoupling theorem*, which is a generalization of the bi-decoupling theorem [36, 7]. Based on this result, we prove Proposition 6 in Section 5.2. We adopt the idea that a protocol for state redistribution can be constructed from sequentially combining protocols for the (fully quantum) reverse Shannon and the (fully quantum) Slepian-Wolf. In Section 5.3, we extend the rate region in Proposition 6 by incorporating teleportation and dense coding, thereby proving Proposition 7. Finally, we prove Theorem 2 from Proposition 7 in Section 5.4.

5.1 Partial Bi-Decoupling

The idea of the bi-decoupling theorem was first introduced in [36], and was improved in [7] to fit more into the framework of the one-shot information theory. The approach in [7] is based on the decoupling theorem in [15]. In this subsection, we generalize those results by using the direct part of randomized partial decoupling [33] to incorporate the hybrid communication scenario.

5.1.1 Direct Part of Partial Decoupling

We first present the direct part of randomized partial decoupling (Theorem 3 in [33]). Let $\Psi^{\hat{C}\hat{S}}$ be a subnormalized state in the form of

$$\Psi^{\hat{C}\hat{S}} = \sum_{j,k=1}^J |j\rangle\langle k|^Z \otimes \psi_{jk}^{CS} \otimes |j\rangle\langle k|^{Z'}. \quad (121)$$

Here, Z and Z' are J -dimensional quantum system with a fixed orthonormal basis $\{|j\rangle\}_{j=1}^J$, $\hat{C} \equiv ZC$, $\hat{S} \equiv Z'S$ and $\psi_{jk} \in \mathcal{L}(\mathcal{H}^C \otimes \mathcal{H}^S)$ for each j and k . Note that the positive-semidefiniteness of $\Psi^{\hat{C}\hat{S}}$ implies $\psi_{jj} \geq 0$ for all j and the subnormalization condition implies $\sum_{j=1}^J \text{Tr}[\psi_{jj}] \leq 1$. Consider a random unitary U on \hat{C} in the form of

$$U := \sum_{j=1}^J |j\rangle\langle j|^Z \otimes U_j^C, \quad (122)$$

where $U_j \sim \mathsf{H}_j$ for each j , and H_j is the Haar measure on the unitary group on \mathcal{H}^C . The averaged state obtained after the action of the random

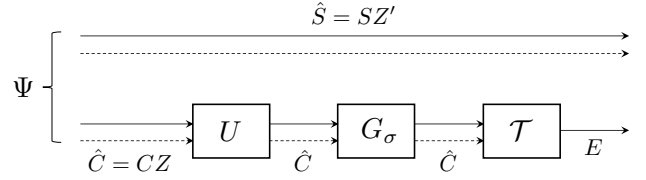

Figure 4: The situation of partial decoupling is depicted.

unitary U is given by

$$\begin{aligned} \Psi_{\text{av}}^{\hat{C}\hat{S}} &:= \mathbb{E}_U [U^{\hat{C}} (\Psi^{\hat{C}\hat{S}}) U^{\dagger \hat{C}}] \\ &= \sum_{j=1}^J p_j |j\rangle\langle j|^Z \otimes \pi^C \otimes \psi_j^S \otimes |j\rangle\langle j|^{Z'}, \end{aligned} \quad (123)$$

where $p_j := \text{Tr}[\psi_{jj}]$ and $\psi_j := p_j^{-1} \psi_{jj}$. Consider also the permutation group \mathbb{P} on $[1, \dots, J]$, and define a unitary G_σ for any $\sigma \in \mathbb{P}$ by

$$G_\sigma := \sum_{j=1}^J |\sigma(j)\rangle\langle j|^Z. \quad (125)$$

We assume that the permutation σ is chosen at random according to the uniform distribution on \mathbb{P} .

Suppose that the state $\Psi^{\hat{C}\hat{S}}$ is transformed by unitaries U and G_σ , and then is subject to the action of a quantum channel (linear CP map) $\mathcal{T}^{\hat{C} \rightarrow E}$ (see Figure 4). The final state is represented as

$$\begin{aligned} &\mathcal{T}^{\hat{C} \rightarrow E} ((G_\sigma^Z U^{\hat{C}}) \Psi^{\hat{C}\hat{S}} (G_\sigma^Z U^{\hat{C}})^\dagger) \\ &= \mathcal{T}^{\hat{C} \rightarrow E} \circ \mathcal{G}_\sigma^Z \circ \mathcal{U}^{\hat{C}} (\Psi^{\hat{C}\hat{S}}). \end{aligned} \quad (126)$$

We consider how close the final state is, on average over all U , to the averaged final state $\mathcal{T}^{\hat{C} \rightarrow E} \circ \mathcal{G}_\sigma^Z (\Psi_{\text{av}}^{\hat{C}\hat{S}})$, for typical choices of the permutation σ . The following theorem is the direct part of the randomized partial decoupling theorem, which provides an upper bound on the average distance between $\mathcal{T}^{\hat{C} \rightarrow E} \circ \mathcal{G}_\sigma^Z \circ \mathcal{U}^{\hat{C}} (\Psi^{\hat{C}\hat{S}})$ and $\mathcal{T}^{\hat{C} \rightarrow E} \circ \mathcal{G}_\sigma^Z (\Psi_{\text{av}}^{\hat{C}\hat{S}})$. Although the original version in [33] is applicable to any $J \geq 1$, in this paper we assume that $J \geq 2$.

Lemma 8 (Corollary of Theorem 3 in [33]) *Consider a subnormalized state $\Psi^{\hat{C}\hat{S}} \in \mathcal{S}_{\leq}(\mathcal{H}^{\hat{C}\hat{S}})$ that is decomposed as (121). Let $\mathcal{T}^{\hat{C} \rightarrow E}$ be a linear trace non-increasing CP map with the complementary channel $\mathcal{T}^{\hat{C} \rightarrow F}$. Let U and G_σ be random unitaries given by (122) and (125),*

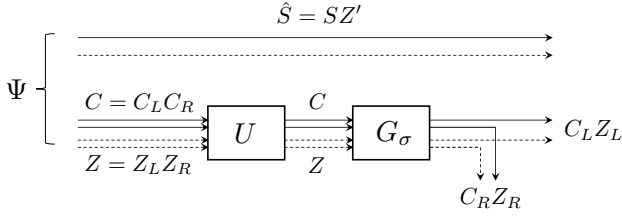

Figure 5: The situation of partial decoupling under partial trace is depicted.

respectively, and fix arbitrary $\epsilon, \mu \geq 0$. It holds that

$$\begin{aligned} & \mathbb{E}_{\sigma, U} \left[\left\| \mathcal{T}^{\hat{C} \rightarrow E} \circ \mathcal{G}_\sigma^Z \circ \mathcal{U}^{\hat{C}}(\Psi^{\hat{C}\hat{S}}) \right. \right. \\ & \quad \left. \left. - \mathcal{T}^{\hat{C} \rightarrow E} \circ \mathcal{G}_\sigma^Z(\Psi_{\text{av}}^{\hat{C}\hat{S}}) \right\|_1 \right] \\ & \leq \begin{cases} 2^{-\frac{1}{2}H_I} + 2^{-\frac{1}{2}H_{II}} + 4(\epsilon + \mu + \epsilon\mu) & (d_C \geq 2), \\ 2^{-\frac{1}{2}H_I} + 4(\epsilon + \mu + \epsilon\mu) & (d_C = 1), \end{cases} \end{aligned} \quad (127)$$

where $\Psi_{\text{av}}^{\hat{C}\hat{S}} := \mathbb{E}_U[\mathcal{U}^{\hat{C}}(\Psi^{\hat{C}\hat{S}})]$. The exponents H_I and H_{II} are given by

$$H_I = \log(J-1) + H_{\min}^\epsilon(\hat{C}|\hat{S})_\Psi - H_{\max}^\mu(\hat{C}|F)_{\mathcal{C}(\tau)}, \quad (128)$$

$$H_{II} = H_{\min}^\epsilon(\hat{C}|\hat{S})_{\mathcal{C}(\Psi)} - H_{\max}^\mu(C|FZ)_{\mathcal{C}(\tau)}. \quad (129)$$

Here, \mathcal{C} is the completely dephasing operation on Z with respect to the basis $\{|j\rangle\}_{j=1}^J$, and τ is the Choi-Jamiolkowski state of $\mathcal{T}^{\hat{C} \rightarrow F}$ defined by $\tau^{\hat{C}F} := \mathcal{T}^{\hat{C} \rightarrow F}(\Phi^{\hat{C}\hat{C}'})$. The state $\Phi^{\hat{C}\hat{C}'}$ is the maximally entangled state in the form of

$$|\Phi\rangle^{\hat{C}\hat{C}'} = \frac{1}{\sqrt{J}} \sum_{j=1}^J |jj\rangle^{ZZ'} |\Phi_r\rangle^{CC'}. \quad (130)$$

5.1.2 Partial Decoupling under Partial Trace

We apply Lemma 8 to a particular case where the channel \mathcal{T} is the partial trace (see Figure 5).

Lemma 9 Consider the same setting as in Lemma 8, and suppose that $Z = Z_L Z_R$, $C = C_L C_R$. We assume that Z_L and Z_R are equipped with fixed orthonormal bases $\{|z_L\rangle\}_{z_L=1}^{J_L}$ and $\{|z_R\rangle\}_{z_R=1}^{J_R}$, respectively, thus $J = J_L J_R$ and the orthonormal basis of Z is given by $\{|z_L\rangle|z_R\rangle\}_{z_L, z_R}$. Fix arbitrary $\epsilon \geq 0$. If $d_C \geq 2$

and

$$\log \frac{d_{C_L}^2}{d_{Z_R} d_C} \leq H_{\min}^\epsilon(\hat{C}|\hat{S})_\Psi + \log \frac{\delta^2}{2}, \quad (131)$$

$$\log \frac{d_{C_L}^2}{d_C} \leq H_{\min}^\epsilon(\hat{C}|\hat{S})_{\mathcal{C}(\Psi)} + \log \delta^2, \quad (132)$$

then it holds that

$$\begin{aligned} & \mathbb{E}_{\sigma, U} \left\| \text{Tr}_{Z_R C_R} \circ \mathcal{G}_\sigma^Z \circ \mathcal{U}^{\hat{C}}(\Psi^{\hat{C}\hat{S}}) \right. \\ & \quad \left. - \text{Tr}_{Z_R C_R} \circ \mathcal{G}_\sigma^Z(\Psi_{\text{av}}^{\hat{C}\hat{S}}) \right\|_1 \leq 4\epsilon + 2\delta, \end{aligned} \quad (133)$$

where $\Psi_{\text{av}}^{\hat{C}\hat{S}} := \mathbb{E}_{U \sim \mathcal{H}_\times}[\mathcal{U}^{\hat{C}}(\Psi^{\hat{C}\hat{S}})]$. The same statement also holds in the case of $d_C = 1$, in which case the condition (132) can be removed.

Proof: We apply Lemma 8 by the correspondence $\mu = 0$, $E = Z_L C_L$, $F = Z_R C_R$, $J = d_Z$ and $\mathcal{T}^{\hat{C} \rightarrow Z_L C_L} = \text{id}^{Z_L C_L} \otimes \text{Tr}_{Z_R C_R}$. It follows that Ineq. (133) holds if $d_C \geq 2$ and

$$\begin{aligned} & \log(d_Z - 1) + H_{\min}^\epsilon(\hat{C}|\hat{S})_\Psi \\ & \quad - H_{\max}(\hat{C}|Z'_R C'_R)_{\mathcal{C}(\tau)} + \log \delta^2 \geq 0, \end{aligned} \quad (134)$$

$$\begin{aligned} & H_{\min}^\epsilon(\hat{C}|\hat{S})_{\mathcal{C}(\Psi)} - H_{\max}(C|Z'_R C'_R Z)_{\mathcal{C}(\tau)} \\ & \quad + \log \delta^2 \geq 0. \end{aligned} \quad (135)$$

Here, τ is the Choi-Jamiolkowski state of the complementary channel of $\mathcal{T}^{\hat{C} \rightarrow Z_L C_L}$, and is given by

$$\tau^{\hat{C}Z'_R C'_R} = \pi^{Z_L} \otimes \pi^{C_L} \otimes \Phi^{Z_R Z'_R} \otimes \Phi^{C_R C'_R}. \quad (136)$$

Using the additivity of the max conditional entropy (Lemma 15 in Appendix A), the entropies are calculated to be

$$\begin{aligned} & H_{\max}(\hat{C}|Z'_R C'_R)_{\mathcal{C}(\tau)} \\ & \quad = \log d_{Z_L} + \log d_{C_L} - \log d_{C_R}, \end{aligned} \quad (137)$$

$$\begin{aligned} & H_{\max}(C|Z'_R C'_R Z)_{\mathcal{C}(\tau)} \\ & \quad = \log d_{C_L} - \log d_{C_R}. \end{aligned} \quad (138)$$

Thus, Inequalities (134) and (135) are equivalent to

$$\begin{aligned} & \log(d_Z - 1) + H_{\min}^\epsilon(\hat{C}|\hat{S})_\Psi \\ & \quad - \log \frac{d_{Z_L} d_{C_L}}{d_{C_R}} + \log \delta^2 \geq 0, \end{aligned} \quad (139)$$

$$H_{\min}^\epsilon(\hat{C}|\hat{S})_{\mathcal{C}(\Psi)} - \log \frac{d_{C_L}}{d_{C_R}} + \log \delta^2 \geq 0. \quad (140)$$

Noting that $d_Z = d_{Z_L} d_{Z_R}$, $d_C = d_{C_L} d_{C_R}$ and that $(d_Z - 1)/d_Z \geq 1/2$, the above two inequalities follow from (131) and (132), respectively.

Thus, the proof in the case of $d_C \geq 2$ is done. The proof for the case of $d_C = 1$ proceeds along the same line. ■

5.1.3 Partial Bi-Decoupling Theorem

Based on Lemma 9, we introduce a generalization of the ‘‘bi-decoupling theorem’’[36, 7] that played a crucial role in the proof of the direct part of one-shot fully quantum state redistribution. We consider the case where systems C and S are composed of three subsystems. The following lemma provides a sufficient condition under which a *single* pair of σ and U simultaneously achieves partial decoupling of a state, from the viewpoint of two different choices of subsystems (see Figure 6 in the next page).

Lemma 10 (Partial bi-decoupling.) *Consider the same setting as in Lemma 8, assume $Z = Z_L Z_R$, $C = C_1 C_2 C_3$, $S = S_1 S_2 S_3$ and fix arbitrary $\epsilon \geq 0$. If $d_C \geq 2$ and*

$$\log \frac{d_{C_1}^2}{d_{Z_R} d_C} \leq H_{\min}^{\epsilon}(\hat{C}|Z'S_2 S_3)_{\Psi} + \log \frac{\delta^2}{2}, \quad (141)$$

$$\log \frac{d_{C_1}^2}{d_C} \leq H_{\min}^{\epsilon}(\hat{C}|Z'S_2 S_3)_{C(\Psi)} + \log \delta^2, \quad (142)$$

$$\log \frac{d_{C_2}^2}{d_{Z_R} d_C} \leq H_{\min}^{\epsilon}(\hat{C}|Z'S_1 S_3)_{\Psi} + \log \frac{\delta^2}{2}, \quad (143)$$

$$\log \frac{d_{C_2}^2}{d_C} \leq H_{\min}^{\epsilon}(\hat{C}|Z'S_1 S_3)_{C(\Psi)} + \log \delta^2, \quad (144)$$

there exist σ and U such that

$$\begin{aligned} & \left\| \text{Tr}_{Z_R C_2 C_3} \circ \mathcal{G}_{\sigma}^Z \circ \mathcal{U}^{\hat{C}}(\Psi^{\hat{C} S_2 S_3 Z'}) \right. \\ & \quad \left. - \text{Tr}_{Z_R C_2 C_3} \circ \mathcal{G}_{\sigma}^Z(\Psi_{\text{av}}^{\hat{C} S_2 S_3 Z'}) \right\|_1 \leq 12\epsilon + 6\delta, \end{aligned} \quad (145)$$

$$\begin{aligned} & \left\| \text{Tr}_{Z_R C_1 C_3} \circ \mathcal{G}_{\sigma}^Z \circ \mathcal{U}^{\hat{C}}(\Psi^{\hat{C} S_1 S_3 Z'}) \right. \\ & \quad \left. - \text{Tr}_{Z_R C_1 C_3} \circ \mathcal{G}_{\sigma}^Z(\Psi_{\text{av}}^{\hat{C} S_1 S_3 Z'}) \right\|_1 \leq 12\epsilon + 6\delta. \end{aligned} \quad (146)$$

The same statement also holds if $d_C = 1$, in which case the conditions (142) and (144) can be removed.

Proof: Suppose that $d_C \geq 2$ and the inequalities (141)-(144) are satisfied. We apply Lemma 9 under the correspondence $C_R = C_{\alpha} C_3$, $S = S_{\alpha} S_3$

and $C_L = C_{\bar{\alpha}}$, where $\alpha = 1, 2$ and $\bar{\alpha} = 2, 1$ for each. It follows that

$$\begin{aligned} & \mathbb{E}_{\sigma, U} \left\| \text{Tr}_{Z_R C_{\alpha} C_3} \circ \mathcal{G}_{\sigma}^Z \circ \mathcal{U}^{\hat{C}}(\Psi^{\hat{C} S_{\alpha} S_3 Z'}) \right. \\ & \quad \left. - \text{Tr}_{Z_R C_{\alpha} C_3} \circ \mathcal{G}_{\sigma}^Z(\Psi_{\text{av}}^{\hat{C} S_{\alpha} S_3 Z'}) \right\|_1 \leq 4\epsilon + 2\delta. \end{aligned} \quad (147)$$

Markov’s inequality implies that there exist σ and U that satisfy both (145) and (146), which completes the proof in the case of $d_C \geq 2$. The proof in the case of $d_C = 1$ proceeds along the same line. ■

5.2 Proof of Proposition 6

To prove Proposition 6, we follow the lines of the proof of the direct part of the fully quantum state redistribution protocol in [36]. The key idea is that a protocol for state redistribution can be constructed from sequentially combining a protocol for the fully quantum reverse Shannon and that for the fully quantum Slepian-Wolf. We generalize this idea to the ‘‘hybrid’’ scenario (see Figure 9 in page 34). We only consider the case where $d_C \geq 2$. The proof for the case of $d_C = 1$ is obtained along the same line.

5.2.1 Application of The Partial Bi-Decoupling Theorem

Consider the ‘‘purified’’ source state

$$\begin{aligned} |\Psi\rangle^{ABCRXYZT} := & \sum_{x,y,z} \sqrt{p_{xyz}} |x\rangle^X |y\rangle^Y |z\rangle^Z |\psi_{xyz}\rangle^{ABCR} |xyz\rangle^T, \end{aligned} \quad (148)$$

where we denoted $X'Y'Z'$ simply by T . Let C be isomorphic to $C_1 C_2 C_3$ and Z to $Z_L Z_R$. Fix an arbitrary $\epsilon > 0$. We apply Lemma 10 under the following correspondence:

$$S_1 = \hat{A}, \quad S_2 = \hat{B}, \quad S_3 = RX'Y'. \quad (149)$$

Note that $\hat{R} = RX'Y'Z'$. It follows that if the dimensions of C_1 and C_2 are sufficiently small (see the next subsection for the details), there exist σ

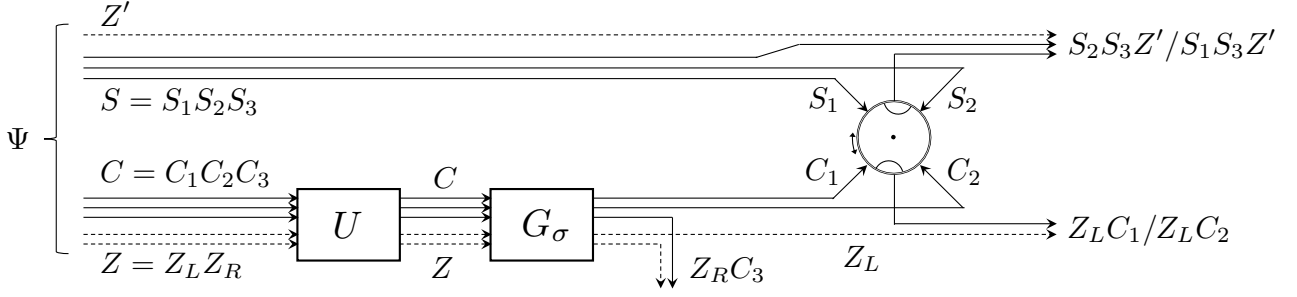

Figure 6: The situation of partial bi-decoupling is depicted. As represented by the rotary, we consider two cases where $S_1 C_2$ or $S_2 C_1$ are traced out.

and U that satisfy

$$\left\| \text{Tr}_{Z_R C_2 C_3} \circ \mathcal{G}_\sigma^Z \circ \mathcal{U}^{\hat{C}}(\Psi^{\hat{C}\hat{B}\hat{R}}) - \text{Tr}_{Z_R C_2 C_3} \circ \mathcal{G}_\sigma^Z(\Psi_{\text{av}}^{\hat{C}\hat{B}\hat{R}}) \right\|_1 \leq 12\epsilon + 6\delta, \quad (150)$$

$$\left\| \text{Tr}_{Z_R C_1 C_3} \circ \mathcal{G}_\sigma^Z \circ \mathcal{U}^{\hat{C}}(\Psi^{\hat{C}\hat{A}\hat{R}}) - \text{Tr}_{Z_R C_1 C_3} \circ \mathcal{G}_\sigma^Z(\Psi_{\text{av}}^{\hat{C}\hat{A}\hat{R}}) \right\|_1 \leq 12\epsilon + 6\delta. \quad (151)$$

Let $|\Psi_{\sigma,1}\rangle^{C_1 Z_L \hat{B} \hat{R} D_A}$ be a purification of $\text{Tr}_{Z_R C_2 C_3} \circ \mathcal{G}_\sigma^Z(\Psi_{\text{av}}^{\hat{C}\hat{B}\hat{R}})$ with D_A being the purifying system. Similarly, let $|\Psi_{\sigma,2}\rangle^{C_2 Z_L \hat{A} \hat{R} D_B}$ be a purification of $\text{Tr}_{Z_R C_1 C_3} \circ \mathcal{G}_\sigma^Z(\Psi_{\text{av}}^{\hat{C}\hat{A}\hat{R}})$ with D_B being the purifying system. Due to Uhlmann's theorem ([30]; see also e.g. Chapter 9 in [34]), there exist linear isometries

$$V^{D_A \rightarrow Z_R C_2 C_3 \hat{A}}, \quad W^{Z_R C_1 C_3 \hat{B} \rightarrow D_B} \quad (152)$$

such that

$$\left\| \mathcal{G}_\sigma^Z \circ \mathcal{U}^{\hat{C}}(\Psi^{\hat{C}\hat{A}\hat{B}\hat{R}}) - V^{D_A \rightarrow Z_R C_2 C_3 \hat{A}}(\Psi_{\sigma,1}) \right\|_1 \leq 2\sqrt{12\epsilon + 6\delta}, \quad (153)$$

$$\left\| W^{Z_R C_1 C_3 \hat{B} \rightarrow D_B} \circ \mathcal{G}_\sigma^Z \circ \mathcal{U}^{\hat{C}}(\Psi^{\hat{C}\hat{A}\hat{B}\hat{R}}) - \Psi_{\sigma,2} \right\|_1 \leq 2\sqrt{12\epsilon + 6\delta}. \quad (154)$$

We particularly choose C_1, C_2, C_3 and Z_R so that they satisfy the isomorphism

$$C_1 \cong E_B, C_2 \cong F_A, C_3 \cong Q, Z_R \cong M. \quad (155)$$

In addition, we introduce systems C'', Z'', A_1 and B_2 such that

$$C'' \cong C, Z'' \cong Z, A_1 \cong E_A, B_2 \cong F_B. \quad (156)$$

We consider the purifying systems to be $D_A \equiv Z_R \hat{C}'' \hat{A} A_1$ and $D_B \equiv Z_R \hat{C}'' \hat{B} B_2$, where $\hat{C}'' = C'' Z''$.

5.2.2 Explicit Forms of The Purifications

To obtain explicit forms of the purifications $\Psi_{\sigma,1}$ and $\Psi_{\sigma,2}$, we define a state Ψ_σ by

$$|\Psi_\sigma\rangle^{\hat{A}\hat{B}\hat{C}''\hat{R}Z} := \sum_{x,y,z} \sqrt{p_{xyz}} |x\rangle^X |y\rangle^Y |\sigma(z)\rangle^Z |z\rangle^{Z''} \otimes |\psi_{xyz}\rangle^{ABC''R} |xyz\rangle^T. \quad (157)$$

From the definition (20) of the source state Ψ_s , (148) of the purified source state Ψ and (157) of the state Ψ_σ , it is straightforward to verify that the states are related simply by

$$|\Psi_\sigma\rangle^{\hat{A}\hat{B}\hat{C}''\hat{R}Z} = G_\sigma^Z \circ P^{Z'' \rightarrow Z''Z} |\Psi\rangle^{\hat{A}\hat{B}\hat{C}''\hat{R}} \quad (158)$$

and

$$\text{Tr}_Z \otimes \mathcal{C}^T(\Psi_\sigma^{\hat{A}\hat{B}\hat{C}''\hat{R}Z}) = \Psi_s^{\hat{A}\hat{B}\hat{C}''\hat{R}} \quad (159)$$

$$= \mathcal{C}^T(\Psi^{\hat{A}\hat{B}\hat{C}''\hat{R}}). \quad (160)$$

Here, Let $P^{Z'' \rightarrow Z''Z}$ be a linear isometry defined by

$$P^{Z'' \rightarrow Z''Z} := \sum_z |z\rangle^{Z''} |z\rangle^Z \langle z|^{Z''}, \quad (161)$$

and \mathcal{C} be the completely dephasing operation on T with respect to the basis $\{|xyz\rangle\}_{x,y,z}$. The state Ψ_σ is simply represented as

$$|\Psi_\sigma\rangle^{\hat{A}\hat{B}\hat{C}''\hat{R}Z} = \sum_z \sqrt{p_z} |\sigma(z)\rangle^Z |\psi_z\rangle^{\hat{A}\hat{B}\hat{C}''R X' Y'} |z\rangle^{Z'}. \quad (162)$$

where

$$|\psi_z\rangle^{\hat{A}\hat{B}\hat{C}''R X' Y'} := \sum_{x,y} \sqrt{\frac{p_{xyz}}{p_z}} |x\rangle^X |y\rangle^Y |z\rangle^{Z''} \otimes |\psi_{xyz}\rangle^{ABC''R} |x\rangle^{X'} |y\rangle^{Y'}. \quad (163)$$

It is convenient to note that

$$\psi_z^{\hat{A}\hat{B}\hat{R}X'Y'} = \sum_{x,y} \sqrt{\frac{p_{xyz}}{p_z}} \psi_{xyz}^{ABR} \otimes |x\rangle\langle x|^{X'} \otimes |y\rangle\langle y|^{Y'}. \quad (164)$$

Due to (148) and (124), the averaged state in (150) is calculated to be

$$\Psi_{\text{av}}^{\hat{C}\hat{B}\hat{R}} = \sum_z p_z |z\rangle\langle z|^Z \otimes \pi^C \otimes \psi_z^{\hat{B}\hat{R}X'Y'} \otimes |z\rangle\langle z|^{Z'}, \quad (165)$$

where $p_z = \sum_{x,y} p_{xyz}$. It follows that

$$\begin{aligned} & \text{Tr}_{Z_R C_2 C_3} \circ \mathcal{G}_\sigma^Z(\Psi_{\text{av}}^{\hat{C}\hat{B}\hat{R}}) \\ &= \sum_z p_z \text{Tr}_{Z_R} [|\sigma(z)\rangle\langle\sigma(z)|] \otimes \pi^{C_1} \\ & \quad \otimes \psi_z^{\hat{B}\hat{R}X'Y'} \otimes |z\rangle\langle z|^{Z'}. \end{aligned} \quad (166)$$

Thus, a purification $\Psi_{\sigma,1}$ of this state is given by

$$|\Psi_{\sigma,1}\rangle^{\hat{A}\hat{B}\hat{C}''\hat{R}A_1C_1Z} = |\Psi_\sigma\rangle^{\hat{A}\hat{B}\hat{C}''\hat{R}Z} |\phi_1\rangle^{A_1C_1}, \quad (167)$$

where ϕ_1 is the maximally entangled state of Schmidt rank d_{C_1} . In the same way, the purification $\Psi_{\sigma,2}$ is given by

$$|\Psi_{\sigma,2}\rangle^{\hat{A}\hat{B}\hat{C}''\hat{R}B_2C_2Z} = |\Psi_\sigma\rangle^{\hat{A}\hat{B}\hat{C}''\hat{R}Z} |\phi_2\rangle^{B_2C_2}, \quad (168)$$

with ϕ_2 being the maximally entangled state of Schmidt rank d_{C_2} . Substituting these to (153) and (154), we arrive at

$$\begin{aligned} & \left\| \Psi^{\hat{C}\hat{A}\hat{B}\hat{R}} - (\mathcal{G}_\sigma^Z \circ \mathcal{U}^{\hat{C}})^\dagger \circ \mathcal{V}(\Psi_\sigma^{\hat{A}\hat{B}\hat{C}''\hat{R}} \otimes \phi_1^{A_1C_1}) \right\|_1 \\ & \leq 2\sqrt{12\epsilon + 6\delta}, \quad (169) \\ & \left\| \mathcal{W} \circ \mathcal{G}_\sigma^Z \circ \mathcal{U}^{\hat{C}}(\Psi^{\hat{C}\hat{A}\hat{B}\hat{R}}) - \Psi_\sigma^{\hat{A}\hat{B}\hat{C}''\hat{R}Z} \otimes \phi_2^{B_2C_2} \right\|_1 \\ & \leq 2\sqrt{12\epsilon + 6\delta}. \quad (170) \end{aligned}$$

Inequality (169) implies that the operation $(\mathcal{G}_\sigma^Z \circ \mathcal{U}^{\hat{C}})^\dagger \circ \mathcal{V}$ is a reverse Shannon protocol for the state $\Psi^{\hat{C}\hat{A}(\hat{B}\hat{R})}$, up to the action of a linear isometry $G_\sigma^Z \circ P^{Z'' \rightarrow Z''Z}$ by which Ψ_σ is obtained from Ψ as (158). Similarly, Inequality (170) implies that the operation $\mathcal{W} \circ \mathcal{G}_\sigma^Z \circ \mathcal{U}^{\hat{C}}$ is a Slepian-Wolf protocol for the state $\Psi^{\hat{C}\hat{B}(\hat{A}\hat{R})}$, up to the action of $G_\sigma^Z \circ P^{Z'' \rightarrow Z''Z}$ (see Figure 9 in page 34). We combine the two protocols to cancel out $(\mathcal{G}_\sigma^Z \circ \mathcal{U}^{\hat{C}})^\dagger$ and $\mathcal{G}_\sigma^Z \circ \mathcal{U}^{\hat{C}}$. Due to the triangle inequality, it follows from (169) and (170) that

$$\begin{aligned} & \left\| \mathcal{W} \circ \mathcal{V}(\Psi_\sigma^{\hat{A}\hat{B}\hat{C}''\hat{R}} \otimes \phi_1^{A_1C_1}) - \Psi_\sigma^{\hat{A}\hat{B}\hat{C}''\hat{R}Z} \otimes \phi_2^{B_2C_2} \right\|_1 \\ & \leq 4\sqrt{12\epsilon + 6\delta}. \quad (171) \end{aligned}$$

5.2.3 Construction of The Encoding and Decoding Operations

Define a partial isometry

$$\begin{aligned} & V_\sigma^{\hat{A}\hat{C}''A_1 \rightarrow \hat{A}ZC_2C_3} \\ & := V^{Z_R A_1 \hat{A}\hat{C}'' \rightarrow Z_R C_2 C_3 \hat{A}} \circ G_\sigma^Z \circ P^{Z'' \rightarrow Z''Z}. \end{aligned} \quad (172)$$

Applying the map $\text{Tr}_Z \otimes \mathcal{C}^T$ to Inequality (171), and using (158) and (160), it follows that

$$\begin{aligned} & \left\| \text{Tr}_Z \circ \mathcal{W} \circ \mathcal{V}_\sigma(\Psi_s^{\hat{A}\hat{B}\hat{C}''\hat{R}} \otimes \phi_1^{A_1C_1}) \right. \\ & \quad \left. - \Psi_s^{\hat{A}\hat{B}\hat{C}''\hat{R}} \otimes \phi_2^{B_2C_2} \right\|_1 \leq 4\sqrt{12\epsilon + 6\delta}. \end{aligned} \quad (173)$$

We construct a protocol for state redistribution as follows: In the first step, the sender performs the following encoding operation:

$$\begin{aligned} & \mathcal{E}^{\hat{A}\hat{C}''A_1 \rightarrow \hat{A}Z_R C_2 C_3} \\ & = \text{Tr}_{Z_L} \circ \mathcal{V}_\sigma^{\hat{A}\hat{C}''A_1 \rightarrow \hat{A}ZC_2C_3} \circ \mathcal{C}^{Z''}, \end{aligned} \quad (174)$$

where $\mathcal{C}^{Z''}$ is the completely dephasing operation on Z'' with respect to the basis $\{|z_L\rangle|z_R\rangle\}_{z_L, z_R}$. The sender then sends the classical system $Z_R \cong M$ and the quantum system $C_3 \cong Q$ to the receiver, who performs the decoding operation defined by

$$\begin{aligned} & \mathcal{D}^{Z_R C_1 C_3 \hat{B} \rightarrow B_2 \hat{B}\hat{C}''} \\ & = \text{Tr}_{Z_R} \circ \mathcal{W}^{Z_R C_1 C_3 \hat{B} \rightarrow Z_R B_2 \hat{B}\hat{C}''}. \end{aligned} \quad (175)$$

Noting that $\text{Tr}_Z = \text{Tr}_{Z_L} \otimes \text{Tr}_{Z_R}$, we obtain from (173) that

$$\begin{aligned} & \left\| \mathcal{D} \circ \mathcal{E}(\Psi_s^{\hat{A}\hat{B}\hat{C}''\hat{R}} \otimes \phi_1^{A_1C_1}) - \Psi_s^{\hat{A}\hat{B}\hat{C}''\hat{R}} \otimes \phi_2^{B_2C_2} \right\|_1 \\ & \leq 4\sqrt{12\epsilon + 6\delta}. \quad (176) \end{aligned}$$

From (172) and (174), it is straightforward to verify that $\mathcal{E}(\tau)$ is diagonal in Z_R for any input state τ . Thus, the pair $(\mathcal{E}, \mathcal{D})$ is a state redistribution protocol for the state Ψ_s within the error $4\sqrt{12\epsilon + 6\delta}$.

5.2.4 Evaluation of Entropies

We analyze conditions on the size of systems C_1 and C_2 , in order that inequalities (150) and (151) are satisfied. We use the partial bi-decoupling

theorem (Lemma 10) under the correspondence (149), which reads

$$S_1 = \hat{A}, \quad S_2 = \hat{B}, \quad S_3 = RX'Y'. \quad (177)$$

It follows that inequalities (150) and (151) are satisfied if it holds that

$$\log \frac{d_{C_1}^2}{d_{Z_R} d_C} \leq H_{\min}^\epsilon(\hat{C}|\hat{B}\hat{R})_\Psi + \log \frac{\delta^2}{2}, \quad (178)$$

$$\log \frac{d_{C_1}^2}{d_C} \leq H_{\min}^\epsilon(\hat{C}|\hat{B}\hat{R})_{\mathcal{C}(\Psi)} + \log \delta^2, \quad (179)$$

$$\log \frac{d_{C_2}^2}{d_{Z_R} d_C} \leq H_{\min}^\epsilon(\hat{C}|\hat{A}\hat{R})_\Psi + \log \frac{\delta^2}{2}, \quad (180)$$

$$\log \frac{d_{C_2}^2}{d_C} \leq H_{\min}^\epsilon(\hat{C}|\hat{A}\hat{R})_{\mathcal{C}(\Psi)} + \log \delta^2. \quad (181)$$

Using the duality of the smooth conditional entropy (Lemma 12), and noting that $\Psi^{\hat{A}\hat{B}\hat{C}} = \Psi_s^{\hat{A}\hat{B}\hat{C}}$, the min entropies in the first and the third inequalities are calculated to be

$$H_{\min}^\epsilon(\hat{C}|\hat{B}\hat{R})_\Psi = -H_{\max}^\epsilon(\hat{C}|\hat{A})_\Psi \quad (182)$$

$$= -H_{\max}^\epsilon(CZ|AX)_{\Psi_s}, \quad (183)$$

$$H_{\min}^\epsilon(\hat{C}|\hat{A}\hat{R})_\Psi = -H_{\max}^\epsilon(\hat{C}|\hat{B})_\Psi \quad (184)$$

$$= -H_{\max}^\epsilon(CZ|BY)_{\Psi_s}. \quad (185)$$

Similarly, due to Lemma 23 and Lemma 26 in Appendix A, and noting that $\mathcal{C}(\Psi) = \Psi_s$ because of (20) and (148), we have

$$\begin{aligned} H_{\min}^\epsilon(\hat{C}|\hat{B}\hat{R})_{\mathcal{C}(\Psi)} &= H_{\min}^\epsilon(C|BRXYZ)_{\mathcal{C}(\Psi)} \\ &= -H_{\max}^\epsilon(C|AXYZ)_{\Psi_s} \end{aligned} \quad (186)$$

$$= -H_{\max}^\epsilon(C|AXYZ)_{\Psi_s} \quad (187)$$

and

$$\begin{aligned} H_{\min}^\epsilon(\hat{C}|\hat{A}\hat{R})_{\mathcal{C}(\Psi)} &= H_{\min}^\epsilon(C|ARXYZ)_{\mathcal{C}(\Psi)} \\ &= -H_{\max}^\epsilon(C|BXYZ)_{\Psi_s}. \end{aligned} \quad (188)$$

$$= -H_{\max}^\epsilon(C|BXYZ)_{\Psi_s}. \quad (189)$$

In addition, the isomorphism (155) implies

$$\log d_{C_1} = e + e_0, \quad \log d_{C_2} = e_0, \quad (190)$$

$$\log d_{C_3} = q, \quad \log d_{Z_R} = c. \quad (191)$$

Substituting these relations to (178)-(181), and noting that $d_C = d_{C_1} d_{C_2} d_{C_3}$, we arrive at

$$c + q - e \geq H_{\max}^\epsilon(CZ|AX)_{\Psi_s} - \log \frac{\delta^2}{2}, \quad (192)$$

$$q - e \geq H_{\max}^\epsilon(C|AXYZ)_{\Psi_s} - \log \delta^2, \quad (193)$$

$$c + q + e \geq H_{\max}^\epsilon(CZ|BY)_{\Psi_s} - \log \frac{\delta^2}{2}, \quad (194)$$

$$q + e \geq H_{\max}^\epsilon(C|BXYZ)_{\Psi_s} - \log \delta^2 \quad (195)$$

and $q + e + 2e_0 = \log d_C$. Combining these all together, we obtain the set of Ineqs. (107)-(111) as a sufficient condition for the tuple (c, q, e) to be achievable within the error $4\sqrt{12\epsilon + 6\delta}$. ■

5.3 Proof of Proposition 7 from Proposition 6

We prove Proposition 7 based on Proposition 6 by (i) modifying the first inequality (107), and (ii) extending the rate region by incorporating teleportation and dense coding.

5.3.1 Modification of Inequalities (107) and (112)

We argue that the smooth conditional max entropy in the R.H.S. of Inequality (107) is modified to be $H_{\max}^\epsilon(C|AXZ)_{\Psi_s}$. Consider a ‘‘modified’’ redistribution protocol as follows: In the beginning of the protocol, the sender prepares a copy of Z , which we denote by \tilde{Z} . The sender then uses $X\tilde{Z}$ as the classical part of the side information, instead of X alone, and apply the protocol presented in Section 5.2.1. The smooth max entropy corresponding to the first term in (107) is then given by (see Lemma 24)

$$H_{\max}^\epsilon(CZ|AX\tilde{Z})_{\Psi_s} = H_{\max}^\epsilon(C|AXZ)_{\Psi_s}. \quad (196)$$

For the same reason, the term $H_{\max}^\epsilon(Z|AX)_{\Psi_s}$ in the condition (112) is modified to be $H_{\max}^\epsilon(Z|AX\tilde{Z})_{\Psi_s}$, which is no greater than zero (see Lemma 21 and Lemma 24). It should be noted that the entropies in the other three inequalities are unchanged by this modification.

5.3.2 Extension of the rate region by Teleportation and Dense Coding

To complete the proof of Theorem 2, we extend the achievable rate region given in Proposition 6 by incorporating teleportation and dense coding. More precisely, we apply the following lemma that follows from teleportation and dense coding (see the next subsection for a proof):

Lemma 11 *Suppose that a rate tuple $(\hat{c}, \hat{q}, \hat{e}, \hat{e}_0)$ is achievable within the error δ . Then, for any $\lambda, \mu \geq 0$ and $e_0 \geq 0$ such that*

$$-\frac{\hat{c}}{2} \leq \lambda - \mu \leq \hat{q}, \quad \hat{e}_0 \leq e_0, \quad (197)$$

the tuple $(c, q, e, e_0) := (\hat{c} + 2\lambda - 2\mu, \hat{q} - \lambda + \mu, \hat{e} + \lambda + \mu, e_0)$ is also achievable within the error δ .

Proof of Proposition 7: Due to Proposition 6 and Lemma 11, a tuple (c, q, e, e_0) is achievable within the error δ if there exists $\lambda, \mu \geq 0$ and $\hat{e}_0 \leq e_0$ such that the tuple

$$(\hat{c}, \hat{q}, \hat{e}, \hat{e}_0) := (c - 2\lambda + 2\mu, q + \lambda - \mu, e - \lambda - \mu, \hat{e}_0) \quad (198)$$

satisfies

$$\hat{c} + \hat{q} - \hat{e} \geq H_1, \quad (199)$$

$$\hat{q} - \hat{e} \geq H_2, \quad (200)$$

$$\hat{c} + \hat{q} + \hat{e} \geq H_3, \quad (201)$$

$$\hat{q} + \hat{e} \geq H_4, \quad (202)$$

$$\hat{q} + \hat{e} + 2\hat{e}_0 = \log d_C \quad (203)$$

and $\hat{c}, \hat{q} \geq 0$. Here, we have denoted the R.H.S.s of Inequalities (108)-(110) by H_2, H_3 and H_4 , respectively, and that of (196) by H_1 . Substituting (198) to these inequalities yields

$$c + q - e \geq H_1 - 2\mu, \quad (204)$$

$$q - e \geq H_2 - 2\lambda, \quad (205)$$

$$c + q + e \geq H_3 + 2\lambda, \quad (206)$$

$$q + e \geq H_4 + 2\mu, \quad (207)$$

$$q + e + 2\hat{e}_0 = \log d_C + 2\mu \quad (208)$$

and

$$c - 2\lambda + 2\mu \geq 0, \quad (209)$$

$$q + \lambda - \mu \geq 0. \quad (210)$$

Thus, it suffices to prove that, for any tuple (c, q, e, e_0) satisfying Inequalities (113)-(116), there exist $\hat{e}_0 \leq e_0$ and $\lambda, \mu \geq 0$ such that the above inequalities hold. This is proved by noting that the inequality (113) is expressed as

$$c + q + e - H_3 \geq \max\{H_2, H_2'\} - q + e, \quad (211)$$

$$q + e - H_4 \geq H_1 - c - q + e, \quad (212)$$

where

$$H_2' := H_{\min}^e(C|AXYZ)_{\Psi_s} - \log \delta^2. \quad (213)$$

The L.H.S. of (211) and (212) are nonnegative because of Inequalities (114) and (115). Thus, there exists $\lambda, \mu \geq 0$ such that 2λ and 2μ are in between both sides in (211) and (212), respectively. This implies (204)-(207). We particularly choose

$$\mu = \frac{1}{2}(q + e - H_4), \quad \hat{e}_0 = \frac{1}{2}(\log d_C - H_4). \quad (214)$$

A simple calculation leads to (208). Noting that $H_3 \geq H_4$ by the data processing inequality, it follows from (206) that

$$c - 2\lambda \geq H_3 - q - e \geq H_4 - q - e = -2\mu, \quad (215)$$

which implies (209). Inequality (210) is obtained by combining (207) with $2\lambda \geq \max\{H_2, H_2'\} - q + e$. Note that

$$\begin{aligned} H_2' + H_4 &= H_{\min}^e(C|AXYZ)_{\Psi_s} \\ &\quad + H_{\max}^e(C|BXYZ)_{\Psi_s} - 2\log \delta^2 \end{aligned} \quad (216)$$

$$= H_{\min}^e(C|AXYZ)_{\Psi_s} - H_{\min}^e(C|ARXYZ)_{\Psi_s} - 2\log \delta^2 \quad (217)$$

$$\geq 0, \quad (218)$$

where the third line follows from Lemma 26. This completes the proof of Theorem 2. \blacksquare

5.3.3 Proof of Lemma 11 (see also Section IV in [18])

We first consider the case where $\lambda - \mu \geq 0$, and prove that the tuple $(c, q, e, e_0, \delta) := (\hat{c} + 2\lambda - 2\mu, \hat{q} - \lambda + \mu, \hat{e} + \lambda + \mu, \hat{e}_0, \delta)$ is achievable if a rate tuple $(\hat{c}, \hat{q}, \hat{e}, \hat{e}_0, \delta)$ is achievable and $\hat{c}, \hat{q} \geq 0$. Suppose that there exists a protocol $(\mathcal{E}, \mathcal{D})$ with the classical communication cost \hat{c} , the quantum communication cost \hat{q} , the net entanglement cost \hat{e} and the catalytic entanglement cost \hat{e}_0 that achieves the state redistribution of the state Ψ_s within the error δ . We construct a protocol $(\mathcal{E}', \mathcal{D}')$ such that the $\lambda - \mu$ qubits of quantum communication in the protocol $(\mathcal{E}, \mathcal{D})$ is simulated by quantum teleportation, consuming $\lambda - \mu$ ebits of additional shared entanglement and $2\lambda - 2\mu$ bits of classical communication. The net costs of the resources are given by $\hat{c} + 2\lambda - 2\mu, \hat{q} - \lambda + \mu, \hat{e} + \lambda - \mu$ and the catalytic entanglement cost is \hat{e}_0 , which implies achievability of the tuple $(\hat{c} + 2\lambda - 2\mu, \hat{q} - \lambda + \mu, \hat{e} + \lambda + \mu, \hat{e}_0, \delta)$.

Second, we consider the case where $\lambda - \mu \leq 0$. Suppose that there exists a protocol $(\mathcal{E}, \mathcal{D})$ with the classical communication cost \hat{c} , the quantum communication cost \hat{q} and the net entanglement cost \hat{e} that achieves the state redistribution of the state Ψ_s within the error δ . We construct a protocol $(\mathcal{E}'', \mathcal{D}'')$ such that the $2\mu - 2\lambda$ bits of classical communication in $(\mathcal{E}, \mathcal{D})$ is simulated by dense

coding, consuming $\mu - \lambda$ ebits of shared entanglement and $\mu - \lambda$ qubits of quantum communication. The net costs of the resources are given by $\hat{c} - 2\mu + 2\lambda$, $\hat{q} + \mu - \lambda$, $\hat{e} + \mu - \lambda$ and the catalytic entanglement cost is \hat{e}_0 , which implies achievability of the tuple $(\hat{c} - 2\mu + 2\lambda, \hat{q} + \mu - \lambda, \hat{e} + \mu - \lambda, \hat{e}_0, \delta)$. ■

5.4 Proof of Theorem 2 from Proposition 7

The achievability for the case of $d_C = 1$ immediately follows from the condition (120) in Proposition 7. Thus, we only consider the case where $d_C \geq 2$.

Let Π be a projection onto a subspace $\mathcal{H}^{C_\Pi} \subseteq \mathcal{H}^C$ such that $\dim[\mathcal{H}^{C_\Pi}] = 2^{H_{\max'}^{\epsilon^2/8}(C)_{\Psi_s}}$ and that $\text{Tr}[\Pi\Psi_s^C] \geq 1 - \epsilon^2/8$. Such a projection exists due to the definition of $H_{\max'}$ given by (16). Consider the “modified” source state defined by

$$\Psi_{s,\Pi}^{\hat{A}\hat{B}\hat{C}\hat{R}} := \Pi(\Psi_s^{\hat{A}\hat{B}\hat{C}\hat{R}})\Pi. \quad (219)$$

From the gentle measurement lemma (see Lemma 32 in Appendix B), it holds that

$$P(\Psi_s, \Psi_{s,\Pi}) \leq \frac{\epsilon}{2}, \quad \|\Psi_s - \Psi_{s,\Pi}\|_1 \leq \frac{\epsilon}{\sqrt{2}}. \quad (220)$$

Thus, due to the definitions of the smooth entropies (12) and (13), we have

$$H_{\max}^{\epsilon/2}(CZ|BY)_{\Psi_s} \geq H_{\max}^\epsilon(C_\Pi Z|BY)_{\Psi_{s,\Pi}} \quad (221)$$

$$\geq H_{\max}^{3\epsilon/2}(CZ|BY)_{\Psi_s}, \quad (222)$$

$$H_{\min}^{3\epsilon/2}(C|AXYZ)_{\Psi_s} \geq H_{\min}^\epsilon(C_\Pi|AXYZ)_{\Psi_{s,\Pi}} \quad (223)$$

and so forth.

Suppose that the tuple (c, q, e, e_0) satisfies Inequalities (22)-(25) in Theorem 2. It follows that

$$c + 2q \geq \max\{\tilde{H}_I^{(\epsilon,\epsilon)}, \tilde{H}_\Pi^{(\epsilon)}\}_{\Psi_{s,\Pi}} - \log(\delta^4/2), \quad (224)$$

$$c + q + e \geq H_{\max}^\epsilon(C_\Pi Z|BY)_{\Psi_{s,\Pi}} - \log(\delta^2/2), \quad (225)$$

$$q + e \geq H_{\max}^\epsilon(C_\Pi|BXYZ)_{\Psi_{s,\Pi}} - \log \delta^2, \quad (226)$$

$$e_0 \geq \frac{1}{2}(\log d_{C_\Pi} - H_{\max}^\epsilon(C_\Pi|BXYZ)_{\Psi_{s,\Pi}}) + \log \delta. \quad (227)$$

Thus, due to Proposition 7, the tuple (c, q, e, e_0) is achievable within an error $4\sqrt{12\epsilon + 6\delta}$ for the state $\Psi_{s,\Pi}$. That is, there exists a pair of an encoding CPTP map $\mathcal{E}_{\Pi}^{\hat{A}\hat{C}\hat{E}_A \rightarrow \hat{A}QMFA}$ and a decoding CPTP map $\mathcal{D}_{\Pi}^{\hat{B}QME_B \rightarrow \hat{B}\hat{C}\hat{F}_B}$, such that

$$\left\| \mathcal{D}_{\Pi} \circ \mathcal{E}_{\Pi}(\Psi_{s,\Pi}^{\hat{A}\hat{B}\hat{C}\hat{R}} \otimes \Phi_{2^{e+e_0}}^{E_A E_B}) - \Psi_{s,\Pi}^{\hat{A}\hat{B}\hat{C}\hat{R}} \otimes \Phi_{2^{e_0}}^{F_A F_B} \right\|_1 \leq 4\sqrt{12\epsilon + 6\delta}. \quad (228)$$

Define an encoding map $\mathcal{E}^{\hat{A}\hat{C}E_A \rightarrow \hat{A}QMFA}$ and a decoding map $\mathcal{D}^{\hat{B}QME_B \rightarrow \hat{B}\hat{C}\hat{F}_B}$ for the state Ψ_s by

$$\begin{aligned} & \mathcal{E}^{\hat{A}\hat{C}E_A \rightarrow \hat{A}QMFA}(\tau) \\ &= \mathcal{E}_{\Pi}(\Pi^C \tau \Pi^C) + \text{Tr}[(I^C - \Pi^C)\tau]\xi_0, \end{aligned} \quad (229)$$

where ξ_0 is an arbitrary fixed state on $\hat{A}QMFA$, and $\mathcal{D} = \mathcal{D}_{\Pi}$. Note that the system C_Π is naturally embedded into C . By the triangle inequality, we have

$$\begin{aligned} & \left\| \mathcal{D} \circ \mathcal{E}(\Psi_s^{\hat{A}\hat{B}\hat{C}\hat{R}} \otimes \Phi_{2^{e+e_0}}^{E_A E_B}) - \Psi_s^{\hat{A}\hat{B}\hat{C}\hat{R}} \otimes \Phi_{2^{e_0}}^{F_A F_B} \right\|_1 \\ & \leq \left\| \mathcal{D} \circ \mathcal{E}(\Psi_s^{\hat{A}\hat{B}\hat{C}\hat{R}} \otimes \Phi_{2^{e+e_0}}^{E_A E_B}) - \mathcal{D} \circ \mathcal{E}(\Psi_{s,\Pi}^{\hat{A}\hat{B}\hat{C}\hat{R}} \otimes \Phi_{2^{e+e_0}}^{E_A E_B}) \right\|_1 \\ & \quad + \left\| \mathcal{D} \circ \mathcal{E}(\Psi_{s,\Pi}^{\hat{A}\hat{B}\hat{C}\hat{R}} \otimes \Phi_{2^{e+e_0}}^{E_A E_B}) - \Psi_{s,\Pi}^{\hat{A}\hat{B}\hat{C}\hat{R}} \otimes \Phi_{2^{e_0}}^{F_A F_B} \right\|_1 \\ & \quad + \left\| \Psi_{s,\Pi}^{\hat{A}\hat{B}\hat{C}\hat{R}} \otimes \Phi_{2^{e_0}}^{F_A F_B} - \Psi_s^{\hat{A}\hat{B}\hat{C}\hat{R}} \otimes \Phi_{2^{e_0}}^{F_A F_B} \right\|_1 \end{aligned} \quad (230)$$

$$\begin{aligned} & \leq \left\| \mathcal{D}_{\Pi} \circ \mathcal{E}_{\Pi}(\Psi_{s,\Pi}^{\hat{A}\hat{B}\hat{C}\hat{R}} \otimes \Phi_{2^{e+e_0}}^{E_A E_B}) - \Psi_{s,\Pi}^{\hat{A}\hat{B}\hat{C}\hat{R}} \otimes \Phi_{2^{e_0}}^{F_A F_B} \right\|_1 \\ & \quad + 2 \left\| \Psi_s^{\hat{A}\hat{B}\hat{C}\hat{R}} - \Psi_{s,\Pi}^{\hat{A}\hat{B}\hat{C}\hat{R}} \right\|_1 \end{aligned} \quad (231)$$

$$\leq 4\sqrt{12\epsilon + 6\delta} + \sqrt{2}\epsilon, \quad (232)$$

Here, Inequality (231) follows from $\mathcal{D}_{\Pi} \circ \mathcal{E}_{\Pi}(\Psi_{s,\Pi}^{\hat{A}\hat{B}\hat{C}\hat{R}} \otimes \Phi_{2^{e+e_0}}^{E_A E_B}) = \mathcal{D} \circ \mathcal{E}(\Psi_{s,\Pi}^{\hat{A}\hat{B}\hat{C}\hat{R}} \otimes \Phi_{2^{e+e_0}}^{E_A E_B})$ and the monotonicity of the trace distance, and the last line from (220) and (228). Hence, the tuple (c, q, e, e_0) is achievable within an error $4\sqrt{12\epsilon + 6\delta} + \sqrt{2}\epsilon$ for the state Ψ_s , which completes the proof of Theorem 2. ■

6 Proof of The Converse Part (Theorem 3 and Lemma 5)

We prove the one-shot converse bound (Theorem 3). The proof proceeds as follows: First, we

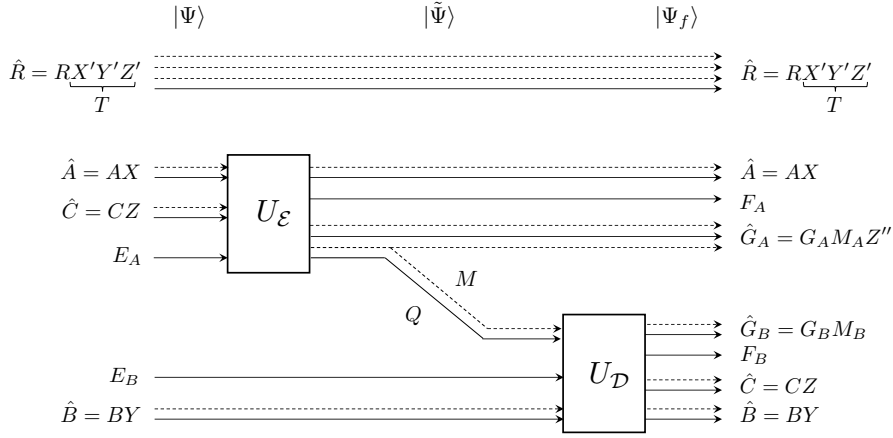

Figure 7: The purified picture of the task is depicted in the diagram. The black lines and the dashed lines represent classical and quantum systems, respectively.

construct quantum states that describe the state transformation in a redistribution protocol in a “purified picture”. Second, we prove four entropic inequalities that hold for those states. Finally, we prove that the four inequalities imply the three inequalities in Theorem 3, thereby completing the proof of the converse bound. We also analyze the properties of the function $\Delta^{(\epsilon, \delta)}$, and prove Lemma 5.

6.1 Construction of States

Let $U_{\mathcal{E}}^{\hat{A}\hat{C}E_A \rightarrow \hat{A}QMF_A\hat{G}_A}$ and $U_{\mathcal{D}}^{\hat{B}QME_B \rightarrow \hat{B}\hat{C}F_B\hat{G}_B}$ be the Stinespring dilations of the encoding operation \mathcal{E} and the decoding operation \mathcal{D} , respectively, i.e.,

$$\mathcal{E} = \text{Tr}_{\hat{G}_A} \circ U_{\mathcal{E}}, \quad \mathcal{D} = \text{Tr}_{\hat{G}_B} \circ U_{\mathcal{D}}. \quad (233)$$

We define the “purified” source state $|\Psi\rangle$ by

$$|\Psi\rangle^{ABCRXYZT} := \sum_{x,y,z} \sqrt{p_{xyz}} |x\rangle^X |y\rangle^Y |z\rangle^Z |\psi_{xyz}\rangle^{ABCR} |xyz\rangle^T, \quad (234)$$

and consider the states

$$|\tilde{\Psi}\rangle^{\hat{A}QMF_A\hat{G}_A\hat{B}\hat{R}E_B} := U_{\mathcal{E}} |\Psi\rangle^{\hat{A}\hat{B}\hat{C}\hat{R}} |\Phi_{2^{\epsilon+e_0}}\rangle^{E_A E_B}, \quad (235)$$

$$|\Psi_f\rangle^{\hat{A}\hat{B}\hat{C}\hat{R}F_A F_B \hat{G}_A \hat{G}_B} := U_{\mathcal{D}} |\tilde{\Psi}\rangle. \quad (236)$$

The state $\tilde{\Psi}$ is a purification of the state after the encoding operation, and Ψ_f is the one after the decoding operation. See Figure 7 for the diagram.

Due to the relation (6) between the trace distance and the purified distance, the condition (21) implies that

$$P\left(\mathcal{C}^T(\Psi_f)^{\hat{A}\hat{B}\hat{C}\hat{R}F_A F_B}, \Psi_s^{\hat{A}\hat{B}\hat{C}\hat{R}} \otimes \Phi_{2^{\epsilon_0}}^{F_A F_B}\right) \leq 2\sqrt{\delta}, \quad (237)$$

with \mathcal{C}^T being the completely dephasing operation on T with respect to the basis $\{|xyz\rangle\}$. Due to an extension of Uhlmann’s theorem (see Lemma 30 in Appendix B), there exists a pure state $|\Gamma\rangle^{\hat{A}\hat{B}\hat{C}\hat{G}_A\hat{G}_B\hat{R}}$, which is represented in the form of

$$|\Gamma\rangle = \sum_{x,y,z} \sqrt{p_{xyz}} |x\rangle^X |y\rangle^Y |z\rangle^Z |\psi_{xyz}\rangle^{ABCR} |\phi_{xyz}\rangle^{\hat{G}_A \hat{G}_B} |xyz\rangle^T, \quad (238)$$

such that

$$P\left(\Psi_f^{\hat{A}\hat{B}\hat{C}\hat{R}F_A F_B \hat{G}_A \hat{G}_B}, \Gamma^{\hat{A}\hat{B}\hat{C}\hat{G}_A \hat{G}_B \hat{R}} \otimes \Phi_{2^{\epsilon_0}}^{F_A F_B}\right) \leq 2\sqrt{\delta}. \quad (239)$$

Using this state, we define

$$|\tilde{\Gamma}\rangle^{\hat{A}QMF_A\hat{G}_A\hat{B}\hat{R}E_B} := U_{\mathcal{D}}^\dagger |\Gamma\rangle^{\hat{A}\hat{B}\hat{C}\hat{G}_A\hat{G}_B\hat{R}} |\Phi_{2^{\epsilon_0}}\rangle^{F_A F_B}. \quad (240)$$

Due to the isometric invariance of the purified distance, it follows from (239) and (236) that

$$P\left(\tilde{\Psi}^{\hat{A}QMF_A\hat{G}_A\hat{B}\hat{R}E_B}, \tilde{\Gamma}^{\hat{A}QMF_A\hat{G}_A\hat{B}\hat{R}E_B}\right) \leq 2\sqrt{\delta}. \quad (241)$$

Relations among the states defined as above are depicted in Figure 8. Some useful properties of these states are presented in the following, and will be used in the proof of the converse part.

$$\begin{array}{ccccc}
|\tilde{\Gamma}\rangle & \xleftarrow{U_{\mathcal{D}}^{\dagger}} & |\Gamma\rangle|\Phi_{2^{e_0}}\rangle & \xrightarrow{\text{Tr}_{\hat{G}_A\hat{G}_B} \otimes \mathcal{C}^T} & \Psi_s \otimes \Phi_{2^{e_0}} \\
2\sqrt{\delta} \wr & & \wr 2\sqrt{\delta} & & \\
\Psi_s \otimes \Phi_{2^{e+e_0}} & \xleftarrow{\mathcal{C}^T} & |\Psi\rangle|\Phi_{2^{e+e_0}}\rangle & \xrightarrow{U_{\mathcal{E}}} & |\tilde{\Psi}\rangle & \xrightarrow{U_{\mathcal{D}}} & |\Psi_f\rangle
\end{array}$$

Figure 8: Relations among the states $\tilde{\Psi}$, $\tilde{\Gamma}$, Ψ , Γ and Ψ_s are depicted.

6.1.1 Decomposition of $U_{\mathcal{E}}$ and $U_{\mathcal{D}}$

Since M is a classical system, we may, without loss of generality, assume that $U_{\mathcal{E}}$ and $U_{\mathcal{D}}$ are decomposed as

$$U_{\mathcal{E}} = \sum_m |m\rangle^M |m\rangle^{M_A} \otimes v_m^{\hat{A}\hat{C}E_A \rightarrow \hat{A}QF_A \hat{G}_A}, \quad (242)$$

$$U_{\mathcal{D}} = \sum_m |m\rangle^{M_B} \langle m|^M \otimes u_m^{\hat{B}QE_B \rightarrow \hat{B}\hat{C}F_B G_B}. \quad (243)$$

Here, M_A and M_B are quantum systems isomorphic to M with the fixed orthonormal basis $\{|m\rangle\}_m$, the operators u_m are linear isometries, and \hat{G}_A and \hat{G}_B are such that $\hat{G}_A \equiv \hat{G}_A M_A$ and $\hat{G}_B \equiv G_B M_B$. It follows that

$$U_{\mathcal{D}} \circ U_{\mathcal{E}} = \sum_m |m\rangle^{M_A} |m\rangle^{M_B} \otimes (u_m \circ v_m). \quad (244)$$

Since Z is a classical system, we may further assume that v_m are decomposed as

$$v_m := \sum_z |z\rangle^{Z''} \langle z|^Z \otimes v_{m,z}^{\hat{A}CE_A \rightarrow \hat{A}QF_A G_A}, \quad (245)$$

where Z'' is a system isomorphic to Z with the fixed orthonormal basis $\{|z\rangle\}_z$ and $\tilde{G}_A \equiv G_A Z''$. The operators $v_{m,z}$ are linear operators such that $\sum_m v_{m,z}^{\dagger} v_{m,z} = I$ for all z . It should be noted that $\hat{G}_A = G_A M_A Z''$.

6.1.2 Properties of $\tilde{\Psi}$ and Ψ_f

Since $|\tilde{\Psi}\rangle$ is defined as (235) by $U_{\mathcal{E}}$ that is in the form of (242), it is decomposed into

$$|\tilde{\Psi}\rangle = \sum_m \sqrt{q_m} |m\rangle^M |m\rangle^{M_A} |\tilde{\Psi}_m\rangle, \quad (246)$$

with some probability distribution $\{q_m\}_m$ and pure states $\{|\tilde{\Psi}_m\rangle\}_m$. Thus, we have

$$\mathcal{C}^M(\tilde{\Psi}) = \sum_m q_m |m\rangle \langle m|^M \otimes |m\rangle \langle m|^{M_A} \otimes |\tilde{\Psi}_m\rangle \langle \tilde{\Psi}_m|, \quad (247)$$

where \mathcal{C}^M is the completely dephasing operation on M with respect to the basis $\{|m\rangle\}_m$. Similarly, due to (244), (235) and (236), the state $|\Psi_f\rangle$ is decomposed into

$$|\Psi_f\rangle = \sum_m \sqrt{q_m} |m\rangle^{M_A} |m\rangle^{M_B} |\Psi_{f,m}\rangle. \quad (248)$$

From (245), it holds that $\langle z_1|^{Z'} \langle z_2|^{Z''} |\Psi_f\rangle \propto \delta_{z_1, z_2}$. Thus, the states $|\Psi_{f,m}\rangle$ are further decomposed into

$$|\Psi_{f,m}\rangle = \sum_z \sqrt{q_{z|m}} |z\rangle^{Z''} |\Psi_{f,m,z}\rangle |z\rangle^{Z'}. \quad (249)$$

6.1.3 Properties of Γ

From the definition (238), it follows that

$$\begin{aligned}
\mathcal{C}^T(\Gamma) = & \sum_{x,y,z} p_{xyz} |xyz\rangle \langle xyz|^{XYZ} \otimes |\psi_{xyz}\rangle \langle \psi_{xyz}|^{ABCR} \\
& \otimes |\phi_{xyz}\rangle \langle \phi_{xyz}|^{\hat{G}_A \hat{G}_B} \otimes |xyz\rangle \langle xyz|^T \quad (250)
\end{aligned}$$

and that

$$\begin{aligned}
\text{Tr}_T(\Gamma) = & \sum_{x,y,z} p_{xyz} |xyz\rangle \langle xyz|^{XYZ} \\
& \otimes |\psi_{xyz}\rangle \langle \psi_{xyz}|^{ABCR} \otimes |\phi_{xyz}\rangle \langle \phi_{xyz}|^{\hat{G}_A \hat{G}_B}. \quad (251)
\end{aligned}$$

Both states are ensembles of pure states on $ABCR\hat{G}_A\hat{G}_B$, classically labelled by xyz on XYZ or T , that are decoupled between $ABCR$ and $\hat{G}_A\hat{G}_B$. It follows from (250) that

$$\text{Tr}_{\hat{G}_A\hat{G}_B} \otimes \mathcal{C}^T(\Gamma) = \Psi_s^{\hat{A}\hat{B}\hat{C}\hat{R}}. \quad (252)$$

Due to (248), (249) and Lemma 31 in Appendix B, we may, without loss of generality, assume that $|\phi_{xyz}\rangle$ is in the form of

$$|\phi_{xyz}\rangle^{\hat{G}_A \hat{G}_B} = |\phi'_{xyz}\rangle^{G_A M_A \hat{G}_B} |z\rangle^{Z''} \quad (253)$$

and

$$\begin{aligned} & |\phi'_{xyz}\rangle^{G_A M_A \hat{G}_B} \\ & := \sum_m \sqrt{p_{m|xyz}} |m\rangle^{M_A} |m\rangle^{M_B} |\phi_{m,xyz}\rangle^{G_A G_B}. \end{aligned} \quad (254)$$

Substituting this to (250), we have

$$\begin{aligned} & \mathcal{C}^T(\Gamma)^{AG_A M_A X Y Z T} \\ & = \sum_{x,y,z} p_{xyz} |xyz\rangle\langle xyz|^{XYZ} \otimes |z\rangle\langle z|^{Z''} \\ & \quad \otimes \psi_{xyz}^A \otimes \phi_{xyz}^{G_A M_A} \otimes |xyz\rangle\langle xyz|^T. \end{aligned} \quad (255)$$

Thus, the state $\mathcal{C}^T(\Gamma)$ given by is classically coherent in ZZ'' . Denoting $p_{xyz} p_{m|xyz}$ by $p_{m,xyz}$, it follows from (250) that

$$\begin{aligned} & \mathcal{C}^T \circ \mathcal{C}^{M_A}(\Gamma^{AG_A M_A \hat{G}_B T}) \\ & = \sum_{x,y,z} p_{m,xyz} \psi_{xyz}^A \otimes |m\rangle\langle m|^{M_A} \otimes |m\rangle\langle m|^{M_B} \\ & \quad \otimes |\phi_{m,xyz}\rangle\langle \phi_{m,xyz}|^{G_A G_B} \otimes |xyz\rangle\langle xyz|^T, \end{aligned} \quad (256)$$

with \mathcal{C}^{M_A} being the completely dephasing operation on M_A with respect to the basis $\{|m\rangle\}_m$. It should also be noted that

$$\begin{aligned} & \Gamma^{AG_A M_A X Y Z} \\ & = \sum_{x,y,z} p_{m,xyz} |m\rangle\langle m|^{M_A} \otimes \psi_{xyz}^A \\ & \quad \otimes \phi_{m,xyz}^{G_A} \otimes |xyz\rangle\langle xyz|^{XYZ}. \end{aligned} \quad (257)$$

6.2 Inequalities for Proving Theorem 3

As an intermediate goal for the proof of Theorem 3, we prove that the following four inequalities hold for the states Ψ_s and Γ defined by (20) and (238), respectively:

$$\begin{aligned} c + q - e & \geq H_{\min}^\epsilon(AXCZ)_{\Psi_s} - H_{\max}^\epsilon(AXZ)_{\Psi_s} \\ & \quad - H_{\min}^{7\epsilon+2\sqrt{\delta}}(G_A|M_A AXZ)_\Gamma - 4f(\epsilon), \end{aligned} \quad (258)$$

$$\begin{aligned} q - e & \geq H_{\min}^\epsilon(AC|XYZ)_{\Psi_s} - H_{\max}^\epsilon(A|XYZ)_{\Psi_s} \\ & \quad - H_{\min}^{5\epsilon+2\sqrt{\delta}}(G_A M_A|XYZ)_\Gamma - 3f(\epsilon), \end{aligned} \quad (259)$$

$$\begin{aligned} c + q + e & \geq H_{\min}^\epsilon(BYCZ)_{\Psi_s} - H_{\min}^{12\epsilon+6\sqrt{\delta}}(BY)_{\Psi_s} \\ & \quad + H_{\min}^{5\epsilon+2\sqrt{\delta}}(G_A M_A|XYZ)_\Gamma - f(\epsilon), \end{aligned} \quad (260)$$

$$\begin{aligned} q + e & \geq H_{\min}^\epsilon(BC|XYZ)_{\Psi_s} - H_{\min}^{11\epsilon+8\sqrt{\delta}}(B|XYZ)_{\Psi_s} \\ & \quad + H_{\min}^{7\epsilon+6\sqrt{\delta}}(G_A|M_A AXYZ)_\Gamma - 2f(\epsilon), \end{aligned} \quad (261)$$

where $f(x) := -\log(1 - \sqrt{1 - x^2})$. The proof of these inequalities will be given in the following subsections. We will extensively use the properties of the smooth conditional entropies, which are summarized in Appendix A.

6.2.1 Proof of Inequality (258)

We start with

$$\begin{aligned} & e + e_0 + H_{\min}^\epsilon(AXCZ)_{\Psi_s} \\ & = e + e_0 + H_{\min}^\epsilon(AXCZ)_{\Psi} \end{aligned} \quad (262)$$

$$\leq H_{\min}^\epsilon(AXCZEA)_{\Psi_s \otimes \Phi_{2e+e_0}} \quad (263)$$

$$= H_{\min}^\epsilon(AXF_A \hat{G}_A QM)_{\tilde{\Psi}} \quad (264)$$

$$\leq H_{\max}^\epsilon(QM) + H_{\min}^{4\epsilon}(AXF_A \hat{G}_A|QM)_{\tilde{\Psi}} + 2f(\epsilon) \quad (265)$$

$$\leq c + q + H_{\min}^{4\epsilon}(AXF_A \hat{G}_A|M)_{\tilde{\Psi}} + 2f(\epsilon), \quad (266)$$

where (262) follows from $\Psi_s^{\hat{A}\hat{C}} = \Psi^{\hat{A}\hat{C}}$; (263) from the superadditivity of the smooth conditional min entropy for product state (Lemma 16); (264) from the fact that $|\tilde{\Psi}\rangle$ is obtained from $|\Psi\rangle|\Phi_{2e+e_0}\rangle$ by an isometry $U_{\mathcal{E}}$ as (235), under which the smooth conditional entropy is invariant (Lemma 14); (265) from the chain rule (360); and (266) from the dimension bound (Lemma 19).

The third term in (266) is further calculated as

$$H_{\min}^{4\epsilon}(AXF_A \hat{G}_A|M)_{\tilde{\Psi}} \quad (267)$$

$$\leq H_{\min}^{4\epsilon}(AXF_A \hat{G}_A|M)_{\mathcal{C}M(\tilde{\Psi})} \quad (268)$$

$$= H_{\min}^{4\epsilon}(AXZ'' F_A G_A M_A|M)_{\mathcal{C}M(\tilde{\Psi})} \quad (269)$$

$$= H_{\min}^{4\epsilon}(AXZ'' F_A G_A|M_A)_{\tilde{\Psi}} \quad (270)$$

$$\leq H_{\min}^{4\epsilon+2\sqrt{\delta}}(AXZ'' F_A G_A|M_A)_{\tilde{\Gamma}} \quad (271)$$

$$= H_{\min}^{4\epsilon+2\sqrt{\delta}}(AXZ'' F_A G_A|M_A)_{\Gamma \otimes \Phi_{2e_0}} \quad (272)$$

$$\leq H_{\min}^{4\epsilon+2\sqrt{\delta}}(AXZ'' G_A|M_A)_{\Gamma} + e_0 \quad (273)$$

$$= H_{\min}^{4\epsilon+2\sqrt{\delta}}(AXZG_A|M_A)_{\Gamma} + e_0 \quad (274)$$

$$\begin{aligned} & \leq H_{\max}^\epsilon(AXZ|M_A)_{\Gamma} \\ & \quad + H_{\min}^{7\epsilon+2\sqrt{\delta}}(G_A|M_A AXZ)_{\Gamma} + e_0 + 2f(\epsilon) \end{aligned} \quad (275)$$

$$\begin{aligned} & \leq H_{\max}^\epsilon(AXZ)_{\Gamma} \\ & \quad + H_{\min}^{7\epsilon+2\sqrt{\delta}}(G_A|M_A AXZ)_{\Gamma} + e_0 + 2f(\epsilon) \end{aligned} \quad (276)$$

$$\begin{aligned} & = H_{\max}^\epsilon(AXZ)_{\Psi_s} \\ & \quad + H_{\min}^{7\epsilon+2\sqrt{\delta}}(G_A|M_A AXZ)_{\Gamma} + e_0 + 2f(\epsilon). \end{aligned} \quad (277)$$

Here, (268) follows from the monotonicity of the smooth conditional entropy (Lemma 13); (269) from $\hat{G}_A \equiv G_A M_A Z''$; (270) from Lemma 23 and the fact that M_A is a classical copy of M as (247); (271) from the continuity of the smooth conditional entropy (Lemma 20) and the fact that $\tilde{\Gamma}$ and $\tilde{\Psi}$ are $2\sqrt{\delta}$ -close with each other as (241); (272) from the fact that $\tilde{\Gamma}$ is converted to Γ by $U_{\mathcal{D}}$ as (240), which does not change the reduced state on $AXZ''F_A G_A M_A$; (273) from the dimension bound (Lemma 19); (274) from the fact that Z'' is a classical copy of Z , due to (255); (275) from the chain rule (360); (276) from the fact that conditioning reduces the entropy due to the monotonicity of the smooth conditional entropy (Lemma 13); and (277) from the fact that $\Gamma^{AXZ} = \Psi_s^{AXZ}$.

Combining these inequalities, we obtain

$$\begin{aligned} & e + e_0 + H_{\min}^{\epsilon}(AXCZ)_{\Psi_s} \\ & \leq c + q + 2f(\epsilon) + H_{\max}^{\epsilon}(AXZ)_{\Psi_s} \\ & \quad + H_{\min}^{7\epsilon+2\sqrt{\delta}}(G_A|M_A AXZ)_{\Gamma} + e_0 + 2f(\epsilon), \end{aligned} \quad (278)$$

which implies (258).

6.2.2 Proof of Inequality (259)

We have

$$e_0 + H_{\min}^{2\epsilon+2\sqrt{\delta}}(\hat{A}\hat{G}_A|T)_{\mathcal{C}^T(\Gamma)} \quad (279)$$

$$= e_0 + H_{\min}^{2\epsilon+2\sqrt{\delta}}(\hat{B}\hat{C}\hat{R}\hat{G}_B|T)_{\mathcal{C}^T(\Gamma)} \quad (280)$$

$$\geq H_{\min}^{2\epsilon+2\sqrt{\delta}}(\hat{B}\hat{C}\hat{R}F_B\hat{G}_B|T)_{\mathcal{C}^T(\Gamma)\otimes\Phi_{2e_0}} \quad (281)$$

$$= H_{\min}^{2\epsilon+2\sqrt{\delta}}(\hat{B}\hat{R}E_BQM|T)_{\mathcal{C}^T(\tilde{\Gamma})} \quad (282)$$

$$\begin{aligned} & \geq H_{\min}^{\epsilon+2\sqrt{\delta}}(\hat{B}\hat{R}E_B M|T)_{\mathcal{C}^T(\tilde{\Gamma})} \\ & \quad + H_{\min}(Q|\hat{B}\hat{R}E_B M T)_{\mathcal{C}^T(\tilde{\Gamma})} - f(\epsilon) \end{aligned} \quad (283)$$

$$\geq H_{\min}^{\epsilon+2\sqrt{\delta}}(\hat{B}\hat{R}E_B M|T)_{\mathcal{C}^T(\tilde{\Gamma})} - q - f(\epsilon). \quad (284)$$

Here, (280) is from the fact that Γ is a pure state on $\hat{A}\hat{B}\hat{C}\hat{R}\hat{G}_A\hat{G}_B$ as (238), which is transformed by \mathcal{C}^T to an ensemble of classically-labelled pure states, to which Lemma 27 is applicable; (281) from the dimension bound (Lemma 19); (282) from the fact that $\tilde{\Gamma}$ is obtained from $\Gamma \otimes \Phi_{2e_0}$ by an isometry as (240) under which the smooth conditional entropy is invariant (Lemma 14); (283) from the chain rule (359); and (284) from the dimension bound (Lemma 18).

The first term in (284) is further calculated to be

$$H_{\min}^{\epsilon+2\sqrt{\delta}}(\hat{B}\hat{R}E_B M|T)_{\mathcal{C}^T(\tilde{\Gamma})} \quad (285)$$

$$\geq H_{\min}^{\epsilon}(\hat{B}\hat{R}E_B M|T)_{\mathcal{C}^T(\tilde{\Psi})} \quad (286)$$

$$= H_{\min}^{\epsilon}(\hat{A}F_A\hat{G}_A Q|T)_{\mathcal{C}^T(\tilde{\Psi})} \quad (287)$$

$$= H_{\min}^{\epsilon}(\hat{A}F_A\hat{G}_A Q M|T)_{\mathcal{C}^T \otimes \mathcal{C}^M(\tilde{\Psi})} \quad (288)$$

$$\geq H_{\min}^{\epsilon}(\hat{A}F_A\hat{G}_A Q M|T)_{\mathcal{C}^T(\tilde{\Psi})} \quad (289)$$

$$= H_{\min}^{\epsilon}(\hat{A}\hat{C}E_A|T)_{\mathcal{C}^T(\Psi)\otimes\Phi_{e+e_0}} \quad (290)$$

$$\geq H_{\min}^{\epsilon}(\hat{A}\hat{C}|T)_{\mathcal{C}^T(\Psi)} + e + e_0 \quad (291)$$

$$= H_{\min}^{\epsilon}(AC|XYZ)_{\Psi_s} + e + e_0. \quad (292)$$

Inequality (286) is from the continuity of the smooth conditional entropy (Lemma 20) and the fact that $\tilde{\Gamma}$ and $\tilde{\Psi}$ are $2\sqrt{\delta}$ -close with each other as (241); (287) from Lemma 27 and the fact that $\tilde{\Psi}$ is a pure state on $\hat{A}\hat{B}\hat{R}QMF_A\hat{G}_A E_B$ as (235), which is transformed by \mathcal{C}^T to an ensemble of classically-labelled pure states; (288) from $\hat{G}_A = G_A M_A Z''$ and the fact that M is a classical copy of M_A as (247); (289) from the monotonicity of the smooth conditional min entropy under unital maps (Lemma 13); (290) from the isometric invariance of the smooth conditional entropy (Lemma 14) and the fact that $\tilde{\Psi}$ is obtained by an isometry $U_{\mathcal{E}}$ from Ψ as (235); (291) from the superadditivity of the smooth conditional entropy (Lemma 16); and (292) from $\mathcal{C}^T(\Psi) = \Psi_s$ and the property of the smooth conditional entropy for CQ states (Lemma 23).

The second term in (279) is bounded as

$$\begin{aligned} & H_{\min}^{2\epsilon+2\sqrt{\delta}}(\hat{A}\hat{G}_A|T)_{\mathcal{C}^T(\Gamma)} \\ & = H_{\min}^{2\epsilon+2\sqrt{\delta}}(AG_A M_A|XYZ)_{\Gamma} \end{aligned} \quad (293)$$

$$\leq H_{\max}^{\epsilon}(A|XYZ)_{\Gamma} \quad (294)$$

$$+ H_{\min}^{5\epsilon+2\sqrt{\delta}}(G_A M_A|AXYZ)_{\Gamma} + 2f(\epsilon) \quad (294)$$

$$= H_{\max}^{\epsilon}(A|XYZ)_{\Psi_s} \quad (295)$$

$$+ H_{\min}^{5\epsilon+2\sqrt{\delta}}(G_A M_A|XYZ)_{\Gamma} + 2f(\epsilon). \quad (295)$$

Here, (293) follows from $\hat{G}_A \equiv G_A M_A Z''$ and the fact that $\mathcal{C}^T(\Gamma)$ is classically coherent in XX' and in ZZ'' because of (255); (294) from the chain rule (360); and (295) from $\Gamma^{AXYZ} = \Psi_s^{AXYZ}$ and the fact that the system A in the conditioning part is decoupled from $G_A M_A$ when conditioned by XYZ as (251) in addition to Lemma 25.

Combining these all together, we arrive at

$$\begin{aligned}
& e_0 + H_{\max}^\epsilon(A|XYZ)_{\Psi_s} \\
& \quad + H_{\min}^{5\epsilon+2\sqrt{\delta}}(G_A M_A|XYZ)_{\Gamma} + 2f(\epsilon) \\
& \geq H_{\min}^\epsilon(AC|XYZ)_{\Psi_s} + e + e_0 - q - f(\epsilon).
\end{aligned} \tag{296}$$

This completes the proof of Ineq. (259).

6.2.3 Proof of Inequality (260)

We first calculate

$$\begin{aligned}
& H_{\min}^\epsilon(BY CZ)_{\Psi_s} \\
& = H_{\min}^\epsilon(BY CZ)_{\Gamma}
\end{aligned} \tag{297}$$

$$\begin{aligned}
& \leq H_{\min}^{12\epsilon+4\sqrt{\delta}}(BY CZ F_B \hat{G}_B)_{\Gamma \otimes \Phi_{2e_0}} \\
& \quad - H_{\min}^{5\epsilon+2\sqrt{\delta}}(F_B \hat{G}_B|BY CZ)_{\Gamma \otimes \Phi_{2e_0}} + f(\epsilon)
\end{aligned} \tag{298}$$

$$\begin{aligned}
& \leq H_{\min}^{12\epsilon+4\sqrt{\delta}}(BY CZ F_B \hat{G}_B)_{\Gamma \otimes \Phi_{2e_0}} \\
& \quad - e_0 - H_{\min}^{5\epsilon+2\sqrt{\delta}}(\hat{G}_B|BY CZ)_{\Gamma} + f(\epsilon)
\end{aligned} \tag{299}$$

$$\begin{aligned}
& = H_{\min}^{12\epsilon+4\sqrt{\delta}}(BY E_B Q M)_{\tilde{\Gamma}} \\
& \quad - e_0 - H_{\min}^{5\epsilon+2\sqrt{\delta}}(\hat{G}_B|BY CZ)_{\Gamma} + f(\epsilon).
\end{aligned} \tag{300}$$

Here, (297) follows from $\Psi_s^{BY CZ} = \Gamma^{BY CZ}$; (298) from the chain rule (359); (299) from the super-additivity of the smooth conditional entropy for product states (Lemma 16); and (300) from the fact that $\tilde{\Gamma}$ is obtained by an isometry $U_{\mathcal{D}}^\dagger$ from $\Gamma \otimes \Phi_{2e_0}$ as (240).

The first term in (300) is further calculated to be

$$H_{\min}^{12\epsilon+4\sqrt{\delta}}(BY E_B Q M)_{\tilde{\Gamma}} \tag{301}$$

$$\leq H_{\min}^{12\epsilon+6\sqrt{\delta}}(BY E_B Q M)_{\tilde{\Psi}} \tag{302}$$

$$\leq H_{\min}^{12\epsilon+6\sqrt{\delta}}(BY E_B)_{\tilde{\Psi}} + c + q \tag{303}$$

$$= H_{\min}^{12\epsilon+6\sqrt{\delta}}(BY E_B)_{\Psi \otimes \Phi_{e+e_0}} + c + q \tag{304}$$

$$\leq H_{\min}^{12\epsilon+6\sqrt{\delta}}(BY)_{\Psi_s} + e + e_0 + c + q, \tag{305}$$

where (302) follows from the continuity of the smooth conditional entropy (Lemma 20) and the fact that $\tilde{\Gamma}$ and $\tilde{\Psi}$ are $2\sqrt{\delta}$ -close with each other as (241); (303) from the dimension bound (Lemma 19); (304) from the fact that $\tilde{\Psi}$ is converted to $\Psi \otimes \Phi_{e+e_0}$ by an operation $U_{\mathcal{E}}$ by Alice as (235), which does not change the reduced state

on $BY E_B$; and (305) from the dimension bound (Lemma 19) and $\Psi_s^{BY} = \Psi^{BY}$.

For the third term in (300), we have

$$H_{\min}^{5\epsilon+2\sqrt{\delta}}(\hat{G}_B|BY CZ)_{\Gamma} \tag{306}$$

$$\geq H_{\min}^{5\epsilon+2\sqrt{\delta}}(\hat{G}_B|BC XY Z)_{\Gamma} \tag{307}$$

$$= H_{\min}^{5\epsilon+2\sqrt{\delta}}(\hat{G}_B|XYZ)_{\Gamma} \tag{308}$$

$$= H_{\min}^{5\epsilon+2\sqrt{\delta}}(\hat{G}_A|XYZ)_{\Gamma} \tag{309}$$

$$= H_{\min}^{5\epsilon+2\sqrt{\delta}}(G_A M_A|XYZ)_{\Gamma} \tag{310}$$

Here, (307) is from the monotonicity of the smooth conditional entropy (Lemma 13); (308) from the fact that Γ is decoupled between BC and \hat{G}_B when conditioned by XYZ as (251), and the property of the smooth conditional entropy (Lemma 25); (309) from Lemma 27 and the fact that $\Gamma^{\hat{G}_A \hat{G}_B XYZ}$ is an ensemble of classically-labelled pure states on $\hat{G}_A \hat{G}_B$ as (251); and (310) from $\hat{G}_A \equiv G_A M_A Z''$, Lemma 23 and the fact that Z'' is a classical copy of Z due to (255).

Combining these all together, we arrive at

$$\begin{aligned}
& H_{\min}^\epsilon(BY CZ)_{\Psi_s} \\
& \leq H_{\min}^{12\epsilon+6\sqrt{\delta}}(BY)_{\Psi_s} + e + c + q + f(\epsilon) \\
& \quad - H_{\min}^{5\epsilon+2\sqrt{\delta}}(G_A M_A|XYZ)_{\Gamma}.
\end{aligned} \tag{311}$$

6.2.4 Proof of Inequality (261)

We have

$$e + e_0 + H_{\min}^{11\epsilon+8\sqrt{\delta}}(B|XYZ)_{\Psi_s} \tag{312}$$

$$= e + e_0 + H_{\min}^{11\epsilon+8\sqrt{\delta}}(ACR|XYZ)_{\Psi_s} \tag{313}$$

$$= e + e_0 + H_{\min}^{11\epsilon+8\sqrt{\delta}}(\hat{A} \hat{C} R|T)_{\Psi_s} \tag{314}$$

$$= e + e_0 + H_{\min}^{11\epsilon+8\sqrt{\delta}}(\hat{A} \hat{C} R|T)_{\mathcal{C}^T(\Psi)} \tag{315}$$

$$\geq H_{\min}^{11\epsilon+8\sqrt{\delta}}(\hat{A} \hat{C} E_A R|T)_{\mathcal{C}^T(\Psi) \otimes \Phi_{2e+e_0}} \tag{316}$$

$$= H_{\min}^{11\epsilon+8\sqrt{\delta}}(\hat{A} Q M F_A \hat{G}_A R|T)_{\mathcal{C}^T(\tilde{\Psi})} \tag{317}$$

$$\geq H_{\min}^{10\epsilon+8\sqrt{\delta}}(\hat{A} M F_A \hat{G}_A R|T)_{\mathcal{C}^T(\tilde{\Psi})} \tag{318}$$

$$+ H_{\min}(Q|\hat{A} M F_A \hat{G}_A R T)_{\mathcal{C}^T(\tilde{\Psi})} - f(\epsilon) \tag{318}$$

$$\geq H_{\min}^{10\epsilon+8\sqrt{\delta}}(\hat{A} M F_A \hat{G}_A R|T)_{\mathcal{C}^T(\tilde{\Psi})} - q - f(\epsilon) \tag{319}$$

$$= H_{\min}^{10\epsilon+8\sqrt{\delta}}(\hat{B} E_B Q|T)_{\mathcal{C}^T(\tilde{\Psi})} - q - f(\epsilon), \tag{320}$$

where (313) follows from Lemma 27; (314) from Lemma 23 and the fact that $T = X'Y'Z'$ is a classical copy of XYZ ; (315) from $\Psi_s = \mathcal{C}^T(\Psi)$, (316)

from the dimension bound (Lemma 19), (317) from the fact that $\tilde{\Psi}$ is obtained from $\Psi \otimes \Phi_{2^{\epsilon+e_0}}$ by applying the isometry $U_{\mathcal{E}}$ as (235), under which the smooth conditional entropy is invariant (Lemma 14), (318) from the chain rule (359), (319) from the dimension bound (Lemma 18), and (320) from Lemma 27 and the fact that $\tilde{\Psi}$ is a pure state on $\hat{A}\hat{B}\hat{R}F_A\hat{G}_A Q M E_B$ as (235), which is converted by \mathcal{C}^T to an ensemble of classically-labelled pure states.

The first term in (320) is further calculated to be

$$H_{\min}^{10\epsilon+8\sqrt{\delta}}(\hat{B}E_B Q|T)_{\mathcal{C}^T(\tilde{\Psi})} \quad (321)$$

$$= H_{\min}^{10\epsilon+8\sqrt{\delta}}(\hat{B}E_B Q|T)_{\mathcal{C}^T \otimes \mathcal{C}^M(\tilde{\Psi})} \quad (322)$$

$$\geq H_{\min}^{10\epsilon+8\sqrt{\delta}}(\hat{B}E_B Q|TM)_{\mathcal{C}^T \otimes \mathcal{C}^M(\tilde{\Psi})} \quad (323)$$

$$= H_{\min}^{10\epsilon+8\sqrt{\delta}}(\hat{B}E_B Q M|TM_A)_{\mathcal{C}^T \otimes \mathcal{C}^{M_A}(\tilde{\Psi})} \quad (324)$$

$$= H_{\min}^{10\epsilon+8\sqrt{\delta}}(\hat{B}\hat{C}F_B\hat{G}_B|TM_A)_{\mathcal{C}^T \otimes \mathcal{C}^{M_A}(\Psi_f)} \quad (325)$$

$$\geq H_{\min}^{10\epsilon+6\sqrt{\delta}}(\hat{B}\hat{C}F_B\hat{G}_B|TM_A)_{\mathcal{C}^T \otimes \mathcal{C}^{M_A}(\Gamma) \otimes \Phi_{2^{\epsilon_0}}} \quad (326)$$

$$\geq H_{\min}^{7\epsilon+6\sqrt{\delta}}(\hat{G}_B|TM_A)_{\mathcal{C}^T \otimes \mathcal{C}^{M_A}(\Gamma) \otimes \Phi_{2^{\epsilon_0}}} + H_{\min}^{\epsilon}(\hat{B}\hat{C}F_B|T\hat{G}_B M_A)_{\mathcal{C}^T \otimes \mathcal{C}^{M_A}(\Gamma) \otimes \Phi_{2^{\epsilon_0}}} - f(\epsilon). \quad (327)$$

Inequality (322) is due to the fact that \mathcal{C}^M does not change the reduced state on $\hat{B}E_B Q T$; (323) from the monotonicity of the conditional entropy (Lemma 13); (324) from the property of the conditional entropy for classical-quantum states (Lemma 23) and the fact that M_A is a classical copy of M as (247); (325) from the fact that Ψ_f is obtained from $\tilde{\Psi}$ by the isometry $U_{\mathcal{D}}$ as (236), under which the smooth conditional entropy is invariant; (326) from the continuity (Lemma 20) and the fact that $\Gamma \otimes \Phi_{2^{\epsilon_0}}$ is $2\sqrt{\delta}$ -close to Ψ_f as (239); and (327) from the chain rule (359).

The second term in (327) is further calculated as

$$H_{\min}^{\epsilon}(\hat{B}\hat{C}F_B|T\hat{G}_B M_A)_{\mathcal{C}^T \otimes \mathcal{C}^{M_A}(\Gamma) \otimes \Phi_{2^{\epsilon_0}}} \quad (328)$$

$$\geq H_{\min}^{\epsilon}(\hat{B}\hat{C}|T\hat{G}_B M_A)_{\mathcal{C}^T \otimes \mathcal{C}^{M_A}(\Gamma)} + e_0 \quad (329)$$

$$\geq H_{\min}^{\epsilon}(\hat{B}\hat{C}|T\hat{G}_B M_A)_{\mathcal{C}^T(\Gamma)} + e_0 \quad (330)$$

$$= H_{\min}^{\epsilon}(\hat{B}\hat{C}|T)_{\mathcal{C}^T(\Gamma)} + e_0 \quad (331)$$

$$= H_{\min}^{\epsilon}(\hat{B}\hat{C}|T)_{\Psi_s} + e_0 \quad (332)$$

$$= H_{\min}^{\epsilon}(BC|XYZ)_{\Psi_s} + e_0, \quad (333)$$

where (329) follows from the superadditivity of the smooth conditional entropy (Lemma 16); (330) from the monotonicity of the smooth conditional entropy (Lemma 13); (331) from Lemma 25 and the fact that the state $\mathcal{C}^T(\Gamma)$ is decoupled between $\hat{B}\hat{C}$ and $\hat{G}_B M_A$ when conditioned by T as (250); (332) from Equality (252); and (333) from Lemma 23.

The first term in (327) is calculated as

$$H_{\min}^{7\epsilon+6\sqrt{\delta}}(\hat{G}_B|TM_A)_{\mathcal{C}^T \otimes \mathcal{C}^{M_A}(\Gamma)} \quad (334)$$

$$= H_{\min}^{7\epsilon+6\sqrt{\delta}}(G_A|TM_A)_{\Gamma} \quad (335)$$

$$= H_{\min}^{7\epsilon+6\sqrt{\delta}}(G_A|M_A XYZ)_{\Gamma} \quad (336)$$

$$= H_{\min}^{7\epsilon+6\sqrt{\delta}}(G_A|M_A AXYZ)_{\Gamma}, \quad (337)$$

where (335) is from $\hat{G}_B = G_B M_B$, Equality (256) and Lemma 27; (336) from Lemma 23 and the fact that $T = X'Y'Z'$ is a copy of XYZ as (238); and (337) from Lemma 25 and the fact that the state Γ is decoupled between A and G_A when conditioned by $M_A XYZ$ as (257).

Combining these all together, we arrive at

$$\begin{aligned} e + e_0 + H_{\min}^{11\epsilon+8\sqrt{\delta}}(B|XYZ)_{\Psi_s} \\ \geq -q + H_{\min}^{7\epsilon+6\sqrt{\delta}}(G_A|M_A AXYZ)_{\Gamma} \\ + H_{\min}^{\epsilon}(BC|XYZ)_{\Psi_s} + e_0 - 2f(\epsilon). \end{aligned} \quad (338)$$

This completes the proof of Inequality (261). ■

6.3 Proof of Theorem 3 from Inequalities (258)-(261)

Since Γ is diagonal in $M_A XYZ$ as (257), and due to the properties of the smooth conditional entropies for classical-quantum states (Lemma 25), we have

$$H_{\min}^{5\epsilon+2\sqrt{\delta}}(G_A M_A|XYZ)_{\Gamma} \geq 0, \quad (339)$$

$$H_{\min}^{7\epsilon+6\sqrt{\delta}}(G_A|M_A AXYZ)_{\Gamma} \geq 0. \quad (340)$$

Thus, Inequalities (260) and (261) implies Inequalities (30) and (31) in Theorem 3, respectively. Summing up both sides in (259) and (260) yields

$$\begin{aligned} c + 2q &\geq H_{\min}^{\epsilon}(AC|XYZ)_{\Psi_s} - H_{\max}^{\epsilon}(A|XYZ)_{\Psi_s} \\ &\quad + H_{\min}^{\epsilon}(BYCZ)_{\Psi_s} \\ &\quad - H_{\min}^{12\epsilon+6\sqrt{\delta}}(BY)_{\Psi_s} - 4f(\epsilon) \\ &= \tilde{H}_I^{(\epsilon,\delta)} - 4f(\epsilon). \end{aligned} \quad (341)$$

Similarly, combining Inequalities (258) and (261), we obtain

$$\begin{aligned}
c + 2q &\geq H_{\min}^{\epsilon}(AXCZ)_{\Psi_s} - H_{\max}^{\epsilon}(AXZ)_{\Psi_s} \\
&\quad + H_{\min}^{\epsilon}(BC|XYZ)_{\Psi_s} \\
&\quad - H_{\min}^{11\epsilon+8\sqrt{\delta}}(B|XYZ)_{\Psi_s} \\
&\quad - H_{\min}^{7\epsilon+2\sqrt{\delta}}(G_A|M_A AXZ)_{\Gamma} \\
&\quad + H_{\min}^{7\epsilon+6\sqrt{\delta}}(G_A|M_A AXYZ)_{\Gamma} - 6f(\epsilon)
\end{aligned} \tag{342}$$

$$= \tilde{H}'_{II}(\epsilon, \delta) - \Delta'_{\Gamma}(\epsilon, \delta) - 6f(\epsilon), \tag{343}$$

where we have defined

$$\begin{aligned}
\Delta'_{\Gamma}(\epsilon, \delta) &:= H_{\min}^{7\epsilon+2\sqrt{\delta}}(G_A|M_A AXZ)_{\Gamma} \\
&\quad - H_{\min}^{7\epsilon+6\sqrt{\delta}}(G_A|M_A AXYZ)_{\Gamma}.
\end{aligned} \tag{344}$$

In the following, we prove that

$$\Delta'_{\Gamma}(\epsilon, \delta) \leq \Delta(\epsilon, \delta). \tag{345}$$

Combining this with (343) in addition to (341), we arrive at Inequality (29) in Theorem 3.

We start by noting that

$$\begin{aligned}
\Delta'_{\Gamma}(\epsilon, \delta) &= H_{\min}^{7\epsilon+2\sqrt{\delta}}(G_A|M_A AX'Z')_{\Gamma} \\
&\quad - H_{\min}^{7\epsilon+6\sqrt{\delta}}(G_A|M_A AX'Y'Z')_{\Gamma}
\end{aligned} \tag{346}$$

$$\leq \tilde{I}_{\min}^{7\epsilon+4\sqrt{\delta}}(G_A : Y'|M_A AX'Z')_{\tilde{\Psi}} \tag{347}$$

The first line follows from Lemma 23 and the fact that XYZ is a copy of $X'Y'Z'$ as (238), and the second line from the continuity bounds for the smooth conditional entropy (Lemma 20) and the definition of the smooth conditional min mutual information (15). Hence, it suffices to prove that there exists an operation $\mathcal{F} : \hat{A}\hat{C} \rightarrow AG_AM_A$ satisfying

$$\mathcal{F}(\Psi_s^{\hat{A}\hat{C}\hat{R}}) = \tilde{\Psi}^{AG_AM_A\hat{R}}, \quad \mathcal{C}^{M_A} \circ \mathcal{F} = \mathcal{F} \tag{348}$$

and that $\tilde{\Psi}$ satisfies the condition

$$\inf_{\{\omega_{xyz}\}} P\left(\tilde{\Psi}^{AG_AM_A\hat{R}}, \sum_{x,y,z} p_{xyz} \psi_{xyz}^{A\hat{R}} \otimes \omega_{xyz}^{G_AM_A}\right) \leq 2\sqrt{\delta}. \tag{349}$$

Recall that the state $|\tilde{\Psi}\rangle$ is obtained by an encoding isometry $U_{\mathcal{E}}^{\hat{A}\hat{C}E_A \rightarrow \hat{A}QMFA\hat{G}_A}$ from $|\Psi\rangle|\Phi_{2^e+\epsilon_0}\rangle$ as (235), where $\hat{G}_A = G_AM_A Z''$. We define an operation $\mathcal{F} : \hat{A}\hat{C} \rightarrow AG_AM_A$ by

$$\mathcal{F}(\tau) := \text{Tr}_{QMFA XZ''} \circ \mathcal{U}_{\mathcal{E}}(\tau \otimes \pi_{2^e+\epsilon_0}^{E_A}). \tag{350}$$

Noting that $U_{\mathcal{E}}$ is in the form of (242), this implies (348). To obtain the decoupling condition (349), note that, since $\tilde{\Psi}$ is converted by an operation by Bob to Ψ_f as (236), it holds that $\tilde{\Psi}^{AG_AM_A\hat{R}} = \Psi_f^{AG_AM_A\hat{R}}$. Thus, tracing out $\hat{B}\hat{C}F_A F_B \hat{G}_B XZ''$ in (239), we obtain

$$P\left(\tilde{\Psi}^{A\hat{R}G_AM_A}, \Gamma^{A\hat{R}G_AM_A}\right) \leq 2\sqrt{\delta}. \tag{351}$$

Due to (238), the state Γ is in the form of

$$\Gamma^{A\hat{R}G_AM_A} = \sum_{x,y,z} p_{xyz} \psi_{xyz}^{A\hat{R}} \otimes \phi_{xyz}^{G_AM_A} \otimes |xyz\rangle\langle xyz|^T. \tag{352}$$

This implies (349) and completes the proof of Inequality (29). \blacksquare

6.4 Property of $\Delta(\epsilon, \delta)$ (Proof of Lemma 5)

Due to the definition of the smooth conditional min mutual information (15) and (34), it is straightforward to verify that $\Delta^{\epsilon, \delta} \geq 0$. The equality holds if $Y' \cong Y$ is a one-dimensional system, that is, if there is no classical side information at the decoder. In the case where there is neither quantum message nor quantum side information at the encoder, i.e.

$$d_A = d_C = 1, \quad \hat{A} = X, \quad \hat{C} = Z, \tag{353}$$

the source state Ψ_s is represented as

$$\Psi_s^{XZ\hat{B}\hat{R}} = \sum_{x,y,z} p_{xyz} |x\rangle\langle x|^X \otimes |y\rangle\langle y|^Y \otimes |z\rangle\langle z|^Z \otimes \psi_{xyz}^{B\hat{R}}. \tag{354}$$

Thus, for any CPTP map $\mathcal{F} : XZ \rightarrow G_AM_A$, we have

$$\mathcal{F}(\Psi_s)^{G_AM_A\hat{R}} = \sum_{x,y,z} p_{xyz} \omega_{xz}^{G_AM_A} \otimes \psi_{xyz}^{\hat{R}}, \tag{355}$$

where $\omega_{xz} := \mathcal{F}(|x\rangle\langle x|^X \otimes |z\rangle\langle z|^Z)$. It follows that

$$\begin{aligned}
&\mathcal{F}(\Psi_s)^{G_AM_A X'Y'Z'} \\
&= \sum_{x,z} p_{xz} \omega_{xz}^{G_AM_A} \otimes |xz\rangle\langle xz|^{X'Z'} \\
&\quad \otimes \left(\sum_y p_{y|xz} |y\rangle\langle y|^{Y'} \right),
\end{aligned} \tag{356}$$

and consequently, $\tilde{I}_{\min}^{7\epsilon+4\sqrt{\delta}}(G_A : Y'|M_A X'Z') = 0$. This implies $\Delta^{\epsilon, \delta} = 0$, and completes the proof of Lemma 5. \blacksquare

7 Conclusion

In this paper, we investigated the state redistribution of classical and quantum hybrid sources in the one-shot scenario. We analyzed the costs of classical communication, quantum communication and entanglement. We obtained the direct bound and the converse bound for those costs in terms of smooth conditional entropies. In most of the cases that have been analyzed in the previous literatures, the two bounds coincide in the asymptotic limit of infinitely many copies and vanishingly small error. Various coding theorems for two-party source coding tasks are systematically obtained by reduction from our results, including the ones that have not been analyzed in the previous literatures.

To investigate the protocol that are covered by our result, but have not been addressed in the previous literature, in detail is left as a future work. Another direction is to explore the family of quantum communication protocols in the presence of classical side information only at the decoder. It would also be beneficial to analyze the relation between our results and the one-shot bounds for entanglement-assisted communication of classical and quantum messages via a noisy quantum channel [32].

Acknowledgement

This work was supported by JSPS KAKENHI (Grant No. 18J01329), and by JST, PRESTO Grant Number JPMJPR1865, Japan.

References

- [1] Anura Abeyesinghe, Igor Devetak, Patrick Hayden, and Andreas Winter, “The mother of all protocols: restructuring quantum information’s family tree”, *Proc. Roy. Soc. A* 465(2108):2537–2563 (2009)
- [2] Anurag Anshu, Rahul Jain, and Naqeeb Ahmad Warsi, “A one-shot achievability result for quantum state redistribution”, *IEEE Trans. Inf. Theory* 64(3): 1425–1435 (2018)
- [3] Anurag Anshu, Min-Hsiu Hsieh, and Rahul Jain, “Noisy quantum state redistribution with promise and the alpha-bit”, *IEEE Trans. Inf. Theory* 66(12): 7772–7786 (2020)
- [4] Zahra Baghali Khanian and Andreas Winter, “Distributed compression of correlated classicalquantum sources or: The price of ignorance”, *IEEE Trans. Inf. Theory* 66(9): 5620–5633 (2020)
- [5] Mario Berta, Matthias Christandl, Roger Colbeck, Joseph M. Renes, and Renato Renner, “The uncertainty principle in the presence of quantum memory”, *Nat. Phys.* 6(9): 659–662 (2010)
- [6] Mario Berta, Matthias Christandl, and Renato Renner, “The quantum reverse shannon theorem based on one-shot information theory”, *Comm. Math. Phys.* 306(3):579–615 (2011)
- [7] Mario Berta, Matthias Christandl, and Dave Touchette, “Smooth entropy bounds on one-shot quantum state redistribution”, *IEEE Trans. Inf. Theory* 62(3):1425–1439 (2016)
- [8] T. M. Cover and J. A. Thomas, *Elements of Information Theory (2nd ed.)*, Wiley Inter-Science, 2005.
- [9] Nilanjana Datta and Min-Hsiu Hsieh, “The apex of the family tree of protocols: optimal rates and resource inequalities”, *New J. Phys.* 13, 093042 (2011)
- [10] Nilanjana Datta, Min-Hsiu Hsieh, and Jonathan Oppenheim, “An upper bound on the second order asymptotic expansion for the quantum communication cost of state redistribution”, *J. Math. Phys.* 57(5), 052203 (2016)
- [11] I Devetak and A Winter, “Classical data compression with quantum side information”, *Phys. Rev. A* 68(4), 042301 (2003)
- [12] I Devetak, AW Harrow, and A Winter, “A family of quantum protocols”, *Phys. Rev. Lett.* 93(23), 230504 (2004)
- [13] Igor Devetak and Jon Yard, “Exact cost of redistributing multipartite quantum states”, *Phys. Rev. Lett.* 100(23), 230501 (2008)
- [14] Igor Devetak, Aram W. Harrow, and Andreas J. Winter, “A resource framework for quantum shannon theory”, *IEEE Trans. Inf. Theory* 54(10):4587-4618 (2008)
- [15] Frederic Dupuis, Mario Berta, Juerg Wullschleger, and Renato Renner, “One-shot decoupling”, *Comm. Math. Phys.* 328(1):251-284 (2014)

- [16] M Horodecki, J Oppenheim, and A Winter, “Partial quantum information”, *Nature* 436 (7051): 673–676 (2005)
- [17] Michal Horodecki, Jonathan Oppenheim, and Andreas Winter, “Quantum state merging and negative information”, *Comm. Math. Phys.* 269(1):107–136 (2007)
- [18] Min-Hsiu Hsieh and Mark M. Wilde, “Trading classical communication, quantum communication, and entanglement in quantum Shannon theory”, *IEEE Trans. Inf. Theory* 56(9): 4705–4730 (2010)
- [19] Robert Koenig, Renato Renner, and Christian Schaffner, “The operational meaning of min- and max-entropy”, *IEEE Trans. Inf. Theory* 55(9): 4337–4347 (2009)
- [20] T Ogawa and H Nagaoka, “A new proof of the channel coding theorem via hypothesis testing in quantum information theory”, In *ISIT: 2002 IEEE Int. Symp. Info.Theory, Proceedings*, page 73
- [21] Joseph M. Renes and Renato Renner, “One-shot classical data compression with quantum side information and the distillation of common randomness or secret keys”, *IEEE Trans. Inf. Theory* 58(3):1985–1991 (2012)
- [22] R Renner and S Wolf, “Simple and tight bounds for information reconciliation and privacy amplification”, In *Advances in Cryptology - ASIACRYPT 2005*, pp.199–216, Springer, Berlin, Heidelberg
- [23] Renato Renner, “Security of quantum key distribution”, *Int. J. Quant. Info.* 6(1): 1–127, (2008)
- [24] Benjamin Schumacher, “Quantum coding”, *Phys. Rev. A* 51(4):2738–2747 (1995)
- [25] W Forrest Stinespring, “Positive functions on c^* algebras”, *Proc. of the Amer. Math. Soc.*, 6(2): 211–216 (1955)
- [26] M. Tomamichel, *Quantum Information Processing with Finite Resources*, Springer Briefs in Mathematical Physics, 2016
- [27] Marco Tomamichel and Masahito Hayashi, “A hierarchy of information quantities for finite block length analysis of quantum tasks”, *IEEE Trans. Inf. Theory* 59(11):7693–7710 (2013)
- [28] Marco Tomamichel, Roger Colbeck, and Renato Renner, “A fully quantum asymptotic equipartition property”, *IEEE Trans. Inf. Theory* 55(12):5840–5847 (2009)
- [29] Marco Tomamichel, Roger Colbeck, and Renato Renner, “Duality between smooth min- and max-entropies”, *IEEE Trans. Inf. Theory* 56(9):4674–4681 (2010)
- [30] Armin Uhlmann, “The “transition probability” in the state space of a $*$ -algebra”, *Rep. Math. Phys.*, 9(2):273–279 (1976)
- [31] Alexander Vitanov, Frederic Dupuis, Marco Tomamichel, and Renato Renner, “Chain rules for smooth min- and max-entropies”, *IEEE Trans. Inf. Theory* 59(5):2603–2612 (2013)
- [32] Eyuri Wakakuwa and Yoshifumi Nakata, “Randomized partial decoupling unifies one-shot quantum channel capacities”, [arXiv:2004.12593](https://arxiv.org/abs/2004.12593) (2020)
- [33] Eyuri Wakakuwa and Yoshifumi Nakata, “One-shot randomized and nonrandomized partial decoupling”, *Comm. Math. Phys.* 386(2):589–649 (2021)
- [34] Mark Wilde, *Quantum Information Theory*, Camb. Univ. Press, 2013
- [35] Jon T. Yard and Igor Devetak, “Optimal quantum source coding with quantum side information at the encoder and decoder”, *IEEE Trans. Inf. Theory* 55 (11):5339–5351 (2009)
- [36] Ming-Yong Ye, Yan-Kui Bai, and Z. D. Wang, “Quantum state redistribution based on a generalized decoupling”, *Phys. Rev. A* 78(3) (2008)

A Definitions and Properties of Smooth Entropies

In this appendix, we summarize the properties of the smooth conditional entropies that are used in the main text. For the properties of the purified distance used in some of the proofs, see Appendix B.

A.1 Basic Properties

Lemma 12 (duality: see e.g. [29]) For any subnormalized pure state $|\psi\rangle$ on system ABC , and for any $\epsilon > 0$, $H_{\max}^\epsilon(A|B)_\psi = -H_{\min}^\epsilon(A|C)_\psi$.

Lemma 13 (monotonicity: Theorem 18 in [29] and Theorem 6.2 in [26]) For any $\rho^{AB} \in \mathcal{S}_{\leq}(\mathcal{H}^{AB})$, $0 \leq \epsilon \leq \sqrt{\text{Tr}[\rho]}$, any unital CPTP map $\mathcal{E} : A \rightarrow C$ and any CPTP map $\mathcal{F} : B \rightarrow D$, it holds that $H_{\min}^\epsilon(A|B)_\rho \leq H_{\min}^\epsilon(C|D)_{\mathcal{E} \otimes \mathcal{F}(\rho)}$.

Lemma 14 (isometric invariance: Lemma 13 in [29]) For any $\epsilon \geq 0$, $\rho^{AB} \in \mathcal{S}_{\leq}(\mathcal{H}^{AB})$ and any linear isometries $U : A \rightarrow C$ and $V : B \rightarrow D$, $H_{\min}^\epsilon(A|B)_\rho = H_{\min}^\epsilon(C|D)_{U \otimes V(\rho)}$.

Lemma 15 (additivity: see Section I C in [19]) For any $\rho \in \mathcal{S}(\mathcal{H}^{AB})$ and $\sigma \in \mathcal{S}(\mathcal{H}^{CD})$, it holds that

$$H_{\max}(AC|BD)_{\rho \otimes \sigma} = H_{\max}(A|B)_\rho + H_{\max}(C|D)_\sigma. \quad (357)$$

Lemma 16 (superadditivity: Lemma A.2 in [15]) For any states ρ^{AB} , σ^{CD} and any $\epsilon, \epsilon' \geq 0$, it holds that

$$H_{\min}^{\epsilon+\epsilon'}(AC|BD)_{\rho \otimes \sigma} \geq H_{\min}^\epsilon(A|B)_\rho + H_{\min}^{\epsilon'}(C|D)_\sigma. \quad (358)$$

Lemma 17 (chain rule: see [31]) For any $\epsilon > 0$, $\epsilon', \epsilon'' \geq 0$ and $\rho \in \mathcal{S}_{\leq}(\mathcal{H}^{ABC})$, it holds that

$$H_{\min}^{\epsilon+\epsilon'+2\epsilon''}(AB|C)_\rho \geq H_{\min}^{\epsilon'}(B|C)_\rho + H_{\min}^{\epsilon''}(A|BC)_\rho - f(\epsilon), \quad (359)$$

$$H_{\min}^{\epsilon'}(AB|C)_\rho \leq H_{\max}^{\epsilon''}(B|C)_\rho + H_{\min}^{\epsilon+\epsilon'+2\epsilon''}(A|BC)_\rho + 2f(\epsilon), \quad (360)$$

where

$$f(\epsilon) := -\log(1 - \sqrt{1 - \delta^2}). \quad (361)$$

Lemma 18 (dimension bounds: Corollary of Lemma 20 in [29]) For any state ρ^{AB} and $\epsilon \geq 0$, it holds that

$$H_{\min}^\epsilon(A|B)_\rho \geq -\log d_A, \quad (362)$$

$$H_{\max}^\epsilon(A|B)_\rho \leq \log d_A. \quad (363)$$

Lemma 19 (dimension bound: Lemma 21 in [9]) For any state ρ^{ABC} and $\epsilon > 0$, it holds that

$$H_{\min}^\epsilon(AB|C)_\rho \leq H_{\min}^\epsilon(A|C)_\rho + \log d_B. \quad (364)$$

Lemma 20 (continuity) For any $\epsilon, \delta \geq 0$, any ρ^{AB} and $\sigma^{AB} \in \mathcal{B}^\delta(\rho)$, it holds that

$$H_{\min}^{\epsilon+\delta}(A|B)_\rho \geq H_{\min}^\epsilon(A|B)_\sigma. \quad (365)$$

Proof: Let $\hat{\sigma}^{AB} \in \mathcal{B}^\epsilon(\sigma)$ be such that $H_{\min}^\epsilon(A|B)_\sigma = H_{\min}(A|B)_{\hat{\sigma}}$. Due to the triangle inequality for the purified distance, it holds that

$$P(\rho, \hat{\sigma}) \leq P(\rho, \sigma) + P(\sigma, \hat{\sigma}) \leq \epsilon + \delta, \quad (366)$$

which implies $\hat{\sigma} \in \mathcal{B}^{\epsilon+\delta}(\rho)$. Thus, we obtain Inequality (365) as

$$H_{\min}^\epsilon(A|B)_\sigma = H_{\min}(A|B)_{\hat{\sigma}} \leq \sup_{\hat{\rho} \in \mathcal{B}^{\epsilon+\delta}(\rho)} H_{\min}(A|B)_{\hat{\rho}} = H_{\min}^{\epsilon+\delta}(A|B)_\rho. \quad (367)$$

■

Lemma 21 (one-dimensional system.) Suppose that $d_A = 1$. For any $\epsilon \geq 0$ and $\rho \in \mathcal{S}(\mathcal{H}^{AB})$, it holds that

$$0 \leq H_{\min}^\epsilon(A|B)_\rho \leq -\log(1 - 2\epsilon), \quad (368)$$

$$0 \geq H_{\max}^\epsilon(A|B)_\rho \geq \log(1 - 2\epsilon). \quad (369)$$

Proof: Since $d_A = 1$, there exists a fixed vector $|e\rangle \in \mathcal{H}^A$ such that $I^A = |e\rangle\langle e|$ and that any $\tilde{\rho} \in \mathcal{S}_{\leq}(\mathcal{H}^{AB})$ is represented as $|e\rangle\langle e|^A \otimes \tilde{\rho}^B$. Due to the definition of the smooth conditional min entropy, we have

$$H_{\min}^\epsilon(A|B)_\rho \geq H_{\min}(A|B)_\rho \quad (370)$$

$$= \sup_{\sigma^B \in \mathcal{S}_{=}(\mathcal{H}^B)} H_{\min}(A|B)_{\rho|\sigma} \quad (371)$$

$$\geq H_{\min}(A|B)_{\rho^{AB}|\rho^B} \quad (372)$$

$$= \sup\{\lambda \in \mathbb{R} | 2^{-\lambda} I^A \otimes \rho^B \geq \rho^{AB}\} \quad (373)$$

$$= \sup\{\lambda \in \mathbb{R} | 2^{-\lambda} |e\rangle\langle e|^A \otimes \rho^B \geq |e\rangle\langle e|^A \otimes \rho^B\} \quad (374)$$

$$= 0. \quad (375)$$

This implies the first inequality in (368). To prove the second inequality in (368), let $\hat{\rho} \in \mathcal{B}^\epsilon(\rho)$ and $\sigma^B \in \mathcal{S}_{=}(\mathcal{H}^B)$ be such that

$$H_{\min}^\epsilon(A|B)_\rho = H_{\min}(A|B)_{\hat{\rho}} = H_{\min}(A|B)_{\hat{\rho}|\sigma}. \quad (376)$$

By definition, it holds that

$$2^{-H_{\min}^\epsilon(A|B)_\rho} I^A \otimes \sigma^B \geq \hat{\rho}^{AB}, \quad (377)$$

which is equivalent to

$$2^{-H_{\min}^\epsilon(A|B)_\rho} |e\rangle\langle e|^A \otimes \sigma^B \geq |e\rangle\langle e|^A \otimes \hat{\rho}^B. \quad (378)$$

By taking the trace in both sides, we obtain

$$2^{-H_{\min}^\epsilon(A|B)_\rho} \geq \text{Tr}[\hat{\rho}]. \quad (379)$$

The R.H.S. of the above inequality is evaluated as

$$\text{Tr}[\hat{\rho}] = \|\hat{\rho}\|_1 \geq \|\rho\|_1 - \|\rho - \hat{\rho}\|_1 \geq 1 - 2\epsilon, \quad (380)$$

where the last line follows from (6) and the condition $\hat{\rho} \in \mathcal{B}^\epsilon(\rho)$. This implies the second inequality in (368). Inequality (369) follows due to the duality relation (Lemma 12). ■

A.2 Classical-Quantum States

Lemma 22 (Lemma A.5 in [15]) For any state $\rho^{ABK} \in \mathcal{S}_{=}(\mathcal{H}^{ABK})$ in the form of

$$\rho^{ABK} = \sum_k p_k \rho_k^{AB} \otimes |k\rangle\langle k|^K, \quad (381)$$

where $\rho_k \in \mathcal{S}_{=}(\mathcal{H}^{AB})$, $\langle k|k'\rangle = \delta_{k,k'}$ and $\{p_k\}_k$ is a normalized probability distribution, it holds that

$$H_{\min}(A|BK)_\rho = -\log\left(\sum_k p_k \cdot 2^{-H_{\min}(A|B)_{\rho_k}}\right). \quad (382)$$

Lemma 23 (Lemma A.7 in [15]) For any state $\rho^{ABK_1K_2} \in \mathcal{S}_{\leq}(\mathcal{H}^{ABK_1K_2})$ in the form of

$$\rho^{ABK_1K_2} = \sum_k p_k \rho_k^{AB} \otimes |k\rangle\langle k|^{K_1} \otimes |k\rangle\langle k|^{K_2}, \quad (383)$$

where $\langle k|k'\rangle = \delta_{k,k'}$, and for any $\epsilon \geq 0$, it holds that

$$H_{\min}^{\epsilon}(AK_1|BK_2)_{\rho} = H_{\min}^{\epsilon}(A|BK_2)_{\rho} = H_{\min}^{\epsilon}(A|BK_1)_{\rho}. \quad (384)$$

Lemma 24 (Lemma 29 in [33]) In the same setting as in Lemma 23, it holds that

$$H_{\max}^{\epsilon}(AK_1|BK_2)_{\rho} = H_{\max}^{\epsilon}(A|BK_2)_{\rho} = H_{\max}^{\epsilon}(A|BK_1)_{\rho}. \quad (385)$$

Lemma 25 Consider a state in the form of

$$\rho^{ACK} = \sum_k p_k \rho_k^A \otimes \sigma_k^C \otimes |k\rangle\langle k|^K. \quad (386)$$

For any $\epsilon > 0$, it holds that

$$H_{\min}^{\epsilon}(A|CK)_{\rho} = H_{\min}^{\epsilon}(A|K)_{\rho} \geq 0. \quad (387)$$

Proof: It is straightforward to verify that there exists a quantum operation $\mathcal{E} : K \rightarrow CK$ such that $\rho^{ACK} = \mathcal{E}(\rho^{AK})$. Due to the monotonicity of the smooth conditional min entropy under operations on the conditioning system, we have

$$H_{\min}^{\epsilon}(A|K)_{\rho^{AK}} \leq H_{\min}^{\epsilon}(A|CK)_{\rho^{ACK}} = H_{\min}^{\epsilon}(A|CK)_{\mathcal{E}(\rho^{AK})} \leq H_{\min}^{\epsilon}(A|K)_{\rho^{AK}}, \quad (388)$$

which implies $H_{\min}^{\epsilon}(A|CK)_{\rho} = H_{\min}^{\epsilon}(A|K)_{\rho}$. The non-negativity follows due to Lemma 22 as

$$H_{\min}^{\epsilon}(A|K)_{\rho} \geq H_{\min}(A|K)_{\rho} = -\log \left(\sum_k p_k \cdot 2^{-H_{\min}(A)_{\rho_k}} \right) \geq -\log \left(\sum_k p_k \right) = 0, \quad (389)$$

which completes the proof. ■

A.3 Classically-labelled Pure States

Lemma 26 Consider a state in the form of

$$\rho^{ABCK} = \sum_k p_k |\psi_k\rangle\langle\psi_k|^{ABC} \otimes |k\rangle\langle k|^K. \quad (390)$$

For any $\epsilon > 0$, it holds that

$$H_{\max}^{\epsilon}(A|BK)_{\rho} = -H_{\min}^{\epsilon}(A|CK)_{\rho}. \quad (391)$$

Proof: It is straightforward to verify that a purification of the state ρ , defined by (390), is given by

$$|\psi_{\rho}\rangle^{ABCKK'} = \sum_k \sqrt{p_k} |\psi_k\rangle^{ABC} |k\rangle^K |k\rangle^{K'}. \quad (392)$$

Due to the duality of the smooth conditional entropies (Lemma 12), we have

$$H_{\max}^{\epsilon}(A|BK)_{\rho} = H_{\max}^{\epsilon}(A|BK)_{\psi_{\rho}} = -H_{\min}^{\epsilon}(A|CK')_{\psi_{\rho}} = -H_{\min}^{\epsilon}(A|CK)_{\rho}, \quad (393)$$

which completes the proof. ■

Lemma 27 Consider the same setting as in Lemma 26. For any $\epsilon > 0$, it holds that

$$H_{\min}^\epsilon(A|K)_\rho = H_{\min}^\epsilon(B|K)_\rho. \quad (394)$$

Proof: To prove (394), let $\hat{\rho}^{AK} \in \mathcal{B}^\epsilon(\rho)$ and $\varsigma \in \mathcal{S}_=(\mathcal{H}^K)$ be such that

$$H_{\min}^\epsilon(A|K)_\rho = H_{\min}(A|K)_{\hat{\rho}} = H_{\min}(A|K)_{\hat{\rho}|\varsigma}. \quad (395)$$

With \mathcal{C} being the completely dephasing operation on K with respect to the basis $\{|k\rangle\}_k$, it holds that

$$P(\mathcal{C}(\hat{\rho}), \mathcal{C}(\rho)) \leq P(\hat{\rho}, \rho) \leq \epsilon. \quad (396)$$

In addition, if

$$2^{-\lambda} I^A \otimes \varsigma^K \geq \hat{\rho}^{AK}, \quad (397)$$

then

$$2^{-\lambda} I^A \otimes \mathcal{C}(\varsigma)^K \geq \text{id}^A \otimes \mathcal{C}^K(\hat{\rho}^{AK}). \quad (398)$$

Thus, without loss of generality, we may assume that both $\hat{\rho}^{AK}$ and ς are diagonal in $\{|k\rangle\}_k$. That is, we may assume that $\hat{\rho}^{AK}$ and ς are in the form of

$$\hat{\rho}^{AK} = \sum_k \hat{p}_k \hat{\rho}_k^A \otimes |k\rangle\langle k|^K, \quad \varsigma = \sum_k q_k |k\rangle\langle k|. \quad (399)$$

Suppose that the Schmidt decomposition of $|\psi_k\rangle$ is given by

$$|\psi_k\rangle = \sum_j \sqrt{\mu_{j|k}} |e_{j|k}\rangle^A |f_{j|k}\rangle^B, \quad (400)$$

Define linear operators $v_k : \mathcal{H}^A \rightarrow \mathcal{H}^B$ and $V : \mathcal{H}^A \otimes \mathcal{H}^K \rightarrow \mathcal{H}^B \otimes \mathcal{H}^K$ by

$$v_k := \sum_j |f_{j|k}\rangle^B \langle e_{j|k}|^A \quad (\forall k) \quad (401)$$

and $V := \sum_k v_k \otimes |k\rangle\langle k|^K$. It is straightforward to verify that $\rho^{BK} = V \rho^{AK} V^\dagger$. Thus, due to the monotonicity of the purified distance under trace non-increasing CP maps (Lemma 7 in [29]), it holds that

$$P(\rho^{BK}, V \hat{\rho}^{AK} V^\dagger) \leq P(\rho^{AK}, \hat{\rho}^{AK}) \leq \epsilon. \quad (402)$$

Applying V to the both sides in condition (397), it follows that

$$2^{-\lambda} V(I^A \otimes \varsigma^K) V^\dagger \geq V \hat{\rho}^{AK} V^\dagger. \quad (403)$$

Noting that $I^B \geq (v_k^\dagger v_k)^B$, this implies that

$$2^{-\lambda} I^B \otimes \varsigma^K \geq V \hat{\rho}^{AK} V^\dagger. \quad (404)$$

Thus, we arrive at

$$H_{\min}^\epsilon(A|K)_\rho \leq H_{\min}^\epsilon(B|K)_\rho. \quad (405)$$

By exchanging the roles of A and B , we also obtain the converse inequality. This completes the proof of Equality (394).

B Properties of The Purified Distance

We summarize the properties of the purified distance, used in Appendix A to prove the properties of the smooth conditional entropies.

Lemma 28 (monotonicity: Lemma 7 in [29]) *For any subnormalized states $\rho, \sigma \in \mathcal{S}_{\leq}(\mathcal{H})$ and for any completely positive trace non-increasing map \mathcal{E} , it holds that $P(\rho, \sigma) \geq P(\mathcal{E}(\rho), \mathcal{E}(\sigma))$. Consequently, for any linear isometry \mathcal{U} , it holds that $P(\rho, \sigma) = P(\mathcal{U}(\rho), \mathcal{U}(\sigma))$*

Lemma 29 *For any normalized state ρ on system A and any normalized pure state $|\phi\rangle$ on system AB , the purified distance satisfies*

$$P(\rho^A, \phi^A) = \min_{|\psi\rangle_{AB}} P(|\psi\rangle\langle\psi|, |\phi\rangle\langle\phi|) = \sqrt{1 - \max_{|\psi\rangle_{AB}} |\langle\psi|\phi\rangle|^2}, \quad (406)$$

where the minimum and the maximum are taken over all purifications $|\psi\rangle$ of ρ .

Proof: Follows from Definition 4 and Lemma 8 in [29]. ■

Lemma 30 *Consider a state Γ on KAB and a pure state $|\Psi\rangle$ on $KABC$ in the form of*

$$|\Psi\rangle = \sum_k \sqrt{p_k} |k\rangle^K |\psi_k\rangle^{ABCD}, \quad \Gamma = \sum_k p_k |k\rangle\langle k|^K \otimes |\gamma_k\rangle\langle\gamma_k|^{AB}. \quad (407)$$

There exists a set of pure states $\{|\phi_k\rangle\}_k$ on CD such that, for the state

$$|\tilde{\Gamma}\rangle = \sum_k \sqrt{p_k} |k\rangle^K |\gamma_k\rangle^{AB} |\phi_k\rangle^{CD}, \quad (408)$$

it holds that

$$P(|\tilde{\Gamma}\rangle\langle\tilde{\Gamma}|, |\Psi\rangle\langle\Psi|) = P(\Gamma^{KAB}, \mathcal{C}^K \circ \text{Tr}_{CD}(|\Psi\rangle\langle\Psi|)), \quad (409)$$

where \mathcal{C} is the completely dephasing operation on K with respect to the basis $\{|k\rangle\}_k$.

Proof: It is straightforward to verify that a purification of the state $\mathcal{C}^K \circ \text{Tr}_{CD}(|\Psi\rangle\langle\Psi|)$ is given by

$$|\Psi_p\rangle = \sum_k \sqrt{p_k} |k\rangle^K |\psi_k\rangle^{ABCD} |k\rangle^{K'}, \quad (410)$$

and that any purification of the state Γ^{KAB} to the system $KABCDK'$ is in the form of

$$|\Gamma_p\rangle = \sum_k \sqrt{p_k} |k\rangle^K |\gamma_k\rangle^{AB} |\xi_k\rangle^{CDK'}, \quad (411)$$

with $\{|\xi_k\rangle\}_k$ being a set of orthogonal states. A simple calculation yields

$$|\langle\Psi_p|\Gamma_p\rangle| = \sum_k p_k |\langle\psi_k|^{ABCD} \langle k|^{K'} (|\gamma_k\rangle^{AB} |\xi_k\rangle^{CDK'})|. \quad (412)$$

The maximum of the above quantity over all orthogonal $\{|\xi_k\rangle\}_k$ is achieved by $\{|\xi_k\rangle\}_k$ that is decomposed into $|\xi_k\rangle^{CDK'} = |\phi_k\rangle^{CD} |k\rangle^{K'}$. Using this $\{|\phi_k\rangle\}_k$, we define a state $|\tilde{\Gamma}\rangle$ by

$$|\tilde{\Gamma}\rangle := \sum_k \sqrt{p_k} |k\rangle^K |\gamma_k\rangle^{AB} |\phi_k\rangle^{CD} \quad (413)$$

and a purification of Γ^{KAB} by

$$|\Gamma_p^*\rangle := \sum_k \sqrt{p_k} |k\rangle^K |\gamma_k\rangle^{AB} |\phi_k\rangle^{CD} |k\rangle^{K'}. \quad (414)$$

It follows that

$$\max_{\{\xi_k\}_k} |\langle \Psi_p | \Gamma_p \rangle| = |\langle \Psi_p | \Gamma_p^* \rangle| \quad (415)$$

$$= \sum_k p_k |\langle \psi_k |^{ABCD} | \gamma_k \rangle^{AB} | \phi_k \rangle^{CD}| \quad (416)$$

$$= |\langle \Psi | \tilde{\Gamma} \rangle|. \quad (417)$$

In addition, the states $|\Psi_p\rangle$ and $|\Gamma_p^*\rangle$ are obtained by a linear isometry $P^{K \rightarrow KK'} := \sum_k |k\rangle^K |k\rangle^{K'} \langle k|$ from $|\Psi\rangle$ and $|\tilde{\Gamma}\rangle$ as

$$|\Psi_p\rangle = P^{K \rightarrow KK'} |\Psi\rangle, \quad |\Gamma_p^*\rangle = P^{K \rightarrow KK'} |\tilde{\Gamma}\rangle \quad (418)$$

Thus, due to the property of the purified distance (Lemma 29 and Lemma 28), it follows that

$$P(|\tilde{\Gamma}\rangle\langle\tilde{\Gamma}|, |\Psi\rangle\langle\Psi|) = P(|\Gamma_p^*\rangle\langle\Gamma_p^*|, |\Psi_p\rangle\langle\Psi_p|) = P(\Gamma^{KAB}, \mathcal{C}^K \circ \text{Tr}_{CD}(|\Psi\rangle\langle\Psi|)), \quad (419)$$

which completes the proof. \blacksquare

Lemma 31 *Consider the same setting as in Lemma 30, and assume that C and D are composite systems C_0M_C and D_0M_D , respectively, where M_C and M_D are isomorphic quantum systems with an orthonormal basis $\{|m\rangle\}_m$. In addition, suppose that the state Ψ is classically coherent in $M_C M_D$, i.e., that*

$$\|\langle m |^{M_C} \langle m' |^{M_D} | \Psi \rangle\| \propto \delta_{m,m'}. \quad (420)$$

Then, without loss of generality, we may assume that the states $|\phi_k\rangle$ are classically coherent in $M_C M_D$.

Proof: It is straightforward to verify that the state Ψ is classically coherent in $M_C M_D$ if and only if all ψ_k are classically coherent in $M_C M_D$. Consequently, the maximum of each term in (416) is achieved by ϕ_k that is classically coherent in $M_C M_D$, which completes the proof. \blacksquare

Lemma 32 (gentle measurement: Lemma 5 in [20] and Corollary of Lemma 7 in [5]) *Let $\epsilon \in (0, 1]$, $\rho \in \mathcal{S}(\mathcal{H})$ and $\Lambda \in \mathcal{L}(\mathcal{H})$ be such that $0 \leq \Lambda \leq I$ and $\text{Tr}[\Lambda\rho] \geq 1 - \epsilon$. It holds that*

$$\|\rho - \sqrt{\Lambda}\rho\sqrt{\Lambda}\|_1 \leq 2\sqrt{\epsilon}, \quad P(\rho, \sqrt{\Lambda}\rho\sqrt{\Lambda}) \leq \sqrt{2\epsilon}. \quad (421)$$

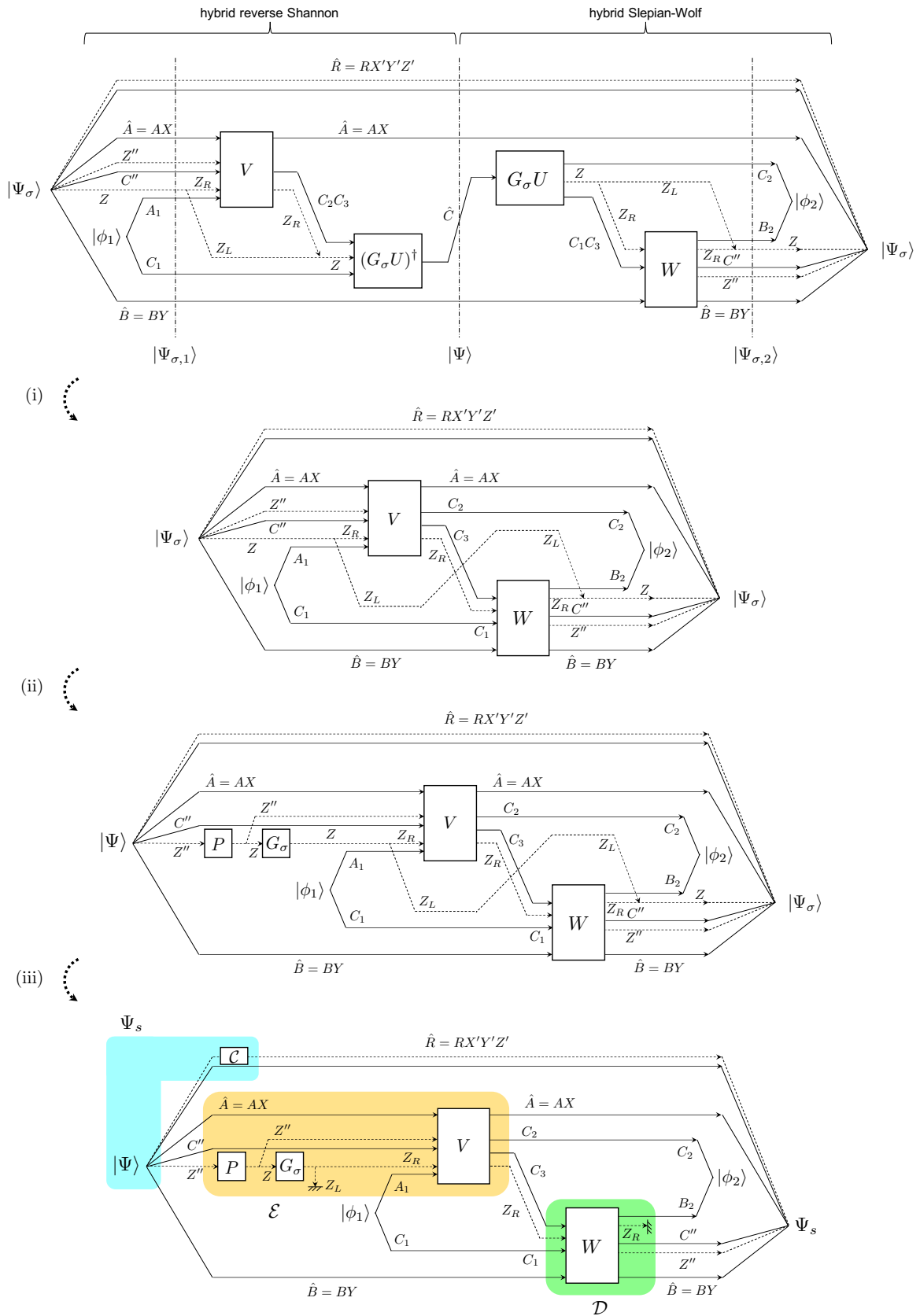

Figure 9: The construction of encoding and decoding operations in the proof of the direct part is depicted. (i) is obtained by cancelling out $G_\sigma U$ and $(G_\sigma U)^\dagger$, corresponding to Inequality (171) obtained from (153) and (154). (ii) follows from the fact that the state $|\Psi_\sigma\rangle$ is obtained from $|\Psi\rangle$ by applying P and G_σ , due to (158). In (iii), we trace out $Z \equiv Z_L Z_R$ and apply the completely dephasing operation C to $X'Y'Z'$. See Inequalities (173) and (176) that are obtained from (171). Note that the source state Ψ_s is obtained from $|\Psi\rangle$ and $|\Psi_\sigma\rangle$ as (160).