

Non-perturbative Defect One-Point Functions in Planar $\mathcal{N} = 4$ Super-Yang-Mills

Shota Komatsu¹ and Yifan Wang^{2,3,4}

¹School of Natural Sciences, Institute for Advanced Study, Princeton, NJ 08540, USA

²Joseph Henry Laboratories, Princeton University, Princeton, NJ 08544, USA

³Center of Mathematical Sciences and Applications, Harvard University, Cambridge, MA 02138, USA

⁴Jefferson Physical Laboratory, Harvard University, Cambridge, MA 02138, USA

Abstract

The four dimensional $\mathcal{N} = 4$ super-Yang-Mills (SYM) theory exhibits rich dynamics in the presence of codimension-one conformal defects. The new structure constants of the extended operator algebra consist of one-point functions of local operators which are nonvanishing due to the defect insertion and carry nontrivial coupling dependence. We study an important class of half-BPS superconformal defects engineered by D5 branes that share three common directions with the D3 branes and involve Nahm pole configurations for the SYM fields on the D3 brane worldvolume. In the planar large N limit, we obtain non-perturbative results in the 't Hooft coupling λ for the defect one-point functions of both BPS and non-BPS operators, building upon recent progress in localization [1] and integrability methods [2, 3].

For BPS operator insertions in the SYM with D5-brane type boundary or interface, we derive an effective two dimensional defect-Yang-Mills (dYM) theory from supersymmetric localization, which gives an efficient way to extract defect observables and generates a novel matrix model for the defect one-point function. By solving the matrix model in the large N limit, we obtain exact results in λ which interpolate between perturbative Feynman diagram contributions in the weak coupling limit and IIB string theory predictions on $AdS_5 \times S^5$ in the strong coupling regime, providing a precision test of AdS/CFT with interface defects. For general non-BPS operators, we develop a non-perturbative bootstrap-type program for integrable boundary states on the worldsheet of the IIB string theory, corresponding to the interface defects in the planar SYM. Such integrable boundary states are constrained by a set of general consistency conditions for which we present explicit solutions that reproduce and extend the known results at weak coupling from integrable spin-chain methods.

Contents

1	Introduction	2
2	The Matrix Model for D5-brane Interface	5
2.1	Review of boundary and interface defects in SYM	5
2.2	D5-brane interface defect and its S-dual	8
2.3	Identifying the defect-Yang-Mills sector	11
2.4	Simplified single-matrix model for D5-brane interface and Nahm pole	15
3	Defect One-Point Function from the D5-brane Matrix Model	20
3.1	The D5-brane interface at $k = 0$	21
3.1.1	Inserting bulk BPS operators	21
3.1.2	Equations for resolvent	23
3.1.3	Solving the matrix model	24
3.1.4	Computation of defect one-point functions	27
3.1.5	Weak coupling expansion	29
3.1.6	Strong coupling expansion	29
3.2	Generalization to D5-brane interface at $k > 0$	30
3.3	Comparisons with results from perturbation theory and holography	32
3.3.1	Weak coupling expansions	32
3.3.2	Strong coupling expansions and holography	33
4	Integrable Bootstrap for One-Point Functions	35
4.1	General strategy	35
4.2	Dynamic $\mathfrak{psu}(2 2)$ spin chain	37
4.3	Symmetry constraints on the two-particle overlap	40
4.4	Constraining the scalar factor	43
4.5	Solving the crossing equation	47
4.6	Excited boundary states and comparison with perturbation theory	52
5	Discussion and Conclusion	58

1 Introduction

Quantum field theories are known to exhibit rich dynamics in the presence of co-dimension one defects such as boundaries or domain walls (interfaces). In particular topological field theories which do not carry any propagating degrees of freedom in the bulk at all, may harbor nontrivial interactions on the boundary or domain wall. A canonical example of this involves the three-dimensional Chern-Simons theory on a manifold with boundary and the corresponding (chiral) Wess-Zumino-Witten model (or general rational conformal field theories) on the boundary [4–6], as a special instance of the anomaly inflow mechanism [7]. More interestingly is when the bulk theory is also strongly interacting. In such cases, the anomaly arguments alone are not enough to pin down the dynamics of the coupled system. Fortunately when the bulk theory enjoys conformal symmetry, as is often the case for strongly-coupled fixed points of renormalization-group (RG) flows, there are direct methods to determine the physical observables non-perturbatively, which broadly speaking belong to the *conformal bootstrap program* [8]. This is thanks to an axiomatic definition of the fixed point theory, a conformal field theory (CFT), in terms of the spectrum of local operators and the operator-product-expansion (OPE) of correlation functions. The conformal symmetry, crossing symmetry together with unitarity imply an infinite set of constraints for the spectrum and OPE coefficients (three-point-functions), which can be explored systematically by bootstrap methods. The bootstrap problem for local operators and their correlation functions has a natural extension in the presence of boundaries or domain walls preserving the the conformal subalgebra longitudinal to the defect [9–11]. Compared to the case without the defects, we now have a richer setup with additional structure constants intrinsic to the defects, known as the defect one-point functions of bulk local operators. Together with the OPE expansion of the local operators, they determine completely the local correlation functions in the presence of the conformal defect. Furthermore, these defect one-point functions constrain the spectrum of local operators that are confined to the world-volume of the conformal defect. This is achieved for example by studying a different bulk-boundary OPE limit of the two-point function of bulk local operators that exchanges boundary operators in the intermediate channel and deriving a crossing equation that relates to the OPE limit of the local operators in the bulk.

In four spacetime dimensions, a large class of strongly coupled fixed points are produced by RG flows from Yang-Mills theories coupled to matter fields in various representations, which admit interesting boundary and domain wall dynamics. Among such four-dimensional CFTs, the $\mathcal{N} = 4$ super Yang-Mills (SYM) holds a special place. On one hand, it shares many

features of the other strongly-coupled gauge theories. On the other hand, the fact that it has the maximal supersymmetry allows for a number of analytic methods to probe its dynamics, such as supersymmetric localization [12–14], integrability [15], and superconformal bootstrap (a refinement of the ordinary bootstrap program outlined above) [8]. Furthermore, via the conjectured holographic correspondence, observables in the $\mathcal{N} = 4$ SYM in the large N limit are mapped to those in the type IIB string theory on $AdS_5 \times S^5$ and vice versa [16–18], thus providing a channel to probe and test quantum gravity using field theory methods.

The $\mathcal{N} = 4$ SYM is known to host a large family of boundary and interface defects, and the half-BPS ones have been classified in [19–21]. They correspond to D5- and NS5-branes (more generally (p, q) five-branes) that share three common directions with the stack of D3-branes that engineer the SYM. The codimension one defect often contains strongly-coupled three-dimensional excitations on its worldvolume, which may be described, via the mirror symmetry (or mirror duality), by RG flows from a three-dimensional $\mathcal{N} = 4$ supersymmetric quiver gauge theory coupled to the SYM [21].¹

In this paper, we study the $\mathcal{N} = 4$ super Yang-Mills in the presence of half-BPS boundary and interface defects of the D5-brane type, building upon recent progress in supersymmetric localization [1] and integrability methods [2, 3] to extract the basic structure constants, the defect one-point function $\langle \mathcal{O} \rangle_{\mathcal{D}}$ of single-trace local operators in the SYM. Combined with the superconformal bootstrap method [9, 10], our results provide a way to potentially solve the $\mathcal{N} = 4$ SYM in the presence of these interface defects.

From the general discussion in [1], the $\mathcal{N} = 4$ SYM in the presence of half-BPS boundary or interface defects contains a solvable 2d/1d subsector described by (constrained) two-dimensional Yang-Mills theory [24] coupled to certain one-dimensional topological quantum mechanics [25], known as the defect-Yang-Mills (dYM). A large class of defect observables in the SYM that preserve a common supercharge \mathcal{Q} have simple descriptions in the dYM sector and their correlation functions can be extracted using standard two-dimensional gauge theory methods [26–29].² For the D5-brane interface that interpolate between $U(N)$ and $U(N + k)$ SYM theories for $k \geq 0$, we determine explicitly the dYM sector in this paper. While the D5-brane interface for $k = 0$ has a simple Lagrangian description, as a transparent interface stacked with a bifundamental hypermultiplet on its worldvolume, this is not the case when $k > 0$ which involve the singular Nahm pole boundary condition [19]. Thanks to the S-duality of the bulk SYM theory as well as the related mirror symmetry acting on the

¹See [22] (and also [23]) for a recent study of interacting boundary CFTs in a non-supersymmetric setting, where the bulk is described by the 4d Maxwell theory.

²See also [30, 31] for reviews on this subject.

boundary conditions (boundary theories), we are able to derive the one-dimensional topological quantum mechanics corresponding to the D5-brane interface (boundary) in the dYM. Using two-dimensional gauge theory techniques in the dYM effective theory, the computation of the defect one-point function $\langle \mathcal{O} \rangle_{\mathcal{D}}$ is reduced to a single-matrix integral. Compared to the simple Gaussian matrix model familiar for SYM, our matrix model involves a novel single-eigenvalue potential, which comes from the D5-brane defect. By solving this matrix model in the planar large N limit, we determine the one-point functions $\langle \mathcal{O} \rangle_{\mathcal{D}}$ as exact functions of the 't Hooft coupling $\lambda = Ng_4^2$. Expanding the answer in both weak and strong coupling regimes, our exact result bridges perturbative answers from Feynman diagram computations in the SYM and holographic results from type IIB string theory on $AdS_5 \times S^5$ where the interface is described by a probe D5-brane along an $AdS_4 \times S^2$ submanifold with k -units of worldvolume flux threading the S^2 factor [32].

The planar $\mathcal{N} = 4$ SYM is integrable which allows for determination of defect one-point functions using spin-chain methods [15,33]. Local operators and defect observables are represented by quantum states of the spin chain. In particular the interface defect corresponds to a matrix product state (MPS) and the bulk local operators correspond to Bethe eigenstates of the spin chain Hamiltonian. The defect one-point functions $\langle \mathcal{O} \rangle_{\mathcal{D}}$ is given by the overlap between the MPS and Bethe states [33–45]. However, this computation relies on a weak coupling expansion and is not suitable for accessing correlators in the $\mathcal{N} = 4$ SYM at finite λ . In this paper, we develop a bootstrap-type program for the defect one-point functions at finite λ following the general strategy laid out in [2,3]. We identify the D5-brane interface defect with a integrable boundary state on the worldsheet of the IIB string theory in the holographic dual, and compute it non-perturbatively by imposing a set of consistency conditions: the Watson's equation, boundary Yang-Baxter equations, and the crossing equation. Knowledge of the integrable boundary states has powerful consequences: it determines the defect structure constants $\langle \mathcal{O} \rangle_{\mathcal{D}}$ for \mathcal{O} that are non-BPS. We provide explicit solutions to the consistency conditions and check that they reproduce the known results at weak coupling.

The rest of the paper is organized as follows. We start by reviewing half-BPS interface defects in the $\mathcal{N} = 4$ SYM in Section 2, and determine the dYM sector as well as the corresponding matrix model for D5-brane interface defects using S-duality and mirror symmetry. In Section 3, we determine the defect structure constants $\langle \mathcal{O} \rangle_{\mathcal{D}}$ of half-BPS operators using the interface matrix model in the large N limit and compare to results from perturbation theory and holographic computations. In Section 4, we present the bootstrap approach to the defect one-point function of non-BPS operators using integrability. We end by a brief

summary and discussion in Section 5.

2 The Matrix Model for D5-brane Interface

2.1 Review of boundary and interface defects in SYM

The 4d $\mathcal{N} = 4$ SYM with gauge group G (its Lie algebra denoted by \mathfrak{g}) is realized by the dimensional reduction of the 10d SYM. It is thus natural to write its action in terms of the 10d fields as

$$S_{\text{SYM}} = -\frac{1}{2g_4^2} \int_{\mathbb{R}^4} d^4x \operatorname{tr} \left(\frac{1}{2} F_{MN} F^{MN} - \Psi \Gamma^M D_M \Psi \right). \quad (2.1)$$

Here $M = 1, 2, \dots, 8, 9, 0$ are 10d spacetime indices which splits into 4d spacetime and R-symmetry (internal) indices (μ, I) with $\mu = 1, 2, 3, 4$ and $I = 5, \dots, 9, 0$. The bosonic field A_M contains the 4d gauge field A_μ and scalars Φ_I . The gaugino Ψ transforms as a chiral spinor of $Spin(10)$ and $\Gamma_M = \{\Gamma_\mu, \Gamma_I\}$ are 10d chiral Gamma matrices. We follow the convention of [24] for the covariant derivative $D \equiv d + A$ and curvature $F = dA + A \wedge A$. In terms of its \mathfrak{g} components, $A_M \equiv A_M^a T_a$ comes with real coefficients A_M^a and *anti-hermitian* generators T_a of \mathfrak{g} . The trace $\operatorname{tr}(\cdot, \cdot)$ is the Killing form of \mathfrak{g} and is related to the usual trace in a particular representation R by $\operatorname{tr} = \frac{1}{2T_R} \operatorname{tr}_R$, where T_R denotes the Dynkin index of R . For $\mathfrak{g} = \mathfrak{su}(N)$, this is identical to the trace in the fundamental representation $\operatorname{tr} = \operatorname{tr}_F$. Finally the generators T^a are normalized by $\operatorname{tr}(T_a T_b) = -\frac{1}{2} \delta_{ab}$. We set the four-dimensional theta angle $\theta = 0$ in this paper.

The superconformal symmetry of the SYM comes from the conformal Killing spinor

$$\varepsilon = \epsilon_s + x^\mu \Gamma_\mu \epsilon_c \quad (2.2)$$

where ϵ_s and ϵ_c are constant 16-component spinors that correspond to the Poincaré and conformal supercharges in the superconformal algebra $\mathfrak{psu}(2, 2|4)$. The superconformal transformation of the SYM fields are generated by

$$\begin{aligned} \delta_\varepsilon A_M &= \varepsilon \Gamma_M \Psi, \\ \delta_\varepsilon \Psi &= \frac{1}{2} F_{MN} \Gamma^{MN} \varepsilon + \frac{1}{2} \Gamma_{\mu I} \Phi^I \partial^\mu \varepsilon. \end{aligned} \quad (2.3)$$

The half-BPS interface or boundary defect along the hyperplane $x_1 = 0$ preserve a superconformal subalgebra $\mathfrak{osp}(4|4, \mathbb{R}) \subset \mathfrak{psu}(2, 2|4)$. There is a family of such subalgebras related by inner automorphisms (conjugation) as well as outer-automorphisms ($U(1)_Y$) of $\mathfrak{psu}(2, 2|4)$.

Here we follow [1] and fix this ambiguity by specifying the supercharges preserved by the defect

$$\Gamma_{1890}\epsilon_s = \epsilon_s, \quad \Gamma_{1890}\epsilon_c = \epsilon_c. \quad (2.4)$$

The corresponding half-BPS subalgebra contains the following bosonic algebras

$$\mathfrak{osp}(4|4, \mathbb{R}) \supset \mathfrak{so}(3)_{567} \oplus \mathfrak{so}(3)_{890} \oplus \mathfrak{so}(3, 2)_{\text{conf}}. \quad (2.5)$$

Here $\mathfrak{so}(3, 2)_{\text{conf}}$ is the conformal symmetry along the defect, and $\mathfrak{so}(3)_{567} \oplus \mathfrak{so}(3)_{890}$ a maximal subalgebra of the full $\mathfrak{so}(6)_R$ symmetry.

The 4d $\mathcal{N} = 4$ vector multiplet naturally decomposes with respect to this $\mathfrak{osp}(4|4, \mathbb{R})$ subalgebra into the following 3d $\mathcal{N} = 4$ multiplets

$$\begin{aligned} \text{hypermultiplet} & : \Psi_-, A_1, X_i, \\ \text{vectormultiplet} & : \Psi_+, A_{2,3,4}, Y_i, \end{aligned} \quad (2.6)$$

where we have split the gaugino Ψ into

$$\Psi_{\pm} \equiv \frac{1}{2}(1_{16} \pm \Gamma_{1890})\Psi, \quad (2.7)$$

and the six scalar fields Φ_I as

$$X_i = (\Phi_8, \Phi_9, \Phi_0), \quad Y_j = (\Phi_5, \Phi_6, \Phi_7). \quad (2.8)$$

As explained in [19], general BPS boundary conditions for the SYM on the half space $x_1 > 0$ are obtained by supersymmetric configurations of the 3d multiplets in (2.6). The generalization to interface defects is immediate via the (un)folding trick. Below we briefly review the relevant BPS boundary conditions.

One simple choice involves assigning Dirichlet boundary condition for the 3d vectormultiplet and Neumann-like boundary condition for the 3d hypermultiplet

$$\text{D5 : } F_{\mu\nu}|_{x_1=0} = D_1 X_i - \frac{1}{2}\epsilon_{ijk}[X_j, X_k]|_{x_1=0} = Y_i|_{x_1=0} = 0, \quad \Psi_+|_{x_1=0} = 0. \quad (2.9)$$

This is realized by D5-branes along the 234890 directions, intersecting with the D3-branes that lie along the 1234 directions in the 10d spacetime of type IIB string theory. Thus we refer to such boundary condition as the D5-type (or generalized Dirichlet). This is also known as the Nahm (pole) boundary condition for the $\mathcal{N} = 4$ SYM since the second equation

in (2.9) is the Nahm equation for \vec{X} . Near the boundary $x_1 = 0$, the solutions to the Nahm equation are given by

$$X_i = -\frac{t_i}{x_1} + \text{regular terms}, \quad (2.10)$$

for $t_i \in \mathfrak{g}$ obeying the $\mathfrak{su}(2)$ commutation rules

$$[t_i, t_j] = \epsilon_{ijk} t_k. \quad (2.11)$$

Up to a gauge transformation, t_i is specified by a homomorphism $\rho : \mathfrak{su}(2) \rightarrow \mathfrak{g}$. For $\mathfrak{g} = \mathfrak{u}(N)$, such a homomorphism is labelled by a partition $d = [p_1, \dots, p_k]$ of N with $p_1 \geq p_2 \geq \dots \geq p_k > 0$. Correspondingly t_i takes the form of a block diagonal $N \times N$ matrix

$$t_i = t_i^{p_1 \times p_1} \oplus t_i^{p_2 \times p_2} \oplus \dots \oplus t_i^{p_k \times p_k}, \quad (2.12)$$

where each triplet $t_i^{p_i \times p_i}$ with $i = 1, 2, 3$ gives rise to a p_i -dimensional irreducible representation of $\mathfrak{su}(2)$ and explicitly

$$t_3^{p \times p} = -\frac{i}{2} \text{Diag}[p-1, p-3, \dots, 1-p]. \quad (2.13)$$

In the D3-D5 setup, the $U(N)$ Nahm pole labelled by the partition $d = [p_1, \dots, p_k]$ involves k D5-branes and there are p_i D3-branes ending on each of the i -th D5-branes. The trivial Nahm pole involves N D5-branes and corresponds to the *minimal* partition $d = [1, 1, \dots, 1]$ with $t_i = 0$. This is the familiar Dirichlet boundary condition. The Nahm pole produced by a single D5-brane is of the *regular*(principal) type with $d = [N]$.

Another simple half-BPS boundary condition for SYM is defined by assigning Dirichlet boundary condition for the 3d hypermultiplet and Neumann boundary condition for the 3d vectormultiplet in (2.6)

$$\text{NS5} : F_{1\mu} |_{x_1=0} = X_i |_{x_1=0} = D_1 Y_i |_{x_1=0} = 0, \quad \Psi_- = 0. \quad (2.14)$$

This is realized by an NS5-brane along the 234567 directions and thus we refer to it as the NS5-type boundary condition or simply as the Neumann boundary condition for the SYM. Importantly, the D5-type and NS5-type boundary conditions are related by S-duality in the SYM [21].

The D5-type (2.9) and NS5-type (2.14) boundary conditions can be generalized by introducing partial *gauge symmetry breaking* [19]. For a subgroup of the gauge group $H \subset G$

(which may not be simple), the corresponding Lie algebra decomposes as

$$\mathfrak{g} = \mathfrak{h} \oplus \mathfrak{h}^\perp \quad (2.15)$$

into the Lie algebra of H and its orthogonal complement (which may not be a Lie algebra). Then one can consider a mixture of NS5-type boundary condition (2.14) for the components of the SYM fields in \mathfrak{h} and D5-type boundary condition (2.9) for the components in \mathfrak{h}^\perp . This defines the symmetry breaking boundary condition associated to the subgroup $H \subset G$ [19].

Finally, the half-BPS boundary conditions defined above lead to interface defects preserving the same supersymmetry thanks to the (un)folding trick, generated by a \mathbb{Z}_2 -automorphism ι_{fold} of the superconformal algebra $\mathfrak{psu}(2, 2|4)$ [19]

$$\iota_{\text{fold}} : (x_1, x_2, x_3, x_4) \rightarrow (-x_1, x_2, x_3, x_4), \quad (\vec{X}, \vec{Y}) \rightarrow (-\vec{X}, \vec{Y}). \quad (2.16)$$

In particular the BPS interfaces in the $\mathcal{N} = 4$ SYM with gauge group G_1 on one side $x_1 > 0$ and another gauge group G_2 on the other side $x_1 < 0$ correspond to BPS boundary conditions for the SYM with gauge group $G_1 \times G_2$. For example, the transparent interface in the G SYM corresponds to unfolding the $G \times G$ SYM with the partial symmetry breaking boundary condition that preserves the diagonal subgroup $G_{\text{diag}} \subset G \times G$. Note that the flipping of \vec{X} in (2.16) ensures the continuity of the $\mathcal{N} = 4$ vector multiplet across the interface.

2.2 D5-brane interface defect and its S-dual

We now focus on the interface interpolating between the $U(N)$ and $U(N+k)$ SYMs engineered by a single D5 brane with N D3-branes on the left and $N+k$ D3 branes on the right (see Figure 1a).³

According to the general discussion in Section 2.1, this corresponds by the (un)folding trick to the symmetry breaking BPS boundary condition of the $U(N) \times U(N+k)$ SYM

$$U(N) \times U(N+k) \supset U(N)_{\text{diag}} \quad (2.17)$$

specified by NS5-type boundary condition (2.14) for the components of the SYM fields in $\mathfrak{u}(N)_{\text{diag}}$ and D5-type boundary condition (2.9) for the orthogonal complements. Consequently we have near the interface $x_1 = 0$, the following relations between the $U(N+k)$

³We emphasize that unlike in the case without interface defects, here the $U(1)$ part of the $U(N)$ SYM does not decouple.



Figure 1: Half-BPS interfaces between $U(N)$ and $U(N+k)$ SYMs engineered by a single D5- or NS5-brane, related by S-duality. Here $N = 3$ and $k = 2$ in the figures above. The horizontal direction is x_1 . The solid black lines denote D3-branes in the 1234 directions. The red dotted vertical line denotes a D5-brane extending in the 234890 directions. The blue circled cross labels an NS5-brane extending in the 234567 directions.

fields A_M^+ and the $U(N)$ fields A_M^- ,

$$A_\mu^+ = \begin{pmatrix} A_\mu^- & * \\ * & * \end{pmatrix}, \quad \vec{Y}^+ = \begin{pmatrix} \vec{Y}^- & * \\ * & * \end{pmatrix}, \quad \vec{X}^+ = \begin{pmatrix} \vec{X}^- & * \\ * & -\frac{1}{x_1} \vec{t} \end{pmatrix}. \quad (2.18)$$

Here the $*$ labels the components of A_M^+ that are unconstrained (regular) at the interface. Note that due to the Nahm equation in (2.9), the bottom $k \times k$ block of \vec{X}^+ is given by a triplet \vec{t} with

$$t_3 = -\frac{i}{2} \text{Diag}[k-1, k-3, \dots, 1-k]. \quad (2.19)$$

The S-dual of the D5 brane interface in the $\mathcal{N} = 4$ SYM with complexified gauge coupling $\tau = \frac{4\pi i}{g_4^2} + \frac{\theta}{2\pi}$ is easy to infer from the IIB brane setup. By an S-duality transformation of the IIB string theory, the D5 brane interface maps to an NS5 brane interface in Figure 1b. The resulting 4d theory on the D3-branes consists of two individual 4d SYMs with $U(N+k)$ and $U(N)$ gauge groups and Neumann boundary conditions, coupled together by a bifundamental hypermultiplet localized at the interface. The SYM gauge couplings are now at the S-dual value $\tau' = -\frac{1}{\tau}$. By performing a further S-duality transformation on each of the two SYM factors, the $U(N)$ SYM with coupling τ' and Neumann boundary condition maps to the $U(N)$ SYM at original gauge coupling τ coupled to a three-dimensional $\mathcal{N} = 4$ SCFT known as the $T[SU(N)]$ theory, similarly for the $U(N+k)$ factor where S-duality introduces the

coupling to the $T[SU(N+k)]$ SCFT (see Figure 2 for the quiver description of these 3d theories). In general the 3d $T[G]$ SCFT has global symmetries $G \times G^\vee$ where G^\vee denotes the Langlands dual of the 4d gauge group. Here the global symmetries of the $T[SU(N)]$ and $T[SU(N+k)]$ theories are gauged by the $SU(N)$ and $SU(N+k)$ vector multiplets in the bulk, as well as on the interface along with the bifundamental hypermultiplet.

Note that $T[SU(N)]$ coupled to the $U(N) \times U(N+k)$ bifundamental multiplet defines the $T_{[k,1,\dots,1]}[SU(N+k)]$ SCFT with $SU(N) \times SU(N+k)$ global symmetry. This belongs to a generalization of the $T[G]$ SCFT by two homomorphisms ρ and σ from $\mathfrak{su}(2)$ to \mathfrak{g} , labelled as $T_\rho^\sigma[G]$. When either ρ or σ is the trivial homomorphism, we drop the corresponding sub- or super-script. In particular the $T[G]$ theory corresponds to trivial ρ and σ . The $T_\rho^\sigma[G]$ SCFT is engineered by considering 4d $\mathcal{N} = 4$ G SYM on a segment (suppressing the non-compact \mathbb{R}^3) with Nahm pole boundary condition for \vec{X} labelled by ρ at one end, and Nahm pole boundary condition for \vec{Y} labelled by σ at the other end, together with an S-duality wall in the middle [21]. By gluing with the 4d G SYM on a half-space with suitable boundary conditions, the coupling to $T_\rho^\sigma[G]$ SCFT induces the S-dual boundary condition for the 4d SYM.⁴ For this reason, the $T_\rho^\sigma[G]$ SCFT is sometimes referred to as the S-duality transformation kernel. Back to the case we are interested in here, which is due to a single nontrivial Nahm pole $\rho = [k, 1, 1, \dots, 1]$. The relevant 3d defect theory is given by $T_{[k,1,1,\dots,1]}[SU(N+k)]$ (see Figure 2).

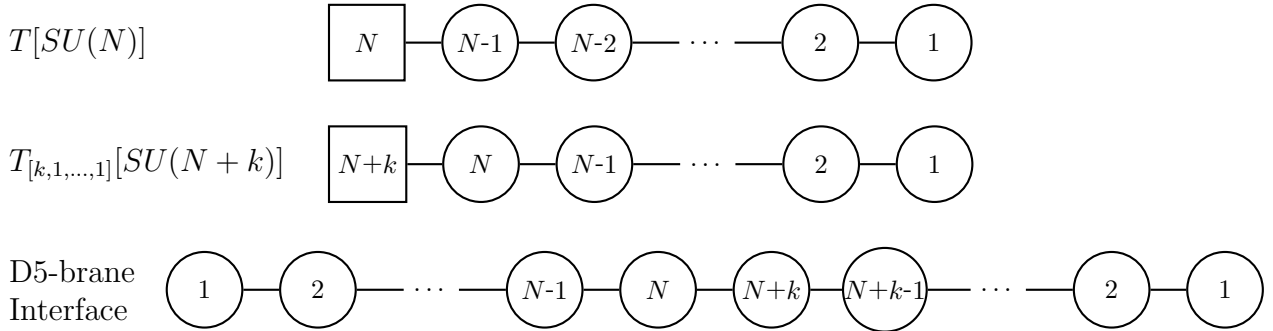

Figure 2: The ultraviolet linear quiver descriptions for the 3d $\mathcal{N} = 4$ SCFTs $T[SU(N)]$ and $T[SU(N+k)]$, as well as (the mirror dual for) the D5-brane interface theory. Each numbered circle node denotes a 3d $\mathcal{N} = 4$ vector multiplet for the correspondence unitary gauge group, and each segment denotes a bifundamental hypermultiplet. The boxed nodes are not gauged and carry the Higgs branch flavor symmetries of the corresponding SCFTs.

⁴See [46] for recent work on the factorization and gluing of supersymmetric partition functions.

2.3 Identifying the defect-Yang-Mills sector

The D5 brane interface preserves the half-BPS algebra $\mathfrak{osp}(4|4)$. As explained in [1], this subalgebra contains the 4d supercharge \mathcal{Q} of [24] which squares to a combination of the transverse rotation M_\perp to an two-sphere

$$S_{\text{YM}}^2 : x_4 = 0, \quad \sum_{i=1}^3 x_i^2 = 1, \quad (2.20)$$

and the R-symmetry generator R_{56} inside $\mathfrak{so}(6)_R$.⁵ Furthermore, after mapping the setup to S^4 by the stereographic projection, one can carry out the \mathcal{Q} -localization of the 4d SYM with a general half-BPS interface defect. The dynamics of general defect observables in the \mathcal{Q} cohomology is determined by an effective 2d defect-Yang-Mills (dYM) theory on the S_{YM}^2 , which is described by the constrained 2d Yang-Mills [24] coupled to certain topological quantum mechanics (TQM) [25] on the equator

$$S_{\text{TQM}}^1 : x_4 = 0, \quad x_1 = 0, \quad \sum_{i=2}^3 x_i^2 = 1. \quad (2.21)$$

The dYM gives an efficient way to determine defect observables in the \mathcal{Q} -cohomology by standard two-dimensional gauge theory techniques, which oftentimes reduce to computations in (multi)matrix models.

The details of the dYM will depend on the specific interface. This is especially subtle when the defect introduces singularities for the SYM fields, such as the Nahm pole for the D5-brane interface. Here we will circumvent this by two ways to determine the dYM, namely the S-duality of the SYM and the mirror dual of the interface (boundary condition). As explained in [21], the two are closely related which we review below.

Let's first consider the S-dual configuration in Figure 1b involving an NS5-brane interface, described by two individual SYMs on half-spaces with Neumann boundary conditions and gauge groups $U(N)$ and $U(N+k)$. The two SYM factors are coupled together just by a bifundamental hypermultiplet of $U(N) \times U(N+k)$ localized at the interface. The invariance of the bulk SYM under S-duality transformations ensures that the correlation function of defect observables in the SYM with D5-brane interface is equivalent to that with an NS5-brane interface. A particular class of observables in the \mathcal{Q} -cohomology of the SYM are $\frac{1}{8}$ -BPS

⁵We follow the convention of [1] for the generators of the superconformal algebra $\mathfrak{psu}(2, 2|4)$. In particular the $\mathfrak{so}(6)_R$ symmetry is generated by R_{IJ} with $I, J = 5, 6, \dots, 9, 0$.

operators on the S_{TQM}^2 [47]

$$\mathcal{O}_J(x_i) \equiv \text{tr}(x_1\Phi_7 + x_2\Phi_9 + x_3\Phi_0 + i\Phi_8)^J. \quad (2.22)$$

Since these operators (individually half-BPS) are invariant under S-duality [48], their correlators in the presence of D5- or NS5-brane interface are simply related by

$$\langle \mathcal{O}_{J_1} \cdots \mathcal{O}_{J_n} \rangle_{\text{D5}}^\tau \equiv \langle \mathcal{O}_{J_1} \cdots \mathcal{O}_{J_n} \rangle_{\text{NS5}}^{\tau'}, \quad (2.23)$$

where $\tau' = -\frac{1}{\tau}$.

In a later section, we will derive a matrix model for the one point function of the D5-brane interface $\langle \mathcal{O}_J \rangle_{\text{D5}}$. For this purpose, it's convenient to use the S-dual NS5-brane description, which leads to a simple dYM description which we now present.

Following the general discussion in [1], the \mathcal{Q} -cohomology is parametrized by emergent 2d YM gauge fields \mathcal{A}' and \mathcal{A} on the two hemispheres HS_\pm^2 with gauge group $U(N+k)$ and $U(N)$ respectively, as well as the (twisted combination of) hypermultiplet scalars (Q, \tilde{Q}) in the bifundamental representation of $U(N) \times U(N+k)$. The partition function of the dYM is

$$Z_{\text{dYM}} = \int_{S_{\text{YM}}^2} D\mathcal{A}|_{HS_-^2} D\mathcal{A}'|_{HS_+^2} DQ D\tilde{Q}|_{S_{\text{TQM}}^1} e^{-S_{\text{YM}}(\mathcal{A}) - S_{\text{YM}}(\mathcal{A}') - S_{\text{TQM}}(\mathcal{A}, \mathcal{A}', Q, \tilde{Q})}. \quad (2.24)$$

Here the YM action $S_{\text{YM}}(\mathcal{A})$ is

$$S_{\text{YM}}(\mathcal{A}) \equiv -\frac{1}{g_{\text{YM}}^2} \int_{HS_-^2} dV_{S^2} \text{tr}(\star\mathcal{F})^2, \quad g_{\text{YM}}^2 = -\frac{8\pi}{g_4^2 R^2}, \quad (2.25)$$

with the field strength $\mathcal{F} \equiv d\mathcal{A} + \mathcal{A} \wedge \mathcal{A}$ and similarly for $S_{\text{YM}}(\mathcal{A}')$ on HS_+^2 . The TQM is described by

$$S_{\text{TQM}} = -2\pi \int d\varphi \tilde{Q}_i^m (D_{\mathcal{A}, \mathcal{A}'}^m)_{jm}^{in} Q_n^j, \quad (2.26)$$

where $i, j = 1, \dots, N$ and $m, n = 1, \dots, N+k$ are indices for $U(N)$ and $U(N+k)$ fundamental representations respectively. The gauge covariant derivative is

$$(D_{\mathcal{A}, \mathcal{A}'}^m)_{jm}^{in} = d\delta_j^i \delta_m^n + \delta_m^n \mathcal{A}_j^i + \delta_j^i \mathcal{A}'_m{}^n. \quad (2.27)$$

Integrating out the 2d/1d fields in (2.24) as described in [1], we obtain a (two-)matrix model

$$Z_{D5} = \int [da][d\alpha] \underbrace{\frac{\Delta(a)\Delta(a)e^{-\frac{g_4^2}{4}\sum_{i=1}^N a_i^2}}{N!}}_{U(N) \text{ SYM Neumann b.c.}} \underbrace{\frac{\Delta(\alpha)\Delta(\alpha)e^{-\frac{g_4^2}{4}\sum_{n=1}^{N+k} \alpha_n^2}}{(N+k)!}}_{U(N+k) \text{ SYM Neumann b.c.}} \frac{1}{\underbrace{\prod_{i=1}^N \prod_{n=1}^{N+k} 2 \cosh(\pi(a_i + \alpha_n))}_{U(N) \times U(N+k) \text{ bifundamental hyper}}} . \quad (2.28)$$

with measure

$$[da] \equiv \left(\prod_{n=1}^N da_n \right), \quad [d\alpha] \equiv \left(\prod_{n=1}^{N+k} d\alpha_n \right). \quad (2.29)$$

Here $\Delta(\cdot)$ denotes the usual Vandermonde determinant

$$\Delta(z) \equiv \prod_{i < j} (z_i - z_j), \quad (2.30)$$

while $\Delta(\cdot)$ denotes the one-loop determinant for 3d $\mathcal{N} = 4$ vector multiplets

$$\Delta(z) \equiv \prod_{i < j} 2 \sinh \pi(z_i - z_j). \quad (2.31)$$

In writing (2.28), we have made manifest its factorized form, from gluing $U(N)$ and $U(N+M)$ SYMs with Neumann boundary conditions and coupled together by the bifundamental hypermultiplet. Finally, the one point function of the $\frac{1}{8}$ -BPS operator \mathcal{O}_J on the hemispheres HS_{\pm}^2 simply amounts to an insertion of $\sum_{n=1}^{N+k} (\alpha_n)^J$ or $\sum_{i=1}^N (a_i)^J$ respectively in (2.28) [1].⁶

In a sense, the dYM presented above from the NS5-brane interface is S-dual to the would-be dYM that directly descends from the D5-brane description which we do not pursue here directly due to the singular Nahm pole boundary condition. However it is known that such superconformal boundary condition has an ultraviolet (UV) description by certain $\mathcal{N} = 4$ supersymmetric linear quiver gauge theories [21]. This UV Lagrangian is mirror dual to the original interface theory (boundary condition) since it couples to the bulk $\mathcal{N} = 4$ vector multiplets via the 3d moment map operators on the Coulomb branch, as opposed to the Higgs branch. There is a standard procedure to identify the mirror dual Lagrangian as explained in [21]. This follows from first isolating the interface degrees of freedom and bulk-interface couplings by introducing D5 branes that impose Dirichlet boundary conditions on

⁶As in the case without the interface, the correlation functions of the local operators \mathcal{O}_J are topological [49] and thus independent of the location of the insertions on the S_{YM}^2 as long as it doesn't cross the interface at S_{TQM}^1 [1].

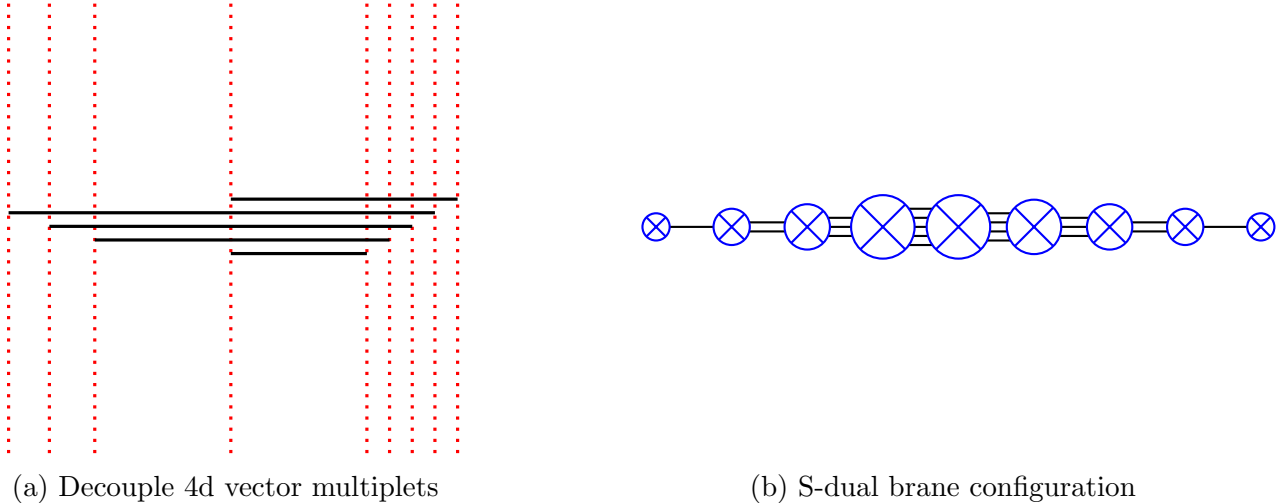

Figure 3: The standard procedure to identify the mirror dual for the D5-brane interface. In the left figure, we ungauged the 4d vector multiplets by attaching the individual D3 branes to D5 branes, implementing Dirichlet boundary conditions. By performing an S-duality transformation, we obtain the brane configuration in the right figure, which gives the mirror dual quiver description of the D5-brane interface.

the 4d vector multiplets away from the interface, and then implementing the IIB S-duality on this configuration. As reviewed in Figure 3, carrying out this procedure, the D5-brane interface between $U(N)$ and $U(N+k)$ SYMs here has a UV Lagrangian description given by the bottom quiver in Figure 2. Following [1], one can then localize the coupled system with this Lagrangian interface theory and obtain a dYM similar to that in (2.24). The main differences are that the 2d Yang-Mills coupling becomes

$$g_{\text{YM}}^2 = -\frac{g_4^2}{2\pi R^2}, \tag{2.32}$$

and the TQM is now an interacting theory descending from the D5-interface quiver in Figure 2. We will not need the explicit form of this dYM description in this paper but we point out that it leads to a different form of the integrand for the matrix model than in (2.28), though the integrals agree as expected (see also the next section for explicit formulae).⁷

⁷We also emphasize that the D5-interface quiver here is of the *bad* type according to the *good-bad-ugly* classification in [21]. This means as a stand-alone 3d $\mathcal{N} = 4$ theory, it is obscure from the quiver what the correct IR description should be (e.g. there are monopole operators that violate the putative unitarity bound, spontaneous symmetry breaking etc.). Nevertheless as we will see in the next section, this bad quiver suffices in describing the D5-brane interface defect, at least at the level of the S^3 partition function (which contributes to the interface matrix model).

2.4 Simplified single-matrix model for D5-brane interface and Nahm pole

In this section we simplify the matrix model (2.28) by explicitly integrating out the $U(N+k)$ degrees of freedom. The final result is

$$Z_{\text{D5}} = \frac{C_{N,k}}{N!} \int [da] \frac{\Delta(a)^2 \prod_{i=1}^N \prod_{j=1}^k (a_i - i \frac{2j-k-1}{2})}{\prod_{j=1}^N 2 \cosh \pi(a_j + \frac{ki}{2})} e^{-\frac{8\pi^2}{g_4^2} \sum_{i=1}^N a_i^2}, \quad (2.33)$$

with

$$C_{N,k} = \left(\frac{4\pi}{g_4^2} \right)^{\frac{N^2+(N+k)^2}{2}} e^{\frac{4\pi}{g_4^2} \frac{k(k-1)(k+1)}{24}} (-i)^{Nk} G(1+k), \quad (2.34)$$

where $G(z)$ is the Barnes G-function.

There are several ways to derive (2.33), relying on a generalized Cauchy determinant formula and repeated Fourier transformations. We present one derivation below which makes clear the connections to the descriptions of the D5-brane interface by S-duality and mirror symmetry as explained in the previous section.

We start by rewriting (2.28) using the S-duality kernel $Z^{T[SU(N)]}(a, a')$ which acts on the wavefunction of the $U(N)$ SYM on HS^4 with Dirichlet boundary condition (after dropping an unimportant phase factor compared to [1])

$$Z_{\text{Dir}}^{\text{SYM}}(a, g_4^2) = e^{-\frac{4\pi^2}{g_4^2} \sum_{i=1}^N a_i^2} \frac{\Delta(a)}{\mathbf{\Delta}(a)}, \quad (2.35)$$

as

$$\frac{1}{N!} \int [da'] \mathbf{\Delta}^2(a') Z^{T[SU(N)]}(a', a) Z_{\text{Dir}}^{\text{SYM}}(a', g_4^2) = \left(\frac{g_4^2}{4\pi} \right)^{\frac{N^2}{2}} Z_{\text{Dir}}^{\text{SYM}} \left(a, \frac{16\pi^2}{g_4^2} \right). \quad (2.36)$$

More explicitly, the S-duality kernel for the $U(N)$ SYM corresponds to the partition function of the 3d $T[SU(N)]$ SCFT [50, 51]

$$Z^{T[SU(N)]}(m_i, e_j) = \frac{\sum_{\rho \in S_N} (-1)^{|\rho|} e^{2\pi i \sum_j m_{\rho(j)} e_j}}{i^{\frac{N(N-1)}{2}} \mathbf{\Delta}(m) \mathbf{\Delta}(e)}, \quad (2.37)$$

where m_i and e_j are the mass parameters (FI parameters) for the $SU(N) \times PSU(N)$ global symmetries respectively.⁸ Similarly the partition function $Z^{T[SU(N+k)]}(\alpha, \alpha')$ for the

⁸The mass parameters are subjected to the constraints $\sum_i m_i = \sum_i e_i = 0$.

$T[SU(N+k)]$ SCFT defines the S-duality kernel for the $U(N+k)$ SYM.

Consequently the SYM partition function with D5-brane interface (2.28) becomes⁹

$$\begin{aligned}
Z_{\text{D5}} &= \left(\frac{4\pi}{g_4^2}\right)^{\frac{N^2+(N+k)^2}{2}} \int [da][d\alpha][da'][d\alpha'] \underbrace{\frac{\Delta(a)^2 \Delta(a')^2 \Delta(\alpha)^2 \Delta(\alpha')^2}{(N!)^2 ((N+k)!)^2}}_{3d \text{ vectormultiplet}} \underbrace{\frac{\Delta(a) e^{-\frac{4\pi^2}{g_4^2} \sum_{i=1}^N a_i^2}}{\Delta(a)}}_{U(N) \text{ SYM Dirichlet b.c.}} \\
Z^{T[SU(N)]}(a, a') &\frac{1}{\underbrace{\prod_{i=1}^N \prod_{n=1}^{N+k} 2 \cosh(\pi(a'_i + \alpha'_n))}_{U(N) \times U(N+k) \text{ bifundamental hyper}}} Z^{T[SU(N+k)]}(\alpha, \alpha') \underbrace{\frac{\Delta(\alpha) e^{-\frac{4\pi^2}{g_4^2} \sum_{n=1}^{N+k} \alpha_n^2}}{\Delta(\alpha)}}_{U(N+k) \text{ SYM Dirichlet b.c.}}.
\end{aligned} \tag{2.38}$$

From the quiver descriptions of the 3d $\mathcal{N} = 4$ theories in Figure 2, we note the following relation between their S^3 partition functions. The $T_{[k,1,\dots,1]}[SU(N+k)]$ theory can be obtained from gauging the $U(N)$ symmetry of $T[SU(N)]$ and $N+k$ fundamental $U(N)$ hypermultiplets,¹⁰

$$Z^{T_{[k,1,\dots,1]}[SU(N+k)]}(a, \alpha) = \frac{1}{N!} \int [da'] \Delta(a')^2 \frac{Z^{T[SU(N)]}(a, a')}{\prod_{i=1}^N \prod_{n=1}^{N+k} 2 \cosh(\pi(a'_i + \alpha_n))}. \tag{2.39}$$

The mirror quiver of the D5-brane interface theory is obtained from gauging the diagonal $SU(N+k)$ symmetry of $T_{[k,1,\dots,1]}[SU(N+k)]$ and $T[SU(N+k)]$,

$$K(a, \alpha) = \frac{1}{(N+k)!} \int [d\alpha'] \Delta(\alpha')^2 Z^{T_{[k,1,\dots,1]}[SU(N+k)]}(a, \alpha') Z^{T[SU(N+k)]}(\alpha, \alpha'). \tag{2.40}$$

Therefore, the matrix model in (2.38) can be rewritten as

$$Z_{\text{D5}} = \frac{1}{N!(N+k)!} \int [da][d\alpha] \Delta(a)^2 \Delta(\alpha)^2 Z_{\text{Dir}}(a, g_4^2) K(a, \alpha) Z_{\text{Dir}}(\alpha, g_4^2) \tag{2.41}$$

in accordance with the second dYM description given in the last section, where the D5-brane interface (before S-duality) is described by coupling to a 3d $\mathcal{N} = 4$ quiver theory in the UV with partition function $K(a, \alpha)$. Below we will derive an explicit form for $K(a, \alpha)$ which leads to (2.33).

⁹In this section, we use a, a' and α, α' to denote eigenvalues of hermitian matrices of rank N and $N+k$ respectively.

¹⁰The global symmetry of the $T_{[k,1,\dots,1]}[SU(N+k)]$ theory is $U(N) \times SU(N+k)$. Consequently, the partition function $Z^{T_{[k,1,\dots,1]}[SU(N+k)]}(a, \alpha)$ depends on the overall shifts of a_i , unlike in the case of $T[SU(N)]$.

Partition function of $T_{[k,1,\dots,1]}[SU(N+k)]$

We start by evaluating the partition function for $T_{[k,1,\dots,1]}[SU(N+k)]$. From (2.39), we have

$$\begin{aligned} Z^{T_{[k,1,\dots,1]}[SU(N+k)]}(a, \alpha) &= \frac{(-i)^{\frac{N(N-1)}{2}}}{N! \Delta(a)} \int [da'] \sum_{\sigma \in S_N} (-1)^\sigma e^{2\pi i \sum_{j=1}^N a'_{\sigma(j)} a_j} \\ &\times \frac{\Delta(a')}{\prod_i^N \prod_{n=1}^{N+k} 2 \cosh(\pi(a'_i + \alpha_n))}, \end{aligned} \quad (2.42)$$

where we do not impose $\sum_i a'_i = 0$ or $\sum_i a_i = 0$ in the integrand.¹¹ The SCFT has $U(N) \times SU(N+k)$ global symmetry with mass parameters given by a_i and α_m .

Recall the generalized Cauchy determinant formula in [52] (without constraints on a and α)

$$\frac{(-1)^{\frac{N(N-1)}{2}} e^{\pi k (\sum_{i=1}^N a_i + \sum_{n=1}^{N+k} \alpha_n)} \Delta(a) \Delta(\alpha)}{\prod_{i=1}^N \prod_{n=1}^{N+k} 2 \cosh(\pi(a_i + \alpha_n))} = \det \left(\frac{\theta_{N,n}}{2 \cosh(\pi(a_n + \alpha_m))} + e^{2\pi(N+k+\frac{1}{2}-n)\alpha_m} \theta_{n,N+1} \right)_{m,n}, \quad (2.43)$$

where

$$\theta_{mn} \equiv \begin{cases} 1 & m \geq n, \\ 0 & n < m. \end{cases} \quad (2.44)$$

This allows us to simplify (2.42)

$$\begin{aligned} &Z^{T_{[k,1,\dots,1]}[SU(N+k)]}(a, \alpha) \\ &= \frac{i^{\frac{N(N-1)}{2}}}{N! \Delta(a) \Delta(\alpha)} \int [da'] e^{-\pi k \sum_{i=1}^N a'_i} \sum_{\sigma \in S_N} (-1)^{|\sigma|} e^{2\pi i \sum_{j=1}^N a'_{\sigma(j)} a_j} \\ &\times \sum_{\rho \in S_{N+k}} (-1)^{|\rho|} \prod_{m=1}^{N+k} \left(\frac{\theta_{N,m}}{2 \cosh \pi(\alpha_{\rho(m)} + a'_m)} + e^{2\pi(N+k+\frac{1}{2}-m)\alpha_{\rho(m)}} \theta_{m,N+1} \right), \\ &= \frac{i^{\frac{N(N-1)}{2}}}{N! \Delta(a) \Delta(\alpha)} \int [da'] e^{-\pi k \sum_{i=1}^N a'_i} e^{2\pi i \sum_{j=1}^N a'_j a_j} \\ &\times \sum_{\sigma \in S_N} \sum_{\rho \in S_{N+k}} (-1)^{|\sigma|} (-1)^{|\rho|} \prod_{j=1}^N \frac{1}{2 \cosh \pi(\alpha_{\rho(j)} + a'_{\sigma(j)})} \prod_{m=N+1}^{N+k} e^{2\pi(N+k+\frac{1}{2}-m)\alpha_{\rho(m)}}, \end{aligned} \quad (2.45)$$

¹¹The $T[SU(N)]$ sector only couples to the traceless part of a' , which can be achieved (without the constraint $\sum_i a'_i = 0$) by shifting $a'_i \rightarrow a'_i - a'_N$ which does not modify the $T[SU(N)]$ partition function as long as $\sum_i a_i = 0$. Meanwhile the trace part of a' couples nontrivially to the hypermultiplets and allows for an FI term $e^{2\pi i \eta_N \sum_{i=1}^N a'_i}$ in the partition function (2.42), which is equivalent to further relaxing the constraint $\sum_i a_i = 0$.

where in the second equality, we have made a change of variables $a_j \rightarrow a_{\sigma^{-1}(j)}$ and then sent $\sigma \rightarrow \sigma^{-1}$ in the sum over S_N permutations.

Next we use the Fourier transformation

$$\frac{1}{\cosh \pi y} = \int_{-\infty}^{\infty} dx \frac{e^{2\pi i x y}}{\cosh \pi x} \quad (2.46)$$

for each cosh factors in (2.45) to obtain

$$\begin{aligned} & Z^{T_{[k,1,\dots,1]}[SU(N+k)]}(a, \alpha) \\ &= \frac{i^{\frac{N(N-1)}{2}}}{N! \Delta(a) \Delta(\alpha)} \int [da'] \int \left(\prod_{i=1}^N \frac{dx_i}{2 \cosh \pi x_i} \right) e^{-\pi k \sum_{i=1}^N a'_i} e^{2\pi i \sum_{j=1}^N a'_j a_j} \\ & \quad \times \sum_{\sigma \in S_N} \sum_{\rho \in S_{N+k}} (-1)^{|\sigma|} (-1)^{|\rho|} e^{2\pi i \sum_{j=1}^N x_j (\alpha_{\rho(j)} + a'_{\sigma(j)})} \prod_{m=N+1}^{N+k} e^{2\pi (N+k+\frac{1}{2}-m) \alpha_{\rho(m)}}, \\ &= \frac{i^{\frac{N(N-1)}{2}}}{\Delta(a) \Delta(\alpha)} \int [da'] \int \left(\prod_{i=1}^N \frac{dx_i}{2 \cosh \pi x_i} \right) e^{-\pi k \sum_{i=1}^N a'_i} e^{2\pi i \sum_{j=1}^N a'_j a_j} \\ & \quad \times \sum_{\rho \in S_{N+k}} (-1)^{|\rho|} e^{2\pi i \sum_{j=1}^N x_j (\alpha_{\rho(j)} + a'_j)} \prod_{m=N+1}^{N+k} e^{2\pi (N+k+\frac{1}{2}-m) \alpha_{\rho(m)}}, \end{aligned} \quad (2.47)$$

after a change of variables $x_j \rightarrow x_{\sigma(j)}$ and redefining the S_{N+k} permutation as $\rho \rightarrow \rho \cdot \sigma$ in the second equality. The final step is to integrate out the $U(N)$ variables a'_i , leading to delta functions

$$\prod_{j=1}^N \delta\left(a_j + \frac{kj}{2} + x_j\right), \quad (2.48)$$

and doing the x_i integrals gives¹²

$$Z^{T_{[k,1,\dots,1]}[SU(N+k)]}(a, \alpha) = \frac{i^{\frac{N(N-1)}{2}} \sum_{\rho \in S_{N+k}} (-1)^{|\rho|} e^{\pi \sum_{m=N+1}^{N+k} (2N+k+1-2m) \alpha_{\rho(m)}} e^{-2\pi i \sum_{j=1}^N a_j \alpha_{\rho(j)}}}{\Delta(a) \Delta(\alpha) \prod_{j=1}^N 2 \cosh \pi \left(a_j + \frac{k}{2} i\right)}. \quad (2.49)$$

¹²The S^3 partition function for general $T_\rho^\sigma[G]$ theories was conjectured and proven for the case $G = SU(N)$ and $\sigma = [1, \dots, 1]$ in [51] by induction.

Partition function of D5-brane interface quiver theory

Let us now study the partition function of the D5-brane interface quiver theory using (2.40). Plugging in the partition function (2.49) for the $T_{[k,1,\dots,1]}[SU(N+k)]$ and (2.37) for the $T[SU(N+k)]$ theories, we have

$$\begin{aligned}
K(a, \alpha) &= \frac{i^{\frac{N(N-1)}{2}} (-i)^{\frac{(N+k)(N+k-1)}{2}}}{(N+k)! \Delta(a) \Delta(\alpha) \prod_{j=1}^N 2 \cosh \pi(a_j + \frac{ki}{2})} \int [d\alpha'] \\
&\quad \sum_{\rho \in S_{N+k}} (-1)^{|\rho|} e^{2\pi i \sum_{m=1}^{N+k} \alpha'_{\rho(m)} \alpha_m} \sum_{\sigma \in S_{N+k}} (-1)^{|\sigma|} e^{-2\pi i \sum_{j=1}^N a_j \alpha'_{\sigma(j)}} e^{\pi \sum_{n=N+1}^{N+k} (2N+k+1-2n) \alpha'_{\sigma(n)}}, \\
&= \frac{(-i)^{\frac{k(k-1)+2Nk}{2}}}{\Delta(a) \Delta(\alpha) \prod_{j=1}^N 2 \cosh \pi(a_j + \frac{ki}{2})} \int [d\alpha'] \\
&\quad e^{2\pi i \sum_{m=1}^{N+k} \alpha'_m \alpha_m} \sum_{\sigma \in S_{N+k}} (-1)^{|\sigma|} e^{-2\pi i \sum_{j=1}^N a_j \alpha'_{\sigma(j)}} e^{\pi \sum_{n=N+1}^{N+k} (2N+k+1-2n) \alpha'_{\sigma(n)}}.
\end{aligned} \tag{2.50}$$

In the second equality above, we have made the change of variables $\alpha'_m \rightarrow \alpha'_{\rho^{-1}(m)}$ and then redefined the permutation $\sigma \rightarrow \rho \cdot \sigma$. Now integrating out the $U(N+k)$ eigenvalues α'_m , we get

$$K(a, \alpha) = \frac{(-i)^{\frac{k(k-1)+2Nk}{2}} \sum_{\sigma \in S_{N+k}} (-1)^{\sigma} \prod_{m=1}^{N+k} \delta(\alpha_m - \xi_{\sigma(m)})}{\Delta(a) \Delta(\alpha) \prod_{j=1}^N 2 \cosh \pi(a_j + \frac{ki}{2})} \tag{2.51}$$

where

$$\xi_m = (a_1, a_2, \dots, a_N, i \frac{k-1}{2}, i \frac{k-3}{2}, \dots, i \frac{1-k}{2}). \tag{2.52}$$

Note that the presence of the delta functions in (2.51) is a feature of the *bad* quiver which is essential here to provide the expected continuity condition (2.18) for the $u(N)$ components of the SYM fields.

Plugging the expression (2.51) for $K(a, \alpha)$ into (2.41) together with the hemisphere wavefunctions of the $U(N)$ and $U(N+k)$ SYMs with Dirichlet boundary conditions, and integrating out the delta functions, would give the single matrix model in (2.33) for the D5-brane interface. Below we do it in two steps.

Hemisphere matrix model with Nahm pole boundary condition

As a by-product and also an intermediate step, we can determine the hemisphere wavefunction of the $U(N+k)$ SYM with the Nahm pole boundary condition labelled by $\rho = [k, 1, \dots, 1]$. The IR superconformal boundary condition arises from coupling the SYM on half-space (hemisphere) to the mirror quiver theory (last one in Figure 2) in the UV. The supersymmetric wavefunction for the Nahm pole is then given by the following matrix model,

$$\begin{aligned} Z_{\text{Nahm}}(a, g_4^2) &= \frac{1}{(N+k)!} \int [d\alpha] \Delta(\alpha)^2 K(a, \alpha) Z_{\text{Dir}}(\alpha, g_4^2) \\ &= (-i)^{Nk} \frac{\Delta(a) \prod_{j=1}^N \prod_{n=1}^k (a_j - i \frac{2n-k-1}{2}) \prod_{1 \leq m < n \leq k} (n-m)}{\Delta(a) \prod_{j=1}^N 2 \cosh \pi(a_j + \frac{ki}{2})} \\ &\quad \times e^{-\frac{4\pi^2}{g_4^2} \sum_{i=1}^N a_i^2} e^{\frac{4\pi^2}{g_4^2} \frac{k(k-1)(k+1)}{24}}. \end{aligned} \quad (2.53)$$

This gives

$$Z_{\text{Nahm}}(a, g_4^2) = C'_{N,k} \frac{\Delta(a) \prod_{j=1}^N \prod_{n=1}^k (a_j - i \frac{2n-k-1}{2}) e^{-\frac{4\pi^2}{g_4^2} \sum_{i=1}^N a_i^2}}{\Delta(a) \prod_{j=1}^N 2 \cosh \pi(a_j + \frac{ki}{2})}. \quad (2.54)$$

with

$$C'_{N,k} = e^{\frac{\pi^2 k(k-1)(k+1)}{6g_4^2}} (-i)^{Nk} G(1+k). \quad (2.55)$$

Next the D5-brane interface matrix model is related to (2.54) by gluing with the hemisphere wavefunction of $U(N)$ SYM with Dirichlet boundary condition

$$Z_{\text{D5}} = \left(\frac{4\pi}{g_4^2} \right)^{\frac{N^2+(N+k)^2}{2}} \frac{1}{N!} \int [da] \Delta(a)^2 Z_{\text{Dir}}(a, g_4^2) Z_{\text{Nahm}}(a, g_4^2), \quad (2.56)$$

which gives (2.33) with $C_{N,k} = (4\pi/g_4^2)^{\frac{N^2+(N+k)^2}{2}} C'_{N,k}$.

3 Defect One-Point Function from the D5-brane Matrix Model

In this section, using the D5-brane interface matrix model (2.33), we compute the one-point function $\langle \mathcal{O}_J \rangle_{\mathcal{D}}$ of the half-BPS operators \mathcal{O}_J (2.22) inserted at the north pole $x_\mu = (1, 0, 0, 0)$ on S^4 with the D5-brane interface defect \mathcal{D} along the equator S^3 at $x_1 = 0$. Since we plan to

compare the field theory results with IIB string theory and integrability methods, we work with the planar large N limit where the usual 't Hooft coupling $\lambda = g_4^2 N$ is held fixed.

The $k = 0$ case of the D5-brane interface is particularly simple due to the absence of a Nahm pole in (2.18). The 4d/3d system is simply described by $\mathcal{N} = 4$ $U(N)$ SYM coupled to a 3d hypermultiplet in the fundamental representation at $x_1 = 0$. The corresponding matrix model is simply¹³

$$\mathcal{Z} = \int [da] \frac{\Delta(a)^2}{\prod_{j=1}^N 2 \cosh \pi a_j} e^{-\frac{8\pi^2 N}{\lambda} \sum_{i=1}^N a_i^2}, \quad (3.1)$$

where we have dropped overall constants in (2.33) which are irrelevant for computing the one-point functions $\langle \mathcal{O}_J \rangle_{\mathcal{D}}$. In [1] the one-point function $\langle \mathcal{O}_J \rangle_{\mathcal{D}}$ was computed using the above matrix model in the strong coupling limit to the first nontrivial order in the $\frac{1}{\lambda}$ expansion for the $k = 0$ D5-brane interface defect. The results are in perfect agreement with a probe brane analysis in IIB string theory on $AdS_5 \times S^5$ [54, 55], providing a precision test of AdS/CFT in the presence of interface defects. Here we greatly extend the prior analysis to obtain the planar $\langle \mathcal{O}_J \rangle_{\mathcal{D}}$ with exact λ dependence for both $k = 0$ and $k > 0$. As we will explain, our exact expressions bridge known weak coupling results from integrability methods and strong coupling answers from consideration of probe branes in IIB string theory on $AdS_5 \times S^5$.

3.1 The D5-brane interface at $k = 0$

For simplicity of the presentation, below we will first consider the case $k = 0$ and then generalize to $k > 0$.

3.1.1 Inserting bulk BPS operators

As explained in Section 2.3, from the defect-Yang-Mills description [1], the defect one-point function of \mathcal{O}_J inserted at the north pole of S^4 is computed by an insertion of the form $\sum_{i=1}^N f_J(a_i)$ in the matrix model (3.1), where f_J is a degree J polynomial in a_i that takes into account potential mixing between the operator \mathcal{O}_J and its lower dimensional cousins on

¹³This matrix model first appeared in [53].

S^4 . The eigenvalue integral that we analyze is then given by¹⁴

$$\langle \mathcal{O}_J \rangle_{\mathcal{D}} \equiv \frac{\langle \mathcal{D} \mathcal{O}_J \rangle_{\text{SYM}}}{\langle \mathcal{D} \rangle_{\text{SYM}}} = \frac{1}{\mathcal{Z}} \int \left(\prod_{i=1}^N da_i \right) \frac{\Delta(a)}{\prod_k 2 \cosh \pi a_i} \left[\sum_{i=1}^N f_J(a_i) \right] e^{-\frac{8\pi^2 N}{\lambda} \sum_k a_i^2}, \quad (3.2)$$

where the expectation value of the interface defect $\langle \mathcal{D} \rangle_{\text{SYM}}$ is computed by taking the ratio of \mathcal{Z} and the partition function of SYM without the interface insertion.

As explained in [1, 54], the residual $\mathfrak{so}(3)_{567} \times \mathfrak{so}(3)_{890}$ R-symmetry of the half-BPS interface defect implies that the one-point function $\langle \mathcal{O}_J \rangle_{\mathcal{D}}$ is only nonzero for even J . This can also be seen readily from the above matrix model.

A convenient choice of the function $f_J(a_i)$ is determined by diagonalizing the two-point function of the operators \mathcal{O}_J using the Gram-Schmidt procedure. As shown in the paper [65], the result reads

$$f_J(a) = g^J \left[2T_J \left(\frac{a}{2g} \right) + \delta_{J,2} \right], \quad (3.3)$$

where g is defined by¹⁵

$$g = \frac{\sqrt{\lambda}}{4\pi}, \quad (3.4)$$

and T_n is the Chebyshev polynomial. Note that these single-trace operators are not canonically normalized. Namely their two-point functions are given by

$$\langle \mathcal{O}_J \bar{\mathcal{O}}_J \rangle_{\text{SYM}} = J(2g)^{2J}. \quad (3.5)$$

The canonically normalized operators $\mathcal{O}_J^{\text{norm}}$ are defined by

$$\mathcal{O}_J^{\text{norm}} \equiv \frac{i^J}{2^{\frac{J}{2}} g^J \sqrt{J}} \mathcal{O}_J, \quad (3.6)$$

where the factor i^J is purely a convention we chose to match the result with the results in

¹⁴One can arrive at the same matrix model by doing a different localization computation using the supercharge of [13] in the $\mathcal{N} = 2$ subalgebra $\mathfrak{osp}(4|2)$ of the $\mathcal{N} = 4$ SYM, taking into account the interface (boundary) defect [56–60] as well as local operator insertion at the north pole [61, 62]. There are two lessons here. One is that the agreement between the two localization computations is a consequence of the underlying $\mathcal{N} = 4$ superconformal symmetry of the theory. The other is that the matrix model computation we do here has a direct generalization for theories with only $\mathcal{N} = 2$ supersymmetry. It would be interesting to explore this further as an extension of extremal correlators in $\mathcal{N} = 2$ SCFTs [63, 64] that incorporates interface and boundary defects.

¹⁵This is the standard notation in the integrability literature, although it is confusing at times.

perturbation theory. After the normalization the two-point function reads

$$\langle \mathcal{O}_J^{\text{norm}} \bar{\mathcal{O}}_J^{\text{norm}} \rangle_{\text{SYM}} = 2^J. \quad (3.7)$$

Here 2^J should be understood as coming from the R-symmetry polarization vectors $(Y \cdot \bar{Y})^J$.

To compute the correlator (3.2), it is simpler to exponentiate the piece describing the local operator and consider the following matrix model

$$\mathcal{Z}_J \equiv \int [da] \frac{\Delta(a)}{\prod_{i=1}^N 2 \cosh \pi a_i} \exp \left[-\frac{N}{2g^2} \sum_{i=1}^N a_i^2 - N g_J \sum_{i=1}^N f_J(a_i) \right]. \quad (3.8)$$

The logarithmic derivative of this partition function gives the normalized ratio

$$\langle \mathcal{O}_J \rangle_{\mathcal{D}} = -\frac{1}{N} \partial_{g_J} \log \mathcal{Z}_J |_{g_J=0}. \quad (3.9)$$

3.1.2 Equations for resolvent

We will solve the matrix model (3.8) in the planar large N limit using standard techniques [66, 67]. For this purpose, we introduce a normalized density of eigenvalues

$$\rho(a - a_i) \equiv \frac{1}{N} \sum_{i=1}^N \delta(a - a_i), \quad (3.10)$$

and express the integral as

$$\mathcal{Z}_J = \int \left(\prod_{i=1}^N \frac{da_i}{2 \cosh \pi a_i} \right) \exp [-N^2 S_{\text{eff}}[\rho]], \quad (3.11)$$

with

$$S_{\text{eff}}[\rho] = \frac{1}{2g^2} \int da \rho(a) a^2 + g_J \int da \rho(a) f_J(a) - \frac{1}{2} \int da db \rho(a) \rho(b) \log(a - b)^2. \quad (3.12)$$

Here the last term should be interpreted as the principal value integral. Taking the variation with respect to $\rho(a)$ and further taking ∂_a , we get the saddle point equation

$$\frac{a}{g^2} + g_J f'_J(a) = 2 \int db \frac{\rho(b)}{a - b}. \quad (3.13)$$

Here again, the integral is interpreted as the principal value integral. Namely we have

$$\oint db \frac{\rho(b)}{a-b} = \frac{1}{2} \int db \rho(b) \left[\frac{1}{a-b+i\epsilon} + \frac{1}{a-b-i\epsilon} \right]. \quad (3.14)$$

To proceed, we introduce the resolvent

$$R(a) = \frac{1}{N} \sum_{i=1}^N \frac{1}{a-a_i} = \int db \frac{\rho(b)}{a-b}, \quad (3.15)$$

which satisfies for $\epsilon \rightarrow 0^+$

$$-\frac{1}{2\pi i} [R(a+i\epsilon) - R(a-i\epsilon)] = \rho(a). \quad (3.16)$$

Using (3.16), we can rewrite (3.13) as

$$R(a+i\epsilon) + R(a-i\epsilon) = \frac{a}{g^2} + g_J f'_J(a). \quad (3.17)$$

In addition to this equation, we also need to impose the normalization condition $\int \rho(a) da = 1$. This is equivalent to imposing that $R(a)$ decays as $1/a$ at infinity. Thus, to summarize, the equations we need to solve are

$$R(a+i\epsilon) + R(a-i\epsilon) = \frac{a}{g^2} + g_J f'_J, \quad (3.18)$$

$$R(a) \sim \frac{1}{a} \quad a \rightarrow \infty. \quad (3.19)$$

3.1.3 Solving the matrix model

Since we are interested in a small deformation of the Gaussian matrix model by g_J , we can assume that the eigenvalue in the large N limit condenses into a single cut $[\mu_-, \mu_+]$.

Now, consider the following integral

$$I = \oint_{\mathcal{C}} \frac{dv}{2\pi i} \sqrt{\frac{(u-\mu_+)(u-\mu_-)}{(v-\mu_+)(v-\mu_-)}} \frac{R(v)}{u-v}, \quad (3.20)$$

where the contour \mathcal{C} encircles the branch cut $[\mu_-, \mu_+]$ and u is outside the contour. By

deforming the contour and sending it to infinity, we pick up the contribution from a pole at $u = v$ and get

$$I = R(u). \quad (3.21)$$

Note that the contribution from infinity can be neglected owing to the asymptotic behavior of $R(u)$ (3.19). On the other hand, using (3.18), we can evaluate I alternatively as

$$\begin{aligned} I &= \int_{\mu_- - i\epsilon}^{\mu_+ - i\epsilon} \frac{dv}{2\pi i} \sqrt{\frac{(u - \mu_+)(u - \mu_-)}{(v - \mu_+)(v - \mu_-)}} \frac{R(v + i\epsilon) + R(v - i\epsilon)}{u - v}, \\ &= \int_{\mu_- - i\epsilon}^{\mu_+ - i\epsilon} \frac{dv}{2\pi i} \sqrt{\frac{(u - \mu_+)(u - \mu_-)}{(v - \mu_+)(v - \mu_-)}} \frac{\frac{v}{g^2} + g_J f'_J(v)}{u - v}, \end{aligned} \quad (3.22)$$

which can be converted back to the contour integral

$$I = \oint \frac{dv}{4\pi i} \sqrt{\frac{(u - \mu_+)(u - \mu_-)}{(v - \mu_+)(v - \mu_-)}} \frac{\frac{v}{g^2} + g_J f'_J(v)}{u - v}. \quad (3.23)$$

Equating the two expressions, we obtain an integral representation of $R(u)$,

$$R(u) = \oint \frac{dv}{4\pi i} \sqrt{\frac{(u - \mu_+)(u - \mu_-)}{(v - \mu_+)(v - \mu_-)}} \frac{\frac{v}{g^2} + g_J f'_J(v)}{u - v}. \quad (3.24)$$

This is just a standard solution for the Riemann-Hilbert problem (3.18).

Gaussian matrix model Now the remaining task is to determine the position of the branch points μ_{\pm} . Let us first review how this can be achieved for the Gaussian matrix model, namely for $g_J = 0$ [66, 67]. In this case, owing to the parity symmetry of the potential, we can assume $\mu_+ = -\mu_- = \mu$. We then have

$$R_{\text{Gauss}}(u) = \frac{1}{g^2} \oint \frac{dv}{4\pi i} \sqrt{\frac{u^2 - \mu^2}{v^2 - \mu^2}} \frac{v}{u - v}. \quad (3.25)$$

The right hand side can be evaluated simply by deforming the contour to infinity. As a result we get

$$R(u) = \frac{1}{2g^2} \left(\underbrace{u}_{v=u} - \underbrace{\sqrt{u^2 - \mu^2}}_{v=\infty} \right), \quad (3.26)$$

where, as indicated, the first term comes from the pole at $v = u$ while the second term comes from the pole at infinity. To determine μ , we then impose the condition (3.19) on the asymptotic behavior $R(u) \sim 1/u$. We thus find $\mu = 2g$, and

$$R(u) = \frac{1}{2g^2} \left(u - \sqrt{u^2 - 4g^2} \right) = \frac{1}{g x(u)}. \quad (3.27)$$

Here $x(u)$ is the Zhukovsky variable, which is commonly used in the literature on integrability. Its definition is given by

$$u = g \left(x(u) + \frac{1}{x(u)} \right) \iff x(u) = \frac{u + \sqrt{u^2 - 4g^2}}{2g}. \quad (3.28)$$

Infinitesimal deformation We now consider infinitesimal deformation of the eigenvalue potential in the matrix model

$$V'(u) = \frac{u}{g^2} \rightarrow \frac{u}{g^2} + g_J f'(u), \quad (3.29)$$

with $g_J \ll 1$. Differentiating the equation (3.24) with respect to g_J , we get

$$\begin{aligned} \frac{\partial R(u)}{\partial g_J} &= \oint \frac{dv}{4\pi i} \sqrt{\frac{(u - \mu_+)(u - \mu_-)}{(v - \mu_+)(v - \mu_-)}} \frac{f'_J(v)}{u - v} \\ &+ \frac{1}{g^2} \oint \frac{v dv}{8\pi i} \sqrt{\frac{(u - \mu_+)(u - \mu_-)}{(v - \mu_+)(v - \mu_-)}} \left[\frac{\partial_{g_J} \mu_+}{(v - \mu_+)(u - \mu_+)} + \frac{\partial_{g_J} \mu_-}{(v - \mu_-)(u - \mu_-)} \right]. \end{aligned} \quad (3.30)$$

Since we are interested in a small deformation away from the Gaussian point, we can set $\mu_+ = -\mu_- = 2g$ in the formula and get

$$\begin{aligned} \left. \frac{\partial R(u)}{\partial g_J} \right|_{g_J=0} &= \oint \frac{dv}{4\pi i} \sqrt{\frac{u^2 - 4g^2}{v^2 - 4g^2}} \frac{f'_J(v)}{u - v} \\ &+ \frac{1}{g^2} \oint \frac{v dv}{8\pi i} \sqrt{\frac{u^2 - 4g^2}{v^2 - 4g^2}} \left[\frac{\partial_{g_J} \mu_+}{(v - 2g)(u - 2g)} + \frac{\partial_{g_J} \mu_-}{(v + 2g)(u + 2g)} \right]. \end{aligned} \quad (3.31)$$

To compute these integrals, we express them using the Zhukovsky variables

$$x \equiv x(u), \quad y \equiv x(v). \quad (3.32)$$

Note that $f_J(v)$ takes the following simple form in terms of y as

$$f_J(v) = g^J (2T_J(v/2g) + \delta_{J,2}) = g^J \left[2T_J \left(\frac{y + 1/y}{2} \right) + \delta_{J,2} \right] = g^J \left[y^J + \frac{1}{y^J} + \delta_{J,2} \right], \quad (3.33)$$

where we have used the identity $T_J(\cos \theta) = \cos J\theta$, and dv can be rewritten as

$$dv = dy \frac{dv}{dy} = dy g \left(1 - \frac{1}{y^2} \right). \quad (3.34)$$

As a result, we get

$$\frac{\partial R(u)}{\partial g_J} \Big|_{g_J=0} = \begin{cases} \frac{g^{J-1} J (1-x^{-J})}{x-x^{-1}} + \frac{1}{4g^2} \left[\frac{x+1}{x-1} \partial_{g_J} \mu_+ + \frac{x-1}{x+1} \partial_{g_J} \mu_- \right] & J : \text{even} \\ \frac{g^{J-1} J (\frac{x+x^{-1}}{2} - x^{-J})}{x-x^{-1}} + \frac{1}{4g^2} \left[\frac{x+1}{x-1} \partial_{g_J} \mu_+ + \frac{x-1}{x+1} \partial_{g_J} \mu_- \right] & J : \text{odd} \end{cases}. \quad (3.35)$$

To determine $\partial_{g_J} \mu_{\pm}$, we impose the condition $R(u) \sim 1/u$. This translates to the following condition on $\partial_{g_J} R(u)$:

$$\frac{\partial R(u)}{\partial g_J} \Big|_{g_J=0} \sim O(1/u^2) \quad u \rightarrow \infty. \quad (3.36)$$

We then obtain

$$\begin{aligned} J : \text{even} & \quad \partial_{g_J} \mu_+ = -\partial_{g_J} \mu_- = -g^{J+1} J, \\ J : \text{odd} & \quad \partial_{g_J} \mu_+ = \partial_{g_J} \mu_- = -g^{J+1} J. \end{aligned} \quad (3.37)$$

Putting the above together, the derivative of the resolvent is given by

$$\frac{\partial R(u)}{\partial g_J} \Big|_{g_J=0} = -\frac{g^{J-1} J}{x^J} \frac{1}{x-x^{-1}}, \quad (3.38)$$

both for even and odd J .

3.1.4 Computation of defect one-point functions

Let us now compute the one-point function in the presence of the interface defect using the formula (3.9). In the large N limit, the modified partition function \mathcal{Z}_J is given by

$$\mathcal{Z}_J \sim e^{-N^2 S_{\text{eff}}[\rho]} e^{-N \int \frac{du}{2\pi i} R(u) \log(2 \cosh \pi u)}, \quad (3.39)$$

where $\rho(u)$ and $R(u)$ are saddle point values of the density and the resolvent respectively. By taking the logarithmic derivative, we get

$$-\frac{1}{N}\partial_{g_J}\log\mathcal{Z}_J = N\frac{dS_{\text{eff}}}{dg_J} + \oint\frac{du}{2\pi i}\partial_{g_J}R(u)\log(2\cosh\pi u). \quad (3.40)$$

Among the two terms on the right hand side, the first term can be decomposed into two contributions, one coming from the explicit g_J dependence of the action and the other coming from the variation of ρ , $\partial_{g_J}\rho$:

$$\frac{dS_{\text{eff}}}{dg_J} = \frac{\partial S_{\text{eff}}}{\partial g_J} + \underbrace{\frac{\partial\rho}{\partial g_J}\frac{\delta S_{\text{eff}}}{\delta\rho}}_{=0}. \quad (3.41)$$

As indicated, the second contribution vanishes owing to the equation of motion. It turns out that the first term also vanishes precisely because of our choice of f_J :

$$\begin{aligned} \left.\frac{\partial S_{\text{eff}}}{\partial g_J}\right|_{g_J=0} &= -\oint\frac{du}{2\pi i}R(u)f_J(u), \\ &= -\oint\frac{dx}{2\pi i}g\left(1-\frac{1}{x^2}\right)\frac{1}{gx}g^J\left(x^J+\frac{1}{x^J}+\delta_{J,2}\right) = 0. \end{aligned} \quad (3.42)$$

In the second line, we expressed the integral in terms of the Zhukovsky variable using the conversion formula (3.34) and the integration contour is along the unit circle. Therefore, we only need to compute the second term in (3.40). The result reads

$$\begin{aligned} \langle\mathcal{O}_J\rangle_{\mathcal{D}} &= -g^{J-1}J\oint\frac{du}{2\pi i}\frac{1}{x^J}\frac{\log(2\cosh\pi u)}{x-x^{-1}}, \\ &= -g^J J\oint\frac{dx}{2\pi i x^{J+1}}\log\left[2\cosh\pi g\left(x+\frac{1}{x}\right)\right]. \end{aligned} \quad (3.43)$$

The residue is clearly zero for J odd thus $\langle\mathcal{O}_J\rangle_{\mathcal{D}}$ is nonzero only for J even as explained in the beginning of the section.

Final result The structure constant of the defect CFT can be computed from (3.43) by dividing by the square root of the two-point function of the operator \mathcal{O}_J (3.5). The result reads¹⁶

¹⁶One can in principle expand the logarithm in (3.44) and evaluate the integral term by term. This would lead to an infinite sum representation of (3.44). However we did not find it particularly useful for the purpose of this paper.

$$c_J \equiv \langle \mathcal{O}_J^{\text{norm}} \rangle_{\mathcal{D}} = -\frac{i^J}{2^{J/2}} \sqrt{J} \oint \frac{dx}{2\pi i x^{J+1}} \log \left[2 \cosh \pi g \left(x + \frac{1}{x} \right) \right]. \quad (3.44)$$

An alternative expression can be obtained by performing integration by parts and changing the integration variable $x \rightarrow 1/x$:

$$c_J = \frac{i^J}{2^{J/2} \sqrt{J}} \oint \frac{dx}{2\pi i} g \left(1 - \frac{1}{x^2} \right) \pi x^J \tanh \left[\pi g \left(x + \frac{1}{x} \right) \right]. \quad (3.45)$$

We can also compute the expectation value of the interface defect at large N . The result reads

$$\log \langle \mathcal{D} \rangle_{\text{SYM}} = -\frac{N}{g} \oint \frac{dx}{2\pi i x} \log \left[2 \cosh \pi g \left(x + \frac{1}{x} \right) \right]. \quad (3.46)$$

3.1.5 Weak coupling expansion

The expansion at weak coupling can be obtained straightforwardly by expanding the integral (3.44). The result for even J reads

$$c_J = - (ig\pi)^J 2^{\frac{J}{2}} \frac{B_J(2^J - 1)}{\Gamma(J+1)\sqrt{J}} + \dots, \quad (3.47)$$

where B_J is the Bernoulli number.

3.1.6 Strong coupling expansion

To compute the result at strong coupling, we rewrite the integral (for even J) as

$$\begin{aligned} c_J &= -2 \frac{i^J}{2^{J/2}} \sqrt{J} \int_{-\pi/2}^{\pi/2} \frac{d\theta}{2\pi} e^{-iJ\theta} \log [2 \cosh(2\pi g \cos \theta)], \\ &= -2 \frac{i^J}{2^{J/2}} \sqrt{J} \int_{-\pi/2}^{\pi/2} \frac{d\theta}{2\pi} e^{-iJ\theta} (2\pi g \cos \theta + \log [1 + e^{-4\pi g \cos \theta}]). \end{aligned} \quad (3.48)$$

Since the second term in the parenthesis is exponentially suppressed¹⁷, we simply need to evaluate the first term,

$$c_J \sim -4 \frac{i^J}{2^{J/2}} \pi g \sqrt{J} \int_{-\frac{\pi}{2}}^{\frac{\pi}{2}} \frac{d\theta}{2\pi} e^{-iJ\theta} \cos \theta = \frac{4g(-1)^J \sqrt{J}}{2^{J/2}(J^2 - 1)}. \quad (3.49)$$

This is in agreement with the finding in [1].

3.2 Generalization to D5-brane interface at $k > 0$

The matrix model computation for the $k > 0$ interface is a straightforward generalization of what we have done in the previous section. We start with the relevant matrix integrals for $k > 0$ from (2.33) with the insertion \mathcal{O}_J on the north pole, dropping (common) unimportant overall coefficients,

$$\begin{aligned} \langle \mathcal{D}\mathcal{O}_J \rangle_k &= \int [da] \frac{\Delta(a)^2}{\prod_{j=1}^N 2 \cosh \pi \left(a_j + \frac{ki}{2} \right)} \left[\sum_{j=1}^N f_J(a_j) + \sum_{s=-\frac{k-1}{2}}^{\frac{k-1}{2}} f_J(is) \right] \\ &\times \prod_{s=-\frac{k-1}{2}}^{\frac{k-1}{2}} \prod_n (a_j - is) e^{-\frac{8\pi^2 N}{\lambda} \sum_{i=1}^N a_i^2}, \end{aligned} \quad (3.50)$$

$$\langle \mathcal{D} \rangle_k = \int [da] \frac{\Delta(a)^2}{\prod_{j=1}^N 2 \cosh \pi \left(a_j + \frac{ki}{2} \right)} \prod_{s=-\frac{k-1}{2}}^{\frac{k-1}{2}} \prod_{j=1}^N (a_j - is) e^{-\frac{8\pi^2 N}{\lambda} \sum_{i=1}^N a_i^2}. \quad (3.51)$$

Here we have denoted in red the modifications of the matrix model compared to the $k = 0$ case. Note that if the local operator \mathcal{O}_J is inserted at the south pole, the only difference would be dropping the red term in the square bracket above.

In the presence of these extra factors, the logarithmic derivative of the $k > 0$ interface

¹⁷Note that $\cos \theta > 0$ in the integration range of the integral.

partition function receives the following extra contributions

$$\langle \mathcal{O} \rangle_{\mathcal{D}_k} \equiv \frac{\langle \mathcal{D}\mathcal{O}_J \rangle_k}{\langle \mathcal{D} \rangle_k} = \langle \mathcal{O}_J \rangle_{\mathcal{D}|_{\text{modified}}} - \underbrace{\sum_{s=-\frac{k-1}{2}}^{\frac{k-1}{2}} \oint \frac{du}{2\pi i} \partial_{g_j} R(u) \log(u - is)}_{\equiv \text{extra1}} + \underbrace{\sum_{s=-\frac{k-1}{2}}^{\frac{k-1}{2}} f_J(is)}_{\equiv \text{extra2}}. \quad (3.52)$$

Here the first term on the RHS comes from modifying the result for $k = 0$ by taking into account the shift in $\cosh \pi a_j \rightarrow \cosh(\pi a_j + \frac{ki}{2}\pi)$ in the matrix model (2.33),

$$\langle \mathcal{O}_J \rangle_{\mathcal{D}|_{\text{modified}}} = \oint \frac{dx}{2\pi i} g \left(1 - \frac{1}{x^2}\right) x^J \pi \tanh \left[\pi g \left(x + \frac{1}{x}\right) + \frac{ki}{2}\pi \right]. \quad (3.53)$$

Using the explicit form of $\partial_{g_j} R$, the first extra contribution can be evaluated as

$$\begin{aligned} \text{extra1} &= g^J J \sum_{s=-\frac{k-1}{2}}^{\frac{k-1}{2}} \oint \frac{dx}{2\pi i} \left(1 - \frac{1}{x^2}\right) \frac{1}{x^J} \frac{\log[g((x + x^{-1}) - (x_s + x_s^{-1}))]}{x - x^{-1}}, \\ &= g^J \sum_{s=-\frac{k-1}{2}}^{\frac{k-1}{2}} \oint_{|x|=1} \frac{dx}{2\pi i x^J} \left(1 - \frac{1}{x^2}\right) \frac{1}{x + x^{-1} - (x_s + x_s^{-1})}, \end{aligned} \quad (3.54)$$

where $x_s \equiv x(is)$. We can evaluate this integral by pushing the contour to infinity, and picking the residues at poles at $x = x_s$. Then we get

$$\text{extra1} = -g^J \sum_{s=-\frac{k-1}{2}}^{\frac{k-1}{2}} x_s^{-J}. \quad (3.55)$$

On the other hand, the second extra contribution can be expressed as

$$\text{extra2} = g^J \sum_{s=-\frac{k-1}{2}}^{\frac{k-1}{2}} [x_s^J + x_s^{-J} + \delta_{J,2}]. \quad (3.56)$$

We thus conclude that the sum of extra contributions is given by

$$\text{extra1} + \text{extra2} = g^J \sum_{s=-\frac{k-1}{2}}^{\frac{k-1}{2}} (x_s^J + \delta_{J,2}). \quad (3.57)$$

Taking into account the normalization of the operator, we thus get the following result

at large N :

$$c_J^{(k)} = \frac{i^J}{2^{\frac{J}{2}} \sqrt{J}} (\text{integral} + \text{sum}) , \quad (3.58)$$

with

$$\text{integral} = \begin{cases} \oint \frac{dx}{2\pi i} g \left(1 - \frac{1}{x^2}\right) x^J \pi \coth \left[\pi g \left(x + \frac{1}{x}\right)\right] & k \in 2\mathbb{Z} + 1 , \\ \oint \frac{dx}{2\pi i} g \left(1 - \frac{1}{x^2}\right) x^J \pi \tanh \left[\pi g \left(x + \frac{1}{x}\right)\right] & k \in 2\mathbb{Z} , \end{cases} \quad (3.59)$$

$$\text{sum} = \sum_{s=-\frac{k-1}{2}}^{\frac{k-1}{2}} (x_s^J + \delta_{J,2}) . \quad (3.60)$$

3.3 Comparisons with results from perturbation theory and holography

3.3.1 Weak coupling expansions

Let us first expand the result (3.58) at weak coupling. The contribution from the integral part integral to $c_J^{(k)}$ starts at $\mathcal{O}(g^J)$, while the contribution from the sum starts at $\mathcal{O}(g^{-J})$ which follows from the expansion

$$x(u) = \frac{u - \frac{g^2}{u} + \dots}{g} . \quad (3.61)$$

Let us now expand $c_J^{(k)}$ up to the subleading order $\mathcal{O}(g^{2-J})$ in order to compare with the perturbative results in [37] using Feynman diagrams at tree level and one-loop. For this purpose we can just focus on the contribution from the sum part.

Using the following summation identity for the Bernoulli Polynomial $B_n(z)$

$$\sum_{s=-\frac{k-1}{2}}^{\frac{k-1}{2}} s^J = -\frac{2}{J+1} B_{J+1} \left(\frac{1-k}{2} \right) , \quad (3.62)$$

we obtain

$$c_J^{(k)} = -\frac{2}{2^{\frac{J}{2}} g^J \sqrt{J}} \left[\frac{B_{J+1} \left(\frac{1-k}{2} \right)}{J+1} + g^2 \frac{J B_{J-1} \left(\frac{1-k}{2} \right)}{J-1} + g^2 \delta_{J,2} \frac{k}{2} \right] . \quad (3.63)$$

This beautifully matches the result in [37].¹⁸

3.3.2 Strong coupling expansions and holography

Here we consider the strong coupling limit of the defect one-point function $\langle \mathcal{O}_J \rangle_{\mathcal{D}_k}$ where we draw connection to computations in IIB string theory on $AdS_5 \times S^5$ via the holographic correspondence [16]. After taking the near horizon limit of the D3-branes, the D5-brane interface defect that interpolates between the $SU(N)$ and $SU(N+k)$ SYMs maps to a probe D5-brane wrapping an $AdS_4 \times S^2$ submanifold in the bulk with k -units of worldvolume flux through the S^2 factor [32].¹⁹ The embedding of the submanifold $AdS_4 \times S^2$ in $AdS_5 \times S^5$ depends on the spacetime and R-symmetry orientation of the interface defect on the boundary (here we follow the convention in [1]). The embedding $AdS_4 \subset AdS_5$ also depends on k [32]. The one-point function $\langle \mathcal{O}_J \rangle_{\mathcal{D}_k}$ can be computed by standard holographic methods in the bulk which we review below and match with limits of our exact expression (3.58) in the 't Hooft coupling λ and flux quanta k .

Large J The strong coupling behavior of the integral part `integral` was already evaluated in (3.49). Therefore, we just need to know the strong-coupling behavior of the sum part `sum`. In the scaling limit $k \sim \sqrt{\lambda}$, we can approximate the sum by an integral

$$\text{sum} \sim 2g \int_0^{2\kappa} dz x(igz)^J \quad (3.64)$$

where κ is the ratio

$$\kappa = \frac{\pi k}{\sqrt{\lambda}} = \frac{k}{4g}. \quad (3.65)$$

Since each term in the integrand is monotonic in z , we can evaluate them at the edges of the integration range when $J \gg 1$. As a result, we get

$$\text{sum} \sim 2gi^J \left(\kappa + \sqrt{\kappa^2 + 1} \right)^J. \quad (3.66)$$

Since $J \gg 1$, this contribution is exponentially larger than the contribution from the integral `integral` given in (3.49).

Multiplying the prefactor in (3.58), we see that it reproduces the result computed from

¹⁸Note that the results there are not properly normalized.

¹⁹In the leading large N limit, the interface between the $SU(N)$ and $SU(N+k)$ SYMs is indistinguishable from that between the $U(N)$ and $U(N+k)$ SYMs which we have studied in previous sections.

the classical string worldsheet [34]

$$c_J^{(k)} \sim \left(\frac{\kappa + \sqrt{\kappa^2 + 1}}{\sqrt{2}} \right)^J. \quad (3.67)$$

Finite J For finite J , we can simply perform the integral (3.64) analytically to get

$$\text{sum} = -\frac{4gJ}{J^2 - 1} + (\kappa + \sqrt{1 + \kappa^2})^J \frac{4g [-\kappa + J\sqrt{1 + \kappa^2}]}{J^2 - 1}. \quad (3.68)$$

It turns out that the first term cancels the integral term `integral` given in (3.49) and the final answer reads

$$c_J^{(k)} = \left(\kappa + \sqrt{1 + \kappa^2} \right)^J \frac{4(-1)^J g [-\kappa + J\sqrt{1 + \kappa^2}]}{2^{\frac{J}{2}} \sqrt{J} (J^2 - 1)}. \quad (3.69)$$

The bulk Witten diagram computation of the one-point function $c_J^{(k)}$ was carried out at tree-level in IIB supergravity in [68] by taking into account interaction vertices on the world-volume of the probe D5-brane. The result takes the form (see also [1])

$$c_J = \mathcal{C}_{\frac{J}{2}} g \frac{2^{2+\frac{J}{2}} \Gamma(J + \frac{1}{2})}{\sqrt{\pi J} \Gamma(J)} \int_0^\infty du \frac{u^{J-2}}{[(1 - \kappa u)^2 + u^2]^{J+\frac{1}{2}}}, \quad (3.70)$$

with $\mathcal{C}_{\frac{J}{2}}$ coming from integrating the internal part of the bulk wavefunction over the S^2

$$\mathcal{C}_{\frac{J}{2}} = \frac{1}{4\pi} \int dV_{S^2} (\cos \theta)^{\frac{J}{2}} = \frac{(-1)^J}{J + 1}. \quad (3.71)$$

The integral can be performed for each integer J analytically. By computing it for various different values and using `FindSequenceFunction` in Mathematica, we found that the result is given by

$$\begin{aligned} & \int_0^\infty du \frac{u^{J-2}}{[(1 - \kappa u)^2 + u^2]^{J+\frac{1}{2}}} = \\ & \left(\kappa + \sqrt{1 + \kappa^2} \right)^{J-1} \frac{\sqrt{\pi} \Gamma(J - 1)}{2^{J+1} \Gamma(J + \frac{1}{2})} \left[J + 1 + (J - 1)(\kappa + \sqrt{1 + \kappa^2})^2 \right]. \end{aligned} \quad (3.72)$$

Combining all the factors, we get precisely (3.69).

4 Integrable Bootstrap for One-Point Functions

In this section, we focus on the planar limit and study the defect one-point functions from integrability. The defect one-point functions of non-BPS single-trace operators were studied at weak coupling in [33–45]. The results for the D5-brane defect exhibit two important features:

1. They are nonzero only when the single-trace operator corresponds to a parity-symmetric Bethe state, $|u_1, -u_1, \dots, u_{\frac{M}{2}}, -u_{\frac{M}{2}}\rangle$, with u 's being the rapidities of the excitations on the spin chain.
2. The results are given by a ratio of two determinants, each of which resembles the so-called Gaudin determinant [69–72].

As explained in section 6 of [2], these two features imply that the defect one-point functions can be interpreted as overlaps between an integrable boundary state on the string worldsheet and a closed string state describing the single-trace operator.

In what follows, we build on this assumption and bootstrap the integrable boundary state at finite λ by imposing a set of consistency conditions.

4.1 General strategy

On the string-theory side, the one-point function in the presence of the D5-brane defect corresponds to a disk worldsheet with a closed-string vertex operator insertion. Viewed differently, it is an overlap between a closed string state $|\Psi\rangle$, which describes a single-trace operator, and the boundary state $|\mathcal{D}\rangle$, which describes the probe D5-brane in AdS:

$$\langle \mathcal{O} \rangle_{\mathcal{D}} = \langle \mathcal{D} | \Psi \rangle. \quad (4.1)$$

In flat space such overlaps can be computed using the standard 2d CFT techniques. This is not the case in $AdS_5 \times S^5$ since the worldsheet theory is strongly-coupled at finite λ . A way to overcome this problem is to use integrability. To apply integrability, we first gauge-fix the worldsheet diffeomorphism by choosing the generalized lightcone gauge.²⁰ In this gauge, the spatial length of the string is proportional to one of the R -charges of the state (which we denote by J) and the resulting worldsheet theory is an integrable 2d theory of 8 massive bosons and 8 massive fermions [74, 75].

²⁰See [73] for a pedagogical review on the generalized lightcone gauge.

Assuming the boundary state $|\mathcal{D}\rangle$ is an integrable boundary state,²¹ one can compute the overlap (4.1) following the strategy laid out in [2, 3]:

1. First we consider the overlap for an infinitely long string $\langle\mathcal{D}|\Psi\rangle|_{J\rightarrow\infty}$. In this limit, the closed string state $|\Psi\rangle$ can be described as a collection of “magnon” excitations on the vacuum, for instance, as

$$|\Psi\rangle = |\mathcal{X}_1(u_1)\mathcal{X}_2(u_2)\cdots\mathcal{X}_M(u_M)\rangle \quad (4.2)$$

where \mathcal{X}_i 's are magnons and u_i 's are their rapidities. Thus the right hand side of (4.1) is a function of these rapidities in this limit.

When $|\mathcal{D}\rangle$ is an integrable boundary state, the overlap in the infinite volume limit can be decomposed into two-particle overlaps

$$\langle\mathcal{D}|\mathcal{X}_1(u)\mathcal{X}_2(\bar{u})\rangle \quad (4.3)$$

where \bar{u} is a parity-conjugate rapidity of u (see (4.15) for the definition).

2. Next we bootstrap the two-particle overlap by imposing a set of consistency conditions such as the global symmetry constraints, the Watson's equation, boundary Yang-Baxter equations, and crossing equations. Once determined, the two-particle overlaps allow us to write down the *asymptotic overlap*, which includes all the perturbative $1/J$ corrections.
3. To compute the overlaps at finite J which include corrections nonperturbative in J (called the *wrapping corrections*), we first analyze the ground-state overlap $\langle\mathcal{D}|\Omega\rangle$ in the open string channel, and write down the thermodynamic Bethe ansatz (TBA). A crucial input for writing down the TBA is the reflection matrix, which can be obtained from the overlap determined in step 2 by the analytic continuation. From the TBA, we can derive the Fredholm-determinant representation [78–81] for the ground-state overlap at finite J .
4. Finally, we generalize the result to excited states using the analytic continuation trick proposed by Dorey and Tateo [82].

²¹The integrable boundary states are defined as the boundary states which are annihilated by (infinitely many) odd-spin conserved charges [76]. See also [77] for the analysis in integrable spin chains.

In this paper, we perform the analysis up to step 2. This is enough for the comparison with weak-coupling results in the literature since the wrapping corrections kick in only at higher loop orders. In principle it should be possible to complete the program based on the results in this paper but we leave it to a future work.

An important new ingredient which was not present in the analysis of [2] is the existence of *excited boundary states* (cf. [76]): The D5-brane defect does not correspond to a single boundary state, but rather corresponds to a set of boundary states, which can be viewed as excited states of some basic boundary state. In Section 4.6, we show that this feature is essential in order to reproduce the results in the literature.

4.2 Dynamic $\mathfrak{psu}(2|2)$ spin chain

Before delving into the actual computation, let us review the integrability description of closed-string states in $AdS_5 \times S^5$. In the infinite volume limit $J \rightarrow \infty$, the closed string state is described by the dynamic $\mathfrak{psu}(2|2)$ spin chain introduced by Beisert [83, 84]. In this description, each magnon belongs to a bifundamental representation of the centrally-extended $\mathfrak{psu}(2|2)^2$ symmetry. The precise relation between the fields in $\mathcal{N} = 4$ SYM and the excitations in the dynamic spin chain is given by

$$\begin{aligned} \phi^a \dot{\phi}^{\dot{b}} &\mapsto \Phi^{a\dot{b}} & (\Delta^0, J) &= (1, 0), & \psi^\alpha \dot{\psi}^{\dot{\beta}} &\mapsto D^{\alpha\dot{\beta}} Z & (\Delta^0, J) &= (2, 1), \\ \psi^\alpha \dot{\phi}^{\dot{a}} &\mapsto \Psi^{\alpha\dot{a}} & (\Delta^0, J) &= (3/2, 1/2), & \phi^a \dot{\psi}^{\dot{\alpha}} &\mapsto \Psi^{a\dot{\alpha}} & (\Delta^0, J) &= (3/2, 1/2), \end{aligned} \quad (4.4)$$

where the dotted and undotted indices correspond to the right and the left $\mathfrak{psu}(2|2)$ respectively and all the indices take 1 or 2. Here Ψ 's are fermion fields, $D^{\alpha\dot{\beta}}$'s are covariant derivatives, Z and \bar{Z} are the complex combination of the two scalars $\Phi_7 + i\Phi_8$ and its conjugate, and Φ^{ab} 's are combinations of the other four scalars $\Phi_{5,6,9,0}$. Δ^0 is the classical dimension and J is the $U(1)$ R -charge generated by R_{78} in the full $SO(6)_R$ symmetry which we used to define the length of the string.²²

Symmetry Let us now summarize the action of the $\mathfrak{psu}(2|2)^2$ generators on the excitations. Since the actions of the left and the right $\mathfrak{psu}(2|2)$'s are identical, we only write the results

²² Z and \bar{Z} have +1 and -1 charges for this $U(1)$ symmetry.

for the left $\mathfrak{psu}(2|2)$:²³

$$\begin{aligned}
R_b^a|\phi^c\rangle &= \delta_b^c|\phi^a\rangle - \frac{1}{2}\delta_b^a|\phi^c\rangle, & L_\beta^\alpha|\psi^\gamma\rangle &= \delta_\beta^\gamma|\psi^\alpha\rangle - \frac{1}{2}\delta_\beta^\alpha|\psi^\gamma\rangle, \\
Q_a^\alpha|\phi^b\rangle &= \mathbf{a}\delta_a^b|\psi^\alpha\rangle, & Q_a^\alpha|\psi^\beta\rangle &= \mathbf{b}\epsilon^{\alpha\beta}\epsilon_{ab}|Z^+\phi^b\rangle, \\
S_\alpha^a|\phi^b\rangle &= \mathbf{c}\epsilon^{ab}\epsilon_{\alpha\beta}|Z^-\psi^\beta\rangle, & S_\alpha^a|\psi^\beta\rangle &= \mathbf{d}\delta_\alpha^a|\phi^b\rangle.
\end{aligned} \tag{4.5}$$

Here L 's are the Lorentz generators and R 's are the R-symmetry generators while Q 's and S 's are the supersymmetry and the superconformal generators respectively. The parameters \mathbf{a} - \mathbf{d} are functions of the rapidity u of the excitation and are given by

$$\mathbf{a}(u) \equiv \sqrt{g}\gamma, \quad \mathbf{b}(u) \equiv \frac{\sqrt{g}}{\gamma} \left(1 - \frac{x^+}{x^-}\right), \quad \mathbf{c}(u) \equiv \frac{i\sqrt{g}\gamma}{x^+}, \quad \mathbf{d}(u) \equiv \frac{\sqrt{g}x^+}{i\gamma} \left(1 - \frac{x^-}{x^+}\right),$$

where γ satisfies

$$|\gamma|^2 = i(x^- - x^+). \tag{4.6}$$

and $x(u)$ is the Zhukovsky variable (3.28) given by $u = g(x + 1/x)$. The plus and minus superscripts denote the shift of the rapidity by $i/2$, namely $f^\pm(u) = f(u \pm i/2)$.

In addition to these global charges, the dynamic spin chain has three central charges C , P and K which appear in the anti-commutators of fermionic charges

$$\begin{aligned}
\{Q_a^\alpha, Q_b^\beta\} &= \epsilon^{\alpha\beta}\epsilon_{ab}P, & \{\dot{Q}_{\dot{a}}^{\dot{\alpha}}, \dot{Q}_{\dot{b}}^{\dot{\beta}}\} &= \epsilon^{\dot{\alpha}\dot{\beta}}\epsilon_{\dot{a}\dot{b}}P, \\
\{S_\alpha^a, S_\beta^b\} &= \epsilon^{ab}\epsilon_{\alpha\beta}K, & \{\dot{S}_{\dot{\alpha}}^{\dot{a}}, \dot{S}_{\dot{\beta}}^{\dot{b}}\} &= \epsilon^{\dot{a}\dot{b}}\epsilon_{\dot{\alpha}\dot{\beta}}K, \\
\{Q_a^\alpha, S_\beta^b\} &= \delta_a^b L^\alpha{}_\beta + \delta_\beta^a R^b{}_a + \frac{1}{2}\delta_a^b\delta_\beta^\alpha C, & \{\dot{Q}_{\dot{a}}^{\dot{\alpha}}, \dot{S}_{\dot{\beta}}^{\dot{b}}\} &= \delta_{\dot{a}}^{\dot{b}} \dot{L}^{\dot{\alpha}}{}_{\dot{\beta}} + \delta_{\dot{\beta}}^{\dot{a}} \dot{R}^{\dot{b}}{}_{\dot{a}} + \frac{1}{2}\delta_{\dot{a}}^{\dot{b}}\delta_{\dot{\beta}}^{\dot{\alpha}} C.
\end{aligned} \tag{4.7}$$

The action of these charges on the excitation $|\mathcal{X}\rangle$ reads

$$C|\mathcal{X}\rangle = \frac{1}{2}(\mathbf{ad} + \mathbf{bc})|\mathcal{X}\rangle, \quad P|\mathcal{X}\rangle = \mathbf{ab}|Z\mathcal{X}\rangle, \quad K|\mathcal{X}\rangle = \mathbf{cd}|Z^-\mathcal{X}\rangle. \tag{4.8}$$

Physically, C is a linear combination of the dilatation D and the R -symmetry charge J ,

$$C = \frac{D - J}{2}, \tag{4.9}$$

while P and K correspond to the field-dependent gauge transformations (see e.g. section 3.2 of [85] for further explanation). The extra insertions of Z and Z^{-1} are called Z -markers and are book-keeping devices for the nontrivial coproduct structure of the symmetry algebra

²³In what follows, $\epsilon^{12} = \epsilon^{i\dot{2}} = -\epsilon_{12} = -\epsilon_{i\dot{2}} = 1$.

[74, 83, 84, 86]. On the field theory side they simply correspond to an insertion or a removal of the Z -field which can be moved around using the following rule:

$$|\mathcal{X} Z^\pm\rangle = \left(\frac{x^+}{x^-}\right)^{\pm 1} |Z^\pm \mathcal{X}\rangle. \quad (4.10)$$

Crossing, mirror and parity transformations The energy and the momentum of the magnon excitation admit compact expressions in terms of the Zhukovsky variable:

$$E(u) = \frac{1}{2} \frac{1 + \frac{1}{x^+ x^-}}{1 - \frac{1}{x^+ x^-}}, \quad p(u) = \frac{1}{i} \log \frac{x^+}{x^-}. \quad (4.11)$$

Owing to the definition of the Zhukovsky variable (3.28), they contain two branch cuts, one for x^+ and the other for x^- , when viewed as a function of the rapidity u . The analytic continuations across these branch cuts invert the corresponding Zhukovsky variables ($x^\pm \rightarrow 1/x^\pm$), and define analogues of the crossing and the mirror transformations in the relativistic field theory.

Let us first consider the analytic continuation (to be denoted by $u^{2\gamma}$) in which we cross both of the cuts once. This process transforms the Zhukovsky variables as

$$x^+(u^{2\gamma}) = 1/x^+(u), \quad x^-(u^{2\gamma}) = 1/x^-(u). \quad (4.12)$$

Using (4.11), one can check that this flips the signs of the energy and the momentum. Physically, this can be interpreted as the *crossing transformation*, which maps a particle to an antiparticle.

If we instead cross only one of the two cuts, we have either

$$x^+(u^\gamma) = 1/x^+(u), \quad x^-(u^\gamma) = x^-(u), \quad (4.13)$$

or

$$x^-(u^{-\gamma}) = x^-(u), \quad x^+(u^{-\gamma}) = 1/x^+(u), \quad (4.14)$$

depending on which cut we crossed. These transformations are interpreted as the *mirror transformations*. They map a particle in the original theory to a particle in the so-called mirror theory in which the roles of space and time on the worldsheet are swapped.

Yet another important transformation is the parity transformation $u \rightarrow \bar{u}$. This is nothing but the standard parity transformation on the worldsheet. In terms of the Zhukovsky

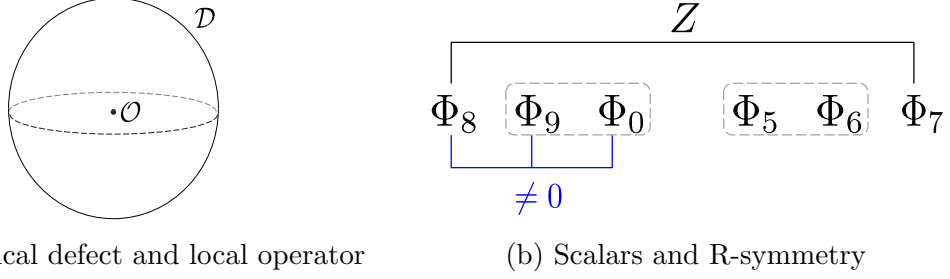

(a) Spherical defect and local operator

(b) Scalars and R-symmetry

Figure 4: The half-BPS defect breaks $\mathfrak{psu}(2|2)^2$ down to $\mathfrak{su}(2|1)^2$. Their bosonic subgroups $\mathfrak{su}(2)^2$ and $\mathfrak{u}(1)^2$ are realized as follows: (a) A spherical defect and a local operator inserted at the origin preserves the $SO(4)$ Lorentz symmetry. (b) Among the six scalars in $\mathcal{N} = 4$ SYM, two of them $\Phi_{7,8}$ are used to define the vacuum of the dynamic spin chain, and three of them $\Phi_{8,9,0}$ acquire nontrivial vacuum expectation values in the presence of the defect. Therefore the residual symmetry group is $U(1)^2$ which rotate $\Phi_{9,0}$ and $\Phi_{5,6}$ (encircled by the dashed curves).

variables, it is defined by

$$x^+(\bar{u}) = -x^-(u), \quad x^-(\bar{u}) = -x^+(u). \quad (4.15)$$

One can readily check from (4.11) that this flips the sign of the momentum but not of the energy.

4.3 Symmetry constraints on the two-particle overlap

$\mathfrak{su}(2|1)^2$ symmetry In the presence of the half-BPS defect, the $\mathfrak{psu}(2|2)^2$ symmetry is broken down to a subgroup which is an intersection of $\mathfrak{psu}(2|2)^2$ and the defect superconformal symmetry $\mathfrak{osp}(4|4, \mathbb{R})$. To understand the structure of this subalgebra, it is useful to place the single-trace operator at the origin and consider a spherical defect of radius r around it. As explained in Figure 4, this configuration manifestly preserves the $SO(4) (\simeq SU(2)^2)$ rotation symmetry, and the $U(1)^2$ R -symmetry which rotates $\Phi_{9,0}$ and $\Phi_{5,6}$ in (2.8). Once the fermionic charges are included, these bosonic symmetries get completed into the $\mathfrak{su}(2|1)^2$ subalgebra whose generators are given by

$$\begin{aligned} \mathcal{R} &\equiv R^1_1 - R^2_2, & L^\alpha_\beta, & & \mathcal{S}^a_\alpha &\equiv S^a_\alpha + ir\epsilon_{\alpha\beta}\sigma^{ab}Q^\beta_b, \\ \hat{\mathcal{R}} &\equiv \hat{R}^1_1 - \hat{R}^2_2, & \hat{L}^{\dot{\alpha}}_{\dot{\beta}}, & & \hat{\mathcal{S}}^{\dot{a}}_{\dot{\alpha}} &\equiv \hat{S}^{\dot{a}}_{\dot{\alpha}} + ir\epsilon_{\dot{\alpha}\dot{\beta}}\sigma^{\dot{a}\dot{b}}\hat{Q}^{\dot{\beta}}_{\dot{b}}, \end{aligned} \quad (4.16)$$

where r is the radius of the spherical defect and σ^{ab} is a symmetric tensor defined by

$$\sigma^{11} = \sigma^{22} = 0, \quad \sigma^{12} = \sigma^{21} = 1. \quad (4.17)$$

These generators satisfy the following algebras:²⁴

$$\begin{aligned} [L^\alpha{}_\beta, \mathcal{R}] &= 0, \quad [L^\alpha{}_\beta, \mathcal{S}^a_\gamma] = \delta^\alpha_\gamma \mathcal{S}^a_\beta - \frac{1}{2} \delta^\alpha_\beta \mathcal{S}^a_\gamma, \\ [\mathcal{R}, \mathcal{S}^1{}_\alpha] &= +\mathcal{S}^1{}_\alpha, \quad [\mathcal{R}, \mathcal{S}^2{}_\alpha] = -\mathcal{S}^2{}_\alpha \\ \{\mathcal{S}^a{}_\alpha, \mathcal{S}^b{}_\beta\} &= \epsilon_{\alpha\beta} \epsilon^{ab} (K + r^2 P + ir\mathcal{R}) + i\sigma^{ab} (\epsilon_{\alpha\gamma} L^\gamma{}_\beta + \epsilon_{\beta\gamma} L^\gamma{}_\alpha) \end{aligned} \quad (4.18)$$

Note that the central charges P and K always appear in the combination $K + r^2 P + ir\mathcal{R}$, and the algebra is isomorphic to $\mathfrak{su}(2|1)$ without central extension.

We now discuss the implication of $\mathfrak{su}(2|1)^2$ symmetry on the two-particle overlap. Explicitly, we impose²⁵

$$\langle \mathcal{D}|j| \mathcal{X}^{A\dot{A}}(u) \mathcal{X}^{B\dot{B}}(\bar{u}) \rangle = 0, \quad j \in \mathfrak{su}(2|1)_L \oplus \mathfrak{su}(2|1)_R. \quad (4.19)$$

Here A, B and \dot{A}, \dot{B} label abstractly the indices carried by the left and right excitations separately.

Owing to the structure of the symmetry algebra $\mathfrak{su}(2|1)^2$, it is useful to factorize the overlap into the left and the right parts as

$$\langle \mathcal{D}| \mathcal{X}^{A\dot{A}}(u) \mathcal{X}^{B\dot{B}}(\bar{u}) \rangle = F_0(u) \times \langle \mathfrak{d}| \chi^A(u) \chi^B(\bar{u}) \rangle \times \langle \mathfrak{d}| \chi^{\dot{A}}(u) \chi^{\dot{B}}(\bar{u}) \rangle \quad (4.20)$$

and discuss constraints from the left and the right $\mathfrak{su}(2|1)$'s separately. Here F_0 is an overall scalar factor which will be determined later.

Constraints from bosonic symmetry Let us impose the invariance under the bosonic symmetry. First, from the left $SU(2)$ rotation symmetry, we can constrain the overlaps

²⁴Since the left and the right $\mathfrak{su}(2|1)$ have the identical structure, here we only write down the commutation relations for the left part.

²⁵The integrable boundary states with $\mathfrak{su}(2|1)^2$ were analyzed also in [91]. Their boundary state is in the mirror channel while our boundary state is in the physical channel. Since the non-relativistic worldsheet theories in the mirror and the physical channels are inequivalent, there seems to be no simple relation between the two boundary states.

involving fermions as

$$\begin{aligned}\langle \mathfrak{d}|\psi^\alpha(u)\psi^\beta(\bar{u})\rangle &= \epsilon^{\alpha\beta}, \\ \langle \mathfrak{d}|\phi^a(u)\psi^\beta(\bar{u})\rangle &= \langle \mathfrak{d}|\psi^\alpha(u)\phi^b(\bar{u})\rangle = 0.\end{aligned}\tag{4.21}$$

To constrain the overlap of two bosons, we impose the invariance under the $U(1)$ generator $K + r^2P + ir\mathcal{R}$. This is equivalent to imposing the invariance under \mathcal{R} since the action of $K + r^2P$ annihilates a parity-invariant pair of excitations $|\mathcal{X}(u)\mathcal{X}(\bar{u})\rangle$ as can be verified from (4.8). We then get

$$\begin{aligned}0 &= \langle \mathfrak{d}|\mathcal{R}|\phi^1(u)\phi^1(\bar{u})\rangle = 2\langle \mathfrak{d}|\phi^1(u)\phi^1(\bar{u})\rangle, \\ 0 &= \langle \mathfrak{d}|\mathcal{R}|\phi^2(u)\phi^2(\bar{u})\rangle = -2\langle \mathfrak{d}|\phi^2(u)\phi^2(\bar{u})\rangle.\end{aligned}\tag{4.22}$$

Therefore, only nonzero components are the following ones:

$$\langle \mathfrak{d}|\phi^1(u)\phi^2(\bar{u})\rangle =: k_+(u), \quad \langle \mathfrak{d}|\phi^2(u)\phi^1(\bar{u})\rangle =: k_-(u).\tag{4.23}$$

Rule of pulling out Z marker In order to analyze constraints from fermionic generators, we need to impose *by hand* a rule of pulling out Z markers from the closed-string state. Roughly speaking this determines how an insertion and a removal of Z field change the one-point function, and it is therefore related to the expectation value of the scalar field. For now, we simply assume the following rule

$$\langle \mathcal{D}|Z\mathcal{X}\rangle = \frac{x_s}{r}\langle \mathcal{D}|\mathcal{X}\rangle,\tag{4.24}$$

without specifying the value of $x_s(=x(is))$. Note that we multiplied a factor $1/r$ to account for the mass dimension of Z .

The value of x_s has a clear physical meaning both in the gauge theory and string theory. On the gauge-theory side, it can be interpreted as an expectation value of the Z field in the classical background sourced by the interface defect. On the string-theory side, it is a parameter which distinguishes different boundary states and is related to a momentum carried by the boundary state as we discuss in more detail in section 4.6. There we also show that one can change the value of x_s by considering a bound state of the boundary state and a bulk particle. This feature turns out to be essential in order to reproduce the results obtained at weak coupling [39].

Constraints from fermionic symmetry Next we study constraints from the fermionic symmetry. The fermionic symmetry exchanges bosons and fermions in the dynamic spin chain and thereby allows us to determine k_+ and k_- in (4.23).

Let us first consider the state $|\phi^a(u)\psi^\alpha(\bar{u})\rangle$. The action of \mathcal{S} reads

$$\begin{aligned} \mathcal{S}_\beta^b |\phi^a(u)\psi^\alpha(\bar{u})\rangle &= c\epsilon^{ba}\epsilon_{\beta\gamma} |Z^- \psi^\gamma(u)\psi^\alpha(\bar{u})\rangle + \bar{d}\delta_\beta^\alpha |\phi^a(u)\phi^b(\bar{u})\rangle \\ &\quad + iar\epsilon_{\beta\gamma}\sigma^{bc}\delta_c^a |\psi^\gamma(u)\psi^\alpha(\bar{u})\rangle + i\bar{b}r\epsilon_{\beta\gamma}\sigma^{bc}\epsilon^{\gamma\alpha}\epsilon_{cd} |\phi^a(u)Z\phi^d(\bar{u})\rangle, \\ &= r\epsilon^{ba}\epsilon_{\beta\gamma} \left(\frac{c}{x_s} + ias^b\right) |\psi^\gamma(u)\psi^\alpha(\bar{u})\rangle + \delta_\beta^\alpha \left(\bar{d} + ix_s\bar{b}s^b\frac{x^+}{x^-}\right) |\phi^a(u)\phi^b(\bar{u})\rangle, \end{aligned} \quad (4.25)$$

where $\bar{\mathbf{b}}$ and $\bar{\mathbf{d}}$ are given by $\mathbf{b}(\bar{u})$ and $\mathbf{d}(\bar{u})$, and s^b is defined by $s^1 = -s^2 = 1$. Note that here we have already used the rule (4.24) to pull out Z markers.

By contracting the state against the boundary state $\langle \mathfrak{d} |$, we obtain

$$\begin{aligned} 0 &= \langle \mathfrak{d} | \mathcal{S}_\beta^b |\phi^a(u)\psi^\alpha(\bar{u})\rangle \\ \iff &\begin{cases} 0 = r\delta_\beta^\alpha \left(\frac{c}{x_s} + ia\right) + \delta_\beta^\alpha \left(\bar{d} + ix_s\bar{b}\frac{x^+}{x^-}\right) k_-(u) & (a=2, b=1), \\ 0 = -r\delta_\beta^\alpha \left(\frac{c}{x_s} - ia\right) + \delta_\beta^\alpha \left(\bar{d} - ix_s\bar{b}\frac{x^+}{x^-}\right) k_+(u) & (a=1, b=2). \end{cases} \end{aligned} \quad (4.26)$$

Solving these equations, we get

$$k_+(u) = -ir \frac{1 - \frac{1}{x^+x_s}}{1 + \frac{x_s}{x^-}}, \quad k_-(u) = -ir \frac{1 + \frac{1}{x^+x_s}}{1 - \frac{x_s}{x^-}}. \quad (4.27)$$

This determines the two-particle overlaps (4.20) up to an overall factor $F_0(u)$.

4.4 Constraining the scalar factor

Having determined the matrix structure of the two-particle overlap, we next determine $F_0(u)$ by imposing a set of consistency conditions: Watson's equation and the crossing symmetry. We also check that our solution satisfies the boundary Yang-Baxter equations.

String frame and redefinition of the overall factor To impose these constraints, it is more convenient to change the definition of the bosonic excitation in the dynamic spin chain as

$$\phi_{\text{new}} = Z^{1/4} \phi_{\text{old}} Z^{1/4}. \quad (4.28)$$

The excitations defined in this way are called *string-frame* excitations [75] while the original ones are called *spin-chain frame* excitations. The spin-chain frame is more convenient for the comparison with the gauge theory while the string-frame is more natural for the analysis of the dual string worldsheet. After this change, the two-particle overlap of two scalar gets modified as follows:

$$\begin{aligned} \langle \mathfrak{d} | \phi^a(u) \phi^b(\bar{u}) \rangle \Big|_{\text{string}} &= \langle \mathfrak{d} | Z^{1/4} \phi^a(u) Z^{1/2} \phi^b(\bar{u}) Z^{1/4} \rangle \Big|_{\text{spin}} , \\ &= \frac{x_s}{r} \sqrt{\frac{x^+}{x^-}} \langle \mathfrak{d} | \phi^a(u) \phi^b(\bar{u}) \rangle \Big|_{\text{spin}} . \end{aligned} \quad (4.29)$$

For later purposes, we rescale the overall factor (from F_0 to F) and write the two-particle overlaps in the string frame as follows²⁶:

$$\begin{aligned} \langle \mathcal{D} | \mathcal{X}^{A\dot{A}}(u) \mathcal{X}^{B\dot{B}}(\bar{u}) \rangle &= F(u) \times \langle \mathfrak{d} | \chi^A(u) \chi^B(\bar{u}) \rangle \times \langle \mathfrak{d} | \chi^{\dot{A}}(u) \chi^{\dot{B}}(\bar{u}) \rangle , \\ \langle \mathfrak{d} | \psi^\alpha(u) \psi^\beta(\bar{u}) \rangle &= \frac{x_s^2 - (x^-)^2}{x^-(x^+ + x^-)} \epsilon^{\alpha\beta} , \\ \langle \mathfrak{d} | \phi^1(u) \phi^2(\bar{u}) \rangle &= -ix_s \frac{x_s^2 - (x^-)^2}{x^-(x^+ + x^-)} \sqrt{\frac{x^+}{x^-} \frac{1 - \frac{1}{x^+ x_s}}{1 + \frac{x_s}{x^-}}} , \\ \langle \mathfrak{d} | \phi^2(u) \phi^1(\bar{u}) \rangle &= -ix_s \frac{x_s^2 - (x^-)^2}{x^-(x^+ + x^-)} \sqrt{\frac{x^+}{x^-} \frac{1 + \frac{1}{x^+ x_s}}{1 - \frac{x_s}{x^-}}} . \end{aligned} \quad (4.30)$$

Watson's equation The first consistency condition is Watson's equation, which states that one needs to multiply the S-matrix in order to reorder excitations, see Figure 5a. Written explicitly, it says

$$\langle \mathcal{D} | \mathbb{S} | \mathcal{X}_1 \mathcal{X}_2 \rangle = \langle \mathcal{D} | \mathcal{X}_1 \mathcal{X}_2 \rangle . \quad (4.31)$$

Note that this is a matrix-valued equation and therefore is an over-constrained system for a single scalar factor $F(u)$. Remarkably we found that it reduces to a single constraint on F ,

$$\frac{F(u)}{F(\bar{u})} = S_0(u, \bar{u}) , \quad (4.32)$$

²⁶After this paper came out on arXiv, the paper [87] appeared in which they studied the matrix structures of two-particle overlaps corresponding to integrable boundary states in the dynamic $\mathfrak{psu}(2|2)$ spin chain, and obtained a result which seems consistent with (4.30).

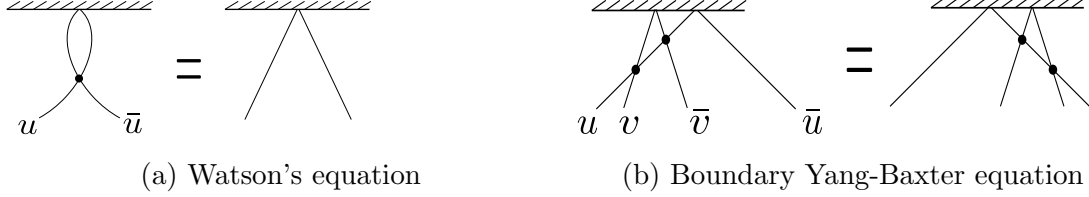

Figure 5: The Watson's equation and boundary Yang-Baxter equations. Here u , v , \bar{u} and \bar{v} are rapidities of excitations and their parity conjugates. The black dots in the figures denote the S-matrix of the excitations.

where S_0 is the overall scalar factor for the bulk S-matrix, given by

$$S_0(u_1, u_2) = \frac{x_1^+ - x_2^-}{x_1^- - x_2^+} \frac{1 - 1/x_1^- x_2^+}{1 - 1/x_1^+ x_2^-} \frac{1}{\sigma^2(u_1, u_2)}, \quad (4.33)$$

where $x_{1,2} \equiv x(u_{1,2})$ and $\sigma(u_1, u_2)$ is the dressing phase determined in [88]. The equation can be solved by the following ansatz,

$$F(u) = \frac{(x^+ + x^-)^3}{2(x_s - x^+)(x_s + x^-)(1 - 1/(x_s x^+))(1 + 1/(x_s x^-))} \frac{1 + 1/(x^-)^2 \sigma_B(u)}{x^- + 1/x^+ \sigma(u, \bar{u})}, \quad (4.34)$$

where $\sigma_B(u)$ is an undetermined prefactor which we call the *boundary dressing phase*. At this point, σ_B can be arbitrary as long as it satisfies

$$\sigma_B(u) = \sigma_B(\bar{u}). \quad (4.35)$$

Boundary Yang-Baxter equation We next consider the boundary Yang-Baxter equations as depicted in Figure 5b:

$$\langle \mathcal{D} | \mathbb{S}_{24} \mathbb{S}_{34} | \mathcal{X}_1(u) \mathcal{X}_2(v) \mathcal{X}_3(\bar{v}) \mathcal{X}_4(\bar{u}) \rangle = \langle \mathcal{D} | \mathbb{S}_{13} \mathbb{S}_{24} | \mathcal{X}_1(u) \mathcal{X}_2(v) \mathcal{X}_3(\bar{v}) \mathcal{X}_4(\bar{u}) \rangle. \quad (4.36)$$

Here \mathbb{S}_{ij} is the S-matrix between \mathcal{X}_i and \mathcal{X}_j . Checking these equations is a straightforward yet tedious task. We verified that these equations are satisfied by the solution (4.27), regardless of the values of $F(u)$ and x_s . This provides further support for our assumption that the boundary state $|\mathcal{D}\rangle$ is an integrable boundary state.

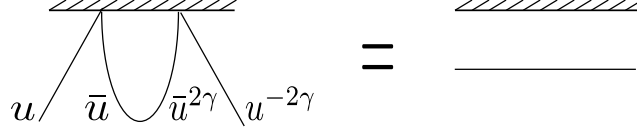

Figure 6: The crossing equation for the two-particle overlap. It requires that the overlap for the singlet states (shown in the figure) is trivial. In general, to write down the crossing equation, one needs to sum over all possible states that form a single pair $\mathcal{X}(\bar{u})$ and $\mathcal{X}(\bar{u}^{2\gamma})$. (This is why the middle two particles in the figure are connected by the curve.) In the case at hand, by judiciously choosing the external states, it reduces to a simple constraint given in (4.37).

Crossing equation The third constraint is the crossing equation, which requires the overlap to be trivial when excitations form a singlet state of the centrally-extended $\mathfrak{psu}(2|2)^2$ symmetry. The singlet state has the same quantum numbers as the vacuum state of the dynamic spin chain and can be pair-created from the vacuum. Therefore imposing the crossing equation is physically equivalent to requiring the overlap to be invariant under the vacuum fluctuations. For more detailed discussions, see sections 6 and 7 of [2] (and also [76]). In our case, it boils down to the following relation (see also Figure 6):

$$\langle \mathcal{D} | D^{1\dot{1}}(u) D^{2\dot{2}}(\bar{u}) D^{1\dot{1}}(\bar{u}^{2\gamma}) D^{2\dot{2}}(u^{-2\gamma}) \rangle = 1. \quad (4.37)$$

To compute the left hand side, one has to analyze the four-particle form overlap. Here we use the assumption that the system is described by an integrable boundary state and factorize the four-particle overlap into a product of two-particle overlaps. Under this assumption, (4.37) becomes

$$\underbrace{\left[F(u) \left(\frac{x_s^2 - (x^-)^2}{x^-(x^+ + x^-)} \right)^2 \right]}_{D^{1\dot{1}}(u) D^{2\dot{2}}(\bar{u})} \underbrace{\left[F(\bar{u}^{2\gamma}) \left(\frac{x^-(1 - x_s^2(x^+)^2)}{(x^+ + x^-)} \right)^2 \right]}_{D^{1\dot{1}}(\bar{u}^{2\gamma}) D^{2\dot{2}}(u^{-2\gamma})} = 1. \quad (4.38)$$

Substituting the expression (4.34) and using the identity²⁷

$$\frac{1}{\sigma(u, \bar{u})\sigma(\bar{u}^{2\gamma}, u^{-2\gamma})} = \frac{4(x^-)^4}{(x^+ + 1/x^+)(x^- + 1/x^-)} \left(\frac{1 + \frac{1}{x^+x^-}}{x^+ + x^-} \right)^2, \quad (4.40)$$

we can rewrite the crossing equation as follows:

$$\sigma_B(u)\sigma_B(\bar{u}^{2\gamma}) = \frac{1}{x_s^4} \frac{(x^+ - x_s)^2(x^- + 1/x_s)^2}{(x^+ + 1/x_s)^2(x^- - x_s)^2}. \quad (4.41)$$

This can be further rewritten using $\sigma_B(\bar{u}) = \sigma_B(u)$ as

$$\sigma_B(u)\sigma_B(u^{2\gamma}) = \frac{1}{x_s^4} \frac{(x^+ - 1/x_s)^2(x^- + x_s)^2}{(x^+ + x_s)^2(x^- - 1/x_s)^2}. \quad (4.42)$$

4.5 Solving the crossing equation

We now solve the functional equation (4.42) by applying standard procedures explained in the review [89].

Minimal solution We first perform the mirror transformation and rewrite (4.42) as

$$\sigma_B(u^{-\gamma})\sigma_B(u^\gamma) = \frac{(x^+ - 1/x_s)^2(x^- + 1/x_s)^2}{(x^+ + x_s)^2(x^- - x_s)^2}. \quad (4.43)$$

We then consider the following ansatz (to be called the minimal solution)

$$\sigma_B^{\min}(u) = \frac{G(x^-, x_s)G(x^+, -1/x_s)}{G(x^+, x_s)G(x^-, -1/x_s)}, \quad (4.44)$$

and write (4.43) as

$$\frac{(G(x, -1/x_s)G(1/x, -1/x_s))^{D-D-1}}{(G(x, x_s)G(1/x, x_s))^{D-D-1}} = \frac{(x - 1/x_s)^{2D}(x + 1/x_s)^{2D-1}}{(x + x_s)^{2D}(x - x_s)^{2D-1}}, \quad (4.45)$$

²⁷This relation can be derived from the crossing equation for the dressing phase $\sigma(u, v)$:

$$\sigma(u_1, u_2)\sigma(u_1^{2\gamma}, u_2) = \frac{(1 - 1/x_1^+x_2^+)(1 - x_1^-/x_2^+)}{(1 - 1/x_1^+x_2^-)(1 - x_1^-/x_2^-)}. \quad (4.39)$$

For details of the derivation, see Appendix G of [2].

where D is the shift operator $D \equiv \frac{i}{2} \partial_u$. Solutions to this equation can be obtained by dealing with a simpler equation,

$$G(x, y)G(1/x, y) = \left(\frac{x - \frac{1}{y}}{\sqrt{x}} \right)^{\frac{-2D}{D-D^{-1}}} \left(\frac{x + \frac{1}{y}}{\sqrt{x}} \right)^{\frac{-2D^{-1}}{D-D^{-1}}}, \quad (4.46)$$

which implies

$$\begin{aligned} G(x, y)G(1/x, y)G(x, 1/y)G(1/x, 1/y) &= (u - v)^{\frac{-2D}{D-D^{-1}}} (u + v)^{\frac{-2D^{-1}}{D-D^{-1}}} \\ &= \left(\frac{\Gamma[1 + i(u + v)]}{\Gamma[1 - i(u - v)]} \right)^2, \end{aligned} \quad (4.47)$$

with $v \equiv g(y + 1/y)$ (or equivalently $y = x(v)$). In the second equality of (4.47), we have used a series-expansions of the exponents

$$\begin{aligned} \frac{-2D}{D - D^{-1}} &= \frac{2D^2}{1 - D^2} = 2 \sum_{n=1}^{\infty} D^{2n}, \\ \frac{-2D^{-1}}{D - D^{-1}} &= -\frac{2D^{-2}}{1 - D^{-2}} = -2 \sum_{n=1}^{\infty} D^{-2n}. \end{aligned} \quad (4.48)$$

The functional equation (4.47) can be solved by applying standard techniques of the Riemann-Hilbert problem (see e.g. [89]). The result reads

$$\frac{1}{i} \log G(x, y) = \frac{2}{i} \oint_{|z|=1} \frac{dz}{2\pi i} \oint_{|w|=1} \frac{dw}{2\pi i} \frac{1}{x - z} \frac{1}{y - w} \log \mathfrak{G}(z, w), \quad (4.49)$$

with

$$\mathfrak{G}(z, w) = \frac{\Gamma[1 + ig(z + \frac{1}{z} + w + \frac{1}{w})]}{\Gamma[1 - ig(z + \frac{1}{z} - w - \frac{1}{w})]}. \quad (4.50)$$

The solution (4.49) is valid for $|x| > 1$ and $|y| > 1$, and the result for other parameter regions can be obtained by analytic continuation.

CDD ambiguity Using the minimal solution $\sigma^{\min}(u)$, we can construct infinitely many solutions to the crossing equation by multiplying a factor $\sigma_{\text{CDD}}(u)$ which satisfies

$$\sigma_{\text{CDD}}(u) = \sigma_{\text{CDD}}(\bar{u}), \quad \sigma_{\text{CDD}}(u)\sigma_{\text{CDD}}(u^{2\gamma}) = 1. \quad (4.51)$$

This is an analogue of the Castillejo-Dalitz-Dyson (CDD) ambiguity [90] for the bulk S-matrix. In particular, for any odd function of the magnon energy $f_{\text{odd}}(E)$, one can verify that $\sigma_{\text{CDD}}(u) = e^{f_{\text{odd}}(E)}$ satisfies the relations (4.51).

As we see later, the choice that reproduces the weak-coupling results in the literature turns out to be $\sigma_{\text{CDD}}(u) = 2^{-4E(u)}$. Thus our proposal for the solution to the crossing equation relevant for the D5-brane interface is

$$\sigma_B(u) = 2^{-4E(u)} \frac{G(x^-, x_s) G(x^+, -1/x_s)}{G(x^+, x_s) G(x^-, -1/x_s)}. \quad (4.52)$$

Let us now make one remark: The same CDD factor appeared in the analysis of structure constants of determinant operators in [2, 3], and it was interpreted²⁸ as an extra spacetime dependence associated to a conformal transformation which maps the symmetric configuration (in which operators are at $-1, 0$ and 1 along a line) to the canonical configuration (in which operators are at $0, 1$ and ∞). A similar argument holds also for the defect one-point function. Normally we consider a planar defect and define the structure constant $C_{\mathcal{O}}$ by

$$\langle \mathcal{O} \rangle_{\mathcal{D}} = \frac{C_{\mathcal{O}}}{x_{\perp}^{\Delta}}, \quad (4.53)$$

where x_{\perp} is the distance between the defect and the operator. However, to apply integrability, it is more convenient to use a spherical defect with a unit radius and define the structure constant (to be denoted by $C_{\mathcal{O}}^{\text{sphere}}$) as the one-point function in that configuration. Analyzing the conformal (and the R -symmetry) transformations which map the two configurations, we find that the relation between the two structure constants is given by²⁹

$$C_{\mathcal{O}} = 2^{-(\Delta-J)} C_{\mathcal{O}}^{\text{sphere}}. \quad (4.54)$$

The factor $2^{-(\Delta-J)}$ is precisely the origin of the CDD factor in (4.52). In other words, if we define the structure constant using the spherical defect, we would not need the CDD factor.

Weak coupling expansions We now expand the boundary dressing phase σ_B at weak coupling in order to perform a comparison with the literature. To do so we assume that the

²⁸See section 7.5 of [2].

²⁹Here we have been suppressing the dependence on the R -symmetry polarizations. To reproduce the factor $2^{-(\Delta-J)}$ in (4.54), we also need to keep track of the R -symmetry polarizations. See [2] for details.

absolute value of x_s is larger than 1: $|x_s| > 1$. The assumption is justified eventually by the match with the weak-coupling results in the literature.

Since σ_B is given by (4.52), we need expansions of both $G(x, y)$ and $G(x, 1/y)$ with $|x| > 1$ and $|y| > 1$. Let us first discuss the expansion of $G(x, y)$. This can be done by expanding (4.49) in a power series of $1/x$ and $1/y$ as

$$\frac{\log G(x, y)}{i} = \sum_{r,s=1}^{\infty} \frac{c_{r,s}}{x^r y^s}, \quad (4.55)$$

with

$$c_{r,s} \equiv \frac{2}{i} \oint_{|z|=1} \frac{dz z^{r-1}}{2\pi i} \oint_{|w|=1} \frac{dw w^{s-1}}{2\pi i} \log \mathfrak{G}(z, w). \quad (4.56)$$

We then use the integral representation of $\log \Gamma$,

$$\log \Gamma(z) = \int_0^{\infty} \frac{dt}{t} e^{-t} \left(z - 1 - \frac{1 - e^{-t(z-1)}}{1 - e^{-t}} \right), \quad (4.57)$$

and rewrite (4.56) as

$$c_{r,s} = \frac{2}{i} \int_0^{\infty} \frac{dt}{t} \oint_{|z|=1} \frac{dz z^{r-1}}{2\pi i} \oint_{|w|=1} \frac{dw w^{s-1}}{2\pi i} \frac{e^{-igt(z+\frac{1}{z}+w+\frac{1}{w})} - e^{igt(z+\frac{1}{z}-w-\frac{1}{w})}}{e^t - 1}. \quad (4.58)$$

To proceed we expand the integrand using

$$e^{ia(b+\frac{1}{b})} = \sum_{k=-\infty}^{\infty} i^k b^k J_k(2a), \quad (4.59)$$

and perform the integrals of z and w . As a result we obtain

$$c_{r,s} = \frac{2(1 - (-1)^r)}{i^{r+s+1}} \int_0^{\infty} dt \frac{J_r(2gt) J_s(2gt)}{t(e^t - 1)}, \quad (4.60)$$

where J 's are the Bessel functions. Expanding the integrand in powers of g and performing the integral, we get

$$c_{r,s} = \sum_{n=0}^{\infty} g^{r+s+2n} c_{r,s}^{(n)}, \quad (4.61)$$

where

$$c_{r,s}^{(n)} = 2(-1)^n \frac{(1 - (-1)^r)}{i^{r+s+1}} \frac{(2n+r+s-1)!(2n+r+s)!}{n!(n+r)!(n+s)!(n+r+s)!} \zeta_{2n+r+s}, \quad (4.62)$$

with ζ_n being the zeta function. From (4.55) and (4.61), one can show $G(x, y) = 1 + \mathcal{O}(g^4)$

at weak coupling.

We next consider $G(x, 1/y)$. Since the magnitude of the second argument is less than 1 ($|1/y| < 1$), one has to analytically continue the integral representation (4.49). Upon doing so, the integral picks up a contribution from a pole at $w = 1/y$. As a result we have

$$\frac{1}{i} \log G(x, 1/y) = \chi_{\text{int}}(x, y) + \chi_{\text{pole}}(x, y), \quad (4.63)$$

with

$$\begin{aligned} \chi_{\text{int}}(x, y) &\equiv \frac{2}{i} \oint_{|z|=1} \frac{dz}{2\pi i} \oint_{|w|=1} \frac{dw}{2\pi i} \frac{1}{x-z} \frac{1}{\frac{1}{y}-w} \log \mathfrak{G}(z, w), \\ \chi_{\text{pole}}(x, y) &\equiv \frac{2}{i} \oint_{|z|=1} \frac{dz}{2\pi i} \frac{1}{x-z} \log \mathfrak{G}(z, y). \end{aligned} \quad (4.64)$$

By rewriting the integrand, we can further decompose χ_{int} into two terms

$$\chi_{\text{int}}(x, y) = -\frac{1}{i} \log G(x, y) - \bar{\chi}_{\text{int}}(x), \quad (4.65)$$

with

$$\bar{\chi}_{\text{int}}(x) \equiv \frac{2}{i} \oint_{|z|=1} \frac{dz}{2\pi i} \oint_{|w|=1} \frac{dw}{2\pi i} \frac{1}{x-z} \frac{1}{w} \log \mathfrak{G}(z, w). \quad (4.66)$$

As we already know the expansion of $G(x, y)$, the remaining tasks are to expand χ_{pole} and $\bar{\chi}_{\text{int}}$. Using the integral representation of $\log \Gamma$ (4.57), we get

$$\chi_{\text{pole}}(x, y) = \sum_{r=1}^{\infty} \frac{d_r}{x^r}, \quad \bar{\chi}_{\text{int}}(x) = \sum_{r=1}^{\infty} \frac{e_r}{x^r}, \quad (4.67)$$

where d_k and e_k are given by

$$\begin{aligned} d_r &= 4g\delta_{r,1} \int_0^{\infty} dt \frac{e^{-t}}{t} + \frac{2(1 - (-1)^r)}{i^{r+1}} \int_0^{\infty} dt \frac{e^{-itv} J_r(2gt)}{t(e^t - 1)}, \\ e_r &= 4g\delta_{r,1} \int_0^{\infty} dt \frac{e^{-t}}{t} + \frac{2(1 - (-1)^r)}{i^{r+1}} \int_0^{\infty} dt \frac{J_r(2gt) J_0(2gt)}{t(e^t - 1)}, \end{aligned} \quad (4.68)$$

where v is the rapidity for y , $v = g(y + 1/y)$. Expanding these integrals in powers of g , we get

$$d_r = \sum_{n=0}^{\infty} g^{r+2n} d_r^{(n)}, \quad e_r = \sum_{n=0}^{\infty} g^{r+2n} e_r^{(n)}, \quad (4.69)$$

with

$$\begin{aligned}
d_r^{(n)} &= \frac{2(1 - (-1)^r)(-1)^{n+1}}{n!(n+r)!i^{r+1}} \Psi^{(2n+r-1)}(1+iv), \\
e_r^{(n)} &= \begin{cases} -4\gamma_E & (r=1, n=0), \\ 2(-1)^n \frac{(1-(-1)^r)}{i^{r+1}} \frac{(2n+r-1)!(2n+r)!}{(n!(n+r)!)^2} \zeta_{2n+r} & (\text{others}). \end{cases} \quad (4.70)
\end{aligned}$$

Here $\Psi^{(n)}$ is the n -th derivative of the Euler digamma function and γ_E is the Euler-Mascheroni constant. Therefore $\log G(x, 1/y)$ can be expanded up to one loop as

$$\frac{1}{i} \log G(x, 1/y) = \frac{4g^2}{u} (\Psi(1+iv) + \gamma_E) + \mathcal{O}(g^4). \quad (4.71)$$

Putting together everything, we get the following expansion of the boundary dressing phase:

$$\sigma_B(u) = \frac{1}{4} \left[1 + \frac{4g^2}{u^2 + \frac{1}{4}} (\Psi(1+s) + \gamma_E - \log 2) + \mathcal{O}(g^4) \right]. \quad (4.72)$$

Already at this stage, it is worth pointing out that the one-loop result in (4.72) takes the same form as the “flux factor” in [39] if we set $s = (k-1)/2$. In the following subsections, we make this heuristic observation into a more concrete statement and show that our results are indeed in agreement with [39].

4.6 Excited boundary states and comparison with perturbation theory

Having solved the crossing equation, we now make a comparison with the results from perturbation theory. We focus on the so-called $SU(2)$ sector (see below), for which the one-loop results are available [33, 34, 39]. We leave the comparison in other sectors to a future work.

Two-particle overlap in $SU(2)$ sector In $\mathcal{N} = 4$ SYM, we can define subsectors of operators in which the action of the dilatation operator is closed at all orders in perturbation theory. The simplest subsector is the so-called $SU(2)$ sector, which consists of operators made out of two complex scalars. In order to make contact with [33, 34, 39], we choose the two

scalars to be Z and $\tilde{\Phi}$ with³⁰

$$\tilde{\Phi} \equiv \frac{\Phi^{1\dot{1}} + \Phi^{2\dot{2}} + \Phi^{1\dot{2}} + \Phi^{2\dot{1}}}{2}. \quad (4.73)$$

Then the two-particle overlap in this sector, $f_{SU(2)}(u) \equiv \langle \mathcal{D} | \tilde{\Phi}(u) \tilde{\Phi}(\bar{u}) \rangle$, is given by

$$\begin{aligned} f_{SU(2)}(u) &= \frac{F(u)}{4} (\langle \mathfrak{d} | \phi^1 \phi^2 \rangle + \langle \mathfrak{d} | \phi^2 \phi^1 \rangle)^2 \\ &= x_s^2 \frac{u(u - \frac{i}{2})}{(u - i(s - \frac{1}{2}))(u + i(s - \frac{1}{2}))} \frac{x^+ \sigma_B(u)}{x^- \sigma(u, \bar{u})}. \end{aligned} \quad (4.74)$$

Expanding it at weak coupling, we obtain the following expression for $\sqrt{f_{SU(2)}(u)f_{SU(2)}(\bar{u})}$:

$$\begin{aligned} \sqrt{f_{SU(2)}(u)f_{SU(2)}(\bar{u})} &= \\ &= \frac{x_s^2 \sqrt{u^2(u^2 + \frac{1}{4})}}{4 \left(u^2 + (s - \frac{1}{2})^2\right)} \left[1 + \frac{4g^2}{u^2 + \frac{1}{4}} (\Psi(1 + s) + \gamma_E - \log 2) + \mathcal{O}(g^4) \right]. \end{aligned} \quad (4.75)$$

Asymptotic overlap With the two-particle overlap at hand, we can write down the asymptotic overlap formula which includes all the perturbative $1/J$ corrections. The asymptotic formula is expected to be exact up to three loops since the correction to the asymptotic formula (called the wrapping corrections) is known to appear only at four loops.

To rigorously derive the asymptotic formula, one has to go through steps 3 and 4 in Section 4.1: Namely we first formulate the TBA, compute the excited-state g -function and finally take the asymptotic limit $J \rightarrow \infty$. Such an analysis was done for the structure constants of determinant operators in [2, 3]. It was then found that the result is given purely in terms of the two-particle overlaps and the Gaudin determinants, and has the same universal structure as the results at weak coupling. Here we *assume* that this is the case also for the defect one-point function. Then the asymptotic overlap formula in the $SU(2)$ sector is given by

$$\frac{\langle \mathcal{D} | \mathbf{u} \rangle}{\sqrt{\langle \mathbf{u} | \mathbf{u} \rangle}} \Big|_{\text{asym}} = (x_s)^J \sqrt{\left(\prod_{m=1}^{M/2} f_{SU(2)}(u_m) f_{SU(2)}(\bar{u}_m) \right) \frac{\det G_+}{\det G_-}}, \quad (4.76)$$

³⁰Normally we simply choose Z and $\Phi^{1\dot{1}}$ to define the $SU(2)$ sector. However, the one-point functions in that sector vanish owing to the matrix structure of the overlap (4.30), and they do not correspond to the setup discussed in [33, 34, 39]. This is the reason why we have chosen a particular linear combination given in (4.73).

where $|\mathbf{u}\rangle$ is a parity-symmetric Bethe eigenstate with rapidities $\mathbf{u} = \{u_1, \bar{u}_1, \dots, u_{\frac{M}{2}}, \bar{u}_{\frac{M}{2}}\}$, and $\det G_{\pm}$ are the Gaudin(-like) determinants whose definitions can be found in e.g. [2, 3, 39]. The prefactor x_s^J comes from the rule for pulling out Z fields (4.24) and is a counterpart of i^J in (1.13) of [2]. We will later give a more physical interpretation of this factor.

Now to perform a comparison with [39], we set $s = (k-1)/2$ and expand (4.76) at weak coupling. This gives

$$\frac{\langle \mathcal{D} | \mathbf{u} \rangle}{\sqrt{\langle \mathbf{u} | \mathbf{u} \rangle}} \Big|_{\text{asym}} = \frac{\left(x_{\frac{k-1}{2}}\right)^L}{2^M} \left[\frac{\sqrt{Q(\frac{i}{2})Q(0)}}{Q(\frac{i(k-2)}{2})} \sqrt{\frac{\det G_+}{\det G_-}} \mathbb{F}_k + \mathcal{O}(g^4) \right], \quad (4.77)$$

where $Q(u)$ is the Baxter Q -function

$$Q(u) \equiv \prod_{m=1}^M (u - u_m) = \prod_{m=1}^{M/2} (u^2 - u_m^2), \quad (4.78)$$

and \mathbb{F}_k is the flux factor introduced in [39]

$$\mathbb{F}_k = 1 + \left(\Psi \left(\frac{k+1}{2} \right) + \gamma_E - \log 2 \right) \delta \Delta, \quad (4.79)$$

with $\delta \Delta \equiv \sum_{m=1}^M \frac{2g^2}{u_m^2 + \frac{1}{4}}$. The result (4.77) resembles but does not quite agree with the perturbative answer in [39]. The main difference is that, while (4.77) is given by a single term, the result in [39] is a sum of k different terms. In what follows, we show that this mismatch can be resolved once we take into account the contributions from excited boundary states.

Excited boundary state The two-particle overlap $f_{SU(2)}(u)$ given in (4.74) has poles at $u = \pm i(s - \frac{1}{2})$. As explained in [76], such poles correspond to physical processes in which a particle gets absorbed by the boundary and changes it to an *excited boundary state*³¹, see Figure 7. This is a boundary scattering version of the relation between poles in the S-matrix and bound states.

Excited boundary states can be thought of as bound states of particles and the boundary, and much like usual bound states of particles, we need to include their contributions in order to obtain the correct answer. In integrable field theories, the two-particle overlaps for excited

³¹In the boundary scattering picture, this is often called the boundary bound state [76]. Such boundary bound states also play an important role in the analysis of the spectrum on the so-called $Z = 0$ brane in [91].

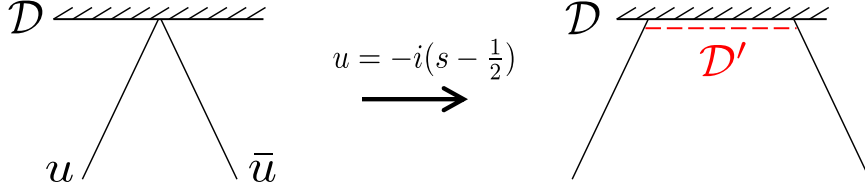

Figure 7: Poles of the two-particle overlap and excited boundary states. A pole of the two-particle overlap corresponds to a physical process depicted above, in which a particle gets absorbed by the boundary state and modifies it to an excited boundary state (shown as a red dashed line). Using this property, one can compute the two-particle overlap for the excited boundary state by solving the bootstrap axiom given in Figure 8.

boundary states can be determined from the bootstrap axiom [76] which is depicted in Figure 8. In our case, we can work entirely within the $SU(2)$ sector and the bootstrap axiom gives

$$f'_{SU(2)}(u) = \tilde{S}(-i(s - \frac{1}{2}), u) \tilde{S}(-i(s - \frac{1}{2}), \bar{u}) f_{SU(2)}(u), \quad (4.80)$$

where $f'_{SU(2)}(u) \equiv \langle \mathcal{D}' | \tilde{\Phi}(u) \tilde{\Phi}(\bar{u}) \rangle$ is the two-particle overlap for the excited boundary state $|\mathcal{D}'\rangle$, and $\tilde{S}(u, v)$ is the S-matrix in the $SU(2)$ sector (in the string frame) given by [83, 84]

$$\tilde{S}(u, v) \equiv \frac{u - v - i x^+(u) x^-(v)}{u - v + i x^-(u) x^+(v)} \frac{1}{(\sigma(u, v))^2}. \quad (4.81)$$

We then get³²

$$f'_{SU(2)}(u) = x_{s-1}^2 \frac{x^+}{x^-} \frac{u(u - \frac{i}{2})(u - i(s + \frac{1}{2}))(u + i(s + \frac{1}{2}))}{(u - i(s - \frac{1}{2}))(u + i(s - \frac{1}{2}))(u - i(s - \frac{3}{2}))(u + i(s - \frac{3}{2}))} \times \frac{\sigma_B(u)}{\sigma(u, \bar{u}) (\sigma(u, i(s - \frac{1}{2})) \sigma(\bar{u}, i(s - \frac{1}{2})))^2}. \quad (4.82)$$

Let us make two remarks before moving on. First the simple relation (4.80) is valid only in the $SU(2)$ sector, in which the S-matrix and the two-particle overlaps are just scalar factors. In the full $\mathfrak{su}(2|2)^2$ spin chain, one has to consider a matrix analogue of (4.80), which is pictorially represented in Figure 8. As a result, the two-particle overlap for the excited boundary state will have a different matrix structure from the one for the original boundary state (4.30). Second there is another important difference between the original boundary state and the excited boundary state. In the asymptotic overlap formula for $|\mathcal{D}\rangle$ (4.76), we had an overall factor x_s^J . Physically this can be interpreted as a propagation factor $e^{i p_{\text{bdy}} J}$

³²Here we used the parity invariance of the dressing phase $\sigma(u, v) = \sigma(\bar{v}, \bar{u})$.

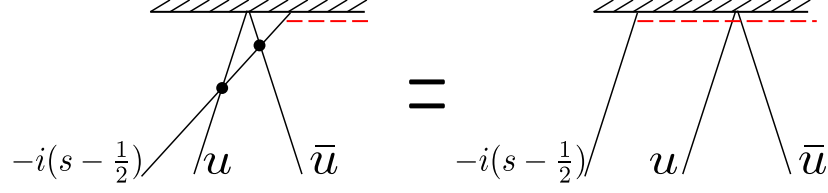

Figure 8: The bootstrap axiom for the overlap for the excited boundary state. The overlap for the excited boundary state (depicted on the right hand side) is given by a product of the bulk S-matrices (the black dots in the figure) and the overlap for the original boundary state, as shown on the left hand side of the figure.

with $e^{ip_{\text{bdy}}} \equiv x_s$ being the momentum carried by the boundary state $|\mathcal{D}\rangle$. Since the excited boundary state $|\mathcal{D}'\rangle$ is a bound state of $|\mathcal{D}\rangle$ and a particle with $u = -i(s - \frac{1}{2})$, the momentum of $|\mathcal{D}'\rangle$ is given by

$$e^{ip'_{\text{bdy}}} = e^{ip_{\text{bdy}}} \frac{x^+(-i(s - \frac{1}{2}))}{x^-(-i(s - \frac{1}{2}))} = x_{s-1}. \quad (4.83)$$

This is also consistent with (4.82) in which the overall factor x_s^2 is replaced by x_{s-1}^2 .

The excited-state overlap (4.82) have new poles at $u = \pm i(s - \frac{3}{2})$. Therefore, by using a particle with rapidity $-i(s - \frac{3}{2})$, we can further excite the boundary state. Setting $s = \frac{(k-1)}{2}$ and repeating this process until we do not get any new poles, we obtain k different excited boundary states, which we denote by

$$|\mathcal{D}_k^{(a)}\rangle, \quad (a = -\frac{k-1}{2}, \dots, \frac{k-1}{2}). \quad (4.84)$$

The two-particle overlaps of these states are given by

$$\tilde{f}_k^{(a)}(u) \equiv \langle \mathcal{D}_k^{(a)} | \tilde{\Phi}(u) \tilde{\Phi}(\bar{u}) \rangle = x_a^2 \frac{x^+}{x^-} \frac{u(u - \frac{i}{2})(u^2 + \frac{k^2}{4})}{(u^2 + \frac{(a-1)^2}{4})(u^2 + \frac{(a+1)^2}{4})} \frac{\sigma_B(u) \left(\tilde{\sigma}_k^{(a)}(u) \right)^2}{\sigma(u, \bar{u})}, \quad (4.85)$$

with

$$\tilde{\sigma}_k^{(a)}(u) \equiv \prod_{r=a}^{\frac{k-3}{2}} \frac{1}{\sigma(u, ir) \sigma(\bar{u}, ir)}. \quad (4.86)$$

We can also express $\tilde{\sigma}_k^{(a)}$ more explicitly as³³

$$\begin{aligned} \frac{\log \tilde{\sigma}_k^{(a)}(u)}{i} = & \chi(x^-, x_a) - \chi(x^+, x_a) - \chi(x^-, x_{\frac{(k-1)}{2}}) + \chi(x^+, x_{\frac{(k-1)}{2}}) \\ & + \chi(-x^+, x_a) - \chi(-x^-, x_a) - \chi(-x^+, x_{\frac{(k-1)}{2}}) + \chi(-x^-, x_{\frac{(k-1)}{2}}), \end{aligned} \quad (4.87)$$

where χ is given by (see e.g. [89, 92])

$$\chi(x, y) \equiv \frac{1}{i} \oint_{|z|=1} \frac{dz}{2\pi i} \oint_{|w|=1} \frac{dw}{2\pi i} \frac{1}{x-z} \frac{1}{y-w} \log \frac{\Gamma[1 + ig(z + \frac{1}{z} - w - \frac{1}{w})]}{\Gamma[1 - ig(z + \frac{1}{z} - w - \frac{1}{w})]}. \quad (4.88)$$

The asymptotic overlap for $|\mathcal{D}_k^{(a)}\rangle$ is simply given by replacing x_s and $f_{SU(2)}$ in (4.76) with x_a and $\tilde{f}_k^{(a)}$

$$\left. \frac{\langle \mathcal{D}_k^{(a)} | \mathbf{u} \rangle}{\sqrt{\langle \mathbf{u} | \mathbf{u} \rangle}} \right|_{\text{asym}} = (x_a)^J \sqrt{\left(\prod_{m=1}^{M/2} \tilde{f}_k^{(a)}(u_m) \tilde{f}_k^{(a)}(\bar{u}_m) \right) \frac{\det G_+}{\det G_-}}. \quad (4.89)$$

Full asymptotic result We now propose that the defect one-point function in the asymptotic limit is given by a sum of overlaps for the excited boundary states, namely

$$\langle \mathcal{O}_{\mathbf{u}}(x) \rangle_{\mathcal{D}_k} = \frac{c_{\mathbf{u}}^{(k)}}{2^J \sqrt{L} x_{\perp}^{\Delta}}, \quad (4.90)$$

with

$$c_{\mathbf{u}}^{(k)} \equiv \sum_{a=-\frac{k-1}{2}}^{\frac{k-1}{2}} \frac{\langle \mathcal{D}_k^{(a)} | \mathbf{u} \rangle}{\sqrt{\langle \mathbf{u} | \mathbf{u} \rangle}} = \mathbb{T}_k \frac{\sqrt{Q(\frac{i}{2})Q(0)}}{Q(\frac{ik}{2})} \sqrt{\left(\prod_{m=1}^M \sigma_B(u_m) \right) \frac{\det G_+}{\det G_-}}, \quad (4.91)$$

$$\mathbb{T}_k \equiv \sum_{a=-\frac{k-1}{2}}^{\frac{k-1}{2}} (x_a)^{J+M} \frac{(Q(\frac{ik}{2}))^2}{Q^-(ia)Q^+(ia)} \prod_{m=1}^M \tilde{\sigma}_k^{(a)}(u_m). \quad (4.92)$$

Let us make several comments on the formula. Firstly the overall factor $1/2^J$ in (4.90) is the kinematical factor associated to the R -symmetry polarization. For the comparison with the weak-coupling results in the literature, it is often convenient to combine it with the factor

³³Recall that x_s is given by $x(is)$.

$1/2^M$ in the boundary dressing phase $\sqrt{\prod_m \sigma_B(u_m)}$, and rewrite them as³⁴ $1/2^L$. Secondly $1/\sqrt{L}$ in (4.90) is the usual factor coming from the cyclicity of the trace. See for instance [93] for further explanation. Thirdly \mathbb{T}_k in (4.91) is a finite-coupling generalization of the transfer matrix of the Heisenberg spin chain found in the weak-coupling results [34, 39]. The main difference from [34, 39] is the factor $\prod_m \tilde{\sigma}_k^{(a)}(u_m)$ which starts to contribute at three loops.

Our proposal is in perfect agreement³⁵ with the results at tree level and one loop in the literature [33, 34, 39], providing strong evidence for the validity of our bootstrap analysis. It will be interesting to perform the higher-loop computation in perturbation theory and compare the results with our predictions.

5 Discussion and Conclusion

In this paper, we studied the half-BPS superconformal boundary and interface defects of the D5-brane type in the $\mathcal{N} = 4$ SYM with $U(N)$ gauge group. Defined by unconventional singular Nahm pole configurations of the SYM fields, such defects have only been explored to leading orders in perturbation theory. We presented non-perturbative approaches to this defect CFT problem based on supersymmetric localization and integrability methods.

Following the localization setup in [1], we have identified the effective 2d defect-Yang-Mills (dYM) theory that captures general $\frac{1}{16}$ -BPS defect observables in the $\mathcal{N} = 4$ SYM with the D5-brane type boundary or interface defect. In particular the dYM contains coupling to a 1d topological quantum mechanics (TQM) which we obtained from localizing the 3d mirror quiver gauge theory description of the Nahm pole boundary condition from [21]. Insertions of half-BPS operators \mathcal{O}_J in the SYM with the D5-brane defect translate to insertions of $\text{tr}(\star\mathcal{F})^J$ in the dYM where \mathcal{F} denotes the field strength of the emergent 2d gauge field. From standard two-dimensional gauge theory techniques, the latter reduces to a computation in a single matrix model with a novel matrix potential due to the D5-brane defect. Solving this matrix model in the large N limit, we obtained exact defect one-point functions $\langle \mathcal{O}_J \rangle_{\mathcal{D}}$ in the 't Hooft coupling λ . Our non-perturbative answers agree with perturbative Feynman diagram computations at weak coupling, and provides a precision test of AdS/CFT with interface defect by comparing with the string theory results on $AdS_5 \times S^5$ in the strong coupling regime. Going beyond defect observables protected by supersymmetry, we devel-

³⁴Note that J counts the number of Z while M counts the number of $\tilde{\Phi}$. Together they give the length of the operator $L = J + M$.

³⁵Precisely speaking the weak-coupling results contain an extra sign factor $(-1)^{L/2}$. (Note that L is even in order for the one-point function to be nonzero.) Keeping track of such an overall sign is practically difficult since the formula contains various square roots, but it would be interesting to clarify this point.

oped a non-perturbative bootstrap-type approach to determining the integrable boundary states in the planar $\mathcal{N} = 4$ SYM corresponding to interface defects, based on recently developed integrability methods of [2, 3]. The one-point function of a single-trace, generally non-BPS, local operator is then given by the overlap between the integrable boundary state and a closed string state corresponding to the local operator. We explicitly solved the consistency conditions that define the boundary state, namely the Watson’s equation, boundary Yang-Baxter equation and the crossing equations. By dressing the minimal solution with appropriate CDD factors, we obtained defect one-point functions of non-BPS operators (in the $SU(2)$ sector) in the asymptotic limit (large R-charge J) that are in perfect agreement with previous results from the traditional integrable spin-chain methods at one-loop.

There are a number of future directions worth exploring which we now discuss. First of all, the 2d dYM we have uncovered for the D5-brane defect captures more general observables of the SYM preserving a common supercharge beyond the local operators \mathcal{O}_J considered in the main text (see [1] for the general classification). For example they include correlation functions that involve genuine defect local operators in the TQM sector, as well as $\frac{1}{8}$ -BPS Wilson loops insertions [94, 95] that correspond to ordinary Wilson loops in the dYM.

It will be very interesting to complete the integrability program we have outlined in Section 4.1 by writing down the thermodynamic Bethe ansatz in the open string channel. This will enable us to reproduce the BPS defect one-point functions computed in this paper from the supersymmetric localization, and fully determine the non-BPS defect one-point functions at finite ’t Hooft coupling in the planar limit. Combined with the OPE of local operators in the bulk, this gives a way to extract general non-BPS correlation functions in the defect CFT. Furthermore, boundary (interface) defect crossing symmetry relates factorization channels of correlation functions that exchange bulk and defect local operators respectively [9–11, 96]. Therefore, by pursuing a defect superconformal bootstrap program, one can try to determine the full spectrum of operators confined to the defect worldvolume.

Another related direction is to classify the integrable boundary states in accordance with the general construction of interface defects from a chain of (p, q) 5-branes in IIB string theory [19]. In this paper, we have focused on the case with a single D5-brane and it is more desirable to have a general dictionary³⁶ between such 5-brane configurations and integrable boundary states. Perhaps a hint towards such a dictionary, these general 5-brane interfaces can be constructed by gluing together a number of the D5-brane interfaces (at various values of k)

³⁶For a certain class of operators living on the interface which can be described by closed spin chains, a similar question was addressed in [97]. It studied the action of the dilatation operator perturbatively at one loop, and concluded that the integrability is generally broken for such operators.

which we have studied, together with general $SL(2, \mathbb{Z})$ duality transformations. This gluing picture is succinctly represented by the matrix model expressions for the defect partition functions using supersymmetric localization (see Section 2.4). It would be interesting to understand the corresponding (de)construction of these boundary states on the integrability side.

Acknowledgement

We thank Charlotte Kristjansen and Matthias Wilhelm for discussions. The work of S.K. is supported by DOE grant number DE-SC0009988. The work of Y.W. is supported in part by the US NSF under Grant No. PHY-1620059 and by the Simons Foundation Grant No. 488653.

References

- [1] Y. Wang, *Taming Defects in $\mathcal{N} = 4$ Super-Yang-Mills*, [arXiv:2003.11016](#).
- [2] Y. Jiang, S. Komatsu, and E. Vescovi, *Structure Constants in $\mathcal{N} = 4$ SYM at Finite Coupling as Worldsheet g -Function*, [arXiv:1906.07733](#).
- [3] Y. Jiang, S. Komatsu, and E. Vescovi, *Exact Three-Point Functions of Determinant Operators in Planar $\mathcal{N} = 4$ Supersymmetric Yang-Mills Theory*, *Phys. Rev. Lett.* **123** (2019), no. 19 191601, [[arXiv:1907.11242](#)].
- [4] E. Witten, *Quantum Field Theory and the Jones Polynomial*, *Commun. Math. Phys.* **121** (1989) 351–399.
- [5] G. W. Moore and N. Seiberg, *Taming the Conformal Zoo*, *Phys. Lett.* **B220** (1989) 422–430.
- [6] S. Elitzur, G. W. Moore, A. Schwimmer, and N. Seiberg, *Remarks on the Canonical Quantization of the Chern-Simons-Witten Theory*, *Nucl. Phys.* **B326** (1989) 108–134.
- [7] C. G. Callan, Jr. and J. A. Harvey, *Anomalies and Fermion Zero Modes on Strings and Domain Walls*, *Nucl. Phys.* **B250** (1985) 427–436.
- [8] D. Poland, S. Rychkov, and A. Vichi, *The Conformal Bootstrap: Theory, Numerical Techniques, and Applications*, *Rev. Mod. Phys.* **91** (2019) 015002, [[arXiv:1805.04405](#)].

- [9] P. Liendo, L. Rastelli, and B. C. van Rees, *The Bootstrap Program for Boundary CFT_d*, *JHEP* **07** (2013) 113, [[arXiv:1210.4258](#)].
- [10] P. Liendo and C. Meneghelli, *Bootstrap equations for $\mathcal{N} = 4$ SYM with defects*, *JHEP* **01** (2017) 122, [[arXiv:1608.05126](#)].
- [11] M. Billo, V. Goncalves, E. Lauria, and M. Meineri, *Defects in conformal field theory*, *JHEP* **04** (2016) 091, [[arXiv:1601.02883](#)].
- [12] N. A. Nekrasov, *Seiberg-Witten prepotential from instanton counting*, *Adv. Theor. Math. Phys.* **7** (2003), no. 5 831–864, [[hep-th/0206161](#)].
- [13] V. Pestun, *Localization of gauge theory on a four-sphere and supersymmetric Wilson loops*, *Commun. Math. Phys.* **313** (2012) 71–129, [[arXiv:0712.2824](#)].
- [14] V. Pestun et al., *Localization techniques in quantum field theories*, *J. Phys.* **A50** (2017), no. 44 440301, [[arXiv:1608.02952](#)].
- [15] N. Beisert et al., *Review of AdS/CFT Integrability: An Overview*, *Lett. Math. Phys.* **99** (2012) 3–32, [[arXiv:1012.3982](#)].
- [16] J. M. Maldacena, *The Large N limit of superconformal field theories and supergravity*, *Int. J. Theor. Phys.* **38** (1999) 1113–1133, [[hep-th/9711200](#)]. [Adv. Theor. Math. Phys.2,231(1998)].
- [17] E. Witten, *Anti-de Sitter space and holography*, *Adv. Theor. Math. Phys.* **2** (1998) 253–291, [[hep-th/9802150](#)].
- [18] S. S. Gubser, I. R. Klebanov, and A. M. Polyakov, *Gauge theory correlators from noncritical string theory*, *Phys. Lett.* **B428** (1998) 105–114, [[hep-th/9802109](#)].
- [19] D. Gaiotto and E. Witten, *Supersymmetric Boundary Conditions in $N=4$ Super Yang-Mills Theory*, *J. Statist. Phys.* **135** (2009) 789–855, [[arXiv:0804.2902](#)].
- [20] D. Gaiotto and E. Witten, *Janus Configurations, Chern-Simons Couplings, And The theta-Angle in $N=4$ Super Yang-Mills Theory*, *JHEP* **06** (2010) 097, [[arXiv:0804.2907](#)].
- [21] D. Gaiotto and E. Witten, *S-Duality of Boundary Conditions In $N=4$ Super Yang-Mills Theory*, *Adv. Theor. Math. Phys.* **13** (2009), no. 3 721–896, [[arXiv:0807.3720](#)].

- [22] L. Di Pietro, D. Gaiotto, E. Lauria, and J. Wu, *3d Abelian Gauge Theories at the Boundary*, *JHEP* **05** (2019) 091, [[arXiv:1902.09567](#)].
- [23] C. P. Herzog and K.-W. Huang, *Boundary Conformal Field Theory and a Boundary Central Charge*, *JHEP* **10** (2017) 189, [[arXiv:1707.06224](#)].
- [24] V. Pestun, *Localization of the four-dimensional $N=4$ SYM to a two-sphere and $1/8$ BPS Wilson loops*, *JHEP* **12** (2012) 067, [[arXiv:0906.0638](#)].
- [25] M. Dedushenko, S. S. Pufu, and R. Yacoby, *A one-dimensional theory for Higgs branch operators*, *JHEP* **03** (2018) 138, [[arXiv:1610.00740](#)].
- [26] E. Witten, *On quantum gauge theories in two-dimensions*, *Commun. Math. Phys.* **141** (1991) 153–209.
- [27] B. E. Rusakov, *Loop averages and partition functions in $U(N)$ gauge theory on two-dimensional manifolds*, *Mod. Phys. Lett.* **A5** (1990) 693–703.
- [28] M. Blau and G. Thompson, *Quantum Yang-Mills theory on arbitrary surfaces*, *Int. J. Mod. Phys.* **A7** (1992) 3781–3806.
- [29] E. Witten, *Two-dimensional gauge theories revisited*, *J. Geom. Phys.* **9** (1992) 303–368, [[hep-th/9204083](#)].
- [30] M. Blau and G. Thompson, *Lectures on 2-d gauge theories: Topological aspects and path integral techniques*, in *Proceedings, Summer School in High-energy physics and cosmology: Trieste, Italy, June 14-July 30, 1993*, pp. 0175–244, 1993. [hep-th/9310144](#).
- [31] S. Cordes, G. W. Moore, and S. Ramgoolam, *Lectures on 2-d Yang-Mills theory, equivariant cohomology and topological field theories*, *Nucl. Phys. Proc. Suppl.* **41** (1995) 184–244, [[hep-th/9411210](#)].
- [32] A. Karch and L. Randall, *Open and closed string interpretation of SUSY CFT's on branes with boundaries*, *JHEP* **06** (2001) 063, [[hep-th/0105132](#)].
- [33] M. de Leeuw, C. Kristjansen, and K. Zarembo, *One-point Functions in Defect CFT and Integrability*, *JHEP* **08** (2015) 098, [[arXiv:1506.06958](#)].

- [34] I. Buhl-Mortensen, M. de Leeuw, C. Kristjansen, and K. Zarembo, *One-point Functions in AdS/dCFT from Matrix Product States*, *JHEP* **02** (2016) 052, [[arXiv:1512.02532](#)].
- [35] I. Buhl-Mortensen, M. de Leeuw, A. C. Ipsen, C. Kristjansen, and M. Wilhelm, *One-loop one-point functions in gauge-gravity dualities with defects*, *Phys. Rev. Lett.* **117** (2016), no. 23 231603, [[arXiv:1606.01886](#)].
- [36] M. de Leeuw, C. Kristjansen, and S. Mori, *AdS/dCFT one-point functions of the SU(3) sector*, *Phys. Lett. B* **763** (2016) 197–202, [[arXiv:1607.03123](#)].
- [37] I. Buhl-Mortensen, M. de Leeuw, A. C. Ipsen, C. Kristjansen, and M. Wilhelm, *A Quantum Check of AdS/dCFT*, *JHEP* **01** (2017) 098, [[arXiv:1611.04603](#)].
- [38] M. de Leeuw, C. Kristjansen, and G. Linardopoulos, *One-point functions of non-protected operators in the SO(5) symmetric D3–D7 dCFT*, *J. Phys. A* **50** (2017), no. 25 254001, [[arXiv:1612.06236](#)].
- [39] I. Buhl-Mortensen, M. de Leeuw, A. C. Ipsen, C. Kristjansen, and M. Wilhelm, *Asymptotic One-Point Functions in Gauge-String Duality with Defects*, *Phys. Rev. Lett.* **119** (2017), no. 26 261604, [[arXiv:1704.07386](#)].
- [40] M. de Leeuw, A. C. Ipsen, C. Kristjansen, and M. Wilhelm, *Introduction to integrability and one-point functions in $\mathcal{N} = 4$ supersymmetric Yang–Mills theory and its defect cousin*, *Les Houches Lect. Notes* **106** (2019) [[arXiv:1708.02525](#)].
- [41] M. De Leeuw, C. Kristjansen, and G. Linardopoulos, *Scalar one-point functions and matrix product states of AdS/dCFT*, *Phys. Lett. B* **781** (2018) 238–243, [[arXiv:1802.01598](#)].
- [42] A. Gimenez Grau, C. Kristjansen, M. Volk, and M. Wilhelm, *A Quantum Check of Non-Supersymmetric AdS/dCFT*, *JHEP* **01** (2019) 007, [[arXiv:1810.11463](#)].
- [43] A. Gimenez-Grau, C. Kristjansen, M. Volk, and M. Wilhelm, *A Quantum Framework for AdS/dCFT through Fuzzy Spherical Harmonics on S^4* , [arXiv:1912.02468](#).
- [44] M. De Leeuw, T. Gombor, C. Kristjansen, G. Linardopoulos, and B. Pozsgay, *Spin Chain Overlaps and the Twisted Yangian*, *JHEP* **01** (2020) 176, [[arXiv:1912.09338](#)].

- [45] E. Widen, *One-point functions in β -deformed $\mathcal{N} = 4$ SYM with defect*, *JHEP* **11** (2018) 114, [[arXiv:1804.09514](#)].
- [46] M. Dedushenko, *Gluing II: Boundary Localization and Gluing Formulas*, [[arXiv:1807.04278](#)].
- [47] S. Giombi and V. Pestun, *Correlators of local operators and 1/8 BPS Wilson loops on S^{*2} from 2d YM and matrix models*, *JHEP* **10** (2010) 033, [[arXiv:0906.1572](#)].
- [48] K. A. Intriligator, *Bonus symmetries of $\mathcal{N} = 4$ superYang-Mills correlation functions via AdS duality*, *Nucl.Phys.* **B551** (1999) 575–600, [[hep-th/9811047](#)].
- [49] S. Giombi and V. Pestun, *Correlators of Wilson Loops and Local Operators from Multi-Matrix Models and Strings in AdS*, *JHEP* **01** (2013) 101, [[arXiv:1207.7083](#)].
- [50] S. Benvenuti and S. Pasquetti, *3D-partition functions on the sphere: exact evaluation and mirror symmetry*, *JHEP* **05** (2012) 099, [[arXiv:1105.2551](#)].
- [51] T. Nishioka, Y. Tachikawa, and M. Yamazaki, *3d Partition Function as Overlap of Wavefunctions*, *JHEP* **08** (2011) 003, [[arXiv:1105.4390](#)].
- [52] M. Honda, *Direct derivation of "mirror" ABJ partition function*, *JHEP* **12** (2013) 046, [[arXiv:1310.3126](#)].
- [53] B. Robinson and C. F. Uhlemann, *Supersymmetric D3/D5 for massive defects on curved space*, *JHEP* **12** (2017) 143, [[arXiv:1709.08650](#)].
- [54] O. DeWolfe, D. Z. Freedman, and H. Ooguri, *Holography and defect conformal field theories*, *Phys. Rev.* **D66** (2002) 025009, [[hep-th/0111135](#)].
- [55] K. Nagasaki and S. Yamaguchi, *Expectation values of chiral primary operators in holographic interface CFT*, *Phys. Rev.* **D86** (2012) 086004, [[arXiv:1205.1674](#)].
- [56] N. Drukker, D. Gaiotto, and J. Gomis, *The Virtue of Defects in 4D Gauge Theories and 2D CFTs*, *JHEP* **06** (2011) 025, [[arXiv:1003.1112](#)].
- [57] M. Bullimore, M. Fluder, L. Hollands, and P. Richmond, *The superconformal index and an elliptic algebra of surface defects*, *JHEP* **10** (2014) 062, [[arXiv:1401.3379](#)].
- [58] E. Gava, K. S. Narain, M. N. Muteeb, and V. I. Giraldo-Rivera, *$N = 2$ gauge theories on the hemisphere HS^4* , *Nucl. Phys.* **B920** (2017) 256–297, [[arXiv:1611.04804](#)].

- [59] B. Le Floch and G. J. Turiaci, *AGT/ \mathbb{Z}_2* , *JHEP* **12** (2017) 099, [[arXiv:1708.04631](#)].
- [60] A. Bawane, S. Benvenuti, G. Bonelli, N. Muteeb, and A. Tanzini, *$\mathcal{N} = 2$ gauge theories on unoriented/open four-manifolds and their AGT counterparts*, *JHEP* **07** (2019) 040, [[arXiv:1710.06283](#)].
- [61] E. Gerchkovitz, J. Gomis, and Z. Komargodski, *Sphere Partition Functions and the Zamolodchikov Metric*, *JHEP* **11** (2014) 001, [[arXiv:1405.7271](#)].
- [62] E. Gerchkovitz, J. Gomis, N. Ishtiaque, A. Karasik, Z. Komargodski, and S. S. Pufu, *Correlation Functions of Coulomb Branch Operators*, *JHEP* **01** (2017) 103, [[arXiv:1602.05971](#)].
- [63] M. Baggio, V. Niarchos, and K. Papadodimas, *tt^* equations, localization and exact chiral rings in $4d \mathcal{N} = 2$ SCFTs*, *JHEP* **02** (2015) 122, [[arXiv:1409.4212](#)].
- [64] M. Baggio, V. Niarchos, and K. Papadodimas, *Exact correlation functions in $SU(2)\mathcal{N} = 2$ superconformal QCD*, *Phys. Rev. Lett.* **113** (2014), no. 25 251601, [[arXiv:1409.4217](#)].
- [65] D. Rodriguez-Gomez and J. G. Russo, *Operator mixing in large N superconformal field theories on S^4 and correlators with Wilson loops*, *JHEP* **12** (2016) 120, [[arXiv:1607.07878](#)].
- [66] E. Brezin, C. Itzykson, G. Parisi, and J. Zuber, *Planar Diagrams*, *Commun. Math. Phys.* **59** (1978) 35.
- [67] B. Eynard, T. Kimura, and S. Ribault, *Random matrices*, [arXiv:1510.04430](#).
- [68] K. Nagasaki, H. Tanida, and S. Yamaguchi, *Holographic Interface-Particle Potential*, *JHEP* **01** (2012) 139, [[arXiv:1109.1927](#)].
- [69] O. Tsuchiya, *Determinant formula for the six-vertex model with reflecting end*, *Journal of Mathematical Physics* **39** (1998), no. 11 5946–5951, [[solv-int/9804010](#)].
- [70] M. Brockmann, J. De Nardis, B. Wouters, and J.-S. Caux, *A gaudin-like determinant for overlaps of néel and xxz bethe states*, *Journal of Physics A: Mathematical and Theoretical* **47** (2014), no. 14 145003, [[arXiv:1401.2877](#)].

- [71] B. Pozsgay, *Overlaps between eigenstates of the xxz spin-1/2 chain and a class of simple product states*, *Journal of Statistical Mechanics: Theory and Experiment* **2014** (2014), no. 6 P06011, [[s1309.4593](#)].
- [72] K. Kozłowski and B. Pozsgay, *Surface free energy of the open xxz spin-1/2 chain*, *Journal of Statistical Mechanics: Theory and Experiment* **2012** (2012), no. 05 P05021, [[arXiv:1201.5884](#)].
- [73] G. Arutyunov and S. Frolov, *Foundations of the $AdS_5 \times S^5$ Superstring. Part I*, *J. Phys. A* **42** (2009) 254003, [[arXiv:0901.4937](#)].
- [74] T. Klose, T. McLoughlin, R. Roiban, and K. Zarembo, *Worldsheet scattering in $AdS_5 \times S^5$* , *JHEP* **03** (2007) 094, [[hep-th/0611169](#)].
- [75] G. Arutyunov, S. Frolov, and M. Zamaklar, *The Zamolodchikov-Faddeev algebra for $AdS_5 \times S^5$ superstring*, *JHEP* **04** (2007) 002, [[hep-th/0612229](#)].
- [76] S. Ghoshal and A. B. Zamolodchikov, *Boundary S matrix and boundary state in two-dimensional integrable quantum field theory*, *Int. J. Mod. Phys. A* **9** (1994) 3841–3886, [[hep-th/9306002](#)]. [Erratum: *Int.J.Mod.Phys.A* 9, 4353 (1994)].
- [77] L. Piroli, B. Pozsgay, and E. Vernier, *What is an integrable quench?*, *Nuclear Physics B* **925** (2017) 362–402, [[arXiv:1709.04796](#)].
- [78] P. Dorey, D. Fioravanti, C. Rim, and R. Tateo, *Integrable quantum field theory with boundaries: The Exact g function*, *Nucl. Phys. B* **696** (2004) 445–467, [[hep-th/0404014](#)].
- [79] B. Pozsgay, *On $O(1)$ contributions to the free energy in Bethe Ansatz systems: The Exact g -function*, *JHEP* **08** (2010) 090, [[arXiv:1003.5542](#)].
- [80] I. Kostov, D. Serban, and D.-L. Vu, *Boundary TBA, trees and loops*, *Nucl. Phys. B* **949** (2019) 114817, [[arXiv:1809.05705](#)].
- [81] I. Kostov, *Effective Quantum Field Theory for the Thermodynamical Bethe Ansatz*, *JHEP* **02** (2020) 043, [[arXiv:1911.07343](#)].
- [82] P. Dorey and R. Tateo, *Excited states by analytic continuation of TBA equations*, *Nucl. Phys. B* **482** (1996) 639–659, [[hep-th/9607167](#)].

- [83] N. Beisert, *The $SU(2|2)$ dynamic S -matrix*, *Adv. Theor. Math. Phys.* **12** (2008) 945–979, [[hep-th/0511082](#)].
- [84] N. Beisert, *The Analytic Bethe Ansatz for a Chain with Centrally Extended $su(2|2)$ Symmetry*, *J. Stat. Mech.* **0701** (2007) P01017, [[nlin/0610017](#)].
- [85] S. Komatsu, *Three-point functions in $\mathcal{N} = 4$ supersymmetric Yang–Mills theory*, *Les Houches Lect. Notes* **106** (2019) [[arXiv:1710.03853](#)].
- [86] G. Arutyunov, S. Frolov, J. Plefka, and M. Zamaklar, *The Off-shell Symmetry Algebra of the Light-cone $AdS_5 \times S^5$ Superstring*, *J. Phys. A* **40** (2007) 3583–3606, [[hep-th/0609157](#)].
- [87] T. Gombor and Z. Bajnok, *Boundary states, overlaps, nesting and bootstrapping $AdS/dCFT$* , [arXiv:2004.11329](#).
- [88] N. Beisert, B. Eden, and M. Staudacher, *Transcendentality and Crossing*, *J. Stat. Mech.* **0701** (2007) P01021, [[hep-th/0610251](#)].
- [89] P. Vieira and D. Volin, *Review of AdS/CFT Integrability, Chapter III.3: The Dressing factor*, *Lett. Math. Phys.* **99** (2012) 231–253, [[arXiv:1012.3992](#)].
- [90] L. Castillejo, R. Dalitz, and F. Dyson, *Low’s scattering equation for the charged and neutral scalar theories*, *Phys. Rev.* **101** (1956) 453–458.
- [91] D. M. Hofman and J. M. Maldacena, *Reflecting magnons*, *JHEP* **11** (2007) 063, [[arXiv:0708.2272](#)].
- [92] N. Dorey, D. M. Hofman, and J. M. Maldacena, *On the Singularities of the Magnon S -matrix*, *Phys. Rev. D* **76** (2007) 025011, [[hep-th/0703104](#)].
- [93] J. Escobedo, N. Gromov, A. Sever, and P. Vieira, *Tailoring Three-Point Functions and Integrability*, *JHEP* **09** (2011) 028, [[arXiv:1012.2475](#)].
- [94] N. Drukker, S. Giombi, R. Ricci, and D. Trancanelli, *Wilson loops: From four-dimensional SYM to two-dimensional YM*, *Phys. Rev. D* **77** (2008) 047901, [[arXiv:0707.2699](#)].
- [95] N. Drukker, S. Giombi, R. Ricci, and D. Trancanelli, *Supersymmetric Wilson loops on S^{*3}* , *JHEP* **05** (2008) 017, [[arXiv:0711.3226](#)].

- [96] M. de Leeuw, A. C. Ipsen, C. Kristjansen, K. E. Vardinghus, and M. Wilhelm, *Two-point functions in AdS/dCFT and the boundary conformal bootstrap equations*, *JHEP* **08** (2017) 020, [[arXiv:1705.03898](#)].
- [97] M. Rapcak, *Nonintegrability of NS5-like Interface in $\mathcal{N} = 4$ Supersymmetric Yang-Mills*, [arXiv:1511.02243](#).