

# The orbital clusters among the near Earth asteroids

Tadeusz J. Jopek<sup>★</sup>

*Astronomical Observatory Institute, Faculty of Physics, A. Mickiewicz University, Słoneczna 36, 60-286 Poznań, Poland*

Accepted XXX. Received YYY; in original form ZZZ

## ABSTRACT

Fifteen orbital clusters (associations) were identified among ~20000 near Earth asteroids (NEAs). All associations were found with a high statistical reliability using a single linkage cluster analysis algorithm and three orbital similarity functions. The identified groups constitute a small fraction (4.74 %) of the entire sample. Nonetheless they may be hazardous to the Earth and its inhabitants. As it happens with meteoroid streams, every year the Earth comes very close to the orbits of each association. In two cases (2008TC3 and 2017FU102) the distance between the asteroid's and the Earth's orbits was smaller than our planet's radius. Among the members of the identified associations we found 331 objects larger than the Chelyabinsk asteroid and all of them approach the Earth's orbit at a distance smaller than 0.05 [au]. Two of the identified groups (4179) Toutatis and (251430) Itokawa support catastrophic origins of Toutatis and Itokawa asteroids.

This study does not focus on the origin of the NEA associations, but on tracing them. Regardless of their origin, the identified groups pose a serious threat to the Earth. Hence, to facilitate their monitoring of we calculated coordinates of the theoretical radiant and calendar dates of their potential activity.

**Key words:** methods: data analysis—minor planets

## 1 INTRODUCTION

While the existence of main belt asteroid (MBA) families is accepted beyond doubt, the existence of families among near Earth asteroids (NEAs) is an open issue, as is the problem of the genetic association of comet groups and pairs. In Kresak (1982) the author wrote “... to illustrate the diversity of opinions on this issue, it may be quoted from Öpik (1971), that there are at least 60 groups of two or seven known comets which are due to real genetic associations.” “... and from Whipple (1977), that except for a few pairs these groups exhibit similarity in their orbital elements that is no greater than might be expected by chance.”

The search for groupings amongst the NEAs does not have a long history. Almost twenty years have passed since an extensive search was performed by Drummond (2000). Among 708 NEAs he found 14 associations of 4-25 members. Drummond estimated that more than half of them might be attributed to chance alignments. This study was followed by Fu et al. (2005), where authors made critical study of Drummond's results and confirmed his skepticism. Fu et al. concluded “... Drummond's families are nothing more than random fluctuations in the distributions of NEA osculating orbital elements.” Schunová et al. (2012) searching for families amongst ~7500 near Earth objects (NEOs), confirmed they had not identified any NEO family. Different results were obtained by Jopek (2011a, 2015) and recently by De la Fuente Marcos & De la Fuente Marcos (2016). Jopek found

more than ten groups of more than ten members amongst ~9000 NEAs. De la Fuente Marcos & De la Fuente Marcos (2016) examined the orbits of ~13500 NEOs and as a result confirmed the presence of statistically significant dynamical groupings among the NEO population.

The above mentioned studies produced different results, which is understandable as search for families (members originating from the same parent body) and search for associations (members displaying the orbital similarity only) are two different tasks. Nonetheless both ample families and associations pose an increased threat to the Earth regardless of their origin, thus the search for groupings amongst the NEA's is an important issue.

In this study an extensive and statistically strict search for associations has been conducted amongst ~20000 NEA's orbits by applying the cluster analysis method, developed and validated for the meteoroid stream searching (Jopek 2011b).

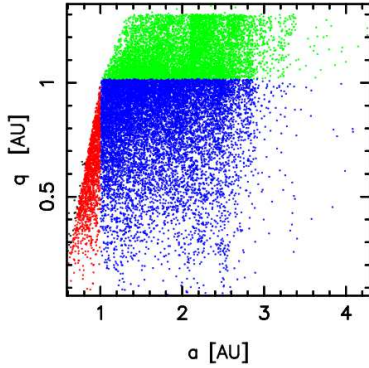
## 2 NEA DATA AND THE SEARCHING METHOD

### 2.1 NEA orbital sample

The NEAs orbital data was retrieved in May 14th, 2019 from the NEODyS-2 database<sup>1</sup> Heliocentric ecliptical osculating elements

<sup>1</sup> The database is publicly available at the URL <https://newton.spacedys.com/neodyS/index.php?pc=5>

<sup>★</sup> E-mail: jopek@amu.edu.pl



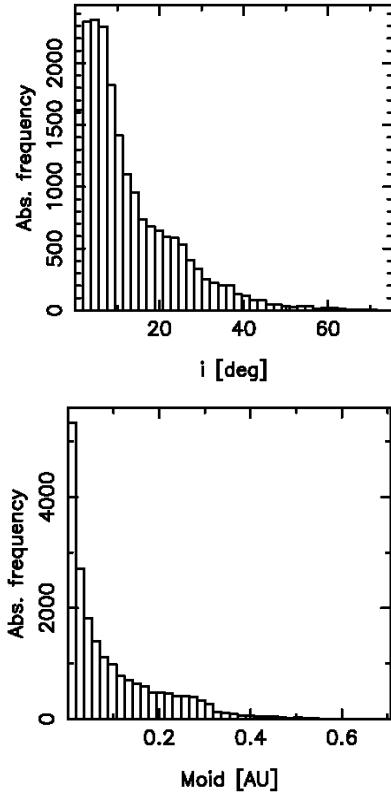
**Figure 1.** Distribution of 20038 NEAs on the  $a$ - $q$  plane. 7471 green points represent the Amor subsample, 11032 blue points represent the objects of the Apollo type, 1516 red points represent the Aten subsample. 19 black points (just above the Atens) mark the Atira objects. (For interpretation of colors in this figure the reader is referred to the web version of this article.)

(epoch 58400 MJD [TDB], reference frame J2000):  $a$  — semi-major axis,  $e$  — eccentricity,  $q$  — perihelion distance,  $\omega$  — argument of perihelion,  $\Omega$  — longitude of ascending node and  $i$  — inclination were used. The orbits with  $i > 90^\circ$  or  $a > 4.4$  [au] or  $q > 1.35$  [au] — 31 in total were discarded. Additionally, two objects (2010 LB67, 2010 LB64) whose absolute magnitude  $H = -1$ , were rejected. Accordingly, in this study 20038 osculating orbits was searched for groupings.

The NEAs sample contains four types of objects (see Fig 1), namely: 19 Atiras, 1516 Atens, 11032 Apollos and 7471 Amors, as defined by separate regions on the  $a$ - $q$  plane they occupy<sup>2</sup>. The NEAs sample is dominated by low inclination orbits (see Fig. 2), with more than half having inclination smaller than  $10^\circ$ . The median  $i_{0.5} = 9^\circ$ , the maximum value equals  $i_M = 75^\circ$ .

For each NEA orbit we calculated the minimum orbital intersection distance (MOID) with the Earth's orbit along with corresponding theoretical geocentric radiant parameters. The MOIDs and the radiant coordinates were calculated according to the methods provided in Dybczynski et al. (1986) and Sitarski (1964), respectively. The Earth's orbital elements were calculated on the osculating epoch 2458400.5 [TDB], using DE405 JPL Ephemerides<sup>3</sup>.

In the NEAs sample small MOIDs are predominant — the median is  $\text{MOID}_{0.5} = 0.0550$  [au], which is close to the value given by the NASA definitions of the Potentially Hazardous Asteroids (PHA). Applying both criteria for PHAs:  $\text{MOID} \leq 0.05$  [au] and absolute magnitude  $H \leq 22.0^m$  we found 1969 PHAs, which constitutes 9.8% of the whole sample. Assuming the albedo of 0.15, the value  $H = 22^m$  corresponds to the asteroid's diameter  $d = 140$  [m]. However, if we choose  $H = 26^m$  (the diameter  $d = 22$  [m]), the number of NEAs satisfying the conditions  $H \leq 26^m$  and  $\text{MOID} = 0.05$  [au] rises to 6825 objects, 34% of the NEAs sample. It is significant to note that Chelyabinsk object had the diameter  $\sim 20$  [m] (Popova et al. 2013).



**Figure 2.** Histograms of orbital inclinations and the MOIDs of 20038 NEAs. Low inclined orbits predominate, the median  $i_{0.5} = 9^\circ$ . Small MOIDs are also predominant, the median  $\text{MOID}_{0.5} = 0.0550$  [au].

## 2.2 Searching method

Our search method comprises of three components:

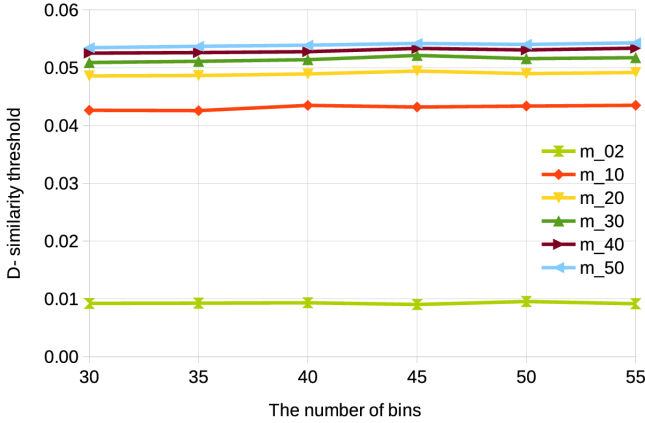
- *cluster analysis algorithm* — we used a single linkage method (a variant of general hierarchical cluster analysis method) proposed for the meteoroid stream identification by Southworth & Hawkins (1963).
- *orbital similarity function* — we used the hybrid D-function  $D_H$  proposed by Jopek (1993b) and two  $\rho$ -functions ( $\rho_1, \rho_2$ ), applied in Kholshchevnikov et al. (2016). The mathematical formulas and further details about different  $D$ - and  $\rho$ -functions can be found in Williams et al. (2019).
- *orbital similarity thresholds* were determined using a statistical approach; the thresholds were found separately for each group of 2, 3, ...,  $M=50$  members, and for each  $D_H, \rho_1, \rho_2$  functions. All thresholds corresponded to low probability (less than 1%) of chance grouping.

The orbital similarity thresholds were determined by numerical experiment (similar to the one described by Jopek & Froeschlé (1997); Jopek et al. (2003)), namely:

- we searched for groupings in the synthetic orbital samples starting from a threshold  $D_0$  for which no single group of 2, 3, 4... members were found,
- next, the search for groups was repeated with an increased value of  $D_0$  until the first group of 2, 3, 4, ..., 50 members, respectively, were found and the obtained  $D_{0M}$  corresponding to the previous step were stored,
- when the last  $D_{0M}$  value was found the new synthetic orbital

<sup>2</sup> We applied definitions given at <https://cneos.jpl.nasa.gov/about/neo2-groups.html>

<sup>3</sup> We used the software and data file from <https://ssd.jpl.nasa.gov/>



**Figure 3.** The orbital similarity thresholds determined for  $\rho_1$  function versus different bin histograms sizes used for synthetic orbits generation. The thresholds are plotted for the groups of 2, 10, 20, 30, 40, 50 members identified among the synthetic NEA orbits.

sample was searched. For each distance function 100 synthetic orbital samples were searched.

- The final individual thresholds  $D_M$ ,  $M = 2...50$  were calculated as the arithmetic means of one hundred of  $D_{0M}$  values.

The synthetic NEA orbits were generated using inversion of the cumulative probability distributions of the observed sample, according to the method *C* described in Jopek & Bronikowska (2017). Only the synthetic orbital samples which had passed the consistency test with the observed sample were used. The chi-square test was applied, see Press et al. (2002). Before the final thresholds  $D_M$  were determined, the possible groups in the observed NEA sample had been excluded. They had been identified by the same cluster analysis as described above. After the elimination, the orbital distributions of the observed reduced sample were used to determine the final thresholds  $D_M$ .

To estimate the sensitivity of  $D_M$  values to the assumed parameters of our synthetic orbits generation method, we carried several additional simulations. We checked the influence of the size of the histogram bins and the choice of the seed of the uniform random number generator. Fig. 3 shows that the thresholds (an example for the  $\rho_1$  function is given) are not sensitive to the histogram bin size. A similar lack of dependence was found while changing the seeds of the random number generator, as well as the remaining functions.

Finally we determined the medians of the  $D_M$  values obtained from different bins and seeds. Their arithmetic means are provided in Table 1, and these are the values applied in this study.

### 3 GENERAL RESULTS

The results of all nine searches are summarized in Table 2. 18–22 associations were found which constitutes 3.6–5.1% orbits of the whole NEAs sample. The obtained percentage values are considerably lower than in the meteor streams searching, e.g.: in Southworth & Hawkins (1963) of the 359 photographic orbits about 36% belonged to streams, in Jopek (1986) of the 1608 photographic orbits about 58% belonged to streams, in Jopek (1993a) of the 531 TV meteor orbits about 30% belonged to stream component, in Jopek et al. (1999a) of the 3675 radio orbits about 28% belonged to stream, in Jopek et al. (2003) of the 256 bolides about

**Table 1.** The values of the orbital similarity thresholds and their uncertainties applied in the search for associations amongst 20038 NEA orbits. The thresholds correspond to the reliability level  $> 99\%$  for each group of  $M$  members and for each distance function:  $D_H, \rho_1, \rho_2$ . The thresholds provided in this table are closely related with the single linkage method and the size of the NEA sample used in this study. Before being used the thresholds had been multiplied by the factors given in the second row of the table.

$M$	$D_H \pm \sigma$		$\rho_1 \pm \sigma$		$\rho_2 \pm \sigma$	
	$10^{-2}$	$10^{-4}$	$10^{-2}$	$10^{-4}$	$10^{-2}$	$10^{-4}$
2	0,8209	1,0	0,9366	2,4	0,9951	1,8
3	2,0137	4,3	2,2837	3,2	2,4106	4,1
4	2,6528	3,1	2,9953	4,1	3,1673	4,1
5	3,0358	2,7	3,4259	4,5	3,6307	3,0
6	3,2888	1,9	3,7021	3,7	3,9323	3,2
7	3,4668	1,2	3,9008	3,1	4,1425	2,2
8	3,6065	1,5	4,0659	2,6	4,3299	2,3
9	3,7268	2,5	4,2044	3,7	4,4688	2,4
10	3,8240	3,1	4,3102	2,7	4,5966	1,6
11	3,9039	2,3	4,4022	3,4	4,6759	1,4
12	3,9739	2,3	4,4809	3,0	4,7628	1,8
13	4,0355	1,6	4,5455	2,4	4,8336	2,4
14	4,0870	1,4	4,6078	2,2	4,8916	2,2
15	4,1400	1,9	4,6584	2,9	4,9490	2,3
16	4,1807	1,8	4,7049	3,2	5,0058	3,0
17	4,2194	2,0	4,7521	2,5	5,0524	2,7
18	4,2522	2,3	4,7889	2,5	5,0958	2,1
19	4,2904	1,6	4,8248	2,3	5,1369	1,6
20	4,3224	2,0	4,8560	2,7	5,1747	1,7
21	4,3466	1,9	4,8859	2,7	5,2068	2,1
22	4,3712	1,9	4,9133	2,2	5,2359	2,6
23	4,4000	2,2	4,9453	2,6	5,2659	2,6
24	4,4229	2,5	4,9706	2,8	5,2927	2,7
25	4,4425	2,5	4,9915	2,8	5,3193	3,0
26	4,4664	2,7	5,0131	2,8	5,3452	2,8
27	4,4845	2,7	5,0336	3,1	5,3692	3,0
28	4,5019	2,5	5,0492	2,9	5,3889	3,1
29	4,5213	2,8	5,0669	2,9	5,4103	3,2
30	4,5382	2,9	5,0853	2,8	5,4300	3,5
31	4,5518	2,6	5,1009	2,6	5,4481	3,0
32	4,5631	2,5	5,1157	2,5	5,4614	2,9
33	4,5760	2,5	5,1308	2,5	5,4791	2,6
34	4,5908	2,6	5,1454	2,8	5,4934	2,6
35	4,6009	2,7	5,1583	2,7	5,5086	2,6
36	4,6147	3,0	5,1713	2,6	5,5245	2,7
37	4,6288	3,1	5,1856	2,3	5,5388	2,5
38	4,6424	3,1	5,1966	2,3	5,5521	2,7
39	4,6541	3,0	5,2113	2,3	5,5678	2,9
40	4,6643	2,9	5,2233	2,2	5,5777	2,8
41	4,6744	3,1	5,2360	2,0	5,5879	2,7
42	4,6838	3,1	5,2475	2,2	5,6010	2,8
43	4,6917	3,1	5,2562	2,0	5,6145	2,7
44	4,7025	3,0	5,2664	1,9	5,6273	2,5
45	4,7127	2,7	5,2785	1,9	5,6383	2,4
46	4,7215	2,9	5,2880	2,1	5,6485	2,3
47	4,7304	2,9	5,2972	2,0	5,6566	2,0
48	4,7386	3,0	5,3066	2,3	5,6672	2,1
49	4,7454	2,8	5,3170	2,2	5,6761	2,0
50	4,7529	2,7	5,3248	2,0	5,6851	1,9

29% belonged to streams. Of  $\sim 19000$  radio-meteoroids only about 16% belonged to streams (Sekanina 1976).

For each individual distance function, the results are quite consistent; and the results obtained with  $D_t \pm \sigma$  thresholds are similar. However, they differ when different functions are compared. Most of the associations (22 of them) were found using the  $\rho_1$  function. Their sizes were rather small and the most numerous group consisted of 292 members. Moreover, when using  $\rho_1$  function the associations made up the highest 5.1% of the total sample. Concerning the number of identified groups the searches with  $D_H, \rho_1, \rho_2$  gave reasonably similar results. The most stable results were obtained with  $\rho_1$  function while the largest groups (above 400 members) were identified with  $\rho_2$  metrics.

**Table 2.** The overall results of nine cluster analysis among 20038 NEAs.  $N_G$  is the total number of identified groups.  $N_A$  is the total number of asteroids identified in  $N_G$  groups;  $P$  is the fraction of the group component in the whole sample. The last two columns provide the minimum and maximum sizes of the identified groups. For each distance function the results correspond to three thresholds values:  $D_t$ ,  $D_t - \sigma$  and  $D_t + \sigma$  (see Table 1).

Dist. func.	$N_G$	$N_A$	$P$ [%]	$Min$	$Max$
$D_H$	21	798	4.0	2	211
$D_H + \sigma$	20	885	4.4	2	261
$D_H - \sigma$	21	714	3.6	2	154
$\rho_1$	22	954	4.8	2	283
$\rho_1 + \sigma$	22	1025	5.1	2	292
$\rho_1 - \sigma$	22	942	4.7	2	281
$\rho_2$	20	903	4.5	2	495
$\rho_2 + \sigma$	20	970	4.8	2	602
$\rho_2 - \sigma$	18	837	4.2	2	495

Such diverse results hamper the interpretation of the cluster analysis, but in the case of small bodies of the Solar System such differences are not surprising. Similar differences were observed in our earlier studies described in Jopek (2011a,b, 2015). They are caused by different properties of the orbital distance functions. Different D- and  $\rho$ - functions are not equivalent to each other (see Jopek 1993b; Kholshchikov et al. 2016). They are expressed by different mathematical formulas and depend on different number of variables: five in case of  $D_H$  and  $\rho_1$ , six in case of  $\rho_2$  function. These sets of variables refer to different spaces, therefore it is not surprising that when using distinct orbital distance functions we get different results of the cluster analysis. Hence, the problem is to decide — how should we extract the most robust associations from this complicated picture?

In what follows we discuss the results obtained with  $D_H$ ,  $\rho_1$  and  $\rho_2$  functions. No single association of 3 or more members was found by all functions. Some groups were found using only one distance function, but for many groups a partial overlap occurred. The most consistent result, found by all functions are two very compact pairs: 2015FO33, 2015YZ and 2017SN16, 2018RY7. On the other hand, one very complicated result is the huge association found using  $\rho_2$  function with the threshold  $D_t=0.0566$ . It is designated by  $\rho_2/296$  code and consists of 495 members. (In this study we designate association by the D-function and a running number (in our data sample) of the first NEA which belongs to this group.) The  $\rho_2/296$  association was partly split into 2 sub-groups found by  $D_H$  as well as by  $\rho_1$  function. Moreover,  $\rho_2/296$  association contained quite a few NEA's which were not included in the sub-groups in question. The  $\rho_2/296$  proved to be our most complex finding. We observed similar splittings in other large groups.

In the next section, we briefly present the results obtained by other researchers before providing more details about our findings.

### 3.1 The results obtained before this study

We refer to these studies where authors performed extended search for groups exclusively among the NEAs orbits.

In Drummond (2000) the author analysed 708 orbits. He applied different searching method, using a single linkage approach only when searching for pairs and strings. He also used the  $D_{SH}$  function proposed by Southworth & Hawkins (1963) and a sin-

gle value of the orbital similarity threshold  $D_t=0.115$ . Drummond found 14 associations of 4-25 members, 8 strings (i.e. groups of three members) and 7 pairs. His largest associations A1 consisted of 25 members. All groups contained 22% of the orbits from the entire NEAs sample, whereas in our study this percentage was only 3.6-5.1%. In our study we found many members of Drummond groups, however our findings were different, e.g. in our study Drummond's A1 association split up into  $DH/178$  (5 members) and  $\rho_1/659$  (1 member).

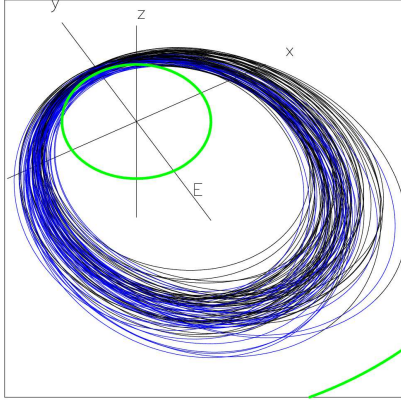
As mentioned in section 1, Schunová et al. (2012) searched for families among 7500 NEAs. They applied different cluster analysis and  $D_{SH}$  function. Three clusters C1, C2, C3 were found of 4-6-5 members only and no cluster passed the strict significance family-test. In our search, none of four objects of C1 group were identified as association member; five of six members of C2 were in  $DH/3058$  and  $\rho_1/3058$ . All five members of C3 were in our  $DH/955$ . In our study, however, we do not claim that our groups which incorporate C2, C3 are NEA families.

In our earlier search described in Jopek (2011a, 2015, 2019) we used similar approach as in this study, however, only very limited and general results have been presented. At the XXVIII IAU GA in Beijing (Jopek 2015) we presented the results of a search among 9004 NEAs. We accepted 10 associations which contained ~8% orbits of the whole sample. These findings are referred to in the following section.

Quite recently De la Fuente Marcos & De la Fuente Marcos (2016) searched for groupings among ~13400 NEAs orbits. They applied another cluster analysis algorithm as well as two different D-functions, namely the reduced  $D_R$  function proposed by Valsecchi et al. (1999) and a simplified form of the  $D_{SH}$  function proposed by Lindblad (1994). Five groups consisting of 43-180 members are reported in their paper. As the authors did not provide a full list of members of the identified groups (only a few members were specified) it is difficult for us to refer to this study. We were only able to find that the 4 mentioned NEAs from their 5011 Pthah group do not belong to any group found in our search; from 3 NEAs mentioned as the 85585 Mjolinr group only one was found in our  $\rho_1/3041$ ,  $\rho_2/3041$  associations and from 2 members of the 101955 Bennu group mentioned by De la Fuente Marcos & De la Fuente Marcos (2016) only one we found in our  $\rho_2/296$  association.

## 4 RESULTS AND DISCUSSION

In this section we describe the details of 15 associations identified in this study. The association were named after the first asteroid in the NeoDys catalogue belonging to the identified group. Our working code was also assigned — it represents the distance function used, and a running number of the first orbit in our NEA catalogue assigned to the group. For each group the members' names were listed. In bold are the names of the NEAs objects, which satisfy the following conditions — the absolute magnitude  $H \leq 26$  and the  $MOID \leq 0.05$  [au]. We call such objects 'Chelyabinsk class objects', which indicates they pose a potential threat the Earth's inhabitants comparable to that of Chelyabinsk meteorite. The orbits belonging to the same association are illustrated graphically. We applied different orbital projections in a drawing plane. The orbital arcs running below the ecliptic plane are plotted in blue. All physical parameters such as absolute magnitude  $H$  and diameters  $d$  were taken from <http://neo.ssa.esa.int/> or <http://neo.ssa.esa.int/neo-home>.



**Figure 4.** Anza (2061) association. 89 orbits resemble a meteoroid stream approaching the Earth orbit at distances 0.0006-0.1063 [au]. The activity of the bolides potentially related with this group starts in August and ends in November. The orbital arcs running below the ecliptic are plotted in blue. In green, the projection of the Earth's and the Jupiter's orbits are plotted. The Earth's orbit lies inside Anza association. In the bottom right corner the arc of the Jupiter's orbit can be seen.

#### 4.1 (2061) Anza association

Anza association (our internal code  $D_H/23$ ) was named after Anza NEA of absolute magnitude  $H=16.38^m$  and diameter  $d=1700$  [m]. The group consists of 89 members (see Table 3). It was identified using  $D_H$  function with the orbital similarity threshold  $D_t = 0.047386$ . Anza was found in our earlier search among  $\sim 9000$  NEAs (see Jopek 2015), at that time only 34 orbits of the group had been identified.

The orbit of 2008VB4 ( $H=28.32^m$ ), a member of this association, approaches the Earth's orbit very closely. Its MOID equals 0.000562 [au], or 0.219 [LD] i.e. the mean Earth-Moon distance. The parameters of a theoretical radiant of this NEA are: the equatorial coordinates  $\alpha_G=251^\circ$ ,  $\delta_G=-22^\circ$  and the geocentric velocity  $V_G=11.9$  [km/s]. Potential meteor-bolide activity related with this radiant falls on November 4th. The remaining orbits of the Anza group do not approach the Earth's orbit so closely. Nonetheless many of them reach MOIDs smaller than 0.05 [au]; the maximum MOID is 0.1063 [au], the average is 0.0326 [au]. 38 members of this group fall into Chelyabinsk class, 5 objects meet the PHAs criteria. In outer space, the orbits of Anza group form a structure resembling a typical meteoroid stream, as illustrated in Fig. 4. The names of the members of this association are listed in Table 3.

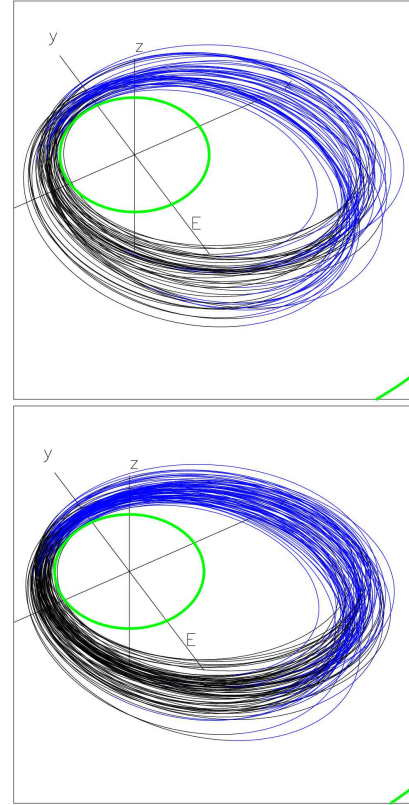
Anza asteroid was included by Drummond (1991) as a member of association II in his Table II. However, the other members of this group ((3551) Verenie, (496817) 1989VB, (3908) Nyx and (2202) Pele) were not identified as the members of our Anza association. Therefore our finding does not confirm Drummond's result.

#### 4.2 (12923) Zephyr association

Zephyr group (DH/178,  $H=15.7^m$ ,  $d = 2060$  [m]) was identified by  $D_H$  function and  $D_t = 0.047304$ . It consists of 51 orbits observed up to AD 2012 and 81 observed since 2012. In our previous search (Jopek 2015) this association had been named NEA Masaakikoyama (13553). The 132 orbits (see Tab. 4) form a structure resembling a meteoroid stream (see Fig. 5), however not as coherent one as in case of Anza association. The smallest MOID for this group is 0.000157 [au] or 0.0611 [LD]. We found it for

**Table 3.** Codes of the members of Anza (2061) association. 89 members were identified by  $D_H$  function, a single linkage cluster analysis algorithm and the orbital similarity threshold  $D_t = 0.047386$ . 38 objects in bold are of Chelyabinsk class.

2061	100085	162183	222008	1993UA	2001TY1
2002VU17	2004SS	2005PA17	2005UC3	2005VT2	2006SN131
2006UY16	2006VT13	2007PP9	2007RG2	2007SS1	2007TD1
2007UO6	2007VD8	2008RE1	2008SF8	2008UW99	2008VB4
2009QH34	2009SK	2009SV19	2009SX17	2009UL20	2010SK15
2010SU15	2011RJ1	2011SQ32	2011YQ10	2012PZ19	2012RH15
2012RW16	2012TE53	2012UC69	2012VF77	2013PH3	2013RO21
2013RT43	2013SQ19	2013TD	2013UQ5	2013VH13	2013VP13
2014SE145	2014ST1	2014SU143	2014TH17	2014TZ17	2014UY57
2014WG70	2015MW130	2015PT227	2015TP21	2015US51	2015VC65
2015VK64	2016NA1	2016PR26	2016QQ44	2016RD20	2016TC57
2016TL2	2016TQ18	2016TS	2016TT55	2016TT92	2016UD26
2016UH101	2017QW32	2017SG16	2017SQ12	2017TE1	2017TL2
2017TM2	2017UM2	2017UU	2017VA	2018RC4	2018RR4
2018SC1	2018TB	2018TY4	2018VO5	2018VP6	



**Figure 5.** Two plots of the Zephyr (12923) association orbits. Top — 51 orbits observed before AD 2012, bottom — 81 orbits observed between 2012–2019. The drawings are similar to each other. In green the Earth's orbit is plotted.

2018SM asteroid ( $H = 29.4^m$ ). The parameters of a theoretical radiant of this NEA are:  $\alpha_G = 217^\circ$ ,  $\delta_G = 20^\circ$ ,  $V_G = 10.2$  [km/s]. The potential meteor-bolide activity of this radiant falls on September 17th. The maximum MOID in Zephyr group equals 0.2768 [au] with the average one is 0.1417 [au]. 14 members are of Chelyabinsk class, 6 objects meet the PHA criteria.

**Table 4.** Zephyr (12923) association. 132 members were identified by  $D_H$  function, a single linkage cluster analysis algorithm and the orbital similarity threshold  $D_t = 0.047304$ . 14 objects in bold are of Chelyabinsk class.

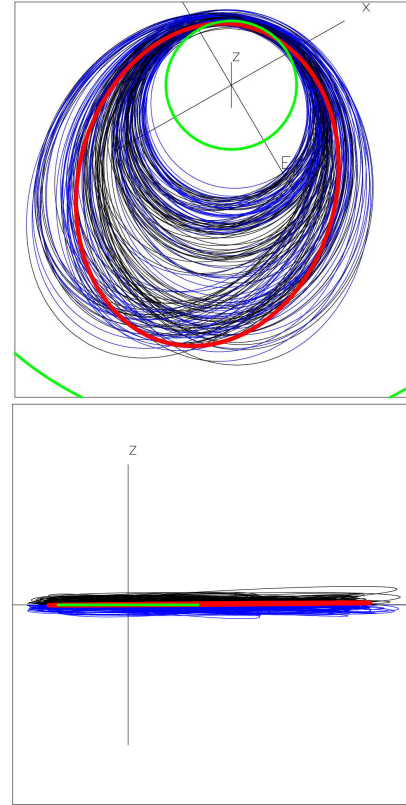
12923	13553	27031	159856	161999	212546
235086	373393	416584	452314	468741	481984
2000PP9	2000RK60	2001NJ6	2001QD34	2001SO263	2002RB
2003MU	2003QA30	2003SA85	2003SV159	2004PD97	2004PE20
2004QJ13	2004RS25	2004SE26	2005MX1	2005OK3	2005TL
2006HB	2006JU	2006KQ21	2007RS12	2007RZ19	2007TS68
2009QC	2009QR8	2010JV153	2010KK127	2010RP64	2010RS3
2011HD63	2011JP29	2011OC18	2011OE16	2011OV17	2011PC2
2012HG31	2012NP	2012OU5	2012PP24	2012QX17	2013KF6
2013NL10	2013PC39	2013PD26	2013PU13	2013PV6	2013QB11
2013QK6	2013RO30	2014JR55	2014MJ26	2014MP5	2014ON339
2014QQ207	2014OR338	2014PT59	2014QE391	2014QE434	2014QK390
2014QM362	2014SV141	2015KK122	2015MJ130	2015MU59	2015NV13
2015OH22	2015OJ22	2015PP227	2015PV227	2015PW56	2015QS8
2015QU8	2015RB36	2015RC2	2015RC37	2015RF83	2015RP2
2015TS237	2016GN220	2016LS9	2016MF1	2016NC39	2016NM39
2016NQ16	2016PB2	2016PH66	2016PW38	2016PW78	2016QR44
2016RC41	2016RK17	2016UD101	2017MC5	2017MY2	2017OF7
2017OG7	2017OU67	2017PC27	2017QA17	2017QK33	2017QO16
2017QO32	2017QU17	2017RC15	2017SQ21	2018JC3	2018LS15
2018MR6	2018PJ21	2018PL22	2018PN23	2018PO9	2018PO10
2018PQ24	2018PW21	2018PY21	2018RK3	2018RV1	2018SM

### 4.3 (4179) Toutatis association

Toutatis association (internal code  $\rho_1/63$ ) was named after the most massive object in the group,  $H=15.2^m$ , size 4750x1950 [m]. It was identified using  $\rho_1$  and  $D_H$  functions, providing 173 (see Tab. 5) and 211 members, respectively. The group resembles a dispersed but still coherent meteoroid stream. The orbits' inclinations are small (up to  $6.7^\circ$ ); many orbits closely approach the Earth's orbit at ascending and descending nodes. Toutatis orbital inclination equals  $0.45^\circ$ , its orbit occupies central position in the group, see Figure 6. The minimum, maximum and mean MOID for this group are: 0.000102 [au] or 0.039695 [LD], 0.182691 [au], 0.036038 [au], respectively. The minimum is for 2017SR2 NEA and the radiant parameters are  $\alpha_G = 323^\circ$ ,  $\delta_G = -18^\circ$ , geocentric velocity  $V_G = 9.5$  [km/s]. Potential meteor-bolide activity of this radiant falls on September 22nd. 71 members of the Toutatis association are of Chelyabinsk class.

The hypothesis that Toutatis is a member of the NEA group, in the context of Taurids Complex, was raised by Asher et al. (1993); Steel et al. (1993); Steel (1994). In Steel (1994) choosing Southworth and Hawkins D-function (Southworth & Hawkins 1963) and  $D_t = 0.25$ , Toutatis was listed with 22 other NEAs as having orbits similar to those of the Taurid meteoroid complex. In our search however, none of the 22 orbits was found among our Toutatis group.

Speculating if Toutatis is a member of the NEA family, Steel wrote 'Asteroid (4179) Toutatis is of some topical interest since it had a near miss of the Earth in 1992 December, radar images showing it to have a bifurcated structure. This might be understood in terms of a hierarchical disintegration, several subunits having already separated, leaving two still in contact. This interpretation would be bolstered by the identification of other NEAs on similar orbits as Toutatis, indicating that a family has been produced by the break-up of a larger object ...'. On December 2012, a close observation of Toutatis performed by Chang'e-2 spacecraft, (Huang et al. 2013) confirmed Steel's speculations. The bifurcated configuration implies that Toutatis is a contact binary. Other de-



**Figure 6.** Two projections of Toutatis association orbits (4179). Top — the ecliptic projection, bottom — the projection perpendicular to the ecliptic. The group was identified by  $\rho_1$  function, the orbit count is 173. The Toutatis orbit is plotted in red. In green color the Earth's orbit is plotted.

tails from the images imply Toutatis may have a rubble-pile structure (Huang et al. 2013).

Therefore our finding is in favor of a catastrophic origin of Toutatis asteroid, and perhaps the entire association. However it is not possible to fully answer questions related with the origin of Toutatis association after a cluster analysis only.

### 4.4 (25143) Itokawa association

This group (DH/227) was identified by  $D_H$ ,  $\rho_1$  as well as by  $\rho_2$  function. The numbers of the identified NEAs were 94, 128, 106, respectively. One of the most massive object in the group is Itokawa asteroid (25143),  $H = 18.95^m$ , size 520x270x230 [m]. 94 members of the group were identified with  $D_H$  and  $D_t = 0.047529$ .

The group resembles a quite coherent meteoroid stream. The inclinations of the orbits are small (up to  $6.5^\circ$ ), many orbits approach the Earth's orbit bf closely at both nodes. Itokawa orbital inclination equals  $1.62^\circ$ , its orbit approaches the Earth's orbit within 0.013 and 0.023 [au] on 28th June and 4th April, respectively. It occupies internal position in the group, see Fig. 7. The minimum, maximum and mean MOIDs of this group are: 0.000037 [au], 0.085742 [au], 0.022713 [au], respectively. The smallest MOID of 0.014399 [LD] was found for 2017FU102,  $H=28.67^m$ ,  $d=6$  [m]. This MOID is smaller than the Earth's radius but, fortunately, at the date when our planet was close to this point the asteroid was far away on its orbit. This small Earth MOID we calculated using the orbital elements corresponding to the osculating epoch 2455400.5

**Table 5.** Toutatis (4179) association. 173 members identified by  $\rho_1$  function, a single linkage cluster analysis algorithm and the orbital similarity threshold  $D_I = 0.053066$ . In bold, 71 association members which are of Chelyabinsk class.

4179	65803	429382	440212	455322	1997UR
2000SB45	2000TE2	2001UD18	2002TP69	2003TO9	2003WY153
2004XG29	2005AZ28	2005SK26	2005TD49	2005UF7	2005UN
2005VA	2006UA216	2006UE185	2006UN	2006VU2	2006YP44
2007TA23	2007TT24	2007TU68	2007VD138	2007VH184	2007WC
2007YY59	2008SV7	2008WF14	2008WF96	2009QZ34	2009RG2
2009RV1	2009TF8	2009UK1	2009UN1	2009VT1	2009WG106
2009WX7	2010UA7	2010UO7	2010VA40	2010VA140	2010VC140
2010VF139	2010VQ139	2010VR139	2010VV21	2010VW194	2010VY71
2010WD9	2010XW58	2011CR4	2011QS49	2011SL189	2011UB
2011YQ1	2012SJ32	2012TC4	2012TQ20	2012VB37	2012VF26
2012VL5	2012XB133	2012XH	2013RC32	2013RS43	2013TO69
2013US8	2013U1	2013VR12	2013XY9	2014OM339	2014SX141
2014TR	2014UA57	2014UH57	2014UK114	2014WF364	2014WG200
2014WN69	2014WX4	2015HV182	2015RN35	2015SJ17	2015TC145
2015TC179	2015TR238	2015TZ143	2015UC	2015UH	2015VA1
2015VG150	2015VH1	2015WF	2015XE	2015XG1	2015XM169
2015XR378	2016PR38	2016SO2	2016TL94	2016TW19	2016UD42
2016UG57	2016UY5	2016VL2	2016VQ4	2016WE	2016WM7
2016WQ1	2016XL23	2016XQ1	2016YO	2017QU1	2017RO16
2017RU2	2017RU17	2017RW2	2017SJ14	2017SK14	2017SL2
2017SR2	2017ST10	2017TK4	2017TQ5	2017UG3	2017UJ44
2017UO1	2017UQ5	2017US7	2017UT5	2017VC13	2017VD15
2017VE13	2017VG13	2017VG34	2017VM2	2017VO14	2017VX14
2017WL2	2017WL28	2017WP16	2017WW13	2017XF2	2017YK5
2018AY	2018BP	2018RK6	2018RM4	2018RQ4	2018SB1
2018TM3	2018TN3	2018TS2	2018TV	2018VB5	2018VG6
2018VK3	2018VN1	2018VR7	2018VX4	2018VX5	2018WQ
2018WV	2018WZ2	2018XF2	2018XX4	2019AS2	

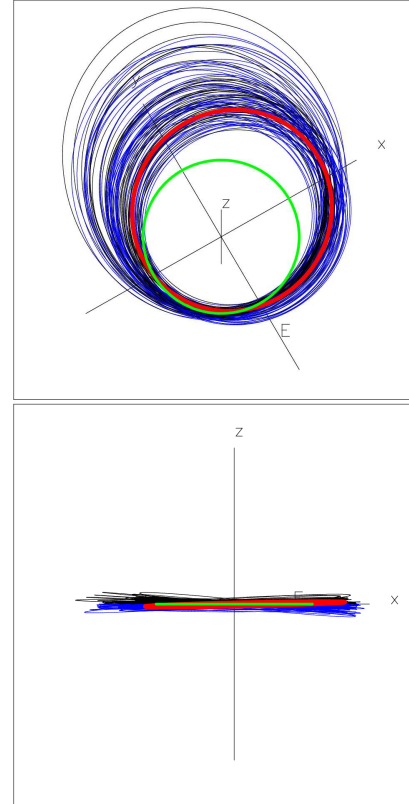
**Table 6.** Itokawa (25143) association. 94 members identified by  $D_H$  function, a single linkage cluster analysis algorithm and the orbital similarity threshold  $D_I = 0.047529$ . 40 members of Itokawa association, including Itokawa asteroid, are of Chelyabinsk class.

25143	89136	141018	2003DW10	2004DK1	2004HD
2004OW10	2006DN	2006EY	2006HX30	2006JT41	2006KL103
2007EG88	2007HB15	2007LT	2008CC71	2008HB2	2008LE
2009DN4	2009FH	2009FK	2009HH21	2010CE55	2010HF
2010JW39	2011EC	2011FT9	2011FU9	2011GR59	2012EB2
2012EM8	2012FV23	2012GP1	2012HB2	2012JO4	2012KT12
2013ED68	2013EN20	2013EN89	2013EN126	2013FB8	2013JF1
2013JT28	2014DG80	2014EO12	2014FZ	2014GV48	2014HA199
2014HR198	2014HS4	2014HT46	2014HV197	2014HY197	2014KQ84
2015CW13	2015DK200	2015FC345	2015FK120	2015HB117	2015KD57
2015KK120	2015MB54	2016CY135	2016EF86	2016EQ1	2016FN13
2016GH1	2016GH3	2016HO	2016JH	2016JM	2016JN6
2016NL39	2016NV22	2017FA159	2017FU102	2017FW128	2018CZ13
2018DN1	2018DY3	2018ED9	2018EM4	2018HO	2018PD9
2018PR23	2019CL2	2019ES	2019ES2	2019FH1	2019GC
2019GP5	2019GT1	2019JA1	2019JP1		

[TDB]. The orbit of 2017FU102 is not well known, the data-arc span is only 11 days.

The theoretical radiant parameters related to 2017FU102 asteroid are  $\alpha_G = 178^\circ$ ,  $\delta_G = 16^\circ$  and  $V_G = 7.29$  [km/s] the date of possible activity of this radiant is April 3rd. Forty members of this association satisfy the conditions of Chelyabinsk class, see Tab. 6.

In November 2005, Hayabusa spacecraft landed on 25143 Itokawa asteroid. It captured dust particles which were then analyzed in detail. In Nakamura et al. (2011) the authors wrote ‘*Mineral chemistry indicates that the majority of regolith surface particles suffered long-term thermal annealing and subsequent impact*



**Figure 7.** Two projections of the Itokawa (25143) association orbits. Top — 3-D projection from above the ecliptic, bottom — the projection perpendicular to the ecliptic. The group was identified by  $D_H$  function, it consists of 94 orbits. Itokawa orbit is plotted in red, the Earth’s orbit is plotted in green.

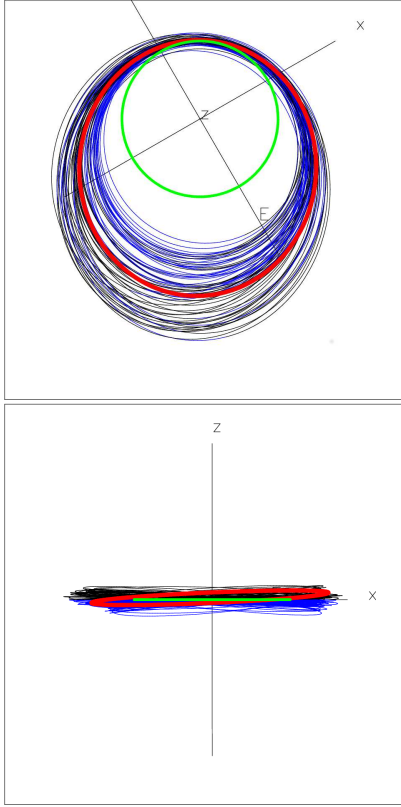
*shock, suggesting that Itokawa is an asteroid made of reassembled pieces of the interior portions of a once larger asteroid’.* Following this ascertainment, Ohtsuka et al. (2011) conducted a search for meteoroids originating from this NEA. They found that the fireball MORP 172<sup>4</sup> reveals a dynamic similarity to Itokawa. Using the Öpik variables  $U, \cos(\theta)$ , (see e.g. Valsecchi et al. 1999) they claim ‘*a strong dynamical relation (thus genetic) between Itokawa and MORP 172*’. Therefore our finding concerning Itokawa association is consistent with Nakamura et al. (2011) and Ohtsuka et al. (2011) ascertainments.

#### 4.5 (65803) Didymos association

Didymos group ( $\rho_2/309$ ) was identified by  $D_H$ , and  $\rho_2$  functions with 20, 70 members respectively. One of the most massive objects in the group is Didymos (65803),  $H=17.98^m$ , size 800 [m]. Seventy members of the group were identified by  $\rho_2$  function and  $D_I=0.056566$ . Didymos association asteroids are listed in Table 7, and their orbits are illustrated in Fig. 8.

The minimum, maximum and mean Earth MOIDs of this group are: 0.000293 [au], 0.11116 [au], 0.02112 [au], respectively. The smallest one equals 0.114027 [LD] and was found for

<sup>4</sup> The fireball photographed by the Canadian Meteorite Observation and Recovery Project.



**Figure 8.** Two projections of Didymos (65803) association orbits. Top — the ecliptic projection, bottom — the projection perpendicular to the ecliptic. The group was identified by  $\rho_2$  function, there are 70 orbits. Didymos orbit is in red, the Earth's orbit is in green.

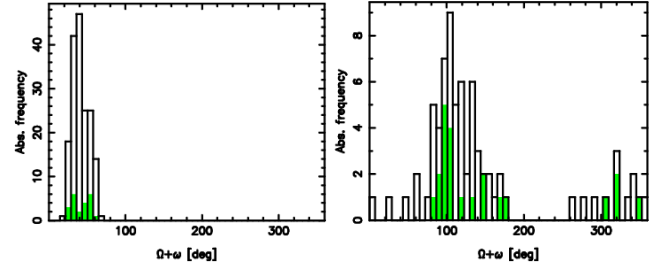
**Table 7.** Didymos (65803) association. 70 members were identified by  $\rho_2$  function, a single linkage cluster analysis algorithm and the orbital similarity threshold  $D_t = 0.056566$ . 31 members of this associations are of Chelyabinsk class.

65803	440212	2000TE2	2001UD18	2005SK26	2005UN
2005WK56	2006UA216	2006UN	2007TA23	2007TT24	2008SV7
2008WF14	2009QZ34	2009RG2	2009WG106	2009WX7	2010RD
2010RF31	2010UO7	2010VA140	2010VQ139	2010VR139	2010VW194
2010WD9	2011QS49	2011UB	2012VB37	2012VL5	2012XH
2013RS43	2013US8	2013XY9	2014WN69	2014WX4	2015SJ17
2015TC179	2015VA1	2015VH1	2015XE	2015XG1	2015XM169
2016PR38	2016RY17	2016SO2	2016TL94	2016UY5	2016VK6
2016WM7	2016WQ1	2017QO17	2017QU1	2017TK4	2017TQ5
2017UQ5	2017UT5	2017VD15	2017VG13	2017XF2	2018BP
2018RQ4	2018SB1	2018TM3	2018TN3	2018VB5	2018VG6
2018VN1	2018XE	2018XX4	2019AS2		

2016WQ1,  $H=27.89^m$ . The theoretical geocentric radiant parameters of this object are  $\alpha_G=284^\circ$ ,  $\delta_G=-22^\circ$  and  $V_G=7.63$  [km/s], the date of possible activity of the radiant is November 18th. Thirty one members of this group meet Chelyabinsk class conditions.

#### 4.6 (225312) Cyclids-SEAs association

We adopted the name Cyclids for the NEAs association from Southworth & Hawkins (1963) who first found a group of five orbits very similar to that of the Earth's among the Super-Schmidt



**Figure 9.** Histograms of longitude of perihelions ( $\varpi = \Omega + \omega$ ) of Toutatis association (left plot, 173 NEAs) and Cyclids-SEAs association (right plot, 73 NEAs). For Cyclids-SEAs group the spread of values is much more considerable and two concentrations of  $\varpi$  are well separated, suggesting that this group consists of two subgroups. The green beans apply to the MOIDs lower than 0.0025 [au].

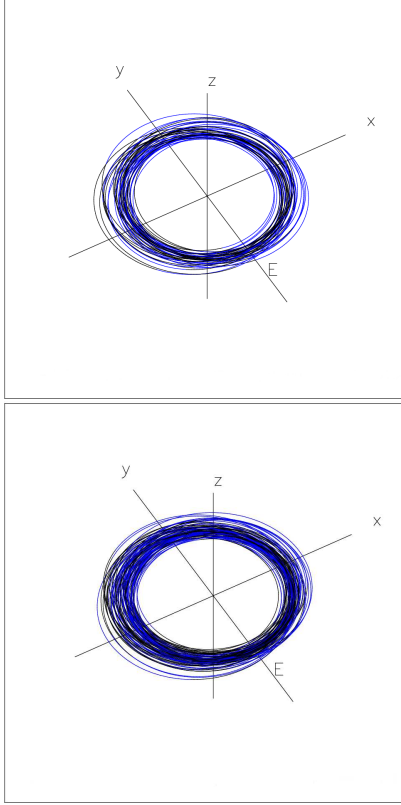
photographic meteoroid data. This discovery was confirmed using larger photographic sample by Lindblad (1971) and Jopek et al. (1999b) and using TV data by Jopek & Froeschlé (1997). Southworth and Hawkins indicated, that the Cyclids are quite probably not a meteoroid stream, e.g. their radiant activity spread was very large — since April to October.

In our basic search (using  $D_H$  and  $D_t=0.047215$ ) we found a group of 73 NEAs orbits very similar to that of Cyclids' meteoroids. Our association is consistent with the group mentioned in Chyba (1993) and Rabinowitz et al. (1993). The authors reported an overabundance of the NEAs moving on orbits similar to the Earth's trajectory and called them small-Earth approachers (SEAs). Rabinowitz et al. (1993) stated that 'most of these SEAs have a diameter  $d < 50$  [m] and are on low-eccentricity, low-inclination orbits and semi-major axis not too deviant from unity'. The sample of SEAs led Rabinowitz et al. (1993) to suggest there is a near-Earth asteroids belt with the majority of members not yet detected. Brassier & Wiegert (2008) selected 13 SEAs and studied their dynamical evolution and calculated the probability of their impact with Earth. It emerged that, except of 3, all remaining SEAs have much higher probabilities of impact than typical NEA, by up to two orders of magnitude.

Cyclids association was found in our previous studies described in Jopek (2011b,a). Using Southworth & Hawkins (1963)  $D_{SH}$  function, and  $D_V$  function defined in Jopek et al. (2008) we found two Cyclids-like groups, (see Table 8 in Jopek 2011b) which partly overlapped with our Cyclids-SEAs group of 73 members. Overlooking the distributions of the longitude of perihelions ( $\varpi = \Omega + \omega$ ) we see that  $\varpi$ -distribution of Cyclids-SEAs differs clearly from that of e.g. the Toutatis group, see Fig. 9. For Cyclids-SEAs, the orientation of the orbit in the plane of motion should be considered less significant. This observation encourages us to be less restrictive when applying the  $D_H$  function. Thus we carried out one more search with a bit higher threshold, namely with  $D_t = 0.0502$ . As a result we identified a group of 129 Cyclids-SEAs ( $D_H/955$ ). The names of the members of this association are listed in Table 8. The association ( $D_H/955$ ) comprises of: 13 Atens, 96 Apollos and 20 Amors; among which we found 29 Chelyabinsk-class objects. The mean MOID value equals 0.015817 [au], the smallest one amounts to 0.000058 [au] (0.022572 [LD]) and the greatest is 0.159817 [au]. The theoretical radiants of this group occupy a big part of the celestial sphere. Their potential activities are possible all year round.

Among our Cyclids-SEAs we found 6 of 13 listed in

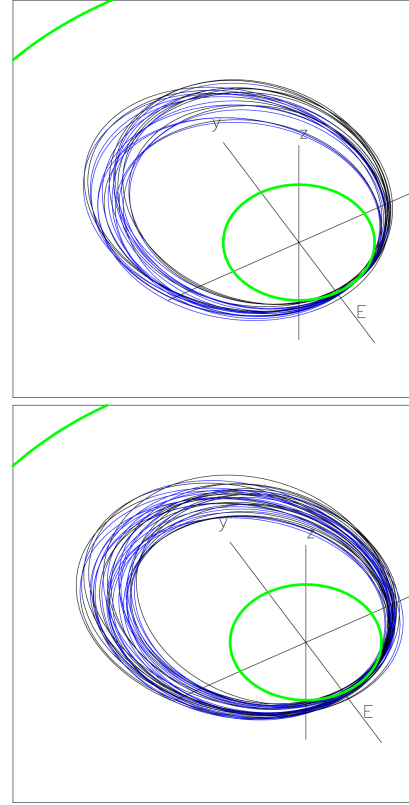




**Figure 10.** Cyclids-SEAs association. Top — 45 orbits observed before AD 2012, bottom — 84 orbits observed between 2012 – 2019. The Earth's orbit is 'immersed' in the association.

**Table 8.** Cyclids-SEAs (225312) association. 129 members were identified by  $D_H$  function, a single linkage cluster analysis algorithm and the orbital similarity threshold  $D_t=0.0502$ . The names of 29 of Chelyabinsk class objects are listed in bold.

225312	478784	1991VG	2000SG344	2001GP2	2001QJ142
2003SM84	2004EO20	2004WH1	2006BU7	2006BZ147	2006Y26
2006RH120	2006UQ216	2007TF15	2007UN12	2007VU6	2008CM74
2008EA9	2008EL68	2008HU4	2008JL24	2008ST	2008TX3
2008UA202	2008VC	2009BD	2009CV	2009DB43	2009OS5
2010AN61	2010JW34	2010TE55	2010UE51	2010VQ98	2011AA37
2011ED12	2011HP24	2011UD21	2012AQ	2012BB14	2012EP10
2012FM35	2012FS35	2012HG2	2012TF79	2012UL171	2012UW68
2012XB112	2012XM55	2013BS45	2013CY	2013DA1	2013EC20
2013GH66	2013LE7	2013RZ53	2013WA44	2013XY20	2014CH13
2014HJ197	2014KD45	2014LJ	2014QN266	2014UV210	2014UY
2014WA366	2014WU200	2014WX202	2014YD	2015DU	2015JD3
2015KE	2015KK57	2015PL57	2015PS228	2015TC25	2015VC2
2015VO142	2015XZ378	2016CF137	2016GK135	2016GL222	2016JB18
2016RD34	2016TB18	2016TB57	2016UE	2016WD7	2016WQ3
2016YR	2017BG30	2017BN93	2017CF32	2017FB157	2017FF3
2017FJ3	2017FL64	2017FT102	2017FW90	2017KP27	2017RL2
2017RP2	2017SV19	2017TA6	2017TP4	2017UY4	2017YK14
2017YS1	2018AJ3	2018BC	2018BJ6	2018CQ3	2018CU14
2018DT	2018LQ2	2018PM28	2018PU23	2018TG6	2018UE1
2018VO9	2018WV1	2019AH13	2019AU	2019FV2	2019FY1
2019GF1	2019GK3	2019GL1			



**Figure 11.** 58 orbits of the 1994GV association were identified using  $D_H$  function and  $D_t = 0.047529$ . Top — 23 orbits observed before AD 2012, bottom — 35 orbits observed between 2012–2019. The potential bolide activity of this group ranges from February, 2nd to April, 14th. The Earth's orbit and small arc of Jupiter's orbit are plotted in green.

Brasser & Wiegert (2008), however it should be noted that, to select the SEA, Brasser & Wiegert (2008) used the criteria:  $a \in [0.95, 1.05]$  [au],  $e \in [0, 0.1]$  and  $i \in [0, 10^\circ]$  that are essentially different than those applied in our study.

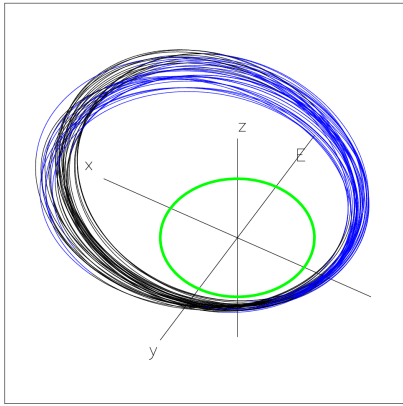
Additionally we discovered all 5 members of the C3 group identified by Schunová et al. (2012) among our Cyclids-SEAs. We do not consider the Cyclids-SEAs group as a family of NEAs. We simply report that in our study all members of C3 group belong to the most numerous association.

#### 4.7 1994GV association

This group ( $D_H/2834$ ) was found with  $D_H$  and  $D_t=0.047529$ . 58 orbits resemble those of meteoroid stream (see Fig. 11). Using  $\rho_1$  metric only 4 NEAs proved to be members of this group. The MOIDs of the orbits amount to 0.000420, 0.027421, 0.156182 [au] — the minimal, mean and maximal, respectively. The smallest MOID is 0.163452 [LD] and was found for 1994GV ( $H=27.35^m$ , size 11 [m]), the radiant parameters of this asteroid are:  $\alpha_G=69^\circ$ ,  $\delta_G=24^\circ$  and  $V_G=8.41$  [km/s], the date of possible activity is April, 14th. The most massive member of this association is 2012XY6, its absolute brightness and size amount to  $19.09^m$ , 500 [m]. The names of the association members are listed in Table 9; 34 of them belong to Chelyabinsk class.

**Table 9.** 1994GV association. 58 members were identified by  $D_H$  function and a single linkage cluster analysis algorithm. The 34 members of Chelyabinsk class are in bold.

1994GV	2007BC8	2007BZ48	2008CF	2008EW5	2008FL7
2008GE128	2009BA11	2009BG81	2009CD2	2009CV5	2009DN45
2009DW	2009FQ	2009FR	2010GL65	2011BE24	2011BV10
2011CZ6	2011FQ16	2012DW32	2012FM	2012FQ52	2012XO111
2012XY6	2013DS9	2013ER	2013GD55	2014CB13	2014DP21
2014HK196	2014HZ164	2015AZ43	2015CQ13	2015CS	2015DD54
2015EP	2015FX35	2015HW11	2016CB138	2016CJ30	2016GD2
2016GF1	2016GL134	2017BX6	2018CF3	2018CG3	2018CH2
2018FN3	2018GN1	2018HD1	2018XQ4	2019BD3	2019BH3
2019CP4	2019ET2	2019GD4	2019GS5		



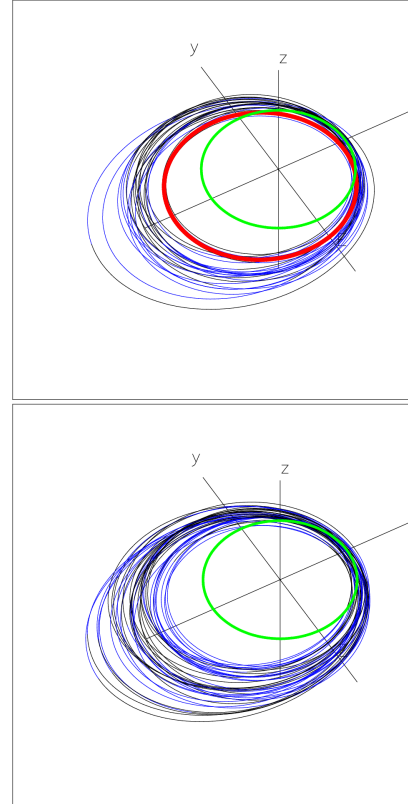
**Figure 12.** 38 orbits of (243147) association were identified with  $D_H$  function and  $D_t = 0.046288$ . Possible activities of the radiant of this association range from July, 12th until August, 12th. The Earth's orbit is plotted in green.

**Table 10.** (243147) association. 38 members were identified by  $D_H$  function and a single linkage cluster analysis algorithm.

243147	436035	436094	439889	2003NB	2006QB58
2007PQ	2009MC9	2010RD31	2011NZ	2011OC57	2011PU
2011PX	2012PO17	2013MX5	2013OT3	2014MK6	2014PR62
2015PQ56	2015RX2	2016ND33	2016ND56	2016NH15	2016NH22
2016NT32	2016NW32	2016PH1	2016RF17	2016TD10	2016TX1
2016UX25	2017MB4	2017RF15	2017RT15	2018ME7	2018PX7
2018RR3	2018TU2				

**4.8 (243147) association**

This group ( $D_H/1007$ ) of 38 NEAs was found with  $D_H$  and  $D_t = 0.046288$ . The dominant body is (243147), its absolute brightness and size are  $17.25^m$  and 112 [m]. The orbits resemble meteoroid stream (see Fig. 12), however they did not approach the Earth orbit closely. The minimal, mean and maximal MOIDs amount to 0.078342, 0.187735 and 0.289566 [au]. The minimal MOID (30.488 [LD]) was found for 2015PQ56 asteroid ( $H=22.56^m$ , diameter  $D=110$  [m]). The corresponding radiant parameters are  $\alpha_G=203^\circ$ ,  $\delta_G=-50^\circ$  and  $V_G=6.48$  [km/s], the date of possible activity of the radiant is August, 12th. The names of the NEAs falling into this association are listed in Table 10. No member of the group belongs to Chelyabinsk class.



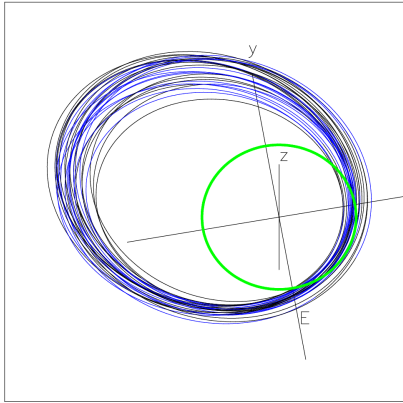
**Figure 13.** 69 orbits of 1999TV16 association were identified with  $\rho_2$  function and  $D_t = 0.056485$ . Top — 27 orbits observed before AD 2012, bottom — 42 orbits observed between 2012 – 2019. The potential bolide activity of this group ranges from October, 7th to February, 8th. The red orbit corresponds to 2008TC3 which entered the Earth's atmosphere on October, 7th 2008. It was the first predicted and observed collision of the NEA with our planet. The Earth's orbit is plotted in green color.

**4.9 1999TV16 association**

The group of 69 NEAs ( $\rho_2/3041$ ) was found using  $\rho_2$  distance function and the threshold  $D_t = 0.056485$ . 1999TV16 is a small object with a diameter of 90 [m] and absolute magnitude  $H = 23.40^m$ . Fig. 13 presents two plots of the group's orbit, one for 27 objects discovered before 2012 and the other for 42 objects discovered since 2012. It is easy to agree the drawings represent the same asteroid stream. The orbits approach the Earth's orbit quite closely, the minimal, mean and maximal MOIDs are 0.000031, 0.02011 and 0.11531 [au], respectively. The smallest MOID (0.012 [LD]) corresponds to 2008TC3, the radiant parameters are  $\alpha_G = 348^\circ$ ,  $\delta_G = 8^\circ$  and  $V_G = 6.69$  [km/s], the date of possible activity of the radiant is October 7th. The members' names are listed in Table 11. The asteroid 2008TC3 was a very small 4.1 [m] size object observed only during 1 day in 2008. On October 7th, it entered the Earth's atmosphere and exploded above the Nubian Desert in Sudan. The impact had been predicted prior to its entry into the atmosphere as a meteor. A few hundred meteorites, collectively named Almahata Sitta, were recovered by Peter Jenniskens, with help from students and staff of the University of Khartoum, (see Jenniskens et al. 2009a,b). The case of 2008TC3 shows that the existence of NEAs associations in close proximity to Earth may be a real threat to its inhabitants.

**Table 11.** 1999TV16 association. 69 members were identified by  $\rho_2$  function and a single linkage cluster analysis algorithm. The group has 24 members meeting Chelyabinsk class criteria. Their names are in bold.

1999TV16	2001AV43	2003YT70	2005WF55	2006XQ4	2006XY
2006YH2	2007DC	2007TX22	2008TC3	2008VA15	2008WM61
2009BF58	2009RH	2009UK14	2009WK1	2009WV7	2010AR1
2010DL	2010VO21	2010WW8	2010XC	2010XF64	2010XG64
2011BY10	2012BA102	2012BU1	2012VJ38	2012XN134	2013AC
2013AC53	2013AP20	2013VO4	2013VX4	2014AE5	2014AE16
2014CS13	2014SH224	2014UW57	2014WE121	2015DD1	2015VH2
2015VR64	2015VV2	2015WK	2015XN	2016AN66	2016BF1
2016DK1	2016TA11	2016TG55	2016UB107	2016UN36	2016WZ8
2017AD21	2017BG92	2017ST19	2017VV12	2017XR60	2017YD
2017YF8	2017YR3	2017YR4	2018BD5	2018VX1	2019BO
2019CR1	2019CV1	2019CZ2			



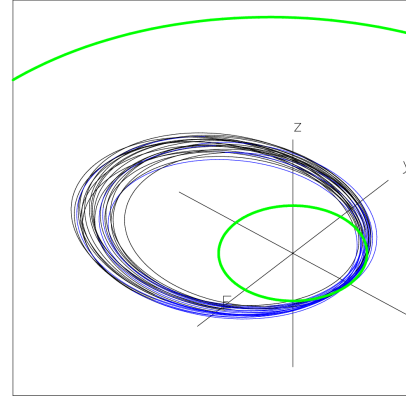
**Figure 14.** 30 orbits of 2000BH19 association were identified using  $\rho_2$  and  $D_H$  functions. The configuration of orbits resembles a meteoroid stream. The Earth's orbit is plotted in green color.

**Table 12.** Association 2000BH19. 30 members were identified by  $\rho_2$  function and a single linkage cluster analysis algorithm. 16 members fall into Chelyabinsk class.

2000BH19	2003XV	2006AH4	2006WM3	2009FG	2010XN69
2011WS95	2011YB63	2012VO6	2014AZ32	2014DK23	2014FX6
2014YD15	2015FU344	2015XV384	2016CW246	2016XA	2016XK
2016XV17	2017BN92	2017WH13	2018BE3	2018FL29	2018GV3
2018PU24	2018UQ1	2018VV1	2018VX6	2018WE	2019AB5

#### 4.10 2000BH19 association

The group of 30 orbits ( $\rho_2/3065$ ) was found with  $D_H$  and  $\rho_2$  functions, the thresholds were 0.045382 and 0.054300, respectively. The dominant member is 2000BH19 with an absolute magnitude  $H = 19.36^m$ , and diameter 400 [m]. The orbits resemble a compact meteoroid stream, see Fig. 14. The minimal, mean and maximal MOIDs of this group are: 0.000280, 0.022864, 0.157994 [au]. The smallest MOID, 0.108968 [LD], was found for 2018FL29,  $H = 30.07^m$ . The theoretical radiant parameters of this object are  $\alpha_G = 38^\circ$ ,  $\delta_G = 15^\circ$  and  $V_G = 11.91$  [km/s], the date of possible activity is November, 21st. The association members are listed in Table 12. 16 members are of Chelyabinsk class.



**Figure 15.** 24 orbits of (523606) association were identified with  $\rho_1$  function and  $D_t = 0.049453$ . The potential bolide activity of this group ranges from October 9th, to January 13th. The Earth's orbit is in green color.

**Table 13.** (523606) association. 24 members were identified by  $\rho_1$  function and a single linkage cluster analysis algorithm. 14 NEAs in bold, belong to Chelyabinsk class.

523606	1993TZ	2003SS84	2006BN26	2007UF6	2007UU3
2007VD184	2009UL28	2009UW87	2011WQ4	2012CU	2013BD74
2013UE1	2014SC324	2015BP513	2016XA21	2017AP4	2017TH5
2017TZ3	2017UU2	2018BQ5	2018UA	2018VD5	2018VR1

#### 4.11 (523606) association

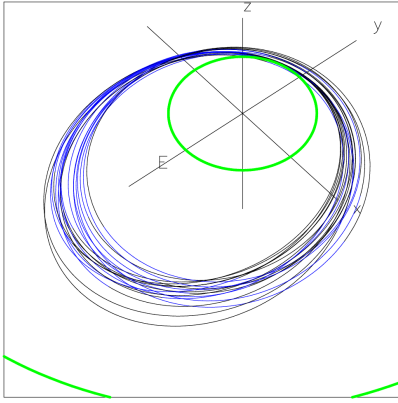
8 members of (523606) association were identified using  $D_H$  function and  $D_t = 0.034668$ . A similar result was obtained with  $\rho_2$  and  $D_t = 0.044688$  where 11 objects were found. However, using  $\rho_1$  and  $D_t = 0.049453$ , 24 NEAs were classified as an association ( $\rho_1/2710$ ). (523606) asteroid is the biggest and brightest object in this group,  $H=20.23^m$ ,  $D = 300$  [m]. The spatial distribution of this cluster's orbits resembles a meteoroid stream, see Fig. 15.

All orbits approach the Earth's orbit at a distance smaller than 0.05 [au] (PHA limit); the minimal, mean and maximal MOIDs are: 0.000049, 0.019069, 0.026283 [au]. The smallest MOID was found for 2018UA,  $H = 30.15^m$ . The theoretical radiant parameters of this object are  $\alpha_G=354^\circ$ ,  $\delta_G=18^\circ$  and  $V_G=11.92$  [km/s], the date of possible activity is October, 20th. In [LD] unit 2018UA MOID=0.019069, which equals 1.15 of the Earth's radius.

Table 13 lists the names of 24 members of the group, 14 of them belong to Chelyabinsk class.

#### 4.12 2000SE8 association

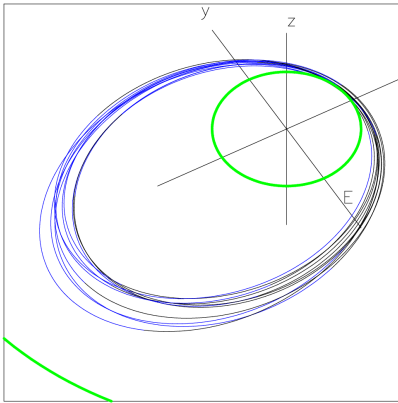
Twenty orbits were found with  $\rho_1$  function and  $D_t = 0.048248$  ( $\rho_1/3137$ ). The NEAs of this group are rather small objects; one of the dominant members is 2000SE8 with absolute magnitude  $H=22.9^m$ , and size 60 [m]. The orbits resemble a meteoroid stream, see Fig. 16. The minimal, mean and maximal MOIDs of this group are: 0.000257, 0.045534, 0.129974 [au]. The smallest MOID (0.10017 [LD]) we found for 2015SG asteroid,  $H=26.43^m$ . The theoretical radiant parameters of this object are  $\alpha_G=232^\circ$ ,  $\delta_G=-21^\circ$  and  $V_G=7.77$  [km/s], the date of possible activity is September, 5th. The group's members are listed in Table 14, half of them are of Chelyabinsk class.



**Figure 16.** 20 orbits of 2000SE8 association were identified using  $\rho_1$  function. The configuration of orbits resembles a meteoroid stream. The Earth's and Jupiter's orbits are plotted in green color.

**Table 14.** 2000SE8 association. 20 members were identified by  $\rho_1$  function and a single linkage cluster analysis algorithm. The names of 10 Chelyabinsk-class objects are in bold.

2000SE8	2007RR17	2009SM1	2010RB130	2010RC31	2010RQ64
2011OE	2011QH50	2014SS1	2015RO35	2015RZ36	2015SG
2016NJ39	2016NR55	2016PG	2016RV19	2017PD25	2017QS32
2017SB12	2018QR				



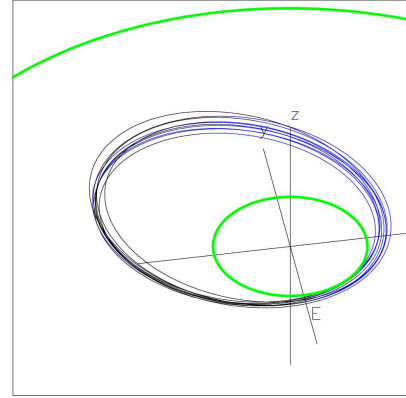
**Figure 17.** 11 orbits of the 1999YD association were identified using  $D_H$  and  $\rho_1$  function. The configuration of the orbits resembles a compact meteoroid stream. The Earth's and Jupiter's orbits are plotted in green.

#### 4.13 1999YD association

We obtained the exact same result using  $D_H$  and  $\rho_1$  functions, 11 orbits of this association ( $D_H/3058$ ) were found with the thresholds 0.037268 and 0.043102, respectively. The largest member of this group is 1999YD,  $H = 21.12^m$ , size 200 [m]. The association clearly resembles a compact meteoroid stream, see Fig. 17. The orbits approach the Earth's orbit closely; the minimal, mean and maximal MOIDs are: 0.000342, 0.032855, 0.083527 [au]. The smallest MOID (0.133096 [LD]) was found for 2007YM,  $H = 26.06^m$ . The theoretical radiant parameters of this object are  $\alpha_G = 351^\circ$ ,  $\delta_G = -9^\circ$  and  $V_G = 8.34$  [km/s], the date of possible activity is November, 21st. The association members are listed in Table 15, 6 of them are of Chelyabinsk class.

**Table 15.** 1999YD association. 11 members were identified by  $D_H$  and  $\rho_1$  functions and a single linkage cluster analysis algorithm. 6 NEAs meet the criteria of Chelyabinsk class.

1999YD	2000WM10	2003UW5	2004YE	2007YM	2008UT5
2008YW32	2016WV2	2017UT7	2018TS	2018VQ6	



**Figure 18.** 10 orbits of 1996GQ association were identified using only  $\rho_1$  function; the applied orbital similarity threshold was  $D_t = 0.043102$ . The configuration of the orbits clearly resembles a meteoroid stream. The Earth's and Jupiter's orbits are plotted in green.

**Table 16.** 1996GQ association. 10 members were identified by  $\rho_1$  function,  $D_t = 0.043102$ , and a single linkage cluster analysis algorithm. 3 asteroids in bold meet the criteria of Chelyabinsk class.

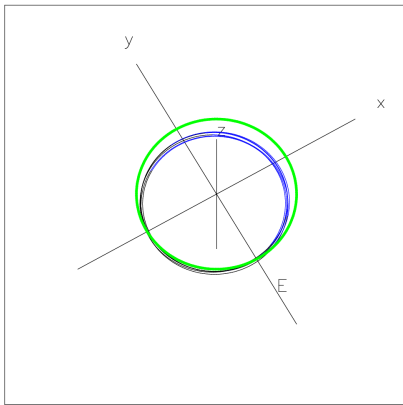
1996GQ	1999FQ10	2012FO52	2013DX	2014ES3	2016CY193
2016DM2	2017BL123	2017EJ4	2019CT		

#### 4.14 1996GQ association

The group consists of 10 orbits and was found using only  $\rho_1$  function and  $D_t = 0.043102$  (internal code is  $\rho_1/2870$ ). The brightness of 1996GQ asteroid is  $23.17^m$ , and its size equals 210 [m] (with assumed albedo of 0.024). The orbits clearly resemble those of a meteoroid stream, see Fig. 18. The minimal, mean and maximal MOIDs of this group are: 0.008514, 0.062156, 0.134925 [au]. The smallest MOID (3.313396 [LD]) was found for 2009FQ10,  $H=25.51^m$ . The theoretical radiant parameters of this object are  $\alpha_G=46^\circ$ ,  $\delta_G=11^\circ$ ,  $V_G=6.11$  [km/s] and the date of possible activity is February, 13th. The association members are listed in Table 16, 3 objects belong to Chelyabinsk class.

#### 4.15 2014FW32 association

The group ( $\rho_1/10793$ ) consists of 6 orbits, it was found using  $\rho_1$  and  $\rho_2$  functions, the thresholds were  $D_t=0.037021$  and  $D_t=0.036307$ . The NEA 2014FW32 absolute magnitude is  $26.98^m$  and its diameter is 15 [m]. The orbits resemble those of a meteoroid stream, see Fig. 19, similar to Cyclids-SEAs association, but all the orbits are within the Earth's orbit. All 6 members belong to the Aten group. The minimal, mean and maximal MOIDs of this association are: 0.000702, 0.007543, 0.015019 [au]. The smallest MOID (0.273198 [LD]) we found for 2018GR4,  $H=27.08^m$ .



**Figure 19.** A group of 6 orbits of 2014FW32 association was identified using  $\rho_1$  and  $\rho_2$  functions. The orbits resemble Cyclids-SEAs association and are located inside the Earth's orbit, the biggest ellipse marked in green.

**Table 17.** 2014FW32 association. 6 members were identified by  $\rho_1$  and also by  $\rho_2$  functions. A single linkage cluster analysis algorithm was applied. The name of the Chelyabinsk-class asteroid is in bold.

2014FW32	2014HN2	2016HF19	2017HK1	2018GE	2018GR4
----------	---------	----------	---------	--------	---------

The theoretical radiant parameters of this object are  $\alpha_G=328^\circ$ ,  $\delta_G=-25^\circ$  and  $V_G=2.54$  [km/s], the date of possible activity is March 11th. The members of this association are listed in Table 17. Only one asteroid of this group belongs to Chelyabinsk class.

## 5 CONCLUSIONS

We have made three attempts at extensive and very rigorous search for grouping among 20032 NEAs. The probability of accidental clustering was small, below 1%. Fifteen associations were found using a single linkage cluster analysis algorithm, the same one Zappala et al. (1990) used in search for asteroid families among the main belt asteroids (MBA). Zappala et al. called this algorithm a hierarchical cluster analysis algorithm. In our search only 953 orbits ( $\sim 4.7\%$ ) were classified as association members.

To quantify the similarity among the two orbits we applied three distance functions:  $D_H$ ,  $\rho_1$  and  $\rho_2$ . Both  $\rho$ -functions proposed recently by Kholshchevnikov et al. (2016) worked well, they provided results comparable with those obtained by  $D_H$  function (Jopek 1993b). Thus, in our view, the new functions do not constitute a major breakthrough in small bodies cluster analysis. However, from the mathematical point of view, they have the obvious advantage — they satisfy three axioms of a metric space. Therefore, they must be applied at the first place.

All orbital plots of the identified associations clearly resemble meteoroid streams, see Figures 4–8 and 10–19. However, we do not claim that our associations are of genetic nature, i.e. that they originated from a common parent body. No cluster analysis can prove it. We only claim, that despite of their origin, the identified associations do exist. At the moment no one knows how many NEAs a single group includes. It could be 70 members, but perhaps it contains 700? We showed that the number of members identified in an association increases with time, as was the case for Anza, Zephyr,

Toutatis, Itokawa and other large groups. This is an important fact if the probability of the collision between the Earth and the NEAs is to be calculated. The threat to the Earth and its inhabitants is very serious. Among the members of the identified associations we found many members, on average 34 %, which are larger than the Chelyabinsk object and which approach the Earth's orbit at a distance smaller than 0.05 [au] (PHA limit). Two asteroids in these associations approached the Earth's orbit at extremely close distances, smaller than the Earth's radius, are: 2017FU102 (a member of the Itokawa association) and 2008TC3 (a member of 1999TV16 association). The latter object entered the Earth's atmosphere on October 7 2008 and exploded at  $\sim 37$  [km] above the Nubian Desert in Sudan, (Jenniskens et al. 2009b).

The common origin of the members of the identified groups is an open question. They could have emerged as a result of collisions (e.g. Itokawa and Toutatis associations) or as a result of migration processes induced by some dynamical resonances. Further investigations are needed on the number and the nature of the NEAs associations.

## ACKNOWLEDGEMENTS

The author acknowledges the anonymous referee for the comments and suggestions. T.J. Jopek was supported by the National Science Center in Poland (project No 2016/21/B/ST9/01479). This research has made use of NASA's Astrophysics Data System Bibliographic Services.

## REFERENCES

- Asher D. J., Clube S. V. M., Steel D. I., 1993, *MNRAS*, **264**, 93
- Brasser R., Wiegert P., 2008, *MNRAS*, **386**, 2031
- Chyba C. F., 1993, *Nature*, **363**, 701
- De la Fuente Marcos C., De la Fuente Marcos R., 2016, *MNRAS*, **456**, 2946
- Drummond J. D., 1991, *Icarus*, **89**, 14
- Drummond J. D., 2000, *Icarus*, **146**, 453
- Dybczynski P. A., Jopek T. J., Serafin R. A., 1986, *Celestial Mechanics*, **38**, 345
- Fu H., Jedicke R., Durda D. D., Fevig R., Scotti J. V., 2005, *Icarus*, **178**, 434
- Huang J., et al., 2013, *Scientific Reports*, **3**, 3411
- Jenniskens P. M. M., Shaddad M. H., Numan D., Kudoda A. M., Almahata Sitta Consortium 2009a, in AAS/Division for Planetary Sciences Meeting Abstracts #41. AAS/Division for Planetary Sciences Meeting Abstracts. p. 9.01
- Jenniskens P., et al., 2009b, *Nature*, **458**, 485
- Jopek T. J., 1986, PhD thesis, Astronomical Observatory, Physics Department, A.M. University, Poznan, Poland
- Jopek T. J., 1993a, in Stohl J., Williams I. P., eds, Meteoroids and their Parent Bodies. pp 269–272
- Jopek T. J., 1993b, *Icarus*, **106**, 603
- Jopek T. J., 2011a, in EPSC Abstracts, vol. 6, EPSC-DPS2011-15, 2011. p. 15
- Jopek T. J., 2011b, *Mem. Soc. Astron. Italiana*, **82**, 310
- Jopek T. J., 2015, *Highlights of Astronomy*, **16**, 474
- Jopek T. J., 2019, in Astronomy in Focus – XXX, Proceedings IAU Symposium No. XXX, 2019, ed. M.T. Lago. p. 25
- Jopek T. J., Bronikowska M., 2017, *Planet. Space Sci.*, **143**, 43
- Jopek T. J., Froeschlé C., 1997, *A&A*, **320**, 631
- Jopek T. J., Valsecchi G. B., Froeschle C., 1999a, in Baggaley W. J., Porubcan V., eds, Meteoroids 1998. pp 307–310
- Jopek T. J., Valsecchi G. B., Froeschle C., 1999b, *MNRAS*, **304**, 751
- Jopek T. J., Valsecchi G. B., Froeschlé C., 2003, *MNRAS*, **344**, 665
- Jopek T. J., Rudawska R., Bartczak P., 2008, *Earth, Moon, and Planets*, **102**, 73
- Kholshchevnikov K. V., Kokhirova G. I., Babadzhanyan P. B., Khamroev U. H., 2016, *MNRAS*, **462**, 2275

- Kresak L., 1982, Bulletin of the Astronomical Institutes of Czechoslovakia, [33, 150](#)
- Lindblad B. A., 1971, Smithsonian Contributions to Astrophysics, [12, 1](#)
- Lindblad B. A., 1994, in Kozai Y., Binzel R. P., Hirayama T., eds, Astronomical Society of the Pacific Conference Series Vol. 63, 75 Years of Hirayama Asteroid Families: The Role of Collisions in the Solar System History. p. 62
- Nakamura T., et al., 2011, [Science, 333, 1113](#)
- Ohtsuka K., Abe S., Ito T., Nakamura T., Abe M., Yano H., Watanabe J.-I., 2011, [PASJ, 63, L73](#)
- Öpik E. J., 1971, Irish Astronomical Journal, [10, 35](#)
- Popova O. P., et al., 2013, [Science, 342, 1069](#)
- Press W. H., Teukolsky S. A., Vetterling W. L., Flannery B. P., 2002, Numerical Recipes in C, 2nd ed. Cambridge University Press
- Rabinowitz D. L., et al., 1993, [Nature, 363, 704](#)
- Schunová E., Granvik M., Jedicke R., Gronchi G., Wainscoat R., Abe S., 2012, [Icarus, 220, 1050](#)
- Sekanina Z., 1976, [Icarus, 27, 265](#)
- Sitarski G., 1964, Acta Astron., [14, 25](#)
- Southworth R. B., Hawkins G. S., 1963, Smithsonian Contributions to Astrophysics, [7, 261](#)
- Steel D., 1994, in Kozai Y., Binzel R. P., Hirayama T., eds, Astronomical Society of the Pacific Conference Series Vol. 63, 75 Years of Hirayama Asteroid Families: The Role of Collisions in the Solar System History. p. 97
- Steel D. I., Asher D. J., Clube S. V. M., 1993, in AAS/Division for Planetary Sciences Meeting Abstracts #25. p. 32.06
- Valsecchi G. B., Jopek T. J., Froeschlé C., 1999, [MNRAS, 304, 743](#)
- Whipple F. L., 1977, [Icarus, 30, 736](#)
- Williams I. P., Jopek T. J., Rudawska R., Tóth J., Kornoš L., 2019, Minor Meteor Showers and the Sporadic Background. Cambridge University Press, p. 210
- Zappala V., Cellino A., Farinella P., Knezevic Z., 1990, [AJ, 100, 2030](#)

This paper has been typeset from a  $\text{\TeX}/\text{\LaTeX}$  file prepared by the author.