

Continuous variable direct secure quantum communication using Gaussian states

Srikara S^{¶,*}, Kishore Thapliyal^{§,†}, Anirban Pathak^{||,‡}

[¶]Indian Institute of Science Education and Research, Pune, India

[§]RCPTM, Joint Laboratory of Optics of Palacky University and Institute of Physics of Academy of Science of the Czech Republic, Faculty of Science, Palacky University, 17. listopadu 12, 771 46 Olomouc, Czech Republic

^{||}Jaypee Institute of Information Technology, A-10, Sector-62, Noida, UP-201309, India

Abstract

Continuous variable one-way and controlled-two-way secure direct quantum communication schemes have been designed using Gaussian states. Specifically, a scheme for continuous variable quantum secure direct communication and another scheme for continuous variable controlled quantum dialogue are proposed using single-mode squeezed coherent states. The security of the proposed schemes against a set of attacks (e.g., Gaussian quantum cloning machine and intercept resend attacks) has been proved. Further, it is established that the proposed schemes do not require two-mode squeezed states which are essential for a set of existing proposals. The controlled two-way communication scheme is shown to be very general in nature as it can be reduced to schemes for various relatively simpler cryptographic tasks like controlled deterministic secure communication, quantum dialogue, quantum key distribution. In addition, it is briefly discussed that the proposed schemes can provide us tools to design quantum cryptographic solutions for several socioeconomic problems.

1 Introduction

The advantages of quantum resources and principles of quantum mechanics in the field of quantum technology are the focus of the second quantum revolution [1]. The first set of applications of quantum mechanics was proposed in secure quantum communication with the feasibility of a quantum key distribution protocol [2], where security does not rely on the complexity of the computational task. This was followed by several quantum key distribution and other cryptographic schemes (see [3–5] for review). Specifically, quantum resources ensure secure transmission of a message without requiring key transmission known as quantum secure direct communication (QSDC) [6–8] and deterministic secure quantum communication (DSQC) [9]. DSQC (QSDC) requires an (no) additional classical communication to decode the message [4, 9]. Bidirectional and controlled variants of these schemes have been proposed subsequently [10, 11].

Independent of these initial discrete variable (DV) quantum cryptography schemes, a set of continuous variable (CV) secure quantum communication schemes have also been proposed. Information is encoded on quadratures in CV communication schemes. The encoded information is decoded later by homodyne or heterodyne detection (see [12–14] for review). Most of the initial CV cryptography schemes used Gaussian states, like squeezed [15, 16], Einstein-Podolsky-Rosen correlated [17], and coherent [18–20] states. However, schemes using non-Gaussian states have also been proposed since then ([21] and references therein). CV quantum communication is preferred over corresponding DV counterpart due to the possibility of its implementation without requiring single photon source and/or detector, better performance for metropolitan networks which can be performed using existing optical communication technology.

Motivated by the advantages of CV communication in general, CV schemes are proposed recently for QSDC [22, 23], DSQC [24], quantum dialogue (QD) [25, 26], multiparty QD [22, 27, 28], controlled quantum dialogue (CQD) [29]. Several types of CV quantum key distribution schemes have also been designed ([21] and references therein). Inspired by these works and our recent results [29–34] which established that several direct quantum communication schemes may be useful in providing quantum solutions to secure multiparty computation tasks [35], here we propose a CV QSDC and a CV CQD schemes. Specifically, it is already established that several socioeconomic problems can be defined as secure multiparty computation tasks, such as voting [30], sealed-bid auction [32], socialist millionaire problem [29], and private comparison [33]. In fact, some of the present authors have proposed a CV CQD scheme using two-mode squeezed state [29] and used it as primitive for quantum solution for the socialist millionaire problem. Squeezed and entangled states for quantum communication may

*Email: srikara.s@students.iiserpune.ac.in

†Email: kishore.thapliyal@upol.cz

‡Email: anirban.pathak@jiit.ac.in

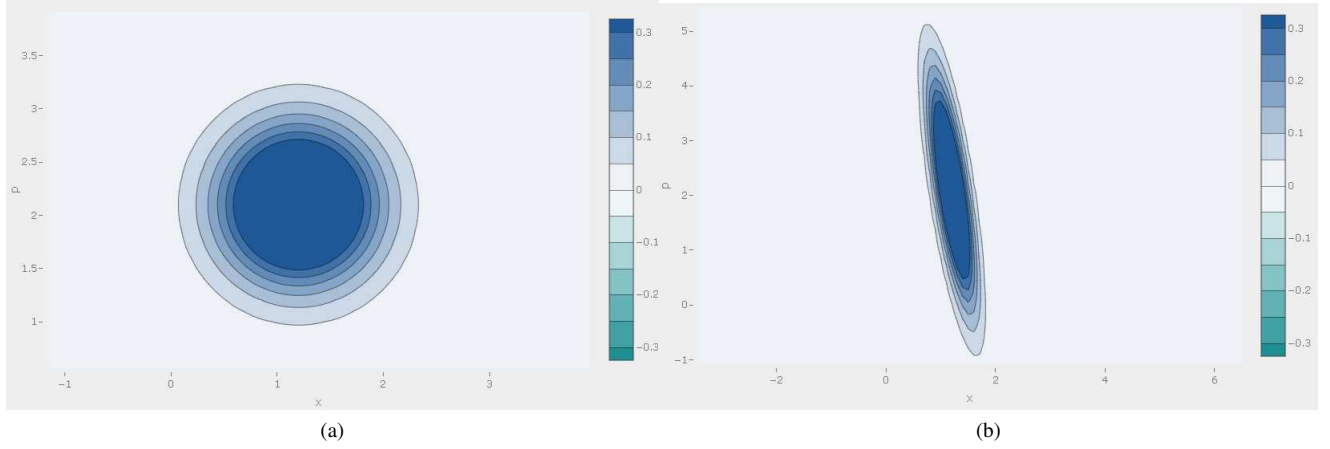

Figure 1: (Color online) Wigner function of a (a) coherent state $|\alpha\rangle$ and (b) squeezed coherent state $S(s)|\alpha\rangle$ with $s = e^{0.3i}$ with $\alpha = 1.2 + i2.1$. These plots are generated using [45].

be generated in different systems and optical processes [36–42]. These works and the fact that single-mode Gaussian states are easy to prepare, justify the need for designing new schemes for secure direct quantum communication using these states. In the rest of the paper, we have tried to design such schemes using squeezed coherent states.

The rest of this paper is structured as follows. In Section 2, we introduce some basic concepts of quantum optics required to explain the CV QSDC and CV CQD schemes (given in Section 3). In Section 4, we analyze the security of the proposed protocols. Finally, the paper concludes in Section 5.

2 Preliminaries

Coherent states $|\alpha\rangle$ of the radiation field are the eigenstates of the annihilation operator \hat{a} with a complex eigenvalue α , also called the amplitude of $|\alpha\rangle$. A coherent state can also be described in terms of the displacement operator $D(\alpha)$ as [43]

$$|\alpha\rangle = D(\alpha)|0\rangle = e^{\alpha\hat{a}^\dagger - \alpha^*\hat{a}}|0\rangle. \quad (1)$$

Interestingly, the displacement operator acting on a coherent state would give another coherent state [43]

$$D(\beta)|\alpha\rangle = |\beta + \alpha\rangle. \quad (2)$$

Further, an arbitrary quantum state ρ can also be described by a quasiprobability distribution in phase space, such as Wigner function [44]

$$W(\gamma) = \frac{1}{\pi^2} \int d^2z \text{Tr}[\rho D(z)] e^{-(z\gamma^* - z^*\gamma)}. \quad (3)$$

It can be easily verified that the Wigner function of a coherent state $|\alpha\rangle$ is obtained as a Gaussian distribution peaked at $\gamma = \alpha$ (cf. Fig. 1 (a)).

The real part q and the imaginary part p of the eigenvalue $\alpha = q + ip$ give values for the position and momentum quadratures, respectively. These quadratures can be measured by two methods, namely by homodyne and heterodyne detection. These methods are useful in quantum optical tomography, too [46, 47]. Homodyne detection is used to measure one of the quadratures, whereas heterodyne detection helps in measuring both the quadratures. However, Heisenberg's uncertainty principle restricts precise measurement of both the quadratures in heterodyne measurement.

Additionally, the squeezing operator is defined as

$$S(s) = e^{\frac{1}{2}(s^*\hat{a}^2 - s\hat{a}^{\dagger 2})}, \quad (4)$$

where squeezing parameter $s = re^{i\theta}$. A coherent state gets squeezed after application of the squeezing operator which reduces the variance along one direction depending upon squeezing phase parameter at the cost of increase in variance in the perpendicular direction (cf. Fig. 1 (b)). Therefore, α cannot be determined accurately using homodyne/heterodyne detection in the absence of knowledge about s . Note that the squeezing and displacement operators do not commute, and thus

$$S(s)D(\alpha) = D(\beta)S(s), \quad (5)$$

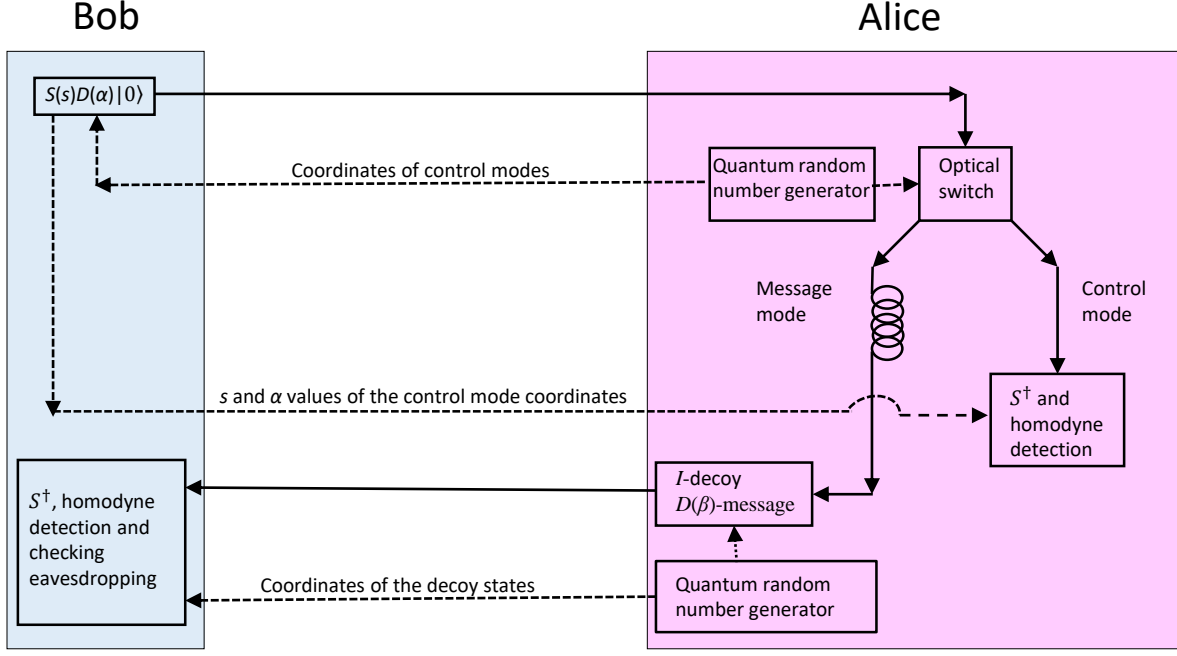

Figure 2: (Color online) Schematic diagram of the QSDC protocol.

where

$$\beta = \alpha \cosh(r) + e^{i\theta} \alpha^* \sinh(r) \quad (6)$$

and

$$\alpha = \beta \cosh(r) - e^{i\theta} \beta^* \sinh(r). \quad (7)$$

This brief description of the preliminaries enables us to propose the protocols for CV QSDC and CV CQD that we aim to design in this work. The next section describes the protocols.

3 The protocols

Before we describe the cryptographic schemes, we briefly discuss the encoding scheme. The encoding scheme is as follows: The real line is divided into 8 parts: $(-\infty, -3)$, $(-3, -2)$, \dots , $(i, i+1)$, \dots , $(2, 3)$, and $(3, \infty)$. These parts represent the binary numbers 000, 001, 010, 011, 100, 101, 110 and 111, respectively [25, 29]. The message is encoded by choosing a random real number r from the corresponding interval and applying the displacement operator $D(\beta)$ on the incoming state where $\beta = r + ir$. Here it may be noted that the sender need not know which quadrature is squeezed. Consequently, she/he should encode the same message on both the quadratures.

3.1 Quantum secure direct communication (QSDC) protocol

The QSDC protocol (shown schematically in Fig. 2) works as follows

1. Bob generates n random complex numbers in a string R_d and labels them $\alpha_1, \alpha_2, \dots, \alpha_n$. He then randomly chooses n more complex numbers s_1, s_2, \dots, s_n in a string R_s . He subsequently uses both these strings R_d and R_s to prepare the squeezed coherent states $S(s_j)D(\alpha_j)|0\rangle \forall j \in (1, \dots, n)$, and sends them to Alice via block transmission.
2. Alice uses an optical switch to randomly select a set of the incoming states as control/message mode, and sends the information about the coordinates of the $n/2$ control mode states to Bob, whereas she puts the message mode states into an optical delay. Here and in what follows, by coordinates we mean the time slot chosen by Bob as control/message modes.
3. Bob sends information of s_j and α_j for the control mode states to Alice. She applies $S^\dagger(s_j) = S(-s_j)$ on the corresponding control mode states, and performs homodyne measurement in the position/momentum quadrature and verifies the real/imaginary part of the corresponding values of α_j to check for eavesdropping. If measured α_j values are correct up to a tolerable limit, then she continues to Step 4, else she discards the protocol, and they start all over again.

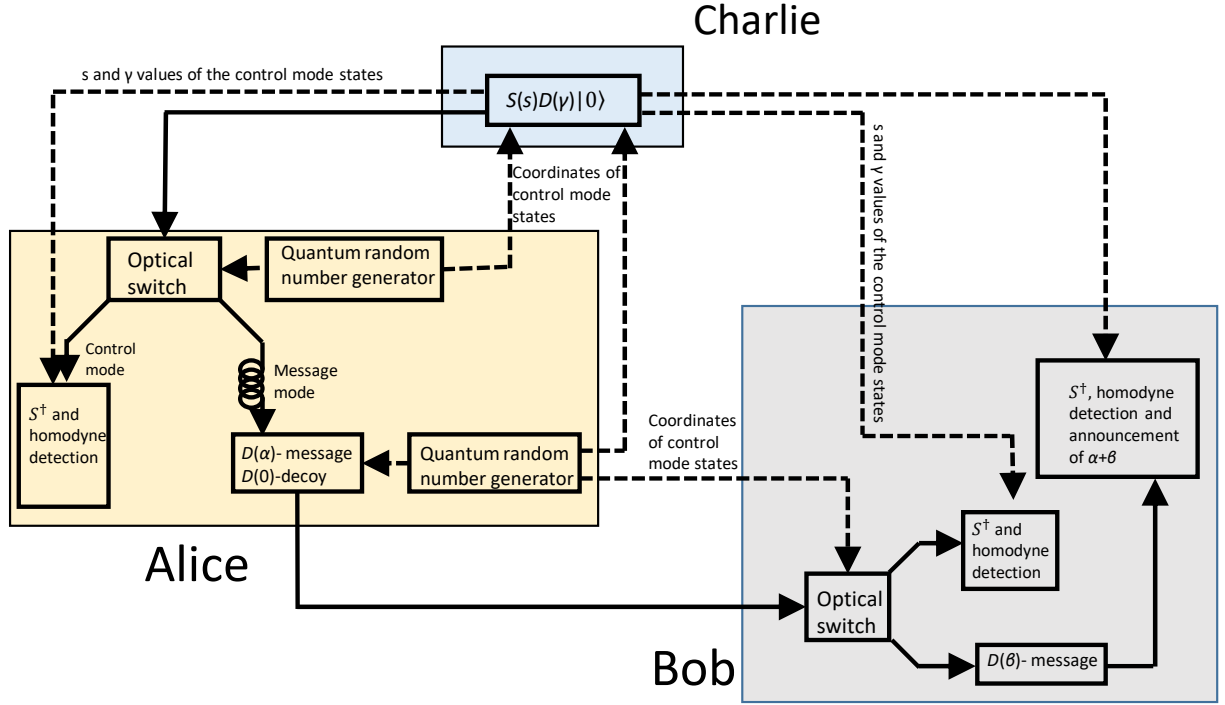

Figure 3: (Color online) Schematic diagram of the CQD protocol.

4. After discarding the control mode states, Alice randomly chooses $n/4$ states from the message mode and encodes her message on them by applying $D(\beta)$, where $\beta = m_A(1 + i)$ depends on her message $m_A \in \mathcal{R}$. The remaining $n/4$ states are kept unchanged to be used as decoy states, and all these $n/2$ states are then sent to Bob.
5. Bob applies the corresponding $S^\dagger(s_j)$ operator and performs homodyne measurement on the incoming $n/2$ message mode states for the corresponding position or momentum quadrature.
6. Alice sends information about the coordinates of the decoy states to Bob, and he checks for eavesdropping by comparing the corresponding α_j values for the decoy states by following the same procedure as described in Step 3.
7. The measurement results from the remaining message mode states would reveal the message m_A and hence Bob would obtain the message sent by Alice using Eq. (7).

3.2 Controlled quantum dialogue (CQD) protocol

The CQD protocol (shown schematically in Fig. 3) works as follows

1. Charlie generates $4n$ random complex numbers as a string R_d and labels them $\gamma_1, \gamma_2, \dots, \gamma_{4n}$. He then randomly generates $4n$ more complex numbers s_1, s_2, \dots, s_{4n} as a string R_s and uses both R_d and R_s to prepare the squeezed coherent states $S(s_j)D(\gamma_j)|0\rangle \forall j \in (1, \dots, 4n)$ and sends them to Alice.
2. Alice, using an optical switch, randomly selects $2n$ of the incoming states as the control mode and sends the information about the coordinates (i.e., corresponding time slots) of the $2n$ control mode states to Charlie, while she puts the rest of the $2n$ states into an optical delay for the message mode.
3. Charlie sends values of γ_j and s_j of the control mode states to Alice, and she applies the corresponding squeezing operator $S^\dagger(s_j) = S(-s_j)$ to each of the control mode states to perform homodyne measurement of position/momentum quadrature on them. From the measured values she verifies the corresponding value γ_j chosen by Charlie to check for eavesdropping. If γ_j values are correct up to a tolerable limit, then she continues to the next step, else the protocol is aborted and they start all over again.
4. After discarding the control mode states, Alice encodes her message m_A randomly in n of her message mode states by applying the appropriate displacement operator $D(\alpha_j)$ with $\alpha_j = m_A + i m_A$ on them and leaves the other n states

as control mode. Subsequently, she chooses a random complex number w_j and squeezes all the $2n$ states by applying $S(w_j)$ to these states and sends them to Bob. Upon Bob's confirmation of receiving all the $2n$ states, Alice sends Bob the value of w_j and the coordinates of the control mode states and Charlie sends Bob their corresponding γ_j and s_j . Without loss of generality, we can assume $w_j = w \forall j$ for squeezing operations would be sufficient in providing security against participant attack by Charlie.

5. Bob first applies the squeezing operator $S^\dagger(w_j) = S(-w_j)$ on all the $2n$ received states and then applies the corresponding squeezing operators $S^\dagger(s_j)$ on the n control mode states and checks for eavesdropping just as Step 3, meanwhile he encodes his message m_B in the other n message modes by applying the appropriate displacement operator $D(\beta_j)$ with $\beta_j = m_B + i m_B$ on them.
6. Once Bob encodes the message in the message mode states and confirms that there is no eavesdropping, then Charlie sends the corresponding γ_j and s_j of the message mode states, and Bob applies the corresponding operator $D^\dagger(\gamma_j)S^\dagger(s_j)$ on the message mode states. He measures position/momentum quadrature using homodyne detection and announces $\alpha_j + \beta_j$ after calculating it using Eq. (7). Finally, Alice and Bob can obtain each other's message by subtracting their message from the announced value of $\alpha_j + \beta_j$.

We have proposed here CV protocols for QSDC and CQD, both of which are the schemes for secure direct quantum communication, but the former one enables one way secure direct communication whereas the latter one allows the users to perform a two-way secure communication in presence of a controller. Notice from the schematic diagrams of these schemes in Figs. 2 and 3 that if the task allotted to Charlie in CQD is performed by Bob and he does not encode his message as displacement operator $D(\beta)$ the scheme is equivalent to the QSDC scheme. This reduction can be summarized as feasibility of a less complex cryptographic task if a secure communication solution is available for more complex problem. Analogously, the feasibility of a CQD scheme also provides corresponding quantum schemes for controlled DSQC, QD, DSQC as well as quantum key distribution and agreement (see [48] for more detail).

Interestingly, some of the schemes for secure direct quantum communication can be used as a primitive to obtain solution of secure multiparty computation problems, which have significance in several socioeconomic tasks. For instance, consider that Alice and Bob wish to compare their assets to know the richer one among them, which is known as socialist millionaire problem [29]. They can perform CQD scheme where both Alice and Bob would encode the amount of assets they have and send the encoded mode finally to Charlie for measurement. Assuming that Alice (Bob) always encodes A ($-B$) for her (his) amount of assets A (B). Depending upon whether Charlie's homodyne measurement finally gives him positive (negative) value, they can conclude Alice (Bob) the richer person as $A > B$ ($B > A$). Recently, we have used two-mode squeezed state based CQD scheme to provide solutions for the socialist millionaire problem [29]. Further, these schemes ensure the feasibility of quantum solutions for e-commerce [34] and voting [30] as well. In what follows, the security of the QSDC and CQD schemes against various types of attacks will be critically analyzed.

4 Security analysis of the protocols

In this section, we discuss the security of the protocol with respect to two attacks, namely the Gaussian quantum cloning machine (GQCM) and intercept-resend attacks.

4.1 Gaussian quantum cloning machine (GQCM) attack

A GQCM consists of a linear amplifier (LA) of gain A and a beamsplitter of transmission coefficient T (shown schematically in Fig. 4). The outputs of the GQCM are given in the Heisenberg picture as [26]

$$a_B = \sqrt{AT}a_{in} + \sqrt{(A-1)T}b_1 + \sqrt{1-T}b_2 \quad (8)$$

and

$$a_E = \sqrt{T}b_2 - \sqrt{A(1-T)}a_{in} - \sqrt{(A-1)(1-T)}b_1, \quad (9)$$

where a_B and a_E are Bob's and Eve's copies, respectively. Further, a_{in} is the incoming Alice's signal mode, and b_1 and b_2 are vacuum modes as inputs of the linear amplifier and the beamsplitter, respectively. We discuss the GQCM attack for the two protocols separately.

4.1.1 QSDC protocol

In the QSDC protocol given in Fig. 1, the squeezing parameters s_j and the initial coherent amplitudes α_j are completely randomized and are kept secret by Bob throughout the protocol. Therefore, Eve cannot infer anything from her copy of the cloned state. Hence, the QSDC protocol is unconditionally secure against the GQCM attack.

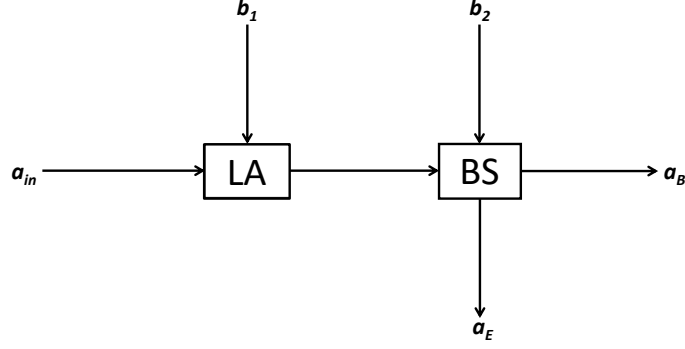

Figure 4: (Color online) Schematic diagram of the Gaussian quantum cloning machine (GQCM) attack on the CQD protocol. Here, LA and BS correspond to linear amplifier and beamsplitter, respectively.

4.1.2 CQD protocol

In the first quantum channel from Charlie to Alice, Eve has no advantage by performing this attack as Alice has not yet encoded her message. However though, in the quantum channel from Alice to Bob, Eve can use the GQCM on the channel and clone the incoming state, keep her copy of the clone in a quantum memory, wait for the values of w_j , s_j , $\alpha_j + \beta_j$, and γ_j to be announced during the protocol. She, subsequently, using this information, can measure her mode and interpret Alice's message which will reveal Bob's message too. Similarly, an untrusted Charlie may also perform the exact same attack.

The input of the GQCM can be defined in Heisenberg picture as

$$a_{in} = S^\dagger(t_j)D^\dagger(d_j)aD(d_j)S(t_j) = S^\dagger(t_j)aS(t_j) + d_j, \quad (10)$$

where $a = X_a + iP_a$ is the annihilation operator for the CV mode used for message transmission. Here, X_a and P_a correspond to the conjugate position and momentum quadrature operators, respectively. The final form of displacement and squeezing operators can be defined in terms of Alice's and Charlie's operations $D(d_j)S(t_j) = S(w)D(\alpha_j)S(s_j)D(\gamma_j)$, where $t_j = s_j + w_j = ge^{ih}$, and $d_j = d_{jx} + id_{jy}$ can be obtained from α_j and γ_j using Eqs. (6) and (7).

The use of Bogoliubov transformations yields

$$a_{in} = (mX_a + d_{jx}) + i(nP_a + d_{jy}) = X_{in} + iP_{in}, \quad (11)$$

where

$$\begin{aligned} X_{in} &= m_r X_a - n_i P_a + d_{jx}, \\ P_{in} &= m_i X_a + n_r P_a + d_{jy} \end{aligned}$$

with

$$\begin{aligned} m &= \cosh(g) - e^{ih}\sinh(g) = m_r + im_i, \\ n &= \cosh(g) + e^{ih}a^\dagger\sinh(g) = n_r + in_i. \end{aligned}$$

Using Eq. (11) as the input of Eqs. (8) and (9), the position and momentum quadratures of the Bob's and Eve's modes can be obtained as

$$\begin{aligned} X_B &= \sqrt{AT}(m_r X_a - n_i P_a + d_{jx}) + \sqrt{(A-1)T}X_{b1} + \sqrt{1-T}X_{b2}, \\ X_E &= \sqrt{T}X_{b2} - \sqrt{A(1-T)}(m_r X_a - n_i P_a + d_{jx}) - \sqrt{(A-1)(1-T)}X_{b1}, \\ P_B &= \sqrt{AT}(m_i X_a + n_r P_a + d_{jy}) + \sqrt{(A-1)T}P_{b1} + \sqrt{1-T}P_{b2}, \\ P_E &= \sqrt{T}P_{b2} - \sqrt{A(1-T)}(m_i X_a + n_r P_a + d_{jy}) - \sqrt{(A-1)(1-T)}P_{b1}. \end{aligned} \quad (12)$$

Since these variables are normally distributed, their corresponding variances are

$$\begin{aligned} \langle(\Delta X_B)^2\rangle &= M_{XB} + N_{XB}, \\ \langle(\Delta X_E)^2\rangle &= M_{XE} + N_{XE}, \\ \langle(\Delta P_B)^2\rangle &= M_{PB} + N_{PB}, \\ \langle(\Delta P_E)^2\rangle &= M_{PE} + N_{PE}, \end{aligned} \quad (13)$$

where the parameters

$$\begin{aligned} M_{XB} &= M_{PB} = \frac{1}{4}AT, \\ M_{XE} &= M_{PE} = \frac{1}{4}A(1-T) \end{aligned}$$

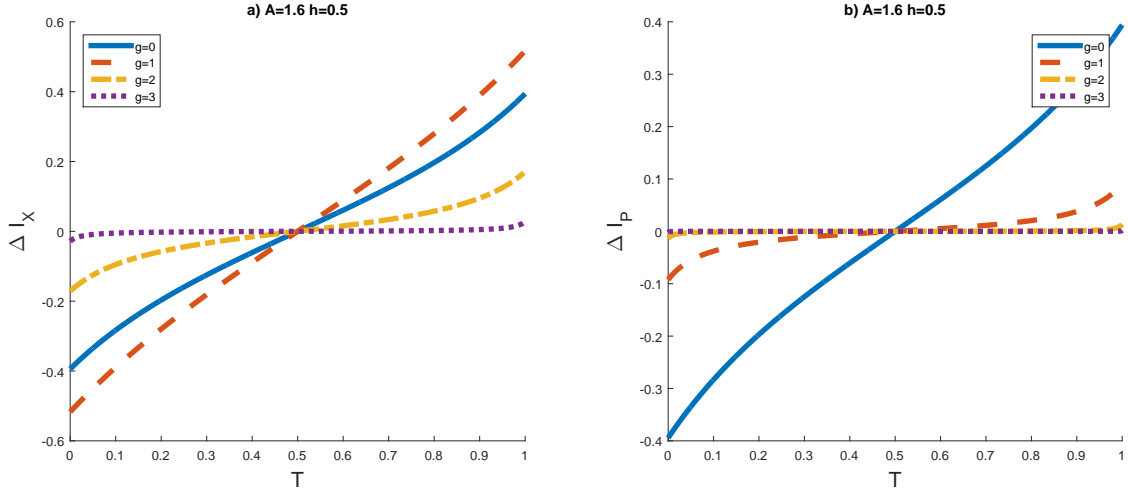

Figure 5: (Color online) Variation of (a) ΔI_X and (b) ΔI_P with transmission coefficient T for different values of squeezing parameter g , while values of squeezing parameter h and linear amplifier gain A are mentioned.

are the respective signal variances, and

$$\begin{aligned}
 N_{XB} &= \frac{1}{4}((m_r^2 + n_i^2)AT + (A-1)T + (1-T)), \\
 N_{XE} &= \frac{1}{4}(T + (m_r^2 + n_i^2)A(1-T) + (A-1)(1-T)), \\
 N_{PB} &= \frac{1}{4}((m_i^2 + n_r^2)AT + (A-1)T + (1-T)), \\
 N_{PE} &= \frac{1}{4}(T + (m_i^2 + n_r^2)A(1-T) + (A-1)(1-T))
 \end{aligned}$$

are the respective noise variances.

If γ_j is real (imaginary), then the position (momentum) quadrature is used for Homodyne measurement. Therefore, the mutual information $I_J(A, B)$ between Alice and Bob and $I_J(A, E)$ between Alice and Eve can be calculated as

$$I_J(A, B) = \frac{1}{2} \log_2 \left(1 + \frac{M_{JB}}{N_{JB}} \right), \quad (14)$$

and

$$I_J(A, E) = \frac{1}{2} \log_2 \left(1 + \frac{M_{JE}}{N_{JE}} \right) \quad (15)$$

with $J \in \{X, P\}$ corresponding to the position and momentum quadrature measurements. The security criterion for the CQD protocol is

$$\Delta I_J = I_J(A, B) - I_J(A, E) > 0. \quad (16)$$

We further discuss the dependence of the security of the protocol on different parameters, such as squeezing parameters and cloning parameters (shown in Figs. 5-8). According to Fig. 5, we can clearly see that for $\Delta I_J > 0$ requires the transmission coefficient $T > 0.5$, and we also see that both ΔI_X and ΔI_P increases with an increase in T . Additionally, for $T > 0.5$, ΔI_J decreases with increase in the gain parameter A as shown in Fig. 6. In the case of $T > 0.5$, both ΔI_X and ΔI_P initially increase with increase in the value of squeezing parameter g and then decrease after reaching a maximum value of ΔI_J . The effect of squeezing parameter g on position and momentum quadratures is opposite as ΔI_P can be obtained from ΔI_X by considering $-g$ instead of g (cf. Figs. 7 and 8). We have used h in the range 0 to π because according to Fig. 8, the results are symmetric about $h = \pi$.

4.2 Intercept-resend attack

In the QSDC protocol, Eve keeps the incoming state from Bob by using delay, and she prepares and sends her own freshly prepared state to Alice. Alice encodes her message on Eve's state and sends it to Bob. Eve decodes the message from this state, encodes the same message on Bob's state in the quantum memory and sends it back to Bob. This attack cannot be performed in this protocol because Eve will be detected when Alice checks for eavesdropping on the control mode, as α_j values of those sent by Bob and those measured by Eve will not match. Another type of intercept-resend attack (which is a form of

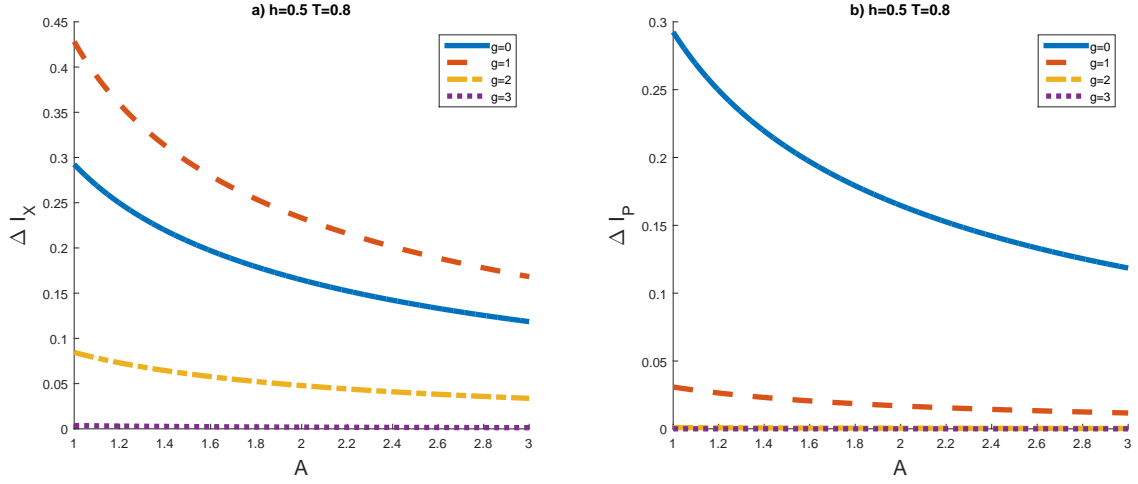

Figure 6: (Color online) Variation of (a) ΔI_X and (b) ΔI_P with A for different values of squeezing parameter g , while values of h and T are mentioned.

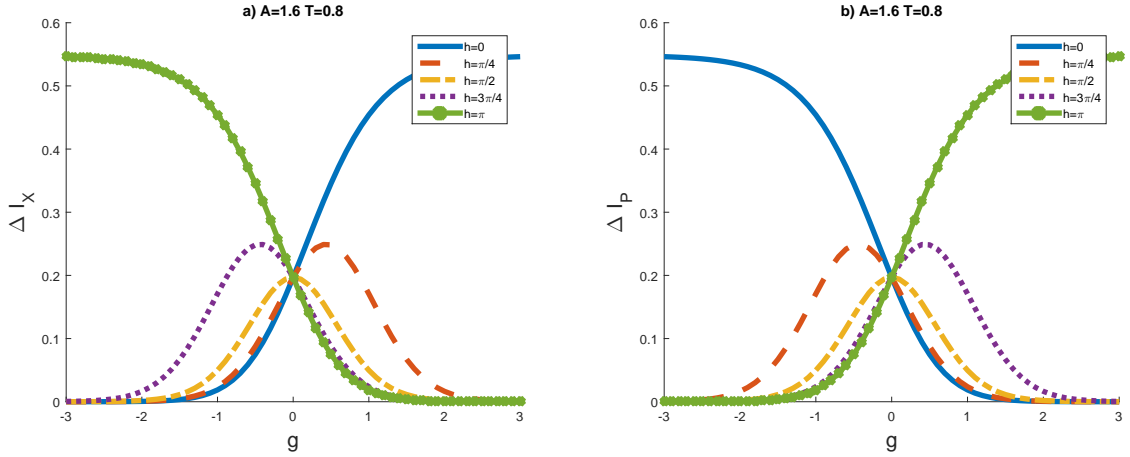

Figure 7: (Color online) The security of the scheme in terms of parameters (a) ΔI_X and (b) ΔI_P as a function of squeezing parameters g and h . Linear amplifier gain A and transmission coefficient T of the beamsplitter are mentioned.

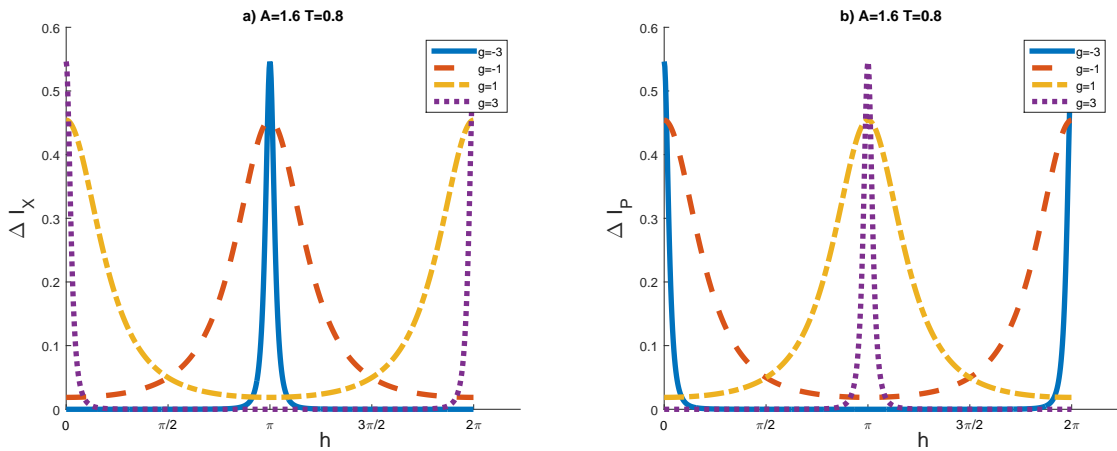

Figure 8: (Color online) Variation of (a) ΔI_X and (b) ΔI_P squeezing parameters g and h with the value of A and T as mentioned.

denial of service) can be performed by Eve in which she blocks the second channel (i.e., from Alice to Bob) and prepares and sends random quantum states to Bob, preventing Bob from receiving the message. This attack by Eve will be detected when Bob performs the eavesdropping checking on the decoy states in the message mode. In another kind of attack strategy, Eve measures the intercepted state, infers it, re-prepares it and sends it. This attack too, cannot be performed successfully by Eve as the squeezing parameter s_j and the initial amplitude α_j are random and unknown at the time of measurement, and hence no information can be obtained about the message sent. The same arguments hold for the CQD protocol.

4.3 Participant attack by Charlie

In CQD protocol, after Alice records her message and sends the encoded state to Bob. As Charlie is aware of the squeezing parameter, so he may intercept the Alice-Bob channel and apply S^\dagger operator to find out Alice's message. Subsequently, he re-prepares and re-sends the state to Bob. To avoid this, Alice has to apply her own random squeezing operation $S(w_j)$ on the state after encoding her message. Here, it may be noted that this attack is not applicable to the other scheme proposed here as there is no supervisor in that scheme.

5 Conclusion

Motivated by the recent success of CV quantum key distribution schemes using Gaussian states, we proposed here a two-party and a three-party CV direct secure Gaussian quantum communication schemes. Specifically, we have shown that a sender can send CV information to a distant receiver (in the QSDC scheme) without distributing and encrypting it with a quantum key to attain security ensured by the quantum resources. A single-mode squeezed state is used as a quantum resource, and displacement and squeezing operations are used to encode the message, which is decoded by performing homodyne detection.

We have also proposed a CV CQD which allows two parties to perform simultaneous communication under the supervision of a controller in a secure manner. The proposed scheme can be reduced to the corresponding three-party scheme where a sender can send her message to the receiver by assuming that Bob is neither encoding his message nor announcing his final measurement outcomes in our CQD protocol. Both these schemes are found useful as primitive to design solutions for socioeconomic problems, and thus the feasibility of our scheme with single-mode Gaussian states enables us to provide CV solutions for these problems. We have further established the application of our CQD scheme to provide solution of socialist millionaire problem. Similarly, the proposed schemes can be used to obtain quantum solutions for e-commerce [34] and voting [30] as well. Our CQD scheme can also be reduced to a modified version of recently proposed two-party quantum dialogue [26] scheme in the limiting case, which will be more robust against Gaussian quantum cloning machine and intercept-resend attacks as the squeezing parameter is not revealed in our scheme.

We conclude the paper with the expectation that in view of the recent surge of experimental direct secure quantum communication and promising future of CV quantum communication, the present schemes be implemented in the near future.

Acknowledgment

AP acknowledges the support from Interdisciplinary Cyber Physical Systems (ICPS) programme of the Department of Science and Technology (DST), India, Grant No.: DST/ICPS/QuST/Theme-1/2019/14. KT acknowledges the financial support from the Operational Programme Research, Development and Education - European Regional Development Fund project no. CZ.02.1.01/0.0/0.0/16_019/0000754 of the Ministry of Education, Youth and Sports of the Czech Republic.

References

- [1] Dowling, J. P., Milburn, G. J.: Quantum technology: the second quantum revolution. *Philosophical Transactions of the Royal Society of London. Series A: Mathematical, Physical and Engineering Sciences* **361**, 1655–1674 (2003)
- [2] Bennett, C. H., Brassard, G.: Quantum cryptography: public key distribution and coin tossing. In: *International Conference on Computer System and Signal Processing*, IEEE, 1984 pp. 175–179 (1984)
- [3] Gisin, N., Ribordy, G., Tittel, W., Zbinden, H.: Quantum cryptography. *Rev. Mod. Phys.* **74**, 145 (2002)
- [4] Pathak, A.: *Elements of quantum computation and quantum communication*. Taylor & Francis, New York (2013)
- [5] Shenoy-Hejamadi, A., Pathak, A., Radhakrishna, S.: Quantum cryptography: key distribution and beyond. *Quanta* **6**, 1–47 (2017)

- [6] Boström, K., Felbinger, T.: Deterministic secure direct communication using entanglement. *Phys. Rev. Lett.* **89**, 187902 (2002)
- [7] Deng, F.-G., Long, G.-L.: Controlled order rearrangement encryption for quantum key distribution. *Phys. Rev. A* **68**, 042315 (2003)
- [8] Hu, J., Yu, B., Jing, M., et al.: Experimental quantum secure direct communication with single photons. *Light: Science & Applications* **5**, e16144 (2016)
- [9] Long, G.-l., Deng, F.-g., Wang, C., et al.: Quantum secure direct communication and deterministic secure quantum communication. *Frontiers of Physics in China* **2**, 251–272 (2007)
- [10] Nguyen, B. A.: Quantum dialogue. *Phys. Lett. A* **328**, 6–10 (2004)
- [11] Thapliyal, K., Pathak, A.: Applications of quantum cryptographic switch: various tasks related to controlled quantum communication can be performed using Bell states and permutation of particles. *Quantum Inf. Process.* **14**, 2599–2616 (2015)
- [12] Braunstein, S. L., Van Loock, P.: Quantum information with continuous variables. *Rev. Mod. Phys.* **77**, 513 (2005)
- [13] Andersen, U. L., Leuchs, G., Silberhorn, C.: Continuous-variable quantum information processing. *Laser & Photonics Reviews* **4**, 337–354 (2010)
- [14] Weedbrook, C., Pirandola, S., García-Patrón, R., et al.: Gaussian quantum information. *Rev. Mod. Phys.* **84**, 621 (2012)
- [15] Hillery, M.: Quantum cryptography with squeezed states. *Phys. Rev. A* **61**, 022309 (2000)
- [16] Gottesman, D., Preskill, J.: Secure quantum key distribution using squeezed states. *Phys. Rev. A* **63**, 022309 (2001)
- [17] Reid, M. D.: Quantum cryptography with a predetermined key, using continuous-variable Einstein-Podolsky-Rosen correlations. *Phys. Rev. A* **62**, 062308 (2000)
- [18] Ralph, T. C.: Continuous variable quantum cryptography. *Phys. Rev. A* **61**, 010303 (1999)
- [19] Ralph, T. C.: Security of continuous-variable quantum cryptography. *Phys. Rev. A* **62**, 062306 (2000)
- [20] Grosshans, F., Grangier, P.: Continuous variable quantum cryptography using coherent states. *Phys. Rev. Lett.* **88**, 057902 (2002)
- [21] S, S., Thapliyal, K., Pathak, A.: Continuous variable B92 quantum key distribution protocol using single photon added and subtracted coherent states. *arXiv preprint arXiv:1906.07768* (2019)
- [22] Pirandola, S., Mancini, S., Lloyd, S., Braunstein, S. L.: Continuous-variable quantum cryptography using two-way quantum communication. *Nature Physics* **4**, 726 (2008)
- [23] Yuan, L., Chunlei, J., Shunru, J., Mantao, X.: Continuous variable quantum secure direct communication in non-Markovian channel. *Int. J. Theor. Phys.* **54**, 1968–1973 (2015)
- [24] Marino, A. M., Stroud Jr, C.: Deterministic secure communications using two-mode squeezed states. *Physical Review A* **74**, 022315 (2006)
- [25] Zhou, N.-R., Li, J.-F., Yu, Z.-B., Gong, L.-H., Farouk, A.: New quantum dialogue protocol based on continuous-variable two-mode squeezed vacuum states. *Quantum Inf. Process.* **16**, 4 (2017)
- [26] Zhang, M.-H., Cao, Z.-W., He, C., Qi, M., Peng, J.-Y.: Quantum dialogue protocol with continuous-variable single-mode squeezed states. *Quantum Inf. Process.* **18**, 83 (2019)
- [27] Yu, Z.-B., Gong, L.-H., Zhu, Q.-B., Cheng, S., Zhou, N.-R.: Efficient three-party quantum dialogue protocol based on the continuous variable GHZ states. *Int. J. Theor. Phys.* **55**, 3147–3155 (2016)
- [28] Gong, L.-H., Tian, C., Li, J.-F., Zou, X.: Quantum network dialogue protocol based on continuous-variable GHZ states. *Quantum Inf. Process.* **17**, 331 (2018)
- [29] Saxena, A., Thapliyal, K., Pathak, A.: Continuous variable controlled quantum dialogue and secure multiparty quantum computation. *arXiv preprint arXiv:1902.00458* (2019)

- [30] Thapliyal, K., Sharma, R. D., Pathak, A.: Protocols for quantum binary voting. *Int. J. Quantum Inf.* p. 1750007 (2017)
- [31] Shukla, C., Thapliyal, K., Pathak, A.: Semi-quantum communication: protocols for key agreement, controlled secure direct communication and dialogue. *Quantum Inf. Process.* **16**, 295 (2017)
- [32] Sharma, R. D., Thapliyal, K., Pathak, A.: Quantum sealed-bid auction using a modified scheme for multiparty circular quantum key agreement. *Quantum Inf. Process.* **16**, 169 (2017)
- [33] Thapliyal, K., Sharma, R. D., Pathak, A.: Orthogonal-state-based and semi-quantum protocols for quantum private comparison in noisy environment. *Int. J. Quantum Inf.* **16**, 1850047 (2018)
- [34] Thapliyal, K., Pathak, A.: Quantum e-commerce: a comparative study of possible protocols for online shopping and other tasks related to e-commerce. *Quantum Inf. Process.* **18**, 191 (2019)
- [35] Yao, A. C.: Protocols for secure computations. in: *Foundations of Computer Science, 1982. SFCS'08. 23rd Annual Symposium on* pp. 160–164 IEEE (1982)
- [36] Villar, A. d. S., Cruz, L., Cassemiro, K. N., Martinelli, M., Nussenzveig, P.: Generation of bright two-color continuous variable entanglement. *Phys. Rev. Lett.* **95**, 243603 (2005)
- [37] Lassen, M., Leuchs, G., Andersen, U. L.: Continuous variable entanglement and squeezing of orbital angular momentum states. *Phys. Rev. Lett.* **102**, 163602 (2009)
- [38] Dos Santos, B. C., Dechoum, K., Khoury, A.: Continuous-variable hyperentanglement in a parametric oscillator with orbital angular momentum. *Phys. Rev. Lett.* **103**, 230503 (2009)
- [39] Liu, K., Guo, J., Cai, C., Guo, S., Gao, J.: Experimental generation of continuous-variable hyperentanglement in an optical parametric oscillator. *Phys. Rev. Lett.* **113**, 170501 (2014)
- [40] Thapliyal, K., Pathak, A., Sen, B., Peřina, J.: Higher-order nonclassicalities in a codirectional nonlinear optical coupler: Quantum entanglement, squeezing, and antibunching. *Physical Review A* **90**, 013808 (2014)
- [41] Thapliyal, K., Pathak, A., Sen, B., Perina, J.: Nonclassical properties of a contradirectional nonlinear optical coupler. *Physics Letters A* **378**, 3431–3440 (2014)
- [42] Thapliyal, K., Samantray, N. L., Banerji, J., Pathak, A.: Comparison of lower- and higher-order nonclassicality in photon added and subtracted squeezed coherent states. *Phys. Lett. A* **381**, 3178 – 3187 (2017)
- [43] Agarwal, G. S.: *Quantum Optics*. Cambridge University Press, Cambridge (2013)
- [44] Wigner, E. P.: On the quantum correction for thermodynamic equilibrium. *Phys. Rev.* **40**, 749 (1932)
- [45] Strawberry fields interactive. <https://strawberryfields.ai>. Xanadu, Accessed on 10 December 2018
- [46] Thapliyal, K., Banerjee, S., Pathak, A., Omkar, S., Ravishankar, V.: Quasiprobability distributions in open quantum systems: Spin-qubit systems. *Ann. Phys.* **362**, 261–286 (2015)
- [47] Thapliyal, K., Banerjee, S., Pathak, A.: Tomograms for open quantum systems: in (finite) dimensional optical and spin systems. *Ann. Phys.* **366**, 148–167 (2016)
- [48] Thapliyal, K., Pathak, A., Banerjee, S.: Quantum cryptography over non-Markovian channels. *Quantum Inf. Process.* **16**, 115 (2017)