

Symmetry defects and orbifolds of two-dimensional Yang-Mills theory

Lukas Müller^{a,*}, Richard J. Szabo^{a,b,†} and Lóránt Szegedy^{c,‡}

^a *Department of Mathematics
Heriot-Watt University*

*Colin Maclaurin Building, Riccarton, Edinburgh EH14 4AS, U.K.
and Maxwell Institute for Mathematical Sciences, Edinburgh, U.K.
and The Higgs Centre for Theoretical Physics, Edinburgh, U.K.*

^b *Dipartimento di Scienze e Innovazione Tecnologica
Università del Piemonte Orientale
Viale T. Michel 11, 15121 Alessandria, Italy
and Arnold–Regge Centre, Via P. Giuria 1, 10125 Torino, Italy*

^c *Fachbereich Mathematik
Universität Hamburg
Bundesstraße 55, D–20146 Hamburg, Germany*

Abstract

We describe discrete symmetries of two-dimensional Yang-Mills theory with gauge group G associated to outer automorphisms of G , and their corresponding defects. We show that the gauge theory partition function with defects can be computed as a path integral over the space of twisted G -bundles, and calculate it exactly. We argue that its weak-coupling limit computes the symplectic volume of the moduli space of flat twisted G -bundles on a surface. Using the defect network approach to generalised orbifolds, we gauge the discrete symmetry and construct the corresponding orbifold theory, which is again two-dimensional Yang-Mills theory but with gauge group given by an extension of G by outer automorphisms. With the help of the orbifold completion of the topological defect bicategory of two-dimensional Yang-Mills theory, we describe the reverse orbifold using a Wilson line defect for the discrete gauge symmetry. We present our results using two complementary approaches: in the lattice regularisation of the path integral, and in the functorial approach to area-dependent quantum field theories with defects via regularised Frobenius algebras.

*Email: lm78@hw.ac.uk

†Email: r.j.szabo@hw.ac.uk

‡Email: lorant.szegedy@uni-hamburg.de

Contents

1	Introduction	2
2	Discrete symmetries and defects of Yang-Mills theory	5
2.1	Description of the $\text{Out}(G)$ -symmetry	6
2.2	Defects and twisted bundles	8
2.3	Combinatorial quantisation of defect Yang-Mills theory	10
2.4	The moduli space of flat twisted bundles	15
2.5	The orbifold Yang-Mills theory	18
2.6	The reverse orbifold Yang-Mills theory	20
3	Generalised orbifold of functorial defect Yang-Mills theory	22
3.1	State sum area-dependent quantum field theory with defects	22
3.2	The defect bicategory of Yang-Mills theory	28
3.3	Frobenius algebras from symmetry defects	34
3.4	Gauging the $\text{Out}(G)$ -symmetry	38
3.5	Orbifold equivalence and the backwards orbifold	45
	References	49

1 Introduction

Defects are impurities, discontinuities, boundary conditions, or other ways of modifying a quantum field theory which are localised on submanifolds of various codimensions of the spacetime. In general, defects can meet on other defects of higher codimensions. They are an important tool in the study of non-perturbative features in quantum field theories and condensed matter systems, and of symmetry protected topological phases. The structure of the collection of all defects is closely related to higher categories, see [DKR11, Kap11] for a discussion in the case of topological field theories. Defects are extended observables in quantum field theories, so that one can compute a partition function or correlation function in the presence of a defect network. A prominent class of examples are the Wilson line observables in gauge theories.

A particularly simple class of defects are topological defects which can be continuously deformed without changing any physical observables. Two topological defects can be brought close together such that their contribution to the partition function can be effectively described by another defect. This defines an operation for topological defects called fusion. A defect D is called invertible if there exists another defect D^{-1} such that the fusion of D with D^{-1} is the trivial defect 1 ; every quantum field theory admits a trivial defect 1 which does not change the value of the partition function.

Invertible topological defects of codimension one, or domain walls, are closely related to symmetries of the field theory [FS15]. Given a symmetry we can construct a topological domain wall which acts on fields passing through it by applying the symmetry. On the other hand, one can recover the action of the symmetry on fields by wrapping the defect around a field insertion. The description of symmetries and their corresponding background gauge fields via topological domain walls makes it possible to describe their action on other quantities of the quantum field theory such as boundary conditions or other (non-topological) defects [Tac20].¹

¹This description appears in much earlier literature on conformal field theory, where it is an immediate consequence of the condition that the topological defect commutes with both copies of the Virasoro algebra (see e.g. [PZ01]).

In this paper we illustrate the relationship between defects and symmetries for a simple class of symmetries of two-dimensional Yang-Mills theory. Yang-Mills theory on a Riemann surface has a long and rich history as an exactly solvable quantum gauge theory which is the first example of a non-abelian gauge theory that can be reformulated as a (topological) string theory (see [CMR95] for a review). Mathematically it has served as a tool for studying the topology of various moduli spaces of interest in geometry and dynamical systems, such as the moduli spaces of flat connections [AB82, Wit91, Wit92], the Hurwitz moduli spaces of branched coverings [CMR95, KSS16], and the principal moduli spaces of holomorphic differentials [GSS04, GSS05]. In the following we will study how some of these features are modified in the presence of domain walls, which in two dimensions can be thought of as symmetry twist branch cuts on the surface [BBCW19], corresponding to outer automorphisms of the gauge group.²

Recently it was shown that defects in area-dependent two-dimensional quantum field theories can be studied in terms of ‘regularised Frobenius algebras’ and their bimodules [RS21]. Let G be a compact semi-simple Lie group. The square-integrable functions on G form the regularised Frobenius algebra underlying the two-dimensional Yang-Mills theory with gauge group G . In [RS21] invertible defects are constructed algebraically from outer automorphisms of G . For example, the only non-trivial outer automorphism of $G = SU(n)$ for $n > 2$ is the complex conjugation automorphism $g \mapsto \bar{g}$; further examples of groups with non-trivial outer automorphisms are displayed in Table 1.

G	$SU(n), n > 2$	$SO(2n), n > 4$	$SO(8)$	E_6
$\text{Out}(G)$	\mathbb{Z}_2	\mathbb{Z}_2	S_3	\mathbb{Z}_2

Table 1: The compact connected simple Lie groups G with non-trivial outer automorphism groups $\text{Out}(G)$. Here \mathbb{Z}_2 is the abelian cyclic group of order two and S_3 is the non-abelian symmetric group of degree three.

One motivation for the present investigation is to give a physical interpretation of these defects, which is the content of the first part of this paper (Section 2). We show in Section 2.1 that for an outer automorphism $\varphi: G \rightarrow G$ there is a symmetry of two-dimensional Yang-Mills theory sending a gauge field described by a principal bundle with connection to the associated G -bundle for the group homomorphism φ with its induced connection. We proceed to show that the partition function in the presence of a network of the associated defects on a closed oriented surface Σ can be computed as a path integral over the space of ‘twisted bundles’. Let $\text{Bun}_G^\nabla(\Sigma)$ be the space of principal G -bundles with connection on Σ , $\text{Out}(G)$ the (finite) group of outer automorphisms of G and $G \rtimes \text{Out}(G)$ the semi-direct product of groups.³ There is a natural group homomorphism $G \rtimes \text{Out}(G) \rightarrow \text{Out}(G)$ which induces a map $\text{Bun}_{G \rtimes \text{Out}(G)}^\nabla(\Sigma) \rightarrow \text{Bun}_{\text{Out}(G)}^\nabla(\Sigma)$. In Section 2.2 we construct an $\text{Out}(G)$ -bundle $D \rightarrow \Sigma$ from the defect network and define the space of D -twisted G -bundles with connection on Σ as the fibre of D for the map $\text{Bun}_{G \rtimes \text{Out}(G)}^\nabla(\Sigma) \rightarrow \text{Bun}_{\text{Out}(G)}^\nabla(\Sigma)$. Concretely, a twisted bundle on Σ is given by a $G \rtimes \text{Out}(G)$ -bundle together with a gauge transformation from the induced $\text{Out}(G)$ -bundle to D which specifies where the branch cuts on Σ are located.

We present exact calculations of the partition function in the presence of defect networks using the lattice regularisation of two-dimensional Yang-Mills theory in Section 2.3. This shows in

²Similar defects are constructed in [FPSV15] in the context of three-dimensional Dijkgraaf-Witten theories, and have also been proposed to have physical realisations in certain topological states of matter, see for example [BJQ13].

³Generally, $\text{Out}(G)$ is defined as the quotient of the group of automorphisms $\text{Aut}(G)$ by the normal subgroup of inner automorphisms, and hence is not a subgroup of $\text{Aut}(G)$. However, the construction of outer automorphisms from symmetries of Dynkin diagrams, reviewed in Section 2.3, gives an embedding of $\text{Out}(G) \hookrightarrow \text{Aut}(G)$. We implicitly use this embedding throughout the paper, for example when defining the semi-direct product $G \rtimes \text{Out}(G)$.

particular that the defects corresponding to the symmetry induced by φ agree with the defects constructed in [RS21]. The weak-coupling limit of two-dimensional Yang-Mills theory can be used to compute the symplectic volume of the moduli space of flat connections on Σ [Wit91]. Similarly, we argue in Section 2.4 that the weak-coupling limit of two-dimensional Yang-Mills theory in the presence of defects computes the symplectic volume of the moduli space of flat twisted bundles on Σ , introduced for example in [Mei17].

The description of symmetries via defects is particularly convenient in the context of orbifold theories.⁴ The partition function of the orbifold theory can be computed by evaluating the original theory on a sufficiently fine defect network labeled with symmetry defects.⁵ This requires the introduction of point defects — called ‘junction fields’ — on which three defect lines can meet. We use the defect approach to orbifolds [FFRS09, CR16, BCP14, CRS19] in Section 2.5 to show that the orbifold theory is the Yang-Mills theory on Σ based on the gauge group $G \rtimes \text{Out}(G)$. An advantage of the defect approach to orbifolds is that it also works for suitable non-invertible defects. We use this generalised orbifold construction to show in Section 2.6 that the orbifold of the Yang-Mills theory with gauge group $G \rtimes \text{Out}(G)$, with respect to the Wilson line defects induced from the regular representation $L^2(\text{Out}(G))$ of $\text{Out}(G)$, is the Yang-Mills theory on Σ with gauge group G ; these defects are invertible, and hence correspond to symmetry defects, only when $\text{Out}(G)$ is an abelian group. This may be thought of as a duality between these two quantum Yang-Mills theories with defects.

The second part of this paper (Section 3) is concerned with a mathematically rigorous formulation of the orbifold construction performed in the first part. We aim to show that this is a good illustration of the power of the approach to two-dimensional area-dependent quantum field theories via functorial field theories and regularised Frobenius algebras. A regularised Frobenius algebra consists of a Hilbert space A equipped with families of bounded linear operators $\mu_a: A \otimes A \rightarrow A$, $\eta_a: \mathbb{C} \rightarrow A$, $\Delta_a: A \rightarrow A \otimes A$ and $\varepsilon_a: A \rightarrow \mathbb{C}$ parameterised by a positive real number $a \in \mathbb{R}_{>0}$. These maps are required to be continuous in an appropriate sense and to satisfy parameterised versions of the usual relations for Frobenius algebras. We give the full definition in Section 3.1.

The example relevant to this paper is the Hilbert space of square-integrable functions $A = L^2(G)$ on a compact semi-simple Lie group G , which becomes a regularised Frobenius algebra via the morphisms

$$\begin{aligned} \eta_a(1) &= \sum_{\alpha \in \hat{G}} \dim \alpha \exp\left(-a \frac{C_2(\alpha)}{2}\right) \chi_\alpha, & \mu_a(f \otimes g) &= \eta_a(1) * (f * g), \\ \varepsilon_a(f) &= (\eta_a(1) * f)(1), & \Delta_a f &= \Delta(\eta_a(1) * f), \end{aligned} \quad (1.1)$$

where the sum runs over all isomorphism classes α of irreducible representations of G of dimension $\dim \alpha$, $\chi_\alpha: G \rightarrow \mathbb{C}$ denotes the corresponding character and $C_2(\alpha)$ is the value of the quadratic Casimir operator C_2 in the representation α . Here

$$(f * g)(x) = \int_G dy f(xy^{-1})g(y) \quad \text{and} \quad (\Delta f)(x, y) = f(xy)$$

are the usual convolution product and coproduct on $L^2(G)$. The regularised Frobenius algebra $L^2(G)$ is the input for the state sum construction of two-dimensional Yang-Mills theory in [RS21], which makes the lattice regularisation of Section 2 precise. The centre of $L^2(G)$ is the commutative regularised Frobenius algebra of class functions $C\ell^2(G)$ on G , which describes two-dimensional Yang-Mills theory without defects.

⁴Orbifolds of two-dimensional conformal field theories with respect to an outer automorphism group symmetry were studied long ago, see for example [SY90, BFS99].

⁵By ‘sufficiently fine’ we mean a defect network that can be obtained as the dual graph of a triangulation of Σ .

In this approach, defects between different Yang-Mills theories correspond to dualisable bimodules between the regularised Frobenius algebras $L^2(G)$ and $L^2(G')$. Such a bimodule consists of a Hilbert space M together with a family of maps $\rho_{a,b}: L^2(G) \otimes M \otimes L^2(G') \rightarrow M$ parameterised by two positive real numbers $a, b \in \mathbb{R}_{>0}$, satisfying a parameterised version of the usual bimodule relations; we refer again to Section 3.1 for more details. The defect described in the first part of the paper corresponds to the bimodule $L_\varphi = L^2(G)$ with action twisted by the outer automorphism φ as

$$\begin{aligned} \rho_{a,b}: L^2(G) \otimes L^2(G) \otimes L^2(G) &\longrightarrow L^2(G) , \\ f \otimes h \otimes g &\longmapsto \mu_a(f \otimes \mu_b(h \otimes \varphi^*g)) . \end{aligned} \tag{1.2}$$

These observations are the starting point for the content of second part of the paper. After a brief review of the state sum construction of area-dependent quantum field theories from regularised Frobenius algebras and their bimodules in Section 3.1, we make the mathematical structure of topological defects in two-dimensional Yang-Mills theories precise by introducing an idempotent complete bicategory of topological defects in Section 3.2. The input for a generalised orbifold construction in this framework is a strongly separable symmetric Frobenius algebra in an endomorphism category inside the topological defect bicategory. In Section 3.3 we construct such a Frobenius algebra from the defects which is isomorphic to a Frobenius algebra built from a bimodule structure on the square-integrable functions $L^2(G \rtimes \text{Out}(G))$ on the semi-direct product $G \rtimes \text{Out}(G)$. In Section 3.4 we compute the corresponding orbifold theory using the state sum construction and show, using the abstract orbifold completion of the defect bicategory [CR16], that the backwards orbifold can be performed using Wilson line defects in Section 3.5.

Acknowledgments

We thank Sanjaye Ramgoolam, Ingo Runkel and Lennart Schmidt for helpful discussions and correspondence. This work was supported by the COST Action MP1405 “Quantum Structure of Spacetime”, funded by the European Cooperation in Science and Technology (COST). The work of L.M. was supported by the Doctoral Training Grant ST/N509099/1 from the UK Science and Technology Facilities Council (STFC). The work of R.J.S. was supported in part by the STFC Consolidated Grant ST/P000363/1 “Particle Theory at the Higgs Centre” and the Istituto Nazionale di Fisica Nucleare (INFN, Torino). L.S. gratefully acknowledges the Max Planck Institute for Mathematics in Bonn for financial support and hospitality. L.S. is partially supported by the DFG Research Training Group 1670 “Mathematics Inspired by String Theory and Quantum Field Theory”.

2 Discrete symmetries and defects of Yang-Mills theory

Let G be a compact semi-simple Lie group with Lie algebra \mathfrak{g} , and $\varphi: G \rightarrow G$ an outer automorphism of G . In this section we construct a groupoid homomorphism $\varphi: \text{Bun}_G^\nabla(\Sigma) \rightarrow \text{Bun}_G^\nabla(\Sigma)$ on the topological groupoid of principal G -bundles with connection for every closed oriented surface Σ . We show in Section 2.1 that the Yang-Mills action functional on Σ is invariant under this transformation, so that φ defines a symmetry of the gauge theory. In Section 2.2 we study the corresponding defects in terms of twisted bundles, and calculate the partition functions exactly using a lattice regularisation of the quantum gauge theory in Section 2.3. The partition function for a given defect configuration localises in the weak-coupling limit onto the moduli space of flat twisted G -bundles, similarly to the untwisted case [Wit91]. In this limit the partition function computes the symplectic volume of this moduli space, defined for example in [Mei17]. We will use

the combinatorial quantisation of two-dimensional Yang-Mills theory to make a precise conjecture for this volume in some simple cases in Section 2.4. In Section 2.5 we compute the corresponding orbifold theory, and subsequently the reverse orbifold theory in Section 2.6.

2.1 Description of the $\text{Out}(G)$ -symmetry

Let $\pi : P \rightarrow \Sigma$ be a principal G -bundle on Σ , and let $\text{Ad}(P) = (P \times \mathfrak{g})/G$ be the vector bundle on Σ with fibre \mathfrak{g} , where G acts on P by the principal bundle action and on \mathfrak{g} by the adjoint action. Let $A \in \Omega^1(P; \mathfrak{g})$ be a connection on P ; its curvature $F_A = dA + A \wedge A$ is a two-form on Σ valued in the adjoint bundle associated with P : $F_A \in \Omega^2(\Sigma; \text{Ad}(P))$. The group of gauge transformations is the automorphism group $\text{Aut}(P)$ of P consisting of G -equivariant diffeomorphisms $g : P \rightarrow P$ with $\pi \circ g = \pi$.

We define a new bundle $\varphi(P)$ with the same underlying total space P and projection π , but with G -action $P \times G \rightarrow P$ modified by pre-composing with φ^{-1} . This can also be regarded as the induced G -bundle $P \times_{\varphi} G$ for the Lie group automorphism $\varphi : G \rightarrow G$. By differentiating φ at the identity we get a Lie algebra automorphism $\varphi_* : \mathfrak{g} \rightarrow \mathfrak{g}$. The symmetry φ acts on the connection A by mapping it to $\varphi_*(A)$ where $\varphi_* : \mathfrak{g} \rightarrow \mathfrak{g}$ acts only on the Lie algebra part of the one-form $A \in \Omega^1(P; \mathfrak{g})$; this is the induced connection on the bundle $P \times_{\varphi} G$, see for example [Fre95, Section 1].

We use a local trivialisation to show that this is again a principal G -bundle with connection. Let $\{U_i\}$ be an open cover of Σ such that (P, A) can be described by transition functions $g_{ij} : U_{ij} \rightarrow G$ on overlaps $U_{ij} := U_i \cap U_j$ and local one-forms $A_i \in \Omega^1(U_i; \mathfrak{g})$. On the overlaps U_{ij} the one-forms A_i are required to satisfy

$$A_j = \text{Ad}_{g_{ij}}(A_i) + g_{ij}^* \theta = g_{ij}^{-1} A_i g_{ij} + g_{ij}^{-1} dg_{ij} \quad (2.1)$$

where θ is the Maurer-Cartan one-form on G and the second equality holds for matrix Lie groups. Under the automorphism, g_{ij} is mapped to $\varphi \circ g_{ij} : U_{ij} \rightarrow G$. We check that $\varphi_*(A_i)$ satisfy (2.1) with respect to the new transition functions:

$$\begin{aligned} \text{Ad}_{\varphi \circ g_{ij}}(\varphi_*(A_i)) + (\varphi \circ g_{ij})^* \theta &= \varphi_*(\text{Ad}_{g_{ij}}(A_i)) + (\varphi \circ g_{ij})^* \theta \\ &= \varphi_*(\text{Ad}_{g_{ij}}(A_i) + g_{ij}^* \theta) \\ &= \varphi_*(A_j) , \end{aligned}$$

where the first equality follows from differentiating the equality $\varphi(g^{-1}) \varphi(\cdot) \varphi(g) = \varphi(g^{-1}(\cdot)g)$ of group automorphisms of G and the second equality from the definition of the Maurer-Cartan one-form. The groupoid homomorphism acts on a gauge transformation $\xi_i : U_i \rightarrow G$ by composition with φ .

In the case of an inner automorphism of G , this would just describe the action of a global gauge transformation on the physical fields. For later use, we note that the action on the parallel transport in P described by an element $g \in G$ with respect to a given local trivialisation is given by applying φ to g .⁶

Let us now equip the smooth oriented surface Σ with a Riemannian metric such that Σ has total area

$$a := \int_{\Sigma} d\mu ,$$

⁶This can be seen by applying the chain rule to the function $\varphi \circ g : [0, 1] \rightarrow G$, where $g : [0, 1] \rightarrow G$ is a solution to the differential equation describing the parallel transport in P .

where $d\mu = \star 1$ is the Riemannian measure defined by the corresponding Hodge duality operator \star . The metric induces the Hodge operator $\star : \Omega^2(\Sigma; \text{Ad}(P)) \rightarrow \Omega^0(\Sigma; \text{Ad}(P))$ acting only on the differential form part. We also equip the Lie algebra \mathfrak{g} with an invariant quadratic form, which we may assume without loss of generality to be a suitable multiple, as described in [Wit91], of the Killing form on \mathfrak{g} denoted by $\text{Tr}_{\mathfrak{g}}$. Then Yang-Mills theory on Σ is defined by the $\text{Aut}(P)$ -invariant action functional of $(P, A) \in \text{Bun}_G^{\nabla}(\Sigma)$ given by

$$S_{\text{YM}}(P, A) := \frac{1}{4e^2} \int_{\Sigma} \text{Tr}_{\mathfrak{g}}(F_A \wedge \star F_A) , \quad (2.2)$$

where e is the gauge coupling constant.

The Yang-Mills action functional transforms under φ according to

$$\text{Tr}_{\mathfrak{g}}(F_A \wedge \star F_A) \xrightarrow{\varphi} \text{Tr}_{\mathfrak{g}}(\varphi_*(F_A) \wedge \star \varphi_*(F_A)) ,$$

where φ_* again acts only on the Lie algebra part. The invariance of the action functional $S_{\text{YM}}(P, A)$ then follows from the fact that the Killing form is preserved by Lie algebra automorphisms. This shows that φ induces a symmetry of the gauge theory at the classical level.

However, this does not necessarily extend to a symmetry at the quantum level. To define the quantum gauge theory, we note that the tangent space at any point $(P, A) \in \text{Bun}_G^{\nabla}(\Sigma)$ can be identified with $\Omega^1(\Sigma; \text{Ad}(P))$, and thus an $\text{Aut}(P)$ -invariant symplectic form on $\text{Bun}_G^{\nabla}(\Sigma)$ can be defined by [AB82]

$$\omega(A_1, A_2) = \frac{1}{4\pi^2} \int_{\Sigma} \text{Tr}_{\mathfrak{g}}(A_1 \wedge A_2) , \quad (2.3)$$

for any two $\text{Ad}(P)$ -valued one-forms A_1 and A_2 on Σ . This formally induces an $\text{Aut}(P)$ -invariant symplectic measure on the infinite-dimensional space $\text{Bun}_G^{\nabla}(\Sigma)$ which we denote by $\mathcal{D}(P, A)$. Two-dimensional quantum Yang-Mills theory is then defined by the partition function which is given as the formal Euclidean path integral

$$Z_{\text{YM}}(\Sigma, G, e^2 a) := \int_{\text{Bun}_G^{\nabla}(\Sigma)} \mathcal{D}(P, A) \exp(-S_{\text{YM}}(P, A)) . \quad (2.4)$$

The partition function is invariant under area-preserving diffeomorphisms of the Riemann surface Σ , and so depends on e and the metric of Σ only through the combination $e^2 a$ [Wit91, CMR95]. It is therefore possible to set $e = 1$ without loss of generality and consider all amplitudes of the gauge theory as functions of the area a . In this sense two-dimensional Yang-Mills theory is a mild variant of a topological field theory that is an example of an ‘area-dependent quantum field theory’.

Now the same arguments used to establish invariance of the classical Yang-Mills action functional under the symmetry φ show that the symplectic form (2.3) is preserved by φ . Thus the partition function (2.4) is *formally* invariant under the symmetry φ . However, the definition of the formal path integral (2.4) requires a suitable regularisation to make it mathematically well-defined, and it may be that there is no regularisation which preserves the symmetry; in such a case the symmetry is anomalous and the partition function is not invariant. We will show in Section 2.3 below, using the lattice regularisation of two-dimensional Yang-Mills theory, that indeed the quantum gauge theory is also invariant under the symmetry induced by the outer automorphism $\varphi : G \rightarrow G$. Different prescriptions for defining the path integral in (2.4) will differ by a renormalisation ambiguity depending on the topology and area of Σ as [Wit91, Wit92]

$$\Delta S = v_1 \chi(\Sigma) + v_2 e^2 a \quad (2.5)$$

for arbitrary constants $v_1, v_2 \in \mathbb{R}$, where $\chi(\Sigma)$ is the Euler characteristic of Σ ; this respects the invariance under area-preserving diffeomorphisms and just multiplies the partition function by a constant factor $\exp(-\Delta S)$. The parameters v_1, v_2 depend only on the gauge group G and the renormalisation scheme, but not on the area or topology of the surface Σ .

At this stage though we can already see how the symmetry acts on the Hilbert space of wavefunctions. The quantum Hilbert space of the gauge theory on a Cauchy circle S^1 in Σ consists of gauge-invariant functions from the collection of principal bundles with connection on S^1 to \mathbb{C} . The only gauge-invariant quantity that one can associate to a G -bundle with connection over S^1 is the conjugacy class of its holonomy around the circle. Hence the state space is given by the Hilbert space

$$Z_{\text{YM}}(S^1, G) = C\ell^2(G) := L^2(G)^{\text{Ad}(G)}$$

of class functions on G . The collection of characters χ_α of unitary irreducible representations α of G provide a natural basis for the state space. The symmetry acts unitarily on this Hilbert space by sending a class function $f: G \rightarrow \mathbb{C}$ to the function $f \circ \varphi^{-1}$.

The Hamiltonian H_{YM} of the gauge theory associated to any foliation of the surface Σ is given in terms of the quadratic Casimir operator C_2 by [CMR95, Wit92]

$$H_{\text{YM}} = \frac{e^2}{2} L C_2 + e^2 L v_2, \quad (2.6)$$

where L is the length of the Cauchy circle. The Hamiltonian operator (2.6) is the generator of time translations. The time evolution operator $\exp(-T H_{\text{YM}})$ is parameterised by the elapsed time $0 \leq T \leq \frac{a}{L}$, and its action on the character basis is given by

$$\exp(-T H_{\text{YM}}) \chi_\alpha = \exp\left(-e^2 L T \left(\frac{C_2(\alpha)}{2} + v_2\right)\right) \chi_\alpha.$$

The symmetry maps χ_α to $\chi_{\varphi^*\alpha}$, and thus commutes with the time evolution operator since the invariance of the Killing form implies $C_2(\alpha) = C_2(\varphi^*\alpha)$: The action of φ on the Casimir operator C_2 can be interpreted as a change of basis in the Lie algebra corresponding to the Lie algebra automorphism φ_* , which preserves the Killing form and hence maps dual coordinates to dual coordinates. As a result, it only changes the choice of basis for the evaluation of the Casimir operator and leaves its value invariant.

2.2 Defects and twisted bundles

Every symmetry of a quantum field theory comes with a corresponding invertible codimension one topological defect, such that passing a field through the defect corresponds to the action of the symmetry on the field, as illustrated in Figure 1. In general, different defects can join at lower-dimensional submanifolds. In the following we give a geometric description of the partition function of two-dimensional Yang-Mills theory with gauge group G in the presence of an arbitrary network of defects corresponding to the symmetry discussed in Section 2.1.

A *defect network* on the surface Σ is determined by a triangulation of Σ , a choice of an orientation, and an element in $\text{Out}(G)$ for every edge of the triangulation; the defect network represents the dual triangulation. Since $\text{Out}(G)$ is a finite group, we require that around every vertex the product of all three elements in $\text{Out}(G)$ is id_G (taking the orientation into account as explained below). The elements of $\text{Out}(G)$ describe the types of defects corresponding to the edges. Edges labeled with id_G are interpreted as the absence of any defects (the trivial defects). This condition

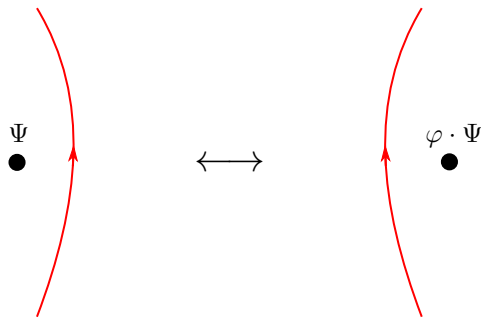

Figure 1: A defect corresponding to the symmetry φ , indicated by the directed lines. A field insertion Ψ moving through the defect corresponds to the action of φ on Ψ .

thus expresses the fact that a defect with label φ and a defect with label φ' can fuse at a codimension two junction to give a defect with label $\varphi\varphi'$, and it allows us to express the labels as a consistent configuration of domain walls throughout Σ .

Fix a defect network on Σ . It defines a principal $\text{Out}(G)$ -bundle on Σ as follows: For every face i of the triangulation we pick an open neighbourhood U_i which is only “slightly bigger” than the face. If there is an edge of the triangulation between U_i and U_j , we set the transition function from the left of the defect to the right equal to the label of the corresponding edge. This is possible since we have picked an orientation for every edge. If the intersection of U_i and U_j is non-empty but there is no edge between them, then we can go from U_i to U_j by passing through a finite number of neighbourhoods for which there exists an edge for any transition. The transition function $U_{ij} \rightarrow \text{Out}(G)$ is then uniquely fixed by the cocycle condition. The consistency condition implies that this defines an $\text{Out}(G)$ -bundle, which we call D . Since $\text{Out}(G)$ is a finite group, D carries a unique flat connection. The parallel transport from the centre of one face to an adjacent centre can be described by the action of the element labeling the edge between the two faces. Hence passing to the dual triangulation provides the holonomy description of the bundle D on Σ .

The semi-direct product $G \rtimes \text{Out}(G)$ is the group with elements $(g, \varphi) \in G \times \text{Out}(G)$ and multiplication

$$(g, \varphi) \bullet (g', \varphi') := (g\varphi(g'), \varphi\varphi') .$$

The projection onto the second factor $G \rtimes \text{Out}(G) \rightarrow \text{Out}(G)$ is a group homomorphism and hence induces a map $\text{Bun}_{G \rtimes \text{Out}(G)}^\nabla(\Sigma) \rightarrow \text{Bun}_{\text{Out}(G)}^\nabla(\Sigma)$. A D -twisted G -bundle with connection is a $G \rtimes \text{Out}(G)$ -bundle with connection such that the induced $\text{Out}(G)$ -bundle is isomorphic to D . We denote by $\text{Bun}_{G \downarrow D}^\nabla(\Sigma)$ the space of D -twisted G -bundles with connection on Σ . A more precise but abstract definition states that the space of D -twisted G -bundles with connection is the homotopy fibre of the map $\text{Bun}_{G \rtimes \text{Out}(G)}^\nabla(\Sigma) \rightarrow \text{Bun}_{\text{Out}(G)}^\nabla(\Sigma)$. An object in this space also comes with a particular choice of isomorphism which we suppress from the present discussion. In the case of discrete gauge groups G , this definition reduces to the notion of relative bundles used in [FSV14] to describe defects in three-dimensional Dijkgraaf-Witten theories.

Twisted bundles implement the defects corresponding to the symmetry introduced in Section 2.1. We can describe a twisted bundle with respect to the same open cover $\{U_i\}$ used to define the $\text{Out}(G)$ -bundle D . The transition functions for a twisted bundle consist of pairs (g_{ij}, φ_{ij}) , where $g_{ij}: U_{ij} \rightarrow G$ and φ_{ij} are fixed to be the transition functions of D (up to isomorphism). Hence g_{ij} are the only free parameters we can choose. On triple overlaps $U_{ijk} = U_i \cap U_j \cap U_k$ the cocycle condition

$$(g_{ki}, \varphi_{ki}) = (g_{kj}, \varphi_{kj}) \bullet (g_{ji}, \varphi_{ji})$$

implies that $g_{ki} = g_{kj} \varphi_{kj}(g_{ji})$, which can be interpreted in the language of defects as the symmetry acting on the transition function g_{ji} when it passes through the defect labeled by φ_{kj} . A connection can be described locally by one-forms $A_i \in \Omega^1(U_i; \mathfrak{g})$. This is the same data as required for a connection on a G -bundle. However, its transformation rule is twisted. For instance, if all g_{ij} are trivial, then on U_{ij} the connection one-forms are required to satisfy

$$A_i = \text{Ad}_{(1, \varphi_{ij})}(A_j) = \varphi_{ij*}(A_j) .$$

This is exactly the action of the symmetry on the connection one-forms introduced in Section 2.1. Gauge transformations of twisted bundles are described by elements $\xi_i \in \Omega^0(U_i; G)$ which, via the embedding $G \hookrightarrow G \rtimes \text{Out}(G)$, induce a gauge transformation of the corresponding $G \rtimes \text{Out}(G)$ -bundle, or in other words gauge transformations of the $G \rtimes \text{Out}(G)$ -bundle which induce the trivial gauge transformation of D .⁷ A gauge transformation ξ_i acts on the transition functions via

$$g_{ij}(x) \xrightarrow{\xi_i} \xi_i(x) g_{ij}(x) \varphi_{ij}(\xi_i(x)^{-1})$$

for all $x \in U_{ij}$.

The Yang-Mills action functional for a twisted bundle is given by the same formula (2.2) for the Yang-Mills action functional of the corresponding $G \rtimes \text{Out}(G)$ -bundle. This action functional locally agrees with the Yang-Mills action functional for G -bundles.

To define the corresponding quantum gauge theory, we note again that a tangent vector to an arbitrary point $(P, A) \in \text{Bun}_{G \downarrow D}^\nabla(\Sigma)$ is an $\text{Ad}(P)$ -valued one-form on Σ , where here $\text{Ad}(P)$ is the vector bundle associated to P by the $G \rtimes \text{Out}(G)$ -action on the Lie algebra \mathfrak{g} . Given two tangent vectors A_1 and A_2 , we can define an $\text{Aut}(P)$ -invariant symplectic pairing by the same formula (2.3). The partition function of two-dimensional quantum Yang-Mills theory in the background of a defect network described by an $\text{Out}(G)$ -bundle D on Σ is then physically defined as the formal path integral

$$Z_{\text{YM}}(\Sigma, G, e^2 a; D) := \int_{\text{Bun}_{G \downarrow D}^\nabla(\Sigma)} \mathcal{D}(P, A) \exp(-S_{\text{YM}}(P, A)) , \quad (2.7)$$

where the integration is taken over the space of D -twisted G -bundles with connection up to gauge transformations and the measure $\mathcal{D}(P, A)$ is induced by the symplectic form. This can be regarded as a part of the partition function of the Yang-Mills theory with gauge group $G \rtimes \text{Out}(G)$. We will come back to this point in Section 2.5.

2.3 Combinatorial quantisation of defect Yang-Mills theory

We will now study the symmetries and defects introduced in Sections 2.1 and 2.2 using the lattice formulation of two-dimensional Yang-Mills theory, as reviewed for example in [Wit91, CMR95]. To discretise the calculation we fix a cell decomposition consisting of an embedded graph which covers the compact oriented surface Σ into vertices $\Sigma^{(0)}$, edges $\Sigma^{(1)}$, and faces $\Sigma^{(2)}$. As the faces are contractible, the only remainders of a principal G -bundle on Σ are its fibre over every vertex, which we can trivialise. A gauge transformation is therefore described by a map $\xi : \Sigma^{(0)} \rightarrow G$. A connection on the bundle is described by its parallel transport, which is a group element $g_\gamma \in G$ for every edge $\gamma \in \Sigma^{(1)}$; if the edge γ joins vertex x to vertex y , then a gauge transformation ξ acts on g_γ by $g_\gamma \mapsto \xi_y g_\gamma \xi_x^{-1}$. The curvature of a connection is a gauge-invariant map $\mathcal{U} : \Sigma^{(2)} \rightarrow G$.

⁷Actually, we work with $G \rtimes \text{Out}(G)$ -gauge transformations that under the map $\text{Bun}_{G \rtimes \text{Out}(G)}^\nabla(\Sigma) \rightarrow \text{Bun}_{\text{Out}(G)}^\nabla(\Sigma)$ relate the two identifications with D .

In the lattice formulation the only gauge-invariant quantity one can construct for a face $w \in \Sigma^{(2)}$ is the (conjugacy class of the) holonomy around the face:

$$\mathcal{U}_w = \prod_{\gamma \in \partial w} g_\gamma ,$$

where the product runs over the boundary edges γ of w ; here we choose an ordering for the multiplication of edges similarly to [RS21].

The path integral can now be defined as an integral over the product group $G^{\times |\Sigma^{(1)}|}$ with respect to its Haar measure, induced from the normalised invariant Haar measure dg on G , which is mathematically well-defined. We still need to understand what to integrate. For this, note that formally we can rewrite the path integral involving an arbitrary local functional $\mathcal{L}(P, A)$ of the gauge fields as

$$\int_{\text{Bun}_G^\nabla(\Sigma)} \mathcal{D}(P, A) \exp\left(-\int_\Sigma \mathcal{L}(P, A)\right) = \int_{\text{Bun}_G^\nabla(\Sigma)} \mathcal{D}(P, A) \prod_{w \in \Sigma^{(2)}} \exp\left(-\int_w \mathcal{L}(P, A)\right) .$$

Hence the integrand is a product over the faces w of the cell decomposition of Σ . We further introduce a local measure on the discretisation by giving an area a_w for every face w . The integration factor is a local function $\Gamma(\mathcal{U}_w, e^2 a_w)$ depending on the holonomy and area associated to w . The correct choice for this local factor which computes the Yang-Mills partition function is [Mig75, Wit91]

$$\Gamma(\mathcal{U}_w, e^2 a_w) := e^{-v_1} \sum_{\alpha \in \hat{G}} \dim \alpha \chi_\alpha(\mathcal{U}_w) \exp\left(-e^2 a_w \left(\frac{C_2(\alpha)}{2} + v_2\right)\right) , \quad (2.8)$$

where the sum runs over all isomorphism classes of unitary irreducible representations α of the gauge group G of dimension $\dim \alpha$ and with character χ_α , and $C_2(\alpha)$ is the value of the quadratic Casimir operator C_2 in the representation α . This factor describes the wavefunction of two-dimensional Yang-Mills theory on a disk [Mig75] which is determined by the heat kernel corresponding to the Hamiltonian (2.6). In general it involves the constants $v_1, v_2 \in \mathbb{R}$ from (2.5) depending on the renormalisation scheme, where we used $\chi(w) = 1$.⁸

The partition function on Σ in this lattice regularisation is now defined as

$$Z_{\text{YM}}(\Sigma, G, e^2 a) := \int_{G^{\times |\Sigma^{(1)}|}} \prod_{\gamma \in \Sigma^{(1)}} dg_\gamma \prod_{w \in \Sigma^{(2)}} \Gamma(\mathcal{U}_w, e^2 a_w) ,$$

where $a = \sum_{w \in \Sigma^{(2)}} a_w$. This partition function is independent of the chosen cell decomposition of Σ [Wit91] and hence agrees with its continuum limit where the lattice discretisation becomes finer and finer: the heat kernel defines a renormalisation group-invariant amplitude on the faces so that the partition function is invariant under subdivision of the lattice. This feature is special to Yang-Mills theory in two dimensions, and for this reason the lattice regularisation of the quantum gauge theory actually computes the partition function (2.4) exactly (up to the undetermined constants v_1 and v_2).

At this stage we can come back to the question of whether $\varphi \in \text{Out}(G)$ induces a symmetry of the gauge theory at the quantum level. Since the pullback of the Haar measure along φ is invariant and normalised, it follows from the uniqueness of the Haar measure that the integration measure is

⁸The explicit expressions for the partition functions below may then be alternatively derived by using standard glueing rules from topological field theory, as in [RS21], and the additivity of the Euler characteristic under disjoint unions, together with the fact that pairs of pants have Euler characteristic -1 .

preserved under φ . The action on the group element associated to an edge is given by applying φ to it, since this describes the action on the parallel transport. Hence the integration factor transforms as

$$\begin{aligned} \Gamma(\mathcal{U}_w, e^2 a_w) &\xrightarrow{\varphi} e^{-v_1} \sum_{\alpha \in \widehat{G}} \dim \alpha \chi_\alpha(\varphi(\mathcal{U}_w)) \exp\left(-e^2 a_w \left(\frac{C_2(\alpha)}{2} + v_2\right)\right) \\ &= e^{-v_1} \sum_{\alpha \in \widehat{G}} \dim \alpha \chi_{\varphi^* \alpha}(\mathcal{U}_w) \exp\left(-e^2 a_w \left(\frac{C_2(\alpha)}{2} + v_2\right)\right). \end{aligned}$$

Now notice that the dimensions of the representations α and $\varphi^* \alpha$ are the same. The value of the quadratic Casimir operator C_2 is also the same in both representations, as discussed at the end of Section 2.1. Combining everything we get⁹

$$\Gamma(\mathcal{U}_w, e^2 a_w) \xrightarrow{\varphi} e^{-v_1} \sum_{\alpha \in \widehat{G}} \dim \varphi^* \alpha \chi_{\varphi^* \alpha}(\mathcal{U}_w) \exp\left(-e^2 a_w \left(\frac{C_2(\varphi^* \alpha)}{2} + v_2\right)\right) = \Gamma(\mathcal{U}_w, e^2 a_w)$$

where in the last step we used the fact that φ^* is a bijection on the set of isomorphism classes of irreducible representations. Since the lattice regularisation of the quantum gauge theory agrees with the continuum limit, this shows that φ induces an actual symmetry at the quantum level.

Let us now explicitly compute the partition function for a defect corresponding to the symmetry in terms of the combinatorial data of the discretisation of Σ . The cellular description provided in this section is dual to that of the triangulation used to define a defect network in Section 2.2; here defects correspond to turning edges of the cell decomposition into symmetry twist branch cuts on Σ . A defect or domain wall corresponding to a symmetry can be implemented by performing the path integral over field configurations which change by the symmetry when passing through the domain wall. In the lattice gauge theory approach this has a simple implementation: When calculating the holonomy around a face we count an edge γ labeled by $g_\gamma \in G$ which passes through a defect corresponding to φ as g_γ to the left of the defect and as $\varphi(g_\gamma)$ to the right of the defect. A straightforward calculation shows that contractible defects do not change the value of the partition function, so in the following we focus on defects which wrap around non-contractible cycles of the surface Σ .

As a warm up, let us begin by calculating the partition function on a genus one surface, which is a torus $\Sigma_1 = T^2$, with a single non-contractible defect line labeled by $\varphi \in \text{Out}(G)$. We pick a cell decomposition of T^2 with two edges and the defect as illustrated in Figure 2. For the path

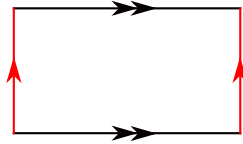

Figure 2: Cell decomposition of T^2 into a rectangle with parallel edges identified. The defect is along the vertical edge.

integral we have to specify the parallel transport along two edges. The partition function can then

⁹This is also demonstrated in [RS21, Lemma 5.14] from an algebraic perspective, where it is shown that the outer automorphism φ induces an isomorphism of commutative regularised Frobenius algebras.

be easily computed to give

$$\begin{aligned}
Z_{\text{YM}}(T^2, G, e^2 a; \varphi) &= \int_{G \times G} dg dh \sum_{\alpha \in \widehat{G}} \dim \alpha \chi_\alpha(\varphi(h)^{-1} g^{-1} h g) \exp\left(-e^2 a \left(\frac{C_2(\alpha)}{2} + v_2\right)\right) \\
&= \int_G dh \sum_{\alpha \in \widehat{G}} \chi_\alpha(\varphi(h)^{-1}) \chi_\alpha(h) \exp\left(-e^2 a \left(\frac{C_2(\alpha)}{2} + v_2\right)\right) \\
&= \int_G dh \sum_{\alpha \in \widehat{G}} \chi_{\varphi^* \alpha}(h^{-1}) \chi_\alpha(h) \exp\left(-e^2 a \left(\frac{C_2(\alpha)}{2} + v_2\right)\right) \\
&= \sum_{\substack{\alpha \in \widehat{G} \\ \alpha = \varphi^* \alpha}} \exp\left(-e^2 a \left(\frac{C_2(\alpha)}{2} + v_2\right)\right),
\end{aligned}$$

where we used $\chi(T^2) = 0$ and $\chi_\alpha(1) = \dim \alpha$, together with the orthonormality and fusion relations for the characters:

$$\begin{aligned}
\int_G dg \chi_\alpha(Ag) \chi_\beta(g^{-1}B) &= \delta_{\alpha,\beta} \frac{1}{\dim \alpha} \chi_\alpha(AB), \\
\int_G dg \chi_\alpha(AgB) &= \frac{1}{\dim \alpha} \chi_\alpha(A) \chi_\alpha(B),
\end{aligned} \tag{2.9}$$

with $A, B \in G$. Setting $e = 1$ for the renormalisation scheme with $v_2 = 0$, this reproduces the result of [RS21]. Representations $\alpha \in \widehat{G}$ for which $\varphi^* \alpha = \alpha$ are called *fixed point representations* of the automorphism φ in [FSS96].

This calculation can be generalised to an arbitrary connected Riemann surface Σ_p of genus $p > 1$ and area a containing p defects, as illustrated in Figure 3, labeled by group outer automorphisms $\varphi_1, \dots, \varphi_p \in \text{Out}(G)$. Using the integral formulas (2.9), we then compute

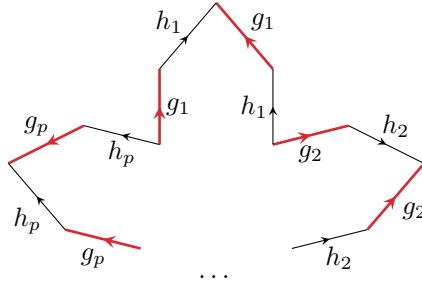

Figure 3: Cell decomposition of Σ_p into a $4p$ -gon with edges of the same label identified. The defects are labeled by h_i .

$$\begin{aligned}
Z_{\text{YM}}(\Sigma_p, G, e^2 a; \varphi_1, \dots, \varphi_p) &= e^{v_1(2p-2)} \int_{G^{\times 2p}} \prod_{j=1}^p dg_j dh_j \sum_{\alpha \in \widehat{G}} \dim \alpha \chi_\alpha \left(\prod_{i=1}^p g_i h_i \varphi_i(g_i^{-1}) h_i^{-1} \right) \\
&\quad \times \exp \left(-e^2 a \left(\frac{C_2(\alpha)}{2} + v_2 \right) \right) \\
&= e^{v_1(2p-2)} \int_{G^{\times (2p-1)}} dg_p \prod_{j=1}^{p-1} dg_j dh_j \sum_{\alpha \in \widehat{G}} \chi_\alpha \left(g_p \prod_{i=1}^{p-1} g_i h_i \varphi_i(g_i^{-1}) h_i^{-1} \right) \chi_{\varphi_p^* \alpha}(g_p^{-1}) \\
&\quad \times \exp \left(-e^2 a \left(\frac{C_2(\alpha)}{2} + v_2 \right) \right) \\
&= e^{v_1(2p-2)} \int_{G^{\times (2p-2)}} \prod_{j=1}^{p-1} dg_j dh_j \sum_{\alpha \in \widehat{G}} \frac{\delta_{\alpha, \varphi_p^* \alpha}}{\dim \alpha} \chi_\alpha \left(\prod_{i=1}^{p-1} g_i h_i \varphi_i(g_i^{-1}) h_i^{-1} \right) \\
&\quad \times \exp \left(-e^2 a \left(\frac{C_2(\alpha)}{2} + v_2 \right) \right)
\end{aligned}$$

where we used $\chi(\Sigma_p) = 2 - 2p$. Proceeding inductively in this way then finally gives

$$\begin{aligned}
Z_{\text{YM}}(\Sigma_p, G, e^2 a; \varphi_1, \dots, \varphi_p) &= e^{v_1(2p-2)} \sum_{\substack{\alpha \in \widehat{G} \\ \alpha = \varphi_1^* \alpha = \dots = \varphi_p^* \alpha}} (\dim \alpha)^{2-2p} \exp \left(-e^2 a \left(\frac{C_2(\alpha)}{2} + v_2 \right) \right) \tag{2.10}
\end{aligned}$$

for the Yang-Mills partition function on an oriented Riemann surface Σ_p of genus p with defects labeled by $\varphi_1, \dots, \varphi_p \in \text{Out}(G)$ around non-contractible cycles of Σ_p . When all defects are trivial, $\varphi_i = \text{id}_G$ for $i = 1, \dots, p$, this combinatorial expression is just the usual Migdal-Rusakov heat kernel expansion for the partition function of Yang-Mills theory on Σ_p [Mig75, Rus90, Wit91, BT92, CMR95]. In general it agrees with the computation of [RS21, Proposition 5.17] for the particular defect configuration at hand.

In at least simple cases, the partition function (2.10) can be computed explicitly using the combinatorics of Dynkin diagrams. For this, recall that outer automorphisms of a semi-simple Lie algebra \mathfrak{g} are in one-to-one correspondence with automorphisms of the underlying Dynkin diagram. Let $(C_{i,j})_{i,j \in I_r}$ be the Cartan matrix encoded by the corresponding Dynkin diagram, where $I_r = \{1, \dots, r\}$ and r is the rank of \mathfrak{g} . An automorphism of the Dynkin diagram is a bijective map $\varphi: I_r \rightarrow I_r$ which preserves the entries of the Cartan matrix: $C_{i,j} = C_{\varphi(i), \varphi(j)}$ for all $i, j \in I_r$. Associated to the Dynkin diagram is a Cartan-Weyl basis of Chevalley generators $\{H_i, E_i^\pm\}_{i \in I_r}$ of \mathfrak{g} in which φ induces the outer automorphism

$$\varphi: \mathfrak{g} \longrightarrow \mathfrak{g}, \quad (H_i, E_i^\pm) \xrightarrow{\varphi} (H_{\varphi(i)}, E_{\varphi(i)}^\pm)$$

of \mathfrak{g} . This in turn induces an isomorphism between the group of symmetries of the underlying Dynkin diagram and the group of outer automorphisms of the Lie algebra \mathfrak{g} , see for example [FSS96]. Let $\mathfrak{h} \subset \mathfrak{g}$ be the Cartan subalgebra spanned by H_i . Then the automorphism φ induces an action on the weight space \mathfrak{h}^* given by pullback

$$\varphi^*: \mathfrak{h}^* \longrightarrow \mathfrak{h}^*, \quad \lambda(x) \xrightarrow{\varphi^*} (\varphi^* \lambda)(x) := \lambda(\varphi^{-1}(x)).$$

A weight vector λ is *symmetric* if $\varphi^* \lambda = \lambda$. If α is an irreducible representation of \mathfrak{g} with highest weight vector v of weight λ_α , then v is also a highest weight vector for the representation $\varphi^* \alpha$ with

weight $\varphi^* \lambda_\alpha$ [FSS96, Section 4]. For the calculation of the partition function (2.10), we thus have to restrict to representations with symmetric highest weight.

The highest weights corresponding to irreducible representations of \mathfrak{g} can be uniquely expressed as

$$\lambda = \sum_{i=1}^r n_i \omega_i ,$$

where ω_i are the fundamental weights and $n_i \in \mathbb{N}_0$ for $i = 1, \dots, r$. The non-negative integers n_i are the *Dynkin labels* of the corresponding representation. The action of φ on the fundamental weights is given by $\varphi^* \omega_i = \omega_{\varphi(i)}$. Hence a representation α is symmetric if and only if the corresponding Dynkin labels are invariant under the transformation

$$[n_1, \dots, n_r] \xrightarrow{\varphi} [n_{\varphi^{-1}(1)}, \dots, n_{\varphi^{-1}(r)}] .$$

The Dynkin labels can be used to concretely calculate the partition function (2.10) for a genus p surface Σ_p containing defects: The dimension and quadratic Casimir invariant of an irreducible unitary representation with highest weight λ are given by

$$\dim \lambda = \prod_{\alpha \in \mathfrak{A}_+} \frac{(\lambda + \rho, \alpha)_{\mathfrak{g}^*}}{(\rho, \alpha)_{\mathfrak{g}^*}} \quad \text{and} \quad C_2(\lambda) = (\lambda + 2\rho, \lambda)_{\mathfrak{g}^*} ,$$

where $\mathfrak{A}_+ \subset \mathfrak{h}^*$ is the system of positive roots of the Lie algebra \mathfrak{g} , $\rho = \frac{1}{2} \sum_{\alpha \in \mathfrak{A}_+} \alpha$ is the Weyl vector, and the invariant bilinear form $(\cdot, \cdot)_{\mathfrak{g}^*}$ on \mathfrak{g}^* is induced by the Killing form of \mathfrak{g} .

Example 2.11. The Lie group $G = SU(3)$ has rank $r = 2$ and hence every irreducible representation can be labeled by a pair of non-negative integers $[n, m]$. $SU(3)$ admits only one non-trivial outer automorphism φ corresponding to complex conjugation, which acts on the Dynkin labels by interchanging n and m . Hence $\text{Out}(SU(3)) = \mathbb{Z}_2$ and symmetric representations are real representations which are of the form $[n, n]$. The dimension of the representation $[n, n]$ is $\dim[n, n] = (n+1)^3$, and the value of its quadratic Casimir invariant is $C_2([n, n]) = n(n+2)$. Consider the defect network from Figure 3 with at least one non-trivial defect label φ . Then the partition function (2.10) reads as

$$Z_{\text{YM}}(\Sigma_p, SU(3), e^2 a; \varphi) = e^{v_1(2p-2)} \sum_{n=0}^{\infty} (n+1)^{6-6p} \exp\left(-e^2 a \left(\frac{n(n+2)}{2} + v_2\right)\right) . \quad (2.12)$$

2.4 The moduli space of flat twisted bundles

Let D be an $\text{Out}(G)$ -bundle on a surface Σ . We denote by $\mathcal{M}_G^D(\Sigma)$ the moduli space of flat D -twisted G -bundles on Σ , or in other words pairs $(P, A) \in \text{Bun}_{G \downarrow D}(\Sigma)$ with $F_A = 0$, up to gauge transformations. Up to equivalence we can describe D by a group homomorphism on the fundamental group of Σ : $\kappa_D: \pi_1(\Sigma) \rightarrow \text{Out}(G)$. A flat D -twisted G -bundle P on Σ can then be described by a group homomorphism $\phi'_P: \pi_1(\Sigma) \rightarrow G \rtimes \text{Out}(G)$ which lifts the group homomorphism κ_D in the sense that the diagram

$$\begin{array}{ccc} & & G \rtimes \text{Out}(G) \\ & \nearrow \phi'_P & \downarrow \\ \pi_1(\Sigma) & \xrightarrow{\kappa_D} & \text{Out}(G) \end{array}$$

commutes, where the vertical arrow is the projection to the second factor.

Equivalently, this can be described by a map $\phi_P: \pi_1(\Sigma) \rightarrow G$ satisfying

$$\phi_P(\gamma_1 * \gamma_2) = \phi_P(\gamma_1) \kappa_D(\gamma_1)(\phi_P(\gamma_2)) ,$$

where $\gamma_1 * \gamma_2$ denotes the concatenation of paths on Σ between representatives of the corresponding homotopy classes. Let $\text{Hom}_{\kappa_D}(\pi_1(\Sigma), G)$ denote the space of all such twisted group homomorphisms; for any $\phi \in \text{Hom}_{\kappa_D}(\pi_1(\Sigma), G)$ and any homotopy class of paths $[\gamma] \in \pi_1(\Sigma)$, $\phi(\gamma)$ is the holonomy of a flat D -twisted G -connection along γ . Gauge transformations correspond to the action of the Lie group G on this space via the twisted conjugation

$$g \cdot \phi: \pi_1(\Sigma) \rightarrow G , \quad \gamma \mapsto (g \cdot \phi)(\gamma) = g \phi(\gamma) \kappa_D(\gamma)(g^{-1}) .$$

The moduli space $\mathcal{M}_G^D(\Sigma)$ can be identified with the quotient $\text{Hom}_{\kappa_D}(\pi_1(\Sigma), G)/G$ by this G -action.

In the local triangulation description of defect networks from Section 2.2, a flat D -twisted G -bundle is the same as a D -twisted G -local system on Σ , as defined for example in [Lab13]; one may also characterise it as a groupoid homomorphism from the fundamental groupoid of Σ to the classifying groupoid of $G \rtimes \text{Out}(G)$ -bundles. It is possible to generalise this description to surfaces Σ with boundary circles by using a subgroupoid of the fundamental groupoid, and hence to describe moduli spaces of flat D -twisted G -connections on Σ with holonomies on the boundary components in prescribed twisted conjugacy classes of G , see [Mei17] for further details.

To relate this moduli space to the quantum gauge theory defined in Section 2.2, we note that the weak-coupling limit $e \rightarrow 0$ of the Yang-Mills action functional (2.2) is either 0 or it diverges to $+\infty$, and hence the path integral (2.7) localises onto gauge field configurations with vanishing action functional, or equivalently with vanishing curvature $F_A = 0$; these are precisely the flat twisted bundles. Hence the path integral formally reduces to an integral over $\mathcal{M}_G^D(\Sigma)$. Since the integration measure $\mathcal{D}(P, A)$ is formally induced by the infinite-dimensional symplectic structure (2.3), it is natural to conjecture that the partition function (2.7) computes the symplectic volume of $\mathcal{M}_G^D(\Sigma)$ in the weak-coupling limit, where the symplectic two-form on $\mathcal{M}_G^D(\Sigma)$ is inherited from (2.3). This argument is completely analogous to that given in the case of ordinary Yang-Mills theory in [Wit91].

To describe the weak-coupling limit more precisely as a topological field theory, it is useful to consider an equivalent formulation of the quantum Yang-Mills theory in the presence of defects. For this, recall that a D -twisted G -bundle on Σ can be described by a $G \rtimes \text{Out}(G)$ -bundle P . The curvature F_A of the connection on the bundle P is a two-form on Σ with values in the associated \mathfrak{g} -bundle $\text{Ad}(P)$. We introduce an auxiliary scalar field ϕ on Σ with values in $\text{Ad}(P)$, and consider the action functional

$$S(P, A, \phi) = -i \int_{\Sigma} \text{Tr}_{\mathfrak{g}}(\phi F_A) - \frac{e^2}{2} \int_{\Sigma} d\mu \text{Tr}_{\mathfrak{g}}(\phi^2) .$$

The field ϕ can only be defined after the D -twisted bundle (P, A) is fixed, and the corresponding path integral

$$\int_{\text{Bun}_{G \downarrow D}^{\nabla}(\Sigma)} \mathcal{D}(P, A) \int_{\Omega^0(\Sigma; \text{Ad}(P))} \mathcal{D}\phi \exp(-S(P, A, \phi)) \tag{2.13}$$

is taken over all D -twisted bundles with connections and $\phi \in \Omega^0(\Sigma; \text{Ad}(P))$, where the measure on the space $\Omega^0(\Sigma; \text{Ad}(P))$ is induced by the metric on $\text{Ad}(P)$ given by

$$\|\phi\|^2 := -\frac{1}{4\pi^2} \int_{\Sigma} d\mu \text{Tr}_{\mathfrak{g}}(\phi^2) .$$

Performing the Gaussian path integral over ϕ (or equivalently eliminating ϕ by its Euler-Lagrange equation) shows that the quantum field theory defined by (2.13) is equivalent to the quantum field theory defined by (2.7) for two-dimensional Yang-Mills theory in the presence of symmetry defects. The path integral (2.13) is subject to the same two-parameter renormalisation ambiguity (2.5), which multiplies it by the factor $\exp(-\Delta S)$.

The advantage of this reformulation is that it is straightforward now to take the $e \rightarrow 0$ limit, which is described by the topological field theory with action functional

$$S_0(P, A, \phi) = -i \int_{\Sigma} \text{Tr}_{\mathfrak{g}}(\phi F_A) .$$

At $e = 0$, the invariance under the group of area-preserving diffeomorphisms is promoted to full diffeomorphism invariance, and the ambiguity (2.5) is reduced to a one-parameter ambiguity depending only on the topology of the surface Σ . This looks similar to the quantum field theory describing the weak-coupling limit of Yang-Mills theory without defects [Wit91, Wit92]. The difference is that here ϕ takes values in a different bundle and that the path integral is taken over twisted bundles rather than ordinary bundles. Integrating over ϕ in (2.13) at $e = 0$ produces a formal delta-functional $\delta(F_A)$, and the remaining path integral over $\text{Bun}_{G \downarrow D}^{\nabla}(\Sigma)$ therefore localises on the locus $F_A = 0$, which by definition is the moduli space $\mathcal{M}_G^D(\Sigma)$ of flat D -twisted G -bundles on Σ . In the usual untwisted case [Wit91], the argument showing that the resulting path integral measure induces the correct symplectic volume form on the moduli space $\mathcal{M}_G(\Sigma) \simeq \text{Hom}(\pi_1(\Sigma), G)/G$ of flat G -connections on Σ uses a careful application of Faddeev-Popov gauge fixing and the triviality of analytic torsion on oriented surfaces, together with a judicious choice of v_1 . It should be possible to extend these arguments to the twisted case.

Putting everything together, we conjecture that the symplectic volume of $\mathcal{M}_G^D(\Sigma)$ can be given a gauge theory interpretation via the formula

$$\text{Vol}(\mathcal{M}_G^D(\Sigma)) = e^{-v_1 \chi(\Sigma)} \lim_{e \rightarrow 0} Z_{\text{YM}}(\Sigma, G, e^2 a; D) .$$

Since the undetermined parameter $v_1 \in \mathbb{R}$ depends only on G and the renormalisation scheme, but not on Σ , the ratio

$$\frac{\text{Vol}(\mathcal{M}_G^D(\Sigma))}{\text{Vol}(\mathcal{M}_G(\Sigma))} = \lim_{e \rightarrow 0} \frac{Z_{\text{YM}}(\Sigma, G, e^2 a; D)}{Z_{\text{YM}}(\Sigma, G, e^2 a)}$$

is independent of the choice of the renormalisation scheme. This ratio can thus be computed explicitly using the lattice regularisation of Section 2.3, and used to make concrete predictions for the symplectic volume $\text{Vol}(\mathcal{M}_G^D(\Sigma))$; in the lattice formulation, a connection is flat if $\mathcal{U}_w = 1$ for every face $w \in \Sigma^{(2)}$.

Example 2.14. Let us look again at the simplest non-trivial example of gauge group $G = SU(3)$. From (2.12) we deduce that the volume of $\mathcal{M}_{SU(3)}^D(\Sigma_p)$ is independent of the choice of non-trivial \mathbb{Z}_2 -bundle $D \rightarrow \Sigma_p$. For genus $p \geq 2$ the weak-coupling limit $e \rightarrow 0$ exists and the series sums to give the value of the Riemann zeta-function $\zeta(6p - 6)$. It follows that the symplectic volume in the presence of defects is

$$\text{Vol}(\mathcal{M}_{SU(3)}^D(\Sigma_p)) = \lim_{e \rightarrow 0} Z_{\text{YM}}(\Sigma_p, SU(3), e^2 a; \varphi) = e^{v_1 (2p-2)} \zeta(6p - 6) .$$

The undetermined parameter v_1 can in principal be determined from the results for untwisted bundles; in [Wit91, Wit92] the constant v_1 is evaluated by a direct computation of the Reidemeister torsion. However, in the present case we are not able to determine *a priori* the value of v_1 , so we cannot make a more concrete prediction for the symplectic volume at this stage.

2.5 The orbifold Yang-Mills theory

Given a discrete symmetry of a quantum field theory one can try to gauge the symmetry, or in other words construct a corresponding orbifold theory; the orbifold field theory is constructed by taking the quotient by the symmetry group and projecting the Hilbert space onto the invariant states. In this paper we focus on the defect approach to orbifolds [FFRS09, BCP14] and show that the orbifold theory corresponding to the symmetry introduced in Section 2.1 is the Yang-Mills theory with gauge group $G \rtimes \text{Out}(G)$. We can further naturally twist the orbifold theory by a two-cocycle $c \in H^2(\text{Out}(G); U(1))$ representing the inclusion of discrete torsion. The resulting orbifold theory will then be a two-dimensional Yang-Mills theory based on the structure group $G \rtimes \text{Out}(G)$ with a topological Dijkgraaf-Witten term [DW90] for the finite group $\text{Out}(G)$ added to the Yang-Mills action functional (2.2); this corresponds to coupling the Yang-Mills theory to a two-dimensional symmetry protected topological phase, which is specified by the two-cocycle c and protected by the $\text{Out}(G)$ -symmetry.

Let D_φ denote the defect corresponding to an outer automorphism $\varphi \in \text{Out}(G)$. We construct the orbifold defect as the superposition

$$P_G = \sum_{\varphi \in \text{Out}(G)} D_\varphi ,$$

corresponding to a superposition of $\text{Out}(G)$ -bundles over Σ . The partition function of the orbifold theory on a Riemann surface Σ can be constructed by picking a triangulation of Σ and computing the partition function of the original Yang-Mills theory in the presence of a defect network where every edge of the triangulation is labeled with P_G . The intersections need to be labeled by ‘junction fields’ which introduce an appropriate normalisation; we will explain this in more detail in Section 3. In practice this reduces to a sum over all consistent defect labels of the triangulation with a normalisation factor $\frac{1}{|\text{Out}(G)|^V}$, where V is the number of vertices of the triangulation. Recall from Section 2.2 that, for a fixed defect configuration, the path integral is taken over a subspace of $\text{Bun}_{G \rtimes \text{Out}(G)}^\nabla(\Sigma)$. The sum over all labels for defect lines reduces to a sum over all possible $\text{Out}(G)$ -bundles. As a consequence, the partition function of the orbifold theory can be interpreted as an integral over the entire space $\text{Bun}_{G \rtimes \text{Out}(G)}^\nabla(\Sigma)$. Dividing the result by $|\text{Out}(G)|^V$ takes care of the fact that in Section 2.2 we only divided out G -gauge transformations; the additional normalisation correctly takes care of the discrete part. This indicates that the partition function of the orbifold theory agrees with the partition function of Yang-Mills theory on Σ with gauge group $G \rtimes \text{Out}(G)$. By adding a two-dimensional Dijkgraaf-Witten term for $\text{Out}(G)$ into the sum we can also construct a twisted version of this orbifold Yang-Mills theory with coupling to an $\text{Out}(G)$ -symmetry protected topological phase.

We now turn our attention to the state space of the orbifold theory, which can be constructed by first adding twisted sectors to the original state space to get

$$\mathcal{H}'_G = \bigoplus_{\varphi \in \text{Out}(G)} Z_{\text{YM}}(S^1, G; \varphi) , \tag{2.15}$$

where $Z_{\text{YM}}(S^1, G; \varphi)$ is the state space on a Cauchy circle S^1 in Σ in the presence of a point defect labeled by φ . This is the Hilbert space of gauge-invariant functions on the space of twisted bundles over S^1 . The only gauge-invariant quantity that can be constructed from a twisted bundle on S^1 is its holonomy \mathcal{U} , which transforms under a gauge transformation corresponding to $g \in G$ as $\mathcal{U} \mapsto g\mathcal{U}\varphi(g^{-1})$. This shows that the state space for each twisted sector $\varphi \in \text{Out}(G)$ is given by

$$Z_{\text{YM}}(S^1, G; \varphi) = \{f \in L^2(G) \mid f(g) = f(hg\varphi(h^{-1})) \text{ for all } g, h \in G\} .$$

The Hilbert space $Z_{\text{YM}}(S^1, G; \varphi)$ has a natural basis given by ‘twining characters’, which we describe explicitly following [FSS96] for the special case of semi-simple Lie groups, see also [Zer18]. Let $\omega: G \rightarrow G$ be an outer automorphism of the Lie group G constructed from an automorphism of the corresponding Dynkin diagram, and let $\pi_\alpha: \mathfrak{g} \rightarrow \text{End}(V_\alpha)$ be a corresponding fixed point unitary irreducible highest weight representation: $\omega^* \alpha = \alpha$. Then by Schur’s lemma there exists a unitary automorphism $T_\alpha^\omega: V_\alpha \rightarrow V_\alpha$ such that the diagram

$$\begin{array}{ccc} V_\alpha & \xrightarrow{\pi_\alpha(\omega(v))} & V_\alpha \\ T_\alpha^\omega \downarrow & & \downarrow T_\alpha^\omega \\ V_\alpha & \xrightarrow{\pi_\alpha(v)} & V_\alpha \end{array}$$

commutes for all $v \in V_\alpha$. Since ω only permutes the generators of \mathfrak{g} , it preserves the highest weight space. Requiring T_α^ω to be the identity on the highest weight space thus fixes it uniquely. Then $T_{\omega_2}^\alpha T_{\omega_1}^\alpha = T_{\omega_1 \omega_2}^\alpha$ for any two automorphisms $\omega_1, \omega_2 \in \text{Out}(G)$.

Exponentiating the representation we get a corresponding representation $\pi_\alpha: G \rightarrow \text{End}(V_\alpha)$ of the group G . The twining characters $\chi_\alpha^\omega: G \rightarrow \mathbb{C}$ can now be defined by

$$\chi_\alpha^\omega(g) := \text{tr}_{V_\alpha}(\pi_\alpha(g) T_\omega^\alpha)$$

for $g \in G$. They satisfy the twisted conjugation invariance

$$\begin{aligned} \chi_\alpha^\omega(h g \omega(h^{-1})) &= \text{tr}_{V_\alpha}(\pi_\alpha(h g \omega(h^{-1})) T_\omega^\alpha) \\ &= \text{tr}_{V_\alpha}(\pi_\alpha(h g) T_\omega^\alpha \pi_\alpha(h^{-1}) T_\omega^{\alpha\dagger} T_\omega^\alpha) \\ &= \text{tr}_{V_\alpha}(\pi_\alpha(g) T_\omega^\alpha) \\ &= \chi_\alpha^\omega(g) , \end{aligned}$$

for all $g, h \in G$. Using the orthogonality of the matrix element functions it is easy to show that the twining characters span the Hilbert space $Z_{\text{YM}}(S^1, G; \omega)$ and satisfy a generalisation of the orthonormality and fusion relations (2.9) given by (see also [Zer18])

$$\begin{aligned} \int_G dg \chi_\alpha^\omega(Ag) \chi_\beta^{\omega'}(g^{-1}B) &= \delta_{\alpha,\beta} \frac{1}{\dim \alpha} \chi_\alpha^{\omega' \omega}(AB) , \\ \int_G dg \chi_\alpha^\omega(AgBg^{-1}) &= \frac{1}{\dim \alpha} \chi_\alpha(A) \chi_\alpha(B) , \end{aligned} \tag{2.16}$$

for $A, B \in G$.

We now note that (2.15) is not the Hilbert space of the orbifold theory, because there is a natural $\text{Out}(G)$ -action on \mathcal{H}'_G and the Hilbert space of the orbifold theory is the subspace of invariants. An outer automorphism $\omega \in \text{Out}(G)$ maps $f \in Z_{\text{YM}}(S^1, G; \varphi)$ to $\omega \cdot f \in Z_{\text{YM}}(S^1, G; \omega \varphi \omega^{-1})$ via the linear map corresponding to the defect network illustrated in Figure 4. A straightforward computation using (2.16) and the lattice regularisation shows that the action is given by $\omega \cdot f := f \circ \omega^{-1}$.¹⁰ To describe the space of invariants, we pick a representative C for every conjugacy class of $\text{Out}(G)$. For an automorphism $\varphi \in \text{Out}(G)$, we denote by $\text{Com}(\varphi)$ the commutant of φ in $\text{Out}(G)$, or in other words the subgroup of $\text{Out}(G)$ commuting with φ ; the action of $\text{Com}(\varphi)$ on \mathcal{H}'_G preserves

¹⁰See Proposition 3.22 below for a rigorous proof of this statement.

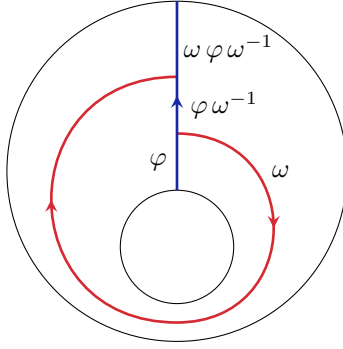

Figure 4: The action of $\omega \in \text{Out}(G)$ on a defect labeled by φ .

$Z_{\text{YM}}(S^1, G; \varphi)$. A description of the state space of the orbifold theory which depends on the choice of conjugacy class \mathcal{C} is then given by

$$\mathcal{H}_{G, \mathcal{C}} = \bigoplus_{\varphi \in \mathcal{C}} Z_{\text{YM}}(S^1, G; \varphi)^{\text{Com}(\varphi)},$$

where we denote by $Z_{\text{YM}}(S^1, G; \varphi)^{\text{Com}(\varphi)}$ the subspace of invariants in $Z_{\text{YM}}(S^1, G; \varphi)$ with respect to the $\text{Com}(\varphi)$ -action.

Now we argue that the Hilbert space $\mathcal{H}_{G, \mathcal{C}}$ is the space $C\ell^2(G \rtimes \text{Out}(G))$ of class functions on the group $G \rtimes \text{Out}(G)$, confirming that the orbifold theory is indeed the Yang-Mills theory based on $G \rtimes \text{Out}(G)$. For this, we note that a conjugation-invariant function on $G \rtimes \text{Out}(G)$ is completely determined by its values on elements of $G \times \mathcal{C} \subset G \rtimes \text{Out}(G)$. Hence we can describe any function $f \in C\ell^2(G \rtimes \text{Out}(G))$ by a family of functions $f_\varphi: G \rightarrow \mathbb{C}$ labeled by the elements $\varphi \in \mathcal{C}$. The value of a function $f_\varphi(g)$ on $g \in G$ transforms under conjugation with respect to elements of the form $(h, 1) \in G \rtimes \text{Out}(G)$ as $f_\varphi(g) \mapsto f_\varphi(h g \varphi(h^{-1}))$. This shows that $f_\varphi \in Z_{\text{YM}}(S^1, G; \varphi)$. The function f_φ is further required to be invariant under conjugation by elements of the form $(1, \omega) \in G \rtimes \text{Out}(G)$ with $\omega \in \text{Com}(\varphi)$, which induces the transformation $f_\varphi \mapsto f_\varphi \circ \omega$. Hence $f_\varphi \in Z_{\text{YM}}(S^1, G; \varphi)^{\text{Com}(\varphi)}$, as required. See Proposition 3.22 below for an explicit description of the inverse map $Z_{\text{YM}}(S^1, G; \varphi)^{\text{Com}(\varphi)} \rightarrow C\ell^2(G \rtimes \text{Out}(G))$.

Generally there are obstructions to the construction of an orbifold theory for a quantum field theory with a discrete symmetry. However, all of these obstructions vanish in the case considered in this paper, since we can construct the orbifold theory explicitly. This is reminiscent of the situation for finite gauge groups where classical symmetries can be described via group extensions by the symmetry group, and the field theory can be gauged if the action functional of the original gauge theory can be lifted to the extension [KT14, MS19]. In the continuous case considered here the extension is given by the semi-direct product

$$1 \longrightarrow G \longrightarrow G \rtimes \text{Out}(G) \longrightarrow \text{Out}(G) \longrightarrow 1,$$

and a lift of the action functional is provided by the action functional of the Yang-Mills theory with gauge group $G \rtimes \text{Out}(G)$.

2.6 The reverse orbifold Yang-Mills theory

It is possible to return back to the original Yang-Mills theory via a generalised orbifold construction. We briefly sketch the construction here and refer to Section 3 for further mathematical details. We denote by W_c a set of representatives for the isomorphism classes $c \in \widehat{\text{Out}(G)}$ of irreducible

representations of $\text{Out}(G)$. Via pullback by the homomorphism $G \rtimes \text{Out}(G) \longrightarrow \text{Out}(G)$, these induce representations of $G \rtimes \text{Out}(G)$ and hence Wilson line defects in the Yang-Mills theory with gauge group $G \rtimes \text{Out}(G)$, which we denote again by W_c . These defects are invertible only if $\text{Out}(G)$ is an abelian group, so that W_c are all one-dimensional vector spaces. But they are always topological defects and, in particular, they are trivial for contractible loops, since the $\text{Out}(G)$ part of the holonomy of any $G \rtimes \text{Out}(G)$ -connection around a contractible loop is trivial.

To reverse the orbifold construction we use the defect

$$\mathcal{A}_G = \bigoplus_{c \in \widehat{\text{Out}(G)}} W_c^{\oplus w_c} \simeq L^2(\text{Out}(G)) , \quad (2.17)$$

where $w_c = \dim W_c$. Only when $\text{Out}(G)$ is an abelian group does this defect come from a symmetry, as in that case (2.17) decomposes into a direct sum of invertible defects. For non-abelian groups $\text{Out}(G)$ we need the generalised orbifold construction of [FFRS09, BCP14] to go backwards. The reason why the choice of defect (2.17) works is that the character of the regular representation $L^2(\text{Out}(G))$ of $\text{Out}(G)$ is given by $\chi_{L^2(\text{Out}(G))}(\kappa) = |\text{Out}(G)| \delta_{\kappa, \text{id}_G}$ for $\kappa \in \text{Out}(G)$. Inserting a Wilson loop corresponding to \mathcal{A}_G into the path integral for a Riemann surface Σ localises the integration domain to $G \rtimes \text{Out}(G)$ -bundles with trivial $\text{Out}(G)$ holonomy around the inserted loop. If at least one Wilson loop for every generator of the fundamental group $\pi_1(\Sigma)$ labeled by \mathcal{A}_G is inserted into the path integral, then the $\text{Out}(G)$ part of all bundles contributing to the partition function is trivial and hence the partition function reduces to the partition function (2.4) of Yang-Mills theory with gauge group G . We will prove this rigorously in Section 3 using the orbifold completion of the topological defect bicategory of two-dimensional Yang-Mills theories.

We conclude by describing the reverse orbifold Yang-Mills theory in the lattice regularisation of Section 2.3. To compute the orbifold gauge theory we have to evaluate the partition function in the presence of a sufficiently dense defect network labeled by (2.17) with appropriate junction fields inserted. The junction fields correspond to the pointwise multiplication of functions and the comultiplication

$$\begin{aligned} \Delta: L^2(\text{Out}(G)) &\longrightarrow L^2(\text{Out}(G)) \otimes L^2(\text{Out}(G)) \simeq L^2(\text{Out}(G) \times \text{Out}(G)) , \\ [\kappa \mapsto f(\kappa)] &\longmapsto [(\kappa_1, \kappa_2) \mapsto \delta_{\kappa_1, \kappa_2} f(\kappa_1)] . \end{aligned}$$

These maps are homomorphisms of $\text{Out}(G)$ -representations and hence induce homomorphisms between the corresponding representations of $G \rtimes \text{Out}(G)$. The associated junction fields are then given by

$$\begin{aligned} \sum_{\kappa \in \text{Out}(G)} \kappa \otimes \kappa \otimes \delta_{\kappa, \text{id}_G} &\in \mathbb{C}[\text{Out}(G)] \otimes \mathbb{C}[\text{Out}(G)] \otimes L^2(\text{Out}(G)) , \\ \sum_{\kappa \in \text{Out}(G)} \kappa \otimes \delta_{\kappa, \text{id}_G} \otimes \delta_{\kappa, \text{id}_G} &\in \mathbb{C}[\text{Out}(G)] \otimes L^2(\text{Out}(G)) \otimes L^2(\text{Out}(G)) , \end{aligned} \quad (2.18)$$

where we identify the complex vector space $\mathbb{C}[\text{Out}(G)]$ generated by the elements of $\text{Out}(G)$ with the dual of $L^2(\text{Out}(G))$.

To compute the partition function in the presence of a defect network D containing only trivalent vertices with one or two ingoing edges, we proceed as follows. We pick a triangulation agreeing with the defect network and integrate over all lattice gauge fields as

$$\begin{aligned} W_{\text{YM}}(\Sigma, G \rtimes \text{Out}(G), e^2 a; D) &:= \frac{1}{|\text{Out}(G)|^N} \sum_{(\kappa_\gamma) \in \text{Out}(G)^{\times |\Sigma^{(1)}|}} \int_{G^{\times |\Sigma^{(1)}|}} \prod_{\gamma \in \Sigma^{(1)}} dg_\gamma \mathcal{W}_D((g_\gamma, \kappa_\gamma)) \\ &\quad \times \prod_{w \in \Sigma^{(2)}} \Gamma(\mathcal{U}_w, e^2 a_w) , \end{aligned}$$

where $a = \sum_{w \in \Sigma^{(2)}} a_w$, the sum is over (flat) $\text{Out}(G)$ -bundles on the triangulation of the surface Σ , N is an appropriate normalisation power, and $\Gamma(\mathcal{U}_w, e^2 a_w)$ is the same local function (2.8) as for the Yang-Mills theory based on the gauge group G ,¹¹ but now with the holonomies \mathcal{U}_w computed for the $G \rtimes \text{Out}(G)$ -bundle with parallel transport $(g_\gamma, \kappa_\gamma)$ along the edges $\gamma \in \partial w$. The quantity $\mathcal{W}_D((g_\gamma, \kappa_\gamma))$ is the value of the corresponding Wilson line observable for the $G \rtimes \text{Out}(G)$ -bundle described by the elements $(g_\gamma, \kappa_\gamma) \in G \rtimes \text{Out}(G)$ for $\gamma \in \Sigma^{(1)}$, which can be computed as follows: Combining the junction fields (2.18) for all vertices defines an element in $\mathbb{C}[\text{Out}(G)]^{\otimes |\Sigma^{(1)}|} \otimes L^2(\text{Out}(G))^{\otimes |\Sigma^{(1)}|}$. To produce a complex number from this we act on the elements of $\mathbb{C}[\text{Out}(G)]$ with the group element of the corresponding edge, and then apply to it the function in $L^2(\text{Out}(G))$ corresponding to the endpoint of the edge; this defines \mathcal{W}_D . The form of the junction fields (2.18) implies that an edge $\gamma_{x,y}$ between two vertices $x, y \in \Sigma^{(0)}$ induces a delta-function between the sums for the different vertices of the form $\delta_{\kappa_{\gamma_{x,y}} \kappa_x, \kappa_y}$. This implies that \mathcal{W}_D is non-zero if and only if the parallel transport around every loop has trivial part in $\text{Out}(G)$. In this case we can apply a gauge transformation to set all $\kappa_\gamma = \text{id}_G$. Restricting to elements with all $\kappa_\gamma = \text{id}_G$ cancels the factor $|\text{Out}(G)|^N$ in the partition function W_{YM} . Hence we are left with the partition function for Yang-Mills theory with gauge group G , showing that the reverse orbifold theory is the Yang-Mills theory we started with:

$$W_{\text{YM}}(\Sigma, G \rtimes \text{Out}(G), e^2 a; D) = Z_{\text{YM}}(\Sigma, G, e^2 a) .$$

3 Generalised orbifold of functorial defect Yang-Mills theory

In this section we gauge the $\text{Out}(G)$ -symmetry of two-dimensional Yang-Mills theory using the generalised orbifold construction [FFRS09, CR16, BCP14, CRS19] of a functorial defect quantum field theory. We start by recalling the notion of area-dependent quantum field theories and their state sum constructions in Section 3.1. Then we give a detailed description of the bicategory of topological defects of two-dimensional Yang-Mills theories in Section 3.2, and in Section 3.3 we discuss the regularised Frobenius algebras constructed from a Lie group and its outer automorphism group. Finally, in Section 3.4 we gauge the $\text{Out}(G)$ -symmetry, and using an orbifold equivalence in the orbifold completion of the topological defect bicategory we give the defect for the reverse orbifold in Section 3.5.

3.1 State sum area-dependent quantum field theory with defects

We begin by briefly reviewing the state sum construction of two-dimensional area-dependent quantum field theory with defects [RS21]. We define area-dependent quantum field theories in the spirit of [Ati88, Seg88, Seg89] as symmetric monoidal functors from a bordism category into an appropriate target category. Then we recall some details of the state sum construction, and discuss transmissive defects which are the topological defects in area-dependent theories.

An *area-dependent quantum field theory* is a symmetric monoidal functor from the category of two-dimensional bordisms with area $\mathcal{Bord}_2^{\text{area}}$ to the category of Hilbert spaces \mathcal{Hilb} . In the former category the objects are disjoint unions of oriented circles, and the morphisms are oriented bordisms up to diffeomorphism together with a positive (and possibly zero for cylinders) real number assigned to each connected component, which we think of as an area. The morphism sets naturally come with a topology induced by the areas of the connected components of surfaces. In the category of Hilbert spaces one can choose many different topologies on morphism sets, but for our purposes the strong operator topology will be relevant. For an area-dependent quantum field theory, in addition

¹¹As in Section 2.3, this is the case because locally both gauge theories agree.

to being symmetric monoidal, we require the bounded linear operators assigned to bordisms to be continuous in the area parameters.

Area-dependent quantum field theories (without defects) are completely defined by a variation of the notion of a Frobenius algebra, analogously to two-dimensional topological field theories. A *regularised Frobenius algebra* consists of a Hilbert space A together with families of maps $\mu_a : A \otimes A \rightarrow A$ (products), $\eta_a : \mathbb{C} \rightarrow A$ (units), $\Delta_a : A \rightarrow A \otimes A$ (coproducts) and $\varepsilon_a : A \rightarrow \mathbb{C}$ (counits) which are continuous in the parameter $a \in \mathbb{R}_{>0}$ with respect to the strong operator topology. These are required to satisfy parameterised versions of associativity, unitality, coassociativity, and counitality:

$$\begin{aligned} \mu_a \circ (\mu_b \otimes \text{id}_A) &= \mu_{a'} \circ (\text{id}_A \otimes \mu_{b'}) , & \mu_a \circ (\eta_b \otimes \text{id}_A) &= \mu_{a'} \circ (\text{id}_A \otimes \eta_{b'}) =: P_{a+b} , \\ (\Delta_b \otimes \text{id}_A) \circ \Delta_a &= (\text{id}_A \otimes \Delta_{b'}) \circ \Delta_{a'} , & (\varepsilon_b \otimes \text{id}_A) \circ \Delta_a &= (\text{id}_A \otimes \varepsilon_{b'}) \circ \Delta_{a'} = P_{a+b} , \end{aligned} \quad (3.1)$$

and of the Frobenius relation

$$\Delta_a \circ \mu_b = (\text{id}_A \otimes \mu_{b'}) \circ (\Delta_{a'} \otimes \text{id}_A) = (\mu_{b'} \otimes \text{id}_A) \circ (\text{id}_A \otimes \Delta_{a'}) , \quad (3.2)$$

for all parameters $a, a', b, b' \in \mathbb{R}_{>0}$ with $a + b = a' + b'$, where the map $P_a : A \rightarrow A$ satisfies

$$\lim_{a \rightarrow 0} P_a = \text{id}_A$$

in the strong operator topology.

We will heavily rely on the graphical calculus for (strict) symmetric monoidal categories, in order to simplify the presentation of our calculations. We present a morphism $f : A \rightarrow B$ as

$$\begin{array}{c} B \\ | \\ \boxed{f} \\ | \\ A \end{array}$$

and the identity morphisms with a straight line

$$\text{id}_A = \begin{array}{c} A \\ | \\ \\ | \\ A \end{array}$$

Composition corresponds to stacking, the tensor product of objects and morphisms is

$$\begin{array}{c} B \otimes B' \\ | \\ \boxed{f \otimes f'} \\ | \\ A \otimes A' \end{array} = \begin{array}{cc} \begin{array}{c} B \\ | \\ \boxed{f} \\ | \\ A \end{array} & \begin{array}{c} B' \\ | \\ \boxed{f'} \\ | \\ A' \end{array} \end{array}$$

and the symmetric braiding is denoted by a crossing

$$\sigma_{A,B} = \begin{array}{c} B \quad A \\ \diagdown \quad \diagup \\ \quad \times \\ \diagup \quad \diagdown \\ A \quad B \end{array}$$

For more details on this graphical calculus, see for example [Kas94].

The structure maps of a regularised Frobenius algebra A are presented as

$$\mu_a = \begin{array}{c} A \\ | \\ \text{cup} \\ | \\ A \quad A \end{array} \quad \eta_a = \begin{array}{c} A \\ | \\ \circ_a \\ | \\ A \end{array} \quad \Delta_a = \begin{array}{c} A \quad A \\ | \\ \text{cup} \\ | \\ A \end{array} \quad \varepsilon_a = \begin{array}{c} \circ_a \\ | \\ A \end{array} \quad P_a = \begin{array}{c} A \\ | \\ \bullet \\ | \\ A \end{array}$$

and the relations (3.1) and (3.2) are

$$\begin{array}{c} \begin{array}{c} A \\ | \\ \text{cup} \\ | \\ A \quad A \end{array} \quad \begin{array}{c} A \\ | \\ \text{cup} \\ | \\ A \quad A \end{array} \\ \text{cup} \\ | \\ A \quad A \quad A \quad A \quad A \quad A \end{array} \quad \begin{array}{c} A \\ | \\ \text{cup} \\ | \\ A \end{array} \quad \begin{array}{c} A \\ | \\ \text{cup} \\ | \\ A \end{array} \\ \text{cup} \\ | \\ A \quad A \quad A \end{array} = \begin{array}{c} A \\ | \\ \bullet_{a+b} \\ | \\ A \end{array} \quad \begin{array}{c} A \quad A \quad A \\ | \\ \text{cup} \\ | \\ A \end{array} \quad \begin{array}{c} A \quad A \quad A \\ | \\ \text{cup} \\ | \\ A \end{array} \\ \text{cup} \\ | \\ A \quad A \quad A \end{array} = \begin{array}{c} A \quad A \quad A \\ | \\ \text{cup} \\ | \\ A \end{array} \quad \begin{array}{c} A \quad A \quad A \\ | \\ \text{cup} \\ | \\ A \end{array} \\ \text{cup} \\ | \\ A \quad A \quad A \end{array} = \begin{array}{c} A \\ | \\ \bullet_{a+b} \\ | \\ A \end{array} \quad \begin{array}{c} A \\ | \\ \text{cup} \\ | \\ A \end{array} \quad \begin{array}{c} A \\ | \\ \text{cup} \\ | \\ A \end{array} \\ \text{cup} \\ | \\ A \quad A \quad A \end{array} = \begin{array}{c} A \\ | \\ \bullet_{a+b} \\ | \\ A \end{array}$$

and

$$\begin{array}{c} A \quad A \\ | \\ \text{cup} \\ | \\ A \quad A \end{array} \quad \begin{array}{c} A \quad A \\ | \\ \text{cup} \\ | \\ A \quad A \end{array} \quad \begin{array}{c} A \quad A \\ | \\ \text{cup} \\ | \\ A \quad A \end{array} \\ \text{cup} \\ | \\ A \quad A \end{array} = \begin{array}{c} A \quad A \\ | \\ \text{cup} \\ | \\ A \quad A \end{array} \quad \begin{array}{c} A \quad A \\ | \\ \text{cup} \\ | \\ A \quad A \end{array} = \begin{array}{c} A \quad A \\ | \\ \text{cup} \\ | \\ A \quad A \end{array}$$

A regularised Frobenius algebra A is *commutative* if $\mu_a \circ \sigma_{A,A} = \mu_a$ for every $a \in \mathbb{R}_{>0}$:

$$\begin{array}{c} A \\ | \\ \text{cup} \\ | \\ A \quad A \end{array} \quad \begin{array}{c} A \\ | \\ \text{cup} \\ | \\ A \quad A \end{array} \\ \text{cup} \\ | \\ A \quad A \end{array} = \begin{array}{c} A \\ | \\ \text{cup} \\ | \\ A \quad A \end{array}$$

Area-dependent quantum field theories are classified by commutative regularised Frobenius algebras: the underlying Hilbert space is the value of the quantum field theory on the circle S^1 , and the structure maps are the values on the generating morphisms of $\mathcal{Bord}_2^{\text{area}}$, which are the cups, caps and pairs of pants. For further details see [RS21, Section 3.2].

An *area-dependent quantum field theory with defects* is a symmetric monoidal functor from the category of two-dimensional bordisms with area and defects. In this bordism category we endow manifolds with a stratification, which is a collection of immersed manifolds of lower dimension. The surface components are assigned individual areas and the functor is required to be continuous in all of these area parameters.

The category of bordisms with area and defects comes with three label sets D_2 , D_1 and D_0 , which respectively label the submanifolds of dimension two, one and zero. The elements of D_2 are called phases, the elements of D_1 are called domain walls or defect conditions, and the elements of D_0 are called junction field labels. For more details see for example [DKR11] and [RS21, Section 3.3].

Consider an area-dependent quantum field theory with defects \mathcal{Z} . A defect line labeled with $x \in D_1$ is *transmissive* if the value of \mathcal{Z} on surfaces involving defects labeled with x depends only on the sum of the areas of the surface components separated by the defect; in other words, area can be transmitted through the defect line. These are the topological defects in area-dependent quantum field theories. When only considering topological defects, the sets D_0 , D_1 and D_2 can be organised into a bicategory using the functor \mathcal{Z} , see Section 3.2 below for further details.

One way to construct examples of area-dependent quantum field theory with defects is using the ‘state sum construction’. Here one works with an appropriate cell decomposition of the surface;

for example, faces are allowed to be intersected by defect lines (without junctions) at most once, and junctions and faces should intersect at most once.

The set labeling surface components D_2 is a set of strongly separable symmetric Frobenius algebras. A regularised Frobenius algebra A is *symmetric* if the natural bilinear pairings $\varepsilon_a \circ \mu_b : A \otimes A \rightarrow \mathbb{C}$ are symmetric: $\varepsilon_a \circ \mu_b \circ \sigma_{A,A} = \varepsilon_a \circ \mu_b$, and it is *strongly separable* if there exist algebra homomorphisms $\tau_a : A \rightarrow A$ which satisfy $\tau_a \circ \mu_b \circ \Delta_c = \mu_b \circ \Delta_c \circ \tau_a = P_{a+b+c}$ for every $a, b, c \in \mathbb{R}_{>0}$. Using such Frobenius algebras ensures that the state sum construction will be independent of the choice of cell decomposition. The examples of Frobenius algebras considered in this paper are strongly separable symmetric with $\tau_a = P_a$.

Before we can describe the set D_1 , we need to define bimodules. A *bimodule* over regularised Frobenius algebras A and B is a Hilbert space X together with a family of maps $\rho_{a,b}^X : A \otimes X \otimes B \rightarrow X$ (the two-sided actions), which we denote by

$$\rho_{a,b}^X = \begin{array}{c} X \\ \left| \begin{array}{c} \leftarrow a, b \\ \rightarrow \end{array} \right. \\ A \quad X \quad B \end{array}$$

satisfying a parameterised version of associativity, and the map

$$Q_{a+a',b+b'}^X := \rho_{a,b}^X \circ (\eta_{a'}^A \otimes \text{id}_X \otimes \eta_{b'}^B) = \begin{array}{c} X \\ \left| \begin{array}{c} \bullet \\ \downarrow \\ a+a', b+b' \end{array} \right. \\ X \end{array}$$

satisfies

$$\lim_{a,b \rightarrow 0} Q_{a,b}^X = \text{id}_X .$$

One can similarly define left and right modules, and commuting left and right actions define a bimodule. The converse is not true in general, but the bimodules considered in this paper are in fact left and right modules, with corresponding morphisms Q_a^X , and hence in the following we only consider such bimodules.

An A - B -bimodule X is *dualisable* if there exists a B - A -bimodule \bar{X} together with two families of morphisms $\beta_{a,b}^X : X \otimes \bar{X} \rightarrow \mathbb{C}$ and $\gamma_{a,b}^X : \mathbb{C} \rightarrow \bar{X} \otimes X$, which we denote as

$$\beta_{a,b}^X = \begin{array}{c} \left. \begin{array}{c} \leftarrow a, b \\ \rightarrow \end{array} \right\} \\ X \quad \bar{X} \end{array} \quad \gamma_{a,b}^X = \begin{array}{c} \bar{X} \quad X \\ \left. \begin{array}{c} \downarrow \\ \leftarrow a, b \\ \rightarrow \end{array} \right\} \end{array}$$

that satisfy the duality relations

$$\begin{array}{c} \left. \begin{array}{c} \leftarrow a, b \\ \rightarrow \\ \leftarrow a', b' \\ \rightarrow \end{array} \right\} \\ X \quad \bar{X} \end{array} = \begin{array}{c} X \\ \left| \begin{array}{c} \bullet \\ \downarrow \\ a+a', b+b' \end{array} \right. \\ X \end{array} \quad \begin{array}{c} \bar{X} \quad X \\ \left. \begin{array}{c} \downarrow \\ \leftarrow a, b \\ \rightarrow \\ \leftarrow a', b' \\ \rightarrow \end{array} \right\} \\ \bar{X} \end{array} = \begin{array}{c} \bar{X} \\ \left| \begin{array}{c} \bullet \\ \downarrow \\ a+a', b+b' \end{array} \right. \\ \bar{X} \end{array}$$

and which are compatible with the action:

$$\begin{array}{c} \left. \begin{array}{c} \leftarrow a, b \\ \rightarrow \\ \leftarrow a', b' \\ \rightarrow \end{array} \right\} \\ A \quad X \quad B \quad \bar{X} \end{array} = \begin{array}{c} \left. \begin{array}{c} \leftarrow a, b \\ \rightarrow \\ \leftarrow a', b' \\ \rightarrow \end{array} \right\} \\ A \quad X \quad B \quad \bar{X} \end{array} \quad \begin{array}{c} \bar{X} \quad X \\ \left. \begin{array}{c} \downarrow \\ \leftarrow a, b \\ \rightarrow \\ \leftarrow a', b' \\ \rightarrow \end{array} \right\} \\ B \quad A \end{array} = \begin{array}{c} \bar{X} \quad X \\ \left. \begin{array}{c} \downarrow \\ \leftarrow a, b \\ \rightarrow \\ \leftarrow a', b' \\ \rightarrow \end{array} \right\} \\ B \quad A \end{array}$$

The set labeling defect lines D_1 is a set of dualisable bimodules over the regularised Frobenius algebras in D_2 . A bimodule is *transmissive* if the action depends only on the sum of the parameters. Transmissive bimodules correspond to transmissive defect lines.

In order to give the set D_0 , we need some more notions. Let X be an A - B -bimodule and Y a B - C -bimodule for regularised Frobenius algebras A , B and C . The *relative tensor product* $X \otimes_B Y$ of X and Y is an A - C -bimodule which is a coequaliser of the morphisms

$$\begin{array}{c} X \quad Y \\ | \quad | \\ \curvearrowright \quad \bullet \\ a_1, b \quad b, c \\ \curvearrowleft \quad | \\ X \quad B \quad Y \end{array} \quad \text{and} \quad \begin{array}{c} X \quad Y \\ | \quad | \\ \bullet \quad \curvearrowright \\ a, b \quad b, c_1 \\ \bullet \quad \curvearrowleft \\ X \quad B \quad Y \\ \circ \quad \circ \\ a_2 \quad c_2 \end{array}$$

If A , B and C are strongly separable symmetric Frobenius algebras then the relative tensor product is the image of the idempotent

$$\mathcal{D}_0^{X,Y} = \lim_{a,b_i,c \rightarrow 0} \begin{array}{c} X \quad Y \\ | \quad | \\ \curvearrowright \quad \bullet \quad \curvearrowright \\ a, b_1 \quad b_2, c \\ \bullet \quad \bullet \\ b_2 \quad b_3 \\ \curvearrowleft \quad \curvearrowleft \\ X \quad B \quad Y \end{array}$$

which exists for dualisable bimodules, and the action is given by

$$\rho_{a,c}^{X \otimes_B Y} = \lim_{b_i \rightarrow 0} \begin{array}{c} X \otimes_B Y \\ \boxed{\pi} \\ \curvearrowright \quad \bullet \quad \curvearrowright \\ a, b_1 \quad b_2, c \\ \bullet \quad \bullet \\ b_2 \quad b_3 \\ \boxed{\iota} \\ \curvearrowleft \quad \curvearrowleft \\ A \quad X \otimes_B Y \quad C \end{array} \quad (3.3)$$

where π and ι are the projection and embedding of the image of the idempotent. For bimodules which are left and right modules as well, the limit in (3.3) exists as we are allowed to set $b_i = 0$. The fusion of defect lines in the state sum construction corresponds to the relative tensor product of bimodules [RS21, Theorem 4.20].

Similarly, we define the *cyclic tensor product* $\circlearrowleft_A X$ of an A - A -bimodule X by identifying the two actions. Instead of giving details here, we just note that the idempotent with image $\circlearrowleft_A X$ is given by

$$\mathcal{D}_0^X = \lim_{a_i \rightarrow 0} \begin{array}{c} X \\ | \\ \curvearrowright \quad \bullet \\ a_1, a_4 \\ \bullet \\ a_2 \\ \curvearrowleft \\ X \\ \circ \quad \circ \\ a_3 \end{array}$$

and refer to [RS21] for further details.

Consider a boundary circle of a surface with defect lines, some of which start or end on this circle. By [RS21, Theorem 4.19], the state space assigned to this circle is

$$\mathcal{Z}(S^1, A_1, \dots, A_n; X_1, \dots, X_n) = \circlearrowleft_{A_1} X_1^{\epsilon_1} \otimes_{A_2} X_2^{\epsilon_2} \otimes_{A_3} \dots \otimes_{A_n} X_n^{\epsilon_n}, \quad (3.4)$$

where $A_i \in D_2$, $X_i \in D_1$, and $\epsilon_i \in \{\pm\}$ depending on the orientation of the i -th defect, with $X_i^+ = X_i$ and $X_i^- = \bar{X}_i$ the dual of X_i .

The set D_0 of junction field labels is given by families of elements in the state spaces (3.4) which are invariant under the action of cylinders over the circles, which are cylinders with parallel defect lines. We give more detail on this in Section 3.2 below.

Now we sketch what the state sum construction assigns to a surface $\Sigma : S \longrightarrow T$ with defect lines. We pick a cell decomposition of the surface such that the defect lines intersect only edges and they intersect each edge at most once. We require that every face contains at most one junction of defect lines. Then we define $\mathcal{Z}(\Sigma)$ in two steps. First we consider the surface Σ' obtained from Σ by cutting out small disks near the junctions, and we regard the new boundary components as ingoing. Then we compose $\mathcal{Z}(\Sigma')$ with $\text{id}_{\mathcal{Z}(S)}$ tensored with the elements from D_0 that label the junction fields.

It remains to show how to define $\mathcal{Z}(\Sigma')$, which is the value of the functor \mathcal{Z} on surfaces without junctions of defects. To each face we assign the morphism

$$(3.5)$$

Then we use the duality morphisms of the bimodules, and the morphisms $\varepsilon_{a_1} \circ \mu_{a_2}$, to contract legs corresponding to inner edges according to the cell decomposition (which describes how faces are glued together along the edges indicated by dashed lines) and to define ingoing edges. Finally we compose with the corresponding projections and embeddings to the state space.

As a detailed computation, consider the cylinder with parallel defect lines illustrated in Figure 5. For the two faces we have the two morphisms from (3.5), for the two dashed edges we contract the

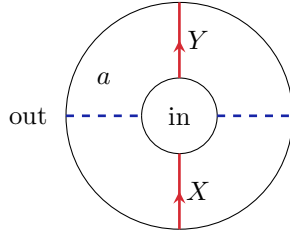

Figure 5: A cylinder of total area a with two parallel defect lines labeled by $X, Y \in D_1$. The dashed lines indicate a cell decomposition of this surface.

legs using the morphisms $\varepsilon_a \circ \mu_{a'}$ and we pull down two legs using the duality morphisms. Finally we compose with the embedding ι and projection π onto the cyclic and relative tensor products of

X and Y to get

$$\text{Diagrammatic equation (3.6) showing the simplification of a morphism. The left side shows a cylinder with a central circle labeled 'in' and an outer circle labeled 'out'. A red arrow labeled 'Y' points up from the center, and a red arrow labeled 'X' points down from the center. A dashed blue line is horizontal through the center. The cylinder is labeled 'a' on the left and 'b' on the right. An arrow labeled 'Z' points to the right. The first diagram on the right shows a box labeled 'pi' at the top and a box labeled 'l' at the bottom. Curved arrows connect the top and bottom boxes, with small circles at their ends. The top and bottom boxes are labeled with the tensor product of Frobenius algebras. The second diagram shows a similar structure but with a different arrangement of arrows. The third diagram shows two vertical lines with boxes 'pi' and 'l' and dots on the lines, representing a simplified form of the morphism.$$

In the first step we used the properties of the duality morphisms, and in the second step the definitions of ι and π . Here and in the following we do not write the area parameters explicitly in order to streamline the presentation, and since we can distribute the area parameters among the morphisms arbitrarily. We will also not write the morphisms $Q_{a,b}^X$ explicitly. In Section 3.4 we give computations which involve defect junctions as well.

3.2 The defect bicategory of Yang-Mills theory

For the remainder of this paper we focus on the area-dependent quantum field theory $\mathcal{Z} = \mathcal{Z}_{\text{YM}}$ corresponding to two-dimensional Yang-Mills theory, as defined in Section 1; in this case the state sum construction provides a rigorous implementation of the lattice regularisation of Section 2. Compared to Section 2, in the following we set the gauge coupling constant to $e = 1$ without loss of generality. The weak-coupling limit, which determines a topological field theory, is then equivalent to the zero area limit $a \rightarrow 0$.

We define a bicategory of topological defects \mathcal{B}_{YM} in the spirit of [DKR11, CR16]. This bicategory has as objects regularised Frobenius algebras of the form $A = L^2(G)$ where G is a compact semi-simple Lie group. The 1-morphisms $X : A \rightarrow B$ are transmissive bimodules with duals and the composition is given by the relative tensor product. The 2-morphisms $X \Rightarrow Y$ for $X, Y : A \rightarrow B$ are given by the set of families of maps $\{\phi_a : \mathbb{C} \rightarrow \circlearrowleft_A Y \otimes_B \bar{X}\}_{a \in \mathbb{R}_{>0}}$ which are invariant under the action of cylinders:¹²

$$\mathcal{C}_b \circ \phi_a = \phi_{a+b} ,$$

where \mathcal{C}_a is the value of \mathcal{Z}_{YM} on the cylinder illustrated in Figure 5 and it is computed in (3.6). We write $\text{H}^{\text{inv}}(Y \otimes_B \bar{X})$ for this set of invariant families. For any morphism $\phi : \mathbb{C} \rightarrow \circlearrowleft_A Y \otimes_B \bar{X}$ we can define a family $\phi_a := \mathcal{C}_a \circ \phi$, and in this case $\phi_a \rightarrow \phi$ in the limit $a \rightarrow 0$. However, there exist invariant families for which this limit does not exist; an example of such a family is

$$\{\eta_a^{C\ell^2(G)} : \mathbb{C} \rightarrow \circlearrowleft_{L^2(G)} L^2(G) \otimes_{L^2(G)} L^2(G) \simeq C\ell^2(G)\}_{a \in \mathbb{R}_{>0}} .$$

¹²This definition is an incarnation of the operator-state correspondence of local quantum field theory.

Vertical composition of 2-morphisms is given by the pair of pants

$$(3.7)$$

of total area c . Explicitly, the vertical composition of $\{\phi_a\}_{a \in \mathbb{R}_{>0}} : X \Rightarrow Y$ and $\{\varpi_b\}_{b \in \mathbb{R}_{>0}} : Y \Rightarrow Z$ for $X, Y, Z : A \rightarrow B$ is the family

$$\{\phi_a\}_{a \in \mathbb{R}_{>0}} \circ^{\text{ver}} \{\varpi_b\}_{b \in \mathbb{R}_{>0}} := \{\mu_c^{\text{ver}} \circ (\phi_a \otimes \varpi_b)\}_{a+b+c \in \mathbb{R}_{>0}} : X \Rightarrow Z,$$

where μ_c^{ver} is the value of \mathcal{Z}_{YM} on the pair of pants (3.7). The unit of this product is given by the value of \mathcal{Z}_{YM} on a disk crossed by a defect line.

Horizontal composition of 2-morphisms is given by acting with the pair of pants

$$(3.8)$$

of total area c . Explicitly, the horizontal composition of $\{\phi_a\}_{a \in \mathbb{R}_{>0}} : X \Rightarrow Y$ and $\{\phi'_b\}_{b \in \mathbb{R}_{>0}} : X' \Rightarrow Y'$ for $X, Y : A \rightarrow B$ and $X', Y' : B \rightarrow C$ is the family

$$\{\phi_a\}_{a \in \mathbb{R}_{>0}} \circ^{\text{hor}} \{\phi'_b\}_{b \in \mathbb{R}_{>0}} := \{\mu_c^{\text{hor}} \circ (\phi_a \otimes \phi'_b)\}_{a+b+c \in \mathbb{R}_{>0}} : X \otimes_B X' \Rightarrow Y \otimes_B Y',$$

where μ_c^{hor} is the value of \mathcal{Z}_{YM} on the pair of pants (3.8). The unit of this composition is the value of \mathcal{Z}_{YM} on a disk with trivial defect line.

Lemma 3.9. *The morphisms μ_c^{ver} and μ_c^{hor} for the vertical and horizontal compositions are given by*

$$\mu_c^{\text{ver}} = \begin{array}{c} \circlearrowleft_B \bar{X} \otimes_A Z \\ \pi \\ \swarrow \quad \searrow \\ \downarrow \quad \downarrow \\ \circlearrowleft_B \bar{X} \otimes_A Y \quad \circlearrowleft_B \bar{Y} \otimes_A Z \end{array} \quad \mu_c^{\text{hor}} = \begin{array}{c} \circlearrowleft_B \bar{X} \otimes_A Y \otimes_B Y' \otimes_C \bar{X}' \\ \pi \\ \swarrow \quad \searrow \\ \downarrow \quad \downarrow \\ \circlearrowleft_B \bar{X} \otimes_A Y \quad \circlearrowleft_C \bar{X}' \otimes_B Y' \end{array}$$

The unit of μ_c^{ver} is $\{\pi \circ \text{coev}_a^X : \mathbb{C} \rightarrow \circlearrowleft_B \bar{X} \otimes_A X\}_{a \in \mathbb{R}_{>0}}$, while the unit of μ_c^{hor} is $\{\iota \circ \eta_a^A : \mathbb{C} \rightarrow \circlearrowleft_A A \otimes_A A\}_{a \in \mathbb{R}_{>0}}$.

Proof. Consider the cell decompositions

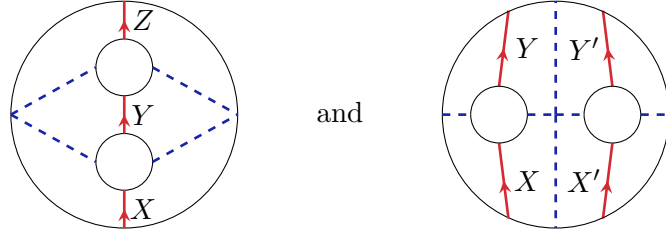

To the first one the state sum construction assigns the morphism

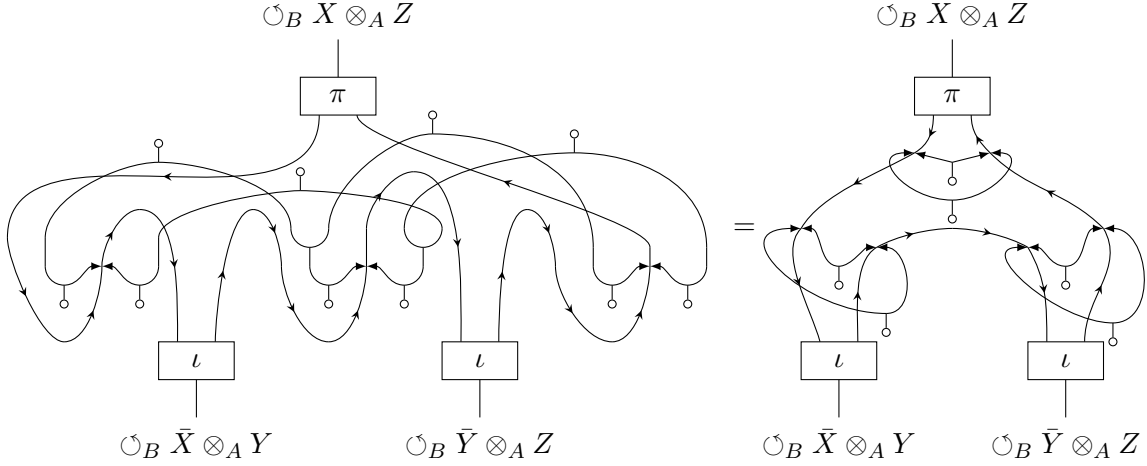

which is μ_c^{ver} after simplifying the expression using the definitions of ι and π as in the calculation of (3.6). For the second pair of pants the morphism is

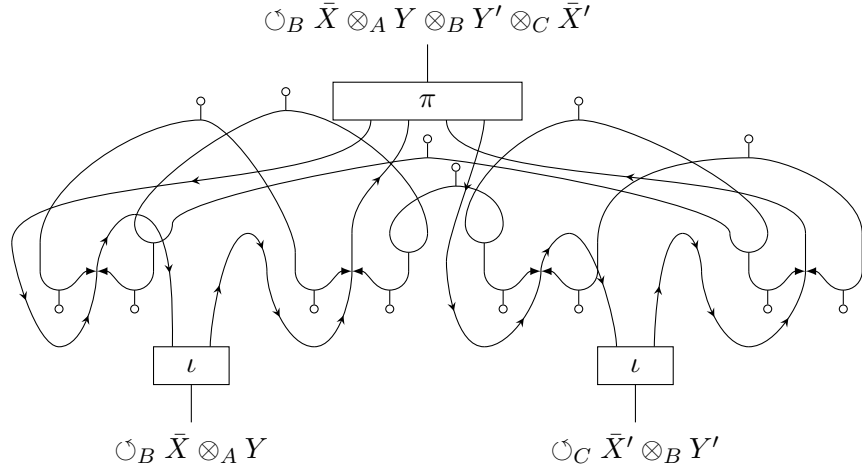

which can be similarly disentangled to give μ_c^{hor} . □

Let $\text{Hom}_{A|B}^{\text{fam}}(X, Y)$ denote the families of bimodule morphisms $\{\psi_a : X \rightarrow Y\}_{a \in \mathbb{R}_{>0}}$ which satisfy the invariance property

$$Q_b^Y \circ \psi_a = \psi_a \circ Q_b^X = \psi_{a+b}.$$

The composition of two families of bimodule morphisms $\{\xi_a : Y \rightarrow Z\}_{a \in \mathbb{R}_{>0}} \in \text{Hom}_{A|B}^{\text{fam}}(Y, Z)$ and $\{\psi_b : X \rightarrow Y\}_{b \in \mathbb{R}_{>0}} \in \text{Hom}_{A|B}^{\text{fam}}(X, Y)$ is defined via the pointwise composition

$$\{\xi_a\}_{a \in \mathbb{R}_{>0}} \circ \{\psi_b\}_{b \in \mathbb{R}_{>0}} := \{\xi_a \circ \psi_b\}_{a+b \in \mathbb{R}_{>0}} \in \text{Hom}_{A|B}^{\text{fam}}(X, Z).$$

$$\begin{array}{c}
\circlearrowleft_B \bar{X} \otimes_A Y \otimes_B Y' \otimes_C \bar{X}' \quad \circlearrowleft_B \bar{X} \otimes_A Y \otimes_B Y' \otimes_C \bar{X}' \\
= \begin{array}{c} \text{---} \\ \boxed{\pi} \\ \text{---} \\ \boxed{\pi} \quad \boxed{\pi} \\ \text{---} \\ \psi \quad \psi' \\ \text{---} \\ \text{---} \end{array} \quad = \quad \begin{array}{c} \text{---} \\ \boxed{\pi} \\ \text{---} \\ \psi \quad \psi' \\ \text{---} \\ \iota \\ \text{---} \\ \text{---} \end{array} = \mathcal{S}(\psi \otimes_B \psi'),
\end{array}$$

where we used the cyclicity of the tensor product $\circlearrowleft_B \bar{X} \otimes_A Y \otimes_B Y' \otimes_C \bar{X}'$ together with the fact that the relative tensor product of morphisms can be expressed using the projections π and embeddings ι . \square

Lemma 3.10 gives two equivalent ways of thinking about the 2-morphisms in the bicategory of topological defects. Sometimes it is easier to work with families of bimodule morphisms as their weak-coupling limit exists more frequently, for example the families $\{\eta_a^A\}_{a \in \mathbb{R}_{>0}}$, $\{Q_a^X\}_{a \in \mathbb{R}_{>0}}$ and $\{P_a^A\}_{a \in \mathbb{R}_{>0}}$, and we can compute with the limits instead of the families. On the other hand, in general the weak-coupling limit of an invariant family may not exist: Take for example the Frobenius algebra $A = \bigoplus_{k \in \mathbb{N}} \mathbb{C} e_k$ with orthonormal basis $\{e_k\}_{k \in \mathbb{N}}$, product $\mu(e_j \otimes e_k) = \delta_{jk} e_k$ and unit $\sum_{k \in \mathbb{N}} e^{-ak^2} e_k$, and consider A as a bimodule over itself. Then the family of endomorphisms $\{\phi_a\}_{a \in \mathbb{R}_{>0}}$ of A given by $\phi_a(e_k) = e^{-ak^2} k^2 e_k$ clearly does not have a weak-coupling limit.

Accordingly we can now give a working definition.

Definition 3.11. The *topological defect bicategory* \mathcal{B}_{YM} of two-dimensional Yang-Mills theories has:

- (a) Objects: Hilbert spaces $L^2(G)$ for G compact semi-simple Lie groups with regularised Frobenius algebra structure given by (1.1);
- (b) 1-morphisms: Transmissive bimodules with duals between regularised Frobenius algebras $L^2(G)$ and $L^2(H)$; and
- (c) 2-morphisms: Invariant families of bimodule morphisms.

In order to apply techniques from [CR16] later on we will need

Proposition 3.12. The bicategory \mathcal{B}_{YM} is idempotent complete; that is, its morphism categories are idempotent complete.

Proof. Let $\psi = \{\psi_a : X \rightarrow X\}_{a \in \mathbb{R}_{>0}}$ be an idempotent on an A - B -bimodule X , that is it obeys $\psi_a \circ \psi_b = \psi_{a+b}$. Let Y be the closure of the subspace $\bigcup_{a \in \mathbb{R}_{>0}} \text{im}(\psi_a)$, $p : X \rightarrow Y$ the projection and $e : Y \rightarrow X$ the embedding of the subspace $Y \subset X$. The Hilbert space Y becomes an A - B -bimodule via the induced action $p \circ \rho^X \circ (\text{id}_A \otimes e \otimes \text{id}_B)$. Since ψ_a is an intertwiner, the action on X indeed restricts to Y . Set $\pi := \{p_a = p \circ \psi_a : X \rightarrow Y\}_{a \in \mathbb{R}_{>0}}$ and $\iota := \{e_a = \psi_a \circ e : Y \rightarrow X\}_{a \in \mathbb{R}_{>0}}$. Then $\iota \circ \pi = \psi$ and $\pi \circ \iota = \text{id}_Y$; the first equation is clear from the definition of p and e , while the second equation follows from $\psi_a(y) = Q_a^Y(y)$ for $y \in Y$ by the definition of Y . \square

Example 3.13. Wilson lines can be described by bimodules over $L^2(G)$ as follows. Let V be a representation of G and consider $V \otimes L^2(G)$ with the commuting left and right actions

$$\psi \cdot (v \otimes f) = \left[x \mapsto \int_G dy \psi(y) (y \cdot v) f(y^{-1}x) \right] \quad \text{and} \quad (v \otimes f) \cdot \psi = v \otimes (f * \psi) ,$$

for $v \in V$ and $\psi, f \in L^2(G)$. Similarly, $L^2(G) \otimes V$ is a bimodule via

$$\psi \cdot (f \otimes v) = (\psi * f) \otimes v \quad \text{and} \quad (f \otimes v) \cdot \psi = \left[x \mapsto \int_G dy (y^{-1} \cdot v) f(xy^{-1}) \psi(y) \right] .$$

The dual of $V \otimes L^2(G)$ is $L^2(G) \otimes V^*$, where V^* is the dual of V . If G is connected then Wilson lines are *not* transmissive, so they are not 1-morphisms in \mathcal{B}_{VM} . Nevertheless we will need these for disconnected gauge groups. For further details on Wilson lines see [RS21, Proposition 5.10].

Example 3.14. The twisted bimodules $L_\varphi = L^2(G)$ for $\varphi \in \text{Out}(G)$ with action given in (1.2) are transmissive bimodules over $L^2(G)$, so they are 1-morphisms in \mathcal{B}_{VM} .

3.3 Frobenius algebras from symmetry defects

Next we define regularised Frobenius algebras and their bimodules in the category \mathcal{Hilb} , starting from a Lie group and its outer automorphism group. Let G be a compact semi-simple Lie group and $\Gamma < \text{Out}(G)$ a subgroup of outer automorphisms of G . We will sometimes use the notation $L = L^2(G)$, $H = L^2(\Gamma)$ and $K = L^2(G \rtimes \Gamma)$ for brevity.

The group $\text{Out}(G)$ is finite and the algebra $L^2(\Gamma)$ is isomorphic to the group algebra of Γ , which has the structure of a Hopf algebra with coproduct

$$\Delta_H = \begin{array}{c} \text{---} \\ \diagup \quad \diagdown \\ \text{---} \end{array} \quad \phi \mapsto \Delta_H(\phi) = [(\gamma, \kappa) \mapsto |\Gamma| \phi_\gamma \delta_{\gamma, \kappa}] =: \phi_{(1)} \otimes \phi_{(2)}$$

and antipode

$$S = \begin{array}{c} | \\ \text{---} \\ | \end{array} \quad S(\delta_\gamma) = \frac{1}{|\Gamma|} \delta_{\gamma^{-1}} ,$$

where $\delta_\gamma(\kappa) = \delta_{\gamma, \kappa}$. The algebra $L^2(\Gamma)$ acts on $L^2(G)$ via

$$\begin{array}{c} \curvearrowright \\ | \end{array} \quad \phi \cdot f = \frac{1}{|\Gamma|} \sum_{\gamma \in \Gamma} \phi_\gamma f \circ \gamma^{-1}$$

for $\phi \in L^2(\Gamma)$ and $f \in L^2(G)$.

Using the Hopf algebra structure of $L^2(\Gamma)$ we endow $L^2(G) \otimes L^2(\Gamma)$ with the structure of a regularised Frobenius algebra with unit

$$\begin{array}{c} L \quad H \\ | \quad | \\ \text{---} \quad \text{---} \\ \text{---} \end{array} = \eta_a^{L^2(G)} \otimes |\Gamma| \delta_{\text{id}_G} ,$$

and product

$$\begin{array}{c} L \quad H \\ \text{---} \quad \text{---} \\ \text{---} \quad \text{---} \\ L \quad H \quad L \quad H \end{array} \quad (f \otimes \phi) * (g \otimes \psi) = (f * (\phi_{(1)} \cdot g)) \otimes (\phi_{(2)} * \psi) \quad (3.15)$$

for $f, g \in L^2(G)$ and $\phi, \psi \in L^2(\Gamma)$. We define the coproduct and counit to be the adjoint operators of the product and unit respectively. We denote this Frobenius algebra by $L^2(G) \rtimes L^2(\Gamma)$.

The map

$$\begin{array}{c} L \quad H \\ \left| \quad \right| \\ L \quad \circ \end{array} \quad L^2(G) \longrightarrow L^2(G) \rtimes L^2(\Gamma), \quad f \longmapsto f \otimes |\Gamma| \delta_{id_G} \quad (3.16)$$

is a homomorphism of regularised Frobenius algebras. Using this morphism we obtain an $L^2(G)$ - $L^2(G)$ -bimodule structure on $L^2(G) \rtimes L^2(\Gamma)$.

Proposition 3.17. 1. The map

$$\Phi : L \rtimes H \longrightarrow K, \quad f \otimes \phi \longmapsto [(x, \gamma) \mapsto f(x) \phi_\gamma]$$

is an isomorphism of regularised Frobenius algebras in $\mathcal{H}\text{ilb}$. The map (3.16) endows K with the structure of a transmissive L - L -bimodule.

2. The L - L -bimodule K is a strongly separable symmetric Frobenius algebra in $\mathcal{B}_{\text{VM}}(L, L)$ via the structure morphisms

$$\begin{aligned} \bar{\mu}^K &:= \{K \otimes_L K \xrightarrow{\iota} K \otimes K \xrightarrow{\mu_a} K\}_{a \in \mathbb{R}_{>0}}, \\ \bar{\Delta}^K &:= \{K \xrightarrow{\Delta_a} K \otimes K \xrightarrow{\pi} K \otimes_L K\}_{a \in \mathbb{R}_{>0}}, \\ \bar{\eta}^K &:= \{L \xrightarrow{\bar{\eta}_a} K\}_{a \in \mathbb{R}_{>0}}, \quad \bar{\eta}_a(f) = P_a^L(f) \otimes |\Gamma| \delta_{id_G}, \\ \bar{\varepsilon}^K &:= \{K \xrightarrow{\bar{\varepsilon}_a} L\}_{a \in \mathbb{R}_{>0}}, \quad \bar{\varepsilon}_a(f \otimes \phi) = P_a^L(f) \frac{1}{|\Gamma|} \phi_{id_G}. \end{aligned}$$

3. The L - L -bimodule $M := \bigoplus_{\varphi \in \Gamma} L_\varphi$ is a strongly separable symmetric Frobenius algebra in $\mathcal{B}_{\text{VM}}(L, L)$ via the structure morphisms

$$\begin{aligned} \bar{\mu}^M &:= \left\{ M \otimes_L M \xrightarrow{\iota} M \otimes M \xrightarrow{\sum_{\varphi, \omega \in \Gamma} \mu_a^{\varphi, \omega}} M \right\}_{a \in \mathbb{R}_{>0}}, \\ \bar{\Delta}^M &:= \left\{ M \xrightarrow{\frac{1}{|\Gamma|} \sum_{\varphi, \omega \in \Gamma} \Delta_a^{\varphi, \omega}} M \otimes M \xrightarrow{\pi} M \otimes_L M \right\}_{a \in \mathbb{R}_{>0}}, \\ \bar{\eta}^M &:= \left\{ L \xrightarrow{P_a^L} L = L_{id_G} \hookrightarrow \bigoplus_{\varphi \in \Gamma} L_\varphi = M \right\}_{a \in \mathbb{R}_{>0}}, \\ \bar{\varepsilon}^M &:= \left\{ M = \bigoplus_{\varphi \in \Gamma} L_\varphi \twoheadrightarrow L_{id_G} = L \xrightarrow{P_a^L} L \right\}_{a \in \mathbb{R}_{>0}}, \end{aligned} \quad (3.18)$$

where

$$\begin{array}{ccc} \mu_a^{\varphi, \omega} = \begin{array}{c} L_{\varphi\omega} \\ \text{---} \text{---} \text{---} \\ \text{---} \omega^{-1} \text{---} \\ \text{---} \text{---} \text{---} \\ L_\varphi L_\omega \end{array} & \Delta_a^{\varphi, \omega} = \begin{array}{c} L_\varphi L_\omega \\ \text{---} \text{---} \text{---} \\ \text{---} \omega \text{---} \\ \text{---} \text{---} \text{---} \\ L_\varphi L_\omega \end{array} & \begin{array}{c} L \\ \text{---} \text{---} \text{---} \\ \text{---} \varphi \text{---} \\ \text{---} \text{---} \text{---} \\ L \end{array} = (\varphi^{-1})^* . \end{array}$$

4. The map

$$\Psi : \bigoplus_{\varphi \in \Gamma} L_\varphi \longrightarrow K , \quad \sum_{\varphi \in \Gamma} f_\varphi \longmapsto [(x, \gamma) \mapsto f_\gamma(\gamma^{-1}(x))]$$

is an isomorphism of L - L -bimodules as well as of Frobenius algebras in $\mathcal{B}_{\mathcal{VM}}(L, L)$.

Proof. For Part 1, we note that $\Delta_H(\delta_\varphi) = |\Gamma| \delta_\varphi \otimes \delta_\varphi$ and $|\Gamma| \delta_\varphi \cdot f = f \circ \varphi^{-1}$. Using (3.15) we first compute

$$\begin{aligned} \Phi((f \otimes \delta_\varphi) * (g \otimes \phi))(x, \omega) &= \Phi((f * |\Gamma| \delta_\varphi \cdot g) \otimes (\delta_\varphi * \phi))(x, \omega) \\ &= (f * (g \circ \varphi^{-1}))(x) \frac{1}{|\Gamma|} \phi_{\varphi^{-1}\omega} . \end{aligned} \quad (3.19)$$

Then we compute

$$\begin{aligned} (\Phi(f \otimes \delta_\varphi) * \Phi(g \otimes \phi))(x, \omega) &= \int_G dy \frac{1}{|\Gamma|} \sum_{\gamma \in \Gamma} f(y) \delta_\varphi(\gamma) g(\gamma^{-1}(y^{-1}x)) \phi_{\gamma^{-1}\omega} \\ &= \frac{1}{|\Gamma|} (f * (g \circ \varphi^{-1}))(x) \phi_{\varphi^{-1}\omega} , \end{aligned}$$

which agrees with (3.19).

Next we show that $\Phi(\eta_a^{L^2(G)} \otimes |\Gamma| \delta_{\text{id}_G})$ is a unit for this multiplication, which by uniqueness of the unit of a regularised algebra is precisely $\eta_a^{L^2(G \times \Gamma)}$. For $F = f \otimes \phi \in K$ we compute

$$\begin{aligned} (\Phi(\eta_a^{L^2(G)} \otimes |\Gamma| \delta_{\text{id}_G}) * (f \otimes \phi))(x, \omega) &= \int_G dy \frac{1}{|\Gamma|} \sum_{\gamma \in \Gamma} \eta_a^{L^2(G)}(y) |\Gamma| \delta_{\text{id}_G}(\gamma) f(\gamma^{-1}(y^{-1}x)) \phi_{\gamma^{-1}\omega} \\ &= (\eta_a^{L^2(G)} * f)(x) \phi_\omega , \end{aligned}$$

and

$$\begin{aligned} ((f \otimes \phi) * \Phi(\eta_a^{L^2(G)} \otimes |\Gamma| \delta_{\text{id}_G}))(x, \omega) &= \int_G dy \frac{1}{|\Gamma|} \sum_{\gamma \in \Gamma} f(y) \phi_\gamma \eta_a^{L^2(G)}(\gamma^{-1}(y^{-1}x)) |\Gamma| \delta_{\text{id}_G}(\gamma^{-1}\omega) \\ &= (f * \eta_a^{L^2(G)})(x) \phi_\omega , \end{aligned}$$

both of which are equal to $F(x, \omega)$ in the $a \rightarrow 0$ limit, showing that $\Phi(\eta_a^{L^2(G)} \otimes |\Gamma| \delta_{\text{id}_G})$ is the unit of K .

Part 2 follows from the fact that K is a strongly separable symmetric Frobenius algebra and from Part 1. We only present the computation which shows associativity. Let us compute the

$a + b + c$ component of the family $\bar{\mu}^K \circ (\bar{\mu}^K \otimes_L \text{id}_K)$:

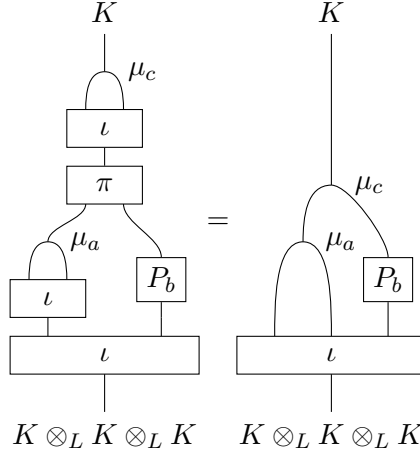

where we used associativity of the relative tensor product and $\mu_c \circ \mathcal{D}_0 = \mu_c$. Computing the $a + b + c$ component of the family $\bar{\mu}^K \circ (\text{id}_K \otimes_L \bar{\mu}^K)$ in a similar way gives the same family.

For Parts 3 and 4, the verification that the isomorphism is an L - L -bimodule morphism follows from a direct computation: For the left L -action we have

$$\begin{aligned}
\Psi\left(g \cdot \sum_{\varphi \in \Gamma} f_{\varphi}\right) &= \Psi\left(\sum_{\varphi \in \Gamma} f_{\varphi} * (g \circ \varphi)\right) \\
&= \Psi\left(\sum_{\varphi \in \Gamma} (f_{\varphi} \circ \varphi^{-1}) * g\right) \\
&= [(x, \gamma) \mapsto ((f_{\gamma} \circ \gamma^{-1}) * g)(x)] \\
&= g \cdot \Psi\left(\sum_{\varphi \in \Gamma} f_{\varphi}\right).
\end{aligned}$$

That Ψ commutes with the right L -action can be similarly shown using

$$(f \otimes \phi) \cdot g = [(x, \gamma) \mapsto (f * (g \circ \gamma^{-1}))(x) \phi_{\gamma}].$$

Finally, we compare the Frobenius algebra structure on M defined in (3.18) with the structure transported from K via Ψ . Here we show that the product and coproduct agree. Since the $a \rightarrow 0$ limits of these families exist, it is enough to check $\Psi \circ P_a^M = P_a^K \circ \Psi$ and compare the limits; this indeed holds, as it is given by scaling basis elements by factors $e^{-a C_2(\alpha)/2}$. For the product we compute

$$\begin{aligned}
&\Psi^{-1}\left(\Psi\left(\sum_{\varphi \in \Gamma} f_{\varphi}\right) * \Psi\left(\sum_{\omega \in \Gamma} g_{\omega}\right)\right) \\
&= \Psi^{-1}\left(\left[(x, \gamma) \mapsto \int_G dy \frac{1}{|\Gamma|} \sum_{\kappa \in \Gamma} f_{\kappa}(\kappa^{-1}(y)) g_{\kappa^{-1}\gamma}(\gamma^{-1} \kappa \kappa^{-1}(y^{-1}x))\right]\right) \\
&= \left[(x, \gamma) \mapsto \int_G dz \frac{1}{|\Gamma|} \sum_{\sigma \in \Gamma} f_{\gamma\sigma^{-1}}(\sigma(z)) g_{\sigma}(z^{-1}x)\right],
\end{aligned}$$

where in the last step we changed summation and integration variables $(y, \kappa) = (1, \gamma) \bullet (z, \sigma^{-1})$.

This is exactly the product defined in (3.18). For the coproduct we compute

$$\begin{aligned} (\Psi^{-1} \otimes \Psi^{-1}) \left[\Delta \left(\Psi \left(\sum_{\varphi \in \Gamma} f_{\varphi} \right) \right) \right] &= (\Psi^{-1} \otimes \Psi^{-1}) \left([((x, \gamma), (y, \kappa)) \mapsto f_{\gamma \kappa}((\gamma \kappa)^{-1}(x \gamma(y)))] \right) \\ &= [((x, \gamma), (y, \kappa)) \mapsto f_{\gamma \kappa}(\kappa^{-1}(x) \gamma(y))] , \end{aligned}$$

which is exactly the coproduct described in (3.18). \square

3.4 Gauging the $\text{Out}(G)$ -symmetry

We shall now compute the orbifold of two-dimensional Yang-Mills theory with gauge group G using a defect corresponding to the $\text{Out}(G)$ -symmetry. We do this by introducing labels for defect junctions, and then compute the image of the projector which is the state space of the orbifold theory. In order to verify that the orbifold theory is again a two-dimensional Yang-Mills theory — with a different gauge group — we compute the orbifold theory on the generators of the category of bordisms with area and without defects $\mathcal{B}\text{ord}_2^{\text{area}}$, which is given by the commutative Frobenius algebra structure on the state space.

The class $[\Phi] \in H^3(\text{Out}(G), \mathbb{C}^{\times})$ obtained from the associator of a morphism category of the topological defect bicategory \mathcal{B}_{YM} is trivial, $[\Phi] = 1$, so we can gauge any subgroup $\Gamma < \text{Out}(G)$ [FFRS09, Section 3], which we now fix. In order to compute the orbifold theory of two-dimensional Yang-Mills theory with defect $M = \bigoplus_{\varphi \in \Gamma} L_{\varphi}$, we need to give labels for junctions of the defect labeled with M . It is enough to give the labels for trivalent junctions because, owing to the fact that M is a strongly separable symmetric Frobenius algebra in $\mathcal{B}_{\text{YM}}(L, L)$, the value of the area-dependent quantum field theory on a surface with a defect network is invariant under certain changes of the defect network, which allow us to define junction fields with higher valency.

To a trivalent junction with an ingoing defect labeled with L_{φ} and two outgoing defects labeled with L_{ω} and L_{γ} , as in Figure 6 a), we assign the family

$$\left\{ \frac{1}{|\Gamma|} \delta_{\varphi, \gamma, \omega} \eta_a^{L^2(G)} \right\}_{a \in \mathbb{R}_{>0}} \in \circlearrowleft_L \bar{L}_{\varphi} \otimes_L L_{\omega} \otimes_L L_{\varphi \omega} \simeq C\ell^2(G) ,$$

where $a = a_1 + a_2 + a_3$ is the total area of the three individual surface components. Similarly, to

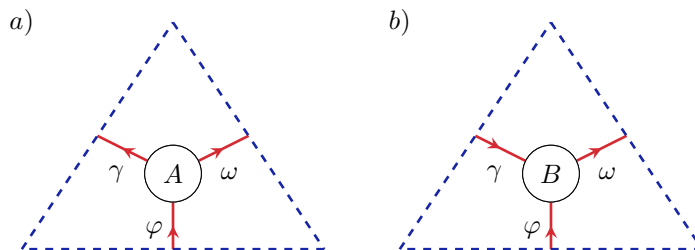

Figure 6: Triangles with trivalent junctions.

a trivalent junction with ingoing defect lines labeled with L_{φ} and L_{ω} and an outgoing defect line labeled with L_{γ} , as in Figure 6 b), we assign the family

$$\left\{ \delta_{\gamma, \varphi, \omega} \eta_a^{L^2(G)} \right\}_{a \in \mathbb{R}_{>0}} \in \circlearrowleft_L \bar{L}_{\varphi} \otimes_L \bar{L}_{\omega} \otimes_L L_{\varphi \omega} \simeq C\ell^2(G) .$$

Here the chosen families correspond to the vertical identity morphisms after horizontally composing the two equidirectional defects in the bicategory of topological defects \mathcal{B}_{YM} from Section 3.2.

From [RS21, Section 5.3] we get

Lemma 3.20. *The twisted sectors of the orbifold theory are given by*

$$\mathcal{H} = \bigoplus_{\varphi \in \Gamma} \mathcal{H}_\varphi ,$$

where $\mathcal{H}_\varphi = \circlearrowleft_L L_\varphi$ is the space of square-integrable functions on G which are invariant under twisted conjugation by $\varphi \in \Gamma$, see Section 2.5.

We will need the morphisms

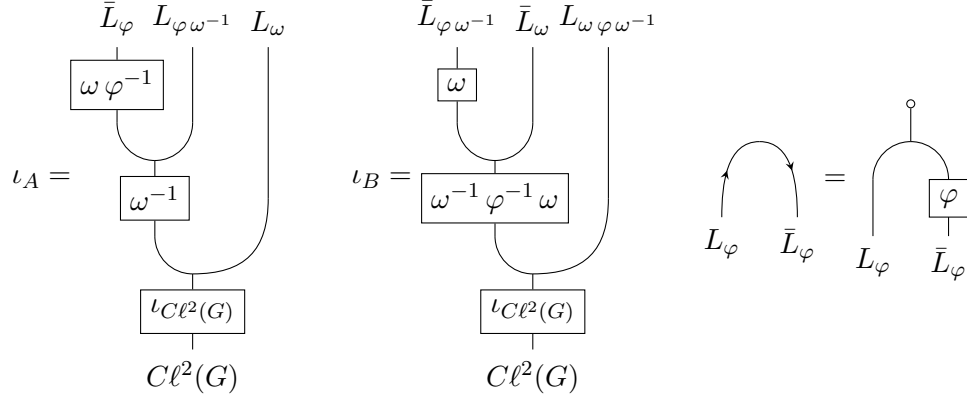

Lemma 3.21. *The state sum construction assigns to the parts of a cell decomposition*

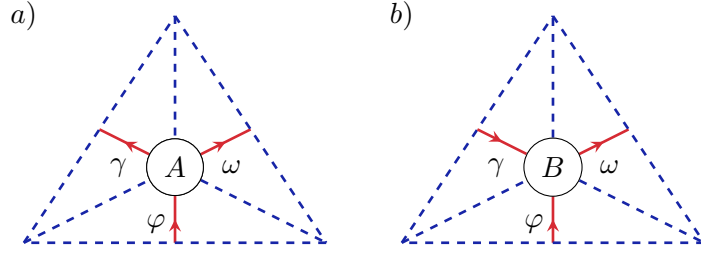

each with total area a , the respective morphisms

$$\frac{1}{|\Gamma|} \delta_{\varphi, \gamma \omega} \iota_A \circ \eta_a^{L^2(G)} \quad \text{and} \quad \delta_{\gamma \varphi, \omega} \iota_B \circ \eta_a^{L^2(G)} .$$

Proof. Let $\gamma := \varphi \omega^{-1}$. The morphism assigned to the part of the cell decomposition a) is

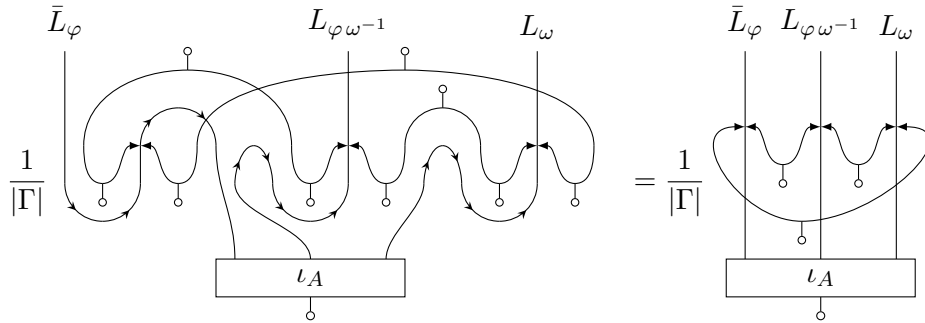

Now we use the fact that ι_A cancels the idempotents \mathcal{D}_0 assigned to cylinders with parallel defect lines to obtain $\frac{1}{|\Gamma|} \iota_A \circ \eta_a^{L^2(G)}$. One similarly computes the morphism associated to b). \square

Next we turn to the projector of [BCP14, Section 1] whose image is the state space of the orbifold theory. The projector \mathcal{P} is obtained by applying the defect area-dependent quantum field theory on the cylinders in Figure 4 and taking the weak-coupling limit.

Proposition 3.22. 1. The projector \mathcal{P} is given by

$$\mathcal{P} = \frac{1}{|\Gamma|} \sum_{\omega \in \Gamma} (\omega^{-1})^* : \mathcal{H} \longrightarrow \mathcal{H} , \quad (3.23)$$

which implements an action of Γ on \mathcal{H} .

2. The image of \mathcal{P} is the subspace \mathcal{H}^Γ of Γ -invariants under this action and there is an isomorphism

$$\mathcal{H}^\Gamma \simeq C\ell^2(G \rtimes \Gamma) .$$

Proof. For Part 1, take a cell decomposition of the cylinder in Figure 4 where we cut along the dashed lines:

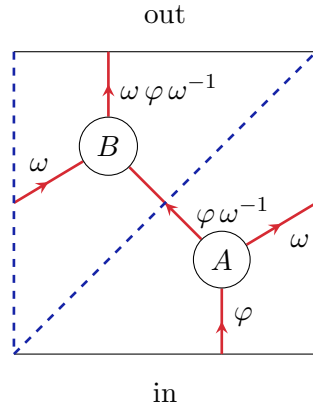

Using Lemma 3.21, the morphism assigned by the state sum area-dependent quantum field theory to the cylinder is

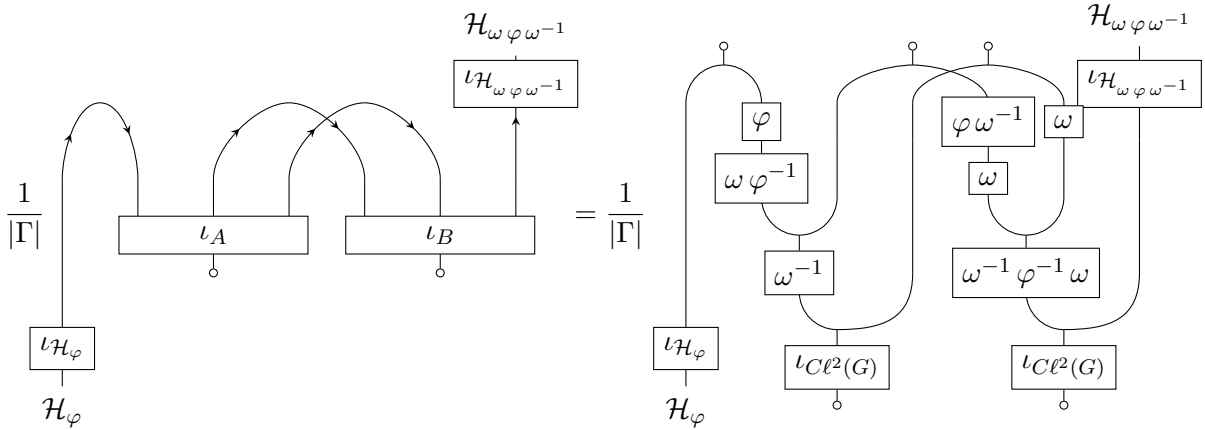

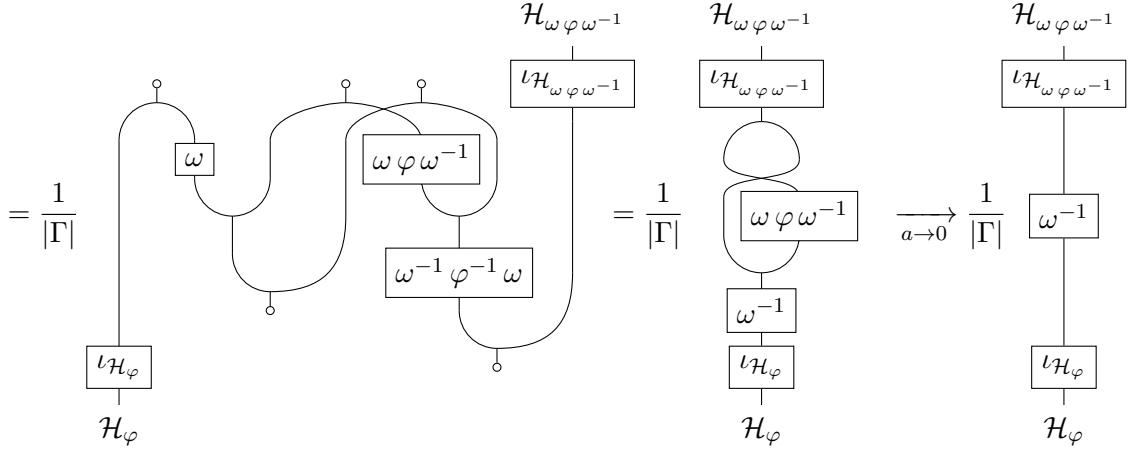

Summing over $\varphi, \omega \in \Gamma$ we get (3.23).

For Part 2, let $h \in \mathcal{H}^\Gamma$ and write $h = \sum_{\varphi \in \Gamma} h_\varphi$ for its components. We define the map

$$\Psi : \mathcal{H}^\Gamma \longrightarrow C\ell^2(G \rtimes \Gamma), \quad h \longmapsto [(x, \alpha) \mapsto h_\alpha(x)].$$

We show that the image of the map Ψ indeed lands in $C\ell^2(G \rtimes \Gamma)$. Since h is invariant under the action of Γ we have

$$\omega \cdot h = \sum_{\varphi \in \Gamma} \omega \cdot h_\varphi = \sum_{\gamma \in \Gamma} h_\gamma = h.$$

Because $\omega \cdot h_\varphi \in \mathcal{H}_{\omega\varphi\omega^{-1}}$, we get

$$h_\varphi \circ \omega^{-1} = \omega \cdot h_\varphi = h_{\omega\varphi\omega^{-1}}. \quad (3.24)$$

Let $(x, \varphi), (y, \omega) \in G \rtimes \Gamma$ and $f := \Psi(h)$. Then

$$\begin{aligned} f((x, \varphi) \cdot (y, \omega) \cdot (x, \varphi)^{-1}) &= f(x \varphi(y) (\varphi \omega \varphi^{-1})(x^{-1}), \varphi \omega \varphi^{-1}) \\ &:= h_{\varphi \omega \varphi^{-1}}(x \varphi(y) (\varphi \omega \varphi^{-1})(x^{-1})) \\ &= h_{\varphi \omega \varphi^{-1}}(\varphi(y)) \\ &= h_\omega(y) \\ &=: f(y, \omega), \end{aligned}$$

where in the third equality we used the twisted conjugation property of elements in $\mathcal{H}_{\varphi \omega \varphi^{-1}}$, and in the fourth equality we used (3.24).

Now we define

$$\Phi : C\ell^2(G \rtimes \Gamma) \longrightarrow \mathcal{H}^\Gamma, \quad f \longmapsto h^f = \sum_{\varphi \in \Gamma} h_\varphi^f,$$

where $h_\varphi^f(x) = f(x, \varphi)$. We show that the image of the map Φ indeed lands in \mathcal{H}^Γ . First we show that $h_\varphi^f \in \mathcal{H}_\varphi$ for $\varphi \in \Gamma$. Let $x, y \in G$ and compute

$$h_\varphi^f(xy\varphi(x^{-1})) := f(xy\varphi(x^{-1}), \varphi) = f((x, \text{id}_G) \cdot (y, \varphi) \cdot (x, \text{id}_G)^{-1}) = f(y, \varphi) = h_\varphi^f(y),$$

where in the third equality we used the twisted conjugation invariance of f . Next we show that h^f is Γ -invariant:

$$\begin{aligned}
(\omega \cdot h^f)(x) &= \sum_{\varphi \in \Gamma} (\omega \cdot h^f_{\varphi})(x) \\
&= \sum_{\varphi \in \Gamma} h^f_{\varphi}(\omega^{-1}(x)) \\
&= \sum_{\varphi \in \Gamma} f(\omega^{-1}(x), \varphi) \\
&= \sum_{\varphi \in \Gamma} f((1, \omega) \cdot (\omega^{-1}(x), \varphi) \cdot (1, \omega)^{-1}) \\
&= \sum_{\varphi \in \Gamma} f(x, \omega \varphi \omega^{-1}) \\
&= \sum_{\varphi' \in \Gamma} f(x, \varphi') \\
&= h^f(x),
\end{aligned}$$

where in the fourth equality we used again the twisted conjugation invariance of f and changed summation variable in the sixth equality.

Clearly the maps Ψ and Φ are inverse to each other. □

Theorem 3.25. *The orbifold theory of two-dimensional Yang-Mills theory with gauge group G and with orbifold defect*

$$\bigoplus_{\varphi \in \Gamma} L_{\varphi}$$

is two-dimensional Yang-Mills theory with gauge group $G \rtimes \Gamma$.

Proof. We need to compute the regularised Frobenius algebra structure on $C\ell^2(G \rtimes \text{Out}(G))$ given by the orbifold theory. This is done by computing the orbifold theory on the generators of $\mathcal{B}\text{ord}_2^{\text{area}}$. The computations are similar to those for the cylinder in the proof of Proposition 3.22, so here we provide less details.

For the cup with area a we pick the defect network and cell decomposition

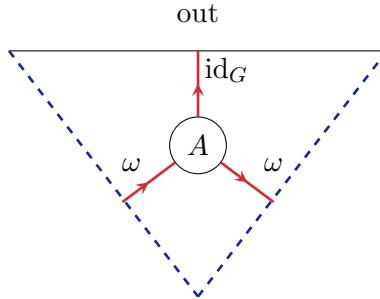

where we identify the two dashed edges on the two sides. The value of the state sum area-dependent

quantum field theory on this is

$$\frac{1}{|\Gamma|} \sum_{\omega \in \Gamma} \text{Diagram 1} = \frac{1}{|\Gamma|} \sum_{\omega \in \Gamma} \text{Diagram 2} = \text{Diagram 3}$$

We similarly obtain

$$|\Gamma| \begin{array}{c} \circ \\ \hline \iota \mathcal{H}_{id_G} \\ \hline \mathcal{H}_{id_G} \end{array}$$

for the value of the area-dependent quantum field theory on the cap with the defect network and cell decomposition

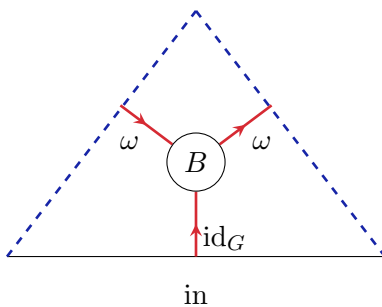

Finally let us turn to the pair of pants with two ingoing circles and one outgoing circle:

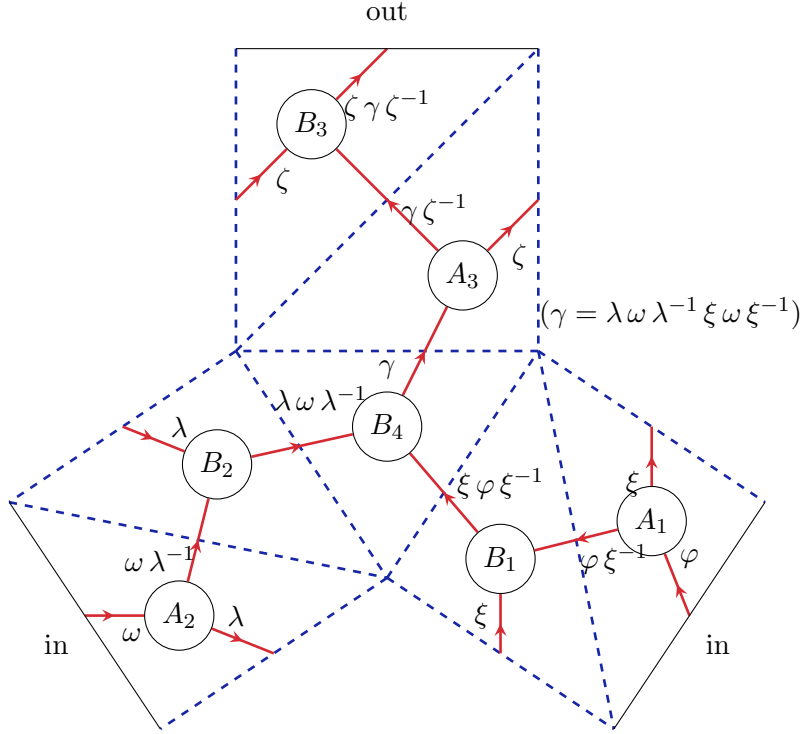

To this decomposition the state sum area-dependent quantum field theory assigns the morphism

$$\begin{aligned}
& \frac{1}{|\Gamma|^3} \sum_{\xi, \lambda, \zeta \in \Gamma} \begin{array}{c} \mathcal{H}_{\zeta \gamma \zeta^{-1}} \\ \pi \mathcal{H}_{\zeta \gamma \zeta^{-1}} \\ \zeta^{-1} \\ \begin{array}{c} \lambda^{-1} \quad \xi^{-1} \\ \downarrow \quad \downarrow \\ \iota_{\mathcal{H}_\omega} \quad \iota_{\mathcal{H}_\varphi} \\ \mathcal{H}_\omega \quad \mathcal{H}_\varphi \end{array} \\ \downarrow \\ \iota_{B_4} \end{array} \\
&= \frac{1}{|\Gamma|^3} \sum_{\xi, \lambda, \zeta \in \Gamma} \begin{array}{c} \mathcal{H}_{\zeta \gamma \zeta^{-1}} \\ \lambda \omega \lambda^{-1} \quad \pi \mathcal{H}_{\zeta \gamma \zeta^{-1}} \\ \zeta^{-1} \\ \begin{array}{c} \xi \varphi \xi^{-1} \\ \downarrow \\ \lambda \omega \lambda^{-1} \\ \downarrow \\ \gamma^{-1} \end{array} \\ \downarrow \\ \begin{array}{c} \lambda^{-1} \quad \xi^{-1} \\ \downarrow \quad \downarrow \\ \iota_{\mathcal{H}_\omega} \quad \iota_{\mathcal{H}_\varphi} \\ \mathcal{H}_\omega \quad \mathcal{H}_\varphi \end{array} \end{array} \\
&= \frac{1}{|\Gamma|^3} \sum_{\xi, \lambda, \zeta \in \Gamma} \begin{array}{c} \mathcal{H}_{\zeta \gamma \zeta^{-1}} \\ \pi \mathcal{H}_{\zeta \gamma \zeta^{-1}} \\ \zeta^{-1} \\ \begin{array}{c} \xi \varphi \xi^{-1} \\ \downarrow \\ \lambda^{-1} \quad \xi^{-1} \\ \downarrow \quad \downarrow \\ \iota_{\mathcal{H}_\omega} \quad \iota_{\mathcal{H}_\varphi} \\ \mathcal{H}_\omega \quad \mathcal{H}_\varphi \end{array} \end{array} = \frac{1}{|\Gamma|^2} \sum_{\varrho, \nu \in \Gamma} \begin{array}{c} \mathcal{H}_{\nu \omega \nu^{-1} \varrho \varphi \varrho^{-1}} \\ \pi \mathcal{H}_{\nu \omega \nu^{-1} \varrho \varphi \varrho^{-1}} \\ \varrho \varphi \varrho^{-1} \\ \begin{array}{c} \nu^{-1} \quad \varrho^{-1} \\ \downarrow \quad \downarrow \\ \iota_{\mathcal{H}_\omega} \quad \iota_{\mathcal{H}_\varphi} \\ \mathcal{H}_\omega \quad \mathcal{H}_\varphi \end{array} \end{array} \quad (3.26)
\end{aligned}$$

Let $f, g \in C\ell^2(G \rtimes \Gamma) \simeq \mathcal{H}^\Gamma$ with components $f_\omega = f(\cdot, \omega)$ and $g_\omega = g(\cdot, \omega)$ for $\omega \in \Gamma$. The

morphism in (3.26) acts on these functions as

$$f \otimes g \mapsto \frac{1}{|\Gamma|^2} \sum_{\varphi, \omega, \varrho, \nu \in \Gamma} (f_{\nu \omega \nu^{-1}} \circ (\varrho \varphi \varrho^{-1})) * g_{\varrho \varphi \varrho^{-1}} = \sum_{\sigma, \kappa \in \Gamma} (f_{\kappa} \circ \sigma) * g_{\sigma} = \sum_{\sigma, \kappa \in \Gamma} f_{\sigma^{-1} \kappa \sigma} * g_{\sigma}$$

which maps

$$(x, \gamma) \mapsto \sum_{\sigma, \kappa \in \Gamma} (f_{\sigma^{-1} \kappa \sigma} * g_{\sigma})(x) \delta_{\kappa \sigma, \gamma} = \sum_{\sigma \in \Gamma} (f_{\sigma^{-1} \gamma} * g_{\sigma})(x),$$

as $f_{\sigma^{-1} \kappa \sigma} * g_{\sigma} \in \mathcal{H}_{\kappa \sigma}$. On the other hand we have

$$\begin{aligned} (f * g)(x, \gamma) &= \frac{1}{|\Gamma|} \sum_{\kappa \in \Gamma} \int_G dy f(y, \kappa) g((y, \kappa)^{-1} \bullet (x, \gamma)) \\ &= \frac{1}{|\Gamma|} \sum_{\kappa \in \Gamma} \int_G dy f_{\kappa}(y) g_{\kappa^{-1} \gamma}(\kappa^{-1}(y^{-1} x)) \\ &= \frac{1}{|\Gamma|} \sum_{\kappa \in \Gamma} \int_G dy f_{\kappa}(y) g_{\gamma \kappa^{-1}}(y^{-1} x) \\ &= \frac{1}{|\Gamma|} \sum_{\sigma \in \Gamma} (f_{\sigma^{-1} \gamma} * g_{\sigma})(x). \end{aligned}$$

Altogether we have shown that multiplying by $|\Gamma|$ is an isomorphism of regularised Frobenius algebras $C\ell^2(G \times \Gamma) \xrightarrow{\cong} \mathcal{H}^{\Gamma}$. \square

3.5 Orbifold equivalence and the backwards orbifold

We can translate the statement of Theorem 3.25 into an adjoint equivalence in the orbifold completion $\mathcal{B}_{\text{YM}}^{\text{orb}}$ [CR16] of the topological defect bicategory of two-dimensional Yang-Mills theories \mathcal{B}_{YM} , which is idempotent complete by Proposition 3.12. Since the objects of \mathcal{B}_{YM} are bimodules in the symmetric monoidal category $\mathcal{H}\text{ilb}$, and the left and right duality morphisms can be related by the symmetric braiding, it follows that the defect bicategory \mathcal{B}_{YM} is pivotal, similarly to the case of topological field theories.

Proposition 3.27. *There are adjoint equivalences in $\mathcal{B}_{\text{YM}}^{\text{orb}}$:*

$${}_K K_L : (L, {}_L K_L) \rightleftarrows (K, {}_K K_K) : {}_L K_K \quad \text{and} \quad {}_K K_L : (L, {}_L L_L) \rightleftarrows (K, {}_K K \otimes_L K_K) : {}_L K_K.$$

Proof. Observe that ${}_L K_L \simeq {}_L K \otimes_K K_L$. Then use [CR16, Proposition 4.4] get the second adjoint equivalence. \square

By [CR16, Proposition 4.3], $K \otimes_{L^2(G)} K$ has the structure of a strongly separable symmetric Frobenius algebra, which we will describe in more detail now. We will see that $K \otimes_{L^2(G)} K$ is a Wilson line defect, which is isomorphic to a defect coming from a group symmetry exactly when Γ is abelian.

Proposition 3.28. 1. $K \otimes_L K \simeq K \otimes H$ as K - K -bimodules. The left K -action is by multiplication on the K factor and the right K -action is

(3.29)

where we used the isomorphism $\Phi : L \rtimes H \xrightarrow{\simeq} K$ from Part 1 of Proposition 3.17. Denote this K - K -bimodule by $(K \otimes H)_{\text{ind}}$.

2. Consider $H = L^2(\Gamma)$ as a left Γ -module with action given by $(\gamma \cdot \phi)_\omega = \phi_{\omega\gamma}$ for $\omega, \gamma \in \Gamma$ and $\phi \in H$, and consider the pullback of H along the projection $G \rtimes \Gamma \rightarrow \Gamma$ which we denote again by H . Write $(K \otimes H)_{\text{Wilson}}$ for the K - K -bimodule structure given by Example 3.13. The left K -action is by multiplication on the K factor and the right K -action is given by

(3.30)

3. The map

$$\Psi = \begin{array}{c} L \quad H \quad H \\ | \quad | \quad | \\ | \quad | \quad | \\ | \quad | \quad | \\ L \quad H \quad H \end{array}$$

is a K - K -bimodule isomorphism $\Psi : (K \otimes H)_{\text{ind}} \rightarrow (K \otimes H)_{\text{Wilson}}$.

4. The bimodule $(K \otimes H)_{\text{Wilson}}$ is a direct sum of invertible bimodules if and only if Γ is abelian.

Proof. For Part 1, the idempotent $\mathcal{D}_0^{K,K}$ projecting onto the relative tensor product is the weak-coupling limit

$$\mathcal{D}_0^{K,K} = \lim_{a \rightarrow 0} \begin{array}{c} K \quad L \quad H \\ | \quad | \quad | \\ | \quad | \quad | \\ | \quad | \quad | \\ K \quad L \quad H \end{array} = \lim_{a \rightarrow 0} \begin{array}{c} L \quad H \quad L \quad H \\ | \quad | \quad | \quad | \\ | \quad | \quad | \quad | \\ | \quad | \quad | \quad | \\ L \quad H \quad L \quad H \end{array} = \begin{array}{c} L \quad H \quad L \quad H \\ | \quad | \quad | \quad | \\ | \quad | \quad | \quad | \\ | \quad | \quad | \quad | \\ L \quad H \quad L \quad H \end{array}$$

We can factorise this as $\mathcal{D}_0^{K,K} = \iota \circ \pi$, where

$$\pi = \begin{array}{c} K \quad H \\ \downarrow \quad \downarrow \\ K \quad L \quad H \\ \leftarrow \quad \downarrow \quad \downarrow \end{array} = \begin{array}{c} L \quad H \quad H \\ \downarrow \quad \downarrow \quad \downarrow \\ L \quad H \quad L \quad H \\ \leftarrow \quad \downarrow \quad \downarrow \end{array} \quad \iota = \lim_{a \rightarrow 0} \begin{array}{c} K \quad L \quad H \\ \downarrow \quad \downarrow \quad \downarrow \\ K \quad H \\ \leftarrow \quad \downarrow \quad \downarrow \end{array} = \begin{array}{c} L \quad H \quad L \quad H \\ \downarrow \quad \downarrow \quad \downarrow \quad \downarrow \\ L \quad H \quad H \\ \leftarrow \quad \downarrow \quad \downarrow \end{array}$$

We first show $\pi \circ \iota = \text{id}_{K \otimes H}$:

$$\pi \circ \iota = \lim_{a \rightarrow 0} \begin{array}{c} K \quad H \\ \downarrow \quad \downarrow \\ K \quad H \\ \leftarrow \quad \downarrow \quad \downarrow \end{array} = \lim_{a \rightarrow 0} \begin{array}{c} K \quad H \\ \downarrow \quad \downarrow \\ K \quad H \\ \leftarrow \quad \downarrow \quad \downarrow \end{array} = \lim_{a \rightarrow 0} \begin{array}{c} K \quad H \\ \downarrow \quad \downarrow \\ K \quad H \\ \leftarrow \quad \downarrow \quad \downarrow \end{array} = \text{id}_{K \otimes H} .$$

Now we show $\iota \circ \pi = \mathcal{D}_0^{K,K}$:

$$\iota \circ \pi = \lim_{a \rightarrow 0} \begin{array}{c} K \quad L \quad H \\ \downarrow \quad \downarrow \quad \downarrow \\ K \quad L \quad H \\ \leftarrow \quad \downarrow \quad \downarrow \end{array} = \lim_{a \rightarrow 0} \begin{array}{c} K \quad L \quad H \\ \downarrow \quad \downarrow \quad \downarrow \\ K \quad L \quad H \\ \leftarrow \quad \downarrow \quad \downarrow \end{array} = \lim_{a \rightarrow 0} \begin{array}{c} K \quad L \quad H \\ \downarrow \quad \downarrow \quad \downarrow \\ K \quad L \quad H \\ \leftarrow \quad \downarrow \quad \downarrow \end{array} = \mathcal{D}_0^{K,K} .$$

The induced action can be computed in a similar way as

$$\pi \circ \rho^{K \otimes L K} \circ \iota = \begin{array}{c} K \quad H \\ \downarrow \quad \downarrow \\ K \quad K \quad H \quad L \quad H \\ \leftarrow \quad \downarrow \quad \downarrow \end{array}$$

and after writing out the right action of L on K we get (3.29).

For Part 2 we compute the right K -action on $(K \otimes H)_{\text{Wilson}}$ for $f, g \in L$ and $\delta_\varphi, \delta_\omega, \delta_\gamma \in H$

with $\varphi, \omega, \gamma \in \Gamma$:

$$\begin{aligned}
& (f \otimes \delta_\varphi \otimes \delta_\omega) \cdot (g \otimes \delta_\gamma) \\
&= \left[(x, \sigma) \mapsto \int_G dy \frac{1}{|\Gamma|} \sum_{\kappa \in \Gamma} f(x (\sigma \kappa^{-1})(y^{-1})) \delta_\varphi(\sigma \kappa^{-1}) (\kappa^{-1} \cdot \delta_\omega) g(y) \delta_\gamma(\kappa) \right] \\
&= \left[(x, \sigma) \mapsto \int_G dy \frac{1}{|\Gamma|} \sum_{\kappa \in \Gamma} f(x \varphi(y^{-1})) \delta_{\varphi\gamma}(\sigma) (\gamma^{-1} \cdot \delta_\omega) g(y) \delta_\gamma(\kappa) \right] \\
&= \left[(x, \sigma) \mapsto \frac{1}{|\Gamma|} \int_G dy f(x \varphi(y^{-1})) \delta_{\varphi\gamma}(\sigma) \delta_{\omega\gamma} g(y) \right] \\
&= \left[(x, \sigma) \mapsto \frac{1}{|\Gamma|} \int_G dz f(x z^{-1}) \delta_{\varphi\gamma}(\sigma) \delta_{\omega\gamma} g(\varphi^{-1}(z)) \right] \\
&= (f * (\delta_\varphi \cdot g)) \otimes \delta_{\varphi\gamma} \otimes \delta_{\omega\gamma} ,
\end{aligned}$$

where in the first step we used the delta-functions, in the second step we used the action of Γ on H , and finally the invariance of the integral. This is exactly the right K -action in (3.30).

For Part 3, we use Part 1 to read off the right K -action on $(K \otimes H)_{\text{ind}}$ to be

$$(f \otimes \delta_\varphi \otimes \delta_\omega) \cdot (g \otimes \delta_\gamma) = (f * (\delta_{\varphi\omega} \cdot g)) \otimes \delta_\varphi \otimes \delta_{\omega\gamma} .$$

Since Ψ obviously commutes with the left K -actions, we only need to show that Ψ commutes with the right K -actions:

$$\begin{aligned}
\Psi(f \otimes \delta_\varphi \otimes \delta_\omega) \cdot (g \otimes \delta_\gamma) &= (f \otimes \delta_{\varphi\omega} \otimes \delta_\omega) \cdot (g \otimes \delta_\gamma) = (f * (\delta_{\varphi\omega} \cdot g)) \otimes \delta_{\varphi\omega\gamma} \otimes \delta_{\omega\gamma} , \\
\Psi((f \otimes \delta_\varphi \otimes \delta_\omega) \cdot (g \otimes \delta_\gamma)) &= \Psi((f * (\delta_{\varphi\omega} \cdot g)) \otimes \delta_\varphi \otimes \delta_{\omega\gamma}) = (f * (\delta_{\varphi\omega} \cdot g)) \otimes \delta_{\varphi\omega\gamma} \otimes \delta_{\omega\gamma} .
\end{aligned}$$

Clearly Ψ is an isomorphism.

Part 4 follows from the facts that $L^2(\Gamma) \simeq \bigoplus_{c \in \widehat{\Gamma}} V_c^{\oplus v_c}$ as Γ -modules, where $v_c = \dim V_c$ and V_c is a representative of the conjugacy class c , and that all simple Γ -modules are one-dimensional if and only if Γ is abelian. \square

As a consequence of Propositions 3.27 and 3.28 we get the defect for the backwards orbifold:

Theorem 3.31. *The orbifold theory of two-dimensional Yang-Mills theory with gauge group $G \rtimes \Gamma$ and with orbifold Wilson line defect*

$$L^2(G \rtimes \Gamma) \otimes L^2(\Gamma)$$

is two-dimensional Yang-Mills theory with gauge group G .

References

- [AB82] M.F. Atiyah and R. Bott, *The Yang-Mills equations over Riemann surfaces*. Phil. Trans. Roy. Soc. London A **308** (1982) 523–615.
- [Ati88] M.F. Atiyah, *Topological quantum field theory*. Publ. Math. IHÉS **68** (1988) 175–186.
- [BBCW19] M. Barkeshli, P. Bonderson, M. Cheng, and Z. Wang, *Symmetry, defects, and gauging of topological phases*. Phys. Rev. B **100** (2019) 114147, [arXiv:1410.4540 [cond-mat.str-el]].
- [BCP14] I. Brunner, N. Carqueville, and D. Plencker, *A quick guide to defect orbifolds*. Proc. Symp. Pure Math. **88** (2014) 231–242, [1310.0062 [hep-th]].
- [BFS99] L. Birke, J. Fuchs, and C. Schweigert, *Symmetry breaking boundary conditions and WZW orbifolds*. Adv. Theor. Math. Phys. **3** (1999) 671–726, [arXiv:hep-th/9905038].
- [BJQ13] M. Barkeshli, C.-M. Jian, and X.-L. Qi, *Twist defects and projective non-abelian braiding statistics*. Phys. Rev. B **87** (2013) 045130, [arXiv:1208.4834 [cond-mat.str-el]].
- [BT92] M. Blau and G. Thompson, *Quantum Yang-Mills theory on arbitrary surfaces*. Int. J. Mod. Phys. A **7** (1992) 3781–3806.
- [CMR95] S. Cordes, G. Moore, and S. Ramgoolam, *Lectures on 2D Yang-Mills theory, equivariant cohomology and topological field theories*. Nucl. Phys. Proc. Suppl. **41** (1995) 184–244, [hep-th/9411210].
- [CR16] N. Carqueville and I. Runkel, *Orbifold completion of defect bicategories*. Quantum Topol. **7** (2016) 203–279, [1210.6363 [math.QA]].
- [CRS19] N. Carqueville, I. Runkel, and G. Schaumann, *Orbifolds of n -dimensional defect TQFTs*. Geom. Topol. **23** (2019) 781–864, [1705.06085 [math.QA]].
- [DKR11] A. Davydov, L. Kong, and I. Runkel, *Field theories with defects and the centre functor*. Proc. Symp. Pure Math. **83** (2011) 71–130, [1107.0495 [math.QA]].
- [DW90] R. Dijkgraaf and E. Witten, *Topological gauge theories and group cohomology*. Commun. Math. Phys. **129** (1990) 393–429.
- [FFRS09] J. Fröhlich, J. Fuchs, I. Runkel, and C. Schweigert. *Defect lines, dualities, and generalised orbifolds*. In P. Exner, editor, *Proceedings of the XVI International Congress on Mathematical Physics*, pages 608–613. World Scientific, 2009, [0909.5013 [math-ph]].
- [FPSV15] J. Fuchs, J. Priel, C. Schweigert, and A. Valentino, *On the Brauer groups of symmetries of abelian Dijkgraaf-Witten theories*. Commun. Math. Phys. **339** (2015) 385–405, [1404.6646 [hep-th]].
- [Fre95] D.S. Freed, *Classical Chern-Simons theory 1*. Adv. Math. **113** (1995) 237–303, [hep-th/9206021].
- [FS15] J. Fuchs and C. Schweigert, *Symmetries and defects in three-dimensional topological field theory*. Proc. Symp. Pure Math. **93** (2015) 21–40, [1501.01885 [hep-th]].

- [FSS96] J. Fuchs, B. Schellekens, and C. Schweigert, *From Dynkin diagram symmetries to fixed point structures*. Commun. Math. Phys. **180** (1996) 39–97, [[hep-th/9506135](#)].
- [FSV14] J. Fuchs, C. Schweigert, and A. Valentino, *A geometric approach to boundaries and surface defects in Dijkgraaf-Witten theories*. Commun. Math. Phys. **332** (2014) 981–1015, [[1307.3632](#) [[hep-th](#)]].
- [GSS04] L. Griguolo, D. Seminara, and R.J. Szabo, *Two-dimensional Yang-Mills theory and moduli spaces of holomorphic differentials*. Phys. Lett. B **600** (2004) 275–286, [[hep-th/0408055](#)].
- [GSS05] L. Griguolo, D. Seminara, and R.J. Szabo, *Instantons, fluxons and open gauge string theory*. Adv. Theor. Math. Phys. **9** (2005) 775–860, [[hep-th/0411277](#)].
- [Kap11] A. Kapustin. *Topological field theory, higher categories, and their applications*. In R. Bhatia, A. Pal, G. Rangarajan, V. Srinivas and M. Vanninathan, editor, *Proceedings of the International Congress of Mathematicians 2010*, volume III, pages 2021–2043. World Scientific, 2011, [[1004.2307](#) [[math.QA](#)]].
- [Kas94] C. Kassel. *Quantum Groups*. Graduate Texts in Mathematics. Springer, (1994).
- [KSS16] Z. Kökényesi, A. Sinkovics, and R.J. Szabo, *Chiral expansion and Macdonald deformation of two-dimensional Yang-Mills theory*. Fortsch. Phys. **64** (2016) 823–853, [[1605.03748](#) [[hep-th](#)]].
- [KT14] A. Kapustin and R. Thorngren, *Anomalies of discrete symmetries in various dimensions and group cohomology*. [[1404.3230](#) [[hep-th](#)]].
- [Lab13] F. Labourie. *Lectures on Representations of Surface Groups*. Zürich Lectures in Advanced Mathematics. EMS Publishing House, (2013).
- [Mei17] E. Meinrenken, *Convexity for twisted conjugation*. Math. Res. Lett. **24** (2017) 1797–1818, [[1512.09000](#) [[math.DG](#)]].
- [Mig75] A.A. Migdal, *Recursion equations in gauge field theories*. Sov. Phys. JETP **42** (1975) 413–418.
- [MS19] L. Müller and R.J. Szabo, *'t Hooft anomalies of discrete gauge theories and non-abelian group cohomology*. Commun. Math. Phys. **375** (2019) 1581–1627, [[1811.05446](#) [[hep-th](#)]].
- [PZ01] V.B. Petkova and J.-B. Zuber, *Conformal boundary conditions and what they teach us*. In Z. Horvath and L. Palla, editor, *Nonperturbative QFT Methods and their Applications*, pages 1–35. World Scientific, 2001, [[hep-th/0103007](#)].
- [RS21] I. Runkel and L. Szegedy, *Area-dependent quantum field theory with defects*. Commun. Math. Phys. **381** (2021) 83–117, [[1807.08196](#) [[math.QA](#)]].
- [Rus90] B.E. Rusakov, *Loop averages and partition functions in $U(N)$ gauge theory on two-dimensional manifolds*. Mod. Phys. Lett. A **5** (1990) 693–703.
- [Seg88] G.B. Segal, *The definition of conformal field theory*. NATO Sci. Ser. **250** (1988) 165–171.

- [Seg89] G.B. Segal. *Two-dimensional conformal field theories and modular functors*. In B. Simon, A. Truman and M. Davies, editor, *Proceedings of the IX International Congress on Mathematical Physics*, pages 22–37. CRC Press, 1989.
- [SY90] A.N. Schellekens and S. Yankielowicz, *Simple currents, modular invariants and fixed points*. *Int. J. Mod. Phys. A* **5** (1990) 2903–2952.
- [Tac20] Y. Tachikawa, *On gauging finite subgroups*. *SciPost Phys.* **8** (2020) 015, [1712.09542 [hep-th]].
- [Wit91] E. Witten, *On quantum gauge theories in two dimensions*. *Commun. Math. Phys.* **141** (1991) 153–209.
- [Wit92] E. Witten, *Two-dimensional gauge theories revisited*. *J. Geom. Phys.* **9** (1992) 303–368, [hep-th/9204083].
- [Zer18] A.J. Zerouali, *Twisted conjugation on connected simple Lie groups and twining characters*. [1811.06507 [math.RT]].