

Marginal Deformations of 3d $\mathcal{N} = 4$ Linear Quiver Theories

Constantin Bachas^a, Ioannis Lavdas^a and Bruno Le Floch^b

^a*Laboratoire de Physique de l'École Normale Supérieure, ÉNS, Université PSL, CNRS, Sorbonne Université, Université Paris-Diderot, Sorbonne Paris Cité, Paris, France*

^b*Institut Philippe Meyer, Département de Physique, École Normale Supérieure, Université PSL, Paris, France*

Abstract

We study superconformal deformations of the $T_\rho^\hat{\rho}[SU(N)]$ theories of Gaiotto-Hanany-Witten, paying special attention to mixed-branch operators with both electrically- and magnetically-charged fields. We explain why all marginal $\mathcal{N} = 2$ operators of an $\mathcal{N} = 4$ CFT₃ can be extracted unambiguously from the superconformal index. Computing the index at the appropriate order we show that the mixed moduli in $T_\rho^\hat{\rho}[SU(N)]$ theories are double-string operators transforming in the (Adjoint, Adjoint) representation of the electric and magnetic flavour groups, up to some overcounting for quivers with abelian gauge nodes. We comment on the holographic interpretation of the results, arguing in particular that gauged supergravities can capture the entire moduli space if, in addition to the (classical) parameters of the background solution, one takes also into account the (quantization) moduli of boundary conditions.

Contents

1	Introduction	3
2	Superconformal index of $T_{\hat{\rho}}[SU(N)]$	5
2.1	Generalities	5
2.2	Integral expression for the index	6
3	Characters of $OSp(4 4)$ and Hilbert series	8
3.1	Representations and recombination rules	8
3.2	Protected multiplets and Hilbert series	9
4	Calculation of the index	10
4.1	The zero-monopole sector	11
4.2	Higgs-branch chiral ring	13
4.3	Contribution of monopoles	14
4.4	The mixed term	17
5	Counting the $\mathcal{N} = 2$ moduli	18
5.1	Examples and interpretation	19
5.2	The holographic perspective	22
5.3	One last comment	24
A	Index and plethystic exponentials	25
B	Combinatorics of linear quivers	27
C	$T[SU(2)]$ index as holomorphic blocks	30

1 Introduction

Superconformal field theories (SCFT) often have continuous deformations preserving some superconformal symmetry. The space of such deformations is a Riemannian manifold (the ‘superconformal manifold’) which coincides with the moduli space of supersymmetric Anti-de Sitter (AdS) vacua when the SCFT has a holographic dual. Mapping out such moduli spaces is of interest both for field theory and for the study of the string-theory landscape.

In this paper we will be interested in superconformal manifolds in the vicinity of the ‘good’ theories $T_\rho^\hat{\rho}[SU(N)]$ whose existence was conjectured by Gaiotto and Witten [1]. These are three-dimensional $\mathcal{N} = 4$ SCFTs arising as infrared fixed points of a certain class of quiver gauge theories introduced by Hanany and Witten [2]. Their holographic duals are four-dimensional Anti-de Sitter (AdS₄) solutions of type-IIB string theory [3, 4, 5, 6]. Our main motivation in this work was to extract features of these moduli spaces not readily accessible from the gravity side. We build on the analysis of ref. [7] which we complete and amend in significant ways.

Superconformal deformations of a d -dimensional theory T_\star are generated by the set of marginal operators $\{\mathcal{O}_i\}$ that preserve some or all of its supersymmetries.¹ The existence of such operators is constrained by the analysis of representations of the superconformal algebra [8]. In particular, unitary SCFTs have no moduli in $d = 5$ or 6 dimensions, whereas in the case $d = 3$ of interest here moduli preserve at most $\mathcal{N} = 2$ supersymmetries. Those preserving only $\mathcal{N} = 1$ belong to long (‘D-term’) multiplets whose dimension is not protected against quantum corrections. The existence of such $\mathcal{N} = 1$ moduli (and of non-supersymmetric ones) is fine-tuned and thus accidental. For this reason we focus here on the $\mathcal{N} = 2$ moduli.

The general local structure of $\mathcal{N} = 2$ superconformal manifolds in three dimensions (and of the closely-related case $\mathcal{N} = 1$ in $d = 4$) has been described in [9, 10, 11, 12, 13]. These manifolds are Kähler quotients of the space $\{\lambda^i\}$ of marginal supersymmetry-preserving couplings modded out by the complexified global (flavor) symmetry group G_{global} ,

$$\mathcal{M}_{\text{SC}} \simeq \{\lambda^i\}/G_{\text{global}}^{\mathbb{C}} \simeq \{\lambda^i | D^a = 0\}/G_{\text{global}} . \quad (1.1)$$

The meaning of this is as follows: marginal scalar operators \mathcal{O}_i fail to be *exactly* marginal if and only if they combine with conserved-current multiplets of G_{global} to form long (unprotected) current multiplets. Requesting this not to happen imposes the moment-map conditions

$$D^a = \lambda^i T_{ij}^a \bar{\lambda}^{\bar{j}} + O(\lambda^3) = 0 , \quad (1.2)$$

where T^a are the generators of G_{global} in the representation of the couplings. The second quotient by $G_{\text{global}}^{\mathbb{C}}$ in (1.1) identifies deformations that belong to the same orbit. The complex dimension of the moduli space is therefore equal to the difference

$$\dim_{\mathbb{C}} \mathcal{M}_{\text{SC}} = \#\{\mathcal{O}_i\} - \dim G_{\text{global}} . \quad (1.3)$$

In the dual gauged supergravity (when one exists) the fields dual to single-trace operators \mathcal{O}_i are $\mathcal{N} = 2$ hypermultiplets, and $D^a = 0$ are D-term conditions [14].

The global flavour symmetry of the $T_\rho^\hat{\rho}[SU(N)]$ theories, viewed as $\mathcal{N} = 2$ SCFTs, is a product

$$G_{\text{global}} = G \times \hat{G} \times U(1) , \quad (1.4)$$

where G and \hat{G} are the flavour groups of the electric and magnetic theories that are related by mirror symmetry, and $U(1)$ is the subgroup of the $SO(4)_R$ symmetry which commutes with the unbroken

¹One exception to this general rule is the gauging of a global symmetry with vanishing β function in four dimensions.

$\mathcal{N} = 2$. To calculate the local moduli space we must then list all marginal supersymmetric operators and the G_{global} -representation(s) in which they transform. Many of these deformations are standard superpotential deformations involving hypermultiplets of either the electric theory or its magnetic mirror. Some marginal operators involve, however, both kinds of hypermultiplets and do not admit a local Lagrangian description. We refer to such deformations as ‘mixed’. They are specific to three dimensions, and will be the focus of our paper.

Marginal $\mathcal{N} = 2$ deformations of $\mathcal{N} = 4$ theories belong to three kinds of superconformal multiplets [7]. The Higgs- and Coulomb-branch superpotentials belong, respectively, to $(2, 0)$ and $(0, 2)$ representations of $SO(3)_H \times SO(3)_C$, where $SO(3)_H \times SO(3)_C \simeq SO(4)_R$ is the $\mathcal{N} = 4$ R -symmetry.² The mixed marginal operators on the other hand transform in the $(J^H, J^C) = (1, 1)$ representation. In the holographic dual supergravity the $(2, 0)$ and $(0, 2)$ multiplets describe massive $\mathcal{N} = 4$ vector bosons, while the $(1, 1)$ multiplets contain also spin- $\frac{3}{2}$ fields. These latter are also special for another reason: they are Stueckelberg fields capable of rendering the $\mathcal{N} = 4$ graviton multiplet massive [15, 16]. In representation theory they are the unique short multiplets that can combine with the conserved energy-momentum tensor into a long multiplet. This monogamous relation will allow us to identify them unambiguously in the superconformal index.

More generally, one cannot distinguish in the superconformal index the contribution of the $\mathcal{N} = 2$ chiral ring, which contains scalar operators with arbitrary (J^H, J^C) , from contributions of other short multiplets. Two exceptions to this rule are the pure Higgs- and pure Coulomb-branch chiral rings whose R -symmetry quantum numbers are $(J^H, 0)$ and $(0, J^C)$. The corresponding multiplets are absolutely protected, i.e. they can never recombine to form long representations of the $\mathcal{N} = 4$ superconformal algebra [17]. These two subrings of the chiral ring can thus be unambiguously identified. Their generating functions (known as the Higgs-branch and Coulomb-branch Hilbert series [18, 19, 20, 21, 22]) are indeed simple limits of the superconformal index [23]. Arbitrary elements of the chiral ring, on the other hand, are out of reach of presently-available techniques.³ Fortunately this will not be an obstacle for the marginal $(1, 1)$ operators of interest here.

The result of our calculation has no surprises. As we will show, the mixed marginal operators transform in the $(\text{Adj}, \text{Adj}, 0)$ representation of the global symmetry (1.4), up to some overcounting when (and only when) the quivers of $T_\rho^{\hat{\rho}}[SU(N)]$ have abelian gauge nodes.⁴ More generally, the set of all marginal $\mathcal{N} = 2$ operators is of the form

$$S^2(\text{Adj } G + \text{Adj } \hat{G}) + [\text{length-4 strings}] - \text{redundant} , \quad (1.5)$$

where S^2 is the symmetrized square of representations, and the ‘length-4 string’ operators are quartic superpotentials made out of the hypermultiplets of the electric or the magnetic theory only. All redundancies arise due to symmetrization and electric or magnetic F -term conditions. Calculating them is the main technical result of our paper. On the way we will find also some new checks of $3d$ mirror symmetry.

Our calculation settles one issue about the dual AdS moduli that was left open in ref. [7]. As is standard in holography, the global symmetries G and \hat{G} of the CFT are realized as gauge symmetries on the gravity side. The corresponding $\mathcal{N} = 4$ vector bosons live on stacks of magnetized D5-branes and NS5-branes which wrap two different 2-spheres (S_H^2 and S_C^2) in the ten-dimensional spacetime [3]. The R -symmetry spins J^H and J^C are the angular momenta on these spheres. As was explained in [7], the Higgs-branch superconformal moduli correspond to open-string states on the D5-branes:

² $SO(3)_H$ and $SO(3)_C$ act on the chiral rings of the pure Higgs and pure Coulomb branches of the theory, whence their names. They are exchanged by mirror symmetry.

³Though there do exist some interesting suggestions [24, 25] on which we will comment at the end of this paper.

⁴However, mixed marginal operators of more general $3d$ $\mathcal{N} = 4$ theories may transform in a representation larger than $(\text{Adj}, \text{Adj}, 0)$. We give an example in subsection 5.1.

either non-excited single strings with $J^H = 2$, or bound states of two $J^H = 1$ strings. The Coulomb branch superconformal moduli correspond likewise to open D-string states on NS5-branes. For mixed moduli ref. [7] suggested two possibilities: either bound states of a $J^H = 1$ open string on the D5-branes with a $J^C = 1$ D-string from the NS5 branes, or single closed-string states that are scalar partners of massive gravitini. Our results rule out the second possibility for the backgrounds that are dual to linear quivers.⁵

It was also noted in ref. [7] that although gauged $\mathcal{N} = 4$ supergravity can in principle account for the $(2, 0)$ and $(0, 2)$ moduli that are scalar partners of spontaneously-broken gauge bosons, it has no massive spin- $\frac{3}{2}$ multiplets to account for single-particle $(1, 1)$ moduli. But if all $(1, 1)$ moduli are 2-particle states, they can be in principle accounted for by modifying the AdS_4 boundary conditions [26, 27]. The dismissal in ref. [7] of gauged supergravity, as not capturing the entire moduli space, was thus premature. We stress however that changing the boundary conditions does not affect the classical AdS solution but only the fluctuations around it. Put differently these moduli show up only upon quantization. The analysis of $\mathcal{N} = 2$ AdS_4 moduli spaces in gauged supergravity [14] must be revisited in order to incorporate such ‘quantization moduli.’

This paper is organized as follows: Section 2 reviews some generalities about good $T_\rho^\hat{\rho}[SU(N)]$ theories, and exhibits their superconformal index written as a multiple integral and sum over Coulomb-branch moduli and monopole fluxes. Our aim is to recast this expression into a sum of superconformal characters with fugacities restricted as pertaining to the index. These restricted characters and the linear relations that they obey are derived in section 3. We also explain in this section how the ambiguities inherent in the decomposition of the index as a sum over representations can be resolved for the problem at hand.

Section 4 contains our main calculation. We first expand the determinants so as to only keep contributions from operators with scaling dimension $\Delta \leq 2$, and then perform explicitly the integrals and sums. The result is re-expressed as a sum of characters of $OSp(4|4) \times G \times \hat{G}$ in section 5. We identify the superconformal moduli, comment on their holographic interpretation (noting the role of a stringy exclusion principle) and conclude. Some technical material is relegated to appendices. Appendix A sketches the derivation of the superconformal index as a localized path integral over the Coulomb branch. This is standard material included for the reader’s convenience. In appendix B we prove a combinatorial lemma needed in the main calculation. Lastly a closed-form expression for the index of $T[SU(2)]$, which is sQED₃ with two ‘selectrons’, is derived in appendix C. This renders manifest a general property (which we do not use in this paper), namely the factorization of the index in holomorphic blocks [28, 29, 30].

Note added: Shortly before ours, the paper [31] was posted to the arXiv. It checks mirror symmetry by comparing the index of mirror pairs, including many examples of coupled 4d-3d systems. The papers only overlap marginally.

2 Superconformal index of $T_\rho^\hat{\rho}[SU(N)]$

2.1 Generalities

We consider the 3d $\mathcal{N} = 4$ gauge theories [2] based on the linear quivers of Figure 1. Circle nodes in these quivers stand for unitary gauge groups $U(N_i)$, squares designate fundamental hypermultiplets and horizontal links stand for bifundamental hypermultiplets. One can generalize to theories with

⁵In the interacting theory single- and multi-string states with the same charges mix and cannot be distinguished. The above statement should be understood in the sense of cohomology: in linear-quiver theories all $(1, 1)$ elements of the $\Delta = 2$ chiral ring are accounted for by 2-string states.

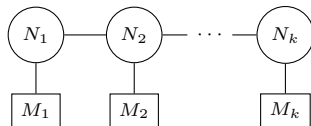

Figure 1: Linear quiver with gauge group $U(N_1) \times \cdots \times U(N_k)$.

orthogonal and symplectic gauge groups and to quivers with non-trivial topology, but we will not consider such complications here. We are interested in the infrared limit of ‘good theories’ [1] for which $N_{j-1} + N_{j+1} + M_j \geq 2N_j \forall j$. These conditions ensure that at a generic point of the Higgs branch the gauge symmetry is completely broken.

The theories are defined in the ultraviolet (UV) by the standard $\mathcal{N} = 4$ Yang-Mills plus matter 3d action. All masses and Fayet-Iliopoulos terms are set to zero and there are no Chern-Simons terms. We choose the vacuum at the origin of both the Coulomb and Higgs branches, where all scalar expectation values vanish. Thus the only continuous parameters are the dimensionful gauge couplings g_i , which flow to infinity in the infrared.

Every good linear quiver has a mirror which is also a good linear quiver and whose discrete data we denote by hats, $\{\hat{N}_j, \hat{M}_j, \hat{k}\}$. A useful parametrization of both quivers is in terms of an ordered pair of partitions, $(\rho, \hat{\rho})$ with $\rho^T > \hat{\rho}$, see appendix B. The SCFT has global (electric and magnetic) flavour symmetries

$$G \times \hat{G} = \left(\prod_j U(M_j) \right) / U(1) \times \left(\prod_j U(\hat{M}_j) \right) / U(1), \quad (2.1)$$

with $\text{rank } G = \hat{k}$ and $\text{rank } \hat{G} = k$. In the string-theory embedding the flavour symmetries are realized on $(\hat{k} + 1)$ D5-branes and $(k + 1)$ NS5-branes [2]. The symmetry G is manifest in the microscopic Lagrangian of the electric theory, as is the Cartan subalgebra of \hat{G} which is the topological symmetry whose conserved currents are the dual field strengths $\text{Tr} \star F_{(j)}$. The non-abelian extension of \hat{G} is realized in the infrared by monopole operators [32, 33].

In addition to $G \times \hat{G}$ the infrared fixed-point theory has global superconformal symmetry. The $\mathcal{N} = 4$ superconformal group in three dimensions is $OSp(4|4)$. It has eight real Poincaré supercharges transforming in the $(\frac{1}{2}, \frac{1}{2}, \frac{1}{2})$ representation of $SO(1, 2) \times SO(3)_H \times SO(3)_C$. The two-component 3d Lorentzian spinors can be chosen real. The marginal deformations studied in this paper leave unbroken an $\mathcal{N} = 2$ superconformal symmetry $OSp(2|4) \subset OSp(4|4)$. This is generated by two out of the four real $SO(1, 2)$ spinors, so modulo $SO(4)_R$ rotations the embedding is unique. Let $Q^{(\pm\pm)}$ be a complex basis for the four Poincaré supercharges, where the superscripts are the eigenvalues of the diagonal R-symmetry generators J_3^H and J_3^C . Without loss of generality we can choose the two unbroken supercharges to be the complex pair $Q^{(++)}$ and $Q^{(--)}$, so that the $\mathcal{N} = 2$ R-symmetry is generated by $J_3^H + J_3^C$ and the extra commuting $U(1)$ by $J_3^H - J_3^C$. We use this same basis in the definition of the superconformal index.

2.2 Integral expression for the index

There is a large literature on the $\mathcal{N} = 2$ superconformal index in three dimensions, for a partial list of references see [34, 35, 36, 37, 38, 39, 40]. The index is defined as a weighted sum over local operators of the SCFT, or equivalently over all quantum states on the two-sphere,

$$\mathcal{Z}_{S^2 \times S^1} = \text{Tr}_{\mathcal{H}_{S^2}} (-1)^F q^{\frac{1}{2}(\Delta + J_3)} t^{J_3^H - J_3^C} e^{-\beta(\Delta - J_3 - J_3^H - J_3^C)}. \quad (2.2)$$

In this formula F is the fermion number of the state, J_3 the third component of the spin, Δ the energy, and $q, t, e^{-\beta}$ are fugacities. Only states for which $\Delta = J_3 + J_3^H + J_3^C$ contribute to the index, which is therefore independent of the fugacity β .

The non-abelian R -symmetry guarantees (for good theories) that the $U(1)_R$ of the $\mathcal{N} = 2$ subalgebra is the same in the ultraviolet and the infrared. We can therefore compute $\mathcal{Z}_{S^2 \times S^1}$ in the UV where the 3d gauge theory is free. The index can be further refined by turning on fugacities for the flavour symmetries, and background fluxes on S^2 for the flavour groups [38]. In our calculation we will include flavour fugacities but set the flavour fluxes to zero.

The superconformal index eq. (2.2) is the appropriately twisted partition function of the theory on $S^2 \times S^1$. It can be computed by supersymmetric localization of the functional integral, for a review see ref. [40]. For each gauge-group factor $U(N_j)$ there is a sum over monopole charges $\{m_{j,\alpha}\} \in \mathbb{Z}^{N_j}$ and an integral over gauge fugacities (exponentials of gauge holonomies) $\{z_{j,\alpha}\} \in U(1)^{N_j}$. The calculation is standard and is summarized in appendix A. The result is most conveniently expressed with the help of the plethystic exponential (PE) symbol,

$$\begin{aligned} \mathcal{Z}_{S^2 \times S^1} = & \prod_{j=1}^k \left[\frac{1}{N_j!} \sum_{m_j \in \mathbb{Z}^{N_j}} \int \prod_{\alpha=1}^{N_j} \frac{dz_{j,\alpha}}{2\pi i z_{j,\alpha}} \right] \left\{ (q^{\frac{1}{2}} t^{-1})^{\Delta(\mathbf{m})} \prod_{j=1}^k \left[\prod_{\alpha=1}^{N_j} w_j^{m_{j,\alpha}} \prod_{\alpha \neq \beta}^{N_j} (1 - q^{\frac{1}{2}|m_{j,\alpha} - m_{j,\beta}|} z_{j,\beta} z_{j,\alpha}^{-1}) \right] \right. \\ & \times \text{PE} \left(\sum_{j=1}^k \sum_{\alpha,\beta=1}^{N_j} \frac{q^{\frac{1}{2}}(t^{-1} - t)}{1 - q} q^{|m_{j,\alpha} - m_{j,\beta}|} z_{j,\beta} z_{j,\alpha}^{-1} \right. \\ & + \frac{(q^{\frac{1}{2}} t)^{\frac{1}{2}} (1 - q^{\frac{1}{2}} t^{-1})}{1 - q} \sum_{j=1}^k \sum_{p=1}^{M_j} \sum_{\alpha=1}^{N_j} q^{\frac{1}{2}|m_{j,\alpha}|} \sum_{\pm} z_{j,\alpha}^{\mp 1} \mu_{j,p}^{\pm 1} \\ & \left. \left. + \frac{(q^{\frac{1}{2}} t)^{\frac{1}{2}} (1 - q^{\frac{1}{2}} t^{-1})}{1 - q} \sum_{j=1}^{k-1} \sum_{\alpha=1}^{N_j} \sum_{\beta=1}^{N_{j+1}} q^{\frac{1}{2}|m_{j,\alpha} - m_{j+1,\beta}|} \sum_{\pm} z_{j,\alpha}^{\mp 1} z_{j+1,\beta}^{\pm 1} \right) \right\}. \end{aligned} \quad (2.3)$$

Here $z_{j,\alpha}$ is the S^1 holonomy of the $U(N_j)$ gauge field and $m_{j,\alpha}$ its 2-sphere fluxes (*viz.* the monopole charges of the corresponding local operator in \mathbb{R}^3) with α labeling the Cartan generators; $\mu_{j,p}$ are flavour fugacities with $p = 1, \dots, M_j$, and w_j is a fugacity for the topological $U(1)$ whose conserved current is $\text{Tr} \star F_{(j)}$. The plethystic exponential of a function $f(v_1, v_2, \dots)$ is given by

$$\text{PE}(f) = \exp \left(\sum_{n=1}^{\infty} \frac{1}{n} f(v_1^n, v_2^n, \dots) \right). \quad (2.4)$$

Finally \mathbf{m} denotes collectively all magnetic charges, and the crucial exponent $\Delta(\mathbf{m})$ reads

$$\Delta(\mathbf{m}) = -\frac{1}{2} \sum_{j=1}^k \sum_{\alpha,\beta=1}^{N_j} |m_{j,\alpha} - m_{j,\beta}| + \frac{1}{2} \sum_{j=1}^k M_j \sum_{\alpha=1}^{N_j} |m_{j,\alpha}| + \frac{1}{2} \sum_{j=1}^{k-1} \sum_{\alpha=1}^{N_j} \sum_{\beta=1}^{N_{j+1}} |m_{j,\alpha} - m_{j+1,\beta}|. \quad (2.5)$$

Note that the smallest power of q in any given monopole sector is $\frac{1}{2} \Delta(\mathbf{m})$. Since the contribution of any state to the index is proportional to $q^{\frac{1}{2}(\Delta + J_3)}$, we see that $\Delta(\mathbf{m})$ is the Casimir energy of the ground state in the sector \mathbf{m} , or equivalently the scaling dimension [and the $SO(3)_C$ spin] of the corresponding monopole operator [32, 33]. As shown by Gaiotto and Witten [1] this dimension is strictly positive (for $\mathbf{m} \neq 0$) for all the good theories that interest us here.

We would now like to extract from the index (2.3) the number, flavour representations and $U(1)$ charges of all marginal $\mathcal{N} = 2$ operators. To this end we need to rewrite the index as a sum over

characters of the global $OSp(4|4) \times G \times \hat{G}$ symmetry,

$$\mathcal{Z}_{S^2 \times S^1} = \sum_{(\mathfrak{R}, \mathbf{r}, \hat{\mathbf{r}})} \mathcal{I}_{\mathfrak{R}}(q, t) \chi_{\mathbf{r}}(\mu) \chi_{\hat{\mathbf{r}}}(\hat{\mu}) \quad (2.6)$$

where the sum runs over all triplets of representations $(\mathfrak{R}, \mathbf{r}, \hat{\mathbf{r}})$, $\chi_{\mathbf{r}}$ and $\chi_{\hat{\mathbf{r}}}$ are characters of G and \hat{G} , and $\mathcal{I}_{\mathfrak{R}}$ are characters of $OSp(4|4)$ with fugacities restricted as pertaining for the index. To proceed we must now make a detour to review the unitary representations of the $\mathcal{N} = 4$ superconformal algebra in three dimensions.

3 Characters of $OSp(4|4)$ and Hilbert series

3.1 Representations and recombination rules

All unitary highest-weight representations of $OSp(4|4)$ have been classified in refs. [41, 17]. As shown in these references, in addition to the generic long representations there exist three series of short or BPS representations:

$$A_1[j]_{1+j+j^H+j^C}^{(j^H, j^C)} \quad (j > 0), \quad A_2[0]_{1+j^H+j^C}^{(j^H, j^C)}, \quad \text{and} \quad B_1[0]_{j^H+j^C}^{(j^H, j^C)}. \quad (3.1)$$

We follow the notation of [17] where $[j]_{\delta}^{(j^H, j^C)}$ denotes a superconformal primary with energy δ , and $SO(1, 2) \times SO(3)_H \times SO(3)_C$ spin quantum numbers j, j^H, j^C .⁶ We use lower-case symbols for the quantum numbers of the superconformal primaries in order to distinguish them from those of arbitrary states in the representation. The subscripts labelling A and B indicate the level of the first null states in the representation.

The A -type representations lie at the unitarity threshold ($\delta_A = 1 + j + j^H + j^C$) while those of B -type are separated from this threshold by a gap, $\delta_B = \delta_A - 1$. Since for short representations the primary dimension δ is fixed by the spins and the representation type, we will from now on drop it in order to make the notation lighter.

The general character of $OSp(4|4)$ is a function of four fugacities, corresponding to the eigenvalues of the four commuting bosonic generators J_3, J_3^H, J_3^C and Δ . For the index one fixes the fugacity of J_3 and then a second fugacity automatically drops out. More explicitly

$$\begin{aligned} \mathcal{I}_{\mathfrak{R}}(q, t) &= \chi_{\mathfrak{R}}(e^{i\pi}, q, t, e^{\beta}) \\ \text{where } \chi_{\mathfrak{R}}(w, q, t, e^{\beta}) &= \text{Tr}_{\mathfrak{R}} w^{2J_3} q^{\frac{1}{2}(\Delta+J_3)} t^{J_3^H - J_3^C} e^{-\beta(\Delta - J_3 - J_3^H - J_3^C)}. \end{aligned} \quad (3.2)$$

Although general characters are linearly-independent functions, this is not the case for indices. The index of long representations vanishes, and the indices of short representations that can recombine into a long one sum up to zero. This is why, as is well known, $\mathcal{Z}_{S^2 \times S^1}$ does not determine (even) the BPS spectrum of the theory unambiguously. Fortunately, we can avoid this difficulty for our purposes here, as we will now explain.

In any 3d $\mathcal{N} = 4$ SCFT the ambiguity in extracting the BPS spectrum from the index can be summarized by the following recombination rules [17]

$$L[0]^{(j^H, j^C)} \rightarrow A_2[0]^{(j^H, j^C)} \oplus B_1[0]^{(j^H+1, j^C+1)}, \quad (3.3a)$$

$$L[\frac{1}{2}]^{(j^H, j^C)} \rightarrow A_1[\frac{1}{2}]^{(j^H, j^C)} \oplus A_2[0]^{(j^H+\frac{1}{2}, j^C+\frac{1}{2})}, \quad (3.3b)$$

$$L[j \geq 1]^{(j^H, j^C)} \rightarrow A_1[j]^{(j^H, j^C)} \oplus A_1[j - \frac{1}{2}]^{(j^H+\frac{1}{2}, j^C+\frac{1}{2})}. \quad (3.3c)$$

⁶Factor of 2 differences from [17] are because we use spins rather than Dynkin labels.

The long representations on the left-hand side are taken at the unitarity threshold $\delta \rightarrow \delta_A$. From these recombination rules one sees that the characters of the B -type multiplets form a basis for contributions to the index. Simple induction indeed gives

$$(-)^{2j} \mathcal{I}_{A_1[j](j^H, j^C)} = \mathcal{I}_{A_2[0](j^H+j, j^C+j)} = -\mathcal{I}_{B_1[0](j^H+j+1, j^C+j+1)} . \quad (3.4)$$

We need therefore to compute the index only for B -type multiplets. The decomposition of these latter into highest-weight representations of the bosonic subgroup $SO(2, 3) \times SO(4)$ can be found in ref. [17]. Using the known characters of $SO(2, 3)$ and $SO(4)$ and taking carefully the limit $w \rightarrow e^{i\pi}$ leads to the following indices

$$\mathcal{I}_{B_1[0](0,0)} = 1 , \quad (3.5a)$$

$$\mathcal{I}_{B_1[0](j^H > 0, 0)} = (q^{\frac{1}{2}}t)^{j^H} \frac{(1 - q^{\frac{1}{2}}t^{-1})}{(1 - q)} , \quad (3.5b)$$

$$\mathcal{I}_{B_1[0](0, j^C > 0)} = (q^{\frac{1}{2}}t^{-1})^{j^C} \frac{(1 - q^{\frac{1}{2}}t)}{(1 - q)} , \quad (3.5c)$$

$$\mathcal{I}_{B_1[0](j^H > 0, j^C > 0)} = q^{\frac{1}{2}(j^H+j^C)} t^{j^H-j^C} \frac{(1 - q^{\frac{1}{2}}(t + t^{-1}) + q)}{(1 - q)} . \quad (3.5d)$$

Note that all superconformal primaries of type B are scalar fields with $\delta = j^H + j^C$, so one of them saturates the BPS bound $\delta = j_3 + j_3^H + j_3^C$ and contributes the leading power $q^{\frac{1}{2}(j^H+j^C)}$ to the index. Things work differently for type- A multiplets whose primary states have $\delta = 1 + j + j^H + j^C > j_3 + j_3^H + j_3^C$, so they cannot contribute to the index. Their descendants can however saturate the BPS bound and contribute, because even though a Poincaré supercharge raises the dimension by $\frac{1}{2}$, it can at the same time increase $J_3 + J_3^H + J_3^C$ by as much as $\frac{3}{2}$.

3.2 Protected multiplets and Hilbert series

General contributions to the index can be attributed either to a B -type or to an A -type multiplet. There exists, however, a special class of *absolutely protected* B -type representations which do not appear in the decomposition of any long multiplet. Their contribution to the index can therefore be extracted unambiguously. Inspection of (3.3) gives the following list of multiplets that are

$$\underline{\text{absolutely protected}} : \quad B_1[0]^{(j^H, j^C)} \quad \text{with} \quad j^H \leq \frac{1}{2} \quad \text{or} \quad j^C \leq \frac{1}{2} . \quad (3.6)$$

Consider in particular the $B_1[0]^{(j^H, 0)}$ series.⁷ The highest-weights of these multiplets are chiral $\mathcal{N} = 2$ scalar fields that do not transform under $SO(3)_C$ rotations. This is precisely the Higgs-branch chiral ring consisting of operators made out of $\mathcal{N} = 4$ hypermultiplets of the electric quiver. It is defined entirely by the classical F -term conditions. Likewise the highest-weights of the $B_1[0]^{(0, j^C)}$ series, which are singlets of $SO(3)_H$, form the chiral ring of the Coulomb branch whose building blocks are magnetic hypermultiplets. Redefine the fugacities as follows

$$x_{\pm} = q^{\frac{1}{4}} t^{\pm \frac{1}{2}} . \quad (3.7)$$

⁷The representations $B_1[0]^{(j^H, \frac{1}{2})}$ and $B_1[0]^{(\frac{1}{2}, j^C)}$ only appear in theories with free (magnetic or electric) hypermultiplets and play no role in good theories.

It follows then immediately from (3.5) that in the limit $x_- = 0$ the index only receives contributions from the Higgs-branch chiral ring, while in the limit $x_+ = 0$ it only receives contributions from the chiral ring of the Coulomb branch.

The generating functions of these chiral rings, graded according to their dimension and quantum numbers under global symmetries, are known as Hilbert series (HS). In the context of 3d $\mathcal{N} = 4$ theories elegant general formulae for the Higgs-branch and Coulomb-branch Hilbert series were derived in refs. [18, 19, 20, 21], see also [22] for a review. It follows from our discussion that

$$\mathcal{Z}_{S^2 \times S^1} \Big|_{x_- = 0} = \text{HS}^{\text{Higgs}}(x_+) \quad \text{and} \quad \mathcal{Z}_{S^2 \times S^1} \Big|_{x_+ = 0} = \text{HS}^{\text{Coulomb}}(x_-). \quad (3.8)$$

These relations between the superconformal index and the Hilbert series were established in ref. [23] by matching the corresponding integral expressions. Here we derive them directly from the $\mathcal{N} = 4$ superconformal characters.

What about other operators of the chiral ring? The complete $\mathcal{N} = 2$ chiral ring consists of the highest weights in all $B_1[0]^{(j^H, j^C)}$ multiplets of the theory.⁸ As seen however from eq. (3.4) the mixed-branch operators (those with both j^H and $j^C \geq 1$) cannot be extracted unambiguously from the index. This shows that there is no simple relation between the Hilbert series of the full chiral ring and the superconformal index. The Hilbert series is better adapted for studying supersymmetric deformations of a SCFT, but we lack a general method to compute it (see however [24, 25] for interesting ideas in this direction). Fortunately these complications will not be important for the problem at hand.

The reason is that marginal deformations exist only in the restricted set of multiplets:

$$\underline{\text{marginal}} : \quad B_1[0]^{(j^H, j^C)} \quad \text{with} \quad j^H + j^C = 2. \quad (3.9)$$

These are in the absolutely protected list (3.6) with the exception of $B_1[0]^{(1,1)}$, a very interesting multiplet that contains also four spin-3/2 fields in its spectrum. This multiplet is not absolutely protected, but it is part of a ‘monogamous relation’: its unique recombination partner is $A_2[0]^{(0,0)}$ and vice versa. Furthermore $A_2[0]^{(0,0)}$ is the $\mathcal{N} = 4$ multiplet of the conserved energy-momentum tensor [17],⁹ which is unique in any irreducible SCFT. As a result the contribution of $B_1[0]^{(1,1)}$ multiplets can be also unambiguously extracted from the index.

A similar though weaker form of the argument actually applies to all $\mathcal{N} = 2$ SCFT. Marginal chiral operators belong to short $OSp(2|4)$ multiplets whose only recombination partners are the conserved $\mathcal{N} = 2$ vector-currents. We already alluded to this fact when explaining why the 3d $\mathcal{N} = 2$ superconformal manifold has the structure of a moment-map quotient [13]. If the global symmetries of the SCFT are known (they are not always manifest), one can extract unambiguously its marginal deformations from the index (see e.g., [43, 44] for applications).

4 Calculation of the index

We turn now to the main calculation of this paper, namely the expansion of the expression (2.2) in terms of characters of the global symmetry $OSp(4|4) \times G \times \hat{G}$. Since we are only interested in the

⁸The A -type multiplets do not contribute to the chiral ring, since none has scalar states that saturate the BPS bound (i.e. $\Delta = J_3^H + J_3^C$ and $J = 0$).

⁹In the dual gravity theory, this recombination makes the $\mathcal{N} = 4$ supergraviton massive. Thus $B_1[0]^{(1,1)}$ is a Stueckelberg multiplet for the ‘Higgsing’ of $\mathcal{N} = 4$ AdS supergravity [15, 16]. We also note in passing ref. [42] where the monogamous relation is used in order to extract the number of conserved energy-momentum tensors from the superconformal index of $d = 4$ class-S theories.

marginal multiplets (3.9) whose contribution starts at order q , it will be sufficient to expand the index to this order. In terms of the fugacities x_{\pm} we must keep terms up to order x^4 . As we have just seen, each of the terms in the expansion to this order can be unambiguously attributed to an $OSp(4|4)$ representation.

We will organize the calculation in terms of the magnetic Casimir energy eq. (2.5). We start with the zero-monopole sector, and then proceed to positive values of $\Delta(\mathbf{m})$.

4.1 The zero-monopole sector

In the $\mathbf{m} = 0$ sector all magnetic fluxes vanish and the gauge symmetry is unbroken. The expression in front of the plethystic exponential in (2.2) reduces to

$$\prod_{j=1}^k \left[\frac{1}{N_j!} \int \prod_{\alpha=1}^{N_j} \frac{dz_{j,\alpha}}{2\pi i z_{j,\alpha}} \prod_{\alpha \neq \beta}^{N_j} (1 - z_{j,\beta} z_{j,\alpha}^{-1}) \right]. \quad (4.1)$$

This can be recognized as the invariant Haar measure for the gauge group $\prod_{j=1}^k U(N_j)$. The measure is normalized so that for any irreducible representation R of $U(N)$

$$\frac{1}{N!} \int \prod_{\alpha=1}^N \frac{dz_{\alpha}}{2\pi i z_{\alpha}} \prod_{\alpha \neq \beta}^N (1 - z_{\beta} z_{\alpha}^{-1}) \chi_R(z) = \delta_{R,0}. \quad (4.2)$$

Thus the integral projects to gauge-invariant states, as expected. We denote this operation on any combination, X , of characters as $X|_{\text{singlet}}$.

Since we work to order $O(q)$ we may drop the denominators $(1 - q)$ in the plethystic exponential. The contribution of the $\mathbf{m} = 0$ sector to the index can then be written as

$$\mathcal{Z}_{S^2 \times S^1}^{\mathbf{m}=0} = \text{PE} \left(x_+(1 - x_-^2)X + (x_-^2 - x_+^2)Y \right) \Big|_{\text{singlet}} + O(x^5) \quad (4.3)$$

with

$$X = \sum_{j=1}^k (\square_j \bar{\square}_j^{\mu} + \bar{\square}_j \square_j^{\mu}) + \sum_{j=1}^{k-1} (\square_j \bar{\square}_{j+1} + \bar{\square}_j \square_{j+1}) \quad \text{and} \quad Y = \sum_{j=1}^k \bar{\square}_j \square_j. \quad (4.4)$$

The notation here is as follows: \square_j denotes the character of the fundamental representation of the j th unitary group, and $\bar{\square}_j$ that of the anti-fundamental. To distinguish gauge from global (electric) flavour groups we specify the latter with the symbol of the corresponding fugacities μ , while for the gauge group the dependence on the fugacities z is implicit. The entire plethystic exponent can be considered as a character of $\mathcal{G} \times G \times U(1) \times \mathbb{R}^+$, where \mathcal{G} is the gauge group and $U(1) \times \mathbb{R}^+ \subset OSp(4|4)$ are the superconformal symmetries generated by $J_3^H - J_3^C$ and by $\Delta + J_3$. The ‘‘singlet’’ operation projects on singlets of the gauge group only.

The plethystic exponential is a sum of powers $\mathbb{S}^k \chi$ of characters, where \mathbb{S}^k is a multiparticle symmetrizer that takes into account fermion statistics. For instance

$$\mathbb{S}^2(a + b - c - d) = \mathbb{S}^2 a + ab + \mathbb{S}^2 b - (a + b)(c + d) + \Lambda^2 c + cd + \Lambda^2 d \quad (4.5)$$

where \mathbb{S}^k and Λ^k denote standard symmetrization or antisymmetrization. Call Ω the exponent in eq. (4.3). To the quartic order that we care about we compute

$$\begin{aligned} \mathbb{S}^2 \Omega &= x_+^2 \mathbb{S}^2 X + x_+(x_-^2 - x_+^2)XY + x_+^4 \mathbb{S}^2 Y + x_+^4 \Lambda^2 Y - x_+^2 x_-^2 (X^2 + Y^2) + O(x^5), \\ \mathbb{S}^3 \Omega &= x_+^3 \mathbb{S}^3 X + x_+^2 (x_-^2 - x_+^2)Y \mathbb{S}^2 X + O(x^5), \\ \mathbb{S}^4 \Omega &= x_+^4 \mathbb{S}^4 X + O(x^5). \end{aligned} \quad (4.6)$$

Upon projection on the gauge-invariant sector one finds

$$X|_{\text{singlet}} = XY|_{\text{singlet}} = 0 \quad \text{and} \quad Y|_{\text{singlet}} = k. \quad (4.7)$$

Second powers of Y also give (μ -independent) pure numbers,

$$Y^2|_{\text{singlet}} = S^2Y|_{\text{singlet}} + \Lambda^2Y|_{\text{singlet}}$$

with

$$S^2Y|_{\text{singlet}} = \frac{1}{2}k(k+1) + \sum_{j=1}^k \delta_{N_j \neq 1}, \quad \Lambda^2Y|_{\text{singlet}} = \frac{1}{2}k(k-1). \quad (4.8)$$

The remaining terms in the expansion require a little more work with the result

$$\begin{aligned} X^2|_{\text{singlet}} &= 2S^2X|_{\text{singlet}} = 2\left(k-1 + \sum_{j=1}^k \bar{\square}_j^\mu \square_j^\mu\right), \\ S^3X|_{\text{singlet}} &= \sum_{j=1}^{k-1} (\square_j^\mu \bar{\square}_{j+1}^\mu + \bar{\square}_j^\mu \square_{j+1}^\mu), \\ YS^2X|_{\text{singlet}} &= k^2 + k - 2 + \delta_{N_1=1} + \delta_{N_k=1} + \sum_{j=1}^k \left[(k + \delta_{N_j \neq 1}) \bar{\square}_j^\mu \square_j^\mu - 2\delta_{N_j=1} \right], \end{aligned} \quad (4.9)$$

and finally (and most tediously)

$$\begin{aligned} S^4X|_{\text{singlet}} &= \sum_{j=2}^{k-1} \delta_{N_j \neq 1} + \sum_{j=1}^{k-1} \delta_{N_j \neq 1} \delta_{N_{j+1} \neq 1} + \frac{(k-1)k}{2} + \sum_{j=1}^{k-2} (\square_j^\mu \bar{\square}_{j+2}^\mu + \bar{\square}_j^\mu \square_{j+2}^\mu) \\ &\quad + \sum_{j=1}^k \delta_{N_j \neq 1} (2 - \delta_{j=1} - \delta_{j=k}) |\square_j^\mu|^2 + (k-1) \sum_{j=1}^k |\square_j^\mu|^2 \\ &\quad + \sum_{j < j'}^k |\square_j^\mu|^2 |\square_{j'}^\mu|^2 + \sum_{j=1}^k |\square \square_j^\mu|^2 + \sum_{j=1}^k \delta_{N_j \neq 1} |\square \square_j^\mu|^2 \end{aligned} \quad (4.10)$$

where in the last equation we used the shorthand $|R|^2$ for the character of $R \otimes \bar{R}$, and denoted the (anti)symmetric representations of $U(M_j)$ by Young diagrams.

Let us explain how to compute the singlets in YS^2X . One obtains gauge-invariant contributions to that term in three different ways: the product of a gauge-invariant from Y and one from S^2X , or the product of an $SU(N_j)$ adjoint in Y with either a fundamental and an antifundamental, or a pair of bifundamentals, coming from S^2X . This gives three terms:

$$YS^2X|_{\text{singlet}} = k \left(k-1 + \sum_{j=1}^k |\square_j^\mu|^2 \right) + \left(\sum_{j=1}^k \delta_{N_j \neq 1} |\square_j^\mu|^2 \right) + \left(-\delta_{N_1 \neq 1} - \delta_{N_k \neq 1} + \sum_{j=1}^k 2\delta_{N_j \neq 1} \right) \quad (4.11)$$

where we used that the $SU(N_j)$ adjoint is absent when $N_j = 1$, and that the outermost nodes have a single bifundamental hypermultiplet rather than two. After a small rearrangement, this is the same as the last line of (4.9).

For $S^4 X|_{\text{singlet}}$ we organized terms according to how many bifundamentals they involve. First, four bifundamentals can be connected in self-explanatory notation as \diamond or \bowtie or $S^2(\diamond)$. Next, two bifundamentals and two fundamentals of different gauge groups can be connected as \lrcorner , while for the same group they can be either connected as \lrcorner or \ulcorner , or disconnected as a pair of bifundamentals \diamond and a flavour current \wedge (see below). When the node is abelian the first two terms are already included in the third and should not be counted separately. Finally, four fundamental hypermultiplets can form two pairs at different nodes, or if they come from the same node they should be split in two conjugate pairs, $Q_{j,\alpha}^p Q_{j,\beta}^r$ and $\tilde{Q}_{j,\alpha}^{\bar{p}} \tilde{Q}_{j,\beta}^{\bar{r}}$, with each pair separately symmetrized or antisymmetrized. When the gauge group is abelian the antisymmetric piece is absent.

4.2 Higgs-branch chiral ring

As a check, let us use the above results to calculate the Hilbert series of the Higgs branch. We have explained in subsection 3.2 that this is equal to the index evaluated at $x_- = 0$. Non-trivial monopole sectors make a contribution proportional to $x_-^{2\Delta(\mathbf{m})}$ and since $\Delta(\mathbf{m}) > 0$ they can be neglected. The Higgs-branch Hilbert series therefore reads

$$\text{HS}^{\text{Higgs}}(x_+) = \mathcal{Z}_{S^2 \times S^1}^{\mathbf{m}=0} \Big|_{x_-=0} . \quad (4.12)$$

Setting $x_- = 0$ in eqs. (4.3) and (4.6) we find

$$\begin{aligned} \text{HS}^{\text{Higgs}}(x_+) &= 1 + x_+^2 (S^2 X - Y) \Big|_{\text{singlet}} + x_+^3 S^3 X \Big|_{\text{singlet}} \\ &+ x_+^4 (S^4 X + \Lambda^2 Y - Y S^2 X) \Big|_{\text{singlet}} + O(x_+^5) . \end{aligned} \quad (4.13)$$

Inserting now (4.7)-(4.10) gives, after some straightforward algebra in which we distinguish $k = 1$ from $k > 1$ because simplifications are somewhat different,

$$\begin{aligned} \text{HS}^{\text{Higgs}}(x_+) &\stackrel{k=1}{=} 1 + x_+^2 \underbrace{\left(|\square_1^\mu|^2 - 1 \right)}_{\text{Adj } G} + x_+^4 \underbrace{\left(|\square_1^\mu|^2 + \delta_{N_1 \neq 1} |\square_1^\mu|^2 - (1 + \delta_{N_1 \neq 1}) |\square_1^\mu|^2 \right)}_{\text{double-string operators}} + O(x_+^5) , \\ \text{HS}^{\text{Higgs}}(x_+) &\stackrel{k \geq 1}{=} 1 + x_+^2 \underbrace{\left(\sum_{j=1}^k |\square_j^\mu|^2 - 1 \right)}_{\text{Adj } G} + x_+^3 \underbrace{\sum_{j=1}^{k-1} \left(\square_j^\mu \bar{\square}_{j+1}^\mu + \bar{\square}_j^\mu \square_{j+1}^\mu \right)}_{\text{length=3 strings}} \\ &+ x_+^4 \underbrace{\left(\sum_{j < j'}^k |\square_j^\mu|^2 |\square_{j'}^\mu|^2 + \sum_{j=1}^k \left(|\square_j^\mu|^2 + \delta_{N_j \neq 1} |\square_j^\mu|^2 - |\square_j^\mu|^2 \right) \right)}_{\text{double-string operators}} \\ &+ \underbrace{\sum_{j=2}^{k-1} \left(\square_{j-1}^\mu \bar{\square}_{j+1}^\mu + \bar{\square}_{j-1}^\mu \square_{j+1}^\mu + \delta_{N_j \neq 1} |\square_j^\mu|^2 \right) - \Delta n_{\text{H}}}_{\text{length=4 strings}} + O(x_+^5) . \end{aligned} \quad (4.14)$$

where Δn_{H} in the last line is a pure number given by

$$\Delta n_{\text{H}} = 1 + \sum_{j=2}^{k-1} \delta_{N_j=1} - \sum_{j=1}^{k-1} \delta_{N_j=1} \delta_{N_{j+1}=1} . \quad (4.15)$$

This result agrees with expectations. Recall that the Higgs branch is classical and its Hilbert series counts chiral operators made out of the scalar fields, Q_j^p and $\tilde{Q}_j^{\bar{p}}$, of the (anti)fundamental

hypermultiplets, and the scalars of the bifundamental hypermultiplets $Q_{j,j+1}$ and $\tilde{Q}_{j+1,j}$ (the gauge indices are here suppressed). Gauge-invariant products of these scalar fields can be drawn as strings on the quiver diagram [7], and they obey the following F -term matrix relations derived from the $\mathcal{N} = 4$ superpotential,

$$Q_{j,j+1}\tilde{Q}_{j+1,j} + \tilde{Q}_{j,j-1}Q_{j-1,j} + \sum_{p,\bar{p}=1}^{M_j} Q_j^p \tilde{Q}_j^{\bar{p}} \delta_{p\bar{p}} = 0 \quad \forall j = 1, \dots, k. \quad (4.16)$$

The length of each string gives the $SO(3)_H$ spin and scaling dimension of the operator, and hence the power of x_+ in the index. Since good theories have no free hypermultiplets there are no contributions at order x_+ . At order x_+^2 one finds the scalar partners of the conserved flavour currents that transform in the adjoint representation of G . Higher powers come either from single longer strings or, starting at order x_+^4 , from multistring ‘bound states’. One indeed recognizes the second line in (4.14) as the symmetrized product of strings of length two,

$$S^2 \chi_{\text{Adj } G} = S^2 \left(\sum_{j=1}^k |\square_j^\mu|^2 - 1 \right), \quad (4.17)$$

modulo the fact that for abelian gauge nodes some of the states are absent. These and the additional single-string operators of length 3 and 4 can be enumerated by diagrammatic rules, we refer the reader to [7] for details.

Note that single- and double-string operators with the same flavour quantum numbers may mix. The convention adopted in eq. (4.14) is to count such operators as double strings. In particular, length 4 single-string operators transforming in the adjoint of the flavour symmetry group (at a non-abelian node) are related by the F -term constraint (4.16) to products of currents, which explains the coefficient 1 of $|\square_j^\mu|^2$ in contrast with its coefficient 2 in $S^4 X|_{\text{singlet}}$ eq. (4.10). In the special case $k = 1$, all length 4 strings are products of currents and some vanish by the F -term constraint (4.16). Note also that the correction term Δn_H is the number of disjoint parts of the quiver when all abelian nodes are deleted. For each such part (consecutive non-abelian nodes) one neutral length-4 operator turns out to be redundant by the F -term conditions.¹⁰

The quartic term of the Hilbert series counts marginal Higgs-branch operators. When the electric flavour-symmetry group G is large, the vast majority of these are double-string operators. Their number far exceeds the number ($\dim G$) of moment-map constraints, eq. (1.2), so generic $T_\rho^{\hat{\rho}}$ theories have a large number of double-string $\mathcal{N} = 2$ moduli.

4.3 Contribution of monopoles

Going back to the full superconformal index, we separate it in three parts as follows

$$\mathcal{Z}_{S^2 \times S^1} = -1 + \text{HS}^{\text{Higgs}}(x_+, \mu) + \text{HS}^{\text{Coulomb}}(x_-, \hat{\mu}) + \mathcal{Z}^{\text{mixed}}(x_+, x_-, \mu, \hat{\mu}) \quad (4.18)$$

¹⁰Let j_1, \dots, j_2 be the non-abelian nodes in such a part, and focus on the case where the nodes $j_1 - 1$ and $j_2 + 1$ are abelian (the discussion is essentially identical if instead we have the edge of the quiver). Because of the abelian node, the closed length 4 string \bowtie passing through nodes $j_1 - 1$ and j_1 factorizes as a product of currents. On the other hand the F -term constraint (4.16) at j_1 expresses $Q_{j_1, j_1-1} Q_{j_1-1, j_1}$ as a sum of two terms and squaring it relates the string under consideration to a sum of three terms: a string of the same shape \bowtie passing through j_1 and $j_1 + 1$, a string of shape $\sqrt{\quad}$ passing through these two nodes and the flavour node M_{j_1} , and a string \bowtie visiting the gauge and flavour nodes j_1 . The third is a product of currents. The first can be rewritten using the F -term condition of node $j_1 + 1$. Continuing likewise until reaching a string of the same shape \bowtie passing through j_2 and $j_2 + 1$, one finally obtains the sought-after relation between many neutral length 4 operators and products of conserved currents.

where the remainder $\mathcal{Z}^{\text{mixed}}$ vanishes if either $x_- = 0$ or $x_+ = 0$. The Higgs-branch Hilbert series only depends on the electric-flavour fugacities $\mu_{j,p}$, and the Hilbert series of the Coulomb branch only depends on the magnetic-flavour fugacities w_j . To render the notation mirror-symmetric these latter should be redefined as follows

$$w_j = \hat{\mu}_j \hat{\mu}_{j+1}^{-1}. \quad (4.19)$$

Note that since the index (2.3) only depends on ratios of the $\hat{\mu}_j$, the last fugacity $\hat{\mu}_{k+1}$ is arbitrary and can be fixed at will. This reflects the fact that a phase rotation of all fundamental magnetic quarks is a gauge rather than global symmetry.

Mirror symmetry predicts that $\text{HS}^{\text{Coulomb}}$ is given by the same expression (4.14) with x_+ replaced by x_- and all other quantities replaced by their hatted mirrors. We will assume that this is indeed the case¹¹ and focus on the mixed piece $\mathcal{Z}^{\text{mixed}}$.

As opposed to the two Hilbert series, which only receive contributions from B -type primaries, $\mathcal{Z}^{\text{mixed}}$ has contributions from both A -type and B -type multiplets, and from both superconformal primaries and descendants. Let us first collect for later reference the terms of the $\mathbf{m} = 0$ sector that were not included in the Higgs-branch Hilbert series. From the results in subsection 4.1 one finds

$$\begin{aligned} \mathcal{Z}_{S^2 \times S^1}^{\mathbf{m}=0} - HS^{\text{Higgs}} &= \left[x_-^2 Y + x_-^4 S^2 Y + x_+^2 x_-^2 (YS^2 X - X^2 - Y^2) \right]_{\text{singlet}} \\ &= x_-^2 k + x_-^4 \left(\frac{1}{2} k(k+1) + \sum_{j=1}^k \delta_{N_j \neq 1} \right) \\ &+ x_+^2 x_-^2 \left(\sum_{j=1}^k (k-1 - \delta_{N_j=1}) |\square_j^\mu|^2 - 2k - \sum_{j=1}^k \delta_{N_j=1} + \delta_{N_1=1} + \delta_{N_k=1} \right) + O(x^5). \end{aligned} \quad (4.20)$$

The two terms in the second line contribute to the Coulomb-branch Hilbert series, while the third line is a contribution to the mixed piece.

We turn next to non-trivial monopole sectors whose contributions are proportional to $x_-^{2\Delta(\mathbf{m})}$. At the order of interest we can restrict ourselves to sectors with $0 < \Delta(\mathbf{m}) \leq 2$. Finding which monopole charges contribute to a generic value of $\Delta(\mathbf{m})$ is a hard combinatorial problem. For the lowest values $\Delta(\mathbf{m}) = \frac{1}{2}, 1$ and for good theories it was solved in ref. [1].

Fortunately this will be sufficient for our purposes here since, to the order of interest, the sectors $\Delta(\mathbf{m}) = 2$ and $\Delta(\mathbf{m}) = \frac{3}{2}$ only contribute to the Coulomb-branch Hilbert series, not to the mixed piece. This is obvious for $\Delta(\mathbf{m}) = 2$, while for $\Delta(\mathbf{m}) = \frac{3}{2}$ subleading terms in (2.3) with a single additional power of $q^{1/4}$ have unmatched gauge fugacities $z_{j,\alpha}$, and vanish after projection to the invariant sector (see below). In addition, good theories have no monopole operators with $\Delta(\mathbf{m}) = \frac{1}{2}$. Such operators would have been free twisted hypermultiplets, and there are none in the spectrum of good theories. This leaves us with $\Delta(\mathbf{m}) = 1$.

The key concept for describing monopole charges is that of *balanced* quiver nodes, defined as the nodes that saturate the ‘good’ inequality $N_{j-1} + N_{j+1} + M_j \geq 2N_j$. Let \mathcal{B}_ξ denote the sets of consecutive balanced nodes, i.e. the disconnected parts of the quiver diagram after non-balanced nodes have been deleted. As shown in [1] each such set corresponds to a non-abelian flavor group $SU(|\mathcal{B}_\xi| + 1)$ in the mirror magnetic quiver.¹² Monopole charges in the sector $\Delta(\mathbf{m}) = 1$ are

¹¹It is straightforward to verify the assertion at the quartic order computed here. Mirror symmetry of the complete index can be proved by induction (I. Lavdas and B. Le Floch, work in progress).

¹²As a result ξ ranges over the different components of the magnetic flavour group, i.e. the subset of gauge nodes ($j = 1, \dots, \hat{k}$) in the mirror quiver of the magnetic theory for which $\hat{M}_j > 1$.

necessarily of the following form: all $m_{j,\alpha}$ vanish except

$$m_{j_1,\alpha_1} = m_{j_1+1,\alpha_2} = \cdots = m_{j_1+\ell,\alpha_\ell} = \pm 1 \quad \text{with} \quad [j_1, j_1 + \ell] \subseteq \mathcal{B}_\xi \quad (4.21)$$

for one choice of color indices at each gauge node, and for one given set of balanced nodes, \mathcal{B}_ξ . Up to permutations of the color indices we can choose $\alpha_1 = \alpha_2 = \cdots = \alpha_\ell = 1$.

Define $j_1 + \ell \equiv j_2$, and let Γ be the sequence of gauge nodes $\Gamma = \{j_1, j_1 + 1, \cdots, j_1 + \ell \equiv j_2\}$. To calculate the contribution of (4.21) to the index, we first note that the above assignment of magnetic fluxes breaks the gauge symmetry down to

$$\mathcal{G}_\Gamma = \prod_{j \notin \Gamma} U(N_j) \times \prod_{j \in \Gamma} [U(N_j - 1) \times U(1)] . \quad (4.22)$$

Let us pull out of the integral expression (2.3) the fugacities $\prod_{j \in \Gamma} w_j^\pm$ and the overall factor x_-^2 . Setting $q = 0$ everywhere else and summing over equivalent permutations of color indices gives precisely the invariant measure of \mathcal{G}_Γ , normalized so that it integrates to 1. To calculate all terms systematically we must therefore expand the integrand in powers of $q^{1/4}$, and then project on the \mathcal{G}_Γ invariant sector. To the order of interest we find

$$\mathcal{Z}_{S^2 \times S^1}^{\Delta(\mathbf{m})=1} = x_-^2 \sum_{\mathcal{B}_\xi} \sum_{\Gamma \subseteq \mathcal{B}_\xi} \left(\prod_{j \in \Gamma} w_j + \prod_{j \in \Gamma} w_j^{-1} \right) \text{PE} \left(x_+ X' + (x_-^2 - x_+^2) Y' - x_+ x_- Z' \right) \Big|_{\mathcal{G}_\Gamma \text{ singlet}} + O(x^5) \quad (4.23)$$

where

$$\begin{aligned} X' &= \sum_{j=1}^k (\bar{\square}_j^\mu \square'_j + \square_j^\mu \bar{\square}'_j) + \sum_{j=1}^{k-1} (\bar{\square}'_j \square'_{j+1} + \square'_j \bar{\square}'_{j+1}) + \sum_{j,j+1 \in \Gamma} (z_{j,1} z_{j+1,1}^{-1} + z_{j,1}^{-1} z_{j+1,1}) , \\ Y' &= \sum_{j=1}^k \bar{\square}_j \square_j = \sum_{j=1}^k \bar{\square}'_j \square'_j + (j_2 - j_1 + 1) , \quad Z' = \sum_{j=1}^k (\bar{\square}'_j z_{j,1} + z_{j,1}^{-1} \square'_j) , \end{aligned} \quad (4.24)$$

and in these expressions \square'_j denotes the fundamental of $U(N'_j)$ where $N'_j = N_j - 1$ if $j \in \Gamma$, and $N'_j = N_j$ if $j \notin \Gamma$. By convention $\square'_j = 0$ when $N'_j = 0$.

Performing the projection onto \mathcal{G}_Γ singlets gives

$$\begin{aligned} X'|_{\mathcal{G}_\Gamma \text{ singlet}} &= 0, \quad Y'|_{\mathcal{G}_\Gamma \text{ singlet}} = (j_2 - j_1 + 1) + \sum_{j=1}^k \delta_{N'_j \neq 0}, \quad Z'|_{\mathcal{G}_\Gamma \text{ singlet}} = 0, \\ \text{and } S^2 X'|_{\mathcal{G}_\Gamma \text{ singlet}} &= \sum_{j=1}^k \delta_{N'_j \neq 0} \bar{\square}_j^\mu \square_j^\mu + \sum_{j=1}^{k-1} \delta_{N'_j \neq 0} \delta_{N'_{j+1} \neq 0} + (j_2 - j_1). \end{aligned} \quad (4.25)$$

Collecting and rearranging terms gives

$$\begin{aligned} \mathcal{Z}_{S^2 \times S^1}^{\Delta(\mathbf{m})=1} &= \sum_{\mathcal{B}_\xi} \sum_{[j_1, j_2] \subseteq \mathcal{B}_\xi} (\hat{\mu}_{j_1} \hat{\mu}_{j_2+1}^{-1} + \hat{\mu}_{j_1}^{-1} \hat{\mu}_{j_2+1}) \left[x_-^2 + x_-^4 \left(k + \sum_{j \in \Gamma} \delta_{N_j \neq 1} \right) \right. \\ &\quad \left. + x_-^2 x_+^2 \left(\sum_{j=1}^k \delta_{N'_j \neq 0} \bar{\square}_j^\mu \square_j^\mu + \sum_{j=1}^{k-1} \delta_{N'_j \neq 0} \delta_{N'_{j+1} \neq 0} - \sum_{j=1}^k \delta_{N'_j \neq 0} - 1 \right) \right] + O(x^5) . \end{aligned} \quad (4.26)$$

The terms that do not vanish for $x_+ = 0$ are contributions to the Hilbert series of the Coulomb branch. For a check let us consider the leading term. Combining it with the one from eq. (4.20) gives the adjoint representation of \hat{G} , as predicted by mirror symmetry

$$\text{HS}^{\text{Coulomb}} = 1 + x_-^2 \underbrace{\left[k + \sum_{\mathcal{B}_\xi} \sum_{j_1 \leq j_2 \in \mathcal{B}_\xi} (\hat{\mu}_{j_1} \hat{\mu}_{j_2+1}^{-1} + \hat{\mu}_{j_1}^{-1} \hat{\mu}_{j_2+1}) \right]}_{\text{Adj } \hat{G}} + O(x_-^3). \quad (4.27)$$

Note that the k Cartan generators of \hat{G} (those corresponding to the topological symmetry) contribute to the index in the $\mathbf{m} = 0$ sector. The monopole operators that enhance this symmetry in the infrared to the full non-abelian magnetic group enter in the sector $\Delta(\mathbf{m}) = 1$.

4.4 The mixed term

Let us now put together the mixed terms from eqs. (4.20) and (4.26). If the quiver has no abelian nodes all $N_j > 1$ and all $N'_j > 0$, and our expressions simplify enormously. The last line in eq. (4.20) collapses to $(k-1) \sum_j |\square_j^\mu|^2 - 2k$, and the last line of (4.26) collapses to $\sum_j |\square_j^\mu|^2 - 2$. Combining the two gives the following result for quivers with

No abelian nodes :

$$\begin{aligned} \mathcal{Z}^{\text{mixed}} &= x_+^2 x_-^2 \left[\left(\sum_j |\square_j^\mu|^2 - 2 \right) \left(k - 1 + \sum_{\mathcal{B}_\xi} \sum_{\epsilon = \pm} \sum_{[j_1, j_2] \subseteq \mathcal{B}_\xi} (\hat{\mu}_{j_1} \hat{\mu}_{j_2+1}^{-1})^\epsilon \right) - 2 \right] + O(x^5) \\ &= x_+^2 x_-^2 \left[(\chi_{\text{Adj } G} - 1)(\chi_{\text{Adj } \hat{G}} - 1) - 2 \right] + O(x^5). \end{aligned} \quad (4.28)$$

We will interpret this result in the following section. But first let us consider the corrections coming from abelian nodes.

The μ -dependent correction in the $\mathbf{m} = 0$ sector, eq. (4.20), is a sum of $|\square_j^\mu|^2$ over all abelian gauge nodes, which should be subtracted from the above result. We expect, by mirror symmetry, a similar subtraction for abelian gauge nodes of the magnetic quiver. To see how this comes about note first that $N'_j = 0$ in (4.26) implies that j is an abelian balanced node in $\Gamma = [j_1, j_2] \subseteq \mathcal{B}_\xi$. Now an abelian balanced node has exactly two fundamental hypermultiplets, so it is necessarily one of the following four types:

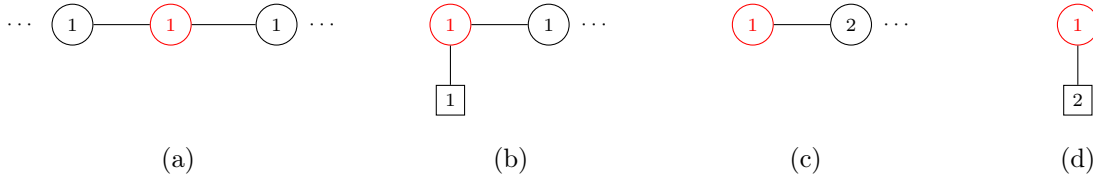

The balanced node is drawn in red, and the dots indicate that the [good] quiver extends beyond the piece shown in the figure, with extra flavour and/or gauge nodes. The set \mathcal{B}_ξ may contain several balanced nodes, as many as the rank of the corresponding non-abelian factor of the magnetic-flavour symmetry. Notice however that abelian nodes of type (c) cannot coexist in the same \mathcal{B}_ξ with abelian nodes of the other types. So we split the calculation of the $\Delta(\mathbf{m}) = 1$ sector according to whether \mathcal{B}_ξ contains abelian nodes of type (a) and/or (b), or nodes of type (c). The case (d) corresponds to a single theory called $T[SU(2)]$ and will be treated separately.

Replacing $\delta_{N'_j \neq 0}$ by $1 - \delta_{N'_j = 0}$ in the last line of (4.26) and doing the straightforward algebra leads to the following result for the $x_+^2 x_-^2$ piece:

$$\sum_{j=1}^k \delta_{N'_j \neq 0} \bar{\square}_j^\mu \square_j^\mu + \sum_{j=1}^{k-1} \delta_{N'_j \neq 0} \delta_{N'_{j+1} \neq 0} - \sum_{j=1}^k \delta_{N'_j \neq 0} - 1 = \sum_{j=1}^k \bar{\square}_j^\mu \square_j^\mu - 2 - \#\{\mathcal{B}_\xi \mid \text{types (a)\&(b)}\} \quad (4.29)$$

The first two terms on the right-hand side were already accounted for in (4.28). The extra subtraction vanishes for each \mathcal{B}_ξ of type (c), and equals -1 for each \mathcal{B}_ξ whose nodes are of type (a) and/or (b). This is precisely what one expects from mirror symmetry. Indeed, as shown in appendix B, the two cases in eq. (4.29) correspond to the $\hat{M}_\xi = |\mathcal{B}_\xi| + 1$ magnetic flavours being charged under a non-abelian, respectively abelian gauge group in the magnetic quiver ($\hat{N}_\xi > 1$, respectively $\hat{N}_\xi = 1$). In the first case there is no correction to (4.28), while in the second summing over all monopole-charge assignments in \mathcal{B}_ξ reconstructs, up to a fugacity-independent term equal to the rank, the adjoint character of the non-abelian magnetic-flavour symmetry.

Putting everything together we finally get the following for all linear quivers except $T[SU(2)]$.

Arbitrary quivers :

$$\begin{aligned} \mathcal{Z}^{\text{mixed}} = x_+^2 x_-^2 & \left[(\chi_{\text{Adj } G}(\mu) - 1)(\chi_{\text{Adj } \hat{G}}(\hat{\mu}) - 1) - 2 \right. \\ & \left. - \sum_{j|N_j=1} |\square_j^\mu|^2 - \sum_{j|\hat{N}_j=1} |\square_j^{\hat{\mu}}|^2 + \Delta n_{\text{mixed}} \right] + O(x^5), \end{aligned} \quad (4.30)$$

where the fugacity-independent correction reads

$$\Delta n_{\text{mixed}} = \sum_{j|\hat{N}_j=1} \hat{M}_j + \delta_{N_1=1} + \delta_{N_k=1} - \sum_{j=1}^k \delta_{N_j=1}. \quad (4.31)$$

We show in B.2 that Δn_{mixed} is (like the rest of the expression) mirror symmetric, albeit not manifestly so.

For completeness we give finally the result for $T[SU(2)]$, the theory described by the quiver (d). This is a self-dual abelian theory with global symmetry $SU(2) \times \widehat{SU}(2)$. In self-explanatory notation the result for this case reads

$$\mathbf{T[SU(2)]} : \quad \mathcal{Z}^{\text{mixed}} = x_+^2 x_-^2 (-3 - \mu - \mu^{-1} - \hat{\mu} - \hat{\mu}^{-1}) + O(x^5). \quad (4.32)$$

It turns out that for this theory the full superconformal index can be expressed in closed form, in terms of the q -hypergeometric function. This renders manifest a general property of the index, its factorization in holomorphic blocks [28, 29, 30]. Since we are not using this feature in our paper, the calculation is relegated to appendix C.

This completes our calculation of the mixed quartic terms of the superconformal index. We will next rewrite the index as a sum of characters of $OSp(4|4)$ and interpret the result.

5 Counting the $\mathcal{N} = 2$ moduli

The full superconformal index up to order $O(q) \sim O(x^4)$ is given by (4.18) together with expressions (4.14)-(4.15) for the Higgs branch Hilbert series, their mirrors for the Coulomb branch Hilbert series,

and expressions (4.30)-(4.31) for the mixed term. Collecting everything and using also (3.5) for the indices of individual representations of the superconformal algebra $OSp(4|4)$ leads to the main result of this paper

$$\begin{aligned}
\mathcal{Z}_{S^2 \times S^1} = & 1 + \underbrace{x_+^2(1-x_-^2)}_{\mathcal{I}_{B_1[0](1,0)}} \chi_{\text{Adj } G} + \underbrace{x_-^2(1-x_+^2)}_{\mathcal{I}_{B_1[0](0,1)}} \chi_{\text{Adj } \hat{G}} + \underbrace{x_+^3}_{\mathcal{I}_{B_1[0](3/2,0)}} \chi_{\ell=3} + \underbrace{x_-^3}_{\mathcal{I}_{B_1[0](0,3/2)}} \hat{\chi}_{\ell=3} \\
& + \underbrace{x_+^4}_{\mathcal{I}_{B_1[0](2,0)}} \boxed{(S^2 \chi_{\text{Adj } G} + \chi_{\ell=4} - \Delta \chi^{(2,0)})} + \underbrace{x_-^4}_{\mathcal{I}_{B_1[0](0,2)}} \boxed{(S^2 \chi_{\text{Adj } \hat{G}} + \hat{\chi}_{\ell=4} - \Delta \chi^{(0,2)})} \quad (5.1) \\
& + \underbrace{x_+^2 x_-^2}_{\mathcal{I}_{B_1[0](1,1)}} \boxed{(\chi_{\text{Adj } G} \chi_{\text{Adj } \hat{G}} - \Delta \chi^{(1,1)})} + \underbrace{(-x_+^2 x_-^2)}_{\mathcal{I}_{A_2[0](0,0)}} + O(x^5).
\end{aligned}$$

where $\chi_{\ell=n}$ counts independent single strings of length $n = 3, 4$ on the electric quiver, $\hat{\chi}_{\ell=n}$ counts likewise single strings on the magnetic quiver, and the correction terms coming from abelian (electric and magnetic) gauge nodes are given by¹³

$$\begin{aligned}
\Delta \chi^{(2,0)} &= \sum_{j=1}^k \delta_{N_j=1} |\square_j^\mu|^2, & \Delta \chi^{(0,2)} &= \sum_{j=1}^{\hat{k}} \delta_{\hat{N}_j=1} |\square_j^{\hat{\mu}}|^2, \\
\text{and } \Delta \chi^{(1,1)} &= \sum_{j|N_j=1} |\square_j^\mu|^2 + \sum_{j|\hat{N}_j=1} |\square_j^{\hat{\mu}}|^2 - \Delta n_{\text{mixed}}.
\end{aligned} \quad (5.2)$$

Notice that we have used in eq. (5.1) the fact that the SCFT has a unique energy-momentum tensor which is part of the $A_2[0]^{(0,0)}$ multiplet, and that all the other $OSp(4|4)$ multiplets can be unambiguously identified at this order.

5.1 Examples and interpretation

The marginal $\mathcal{N} = 2$ deformations are the terms enclosed in boxes in (5.1). Those in the second line are standard quartic superpotentials involving only the $\mathcal{N} = 4$ hypermultiplets of the electric quiver, or only their twisted cousins of the magnetic quiver. The electric superpotentials (counted in the Higgs-branch Hilberts series) are of two kinds: (i) single strings of length 4 that transform in the adjoint of each gauge-group factor $U(M_j)$, or in the bifundamental of next-to-nearest neighbour flavour groups $U(M_j) \times U(M_{j+2})$; and (ii) double-string operators in the $S^2(\text{Adj } G)$ representation. If there are abelian gauge nodes some of these operators are absent. The same statements of course hold for magnetic superpotentials and the mirror quiver.

The more interesting deformations, the ones made out of both types of hypermultiplets, are in the third line of (5.1). For quivers with no abelian nodes, these mixed operators are all possible $|\text{Adj } G| \times |\text{Adj } \hat{G}|$ gauge-invariant products of two fundamental hypermultiplets and two fundamental twisted hypermultiplets¹⁴

$$\mathcal{O}_{j;\hat{j}}^{(\bar{p},r;\bar{p},\hat{r})} = (\tilde{Q}_j^{\bar{p}} Q_j^r) (\tilde{\hat{Q}}_{\hat{j}}^{\bar{p}} \hat{Q}_{\hat{j}}^{\hat{r}}), \quad (5.3)$$

¹³The case $k = 1$ and its mirror $\hat{k} = 1$ are special as in eq. (4.14): for $k = 1$ one has $\Delta \chi^{(2,0)} = \delta_{N_1 \neq 1} |\square_1^\mu|^2 + \delta_{N_1=1} |\square_1^\mu|^2$ and $\chi_{\ell=4} = 0$. Finally, the coefficient of $\mathcal{I}_{B_1[0](1,1)}$ is zero for $T[SU(2)]$.

¹⁴More precisely, all but the overall combination $\sum_j \sum_{p,\bar{p}} Q_j^p \tilde{Q}_j^{\bar{p}} \delta_{p\bar{p}}$ and its mirror. These are the scalar partners of the two missing $U(1)$ flavour symmetries that are gauged.

where hats denote the scalars of the (twisted) hypermultiplets.

Some of the above operators can be identified with superpotential deformations involving both hypermultiplets and vector multiplets. Consider, in particular, the following gauge-invariant chiral operators of the electric theory

$$\mathcal{O}_{j,j'}^{(\bar{p},r)} = (\tilde{Q}_j^{\bar{p}} Q_j^r) \text{Tr}(\Phi_{j'}) , \quad (5.4)$$

where Φ_j is the $\mathcal{N} = 2$ chiral field in the $\mathcal{N} = 4$ vector multiplet at the j th gauge-group node. It can be easily shown that $\text{Tr}(\Phi_j)$ is the scalar superpartner of the j th topological $U(1)$ current, so that the operators (5.4) are the same as the operators (5.3) when these latter are restricted to the Cartan subalgebra of \hat{G} . Similarly, projecting (5.3) onto the Cartan subalgebra of G gives mixed superpotential deformations of the magnetic Lagrangian. The remaining $(|\text{Adj } G| - \text{rank } G) \times (|\text{Adj } \hat{G}| - \text{rank } \hat{G})$ deformations involve both charged hypermultiplets and monopole operators and have a priori no Lagrangian description.

We can also understand why some mixed operators are absent when the quiver has abelian nodes. Recall that the $\mathcal{N} = 4$ superpotential reads

$$W = \sum_{j=1}^k \left(Q_{j,j-1} \Phi_j \tilde{Q}_{j,j-1} + \tilde{Q}_{j,j+1} \Phi_j Q_{j,j+1} + \sum_{p,\bar{p}=1}^{M_j} \tilde{Q}_j^{\bar{p}} \Phi_j Q_j^p \delta_{p\bar{p}} \right) , \quad (5.5)$$

from which one derives the following F -term conditions : $\tilde{Q}_j^{\bar{p}} \Phi_j = \Phi_j Q_j^p = 0$ for all j, p and \bar{p} . Note that Φ_j is an $N_j \times N_j$ matrix, while $Q_j^{\bar{p}}$ and $Q_j^p = 0$ are bra and ket vectors. If (and only if) j is an abelian node, these conditions imply $\mathcal{O}_{j,j}^{(\bar{p},r)} = 0$ so that these operators should be subtracted. This explains the first of the three terms in the subtraction $\delta\chi^{(1,1)}$, eq. (5.2). The second is likewise explained by the F -term conditions at abelian nodes of the magnetic quiver. Finally Δn_{mixed} corrects some overcounting in these abelian-node subtractions.

We should stress that the factorization of mixed marginal deformations $B_1[0]^{(1,1)}$ in terms of electric and magnetic chiral multiplets need not be a general property of all 3d $\mathcal{N} = 4$ theories. As a counterexample [that does not come from a brane construction] consider the $SU(3)$ gauge theory with M_1 hypermultiplets in the fundamental representation and M_2 in its symmetric square. This is a good theory for $M_1 + 3M_2 \geq 5$ (in particular $\Delta(\mathbf{m}) \geq 1$ for $\mathbf{m} \neq 0$). For $M_1 + 3M_2 \geq 6$ it has no magnetic flavour symmetry, yet there are mixed marginal deformations in the $M_1 \overline{M}_2 + \overline{M}_1 M_2$ representation of the electric flavour symmetry $U(M_1) \times U(M_2)$. Even in 3d $\mathcal{N} = 4$ theories that do arise from brane constructions, complicated (p, q) -string webs with both F-string and D-string open ends, corresponding to $B_1[0]^{(j^H, j^C)}$ multiplets, need not factorize into F-string and D-string parts. However, we expect this failure to appear if at all at large j^H, j^C .

We may summarize the discussion as follows:

Marginal chiral operators of $T_{\hat{\rho}}[SU(N)]$ transform in the $S^2(\text{Adj } G + \text{Adj } \hat{G})$ representation of the electric and magnetic flavour symmetry, plus strings of length 4 (in either adjoints or bifundamentals of individual factors), modulo redundancies for quivers with abelian nodes and in the special cases $k = 1$ or $\hat{k} = 1$.

Note that the above logic could be extended to chiral operators of arbitrary dimension $\Delta = n$. Operator overcounting arises, however, in this case at electric or magnetic gauge nodes of rank $\leq n - 1$, making the combinatorial problem considerably harder.

We now illustrate these results with selected examples:

sQCD₃: The electric theory has gauge group $U(N_c)$ with $N_c \geq 2$, and $N_f \geq 2N_c$ fundamental flavours. Its electric and magnetic quivers are drawn below. The magnetic quiver with $N_f = 2N_c$ (upper right figure) differs from the one for $N_f > 2N_c$ (lower right figure). Both have $N_f - 1$ balanced nodes, corresponding to the electric $SU(N_f)$ flavour symmetry, but their magnetic symmetry is, respectively, $SU(2)$ and $U(1)$:

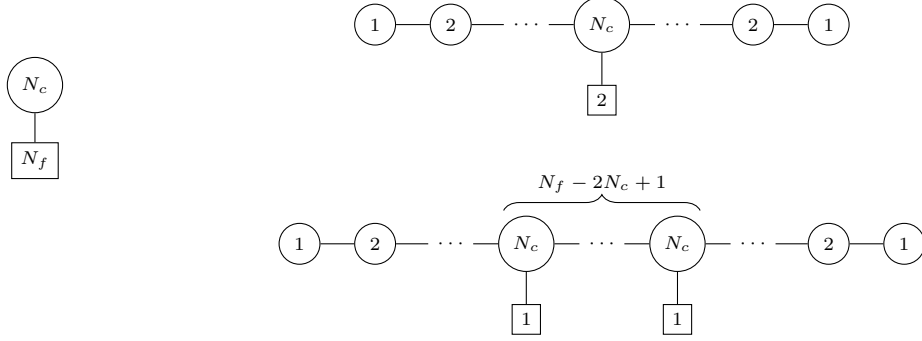

The $N_f > 2N_c$ theories have $\frac{1}{2}N_f^2(N_f^2 - 3)$ electric, one magnetic, and $(N_f^2 - 1)$ mixed marginal operators from 2-string states. For $N_f = 2N_c + 2$ there are three extra marginal operators from length 4 magnetic strings, while for other N_f there is only one. There are none from length 4 electric strings, and no abelian-node redundancies. The number of D-term conditions is $N_f^2 + 1$, so that the complex dimension of the superconformal manifold is $\dim \mathcal{M}_{SC} = \frac{1}{2}N_f^2(N_f^2 - 3)$ if $N_f \neq 2N_c + 2$, and $\dim \mathcal{M}_{SC} = \frac{1}{2}N_f^2(N_f^2 - 3) + 2$ otherwise. When $N_f = 2N_c$ the number of electric operators is the same, but there are now six 2-string magnetic operators, $3(N_f^2 - 1)$ mixed ones, three length-4 strings, and $N_f^2 + 3$ D-term conditions, hence $\dim \mathcal{M}_{SC} = \frac{1}{2}N_f^2(N_f^2 + 1) + 3$.

sQED₃: This is a $U(1)$ theory with $N_f > 2$ charged hypermultiplets. The magnetic quiver has $N_f - 1$ abelian balanced nodes and one charged hypermultiplet at each end of the chain:

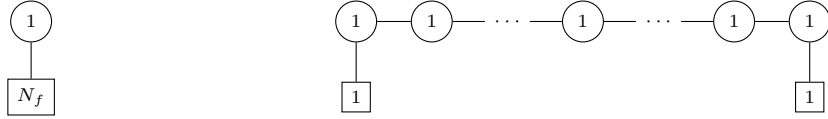

This theory has $\frac{1}{4}N_f^2(N_f + 1)^2 - N_f^2$ marginal electric operators (because the antisymmetric combination $Q^{[p}Q^{r]}$ vanishes), one magnetic operator, and no mixed ones. To prove this latter assertion one computes $\Delta n_{\text{mixed}} = 3$ from eq. (4.31) [checking in passing that the expression is mirror symmetric]. In the special case $N_f = 4$ there is in addition two length-4 magnetic strings. Note that for $N_f \gg 1$ the dimension of the superconformal manifold of sQED₃ is reduced by a factor two compared to the superconformal manifold of sQCD₃.

T[SU(N)]: This theory is defined by the self-dual fully-balanced quiver shown below.

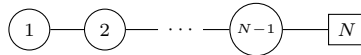

For $N \geq 3$ there are $\frac{1}{2}N^2(N^2 - 1)$ electric operators, as many magnetic operators, and $(N^2 - 1)^2$ mixed ones. The dimension of the superconformal manifold is $\dim \mathcal{M}_{SC} = (N^2 - 1)(2N^2 - 3) - 1$. The case $T[SU(2)]$ was discussed already separately.

5.2 The holographic perspective

In this last part we discuss the relation to string theory and sketch some directions for future work.

Recall that the $T_{\rho}^{\hat{\rho}}[SU(N)]$ theories are holographically dual to type IIB string theory in the supersymmetric backgrounds of refs. [3, 4]. The geometry has a $\text{AdS}_4 \times \text{S}_H^2 \times \text{S}_C^2$ fiber over a basis which is the infinite strip Σ . The $SO(2,3) \times SO(3)_H \times SO(3)_C$ symmetry of the SCFT is realized as isometries of the fiber. The solution features singularities on the upper (lower) boundary of the strip which correspond to D5-brane sources wrapping S_H^2 (NS5-brane sources wrapping S_C^2). These two-spheres are trivial in homology, yet the branes are stabilized by non-zero worldvolume fluxes that counterbalance the negative tensile stress [45].

There is a total of $k + 1$ NS5-branes and $\hat{k} + 1$ D5-branes. Their position along the boundary of the strip is a function of their linking number, which increases from left to right for D5-branes and decrease for NS5-branes [3]. Branes with the same linking number overlap giving non-abelian flavour symmetries. The linking number of a fivebrane can be equivalently defined as

- the D3-brane charge dissolved in the fivebrane ;
- the worldvolume flux on the wrapped two-sphere;
- the node of the corresponding quiver, for instance the \hat{i} th D5-brane provides a fundamental hypermultiplet at the $\hat{l}_i = i$ node of the electric quiver (see appendix B).

The R -symmetry spins J^H, J^C are the angular momenta of a state on the two spheres. Given the above dictionary, can we understand the results of this paper from the string-theory side?

Consider first the Higgs-branch chiral ring which consists of the highest weights of all $B_1[0]^{(j^H, 0)}$ multiplets. When decomposed in terms of conformal primaries these multiplets read [17]

$$B_1[0]_{j^H}^{(j^H, 0)} = [0]_{j^H}^{(j^H, 0)} \oplus [0]_{j^H+1}^{(j^H-1, 1)} \oplus [1]_{j^H+1}^{(j^H-1, 0)} \oplus \text{fermions}_{j^H+\frac{1}{2}}. \quad (5.6)$$

Note that the top component includes a vector boson with scaling dimension $\Delta = j^H + 1$. This is a massless gauge boson in AdS_4 for $j^H = 1$ ('conserved current' multiplet) and a massive gauge boson for $j^H > 1$. As explained in ref. [7], both massless and massive vector bosons are states of fundamental open strings on the D5-branes. Their vertex operators include a scalar wavefunction on S_H^2 with angular momentum $J^H = j^H - 1$. Consider such an open string stretching between two D5-branes with linking numbers ℓ and ℓ' . Since these latter are magnetic-monopole fields on S_H^2 , the open string couples to a net field $(\ell - \ell')$. Its wavefunction is therefore given by the well-known monopole spherical harmonics with¹⁵

$$j^H - 1 = \frac{1}{2}|\ell - \ell'| + \mathbb{N} \quad (5.7)$$

where \mathbb{N} are the natural numbers. Recalling that the linking numbers also designate the nodes of the electric quiver, we understand why the Higgs-branch chiral ring includes strings of minimal length $|\ell - \ell'| + 2$ transforming in the bi-fundamental of $U(M_{\ell}) \times U(M_{\ell'})$ for all $k \geq \ell' > \ell > 0$ [7]. The bifundamental strings of length 3 and 4 in eq. (4.14) are of this kind.

The $\Delta = 2$ chiral ring also includes strings of length 4 in the adjoint of $U(M_j)$ for all $k > j > 1$, see (4.14). The corresponding open-string vector bosons on the i th stack of D5-branes do not feel a monopole field ($\ell = \ell' = i$) but have angular momentum $j^H - 1 = 1$. Notice however that these

¹⁵This celebrated result goes back to the early days of quantum mechanics [46]. We have used it implicitly when expressing determinants as q -Pochhammer symbols. For an amusing real-time manifestation of the effect see [47].

length-4 operators are missing at the two ends of the quiver, i.e. for $i = 1$ and for $i = k$. How can one understand this from the string theory side?

A plausible explanation comes from a well-known effect dubbed ‘stringy exclusion principle’ in ref. [48]. The relevant setup features K NS5-branes and a set of probe D-branes ending on them. The worldsheet theory in this background has an affine algebra $\mathfrak{su}(2)_K$ ¹⁶ and D-branes (Cardy states) labelled by the set of dominant affine weights $\lambda = 0, 1, \dots, K - 1$. The ground states of open strings stretched between two such D-branes have weights ν in the interval

$$[|\lambda - \lambda'|, \min(\lambda + \lambda', 2K - \lambda - \lambda')]$$

and in steps of two [49]. Translating $\lambda = \ell - 1$ (see [47]), $\mu = 2(j^H - 1)$ and $K = k + 1$ (the total number of NS5-branes) gives in replacement of (5.7)

$$j^H - 1 = \frac{1}{2}|\ell - \ell'|, \frac{1}{2}|\ell - \ell'| + 1, \dots, \min\left(\frac{\ell + \ell'}{2} - 1, k - \frac{\ell + \ell'}{2}\right). \quad (5.8)$$

The intuitive understanding of the upper cutoff is that a string cannot remain in its ground state if its angular momentum exceeds the size of the sphere. It follows that for $\ell = \ell' = 1$ or k , only the $j^H = 1$ states survive, in agreement with our findings for the single-string part of the Higgs-branch chiral ring.

To be sure this is just an argument, not a proof, because in the solutions dual to $T_\rho^\hat{\rho}[SU(N)]$ the 3-sphere threaded by the NS5-brane flux is highly deformed by the strong back reaction of the D-branes. The perfect match with the field theory side suggests, however, that the detailed geometry does not matter when it comes to the above stringy effect.¹⁷

The superconformal index brings to light other exclusion effects associated to abelian gauge nodes of the electric and magnetic quivers, as summarized in eqs. (5.1) and (5.2). For higher elements of the chiral ring, these effects are more generally related to the finite ranks of the gauge groups. This is a ubiquitous phenomenon in holography – McGreevy et al coined the name ‘giant graviton’ for it in the prototypical $\text{AdS}_5 \times \text{S}^5$ example [50]. We did not manage to find a simple explanation for giant-graviton exclusions in the problem at hand. Part of the difficulty is that, as opposed to the 5-brane linking numbers, the gauge group ranks have a less direct meaning on the gravitational side of the AdS/CFT correspondence.¹⁸

We conclude our discussion of the AdS side with a remark about gauged $\mathcal{N} = 4$ supergravity. In addition to the graviton, this has n vector multiplets and global $SL(2) \times SO(6, n)$ symmetry, part of which may be gauged. Insisting that the gauged theory have a supersymmetric AdS_4 vacuum restricts the form of the gauge group to be $G_H \times G_C \times G_0 \subset SO(6, n)$, where the (generally) non-compact G_H and G_C contain the R -symmetries $SO(3)_H$ and $SO(3)_C$ [51].

The vector bosons of spontaneously-broken gauge symmetries belong to B -type multiplets with $(j^H, j^C) = (2, 0)$ or $(0, 2)$. These can describe the length-4 marginal operators in the Higgs-branch or Coulomb-branch chiral rings. As noted on the other hand in ref. [7], there is no room for elementary $(1, 1)$ multiplets in $\mathcal{N} = 4$ supergravity, because such multiplets have extra spin- $\frac{3}{2}$ fields. But we have just seen that linear-quiver theories have no single-string $(1, 1)$ operators, so the above limitation does not apply. All mixed marginal deformations correspond to double-string operators that can be

¹⁶The bosonic subalgebra has level $K - 2$ and an extra factor 2 is added by fermions.

¹⁷The match between field theory and (multi-string) symmetric products of single-string states counted using the stringy exclusion principle seems to continue holding to higher orders until the occurrence of low gauge-group rank exclusion effects discussed below.

¹⁸Note that two theories with the same flavour symmetry, i.e. the same disposition of five-branes, can have very different gauge-group ranks. This feature (called ‘fine print’ in ref. [7]) is best illustrated by sQCD_3 with a fixed number of flavours, N_f , but an arbitrary number of colors $N_c \in (2, [N_f/2] - 1)$, see subsection 5.1.

described effectively by modifying the boundary conditions of their single-string constituents [26, 27]. Note that boundary conditions change the quantization, not the solution. So

Gauged $\mathcal{N} = 4$ supergravity has the necessary ingredients to describe the complete moduli space of the $T_{\hat{\rho}}[SU(N)]$ theories, provided one considers both classical and quantization moduli.

This quells, at least for linear quivers, the concern raised in [7] that reduction of string theory to gauged 4d supergravity may truncate away part of the moduli space. As pointed out, however, recently by one of us [16] such quantization moduli of gauged supergravity can be singular in the full-fledged ten-dimensional string theory.

5.3 One last comment

We end with a remark about the Hilbert series of $T_{\hat{\rho}}[SU(N)]$ theories. As we explained in section 3, the full chiral ring consists of the highest-weights of all B -type multiplets in the theory with arbitrary (j^H, j^C) . The relevant and marginal operators can be identified unambiguously in the index, as can the entire Higgs-branch and Coulomb-branch subrings. But general mixed elements (with $j^H, j^C \geq 1$ not both 1) cannot be extracted unambiguously. A calculation that does not rely on the superconformal index would therefore be of great interest.

A natural conjecture for the full Hilbert series [25] is that it is the coordinate ring of the union of all branches B_{σ} (for the $T_{\hat{\rho}}$ theory, σ ranges over partitions between ρ and $\hat{\rho}^T$),

$$\text{HS}\left(\bigcup_{\sigma} B_{\sigma} \mid x_{+}, x_{-}\right) = \sum_{\Lambda} (-1)^{|\Lambda|-1} \text{HS}\left(\bigcap_{\sigma \in \Lambda} B_{\sigma} \mid x_{+}, x_{-}\right) \quad (5.9)$$

where Λ runs over all non-empty subsets of the branches of the theory. In words, the full Hilbert series would be the sum of Hilbert series of every branch, minus corrections due to pairwise intersections and so on. It can be checked that this conjecture is consistent with the Higgs branch and Coulomb branch limits ($q^{1/4}t^{\mp 1/2} \rightarrow 0$ with $q^{1/4}t^{\pm 1/2}$ fixed). One can also compare the number of $B_1[0]^{(1,1)}$ multiplets suggested by this conjecture to the number extracted from the index. In the limited set of examples that we checked (with zero or one mixed branch) we found an exact match. Finding a better way to confirm or falsify this conjecture is an interesting problem.

Acknowledgements: We thank Benjamin Assel, Santiago Cabrera, Ken Intriligator, Noppadol Mekareeya, Shlomo Razamat and Alberto Zaffaroni for useful discussions and for correspondence. We are particularly indebted to Amihay Hanany for his many patient explanations of aspects of 3d quiver gauge theories. CB gratefully acknowledges the hospitality of the String Theory group at Imperial College where part of this work was done.

A Index and plethystic exponentials

The twisted partition function on $S^2 \times S^1$ of the $T_\rho^{\hat{p}}$ theory is given by a multiple sum over monopole charges and a multiple integral over gauge fugacities, see e.g. [40]

$$\mathcal{Z}_{S^2 \times S^1} = \prod_{j=1}^k \left[\frac{1}{N_j!} \sum_{m_j \in \mathbb{Z}^{N_j}} \int \prod_{\alpha=1}^{N_j} \frac{dz_{j,\alpha}}{2\pi i z_{j,\alpha}} \right] \left\{ \prod_{j=1}^k \prod_{\alpha=1}^{N_j} w_j^{m_{j,\alpha}} Z_{j,\alpha}^{\text{vec,diag}} \right. \\ \left. \prod_{j=1}^k \prod_{\alpha \neq \beta}^{N_j} Z_{j,\alpha,\beta}^{\text{vec,off-diag}} \prod_{j=1}^k \prod_{p=1}^{M_j} \prod_{\alpha=1}^{N_j} Z_{j,p,\alpha}^{\text{fund,hyp}} \prod_{j=1}^{k-1} \prod_{\alpha=1}^{N_j} \prod_{\beta=1}^{N_{j+1}} Z_{j,\alpha,j+1,\beta}^{\text{bifund,hyp}} \right\} \quad (\text{A.1})$$

where

$$Z_{j,\alpha}^{\text{vec,diag}} = \frac{(q^{\frac{1}{2}}t; q)_\infty}{(q^{\frac{1}{2}}t^{-1}; q)_\infty} \quad (\text{A.2a})$$

$$Z_{j,\alpha,\beta}^{\text{vec,off-diag}} = (q^{\frac{1}{2}}t^{-1})^{-\frac{1}{2}|m_{j,\alpha}-m_{j,\beta}|} (1 - q^{\frac{1}{2}|m_{j,\alpha}-m_{j,\beta}|} z_{j,\beta} z_{j,\alpha}^{-1}) \\ \times \frac{(tq^{\frac{1}{2}+|m_{j,\alpha}-m_{j,\beta}|} z_{j,\beta} z_{j,\alpha}^{-1}; q)_\infty}{(t^{-1}q^{\frac{1}{2}+|m_{j,\alpha}-m_{j,\beta}|} z_{j,\beta} z_{j,\alpha}^{-1}; q)_\infty} \quad (\text{A.2b})$$

$$Z_{j,p,\alpha}^{\text{fund,hyp}} = (q^{\frac{1}{2}}t^{-1})^{\frac{1}{2}|m_{j,\alpha}|} \frac{(t^{-\frac{1}{2}}q^{\frac{3}{4}+\frac{1}{2}|m_{j,\alpha}|} z_{j,\alpha}^{\pm 1} \mu_{j,p}^{\mp 1}; q)_\infty}{(t^{\frac{1}{2}}q^{\frac{1}{4}+\frac{1}{2}|m_{j,\alpha}|} z_{j,\alpha}^{\mp 1} \mu_{j,p}^{\pm 1}; q)_\infty} \quad (\text{A.2c})$$

$$Z_{j,\alpha,j+1,\beta}^{\text{bifund,hyp}} = (q^{\frac{1}{2}}t^{-1})^{\frac{1}{2}|m_{j,\alpha}-m_{j+1,\beta}|} \frac{(t^{-\frac{1}{2}}q^{\frac{3}{4}+\frac{1}{2}|m_{j,\alpha}-m_{j+1,\beta}|} z_{j,\alpha}^{\pm 1} z_{j+1,\beta}^{\mp 1}; q)_\infty}{(t^{\frac{1}{2}}q^{\frac{1}{4}+\frac{1}{2}|m_{j,\alpha}-m_{j+1,\beta}|} z_{j,\alpha}^{\mp 1} z_{j+1,\beta}^{\pm 1}; q)_\infty} . \quad (\text{A.2d})$$

The expressions (A.2) are the one-loop determinants of the $\mathcal{N} = 4$ multiplets of $T_\rho^{\hat{p}}$, namely the Cartan and charged vector multiplets, and the fundamental and bifundamental hypermultiplets. The variables q, t are the fugacities defined in eq. (2.2), $z_{j,\alpha}$ (where α labels the Cartan generators) are the S^1 holonomies of the $U(N_j)$ gauge field and $m_{j,\alpha}$ its 2-sphere fluxes, *viz.* the monopole charges of the corresponding local operator in \mathbb{R}^3 . Furthermore $\mu_{j,p}$ are flavor fugacities, w_j is a fugacity for the topological $U(1)$ symmetry whose conserved current is $\text{Tr} \star F_{(j)}$, while the q -Pochhammer symbols $(a; q)_\infty$ are defined by

$$(a; q)_\infty = \prod_{n=0}^{\infty} (1 - aq^n) \quad \text{and} \quad (\dots a^{\pm 1} b^{\mp 1}; q)_\infty = (\dots ab^{-1}; q)_\infty (\dots a^{-1}b; q)_\infty . \quad (\text{A.3})$$

Compared to the expressions in ref. [40] we have here replaced the background flux coupling to any given multiplet by its absolute value. This is allowed because of some cancellation between factors in the numerator and denominator Pochhammer symbols, as explicated for instance around (C.4). The theory is also free from parity anomalies, so that the overall signs are unambiguous.¹⁹

At leading order in the q expansion, the contribution of each monopole sector $\mathbf{m} = \{m_{j,\alpha}\}$ to the superconformal index is $(q^{\frac{1}{2}}t^{-1})^{\Delta(\mathbf{m})}$, where

$$2\Delta(\mathbf{m}) = \sum_{j=1}^k \sum_{\alpha,\beta=1}^{N_j} -|m_{j,\alpha} - m_{j,\beta}| + \sum_{j=1}^k M_j \sum_{\alpha=1}^{N_j} |m_{j,\alpha}| + \sum_{j=1}^{k-1} \sum_{\alpha=1}^{N_j} \sum_{\beta=1}^{N_{j+1}} |m_{j,\alpha} - m_{j+1,\beta}|. \quad (\text{A.4})$$

¹⁹There exists a subtle sign $(-)^{e \cdot m}$ related to the change of spin of dyonic states with charges (e, m) . The $T_\rho^{\hat{p}}$ theory has no Chern-Simons terms, so the flux ground states have no electric charge, e , and contribute with plus signs to the index. For excited states in the flux background this sign can be absorbed in the fugacities $z_{j,\alpha}$; it is in the end irrelevant since the $z_{j,\alpha}$ integrations project to gauge-invariant states.

The sphere Casimir energy $\Delta(\mathbf{m})$ is the scaling dimension [and the $SO(3)_C$ spin] of the corresponding monopole operator [32, 33]. It is known that in $\mathcal{N} = 4$ theories monopole-operator dimensions are one-loop exact, and that they are strictly positive for good linear quivers [1]. The index (A.1) admits therefore an expansion in positive powers of q .

It is useful to rewrite the superconformal index in terms of the plethystic exponential (PE) which is defined, for any function $f(v_1, v_2, \dots)$ of arbitrarily many variables that vanishes at 0, by the following expression

$$\text{PE}(f) = \exp\left(\sum_{n=1}^{\infty} \frac{1}{n} f(v_1^n, v_2^n, \dots)\right). \quad (\text{A.5})$$

The reader can verify the following simple identities:

$$\text{PE}(f + g) = \text{PE}(f)\text{PE}(g), \quad \text{PE}(-v) = (1 - v), \quad \text{PE}((a, q)_{\infty}) = \text{PE}\left(-\frac{a}{1 - q}\right). \quad (\text{A.6})$$

Using these identities one can bring the index to the following form

$$\begin{aligned} \mathcal{Z}_{S^2 \times S^1} &= \prod_{j=1}^k \left[\frac{1}{N_j!} \sum_{m_j \in \mathbb{Z}^{N_j}} \int \prod_{\alpha=1}^{N_j} \frac{dz_{j,\alpha}}{2\pi i z_{j,\alpha}} \right] \left\{ (q^{\frac{1}{2}} t^{-1})^{\Delta(\mathbf{m})} \prod_{j=1}^k \left[\prod_{\alpha}^{N_j} w_j^{m_{j,\alpha}} \prod_{\alpha \neq \beta}^{N_j} (1 - q^{\frac{1}{2}|m_{j,\alpha} - m_{j,\beta}|} z_{j,\beta} z_{j,\alpha}^{-1}) \right] \right. \\ &\quad \times \text{PE} \left(\sum_{j=1}^k \sum_{\alpha, \beta=1}^{N_j} \frac{q^{\frac{1}{2}}(t^{-1} - t)}{1 - q} q^{|m_{j,\alpha} - m_{j,\beta}|} z_{j,\beta} z_{j,\alpha}^{-1} \right. \\ &\quad \left. + \frac{(q^{\frac{1}{2}} t)^{\frac{1}{2}} (1 - q^{\frac{1}{2}} t^{-1})}{1 - q} \sum_{j=1}^k \sum_{p=1}^{M_j} \sum_{\alpha=1}^{N_j} q^{\frac{1}{2}|m_{j,\alpha}|} \sum_{\pm} z_{j,\alpha}^{\mp 1} \mu_{j,p}^{\pm 1} \right. \\ &\quad \left. \left. + \frac{(q^{\frac{1}{2}} t)^{\frac{1}{2}} (1 - q^{\frac{1}{2}} t^{-1})}{1 - q} \sum_{j=1}^{k-1} \sum_{\alpha=1}^{N_j} \sum_{\beta=1}^{N_{j+1}} q^{\frac{1}{2}|m_{j,\alpha} - m_{j+1,\beta}|} \sum_{\pm} z_{j,\alpha}^{\mp 1} z_{j+1,\beta}^{\pm 1} \right) \right\}. \quad (\text{A.7}) \end{aligned}$$

This is equation (2.3) in the main text. Notice that after extracting some factors, the contributions of vector, fundamental and bifundamental multiplets add up in the argument of the plethystic exponential, as they would in the standard exponential function.

The usefulness of the above rewriting can be illustrated with a simple example, that of a free hypermultiplet whose superconformal index is

$$\mathcal{Z}_{S^2 \times S^1}^{\text{free hyp}} = \frac{(t^{-\frac{1}{2}} q^{\frac{3}{4}} \mu^{\mp 1}; q)_{\infty}}{(t^{\frac{1}{2}} q^{\frac{3}{4}} \mu^{\pm 1}; q)_{\infty}} = \text{PE} \left(\frac{(q^{\frac{1}{4}} t^{\frac{1}{2}} - q^{\frac{3}{4}} t^{-\frac{1}{2}})}{1 - q} (\mu + \mu^{-1}) \right). \quad (\text{A.8})$$

One recognizes in the PE exponent the contributions of the charge-conjugate $\mathcal{N} = 2$ chiral multiplets, each contributing to the index with one scalar ($\Delta = J_3^H = \frac{1}{2}$ and $J_3 = J_3^C = 0$) and one fermionic state (with $\Delta = 1$, $J_3^H = 0$ and $J_3 = J_3^C = \frac{1}{2}$). As for the factor of $(1 - q)$, this sums up descendant states obtained by the action of the derivative that raises both Δ and J_3 by one unit. Multiparticle states (created by products of fields) are taken care of by the plethystic exponential, the information in them is in this simple case redundant.

Of course in interacting theories supersymmetric multiparticle states may be null, due for example to F -term conditions. The plethystic exponent must in this case be interpreted appropriately, as we discuss in the main text.

B Combinatorics of linear quivers

We collect here formulae for the different parametrizations of the discrete data of the good linear quivers, and we establish two lemmas used in subsection 4.4 of the main text.

The mirror-symmetric parametrization of the quiver is in terms of two partitions $(\rho, \hat{\rho})$ with an equal total number N of boxes, if these partitions are viewed as Young diagrams. We label entries of these partitions and of their transposes as

$$\begin{aligned}
\rho &= (l_1, l_2, \dots, l_{k+1}) & \text{with } l_1 \geq l_2 \geq \dots \geq l_{k+1} \geq 1, \\
\rho^T &= (l_1^T, l_2^T, \dots, l_{l_1}^T) & \text{with } l_1^T \geq l_2^T \geq \dots \geq l_{l_1}^T \geq 1, \\
\hat{\rho} &= (\hat{l}_1, \hat{l}_2, \dots, \hat{l}_{\hat{k}+1}) & \text{with } \hat{l}_1 \geq \hat{l}_2 \geq \dots \geq \hat{l}_{\hat{k}+1} \geq 1, \\
\hat{\rho}^T &= (\hat{l}_1^T, \hat{l}_2^T, \dots, \hat{l}_{\hat{l}_1}^T) & \text{with } \hat{l}_1^T \geq \hat{l}_2^T \geq \dots \geq \hat{l}_{\hat{l}_1}^T \geq 1,
\end{aligned} \tag{B.1}$$

where we used the fact that the number of rows of ρ^T is given by the longest row l_1 of ρ , we denoted the number of rows of ρ as $l_1^T = k + 1 \geq 2$, and likewise for hatted quantities. To simplify formulae, the sequences (l_j) , (l_j^T) , (\hat{l}_j) , (\hat{l}_j^T) are extended with zeros when j or \hat{j} goes beyond the last entry. The total number of boxes is $\sum_j l_j = \sum_j l_j^T = \sum_{\hat{j}} \hat{l}_{\hat{j}} = \sum_{\hat{j}} \hat{l}_{\hat{j}}^T = N$.

In the string-theory embedding ρ and $\hat{\rho}$ describe how N D3-branes end on two sets of fivebranes: on $k + 1$ NS5-branes to the left and on $\hat{k} + 1$ D5-branes to the right.²⁰ The number of D3-branes ending on the j th NS5-brane (or its linking number which is invariant under brane moves) is l_j , and likewise for the hatted quantities. A useful alternative parametrization of these partitions is in terms of the numbers of their same-length rows

$$\begin{aligned}
\rho &= \left(\underbrace{\hat{k} + \dots + \hat{k}}_{M_{\hat{k}}} + \dots + \underbrace{\ell + \dots + \ell}_{M_{\ell}} + \dots + \underbrace{1 + \dots + 1}_{M_1} \right), \\
\hat{\rho} &= \left(\underbrace{k + \dots + k}_{M_k} + \dots + \underbrace{\ell + \dots + \ell}_{M_{\ell}} + \dots + \underbrace{1 + \dots + 1}_{M_1} \right),
\end{aligned} \tag{B.2}$$

where we used the good property $\hat{\rho}^T > \rho$ which implies that $l_1 \leq \hat{k}$ and $\hat{l}_1 \leq k$. Note that here some of the M_{ℓ} and \hat{M}_{ℓ} may vanish, when there are no fundamental hypermultiplets at the corresponding gauge-group nodes. Note also that the label ξ for groups of balanced nodes in subsection 4.4 runs over stacks of NS5-branes with $\hat{M}_{\ell} > 1$, i.e. over nodes in the magnetic quiver with non-abelian flavour groups.

The electric and magnetic gauge groups are $\prod_{j=1}^k U(N_j)$ and $\prod_{\hat{j}=1}^{\hat{k}} U(\hat{N}_{\hat{j}})$:

$$\begin{array}{ccc}
\begin{array}{c} \textcircled{N_1} - \textcircled{N_2} - \dots - \textcircled{N_k} \\ \textcircled{M_1} \quad \textcircled{M_2} \quad \quad \textcircled{M_k} \end{array} & N_j = N_{j-1} + \hat{l}_j^T - l_j \text{ with } N_0 = 0, \\
& M_j = \hat{l}_j^T - \hat{l}_{j+1}^T, \\
\begin{array}{c} \textcircled{\hat{N}_1} - \textcircled{\hat{N}_2} - \dots - \textcircled{\hat{N}_{\hat{k}}} \\ \textcircled{\hat{M}_1} \quad \textcircled{\hat{M}_2} \quad \quad \textcircled{\hat{M}_{\hat{k}}} \end{array} & \hat{N}_{\hat{j}} = \hat{N}_{\hat{j}-1} + l_j^T - \hat{l}_{\hat{j}} \text{ with } \hat{N}_0 = 0, \\
& \hat{M}_{\hat{j}} = l_j^T - l_{\hat{j}+1}^T.
\end{array} \tag{B.3}$$

²⁰In some of the earlier literature, especially ref. [3], ρ designated the partition of D3-branes among D5-branes and $\hat{\rho}$ the partition among NS5-branes. Our flipped convention here is chosen so as to remove all hats from the data of the electric quiver, defined as the theory whose manifest flavour symmetry is realized on D5-branes. Note in particular that in the parametrization (B.2) the number of same-length rows of $\hat{\rho}$ runs over $j = 1, \dots, k$.

The 3d $\mathcal{N} = 4$ flavour group is $G \times \hat{G}$ with $G = (\prod_{j=1}^k U(M_j))/U(1)$ and $\hat{G} = (\prod_{j=1}^k U(\hat{M}_j))/U(1)$. By definition of transposition, \hat{l}_j^T counts rows of $\hat{\rho}$ with at least j boxes, so the following difference counts rows of $\hat{\rho}$ with exactly j boxes:

$$M_j = \hat{l}_j^T - \hat{l}_{j+1}^T = \#\{i \mid \hat{l}_i = j\},$$

and likewise $\hat{M}_j = l_j^T - l_{j+1}^T = \#\{i \mid l_i = j\}.$

(B.4)

We restrict our attention to *good theories*: those with all $N_j \geq 1$ and $\hat{N}_j \geq 1$. In particular, $1 \leq \hat{N}_1 = l_1^T - \hat{l}_1 = k + 1 - \hat{l}_1$, namely $\hat{l}_1 \leq k$. Likewise, $l_1 \leq \hat{k}$.

An important quantity is the *balance* of a node. It takes a very simple form in terms of the partitions:

$$N_{j+1} + N_{j-1} + M_j - 2N_j = (N_{j+1} - N_j) - (N_j - N_{j-1}) + M_j$$

$$= \hat{l}_{j+1}^T - l_{j+1} - \hat{l}_j^T + l_j + \hat{l}_j^T - \hat{l}_{j+1}^T = l_j - l_{j+1}.$$
(B.5)

The node j is *balanced* if this vanishes. An interval $\mathcal{B} \subseteq [1, k]$ of balanced nodes of the electric quiver thus corresponds to $|\mathcal{B}| + 1$ consecutive l_j equal to the same value \hat{j} . In terms of the transposed partition, this means $\hat{M}_j = l_j^T - l_{j+1}^T = |\mathcal{B}| + 1$. This is the well-known $SU(|\mathcal{B}| + 1)$ flavour symmetry enhancement.

Lemma B.1. *If the electric quiver has a balanced abelian node $N_j = 1$ then one of the following possibilities holds:*

1. $1 < j < k$ and $M_j = 0$ and $N_{j-1} = N_{j+1} = 1$;
2. $j = k = 1$ and $M_1 = 2$ (this is the $T[SU(2)]$ theory);
3. $j = 1$ and $M_1 = 1$ and $N_2 = 1$;
4. $j = k$ and $M_k = 1$ and $N_{k-1} = 1$;
5. $j = 1$ and $M_1 = 0$ and $N_2 = 2$;
6. $j = k$ and $M_k = 0$ and $N_{k-1} = 2$.

The corresponding magnetic gauge group (at position $\hat{j} := l_j$) is abelian in the first four cases and non-abelian in the last two.

Proof. The balance condition reads $N_{j-1} + N_{j+1} + M_j = 2N_j = 2$. This implies that (N_{j-1}, M_j, N_{j+1}) are $(1, 0, 1)$, $(0, 2, 0)$, $(0, 1, 1)$, $(1, 1, 0)$, $(0, 0, 2)$ or $(2, 0, 0)$. For each case where $N_{j-1} = 0$ we deduce $j = 1$ because all nodes in $[1, k]$ have non-zero rank. Similarly, $N_{j+1} = 0$ means $j = k$. We then work out the rank of the magnetic gauge group in each case.

Case 1. From $N_j - N_{j-1} = 0$ and $M_j = 0$ and $N_{j+1} - N_j = 0$ we see that $l_j = \hat{l}_j^T = \hat{l}_{j+1}^T = l_{j+1}$ (we denote this \hat{j}). Thus the intersection of ρ (drawn in blue below) and $\hat{\rho}^T$ (drawn in red and dashed) includes a $(j + 1) \times \hat{j}$ rectangle (drawn as thick black lines), and the two partitions share a boundary.

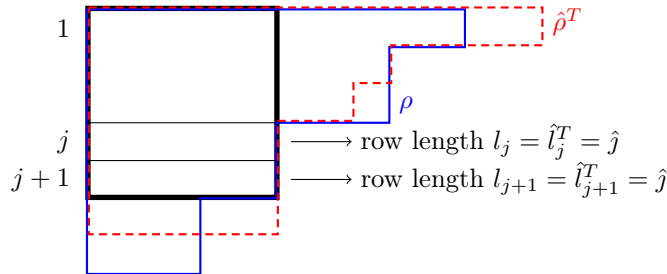

By definition, $\hat{N}_{\hat{j}}$ counts boxes in rows 1 through \hat{j} of ρ^T , minus those in the same rows of $\hat{\rho}$. Removing the common rectangle, this compares the numbers of boxes of the two partitions below the rectangle. Since the total numbers of boxes in both partitions are the same, it is equivalent to comparing boxes above the lower edge of the rectangle, hence $\hat{N}_{\hat{j}} = N_{j+1} = 1$.

Case 2. $T[SU(2)]$ is self-mirror and abelian.

Cases 3. and 5. $N_1 = 1$ gives $\hat{l}_1^T = l_1 + 1$. Thus, $\hat{N}_{\hat{l}_1}$ counts boxes of ρ^T (this partition has l_1 rows) minus all boxes of $\hat{\rho}$ except its last (\hat{l}_1^T -th) row. Since $|\rho^T| = |\hat{\rho}|$, we conclude that the rank we care about is $\hat{N}_{\hat{l}_1} = \hat{l}_{\hat{l}_1^T}$. This in turn is equal to the number of entries of $\hat{\rho}^T$ equal to \hat{l}_1^T . Note now that $\hat{l}_1^T = \hat{l}_2^T + M_1$. If $M_1 > 0$ (case 3) then $\hat{l}_2^T < \hat{l}_1^T$ so $\hat{N}_{\hat{l}_1} = 1$. If $M_1 = 0$ (case 5) then $\hat{l}_2^T = \hat{l}_1^T$ so $\hat{N}_{\hat{l}_1} \geq 2$.

Cases 4. and 6. $N_k = 1$ (and $N_{k+1} = 0$) gives $l_{k+1} = \hat{l}_{k+1}^T + 1$, while balance gives $l_k = l_{k+1}$. On general grounds, $1 \leq \hat{N}_1 = l_1^T - \hat{l}_1 = k + 1 - \hat{l}_1$ so the number of rows \hat{l}_1 of $\hat{\rho}^T$ is $\leq k$, hence in particular $\hat{l}_{k+1}^T = 0$. From all this we deduce that $l_k = l_{k+1} = 1$ and that we want to know \hat{N}_1 . Now use $\hat{l}_k^T = \hat{l}_{k+1}^T + M_k$. If $M_k = 0$ then this vanishes so $\hat{\rho}^T$ has at most $k - 1$ rows, so $\hat{N}_1 = k + 1 - \hat{l}_1 \geq 2$. If $M_k > 0$ then $\hat{\rho}^T$ has k rows, namely $\hat{N}_1 = k + 1 - \hat{l}_1 = 1$. \square

In the main text we introduce the number Δn_{mixed} , given in (4.31), that counts redundancies between F -term relations in the mixed term $x_+^2 x_-^2$.

Lemma B.2. *The quantity $\Delta n_{\text{mixed}} = \delta_{N_1=1} + \delta_{N_k=1} - \sum_{j=1}^k \delta_{N_j=1} + \sum_{\hat{j}|\hat{N}_{\hat{j}}=1} \hat{M}_{\hat{j}}$ is invariant under mirror symmetry. Furthermore, $\Delta n_{\text{mixed}} = 3$ for abelian theories and $\Delta n_{\text{mixed}} \leq 2$ otherwise.*

Proof. An important ingredient in the previous proof was an intersection point between the boundaries $\partial\rho$ of ρ and $\partial\hat{\rho}^T$ of $\hat{\rho}^T$ (we do not include the two coordinate axes in these boundaries). Denote by (j, \hat{j}) the position of such an intersection point, where $(0, 0)$ is the upper left corner, so that the partitions share a $j \times \hat{j}$ rectangle but neither contains the box at positions $(j + 1, \hat{j} + 1)$. Then N_j , which counts boxes of $\hat{\rho}^T$ above the intersection minus those of ρ , is equal to $\hat{N}_{\hat{j}}$, which counts the same difference for boxes to the left of the intersection.

Let us define the *label* (an integer ≥ 1) of each connected component of the $\partial\rho \cap \partial\hat{\rho}^T$ intersection of boundaries as this difference in the number of boxes above this connected component. Let us now understand Δn_{mixed} in terms of the components with label 1.

Consider first the (non-zero) terms in $\sum_{\hat{j}|\hat{N}_{\hat{j}}=1} \hat{M}_{\hat{j}}$, namely consider \hat{j} with $N_j = 1$ and $\hat{M}_{\hat{j}} \geq 1$. There are a few cases.

- $1 < \hat{j} < \hat{k}$: then $\hat{N}_{\hat{j} \pm 1} \geq 1 = N_j$ so $\hat{l}_{\hat{j}+1} \leq l_{\hat{j}+1}^T \leq l_j^T \leq \hat{l}_{\hat{j}}$, where the middle inequality comes from $\hat{M}_{\hat{j}} = l_j^T - l_{\hat{j}+1}^T \geq 0$. This corresponds to a vertical edge of length $\hat{M}_{\hat{j}}$ from $(l_{\hat{j}+1}^T, \hat{j})$ to (l_j^T, \hat{j}) , shared by ρ and $\hat{\rho}^T$, and with label $N_j = 1$.
- $1 = \hat{j} < \hat{k}$: now $\hat{l}_{\hat{j}} = l_{\hat{j}}^T - 1$ so the shared vertical edge has length $\hat{M}_{\hat{j}} - 1$ from $(l_{\hat{j}+1}^T, \hat{j})$ to $(\hat{l}_{\hat{j}}, \hat{j})$.
- $1 < \hat{j} = \hat{k}$: now $\hat{l}_{\hat{j}+1} = l_{\hat{j}+1}^T + 1$ so the shared edge has length $\hat{M}_{\hat{j}} - 1$ from $(\hat{l}_{\hat{j}+1}, \hat{j})$ to (l_j^T, \hat{j}) .
- $1 = \hat{j} = \hat{k}$: one checks the shared vertical edge has length $\hat{M}_{\hat{j}} - 2$ (non-negative because of the balance condition).

Conversely, every shared vertical edge from (i_1, j) to (i_2, j) with label 1 shows up in this list: indeed, the label means $N_j = 1$ and the edge implies that $l_{j+1}^T \leq i_1 < i_2 \leq l_j^T$ are separated by at least $\hat{M}_j \geq i_2 - i_1 \geq 1$. Altogether, the total length of all vertical edges with label 1 shared by ρ and $\hat{\rho}^T$ is

$$\sum_{j|\hat{N}_j=1} (\hat{M}_j - \delta_{j=1} - \delta_{j=\hat{k}}) = \left(\sum_{j|\hat{N}_j=1} \hat{M}_j \right) - \delta_{\hat{N}_1=1} - \delta_{\hat{N}_{\hat{k}}=1}. \quad (\text{B.6})$$

Next consider the other sum in Δn_{mixed} , namely $\sum_{j=1}^k \delta_{N_j=1}$. Separating four cases as above we find that this sum counts the *number* (rather than length) of shared *horizontal* “edges” with label 1. To be more precise, we include among these “edges” one zero-length edge (intersection point) for each integer point along the shared vertical edges, as we depict in the following figure (shared horizontal edges are in black bold, and circled numbers are the labels).

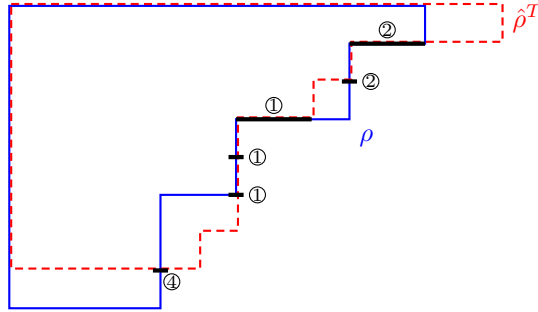

We are ready to put together these observations. In each connected component of the shared boundary of ρ and $\hat{\rho}^T$ with label 1, the total length of vertical edges is one less than the number of horizontal edges (including zero-length, as discussed above). Thus,

$$\Delta n_{\text{mixed}} = \delta_{N_1=1} + \delta_{N_k=1} + \delta_{\hat{N}_1=1} + \delta_{\hat{N}_{\hat{k}}=1} - \#\{\text{shared components with label 1}\}, \quad (\text{B.7})$$

which is manifestly self-mirror.

The end of the proof is straightforward: Δn_{mixed} is at most $4 - 1$, with equality if and only if $N_1 = N_k = \hat{N}_1 = \hat{N}_{\hat{k}} = 1$ and the shared boundary has a single connected component with label 1. In particular the horizontal edges corresponding to $N_1 = 1$ and to $N_k = 1$ must belong to the same component so all $N_j = 1$: the theory is abelian. \square

C $T[SU(2)]$ index as holomorphic blocks

As is well-known from the study of 3d $\mathcal{N} = 2$ theories [28, 29, 30] (see also [23] for the $\mathcal{N} = 4$ case), superconformal indices (and various other partition functions) are bilinear combinations of basic building blocks, referred to as (anti)holomorphic blocks, which are partition functions on $\mathcal{D}^2 \times S^1$. We work out here this factorization for $T[SU(2)]$, and then verify that the resulting closed-form expression (C.8) reproduces our expansion of the superconformal index at order $O(q)$. The structure generalizes but we did not find it useful in concrete calculations, because for generic theories this factorized form contains a large number of terms.

The expression for the full superconformal index of $T[SU(2)]$ reads:

$$\mathcal{Z}_{S^2 \times S^1}^{T[SU(2)]} = \frac{(q^{\frac{1}{2}}t; q)_{\infty}}{(q^{\frac{1}{2}}t^{-1}; q)_{\infty}} \sum_{m \in \mathbb{Z}} (q^{\frac{1}{2}}t^{-1})^{|m|} w^m \oint_{S^1} \frac{dz}{2\pi iz} \prod_{p=1}^2 \prod_{\pm} \frac{(t^{-\frac{1}{2}}q^{\frac{3}{4} + \frac{|m|}{2}} z^{\pm} \mu_p^{\mp}; q)_{\infty}}{(t^{\frac{1}{2}}q^{\frac{1}{4} + \frac{|m|}{2}} z^{\mp} \mu_p^{\pm}; q)_{\infty}}, \quad (\text{C.1})$$

where m is the unique monopole charge, and z runs over the unit circle in the classical Coulomb branch \mathbb{C} . The integrand has poles at²¹

$$z = z_{s,j} := \mu_s t^{\frac{1}{2}} q^{\frac{1}{4} + \frac{|m|}{2} + j} \quad \text{and} \quad z = \mu_s (t^{\frac{1}{2}} q^{\frac{1}{4} + \frac{|m|}{2} + j})^{-1} \quad \text{for } s = 1, 2 \text{ and integer } j \geq 0. \quad (\text{C.2})$$

We calculate the index as an expansion in powers of q , hence $|q| < 1$, with $|t| = |\mu_s| = 1$. The poles that we named $z_{s,j}$ thus lie inside the $|z| = 1$ contour and the other poles outside.

To warm up, compute the contribution to $\mathcal{Z}_{S^2 \times S^1}^{T[SU(2)]}$ from the pole at $z_{s,0}$ for $m = 0$:

$$C_s := \prod_{p \neq s} \frac{(q\mu_s\mu_p^{-1}; q)_\infty}{(\mu_s^{-1}\mu_p; q)_\infty} \frac{(q^{\frac{1}{2}}t^{-1}\mu_s^{-1}\mu_p; q)_\infty}{(q^{\frac{1}{2}}t\mu_s\mu_p^{-1}; q)_\infty}. \quad (\text{C.3})$$

Before moving on to other residues, we note that the identity

$$(iq^{\frac{1}{8}}a^{\frac{1}{2}})^{|m|} \frac{(q^{\frac{3}{4} + \frac{|m|}{2}}a; q)_\infty}{(q^{\frac{1}{4} + \frac{|m|}{2}}a^{-1}; q)_\infty} = (iq^{\frac{1}{8}}a^{\frac{1}{2}})^m \frac{(q^{\frac{3}{4} + \frac{m}{2}}a; q)_\infty}{(q^{\frac{1}{4} + \frac{m}{2}}a^{-1}; q)_\infty} \quad (\text{C.4})$$

allows us to replace $|m| \rightarrow m$ throughout (C.1). The resulting expression involves both positive and negative powers of q , which would make our lives harder if we wanted to expand in powers of q , but leads to nicer residues. We compute the contribution from the $z_{s,j}$ pole for any m :

$$\begin{aligned} & \frac{(q^{\frac{1}{2}}t; q)_\infty}{(q^{\frac{1}{2}}t^{-1}; q)_\infty} (q^{\frac{1}{2}}t^{-1}w)^m \prod_{p=1}^2 \frac{(q^{1+j+\frac{|m|+m}{2}}\mu_s\mu_p^{-1}; q)_\infty (q^{\frac{1}{2}-j-\frac{|m|-m}{2}}t^{-1}\mu_s^{-1}\mu_p; q)_\infty}{((q^{-j-\frac{|m|-m}{2}}\mu_s^{-1}\mu_p; q)_\infty)' (q^{\frac{1}{2}+j+\frac{|m|+m}{2}}t\mu_s\mu_p^{-1}; q)_\infty} \\ &= C_s (q^{\frac{1}{2}}t^{-1}w)^{k_+ - k_-} \prod_{p=1}^2 \frac{(q^{\frac{1}{2}}t\mu_s\mu_p^{-1}; q)_{k_+} (q^{\frac{1}{2}-k_-}t^{-1}\mu_s^{-1}\mu_p; q)_{k_-}}{(q\mu_s\mu_p^{-1}; q)_{k_+} (q^{-k_-}\mu_s^{-1}\mu_p; q)_{k_-}} \end{aligned} \quad (\text{C.5})$$

where the prime in the first line denotes the removal of the vanishing factor in the q -Pochhammer symbol for $p = s$, and we then used finite q -Pochhammer $(a; q)_k = (a; q)_\infty / (aq^k; q)_\infty$ and changed variables to $k_\pm := j + \frac{|m| \pm m}{2} \geq 0$. Altogether

$$\mathcal{Z}_{S^2 \times S^1}^{T[SU(2)]} = \sum_{s=1}^2 C_s \prod_{\pm} \left(\sum_{k_\pm \geq 0} (q^{\frac{1}{2}}t^{-1}w^{\pm 1})^{k_\pm} \prod_{p=1}^2 \frac{(q^{\frac{1}{2}}t\mu_s\mu_p^{-1}; q)_{k_\pm}}{(q\mu_s\mu_p^{-1}; q)_{k_\pm}} \right). \quad (\text{C.6})$$

We recognize here the q -hypergeometric series

$${}_2\phi_1 \left[\begin{matrix} a, b \\ c \end{matrix} \middle| q, z \right] := \sum_{k \geq 0} \frac{(a; q)_k (b; q)_k}{(c; q)_k (q; q)_k} z^k. \quad (\text{C.7})$$

In terms of $\mu := \mu_1\mu_2^{-1}$ and $\hat{\mu} := w$

$$\mathcal{Z}_{S^2 \times S^1}^{T[SU(2)]} = \frac{(q\mu; q)_\infty}{(\mu^{-1}; q)_\infty} \frac{(q^{\frac{1}{2}}t^{-1}\mu^{-1}; q)_\infty}{(q^{\frac{1}{2}}t\mu; q)_\infty} \prod_{\pm} \left({}_2\phi_1 \left[\begin{matrix} q^{\frac{1}{2}}t, q^{\frac{1}{2}}t\mu \\ q\mu \end{matrix} \middle| q, q^{\frac{1}{2}}t^{-1}\hat{\mu}^{\pm 1} \right] \right) + (\mu \leftrightarrow \mu^{-1}). \quad (\text{C.8})$$

This is the factorized form of the index. It is possible to show, using complicated identities obeyed by q -hypergeometric series, that this result is mirror-symmetric

²¹At first sight there is also a pole at $z = 0$, but in fact the q -Pochhammer factors tend to zero there.

To compare with the main text we expand in powers of q and organize the series in terms of supercharacters so as to extract the representation content:

$$\begin{aligned} \mathcal{Z}_{S^2 \times S^1}^{T[SU(2)]} &= 1 + q^{\frac{1}{2}} t \chi_3(\mu) + q^{\frac{1}{2}} t^{-1} \chi_3(\hat{\mu}) + q t^2 \chi_5(\mu) + q t^{-2} \chi_5(\hat{\mu}) - q(1 + \chi_3(\mu) + \chi_3(\hat{\mu})) + O(q^{\frac{3}{2}}) \\ &= 1 + \chi_3(\mu) \mathcal{I}_{(1,0)} + \chi_3(\hat{\mu}) \mathcal{I}_{(0,1)} + \boxed{\chi_5(\mu) \mathcal{I}_{(2,0)}} - \mathcal{I}_{(1,1)} + \boxed{\chi_5(\hat{\mu}) \mathcal{I}_{(0,2)}} + O(q^{\frac{3}{2}}) \end{aligned} \quad (\text{C.9})$$

where $\chi_3(\mu) := \mu + 1 + \mu^{-1}$ and $\chi_5(\mu) := \mu^2 + \mu + 1 + \mu^{-1} + \mu^{-2}$ are characters of $SU(2)$, and we used the short-hand notation for the superconformal indices $\mathcal{I}_{(J^H, J^C)} := \mathcal{I}_{B_1[0](J^H, J^C)}(q, t)$. This agrees with eq. (4.32) of section 4.

As explained in the paper the following BPS multiplets can be unambiguously identified:

- 1: the identity;
- $\chi_3(\mu) \mathcal{I}_{(1,0)}$: the $SU(2)$ electric-flavour currents;
- $\chi_3(\hat{\mu}) \mathcal{I}_{(0,1)}$: the $S\hat{U}(2)$ magnetic-flavour currents;
- $\chi_5(\mu) \mathcal{I}_{(2,0)}$: products of two electric currents;
- $\chi_5(\hat{\mu}) \mathcal{I}_{(0,2)}$: products of two magnetic currents;
- $-\mathcal{I}_{(1,1)}$: the energy-momentum tensor multiplet $A_2[0]^{(0,0)}$.

The bottom component $\tilde{Q}^{\bar{p}} Q^r$ of an electric-current multiplet is the product of an antifundamental and a fundamental chiral scalar (the F -term condition imposes $\tilde{Q}^1 Q^1 + \tilde{Q}^2 Q^2 = 0$). Since the gauge group is abelian, $\tilde{Q}^{\bar{p}} Q^r$ has rank 1 hence zero determinant. This removes one of the six products of two electric currents, thus explaining why there are only five such products in (C.9).

Altogether we see that the $T[SU(2)]$ theory has no mixed marginal (or relevant) chiral operators. All exactly-marginal deformations are purely electric or purely magnetic superpotentials. After imposing the D-term conditions the superconformal manifold has dimension $10 - 7 = 3$.

References

- [1] D. Gaiotto and E. Witten, ‘‘S-Duality of Boundary Conditions In N=4 Super Yang-Mills Theory,’’ *Adv. Theor. Math. Phys.* **13** (2009) no.3, 721 [arXiv:0807.3720 [hep-th]].
- [2] A. Hanany and E. Witten, ‘‘Type IIB superstrings, BPS monopoles, and three-dimensional gauge dynamics,’’ *Nucl. Phys. B* **492** (1997) 152 [hep-th/9611230].
- [3] B. Assel, C. Bachas, J. Estes and J. Gomis, ‘‘Holographic Duals of D=3 N=4 Superconformal Field Theories,’’ *JHEP* **1108** (2011) 087 [arXiv:1106.4253 [hep-th]].
- [4] B. Assel, C. Bachas, J. Estes and J. Gomis, ‘‘IIB Duals of D=3 N=4 Circular Quivers,’’ *JHEP* **1212** (2012) 044 [arXiv:1210.2590 [hep-th]].
- [5] W. Cottrell and A. Hashimoto, ‘‘Resolved gravity duals of $\mathcal{N} = 4$ quiver field theories in 2+1 dimensions,’’ *JHEP* **1610** (2016) 057 [arXiv:1602.04765 [hep-th]].
- [6] Y. Lozano, N. T. Macpherson, J. Montero and C. Nunez, ‘‘Three-dimensional $\mathcal{N} = 4$ linear quivers and non-Abelian T-duals,’’ *JHEP* **1611** (2016) 133 [arXiv:1609.09061 [hep-th]].

- [7] C. Bachas, M. Bianchi and A. Hanany, “ $\mathcal{N} = 2$ moduli of AdS_4 vacua: a fine-print study,” JHEP **1808** (2018) 100 Erratum: [JHEP **1810** (2018) 032] [arXiv:1711.06722 [hep-th]].
- [8] C. Cordova, T. T. Dumitrescu and K. Intriligator, “Deformations of Superconformal Theories,” JHEP **1611** (2016) 135 [arXiv:1602.01217 [hep-th]].
- [9] R. G. Leigh and M. J. Strassler, “Exactly marginal operators and duality in four-dimensional $N=1$ supersymmetric gauge theory,” Nucl. Phys. B **447** (1995) 95 [hep-th/9503121].
- [10] B. Kol, “On conformal deformations,” JHEP **0209** (2002) 046 [hep-th/0205141] ; “On Conformal Deformations II,” [arXiv:1005.4408 [hep-th]].
- [11] O. Aharony, B. Kol and S. Yankielowicz, “On exactly marginal deformations of $N=4$ SYM and Type IIB supergravity on $AdS(5) \times S^{*5}$,” JHEP **0206** (2002) 039 [hep-th/0205090].
- [12] S. Benvenuti and A. Hanany, “Conformal manifolds for the conifold and other toric field theories,” JHEP **0508**, 024 (2005) [hep-th/0502043].
- [13] D. Green, Z. Komargodski, N. Seiberg, Y. Tachikawa and B. Wecht, “Exactly Marginal Deformations and Global Symmetries,” JHEP **1006** (2010) 106 [arXiv:1005.3546 [hep-th]].
- [14] S. de Alwis, J. Louis, L. McAllister, H. Triendl and A. Westphal, “Moduli spaces in AdS_4 supergravity,” JHEP **1405** (2014) 102 [arXiv:1312.5659 [hep-th]].
- [15] C. Bachas and I. Lavdas, “Quantum Gates to other Universes,” Fortsch. Phys. **66** (2018) no.2, 1700096 [arXiv:1711.11372 [hep-th]]; “Massive Anti-de Sitter Gravity from String Theory,” JHEP **1811** (2018) 003 [arXiv:1807.00591 [hep-th]].
- [16] C. Bachas, “Massive AdS Supergravitons and Holography,” [arXiv:1905.05039 [hep-th]].
- [17] C. Cordova, T. T. Dumitrescu and K. Intriligator, “Multiplets of Superconformal Symmetry in Diverse Dimensions,” JHEP **1903** (2019) 163 [arXiv:1612.00809 [hep-th]].
- [18] A. Hanany and N. Mekareeya, “Complete Intersection Moduli Spaces in $N=4$ Gauge Theories in Three Dimensions,” JHEP **1201** (2012) 079 [arXiv:1110.6203 [hep-th]].
- [19] S. Cremonesi, A. Hanany and A. Zaffaroni, “Monopole operators and Hilbert series of Coulomb branches of $3d \mathcal{N} = 4$ gauge theories,” JHEP **1401** (2014) 005 [arXiv:1309.2657 [hep-th]].
- [20] S. Cremonesi, A. Hanany, N. Mekareeya and A. Zaffaroni, “ $T_\rho^\sigma(G)$ theories and their Hilbert series,” JHEP **1501** (2015) 150 [arXiv:1410.1548 [hep-th]].
- [21] S. Cremonesi, A. Hanany, N. Mekareeya and A. Zaffaroni, “Coulomb branch Hilbert series and Hall-Littlewood polynomials,” JHEP **1409** (2014) 178 [arXiv:1403.0585 [hep-th]].
- [22] S. Cremonesi, “3d supersymmetric gauge theories and Hilbert series,” Proc. Symp. Pure Math. **98** (2018) 21 [arXiv:1701.00641 [hep-th]].
- [23] S. S. Razamat and B. Willett, “Down the rabbit hole with theories of class \mathcal{S} ,” JHEP **1410** (2014) 99 [arXiv:1403.6107 [hep-th]].
- [24] S. Cremonesi, N. Mekareeya and A. Zaffaroni, “The moduli spaces of $3d \mathcal{N} \geq 2$ Chern-Simons gauge theories and their Hilbert series,” JHEP **1610** (2016) 046 [arXiv:1607.05728 [hep-th]].

- [25] F. Carta and H. Hayashi, “Hilbert series and mixed branches of $T[SU(N)]$ theory,” JHEP **1702** (2017) 037 [arXiv:1609.08034 [hep-th]].
- [26] E. Witten, “Multitrace operators, boundary conditions, and AdS / CFT correspondence,” [hep-th/0112258].
- [27] M. Berkooz, A. Sever and A. Shomer, “Double trace’ deformations, boundary conditions and space-time singularities,” JHEP **0205** (2002) 034 [hep-th/0112264].
- [28] S. Pasquetti, “Factorisation of $N = 2$ Theories on the Squashed 3-Sphere,” JHEP **1204** (2012) 120 [arXiv:1111.6905 [hep-th]].
- [29] T. Dimofte, D. Gaiotto and S. Gukov, “3-Manifolds and 3d Indices,” Adv. Theor. Math. Phys. **17** (2013) no.5, 975 [arXiv:1112.5179 [hep-th]].
- [30] C. Beem, T. Dimofte and S. Pasquetti, “Holomorphic Blocks in Three Dimensions,” JHEP **1412** (2014) 177 [arXiv:1211.1986 [hep-th]].
- [31] T. Okazaki, “Mirror symmetry of 3d $\mathcal{N} = 4$ gauge theories and supersymmetric indices,” [arXiv:1905.04608 [hep-th]].
- [32] V. Borokhov, A. Kapustin and X. k. Wu, “Topological disorder operators in three-dimensional conformal field theory,” JHEP **0211** (2002) 049 [hep-th/0206054] ; “Monopole operators and mirror symmetry in three-dimensions,” JHEP **0212** (2002) 044 [hep-th/0207074].
- [33] V. Borokhov, “Monopole operators in three-dimensional $N=4$ SYM and mirror symmetry,” JHEP **0403** (2004) 008 [hep-th/0310254].
- [34] J. Bhattacharya, S. Bhattacharyya, S. Minwalla and S. Raju, “Indices for Superconformal Field Theories in 3,5 and 6 Dimensions,” JHEP **0802** (2008) 064 [arXiv:0801.1435 [hep-th]].
- [35] S. Kim, “The Complete superconformal index for $N=6$ Chern-Simons theory,” Nucl. Phys. B **821** (2009) 241 Erratum: [Nucl. Phys. B **864** (2012) 884] [arXiv:0903.4172 [hep-th]].
- [36] Y. Imamura and S. Yokoyama, “Index for three dimensional superconformal field theories with general R-charge assignments,” JHEP **1104** (2011) 007 [arXiv:1101.0557 [hep-th]].
- [37] C. Krattenthaler, V. P. Spiridonov and G. S. Vartanov, “Superconformal indices of three-dimensional theories related by mirror symmetry,” JHEP **1106**, 008 (2011) [arXiv:1103.4075 [hep-th]].
- [38] A. Kapustin and B. Willett, “Generalized Superconformal Index for Three Dimensional Field Theories,” [arXiv:1106.2484 [hep-th]].
- [39] F. Benini and W. Peelaers, “Higgs branch localization in three dimensions,” JHEP **1405** (2014) 030 [arXiv:1312.6078 [hep-th]].
- [40] B. Willett, “Localization on three-dimensional manifolds,” J. Phys. A **50** (2017) no.44, 443006 [arXiv:1608.02958 [hep-th]].
- [41] F. A. Dolan, “On Superconformal Characters and Partition Functions in Three Dimensions,” J. Math. Phys. **51** (2010) 022301 [arXiv:0811.2740 [hep-th]].
- [42] J. Distler, B. Ergun and F. Yan, “Product SCFTs in Class-S,” [arXiv:1711.04727 [hep-th]].

- [43] S. S. Razamat and G. Zafrir, “Exceptionally simple exceptional models,” JHEP **1611** 061 (2016) [arXiv:1609.02089 [hep-th]].
- [44] M. Fazzi, A. Lanir, S. S. Razamat and O. Sela, “Chiral 3d SU(3) SQCD and $\mathcal{N} = 2$ mirror duality,” JHEP **1811** 025 (2018) [arXiv:1808.04173 [hep-th]].
- [45] C. Bachas, M. R. Douglas and C. Schweigert, “Flux stabilization of D-branes,” JHEP **0005** (2000) 048 [hep-th/0003037].
- [46] I. Tamm, “Die verallgemeinerten Kugelfunktionen und die Wellenfunktionen eines Elektrons im Felde eines Magnetpoles,” Z. Phys. **71** (1931) no.3-4, 141; T. T. Wu and C. N. Yang, “Dirac Monopole Without Strings: Monopole Harmonics,” Nucl. Phys. B **107** (1976) 365.
- [47] C. Bachas, C. Bunster and M. Henneaux, “Dynamics of Charged Events,” Phys. Rev. Lett. **103** (2009) 091602 [arXiv:0906.4048 [hep-th]].
- [48] J. M. Maldacena and A. Strominger, “AdS(3) black holes and a stringy exclusion principle,” JHEP **9812** (1998) 005 [hep-th/9804085].
- [49] P. Di Francesco, P. Mathieu and D. Senechal, “Conformal Field Theory,” Springer 1997.
- [50] J. McGreevy, L. Susskind and N. Toumbas, “Invasion of the giant gravitons from Anti-de Sitter space,” JHEP **0006** (2000) 008 [hep-th/0003075].
- [51] J. Louis and H. Triendl, “Maximally supersymmetric AdS₄ vacua in $\mathcal{N} = 4$ supergravity,” JHEP **1410**, 007 (2014) [arXiv:1406.3363 [hep-th]].