

Conformal Field Theory in $D > 2$ dimensions, representations and harmonic analysis

Gerhard Mack

II. Institut für Theoretische Physik
der Universität Hamburg

talk presented at the conference on
Representation Theory and Harmonic Analysis
at Paris Saclay 5 December 2018

1 Plan of the talk

- Summary of what happened since 1968
(when I first met Ivan Todorov)
- The relation between representation theory and harmonic analysis for groups $SO(D, 2)$ and $SO(D + 1, 1)$
i.e. a group theoretical version of the familiar relation between field theory in Minkowski and Euklidean space
- recent developments: Are we close to the *analytic* solution of the 3-dimensional (conformal) Ising model?

The second point is important: positions and residues of poles in the partial wave amplitude $g(\chi = [l, \delta])$ which is obtained by partial wave analysis of the **Euklidean** 4-point Green functions are restricted by the requirement that they are associated with unitary positive energy ray representations of the **Minkowskian** conformal group $SO(D, 2)$.

And it can also be a source of interesting mathematics.

2 What happened since 1968?

I met Ivan Todorov in 1968 at the ICTP Trieste. I had been invited by Abdus Salam, who had studied my PhD-thesis on dilatation- and conformal

symmetry [1] of February 1967. The collaboration with Abdus Salam resulted in a joined paper [2]. Abdus Salam also pointed out Dirac's early work on conformal symmetry [3] which introduced the conformal covariant description of ($D = 4$ -dimensional) space time using lightlike $D + 2$ - vectors ξ

Ivan had worked at the research center in Dubna in the USSR, which also hosted scientist from Bulgaria and other states of the Warsaw pact. It was Ivans first visit to the west. We began our collaboration on conformal symmetry with a paper [4] on the ladder representation of the conformal group $SO(4, 2)$. This is a unitary positive energy representation which also serves to label the states of the H -atom.

We agreed to meet again at the Vienna conference on High Energy physics that year. Shortly before the conference, the Soviet Union's troops invaded Czechoslovakia, and I got worried whether Ivan would come. But never before had there been so many scientists from eastern Europe at a conference in the west. I met Ivan and our paper got finished and published.

This was the beginning of a collaboration lasting 25 years. Our next paper demonstrated freedom of Conformal invariant Green functions from ultraviolet divergences [5]

Wilson's 1969 paper on operator product expansions (OPE) [11] cited me honorably and created a burst of activities:

Polyakov [12] (1970), Migdal [13](1971), d'Eramo, Parisi and Peliti [15, 16] (1971), Symanzik [23, 24, 25] (1971), Ferrara, Gatto and Grillo, [20, 19] (1972), same and Parisi [17] (1972), Tonin et al.[14], Brezin, Itzykson, Zuber and Zinn Justin.

I began working on a group theoretical approach to conformal field theory in 1972. It used group representation theory and harmonic analysis on groups in the spirit of Eugen Wigner [21, 22, 26].

The work was completed by Dobrev, Petkova, Petrova and Todorov [30] and published jointly as a book [31]: *Harmonic Analysis on the n -dimensional Lorentz Group and its Application to Conformal Quantum Field Theory*, Lecture Notes in Physics **63**, Springer 1977

I had met Eugen Wigner at the University of Princeton. My PhD adviser Hans Kastrup had been invited by Wigner who had studied Kastrup's papers on conformal symmetry [6, 7] This visit resulted in further papers on the subject [8]. Hans Kastrup paved the way to my visit. The visit was financed by the Studienstiftung des Deutschen Volkes.

To prepare, I had studied Wigner's book on group theory in quantum mechanics. He became my hero and influenced my work until now

Eugen Wigner and his wife invited Arthur Jaffe and me to a long weekend in their winter home in Vermont. And I met him repeatedly again later on. At the conference of Nobel Laureates in Trieste which was organized by

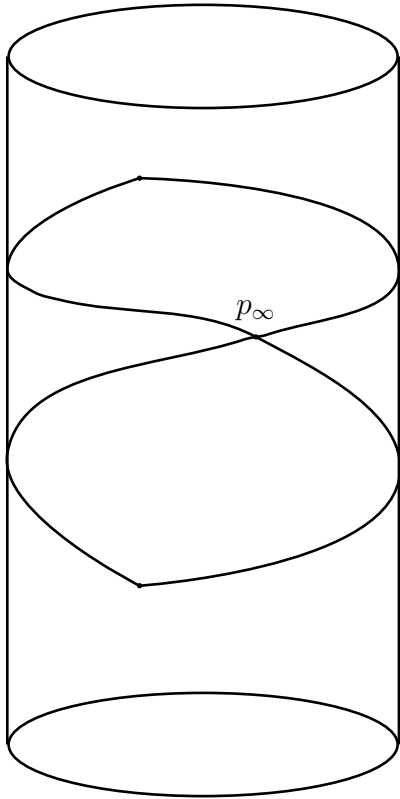

Figure 1: The universal covering \tilde{M} of conformally compactified Minkowski space time is a tube with point(s) p_∞ at spatial infinity of Minkowski space located on the back of the tube. The boundary of Minkowski space passes through it. The two corner points of the boundary of Minkowski space are on the front of the tube.

Abdus Salam. And during later visits in Princeton. The last encounter was at the conference in Baltimore which celebrated Wigners 90th birthday. Arthur Jaffe was also there. A greeting message by Abdus Salam was presented in which he explained how much he had learned from Wigner.

In this talk I will only speak about conformal field theory in more than 2 dimensions. A major breakthrough in 2-dimensional conformal field theory occurred in 1984 with the paper [9] of Belavin, Polyakov and Zamolodchikov on *Infinite conformal symmetry in two-dimensional quantum field theory*. Lüscher and myself had discovered before [10] that the 2-dimensional traceless stress energy tensor is a Lie field; they also found the bound $c \geq 1/2$ on the coefficient of the central term. This paper remained unpublished, but I presented it at a seminar in Copenhagen which Polyakov attended.

3 The space time manifold \tilde{M}

Conformal field theory satisfies locality [29].

It lives on the infinite sheeted covering \tilde{M} - a tube (Figure 1) - of Minkowski space which admits a conformal invariant causal structure. Minkowski space is imbedded into \tilde{M} and is characterized by its point(s) at spatial infinity p_∞ .

3.1 Lagrangean approach

There exists a coupled set of integral equations for all the n-point functions of ϕ^3 -theory [23]. They can also be used for ϕ^4 -theory by considering it as a theory with the fundamental fields $\phi(x)$ and $:\phi^2:(x)$. The equations for propagator and 3-vertex require renormalization; renormalized versions have been derived in the 60's [23]. The 4-point function furnishes also the Bethe Salpeter kernel.

3.2 Bethe-Salpeter equations \mapsto define kernels

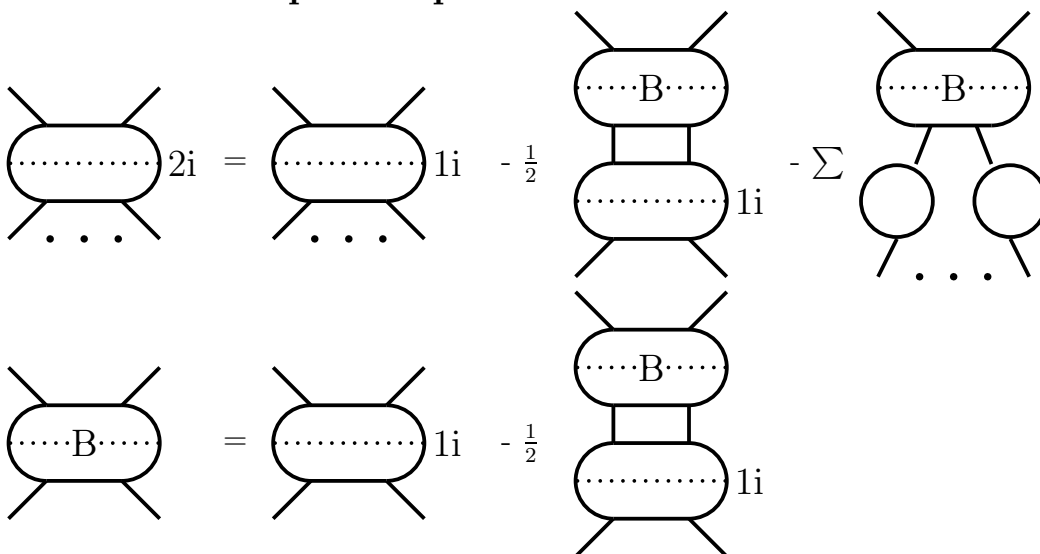

The 1-particle irreducible graphs are obtained by subtracting Born terms.

3.3 Dynamical equations

for ϕ^3 -theory; can be generalized to ϕ^4 -theory by considering fields ϕ and $:\phi^2:$

The equations for $n \geq 3$ can be solved iteratively by skeleton graph expansions, producing also skeleton graph expansions for the Bethe Salpeter kernel. After that it remains to solve the renormalized Schwinger Dyson equations for 3-vertex and propagator:

The equation for the inverse propagator is actually equivalent to an equation for the 3-point function of the stress energy tensor [25].

3.4 Skeleton graph expansions

The equations for $n \geq 4$ point functions can be solved iteratively, producing skeleton graph expansions for Green functions and also for the Bethe Salpeter kernel [25]:

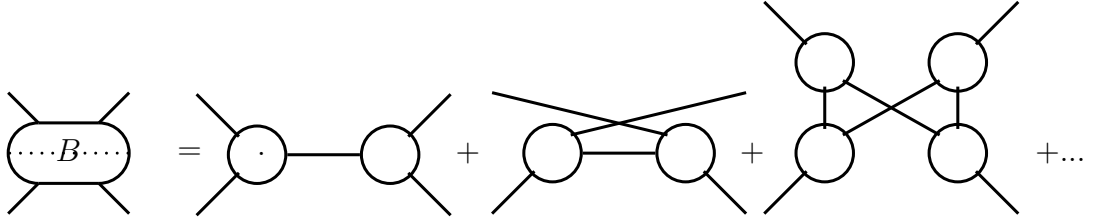

In ϕ^4 -theory, Born terms involve ϕ^2 : propagators

3.5 ϵ -expansions

In $D = 6 + \epsilon$ dimensions for φ^3 -theory (and in $D = 4 - \epsilon$ dimensions for ϕ^4 -theory), the dressed vertices are of order ϵ . Therefore only a finite number of skeleton graphs contribute to any order in ϵ . Inserting into the equations for dressed vertex and propagator, these can be solved by power series expansion in ϵ . For ϕ^3 -theory in $6 + \epsilon$ dimensions one finds to leading orders [26]: The fundamental field ϕ has dimension

$$d = \frac{D}{2} - 1 + \Delta, \quad \Delta = \frac{1}{18}\epsilon + \dots$$

and a trajectory of traceless symmetric tensor fields of even rank $s \geq 2$ with dimension $d_s = D - 2 + s + \sigma_s$,

$$\frac{1}{2}\sigma_s = \left[\frac{1}{18} - \frac{2}{3(s+2)(s+1)} \right] \epsilon + \dots$$

4 The relation between representations and harmonic analysis for covering groups of $SO(D, 2)$ and $SO(D + 1, 1)$

Basic: Elementary representations $\chi = [l, \delta]$ **are representations of the complex Lie algebra**. Partial wave amplitudes $g(\chi)$ depend on χ . Their use is a crucial feature of the group theoretical approach [21, 22, 26, 30, 31]. The (partial) equivalence of representations $\chi = [l, \delta]$ and $\tilde{\chi} = [\tilde{l}, D - \delta]$ ($\tilde{l} = l$ for completely symmetric tensor representations) is the basis of the shadow operator formalism introduced by Ferrara et al. [20]

4.1 Euclidean partial wave expansion

for the 4-point function $\langle \phi(x_4) \dots \phi(x_1) \rangle$.

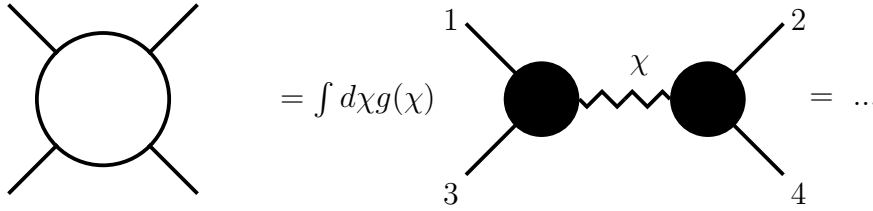

Figure 2: Eukclidean partial wave expansion for the 4-point function $\langle \phi(x_4)\dots\phi(x_1) \rangle$. The dots stand for expansions in the two other channels (12) \mapsto (34) and (13) \mapsto (24) of the same amplitude, implying the equality shown in section 4.2

This formula *is quite trivial, simply expressing the orthogonality* (and completeness!) *of the partial waves* say Simmons-Duffin, Stanford, and Witten [41].

indeed: Physical positivity implies constraints on the partial waves $g(\chi)$! But also completeness is not trivial, because presence of a Born term requires contributions from the *complementary* series in addition to the *principal* series.

They can be included by choosing a proper path of the c -integration

$$\int d\chi\dots = \sum_l \int_C dc \rho_l(c)\dots, \quad \chi = [l, \frac{1}{2}D + c]$$

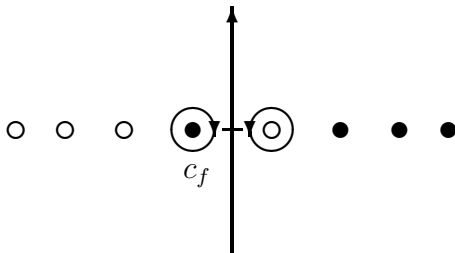

a) Path C of the c -integration for $l = 0$

Positivity constraints were examined already in the 70's. They restrict the position of the poles and fix the sign of of the residues of the partial wave amplitudes $g(\chi)$ defined by

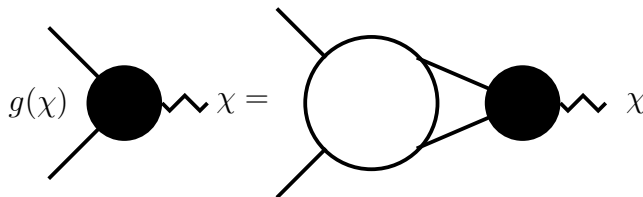

4.2 Crossing relations

$$\int d\chi g(\chi) \text{ (diagram)} = \int d\chi' g(\chi') \text{ (diagram)}$$

The crossing relation is a linear relation for the partial wave, of the form

$$g(\chi) = \int d\chi' C(\chi', \chi) g(\chi').$$

Using orthogonality of the CG-kernels, the crossing kernel $C(\chi, \chi')$ is defined by

$$C(\chi, \chi') = \frac{1}{2} \text{ (diagram)}$$

4.3 Derivation of Operator product expansions from Euklidean partial wave expansions

4.3.1 Split of the partial waves

Operator product expansions (OPE) have the structure

$$\phi^1(-\frac{1}{2}x_1)\phi^2(\frac{1}{2}x_1) = \sum_n C_n(x_1)O^n(0)$$

where O^n are fields or derivatives of fields. The derivatives of each nonderivative field can be summed up. The resulting terms are known as **conformal blocks**. To obtain this expansion, **the Clebsch Gordan coefficients need to be split.**

$$\text{ (diagram)} = \text{ (diagram)} + \text{ (diagram)}$$

This split exploits the equivalence of representations $\chi = [l, h+c]$ and $\tilde{\chi} = [l, h-c]$ ($h = \frac{1}{2}D$) of the Euklidean conformal group to split the three point function into Clebsch-Gordan kernels of the second kind in a way modeled after the split of Legendre functions P_l into Legendre functions of the second kind, Q_l ,

$$\mathfrak{A}(\mathbf{x}_0, \tilde{\chi}, \mathbf{x}_2, \chi_2, \mathbf{x}_1, \chi_1) = \frac{\pi}{\sin(l+c)} [\mathfrak{Q}(\mathbf{x}, \tilde{\chi}, \mathbf{x}_2, \chi_2, \mathbf{x}_1, \chi_1) - \int d^D \mathbf{y} \Delta^{\tilde{\chi}}(\mathbf{x}, \mathbf{y}) \mathfrak{Q}(\mathbf{y}, \chi, \mathbf{x}_2, \chi_1, \mathbf{x}_1, \chi_2)]$$

such that the partial Fourier transform $\mathfrak{Q}(p, \tilde{\chi}, \mathbf{x}_2, \chi_2, \mathbf{x}_1, \chi_1)$ is an entire holomorphic function of p .

4.4 Continuation to Minkowski apace

After the split, one can deform the path of the c -integration in the partial wave expansion involving $g(\chi)$, $\chi = [l, h+c]$, $h = D/2$ picking up a sum over residues as shown in the following picture

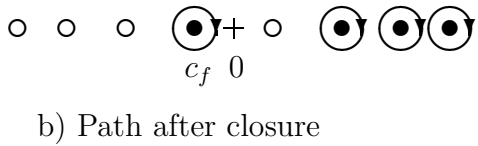
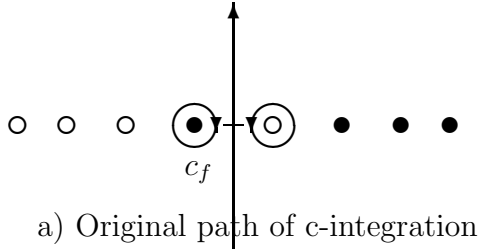

This results in a discrete sum of conformal blocks as shown before, i.e. the expected OPE.

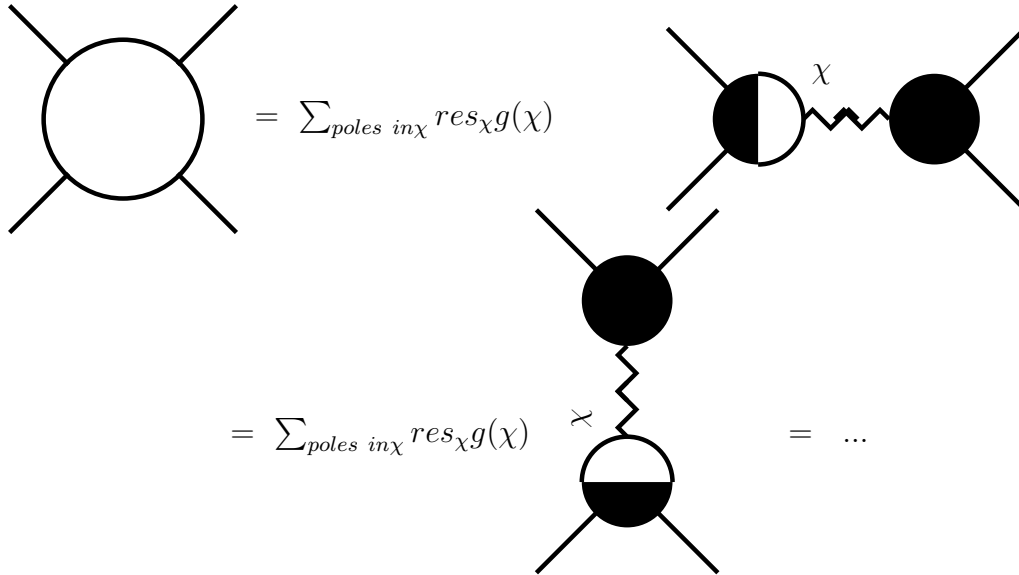

Figure 3: discrete version of the crossing relation for partial wave $g(\chi)$

5 Recent progress

5.1 Conformal Regge theory

Families of poles of the partial wave $g(\chi = [l, \delta])$ labelled by (even or odd) l are analogues of Regge trajectories [33, 45, 42]. But in contrast to conventional Regge theory the pole “approximation” is exact!

5.2 Analysis of the conformal blocks

Dolan and Osborn [36] determined the conformal blocks for even dimension D . Recursion relations were studied by Penedones, Trevisani and Yamazaki [46]

El-Showk, Paulos, Poland, Rychkov, Simmons-Duffin, Vichi [37] generalized the result to arbitrary D and use numerical evaluation to bound and find critical indices for the **Ising model**

5.3 Mellin representation

I proposed to consider bootstrap in Mellin space in 2009 [33]. The Mellin representation was advocated as a natural language by Fitzpatrick, Kaplan,

$$\begin{aligned}
 & \text{Circle with 4 external lines} = \int d\chi g(\chi) \text{ [Two black circles connected by wavy line } \chi \text{, 2 external lines each]} \\
 & = \int d\delta M(\{\delta_{ij}\}) \text{ [Square with X]}
 \end{aligned}$$

Figure 4: Partial wave expansion and Mellin representation for the 4-point function $\langle \phi(x_4) \dots \phi(x_1) \rangle$. The lines in the Mellin representation represent propagators $\Gamma(\delta_{ij})(\xi_i \xi_j)^{-\delta_{ij}}$ in covariant language. Integration is over $\delta_{ij} = \delta_{ji}$ such that $\sum_i \delta_{ij} = d_i$ when the scalar field $\phi(x_i)$ has dimension d_i .

Penedones, Raju and van Rees [47] and further studied by Dey, Ghosh and Sinha [44](2018)

The lines in the Mellin representation represent propagators $\Gamma(\delta_{ij})(\xi_i \xi_j)^{-\delta_{ij}}$ in Dirac's covariant language. Integration is over $\delta_{ij} = \delta_{ji}$ such that $\sum_i \delta_{ij} = d_i$ when the scalar field $\phi(x_i)$ has dimension d_i .

5.4 Pismaks simplified version of the crossing relation

Pismak [43] proposed to study a simplified version of the crossing relation for the partial wave $g(\chi)$ as shown in Figure 5.

$$\begin{aligned}
 & \text{Diagram 1} = \int g(\chi) \text{ [Diagram 2]} \\
 & = \int g(\chi') \text{ [Diagram 3]}
 \end{aligned}$$

Figure 5: Pismaks version of the crossing symmetry of the partial wave $g(\chi)$. In the Ising model with fields $\phi(x)$ and $\phi^2(x)$, $g(\chi)$ is a 2×2 matrix.

5.5 Spacetime derivation of the Lorentzian OPE inversion formula

Caron-Huot [35], and Simmons-Duffin, Stanford, Witten [41] derive a formula for the partial wave $g(\chi = [\Delta, J]) = n_{\Delta, J} I_{\Delta, J}$ expressed in terms of vacuum vacuum expectation value of commutators of the four scalar fields $\phi_i(x_i)$ of dimension d_i in Minkowski space, $n_{\Delta, J}$ is an explicitly given normalization factor

$$\begin{aligned}
I_{\Delta, J} = & -\hat{C}_J(1) \left[\int_{3>1, 2>4} \frac{d^D x_3 d^D x_4}{\text{vol}(SO(D-1))} \right. \\
& \frac{\langle \Omega, [\phi_4(x_4), \phi_2(x_2)] [\phi_1(x_1), \phi_3(x_3)] | \Omega \rangle}{|x_{34}|^{J+2D-d_3-d_4-\Delta}} \\
& (m \cdot x_{34})^J \theta(m \cdot x_{34}) \\
& + (-1)^J \int_{4>1, 2>3} \frac{d^D x_3 d^D x_4}{\text{vol}(SO(D-1))} \\
& \frac{\langle \Omega | [\phi_3(x_3), \phi_2(x_2)] [\phi_1(x_1), \phi_4(x_4)] | \Omega \rangle}{|x_{34}|^{J+2D-d_3-d_4-\Delta}} \\
& \left. (-m \cdot x_{34})^J \theta(-m \cdot x_{34}) \right]
\end{aligned}$$

where m is the nullvector $m^\mu = (1, 1, 0, \dots, 0)$ where the second component is the time direction, and coordinates x_1, x_2 have been fixed to $x_1 = (1, 0, 0, \dots)$, $x_2 = 0$. The notation $i > j$ means that x_i is in the future light cone of x_j .

An explicit expression for $\hat{C}_J(1)$ is given.

The formula has the following advantages: It can be **analytically continued in the spin J** , and for real dimension and spin, the integrand satisfies **positivity conditions**.

References

- [1] G. Mack, *Partially Conserved Dilatation Current*, PhD thesis, Bern (Switzerland) 1967
- [2] G. Mack, Abdus Salam, *Finite Component Field Representations of the Conformal Group*, Ann. Phys (N.Y.) **26B**, 515 (1969)
- [3] P.A.M. Dirac, *Wave equations in conformal space*, Ann. Math. **37** 429 (1936)
- [4] G. Mack, I.T. Todorov, *Irreducibility of the ladder representation of $U(2, 2)$ when restricted to the Poincaré subgroup* J. Math. Phys. **10** (1969) 2078

- [5] G. Mack, I.T. Todorov, *Conformal invariant Green functions without ultraviolet divergences* Phys. Rev **D8** 1764 (1971)
- [6] H.A. Kastrup *Zur physikalischen Deutung und darstellungstheoretischen Analyse der konformen Transformationen von Raum und Zeit*, Ann . Physik **9** 383 (1962)
- [7] H.A. Kastrup, *Konsequenzen der Dilatationsgruppe bei hohen Energien*, Nucl. Phys **58** 561 (1964)
- [8] H.A. Kastrup, *Conformal Group in Space Time* Phys. Rev. **142** 1060 (1966), *Position Operators, Gauge Transformations and the Conformal Group*, Phys. Rev. **143** 1021 (1966), *Gauge Properties of Minkowski Space*, Phys. Rev. **150** 1183 (1966)
- [9] A.A. Belavin, A.M. Polyakov, A.B. Zamolodchikov, *Infinite Conformal Symmetry in Two-dimensional Quantum Field Theory*, Nucl. Phys. **B241** 333-340 (1984)
- [10] M. Lüscher, G. Mack, *The energy momentum tensor of critical field theories in 1 + 1 dimensions* (1977) unpublished manuscript
- [11] K. Wilson, *Non-Lagrangian models in current algebra* Phys. Rev. **179** 1499 (1969)
- [12] A.M. Polyakov, *A similarity hypothesis in strong interactions I: Multiple hadron production in e^+e^- annihilation*, Soviet Physics JETP **32** (1971) 296, *II: Cascade production of hadrons and their energy distribution associated with e^+e^- annihilation*, Soviet physics JETP **33**, 850 (1971)
- [13] A.A. Migdal, *Conformal invariance and bootstrap* Phys. Lett **37B** 386 (1971), *On hadronic interactions at small distances* Phys. Letters **37B** 98 (1971)
- [14] L. Bonora, S. Ciccariello, S. Sartori, M. Tonin, *Conformal Symmetry in Wilson operator product expansions*, in: *Scale and Conformal Symmetry in Hadron Physics*, ed. R. Gatto, Wiley, N.Y. 1973
- [15] G. Parisi, L. Peliti, *Calculation of critical indices* Lett. Nuovo Cimento **2** 386 (1971)
- [16] *Theoretic prediction for critical exponents at the λ -point of Bose liquids*, Nuovo Cim. Lett. **2** 878 (1971)

- [17] S.Ferrara, R.Gatto, A.F.Grillo, G. Parisi, *The shadow operator formalism for conformal algebra. Vacuum expectation values and operator products*, Lett. Nuovo Cimento, **4**, 115 (1972)
- [18] S. Ferrara, A.F. Grillo, G. Parisi, R. Gatto, *Covariant expansion of the conformal four-point function*, Nucl. Phys. **B 49** 77 (1972)
- [19] S. Ferrara, A.F. Grillo, R. Gatto, *Conformal algebra in space time and operator product expansions* Springer Tracts in Modern Physics, Springer 1973 *Tensor representations of conformal algebra and conformally covariant operator product expansions*, Ann. Phys. (N.Y.) **76**, 161 (1973)
- [20] S. Ferrara, R. Gatto, A.F. Grillo, Lett. Nuovo Cim. **2** (1971) 1363, Nucl. Phys. **B34** (1971)349, Nuov. Cim. **A12** (1972) 952
- [21] G. Mack, *Group theoretical approach to conformal invariant quantum field theory*, Journal de Physique **34** C1 (Suppl. No 10) 99 (1973)
- [22] G. Mack, *Osterwalder Schrader positivity in conformal invariant quantum field theory*, in H. Rollnik and K. Dietz (eds), *Trends in elementary particle theory* Lecture notes in physics **37** 66, (1975)
- [23] K. Symanzik, *Green functions method and renormalization of renormalizable quantum theory*, in: *Lectures in High Energy Physics*, ed. B. Jaksic, Zagreb, 485 (1961) Gordon and Breach, N.Y. 1965
- [24] K. Symanzik, *On calculations in conformal invariant field theories*, Nuovo Cim. Lett. **3**,734 (1972)
- [25] G. Mack, K. Symanzik, *Currents, stress energy tensor and generalized unitarity in conformal quantum field theory* **27** 247 (1971)
- [26] G. Mack, *Conformal invariance and short distance expansion in quantum field theory*, in *Strong interaction physics* Lecture notes in physics **17** Springer Verlag 1972
- [27] G. Mack, *Group theoretical approach to conformal invariant quantum field theory*, in E.R.Caianello (ed) *Renormalization and invariance in quantum field theory*, Plenum Press (New York) 1974
- [28] M. Lüscher, *Operator expansions on the vacuum in conformal quantum field theory*, Commun. Math. Phys. **50** 23-52 (1976)
- [29] M. Lüscher, G. Mack, *Global conformal invariance*, Commun Math. Phys **41** (1975) 203

- [30] V.K. Dobrev, V.B. Petkova, S. Petrova, I.T. Todorov, *Dynamical Derivation of Vacuum Operator Product Expansions in Euclidean Conformal Quantum Field Theory*, Phys. Rev. **D13** (1976) 887
- [31] V.K. Dobrev, G. Mack, V.B. Petkova, S. Petrova, I.T. Todorov, *Harmonic analysis on the n -dimensional Lorentz group and its application to conformal quantum field theory* Lecture notes in physics, Springer 1977
V.K. Dobrev, G. Mack, V.B. Petkova, S. Petrova, I.T. Todorov, *On Clebsch Gordan expansions for the Lorentz Group in n dimensions*, Reports on Math. Phys. 9:29 (1976)
- [32] E.S. Fradkin, M. Ya. Palchik, *Method of solving conformal models in d -dimensional space, secondary fields in $d > 2$ and the solution of two-dimensional models*, Int. J. Mod. Phys **A13** 4837-4888, 1998
- [33] G. Mack, *D -independent representation of Conformal Field Theories in D dimensions via transformation to auxiliary Dual Resonance Models*, arxiv:090/240 (2009)
- [34] D. Pappadopoulous, S. Rychkov, J. Espin, R. Rattazi, *OPE Convergence in Conformal Field Theory* Phys. Rev. **D86** (2012) 105043, arxiv: 1208.6449
- [35] S. Caron-Huot, *Analyticity in Spin in Conformal Theories*, arXiv:1703.00278
- [36] F.A. Dolan, H. Osborn, *Conformal Partial Waves: Further Mathematical Results*, arxiv:1108:6104
- [37] S. El-Showk, M.F. Paulos, D. Poland, S. Rychkov, D. Simmons-Duffin, A. Vichi *Solving the 3D Ising model with the conformal bootstrap*, arXiv:1203.6064 (2012)
- [38] M. Hogervorst, S. Rychkov, *Radial coordinates for conformal blocks*, arxiv:303.1111 (203)
- [39] M. Hogervorst, S. Rychkov, *Radial Coordinates for Conformal Blocks* Phys. Rev. **D87** (2013) 106004 arxiv: 1610.05308
- [40] D. Simmons-Duffin, *Projectors, Shadows, and Conformal Blocks*, JHEP **04** (2014) 146, arXiv:1204.3894
- [41] D. Simmons-Duffin, D. Stanford, E. Witten, *A spacetime derivation of the Lorentzian OPE inversion formula*, arXiv:1711.03816 (Nov 2017)

- [42] D. Simmons-Duffin, *The lightcone bootstrap and the structure of the 3d Ising CFT*, JHEP 03 (2017) 086, arxiv:612.0847
- [43] Yu. M. Pis'mak, *Renormalization group and infinite algebraic structure in D-dimensional conformal field theory*, J. Phys.A:Math.Gen **39** (2006) 857-817
- [44] P. Dey, K. Ghosh, A. Sinha, *Simplifying large spin bootstrap in Mellin space*, arxiv:11709.06110
- [45] M.S. Costa, V. Goncalves, J. Penedones, *Conformal Regge Theory*, JHEP (2012) 091 , arXiv:1209.4355
- [46] J. Penedones, E. Trevisani, M. Yamazaki, *Recursion relations for Conformal Blocks* arXiv:1509.00428
- [47] A. Liam Fitzpatrick, J. Kaplan, J. Penedones, S. Raju, C. van Rees, *A natural language for AdS/CFT correlators*, arXiv:1107.1499