

SKEIN MODULES FROM SKEW HOWE DUALITY AND AFFINE EXTENSIONS

HOEL QUEFFELEC

ABSTRACT. We show that we can release the rigidity of the skew Howe duality process for \mathfrak{sl}_n knot invariants by rescaling the quantum Weyl group action, and recover skein modules for web-tangles. This skew Howe duality phenomenon can be extended to the affine \mathfrak{sl}_m case, corresponding to looking at tangles embedded in a solid torus. We investigate the relations between the invariants constructed by evaluation representations (and affinization of them) and usual skein modules, and give tools for interpretations of annular skein modules as sub-algebras of intertwiners for particular $U_q(\mathfrak{sl}_n)$ representations. The categorification proposed in [26] also admits a direct extension in the affine case.

INTRODUCTION

Webs and skew-Howe duality. Cautis, Kamnitzer and Licata [5, 4] recently introduced a reformulation of the \mathfrak{sl}_n Reshetikhin-Turaev invariants for knots and links based on the *quantum skew Howe duality*. This duality phenomenon involves two commuting actions of $U_q(\mathfrak{sl}_m)$ and $U_q(\mathfrak{sl}_n)$ on the quantum exterior algebra $\bigwedge_q(\mathbb{C}^n \otimes \mathbb{C}^m)$, where n corresponds to the \mathfrak{sl}_n -invariants we look at, and m governs the braiding of m -fold tensor products of \mathfrak{sl}_n -representations. In this framework, braidings arise from the so-called *quantum Weyl group action* [27, 14] on $U_q(\mathfrak{sl}_m)$.

This new process is naturally related to the concept of *webs*, which emerge from the study of \mathfrak{sl}_n knot invariants and describe intertwiners of \mathfrak{sl}_n -representations (see [24, 23, 31] for detailed studies of the spider categories they form). For each n , \mathfrak{sl}_n webs are trivalent oriented graphs with edges labeled with integers in $\{1, \dots, n\}$. At each vertex, the sum of the indices of the incoming edges equals the sum of the indices of the outgoing edges:

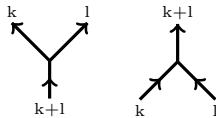

Here is an example of a web:

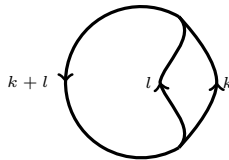

These diagrams are to be understood up to some local relations (see [6] for example), which are a diagrammatic analogue of relations between morphisms of $U_q(\mathfrak{sl}_n)$ -representations that are at the origin of the definition of webs. Note that there are more refined notions of \mathfrak{sl}_n -webs, in particular concerning what to do with n -labeled strands. Indeed, a k -labeled strand corresponds to the k -th exterior power $\bigwedge_q^k(\mathbb{C}^n)$ of the standard $U_q(\mathfrak{sl}_n)$ representation \mathbb{C}^n . The 0-th power is the trivial representation, and it appears natural not to depict it in webs. Similarly, the maximal exterior power $\bigwedge_q^n(\mathbb{C}^n)$ is just the trivial representation, and it is usually forgotten as well (which comes with a correspondence between

an edge labeled by k and the same edge with opposite orientation labeled by $n - k$, see for example [30]). However, it appears that this maximal exterior power plays a non-trivial role in some places, in particular when looking at categorification questions. An heuristic interpretation of this could be the fact that this representation corresponds to the determinant representation, which is indeed a trivial \mathfrak{sl}_n -representation, but is not a trivial \mathfrak{gl}_n -representation. This non-triviality has been encoded by *tags* in some places [31, 6], and applications to categorified knot invariants using these tags in the \mathfrak{sl}_2 case can be found in a work by Clark, Morrison and Walker [9]. One can also choose to keep all the n -edges (which we will then depict doubled). Although the difference is at first sight minimal on the level of webs, it seems to play an important role at the categorified level, as suggested by Blanchet's work [2] and developed in [26]. We sometime refer to these webs as *enhanced*.

For example, the enhanced web:

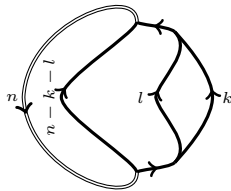

is represented in the tagged version of webs as

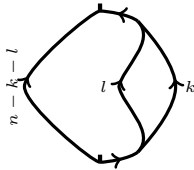

The only difference between the two pictures above lies in the way to deal with the strands decorated with the maximum exterior power of the fundamental representation: while we keep them completely in the first case, they only appear locally in the second case.

The Jones polynomial and its \mathfrak{sl}_n analogues naturally take place in the spider categories. Their reformulation in terms of quantum skew Howe duality proved to be a very powerful tool for understanding these categories, and led Cautis, Kamnitzer and Morrison [6] to solve conjectures on generators and relations for categories of representations $Rep_q(\mathfrak{sl}_n)$. Furthermore, this process admits a very natural categorification [4], linking [26] topological categorifications based on skein theory [16, 17, 18, 1] and categorified quantum groups [19, 21, 20, 22].

However, the skew Howe duality process is quite rigid, allowing to deal only with *ladder webs*, which are a particular class of webs with only upward oriented edges. This is a generalization to the web case of the notion of upward-oriented tangles, with the additional requirement that webs are presented in a rigid structure where strands are either vertical (the uprights of the ladder) or elementary horizontal pieces (the rungs of the ladder). For example, a ladder version of the previous web would be:

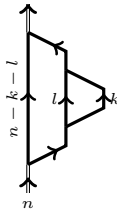

Furthermore, the relation established by Cautis-Kamnitzer-Licata between the braiding (or R -matrix) and the quantum Weyl group action holds up to coefficients $\pm q^k$. For example, the definition of the braidings as it appears in [27] gives for crossings involving a 0-labeled strand:

$$\begin{array}{ccc}
 \begin{array}{c} \nearrow \\ \text{k} \quad 0 \end{array} & \xrightarrow{T'_{i,e}} & (-1)^k q^{ek} \begin{array}{c} \nearrow \\ \text{k} \quad 0 \end{array}
 \end{array}$$

while we would like this crossing to be smoothed without creating any coefficient, since we do not want to consider 0-labeled strands in the skein context. Similarly, definitions provided in [4] wouldn't produce any coefficients, but the use of tags in some of the Reidemeister-like web moves produces difficulties.

In this paper, we find an appropriate rescaling of the Weyl group action that removes the rigidity in the diagrammatic formulation of link (and knotted web) invariants.

Obtaining a skein module. We give in this paper a detailed explanation of the skew-Howe duality process, focusing on obtaining \mathfrak{sl}_n skein modules from this rather rigid context, for any value of n . One of the problems that usually appears when looking at a local crossing in a skein context is that it can be understood in different ways. For example,

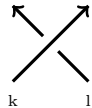

can be translated as a positive (k, l) crossing, or (if we look at it from left to right) as a negative (l, k) crossing with the l strand in reverse direction. These both crossings would give rise to different smoothings in their ladder transcriptions.

The refinement we introduce in this paper is based on both a convenient rescaling of Lusztig's definition of the braidings [27] with a \mathfrak{gl}_m -information, and keeping the whole *enhanced* information of webs, following ideas of Blanchet [2]. It is interesting to note that the original construction of Murakami-Ohtsuki-Yamada [32] was actually also keeping n -labeled strands and is consistent with this presentation. In the \mathfrak{sl}_2 case, this leads to a rather unusual presentation of the skein module, since 2-labeled crossings produce when smoothed some non-trivial coefficients, as shown below:

$$\begin{array}{ccc}
 \begin{array}{c} \nearrow \\ \text{k} \quad 1 \end{array} & \mapsto & q^{-2e} \begin{array}{c} \curvearrowright \\ \text{k} \quad 1 \end{array} \begin{array}{c} \curvearrowleft \\ \text{k} \quad 1 \end{array}, \quad \begin{array}{c} \nwarrow \\ \text{k} \quad 1 \end{array} & \mapsto & q^{2e} \begin{array}{c} \curvearrowleft \\ \text{k} \quad 1 \end{array} \begin{array}{c} \curvearrowright \\ \text{k} \quad 1 \end{array}.
 \end{array}$$

In the \mathfrak{sl}_3 case, we similarly keep 1-, 2- and 3-labeled strands, which produce again different coefficients in the smoothings.

The main result is then that there exists a version of the skew-Howe duality process from which the definition of the braiding can be used locally to define an invariant of framed web-tangles. A good understanding of the behavior of the braidings back in the representation-theory world is of great help in the proof of the invariance under Kauffman's web-moves and considerably simplify them, and also clarifies the categorification of these results.

Affine extensions. The skew-Howe duality process is based on two commuting actions of $U_q(\mathfrak{sl}_n)$ and $U_q(\mathfrak{sl}_m)$ on the module $\bigwedge_q^N(\mathbb{C}^n \otimes \mathbb{C}^m)$. $U_q(\mathfrak{sl}_n)$ corresponds to the quantum invariant we are looking at, and we want to keep it unchanged, but $U_q(\mathfrak{sl}_m)$ appears more as a parameter, and we may want to consider extensions of it. A first step is to replace $U_q(\mathfrak{sl}_m)$ by its affine version $U_q(\widehat{\mathfrak{sl}_m})$.

Classical representation-theoretic tools tell us that we can extend the action of $U_q(\mathfrak{sl}_m)$ to a $U_q(\widehat{\mathfrak{sl}_m})$ one, keeping by construction the commutation property with the $U_q(\mathfrak{sl}_n)$ action. These extensions

can be achieved by the process of *evaluation representations* [8]. This naturally provides knotted-web invariants for the cylinder, and the only question is to relate these invariants to the usual skein module associated to the thickened surface. We show that the evaluation representations with a particular choice of the parameter give the skein module of the filled cylinder, that can be refined by passing to the affinization of the representations. These constructions therefore provide a very natural extension of Jones' construction in the case of web-tangles drawn on the cylinder.

We also investigate better descriptions of the annular skein module in terms of $U_q(\mathfrak{sl}_m)$, and we realize it as a sub-algebra of intertwiners for an explicit $U_q(\mathfrak{sl}_n)$ representation, which give to it the same kind of representation-theory flavored interpretation as we have in the linear case.

Many proofs use the fact that relations for $U_q(\mathfrak{sl}_m)$ and $U_q(\widehat{\mathfrak{sl}_m})$ locally have the same form. Thus, just as at the uncategorified level, the categorification of the skew Howe process provided in [26] admits a direct extension to the affine case.

Note that a recent paper by Mackaay and Thiel [28] presents a categorification of affine q -Schur algebras. Although their paper does not directly deal with annular knots, it would be interesting to understand its implications in terms of categorified invariants of annular web-tangles and the links with categorified quantum skew-Howe duality.

Acknowledgments: I would like to thank my advisors Christian Blanchet and Catharina Stroppel for their constant support, and Aaron Lauda for his great help. Many thanks also to David Rose, Peng Shan, Pedro Vaz and Emmanuel Wagner for all useful discussions we had, Marco Mackaay for pointing out the interest of the affine Hecke algebra, and especially to Mathieu Mansuy for teaching me everything I know about affine algebras.

1. SKEW HOWE DUALITY AND SKEIN MODULES

1.1. Skew Howe duality.

1.1.1. *Context.* We first give a short description of the skew Howe duality phenomenon for usual \mathfrak{sl}_n as explained in [5] and [6].

We look at the quantum group $U_q(\mathfrak{sl}_m)$ as the $\mathbb{C}[q, q^{-1}]$ -algebra generated by the Chevalley elements $E_i, F_i, K_i^{\pm 1}$, for $1 \leq i \leq m-1$, subject to the relations:

$$\begin{aligned} K_i K_i^{-1} = K_i^{-1} K_i = 1 & \quad , & \quad K_i K_j = K_j K_i, \\ K_i E_j K_i^{-1} = q^{a_{ij}} E_j & \quad , & \quad K_i F_j K_i^{-1} = q^{-a_{ij}} F_j, \\ E_i F_j - F_j E_i & = \delta_{ij} \frac{K_i - K_i^{-1}}{q - q^{-1}}, \\ E_i^2 E_j - (q + q^{-1}) E_i E_j E_i + E_j E_i^2 & = 0 \text{ if } j = i \pm 1, \\ F_i^2 F_j - (q + q^{-1}) F_i F_j F_i + F_j F_i^2 & = 0 \text{ if } j = i \pm 1, \\ E_i E_j = E_j E_i & \quad , & \quad F_i F_j = F_j F_i \text{ if } |i - j| > 1. \end{aligned}$$

The idempotent version of $U_q(\mathfrak{sl}_m)$ will be denoted $\dot{U}_q(\mathfrak{sl}_m)$. Generators are $\mathbf{1}_\lambda, E_i \mathbf{1}_\lambda$ and $F_i \mathbf{1}_\lambda$, for all weights λ . The unit is then replaced by a collection of orthogonal idempotents $\mathbf{1}_\lambda$ indexed by the weight lattice of \mathfrak{sl}_m ,

$$\mathbf{1}_\lambda \mathbf{1}_{\lambda'} = \delta_{\lambda\lambda'} \mathbf{1}_\lambda,$$

such that if $\lambda = (\lambda_1, \lambda_2, \dots, \lambda_{m-1})$, then

$$K_i \mathbf{1}_\lambda = \mathbf{1}_\lambda K_i = q^{\lambda_i} \mathbf{1}_\lambda, \quad E_i \mathbf{1}_\lambda = \mathbf{1}_{\lambda + \alpha_i} E_i, \quad F_i \mathbf{1}_\lambda = \mathbf{1}_{\lambda - \alpha_i} F_i,$$

where

$$\lambda + \alpha_i = \begin{cases} (\lambda_1 + 2, \lambda_2 - 1, \lambda_3, \dots, \lambda_{m-2}, \lambda_{m-1}) & \text{if } i = 1 \\ (\lambda_1, \lambda_2, \dots, \lambda_{m-3}, \lambda_{m-2} - 1, \lambda_{m-1} + 2) & \text{if } i = m - 1 \\ (\lambda_1, \dots, \lambda_{i-1} - 1, \lambda_i + 2, \lambda_{i+1} - 1, \dots, \lambda_{m-1}) & \text{otherwise.} \end{cases}$$

$U_q(\mathfrak{sl}_m)$ can be endowed with the structure of a Hopf algebra, with coproduct $\Delta: U_q(\mathfrak{sl}_m) \mapsto U_q(\mathfrak{sl}_m) \otimes U_q(\mathfrak{sl}_m)$ given on Chevalley generators by:

$$(1.1) \quad \begin{aligned} \Delta(E_i) &= 1 \otimes E_i + E_i \otimes K_i \\ \Delta(F_i) &= K_i^{-1} \otimes F_i + F_i \otimes 1 \\ \Delta(K_i^{\pm 1}) &= K_i^{\pm 1} \otimes K_i^{\pm 1}. \end{aligned}$$

Define $\bigwedge_q(\mathbb{C}^r)$ as the algebra generated by r variables:

$$\bigwedge_q(\mathbb{C}^r) = \mathbb{C}[q, q^{-1}] \langle X_1, \dots, X_r \rangle / (X_i^2, X_i X_j + q^{-1} X_j X_i \text{ for } i < j).$$

This algebra can be given a $U_q(\mathfrak{sl}_r)$ action, extending the natural representation¹. More precisely:

$$\begin{aligned} E_i X_i &= X_{i+1} \quad , \quad E_i X_j = 0 \quad \text{if } j \neq i, \\ F_i X_{i+1} &= X_i \quad , \quad F_i X_j = 0 \quad \text{if } j \neq i + 1, \\ K_i X_i &= q^{-1} X_i \quad , \quad K_i X_{i+1} = q X_{i+1}, \quad K_i X_j = X_j \quad \text{otherwise.} \end{aligned}$$

We now consider $\bigwedge_q(\mathbb{C}^n \otimes \mathbb{C}^m)$, where, following [6], the generating variables can be denoted z_{ij} with $1 \leq i \leq n$, $1 \leq j \leq m$, subject to skew-commutation relations.

There are two isomorphisms:

$$\bigwedge_q(\mathbb{C}^n)^{\otimes m} \leftarrow \bigwedge_q(\mathbb{C}^n \otimes \mathbb{C}^m) \rightarrow \bigwedge_q(\mathbb{C}^m)^{\otimes n}.$$

We can thus endow this module with actions of $U_q(\mathfrak{sl}_n)$ and $U_q(\mathfrak{sl}_m)$, which Cautis, Kamnitzer and Licata have proved to commute, calling this *quantum skew Howe duality*. Furthermore, $U_q(\mathfrak{sl}_n)$ and $U_q(\mathfrak{sl}_m)$ form a Howe pair, which is a key argument in [6].² The actions of the two quantum groups can be deduced, for $U_q(\mathfrak{sl}_m)$ for example, from the expressions on the variables z_{ij} :

$$\begin{aligned} E_j z_{ij} &= z_{i,j+1} \quad , \quad E_k z_{ij} = 0 \quad \text{if } k \neq j, \\ F_j z_{i,j+1} &= z_{i,j} \quad , \quad F_k z_{ij} = 0 \quad \text{if } k \neq j + 1, \\ K_j z_{ij} &= q^{-1} z_{ij} \quad , \quad K_j z_{i,j+1} = q z_{i,j+1}, \quad K_k z_{ij} = z_{ij} \quad \text{otherwise.} \end{aligned}$$

We can assign degree one to each generating variable. Given an integer N , the subspace of degree N decomposes as an \mathfrak{sl}_n -representation:

$$\bigwedge_q^N(\mathbb{C}^n \otimes \mathbb{C}^m) = \bigoplus_{a_1 + \dots + a_m = N} \bigwedge_q^{a_1}(\mathbb{C}^n) \otimes \dots \otimes \bigwedge_q^{a_m}(\mathbb{C}^n).$$

Each direct summand is an m -fold tensor product of minuscule \mathfrak{sl}_n -representations, but is not stable under the action of $U_q(\mathfrak{sl}_m)$. However, it appears (tracking it from the explicit definition of the actions) that each subspace $\bigwedge_q^{a_1}(\mathbb{C}^n) \otimes \dots \otimes \bigwedge_q^{a_m}(\mathbb{C}^n)$ is a $U_q(\mathfrak{sl}_m)$ weight space of weight $(a_2 - a_1, a_3 - a_2, \dots, a_m - a_{m-1})$. In particular, if $m = 2$, the subspaces are of the form $\bigwedge_q^k(\mathbb{C}^n) \otimes \bigwedge_q^l(\mathbb{C}^n)$, which are both $U_q(\mathfrak{sl}_n)$ -modules and $U_q(\mathfrak{sl}_2)$ weight spaces of weight $l - k$. The action of $U_q(\mathfrak{sl}_m)$ can be

¹Actually, we choose here a non-standard form (dual) for the natural representation in order to obtain the same conventions as in [26].

²Note that proving the commutation is an easy computation, while it is much harder to prove that both algebras are each other commutant.

explicitly tracked (see Table (1.3) for the case where $m = n = N = 2$), and we see that $E_i: \Lambda_q^{a_1}(\mathbb{C}^n) \otimes \cdots \otimes \Lambda_q^{a_i}(\mathbb{C}^n) \otimes \Lambda_q^{a_{i+1}}(\mathbb{C}^n) \cdots \otimes \Lambda_q^{a_m}(\mathbb{C}^n) \mapsto \Lambda_q^{a_1}(\mathbb{C}^n) \otimes \cdots \otimes \Lambda_q^{a_i-1}(\mathbb{C}^n) \otimes \Lambda_q^{a_{i+1}+1}(\mathbb{C}^n) \cdots \otimes \Lambda_q^{a_m}(\mathbb{C}^n)$.

This $U_q(\mathfrak{sl}_m)$ action can be depicted by some particular diagrams called *ladders*. To a direct summand $\Lambda_q^{a_1}(\mathbb{C}^n) \otimes \cdots \otimes \Lambda_q^{a_m}(\mathbb{C}^n)$ we assign a sequence (a_1, \dots, a_m) depicted as weighted upward strands:

$$(a_1, \dots, a_m) \mapsto \begin{array}{ccccccc} & & \uparrow & \cdots & \uparrow & \uparrow & \cdots & \uparrow \\ & & a_1 & & a_i & a_{i+1} & & a_m \end{array}$$

Strands labeled by zero will be erased, and we will sometime depict the n -labeled strands doubled. We represent the action of E_i and F_i as follows:

$$(1.2) \quad E_i \mapsto \begin{array}{ccccccc} & & & & a_i - 1 & a_{i+1} + 1 & & & & \\ & & \uparrow & & \uparrow & \uparrow & \uparrow & \uparrow & & \\ \cdots & \cdots & \uparrow & \cdots & \uparrow & \uparrow & \uparrow & \uparrow & \cdots & \\ & & a_1 & & a_i & a_{i+1} & & a_m & & \end{array} \quad \text{and} \quad F_i \mapsto \begin{array}{ccccccc} & & & & a_i + 1 & a_{i+1} - 1 & & & & \\ & & \uparrow & & \uparrow & \uparrow & \uparrow & \uparrow & & \\ \cdots & \cdots & \uparrow & \cdots & \uparrow & \uparrow & \uparrow & \uparrow & \cdots & \\ & & a_1 & & a_i & a_{i+1} & & a_m & & \end{array}$$

where we only depicted the strands $1, i, i + 1$ and m : straight strands with indices $a_j, j \neq 1, i, i + 1, m$ have to be added in place of the dots. The diagrams are to be read from bottom to top.

We can define the notion of ladder as any morphism obtained by composition of identities and elementary morphisms given by the images of E_i and F_i .

The above diagrams have an interpretation in terms of webs. Recall that \mathfrak{sl}_n webs are trivalent oriented graphs with edges indexed by integers $1, \dots, n$, so that at each vertex, the sum of outgoing labels equals the sum of ingoing labels (in the literature, the n -strands are usually erased or only kept as tags on the other strands, which we will not do here). These graphs are considered modulo some local relations (see for example [6], or Definition 1.4, for a more precise description). The webs may be understood as \mathfrak{sl}_n analogues of the skein module in the \mathfrak{sl}_2 case (see also [32] or [30] for more details).

An interesting fact is that all of the web relations in the spider category can be recovered from the relations in $U_q(\mathfrak{sl}_m)$ via its action on webs³. We refer for this and for a complete description of the spider category to [6].

We give below an example of the translation process, which gives a ladder whose closure is the one depicted in the introduction (with $k = l = 1$) with $n = 3, m = 3$ and $N = 3$.

$$E_1 F_2 E_2 F_1 \mathbf{1}_{(3,-3)} \mapsto \begin{array}{c} \begin{array}{c} \uparrow \\ | \\ \uparrow \end{array} \begin{array}{c} \uparrow \\ | \\ \uparrow \end{array} \begin{array}{c} \uparrow \\ | \\ \uparrow \end{array} \\ | \quad | \quad | \\ \begin{array}{c} \uparrow \\ | \\ \uparrow \end{array} \begin{array}{c} \uparrow \\ | \\ \uparrow \end{array} \begin{array}{c} \uparrow \\ | \\ \uparrow \end{array} \\ | \quad | \quad | \\ \uparrow \quad \uparrow \quad \uparrow \\ 1 \quad 1 \quad 1 \\ \uparrow \quad \uparrow \quad \uparrow \\ 2 \quad 2 \quad 2 \\ \uparrow \quad \uparrow \quad \uparrow \\ 3 \quad 3 \quad 3 \end{array}$$

In the case where $m = n = N = 2$, the $U_q(\mathfrak{sl}_m)$ action can be explicitly given:

³This statement holds in the case where n -strands are only kept as tags. We will therefore add some relations on the n -strands later.

Summand	Generator	Image under E	Image under F
$\Lambda_q^2 \otimes \Lambda_q^0$	$z_{11} \otimes z_{21}$	$z_{11} \otimes z_{22} + q^{-1} z_{12} \otimes z_{21}$	0
$\Lambda_q^1 \otimes \Lambda_q^1$	$z_{11} \otimes z_{12}$	0	0
	$z_{21} \otimes z_{22}$	0	0
	$z_{11} \otimes z_{22}$	$qz_{12} \otimes z_{22}$	$qz_{11} \otimes z_{21}$
	$z_{12} \otimes z_{21}$	$z_{12} \otimes z_{22}$	$z_{11} \otimes z_{21}$
$\Lambda_q^0 \otimes \Lambda_q^2$	$z_{12} \otimes z_{22}$	0	$q^{-1} z_{12} \otimes z_{21} + z_{11} \otimes z_{22}$

The previous table corresponds in the diagrammatic world to the next situation:

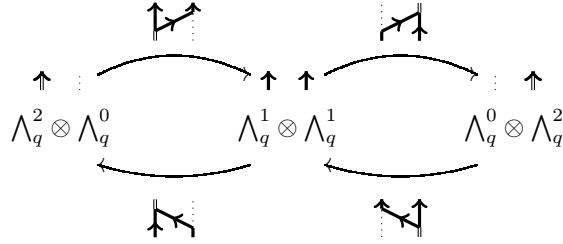

where in the above pictures, 0-strands are depicted dotted and 2-strands are doubled.

1.1.2. *Quantum Weyl group action.* The action of the Weyl group \mathfrak{S}_m of \mathfrak{sl}_m on the weights q -deforms to give rise to a braid group action on representations of $U_q(\mathfrak{sl}_m)$. This phenomenon is referred to as the *quantum Weyl group action* (see [27], [14], [5]).

Generators of the braid group action are elements of the completion $\widetilde{U_q(\mathfrak{sl}_m)}$ of $U_q(\mathfrak{sl}_m)$. This ring is defined (see [14] for example) as a quotient of the ring of series $\sum_{k=1}^{\infty} X_k$ of elements of $U_q(\mathfrak{sl}_m)$, acting on each irreducible representation $V(\lambda)$ of highest weight λ by zero but for finitely many terms X_k . We then consider the quotient of this ring by the two-sided ideal of elements acting by zero on all $V(\lambda)$.

Following [27], to s_i the elementary transposition corresponding to the root α_i , we associate the map $T''_{i,e} \in \widetilde{U_q(\mathfrak{sl}_m)}$:

$$(1.4) \quad T''_{i,e} \mathbf{1}_\lambda := \sum_{a-b+c=-\lambda_i} (-1)^b q^{e(-ac+b)} E_i^{(a)} F_i^{(b)} E_i^{(c)} \mathbf{1}_\lambda,$$

where $e = \pm 1$.

With this definition, $T''_{i,e}$ gives an endomorphism of any finite-dimensional representation. Note that if v is a weight vector of weight λ , $T_i(v)$ is a weight vector of weight $s_i(\lambda)$.

Taking $m = 2$ for simplicity, we have $T_e'' \pm \in \widetilde{U_q(\mathfrak{sl}_m)}$, acting on $\Lambda_q^N(\mathbb{C}^n \otimes \mathbb{C}^2)$. This stabilizes the whole representation, and gives a morphism of $U_q(\mathfrak{sl}_n)$ representations, from $\Lambda_q^k(\mathbb{C}^n) \otimes \Lambda_q^l(\mathbb{C}^n)$ to $\Lambda_q^l(\mathbb{C}^n) \otimes \Lambda_q^k(\mathbb{C}^n)$. It is shown in [5] that this $U_q(\mathfrak{sl}_n)$ endomorphism recovers the braiding. This is the starting point of a reinterpretation of Reshetikhin-Turaev invariants in terms of skew-Howe duality [4], which admits natural categorifications [4, 26].

The name *quantum Weyl group* is used by different authors with slightly different significations. The first one, where we use the notation $T''_{i,e}$, consists in considering morphisms of representations, acting on the category of finite-dimensional modules. We can also use it to build automorphisms of the quantum group itself, by conjugation. Following [14], we denote the latter $C_{T''_{i,e}} : X \mapsto T''_{i,e} X T''_{i,e}^{-1}$. We will use both versions in this paper. We will need some results concerning the behavior of these elements for later use.

For $w = s_{i_1} \cdots s_{i_n}$ element of the Weyl group written in reduced form, where s_i are simple reflexions, we define $T''_{w,e} = T''_{i_1,e} \cdots T''_{i_n,e}$.

Proposition 1.1. [8, Theorem 8.1.2], [27, Section 37.1.3], [14]

$$\begin{aligned} C_{T''_{i,e}}(E_i \mathbf{1}_\lambda) &= -q^{-e\lambda_i} F_i \mathbf{1}_{s_i(\lambda)} \\ C_{T''_{i,e}}(\mathbf{1}_\lambda F_i) &= -q^{e\lambda_i} \mathbf{1}_{s_i(\lambda)} E_i. \end{aligned}$$

For $w \in W$ such that $w(\alpha_i) = \alpha_j$, $C_{T''_{w,e}}(E_i) = E_j$.

Other intertwiners, defined in [27], may also be of interest:

$$(1.5) \quad T'_{i,e} \mathbf{1}_\lambda := \sum_{a-b+c=\lambda_i} (-1)^b q^{e(-ac+b)} F_i^{(a)} E_i^{(b)} F_i^{(c)} \mathbf{1}_\lambda.$$

We have an analogue of Proposition 1.1:

Proposition 1.2.

$$\begin{aligned} C_{T'_{i,e}}(\mathbf{1}_\lambda E_i) &= -q^{-e\lambda_i} \mathbf{1}_{s_i(\lambda)} F_i \\ C_{T'_{i,e}}(F_i \mathbf{1}_\lambda) &= -q^{e\lambda_i} E_i \mathbf{1}_{s_i(\lambda)}. \end{aligned}$$

For $w \in W$ such that $w(\alpha_i) = \alpha_j$, $C_{T'_{w,e}}(E_i) = E_j$.

The relation between the actions of both definitions is given by:

Proposition 1.3. [27, Sections 5.2.3, 37.1.2] $T''_{i,e}$ and $T'_{i,-e}$ are inverse of each other. $T''_{i,e} \mathbf{1}_\lambda$ and $(-1)^{\lambda_i} q^{e\lambda_i} T'_{i,e} \mathbf{1}_\lambda$ act the same way on any integrable module.

1.1.3. *Skew Howe duality and quantum invariants for knots.* As we have seen, the skew-Howe duality process gives us different pieces of the Jones (or Reshetikhin-Turaev) invariants:

- minuscule representations $\bigwedge_q^k(\mathbb{C}^n)$ of $U_q(\mathfrak{sl}_n)$. This means that we are looking at knot invariants where we decorate the strands with minuscule representations. In particular, this does not deal with the colored Jones polynomial or its \mathfrak{sl}_n generalizations, where the strands of the knot can be decorated with any finite-dimensional representations. Paths using Jones-Wenzl projectors, and their categorifications in the categorified case, can be given to relate the general invariants to the ones we study here [12, 35, 10, 33].
- elementary morphisms between tensor products of these representations, given as images of E_i and $F_i \in U_q(\mathfrak{sl}_m)$. These morphisms involve minuscule representations, but do not directly deal with duals, which in the language of knots means that we are looking at upward tangles (or their generalization for webs). The bridge with general knots or links is established in our case in [6] (see also [30]).
- braiding between minuscule representations, understood in terms of the quantum Weyl group action of $U_q(\mathfrak{sl}_m)$. Again, this is given in the framework of ladders, and relaxing this structure will be one of the goals of the next section.

1.2. Skein modules.

1.2.1. *Braidings for skein modules.* Let us now turn toward knots, or ladder analogues of them. The previous diagrammatic process gives us an algebraic interpretation of ladder webs, as well as a definition of the braiding for the tensor product of two minuscule representations. This braiding corresponds in the diagrammatic world to a crossing between two adjacent strands in a ladder, the explicit formulas for $T'_{i,e}$ or $T''_{i,e}$ giving a way to smooth it and replace it by a sum of ladders without crossing.

We start by defining more precisely the notion of skein module, before relating it to the previous analysis. By skein module, we usually refer here both to the module itself and to the Kauffman bracket defining a map from web-tangles to the module. The definition below is adapted from [6].

Definition 1.4. Let $n\mathbf{Web}$, the \mathfrak{sl}_n web skein module, be the $\mathbb{Z}[q, q^{-1}]$ -module generated by webs (planar oriented trivalent graphs with preserved flow), possibly with boundary, up to isotopy and the following web relations:

$$(1.6) \quad \begin{array}{c} k+l \\ \uparrow \\ \begin{array}{c} \diagup \quad \diagdown \\ \diagdown \quad \diagup \\ \uparrow \end{array} \\ k \quad l \\ \downarrow \\ k+l \end{array} = \begin{bmatrix} k+l \\ l \end{bmatrix}_q \begin{array}{c} \uparrow \\ k+l \end{array}, \quad \begin{array}{c} k \\ \uparrow \\ \begin{array}{c} \diagup \quad \diagdown \\ \diagdown \quad \diagup \\ \uparrow \end{array} \\ l \quad k+l \\ \downarrow \\ k \end{array} = \begin{bmatrix} n-k \\ l \end{bmatrix}_q \begin{array}{c} \uparrow \\ k \end{array}$$

$$(1.7) \quad \begin{array}{c} k+l+m \\ \uparrow \\ \begin{array}{c} \diagup \quad \diagdown \\ \diagdown \quad \diagup \\ \uparrow \end{array} \\ k \quad l \quad m \end{array} = \begin{array}{c} k+l+m \\ \uparrow \\ \begin{array}{c} \diagup \quad \diagdown \\ \diagdown \quad \diagup \\ \uparrow \end{array} \\ k \quad l \quad m \end{array}, \quad \begin{array}{c} \uparrow \\ r \\ \begin{array}{c} \diagup \quad \diagdown \\ \diagdown \quad \diagup \\ \uparrow \end{array} \\ s \\ \uparrow \\ k \quad l \end{array} = \begin{bmatrix} r+s \\ r \end{bmatrix}_q \begin{array}{c} \uparrow \\ r+s \\ \begin{array}{c} \diagup \quad \diagdown \\ \diagdown \quad \diagup \\ \uparrow \end{array} \\ k \quad l \end{array}$$

$$(1.8) \quad \begin{array}{c} \uparrow \\ r \\ \begin{array}{c} \diagup \quad \diagdown \\ \diagdown \quad \diagup \\ \uparrow \end{array} \\ s \\ \uparrow \\ k \quad l \end{array} = \sum_t \begin{bmatrix} k-l+r-s \\ t \end{bmatrix}_q \begin{array}{c} \uparrow \\ r \\ \begin{array}{c} \diagup \quad \diagdown \\ \diagdown \quad \diagup \\ \uparrow \end{array} \\ s \\ \uparrow \\ k \quad l \end{array}$$

All equations come with the ones obtained by mirror image and arrow reversion. Recall that $[k] = \frac{q^k - q^{-k}}{q - q^{-1}}$, $[k]! = [k][k-1] \cdots [1]$ and $\begin{bmatrix} p \\ k \end{bmatrix}_q = \frac{[p]!}{[k]![p-k]!}$.

The skein module described above can be given the structure of a category, with objects given by oriented points with labels on a horizontal line (the boundary of strands), and morphisms the webs joining the dots on two such parallel lines. A subcategory is of particular interest for the skew-Howe interpretation, and turns out to essentially representation all the information we need. Assuming a value of N is fixed, let us call $\Phi: \dot{\mathbf{U}}_q(\mathfrak{sl}_m) \mapsto n\mathbf{Web}$ the map described in Equation (1.2).

Definition 1.5. Define $n\mathbf{Web}_m^+$ to be the image category $\Phi(\dot{\mathbf{U}}_q(\mathfrak{sl}_m))$, with objects, sequences (a_1, \dots, a_m) ($0 \leq a_i \leq n$) labeling points on a horizontal line, together with a zero object, and morphisms, \mathfrak{sl}_n webs between such sequences (in the sense of Definition 1.4), that are composition of the images of E_i and F_i , as depicted in Equation (1.2).

We sometime refer to such webs as upward webs, or ladders. These ladder webs have their boundary split in two parts, with all strands oriented inside for the bottom part, and outside for the upper part. Although general webs are more general than this particular situation, it is shown in [6] that they can be related to the particular class of webs obtained from ladders using the tool of pivotal categories.

The use of tags makes the situation somewhat simpler (but harder to fit in a skein module formulation!), but the next relations (and the ones obtained by symmetry on the next ones) are particular realizations of the ones given in [6] in the case where we keep the n -labeled strands (and are special cases of Definition 1.4).

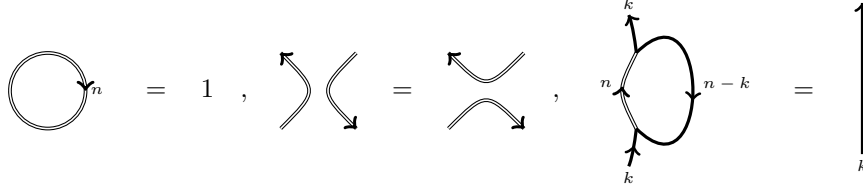

In the above pictures, the n -th strands are depicted doubled for underlying their particular role.

The skein module $n\mathbf{Web}$ is a natural target for maps from (equivalence classes of) diagrams of knotted webs. We call knotted webs, or web-tangles, the natural generalization of knots and tangles to webs. For example, knotted webs are isotopy classes of embeddings into \mathbb{R}^3 of closed webs, and produce diagrams of knotted webs as generic projections onto a plane. Web-tangles are the natural generalization allowing boundaries.

Recall from [15] (see also [3, Theorem 2]) the relations that generalize Reidemeister moves (in a framed version, where a numbered circle on a strand stands for twists): any two diagrams representing the same web-tangle are related by a sequence of moves of the following kind:

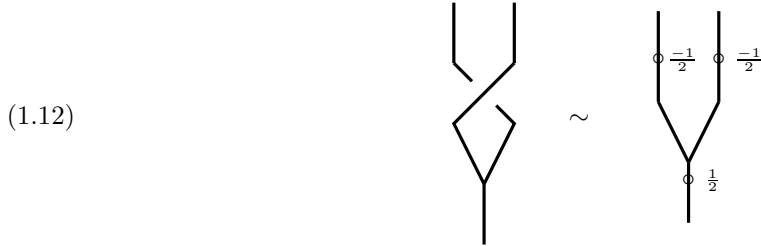
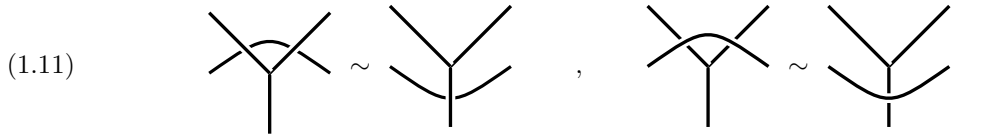
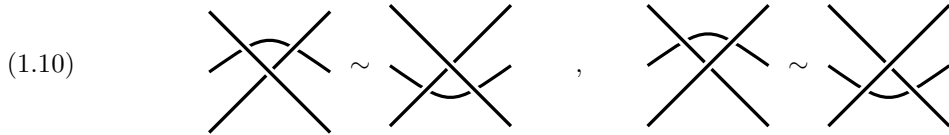
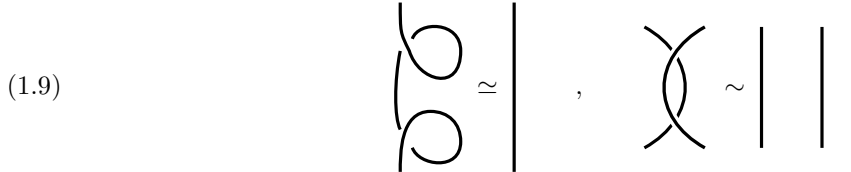

Definition 1.6. A Kauffman bracket for \mathfrak{sl}_n webs is a map from diagrams of \mathfrak{sl}_n web-tangles to $n\mathbf{Web}$, defined locally by replacing a crossing by a linear combination of smoothings, and subject to Relations (1.9) to (1.12).

Let us now restrict to the knotted analogue of $n\mathbf{Web}_m^+$, and define a knotted ladder (or web-tangle in ladder position) to be a vertical composition of images of $E_i \mathbf{1}_\lambda \in \dot{\mathbf{U}}_q(\mathfrak{sl}_m)$ and $F_i \mathbf{1}_\lambda \in \dot{\mathbf{U}}_q(\mathfrak{sl}_m)$ and crossings between two adjacent uprights in the ladder. Interpreting a crossing between the i -th and $(i + 1)$ -th strands as the quantum Weyl group action, one obtains a smoothing process for crossings.

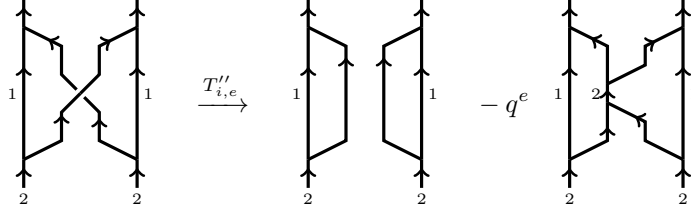

Thus, smoothing all crossings in a ladder web-tangle, one obtains a formal sum of non-knotted ladders that one can see as an element of a skein module.

To obtain a more powerful skein module allowing less rigidity, we want to forget the 0-labeled strands. Indeed, in ladder position, even if the 0-labeled strands are not depicted, one knows where they are. If we want to start from any diagram and use the same smoothing rules as in the ladder case, we cannot know where 0-strands should be and we want to make sure that crossings involving 0-labeled strands do not play any role.

The goal of this section is to obtain a skew-Howe duality process with a conveniently rescaled braiding, so that the smoothing rules derived from this braiding induce a Kauffman bracket for general \mathfrak{sl}_n web-tangles.

Using [27, Proposition 5.2.2], we have:

Proposition 1.7.

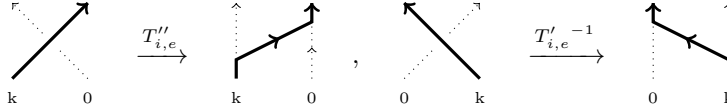

Note that if we use $T''_{i,e}$ in positive degree and $T'_{i,e}$ in negative degree, the situation is different: see Proposition 1.3. We would have:

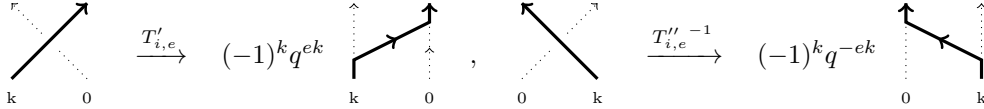

It appears that we cannot choose one of the two solutions and apply it in all cases. A natural idea would be to use a braiding mixing both definitions... which may produce some gaps if we still want to have some instances of Propositions 1.1 and 1.2 (which will prove useful later).

In order to avoid these distortions, we introduce additional rescalings that utilize $U_q(\mathfrak{gl}_m)$ data that is naturally encoded in the representation we are looking at (namely, the sequence (a_1, \dots, a_m) , which is determined by the \mathfrak{sl}_m weight and the choice of an integer N). Note that the following definitions are rather symmetric in the $T'_{i,e}$'s and $T''_{i,e}$'s.

$$(1.13) \quad \begin{aligned} T_{i,e} \mathbf{1}_\lambda &= (-1)^{-a_{i+1}} q^{-ea_{i+1}} T''_{i,e} \mathbf{1}_\lambda = (-1)^{-a_i} q^{-ea_i} T'_{i,e} \mathbf{1}_\lambda, \\ T_{i,e}^{-1} \mathbf{1}_\lambda &= (-1)^{a_i} q^{ea_i} T''_{i,e}^{-1} \mathbf{1}_\lambda = (-1)^{a_{i+1}} q^{ea_{i+1}} T'_{i,e}^{-1} \mathbf{1}_\lambda. \end{aligned}$$

It is easy to see from Proposition 1.3 that both definitions agree, and that this definition still provides a braiding. We can check that we still have $C_{T_{1,e} T_{2,e}}(E_1) = E_2$ as endomorphisms of a given representation appearing in the skew Howe context.

1.2.2. \mathfrak{sl}_2 case. Let us now give a complete description of the \mathfrak{sl}_2 case.

In [2], Blanchet introduces \mathfrak{sl}_2 webs to be oriented trivalent graphs with two kinds of edges (1 and 2-labeled, we draw the latter doubled), and vertices having two inner 1-labeled strands and an outer 2-labeled one, or one inner 2-labeled strand and two outer 1-labeled ones.

The \mathfrak{sl}_2 skein module $2\mathbf{Web}$ is the quotient of (linear combinations of) webs with edges labeled 1 or 2 by the next relations:

$$(1.14) \quad \bigcirc = [2] \quad , \quad \bigcirc = 1 \quad , \quad \begin{array}{c} \curvearrowright \\ \curvearrowleft \end{array} = \begin{array}{c} \curvearrowleft \\ \curvearrowright \end{array}$$

$$(1.15) \quad \begin{array}{c} \diagup \\ \diagdown \end{array} = [2] \begin{array}{c} | \\ | \end{array} \quad , \quad \begin{array}{c} \diagup \\ \diagdown \end{array} = \begin{array}{c} | \\ | \end{array}$$

For non-oriented webs above, the depicted relations hold for any compatible orientation. The definition of the braidings then gives the following smoothing rules:

$$\begin{array}{l} \begin{array}{c} \diagup \\ \diagdown \end{array} \mapsto (-1)q^{-e} \begin{array}{c} \curvearrowright \\ \curvearrowleft \end{array} + \begin{array}{c} \diagdown \\ \diagup \end{array} \quad , \quad \begin{array}{c} \diagdown \\ \diagup \end{array} \mapsto (-1)q^e \begin{array}{c} \curvearrowright \\ \curvearrowleft \end{array} + \begin{array}{c} \diagup \\ \diagdown \end{array} \\ \begin{array}{c} \diagup \\ \diagdown \end{array} \mapsto (-1)q^{-e} \begin{array}{c} \diagup \\ \diagdown \end{array} \quad , \quad \begin{array}{c} \diagdown \\ \diagup \end{array} \mapsto (-1)q^e \begin{array}{c} \diagdown \\ \diagup \end{array} \\ \begin{array}{c} \diagup \\ \diagdown \end{array} \mapsto (-1)q^{-e} \begin{array}{c} \diagdown \\ \diagup \end{array} \quad , \quad \begin{array}{c} \diagdown \\ \diagup \end{array} \mapsto (-1)q^e \begin{array}{c} \diagup \\ \diagdown \end{array} \\ \begin{array}{c} \diagup \\ \diagdown \end{array} \mapsto q^{-2e} \begin{array}{c} \curvearrowright \\ \curvearrowleft \end{array} \quad , \quad \begin{array}{c} \diagdown \\ \diagup \end{array} \mapsto q^{2e} \begin{array}{c} \curvearrowright \\ \curvearrowleft \end{array} \end{array}$$

We could check, following [15], that the previous relations (1.14), (1.15), and the above smoothing relations define a framed skein module. Checking directly all formulas is rather long and tedious, and we note that using the description in terms of the $U_q(\mathfrak{sl}_m)$ -action gives us an efficient way to considerably simplify the proof, in the general case. Indeed, most formulas we want to check are consequences of $U_q(\mathfrak{sl}_m)$ -relations.

The previous skein module provides invariants of framed webs. Here are the effects of adding a negative twist on a 1-strand (depicted in a ribbon version in the two left parts of the equation below):

$$\begin{array}{c} \diagup \\ \diagdown \end{array} = \begin{array}{c} \diagup \\ \diagdown \end{array} \mapsto -q^e \begin{array}{c} \diagup \\ \diagdown \end{array} \circ + \begin{array}{c} \diagdown \\ \diagup \end{array} = -q^{2e} \begin{array}{c} \diagup \\ \diagdown \end{array}$$

The same computation for a 2-labeled strand gives a q^{2e} coefficient. We may introduce twists with half-integers, assigning to them in the negative case the multiplication by q^e , and in the positive case the multiplication by q^{-e} , up to fourth roots of the unity. We fix the value to be $(-1)^{\frac{k}{2}} q^{\frac{-ekn+ek(k-1)}{2}}$ where k stands for the labeling of the strand, and where we have chosen a favorite primitive fourth root of the unity $(-1)^{\frac{1}{2}}$.

1.2.3. \mathfrak{sl}_n case. The previous process applies as well to any value of n , and produces a skein module in the following sense: Cautis, Kamnitzer and Morrison [6] prove that all web relations come from $\dot{U}_q(\mathfrak{sl}_m)$ relations, so we just need to extend it to crossings and prove the invariance under Reidemeister moves. This is the purpose of the following proposition.

Proposition 1.8. For all n , the local smoothing rule defined by Relation (1.13) extends to a Kauffman bracket on \mathfrak{sl}_n web-tangles.

Proof. **Braid-like relations:** Braid-like Reidemeister II relation is direct, and braid-like Reidemeister III relations are consequences of the braiding relation (see [9] for a presentation of all 6 braid-like Reidemeister III relations).

Framing: The framed Reidemeister I relation is easy to check. Furthermore, we can deal locally with the framing as we did in the \mathfrak{sl}_2 -case. Details will be given in Lemma 1.9.

Braid-like web relation 1.11:⁴ Braid-like relations (1.11) are consequences of the next equality, or similar ones:

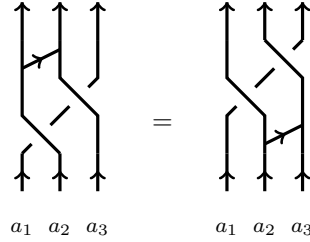

The previous relation is a diagrammatically depicted consequence of $C_{T_{1,e}T_{2,e}}(E_1) = E_2$, a relation from Propositions 1.1 and 1.2, which still holds after rescalings. For obtaining the general case, one needs a straightforward generalization of the previous relation: $C_{T_{1,e}T_{2,e}}(E_1^{(k)}) = E_2^{(k)}$.

Star relations using duality: Following [9], it suffices to have the Reidemeister II relation with opposite orientations to deduce the Reidemeister III star relation. We obtain the Reidemeister II case from the braid-like one as follows:

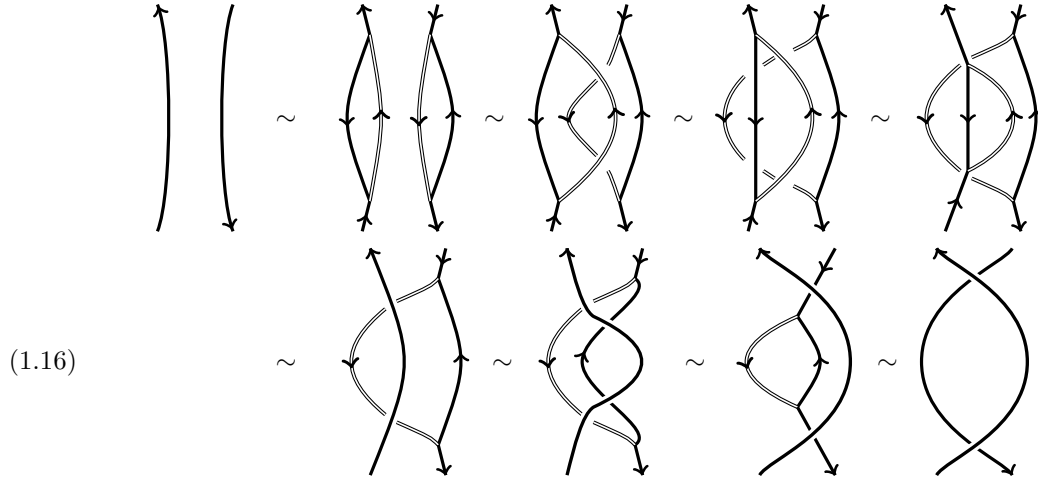

We used in the previous computation the star Reidemeister II relation in the n - n case, which is easy to prove:

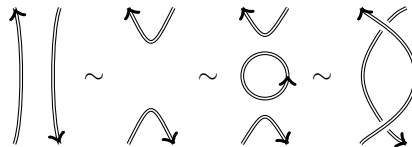

⁴Note that similar relations are studied at the categorified level in [29].

Then, we want to obtain the missing forms of Relation 1.11. We proceed as follows in one case, the other ones being similar:

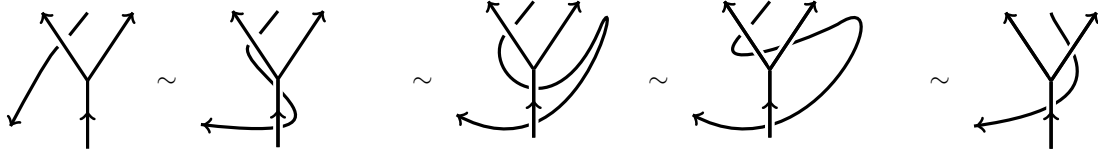

Relation 1.12 and framing: The last relation, for which we need a better understanding of the framing, will be proved separately in Lemma 1.10 below. \square

It is easy to see that a positive framing on a k -strand is equivalent to multiplication by a polynomial in q and q^{-1} . Note t_k this polynomial.

$$\begin{array}{c} \uparrow \\ \oplus_1 \\ k \end{array} = t_k \begin{array}{c} \uparrow \\ k \end{array}$$

Lemma 1.9. $t_k = (-1)^k q^{-ekn} q^{ek(k-1)}$.

Note that this formula explains the choice for the half twists.

Proof. We claim that $t_{k+1}t_k^{-1} = -q^{2ek-en}$. Indeed, the following relation holds from already proven Kauffman relation:

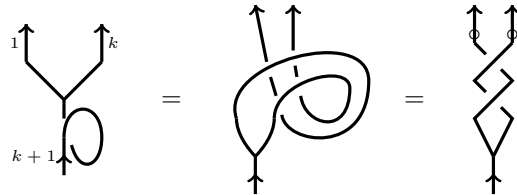

The equality of the LHS and RHS parts implies the recurrence relation. The general solution follows then from the computation of the value for a 1-strand. An explicit computation for this gives $t_1 = -q^{-en}$. \square

We are now ready to prove the last relation by induction:

Lemma 1.10.

$$\begin{array}{c} \uparrow \quad \uparrow \\ l \quad r \\ \diagdown \quad \diagup \\ \diagup \quad \diagdown \\ \uparrow \\ k \end{array} = \begin{array}{c} \uparrow \quad \uparrow \\ r \quad l \\ \oplus_{\frac{-1}{2}} \quad \oplus_{\frac{-1}{2}} \\ \oplus_{\frac{1}{2}} \\ \uparrow \\ k \end{array}$$

Proof. The computation is easy for $r = 1$ or $l = 1$. Then we use:

$$\begin{aligned}
 & \begin{array}{c} r \uparrow \quad l \uparrow \\ \diagdown \quad \diagup \\ \text{---} \\ \diagup \quad \diagdown \\ k \uparrow \end{array} = \frac{1}{[l]} \begin{array}{c} r \uparrow \quad l \uparrow \\ \diagdown \quad \diagup \\ \text{---} \\ \diagup \quad \diagdown \\ k \uparrow \end{array} = \frac{1}{[l]} \begin{array}{c} r \uparrow \quad l \uparrow \\ \diagdown \quad \diagup \\ \text{---} \\ \diagup \quad \diagdown \\ k \uparrow \end{array} = \frac{1}{[l]} \begin{array}{c} r \uparrow \quad l \uparrow \\ \diagdown \quad \diagup \\ \text{---} \\ \diagup \quad \diagdown \\ k \uparrow \end{array} = \frac{a_{r+1}^{\frac{1}{2}} a_r^{-\frac{1}{2}} a_1^{-\frac{1}{2}}}{[l]} \begin{array}{c} r \uparrow \quad l \uparrow \\ \diagdown \quad \diagup \\ \text{---} \\ \diagup \quad \diagdown \\ k \uparrow \end{array} \\
 & = \frac{a_{r+1}^{\frac{1}{2}} a_r^{-\frac{1}{2}} a_1^{-\frac{1}{2}}}{[l]} \begin{array}{c} r \uparrow \quad l \uparrow \\ \diagdown \quad \diagup \\ \text{---} \\ \diagup \quad \diagdown \\ k \uparrow \end{array} = \frac{a_{r+1}^{\frac{1}{2}} a_r^{-\frac{1}{2}} a_1^{-\frac{1}{2}} a_{k-1}^{\frac{1}{2}} a_{l-1}^{-\frac{1}{2}} a_r^{-\frac{1}{2}}}{[l]} \begin{array}{c} r \uparrow \quad l \uparrow \\ \diagdown \quad \diagup \\ \text{---} \\ \diagup \quad \diagdown \\ k \uparrow \end{array} \\
 & = a_{r+1}^{\frac{1}{2}} a_r^{-\frac{1}{2}} a_1^{-\frac{1}{2}} a_{k-1}^{\frac{1}{2}} a_{l-1}^{-\frac{1}{2}} a_r^{-\frac{1}{2}} \begin{array}{c} r \uparrow \quad l \uparrow \\ \diagdown \quad \diagup \\ \text{---} \\ \diagup \quad \diagdown \\ k \uparrow \end{array} .
 \end{aligned}$$

An explicit computation of the coefficient shows that the previous term equals:

$$\begin{array}{c} r \uparrow \quad l \uparrow \\ \text{---} \\ \diagdown \quad \diagup \\ \text{---} \\ \diagup \quad \diagdown \\ k \uparrow \end{array} ,$$

which completes the proof. □

We therefore obtain a well-defined skein module providing an invariant of knotted webs.

Note that in the \mathfrak{sl}_3 case, 2-strands are usually translated into 1-strands by reversing the orientation. In this case, smoothings of crossings would be defined only up to a power of q , and understanding a skew-Howe based way to fix this power seems difficult. We choose here not to apply this duality process and keep distinct 1- and 2-strands with their own orientations, and more generally to keep all strands numbered $1 \dots n$ in the \mathfrak{sl}_n case, with their orientation.

So, we have seen that to a web-tangle in ladder position, we can assign a $U_q(\mathfrak{sl}_n)$ morphism of tensor product of minuscule representations. The diagrammatic form of this morphism corresponds to the image of the same web-tangle in the \mathfrak{sl}_n skein module. If we start with a non-ladder web, we can assign to it its skein element, but the skew-Howe process does not directly apply. Cautis, Kamnitzer and Morrison [6] explain a process for turning upward webs to ladder form, which we summarize in the following section.

1.2.4. *Turning a knot to a ladder.* Let us now consider a tangle T (possibly a web-tangle) with only upward boundaries. Following Cautis-Kamnitzer-Morrison, we can present it as:

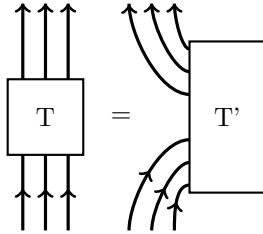

The left part of the RHS is easily presentable as a ladder. The tangle T' is assumed to be presented as a horizontal grid diagram generated by caps, cups and crossings (plus 3-valent vertices for webs). We request to have all crossings vertical, which is possible up to some isotopy. So, two caps or cups cannot lie one over the other one, and we determine the number of n -strands we will have to add as the number of elementary pieces that contain a downward strand: we will then put a strand on the right of this place. Let this number be denoted α . This being done, start over, but adjoining on the right of T α upward n -strands placed at the right place.

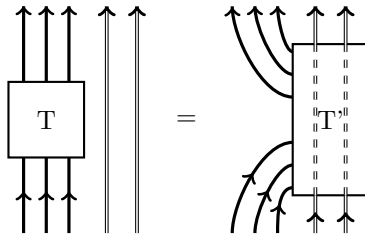

By performing some moves and simplifications near the downward strands, we get a ladder L . These local changes Cautis-Kamnitzer-Morrison perform are smoothings and simplifications of some Reidemeister moves, and so the image of the tangle is equal in the previous skein module to T with α disjoint n -strands added to it.

For example, if we start from the elementary web we considered in the introduction:

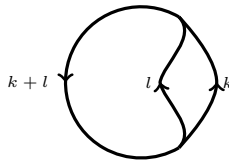

we can add on the right one n -labeled strand and perform Reidemeister-Kauffman moves:

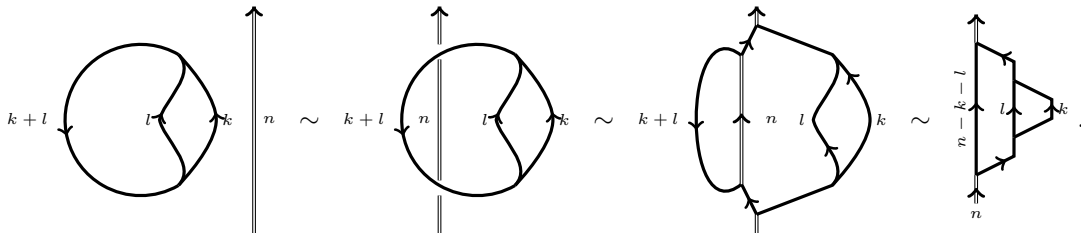

The last isomorphism above is a digon removal, which can be found in [6] for example.

So, from any upward web-tangle union n -strands, we can obtain by a succession of Reidemeister moves and equivalences a ladder diagram. The morphism of representation we compute by the skew

Howe process has then a diagrammatic depiction equivalent to the skein element associated to the web-tangle we started from union the n -strands.

Note now that instead of pulling n -strands from far away, we could have performed a Jones-Kauffman product. Recall that the skein module may be endowed with an algebra structure by defining $\alpha * \beta$ to be the smoothing of the superposition of diagrams of α over β . This superposition is usually assumed to be a knotted web diagram, meaning that the only singularities are crossings. However, we can allow a singular case:

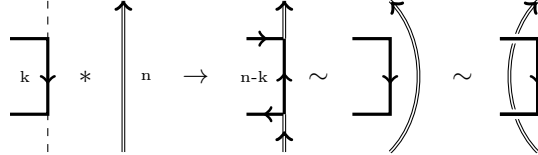

where the dashed line on the left above indicates the place we want to put the n strand: this allows not to perform any simplification on the diagram. This re-interpretation of the process will show useful when we turn to the annular case, where we have no free space where to put the n -strands before pulling them on the place they are needed.

We have seen here only the case where all the boundary of the tangle is upward. First, notice that this is enough for dealing with knots. However, as explained in [6], any tangle is actually isomorphic to such an upward tangle.

2. AFFINE EXTENSIONS

We have seen how the skew-Howe duality process, that involves two commuting actions of $U_q(\mathfrak{sl}_n)$ and $U_q(\mathfrak{sl}_m)$, helps redefining Reshetikhin-Turaev \mathfrak{sl}_n invariants for knots and links, that extend to invariants of knotted webs. The first quantum group controls the invariant we are looking at, and we therefore want to keep it unchanged. But the second one plays the role of a parameter related to the topology of the space we are working in. We can thus try to modify the topology of this space.

One of the easiest extensions we can perform starting from $U_q(\mathfrak{sl}_m)$ is to pass to its affine version $U_q(\widehat{\mathfrak{sl}_m})$, and we will show that the topological analogue of this is to close the square the knots were drawn in into an annulus.

We begin by defining different versions of the quantum affine algebra $U_q(\widehat{\mathfrak{sl}_m})$ that we will use here, before turning toward easy representations of it. We then relate this extension to knots, and study the invariants we can deduce from it.

2.1. **Affine \mathfrak{sl}_m .** $U_q(\widehat{\mathfrak{sl}_m})$ is the quantum affine algebra corresponding to $U_q(\mathfrak{sl}_m)$, that is the Kac-Moody algebra described by the following Dynkin diagram:

$$(2.1) \quad \begin{array}{ccccccc} & 1 & 2 & \dots & m-2 & m-1 & \\ & \circ & \circ & \dots & \circ & \circ & \\ & \diagdown & & & & \diagup & \\ & & & & & & \circ \\ & & & & & & 0 \end{array}$$

Following [13], we consider the algebra $U_q(\widehat{\mathfrak{sl}_m})$ as generated by Chevalley generators E_i, F_i and $K_i^{\pm 1}$ for $0 \leq i \leq m - 1$, and extra generators $K_d^{\pm 1}$ corresponding to the null root. The elements E_i, F_i and $K_i^{\pm 1}$ are subject to \mathfrak{sl}_m relations, where we identify m and 0 , so that the quantum Serre relations

hold for pairs (E_0, E_1) , (F_0, F_1) , (E_0, E_{m-1}) and (F_0, F_{m-1}) :

$$\begin{aligned}
K_i K_i^{-1} &= K_i^{-1} K_i = 1 & , & & K_i K_j &= K_j K_i, \\
K_i E_j K_i^{-1} &= q^{a_{ij}} E_j & , & & K_i F_j K_i^{-1} &= q^{-a_{ij}} F_j, \\
E_i F_j - F_j E_i &= \delta_{ij} \frac{K_i - K_i^{-1}}{q - q^{-1}}, \\
E_i^2 E_j - (q + q^{-1}) E_i E_j E_i + E_j E_i^2 &= 0 & \text{if } j = i \pm 1, \\
F_i^2 F_j - (q + q^{-1}) F_i F_j F_i + F_j F_i^2 &= 0 & \text{if } j = i \pm 1, \\
E_i E_j &= E_j E_i & , & & F_i F_j &= F_j F_i \text{ if } |i - j| > 1.
\end{aligned}$$

Furthermore, K_d and K_d^{-1} are subject to the following relations:

$$\begin{aligned}
K_d K_i &= K_i K_d \quad \forall i \in \{0, \dots, m-1\} \\
K_d E_i K_d^{-1} &= q^{\delta_{0,i}} E_i \quad \forall i \in \{0, \dots, m-1\} \\
K_d F_i K_d^{-1} &= q^{-\delta_{0,i}} F_i \quad \forall i \in \{0, \dots, m-1\}.
\end{aligned}$$

If we restrict to the sub-algebra generated by E_i , F_i and $K_i^{\pm 1}$, we produce a quantum group usually denoted $U'_q(\widehat{\mathfrak{sl}}_m)$. A key difference between the two versions is that the second one has finite dimensional irreducible modules, while the first one admits no non-trivial finite dimensional representations.

We will also use an idempotent version of $U'_q(\widehat{\mathfrak{sl}}_m)$, that we denote $\dot{U}'_q(\widehat{\mathfrak{sl}}_m)$, generated by $\mathbf{1}_\lambda$, $E_i \mathbf{1}_\lambda$ and $F_i \mathbf{1}_\lambda$ with the obvious generalization of the relations of the \mathfrak{sl}_m case. Weights here are m -tuples $\lambda = (\lambda_0, \dots, \lambda_{m-1})$, which in our case, with N fixed, will be related to the sequences (a_1, \dots, a_m) by $\lambda_i = a_{i+1} - a_i$ for $i \neq 0$ and $\lambda_0 = a_1 - a_m$. Note that we have $\sum \lambda_i = 0$.

2.2. Evaluation representations. $U_q(\mathfrak{sl}_m)$ -representations may be extended to representations of $U'_q(\widehat{\mathfrak{sl}}_m)$. The complete formulas (that require a step through $U_q(\mathfrak{gl}_m)$) can be found in [8, p. 400]. These formulas seem at first a bit mysterious, and rather than directly using them, we choose to define differently extensions based on the use of the braidings $T''_{i,e}$ and $T_{i,e}$. We will denote by ρ_a and $\tilde{\rho}_a$ the two morphisms used in these definitions. We will then investigate *a posteriori* the relation with usual formulas as written in [8] in Proposition 2.3.

First, recall that $C_{T''_{i,e}}$ is the automorphism of $U_q(\mathfrak{sl}_m)$ (or its idempotent version) given by conjugation by $T''_{i,e}$ (that is, $X \in U_q(\mathfrak{sl}_m) \mapsto T''_{i,e} X T''_{i,e}^{-1}$). We assume here that whenever we refer to a weight λ , a number N is fixed, and we freely refer to the associated m -tuple (a_1, \dots, a_m) .

For a complex number, define $\rho_a : \dot{U}'_q(\widehat{\mathfrak{sl}}_m) \mapsto \dot{U}'_q(\mathfrak{sl}_m)$ by:

$$\begin{aligned}
\rho_a(E_0 \mathbf{1}_\lambda) &= a q^{-e(a_1 + a_m)} C_{T''_{m-1,e}} \cdots C_{T''_{2,e}} (F_1) \mathbf{1}_\lambda, \\
\rho_a(F_0 \mathbf{1}_\lambda) &= a^{-1} q^{e(a_1 + a_m)} C_{T''_{m-1,e}} \cdots C_{T''_{2,e}} (E_1) \mathbf{1}_\lambda.
\end{aligned}$$

ρ_a is extended to other generators E_i ($i \neq 0$) by sending $E_i \in U_q(\widehat{\mathfrak{sl}}_m)$ to $E_i \in U_q(\mathfrak{sl}_m)$, and similarly for F_i .

In terms of the graphical calculus previously defined, this can be drawn as:

$$(2.2) \quad E_0 \mathbf{1}_\lambda \mapsto a q^{-e(a_1+a_m)} \quad , \quad F_0 \mathbf{1}_\lambda \mapsto a^{-1} q^{e(a_1+a_m)} .$$

The above depiction corresponds to letting $\widehat{U}_q(\mathfrak{sl}_m)$ act on a tensor product of minuscule representations of $U_q(\mathfrak{sl}_m)$ via the map ρ_a . This diagrammatic definition gives us an easy way to reprove (in Proposition 2.1) in a diagrammatic fashion the results of [8, Prop 12.2.10] applied to these particular representations $\bigwedge_q(\mathbb{C}^n \otimes \mathbb{C}^m)$. However, since all fundamental $U_q(\mathfrak{sl}_m)$ representations $\bigwedge_q^k(\mathbb{C}^m)$ appear as summands of a $\bigwedge^N(\mathbb{C}^n \otimes \mathbb{C}^m)$, using the coproduct, we can recover from this construction all evaluation representations associated to finite-dimensional representations.

The relations in Propositions 1.1 and 1.2 together with the fact that the $T''_{i,e}$'s provide a braiding give the next useful diagrammatic relations:

$$(2.3) \quad \text{Diagram 1} = \text{Diagram 2}$$

$$(2.4) \quad \text{Diagram 1} = -q^{e(a_i-a_{i+1})} \text{Diagram 2} , \quad \text{Diagram 3} = -q^{e(a_i-a_{i+1})} \text{Diagram 4}$$

$$(2.5) \quad \text{Diagram 1} = -q^{e(a_i-a_{i+1})} \text{Diagram 2} , \quad \text{Diagram 3} = -q^{e(a_i-a_{i+1})} \text{Diagram 4}$$

Proposition 2.1. The action of $\widehat{U}_q(\mathfrak{sl}_m)$ on $\bigwedge_q(\mathbb{C}^n \otimes \mathbb{C}^m)$ extends via ρ_a to an action of $\widehat{U}'_q(\mathfrak{sl}_m)$.

Proof. The proof consists on checking the defining relations of $\widehat{\mathbf{U}}'_q(\mathfrak{sl}_m)$ that involve E_0 or F_0 , that is:

$$\begin{aligned}
[E_0, F_0]\mathbf{1}_\lambda &= [\lambda_0]\mathbf{1}_\lambda \\
[E_0, F_j]\mathbf{1}_\lambda = 0 \quad , \quad [F_0, E_j]\mathbf{1}_\lambda &= 0 \\
E_0^2 E_j \mathbf{1}_\lambda - (q + q^{-1}) E_0 E_j E_0 \mathbf{1}_\lambda + E_j E_0^2 \mathbf{1}_\lambda &= 0 \text{ if } j = 1 \text{ or } j = m - 1 \\
E_j^2 E_0 \mathbf{1}_\lambda - (q + q^{-1}) E_j E_0 E_j \mathbf{1}_\lambda + E_0 E_j^2 \mathbf{1}_\lambda &= 0 \text{ if } j = 1 \text{ or } j = m - 1 \\
F_0^2 F_j \mathbf{1}_\lambda - (q + q^{-1}) F_0 F_j F_0 \mathbf{1}_\lambda + F_j F_0^2 \mathbf{1}_\lambda &= 0 \text{ if } j = 1 \text{ or } j = m - 1 \\
F_j^2 F_0 \mathbf{1}_\lambda - (q + q^{-1}) F_j F_0 F_j \mathbf{1}_\lambda + F_0 F_j^2 \mathbf{1}_\lambda &= 0 \text{ if } j = 1 \text{ or } j = m - 1 \\
E_0 E_j = E_j E_0 \quad , \quad F_0 F_j &= F_j F_0 \text{ if } j \neq 1 \text{ and } j \neq m - 1.
\end{aligned}$$

By symmetry between the E 's and the F 's, it is enough to check only relations involving E_0 and E_j or F_j , plus the first one. The proof mostly relies on a straightforward use of Relations 2.3, 2.4, 2.5, and the braiding relation. We present some of them below, where we identify an element of $\widehat{\mathbf{U}}'_q(\mathfrak{sl}_m)$ with its image under the representation.

$$\begin{aligned}
[E_0, F_0]\mathbf{1}_\lambda &= E_0 F_0 \mathbf{1}_\lambda - F_0 E_0 \mathbf{1}_\lambda = q^0 [C_{T_{w,e}''}(F_1), C_{T_{w,e}''}(E_1)]\mathbf{1}_\lambda = C_{T_{w,e}''}([F_1, E_1]\mathbf{1}_{w \cdot \lambda}) \\
&= C_{T_{w,e}''}(-[(w^{-1} \cdot \lambda)_1])\mathbf{1}_\lambda = -(-[\lambda_0])\mathbf{1}_\lambda = [\lambda_0]\mathbf{1}_\lambda.
\end{aligned}$$

Under the braiding relation, we can reduce $[E_0, F_1]$ to:

$$[E_0, F_1]\mathbf{1}_\lambda = aq^{e(-a-1-c)} \begin{array}{c} \uparrow \quad \uparrow \quad \uparrow \\ | \quad | \quad | \\ \diagdown \quad \diagup \quad | \\ | \quad | \quad | \\ \diagup \quad \diagdown \quad | \\ \uparrow \quad \uparrow \quad \uparrow \\ a \quad b \quad c \end{array} - aq^{e(-a-c)} \begin{array}{c} \uparrow \quad \uparrow \quad \uparrow \\ | \quad | \quad | \\ | \quad | \quad | \\ \diagdown \quad \diagup \quad | \\ | \quad | \quad | \\ \diagup \quad \diagdown \quad | \\ \uparrow \quad \uparrow \quad \uparrow \\ a \quad b \quad c \end{array}$$

which equals

$$\begin{aligned}
 &= aq^{e(-a-1-c)} \begin{array}{c} \uparrow \uparrow \uparrow \\ \diagdown \diagup \diagdown \diagup \\ \uparrow \uparrow \uparrow \\ a \quad b \quad c \end{array} - aq^{e(-a-c)} \begin{array}{c} \uparrow \uparrow \uparrow \\ \diagup \diagdown \diagup \diagdown \\ \uparrow \uparrow \uparrow \\ a \quad b \quad c \end{array} \\
 &= aq^{e(-a-1-c)}(-q^{e(-a-1+b-1)}) \begin{array}{c} \uparrow \uparrow \uparrow \\ \diagdown \diagup \diagdown \diagup \\ \uparrow \uparrow \uparrow \\ a \quad b \quad c \end{array} - aq^{e(-a-c)}(-q^{e(-a-2+b-1)}) \begin{array}{c} \uparrow \uparrow \uparrow \\ \diagup \diagdown \diagup \diagdown \\ \uparrow \uparrow \uparrow \\ a \quad b \quad c \end{array}
 \end{aligned}$$

We then obtain:

$$-aq^{-2ea+eb-ec-3e} \left(\begin{array}{c} \uparrow \uparrow \uparrow \\ \diagdown \diagup \diagdown \diagup \\ \uparrow \uparrow \uparrow \\ a \quad b \quad c \end{array} - \begin{array}{c} \uparrow \uparrow \uparrow \\ \diagup \diagdown \diagup \diagdown \\ \uparrow \uparrow \uparrow \\ a \quad b \quad c \end{array} \right) = 0$$

using the $U_q(\mathfrak{sl}_m)$ relation $[E_1, F_2] = 0$. We now turn to:

$$E_0^2 E_1 - (q + q^{-1}) E_0 E_1 E_0 + E_1 E_0^2 = a^2 q^{e(-2a-2c+2)}$$

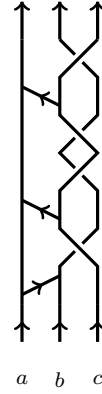

$$-a^2(q + q^{-1})q^{e(-2a-2c+1)}$$

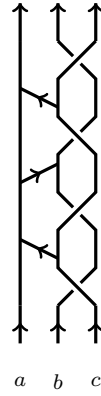

$$+ a^2 q^{e(-2a-2c)}$$

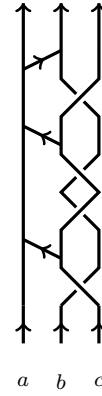

$$= a^2 q^{e(-2a-2c+2)}$$

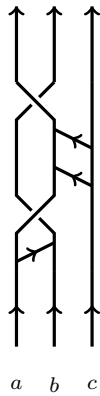

$$- (q + q^{-1}) a^2 q^{e(-2a-2c+1)}$$

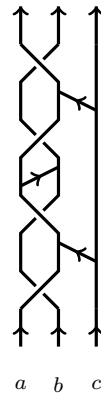

$$+ a^2 q^{e(-2a-2c)}$$

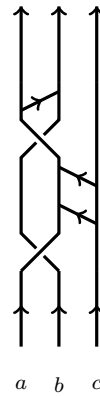

$$\begin{aligned}
 &= -a^2 q^{e(-a-b-2c+2)} \begin{array}{c} \uparrow \uparrow \uparrow \\ \diagdown \quad \diagup \\ \uparrow \quad \uparrow \\ \diagup \quad \diagdown \\ \uparrow \quad \uparrow \\ \uparrow \quad \uparrow \\ a \quad b \quad c \end{array} + a^2 (q + q^{-1}) q^{e(-a-b-2c+2)} \begin{array}{c} \uparrow \uparrow \uparrow \\ \diagdown \quad \diagup \\ \uparrow \quad \uparrow \\ \diagup \quad \diagdown \\ \uparrow \quad \uparrow \\ \uparrow \quad \uparrow \\ a \quad b \quad c \end{array} - a^2 q^{e(-a-b-2c+2)} \begin{array}{c} \uparrow \uparrow \uparrow \\ \diagdown \quad \diagup \\ \uparrow \quad \uparrow \\ \diagup \quad \diagdown \\ \uparrow \quad \uparrow \\ \uparrow \quad \uparrow \\ a \quad b \quad c \end{array}
 \end{aligned}$$

The latter equals 0 since $F_2^2 F_1 - (q + q^{-1}) F_2 F_1 F_2 + F_1 F_2^2 = 0$.

□

Note that the usual definition of the evaluation representations requires to have a $U_q(\mathfrak{gl}_m)$ action. In our case, the $U_q(\mathfrak{sl}_m)$ action, with a choice of N made, is actually a disguised $U_q(\mathfrak{gl}_m)$ -representation, and the factor $q^{\pm(a_1+a_m)}$ utilizes this \mathfrak{gl}_m -information.

It will be useful when we turn to skein modules to rescale the braidings and replace the $T''_{i,e}$'s by the $T_{i,e}$'s. Doing so, we have analogues of Relations 2.3, 2.4 and 2.5:

$$\begin{array}{c}
 \begin{array}{c} \uparrow \uparrow \uparrow \\ \diagdown \quad \diagup \\ \uparrow \quad \uparrow \\ \diagup \quad \diagdown \\ \uparrow \quad \uparrow \\ \uparrow \quad \uparrow \\ a_i \quad a_{i+1} \end{array} = \begin{array}{c} \uparrow \uparrow \uparrow \\ \diagdown \quad \diagup \\ \uparrow \quad \uparrow \\ \diagup \quad \diagdown \\ \uparrow \quad \uparrow \\ \uparrow \quad \uparrow \\ a_i \quad a_{i+1} \end{array} \\
 \\
 (2.6) \quad \begin{array}{c} \uparrow \uparrow \\ \diagdown \quad \diagup \\ \uparrow \quad \uparrow \\ \diagup \quad \diagdown \\ \uparrow \quad \uparrow \\ a_i \quad a_{i+1} \end{array} = -q^{e(a_i - a_{i+1} + 1)} \begin{array}{c} \uparrow \uparrow \\ \diagdown \quad \diagup \\ \uparrow \quad \uparrow \\ \diagup \quad \diagdown \\ \uparrow \quad \uparrow \\ a_i \quad a_{i+1} \end{array}, \quad \begin{array}{c} \uparrow \uparrow \\ \diagdown \quad \diagup \\ \uparrow \quad \uparrow \\ \diagup \quad \diagdown \\ \uparrow \quad \uparrow \\ a_i \quad a_{i+1} \end{array} = -q^{e(a_i - a_{i+1} - 1)} \begin{array}{c} \uparrow \uparrow \\ \diagdown \quad \diagup \\ \uparrow \quad \uparrow \\ \diagup \quad \diagdown \\ \uparrow \quad \uparrow \\ a_i \quad a_{i+1} \end{array} \\
 \\
 (2.7) \quad \begin{array}{c} \uparrow \uparrow \\ \diagdown \quad \diagup \\ \uparrow \quad \uparrow \\ \diagup \quad \diagdown \\ \uparrow \quad \uparrow \\ a_i \quad a_{i+1} \end{array} = -q^{e(a_i - a_{i+1} + 1)} \begin{array}{c} \uparrow \uparrow \\ \diagdown \quad \diagup \\ \uparrow \quad \uparrow \\ \diagup \quad \diagdown \\ \uparrow \quad \uparrow \\ a_i \quad a_{i+1} \end{array}, \quad \begin{array}{c} \uparrow \uparrow \\ \diagdown \quad \diagup \\ \uparrow \quad \uparrow \\ \diagup \quad \diagdown \\ \uparrow \quad \uparrow \\ a_i \quad a_{i+1} \end{array} = -q^{e(a_i - a_{i+1} - 1)} \begin{array}{c} \uparrow \uparrow \\ \diagdown \quad \diagup \\ \uparrow \quad \uparrow \\ \diagup \quad \diagdown \\ \uparrow \quad \uparrow \\ a_i \quad a_{i+1} \end{array}
 \end{array}$$

We denote $\tilde{\rho}_a$, for a complex number, the analogue of ρ_a :

$$\begin{aligned}
 \tilde{\rho}_a(E_0 \mathbf{1}_\lambda) &= a q^{-e(a_1+a_m)} C_{T_{m-1,e}} \cdots C_{T_{2,e}}(F_1) \mathbf{1}_\lambda, \\
 \tilde{\rho}_a(F_0 \mathbf{1}_\lambda) &= a^{-1} q^{e(a_1+a_m)} C_{T_{m-1,e}} \cdots C_{T_{2,e}}(E_1) \mathbf{1}_\lambda.
 \end{aligned}$$

ρ_a and $\tilde{\rho}_a$ are defined similarly for other generators.

The proof of Proposition 2.1 remains valid if we replace the braidings $T''_{i,e}$'s by the (\mathfrak{gl}_m) rescaled $T_{i,e}$'s.

Proposition 2.2. The action of $\dot{U}_q(\mathfrak{sl}_m)$ on $\bigwedge_q(\mathbb{C}^n \otimes \mathbb{C}^m)$ extends via $\widetilde{\rho}_a$ to an action of $\dot{U}'_q(\widehat{\mathfrak{sl}_m})$.

Now, using the fact that the rescaled braidings $T''_{i,e}$ allow some liberty, we can give a *posteriori* a formula very close to Chari-Pressley original evaluation representations [8].

Assume that we have chosen a square root $q^{\frac{1}{2}}$ of q , and define the bracket $[\cdot, \cdot]_{q^{\frac{1}{2}}}$ by $[u, v]_{q^{\frac{1}{2}}} = q^{\frac{1}{2}}uv - q^{-\frac{1}{2}}vu$.

Proposition 2.3. If $e = -1$, we have:

$$\begin{aligned} \widetilde{\rho}_a(E_0 \mathbf{1}_\lambda) &= aq^{a_1+a_m-\frac{m-2}{2}} [[\dots [F_1, F_2]_{q^{\frac{1}{2}}} \dots, F_{m-2}]_{q^{\frac{1}{2}}}, F_{m-1}]_{q^{\frac{1}{2}}} \\ &= aq^{a_1+a_m-\frac{m-2}{2}} [F_1, [F_2, \dots, [F_{m-2}, F_{m-1}]_{q^{\frac{1}{2}}} \dots]_{q^{\frac{1}{2}}}]_{q^{\frac{1}{2}}}, \end{aligned}$$

and if $e = 1$, we have:

$$\begin{aligned} \widetilde{\rho}_a(E_0 \mathbf{1}_\lambda) &= (-1)^{m-2} aq^{-a_1-a_m+\frac{m-2}{2}} [F_{m-1}, [F_{m-2}, \dots, [F_2, F_1]_{q^{\frac{1}{2}}} \dots]_{q^{\frac{1}{2}}}]_{q^{\frac{1}{2}}} \\ &= (-1)^{m-2} aq^{-a_1-a_m+\frac{m-2}{2}} [[\dots [F_{m-1}, F_{m-2}]_{q^{\frac{1}{2}}} \dots, F_2]_{q^{\frac{1}{2}}}, F_1]_{q^{\frac{1}{2}}}. \end{aligned}$$

Proof. The core of the identification is to understand the bracket process in the diagrammatic definition. By Reidemeister or Kauffman-type moves, we can rewrite $\widetilde{\rho}_a(E_0 \mathbf{1}_\lambda)$ as (which doesn't make sense in $U_q(\mathfrak{sl}_m)$ anymore):

$$(2.8) \quad E_0 \mathbf{1}_\lambda \mapsto aq^{-e(a_1+a_m)} \begin{array}{c} \begin{array}{cccc} \uparrow & \uparrow & \uparrow & \uparrow \\ | & | & | & | \\ \diagdown & \dots & \diagup & | \\ | & & | & | \\ \uparrow & \uparrow & \uparrow & \uparrow \\ a_1 & a_2 & a_{m-1} & a_m \end{array} \end{array}$$

Then, we can smooth the rightmost crossing using:

$$(2.9) \quad \begin{array}{c} \begin{array}{cc} 1 & k \\ \diagdown & \diagup \\ k & 1 \end{array} = -q^e \begin{array}{c} \begin{array}{cc} 1 & k \\ | & | \\ \diagdown & \diagup \\ k & 1 \end{array} + \begin{array}{c} \begin{array}{cc} 1 & k \\ | & | \\ \diagup & \diagdown \\ k & 1 \end{array} \end{array} \end{array}$$

This gives:

$$\begin{aligned}
 E_0 \mathbf{1}_\lambda &\mapsto -q^e a q^{-e(a_1+a_m)} \left[\begin{array}{c} \uparrow \uparrow \dots \uparrow \uparrow \\ | | \dots | | \\ \swarrow \quad \nearrow \\ | | \dots | | \\ \uparrow \uparrow \dots \uparrow \uparrow \\ a_1 \quad a_2 \quad \dots \quad a_{m-1} \quad a_m \end{array} \right] + a q^{-e(a_1+a_m)} \left[\begin{array}{c} \uparrow \uparrow \dots \uparrow \uparrow \\ | | \dots | | \\ \swarrow \quad \nearrow \\ | | \dots | | \\ \uparrow \uparrow \dots \uparrow \uparrow \\ a_1 \quad a_2 \quad \dots \quad a_{m-1} \quad a_m \end{array} \right] \\
 &= -q^e a q^{-e(a_1+a_m)} F_{m-1} \left[\begin{array}{c} \uparrow \uparrow \dots \uparrow \uparrow \\ | | \dots | | \\ \swarrow \quad \nearrow \\ | | \dots | | \\ \uparrow \uparrow \dots \uparrow \uparrow \\ a_1 \quad a_2 \quad \dots \quad a_{m-1} \quad a_m \end{array} \right] + a q^{-e(a_1+a_m)} \left[\begin{array}{c} \uparrow \uparrow \dots \uparrow \uparrow \\ | | \dots | | \\ \swarrow \quad \nearrow \\ | | \dots | | \\ \uparrow \uparrow \dots \uparrow \uparrow \\ a_1 \quad a_2 \quad \dots \quad a_{m-1} \quad a_m \end{array} \right] F_{m-1}
 \end{aligned}$$

Depending on the value of e , this gives one or the other bracket, and we can iterate by smoothing successive crossings. This proves the first part of each equality. For the second part, we perform the same process, but we start with the left-most crossing. \square

Because of the similarity of this definition with the usual one, we will from now on refer to the representations induced by $\tilde{\rho}_a$ as *evaluation representations*.

This process helps us extending $\Lambda_q(\mathbb{C}^n \otimes \mathbb{C}^m)$ to a $U'_q(\widehat{\mathfrak{sl}}_m)$ representation. The $U'_q(\widehat{\mathfrak{sl}}_m)$ and $U_q(\mathfrak{sl}_n)$ actions still commute, but this certainly cannot provide new information, since the new representation is entirely built on the old one. An extension of this representation will be studied later.

Since the usual skew Howe duality context is closely related to skein modules (or spider categories), it is natural to wonder if we can understand a skein analogue for the evaluation representations. It appears that closing the Dynkin diagram of \mathfrak{sl}_n corresponds to gluing two opposite sides of the box on which one usually looks at tangles: this produces an annulus.

2.3. Annular knots. Represent $\Lambda_q^N(\mathbb{C}^n \otimes \mathbb{C}^m) \simeq \bigoplus_{a_1+\dots+a_m=N} \Lambda_q^{a_1}(\mathbb{C}^n) \otimes \dots \otimes \Lambda_q^{a_m}(\mathbb{C}^n)$ by a sequence (a_1, \dots, a_m) , as before, but now drawn on a circle instead of drawing it on a segment, so that a_1 and a_m lie next to each other. E_0 is a map: $\Lambda_q^{a_1}(\mathbb{C}^n) \otimes \dots \otimes \Lambda_q^{a_m}(\mathbb{C}^n) \rightarrow \Lambda_q^{a_1+1}(\mathbb{C}^n) \otimes \dots \otimes \Lambda_q^{a_m-1}(\mathbb{C}^n)$. This idea gives a diagrammatic presentation of the affine extension of the skew Howe duality phenomenon. See below the diagram corresponding to $E_0 E_1$ acting on a sequence $(2, 0)$, with $m = 2, n = 2, N = 2$.

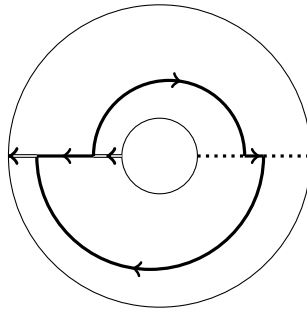

Annular webs can be defined in a very similar fashion as in the plane case. One just embeds trivalent graphs in the annulus instead of the plane, and all relations being local, they look the same for webs considered in any surface.

Definition 2.4. Let $n\mathbf{AWeb}$, the \mathfrak{sl}_n annular web skein module, be the $\mathbb{Z}[q, q^{-1}]$ generated by annular webs (oriented trivalent graphs with preserved flow embedded in an annulus) possibly with boundary (embedded in the two boundary circles of the annulus) up to isotopy and the local \mathfrak{sl}_n web relations (1.6), (1.7) and (1.8).

All web relations and all $\widehat{\mathfrak{sl}}_m$ relations being “local relations”, it is easy to observe that web relations are implied by $\widehat{\mathfrak{sl}}_m$. However, if we consider the evaluation representation for extending the \mathfrak{sl}_m action, there are other relations than web relations: for example, the above diagram corresponds to a scalar action, while in the skein module, this would rather correspond to a generator. We shall first identify here a skein module that corresponds to these representations, before seeking for a situation closer to the skein module of the annulus. For this purpose, let us introduce the annular extension of the category $n\mathbf{Web}_m^+$.

Definition 2.5. Define $n\mathbf{AWeb}_m^+$ to be the category with objects, sequences (a_1, \dots, a_m) ($0 \leq a_i \leq n$) labeling points regularly drawn on a circle, together with a zero object. Points labeled by zero can be erased, but, as in [2] and [26], we will keep the n -strands as well. Morphisms are formal sums over $\mathbb{Z}[q^{\pm 1}]$ of upward \mathfrak{sl}_n -webs (in the sense of Definition 2.4) drawn on a cylinder, generated by⁵:

$$E_i \mathbf{1}_\lambda = \begin{array}{c} a_i - 1 \\ \nearrow \quad \searrow \\ \text{---} \text{---} \text{---} \\ \searrow \quad \nearrow \\ a_i a_{i+1} \\ \text{---} \text{---} \text{---} \\ \nearrow \quad \searrow \\ a_{i+1} + 1 \end{array} \quad \text{and} \quad F_i \mathbf{1}_\lambda = \begin{array}{c} a_i + 1 \\ \nearrow \quad \searrow \\ \text{---} \text{---} \text{---} \\ \searrow \quad \nearrow \\ a_i a_{i+1} \\ \text{---} \text{---} \text{---} \\ \nearrow \quad \searrow \\ a_{i+1} - 1 \end{array}$$

In the above pictures, we have drawn only strands i and $i + 1$.

$n\mathbf{AWeb}_m^+(N)$ will be the full subcategory with objects such that $\sum a_i = N$.

Given m, n, N , we can define on weights a map Φ that sends $\lambda = (\lambda_0, \dots, \lambda_{m-1})$ to a sequence (a_1, \dots, a_m) such that $a_{i+1} - a_i = \lambda_i$ and $a_1 - a_{m-1} = \lambda_0$, with $\sum a_i = N$. If such a solution doesn't exist, the weight is sent to the zero object.

Proposition 2.6. For all m, n, N , there is a functor $\Phi : \dot{\mathbf{U}}'_q(\widehat{\mathfrak{sl}}_m) \mapsto n\mathbf{AWeb}_m^+(N)$ defined on weights as above and on morphisms by $E_i \mathbf{1}_\lambda \mapsto E_i \mathbf{1}_\lambda$ and $F_i \mathbf{1}_\lambda \mapsto F_i \mathbf{1}_\lambda$.

$\widehat{\mathfrak{sl}}_m$ relations are locally \mathfrak{sl}_m relations: the proof is straightforward. [4, Prop 7.4] will receive a direct translation. Let us consider a knotted annular tangle as a composition of $E_i \mathbf{1}_\lambda$, $F_i \mathbf{1}_\lambda$ and crossings between the i -th and $(i+1)$ -th strands. From such a presentation, we can read off an element of $\dot{\mathbf{U}}'_q(\widehat{\mathfrak{sl}}_m)$,

⁵Note that this a priori doesn't recover the complete braid group of the annulus. We miss in the braid group associated to $U_q(\widehat{\mathfrak{sl}}_m)$ the element given by sending each point on one boundary of the annulus to the one corresponding to its right (for example) neighbor in the other boundary of the annulus. In case of ladders, this can be artificially solved by adding a 0-strand.

as the corresponding product of $E_i \mathbf{1}_\lambda$, $F_i \mathbf{1}_\lambda$ and $T''_{i,e}{}^{\pm 1}$. Let us call X_w this element corresponding to a presentation of a web-tangle w .

Proposition 2.7. The evaluation representations produce annular web invariants for ladder-type webs. In other words, if $X_w \in \widehat{\dot{U}}'_q(\mathfrak{sl}_m)$ corresponds to a presentation w of a web-tangle, then the morphism of $U_q(\mathfrak{sl}_n)$ representations given by X_w is an invariant of the web-tangle.

$\widehat{\dot{U}}'_q(\mathfrak{sl}_m)$ above denotes the completion of $\dot{U}'_q(\mathfrak{sl}_m)$ given by the quotient of the ring of series of elements of $\dot{U}'_q(\mathfrak{sl}_m)$ acting by evaluation representation on each irreducible $\dot{U}'_q(\mathfrak{sl}_m)$ representation V_λ by zero but for finitely many terms, mod out by the two-sided ideal of elements acting by zero on all V_λ .

As explained previously, the above process produces an invariant of annular web-tangles. However, it appears to come with only little information about the topology of the annulus, and we can indeed explicitly identify this invariant. It may be useful for this purpose to see the annulus as a cylinder rather than flatten on a plane: this way, we can fill it.

Proposition 2.8. The evaluation representation with $a = -q^{e(n+1)}$ recovers the \mathfrak{sl}_n skein module of the filled cylinder. In other words, for each fixed value of N we have the following commutative diagram:

$$\begin{array}{ccc} \dot{U}'_q(\mathfrak{sl}_m) & \xrightarrow{\Phi} & n\mathbf{AWeb}_m^+ \\ \downarrow ev & & \downarrow Filling \\ \dot{U}_q(\mathfrak{sl}_m) & \xrightarrow{\Phi} & n\mathbf{Web}_m^+ \end{array}$$

Proof. We just have to check that the action of $E_0 \mathbf{1}_\lambda$ and $F_0 \mathbf{1}_\lambda$ corresponds to $E_0 \mathbf{1}_\lambda$ and $F_0 \mathbf{1}_\lambda$ seen in the skein module of the filled cylinder.

For E_0 for example, we have the following situation:

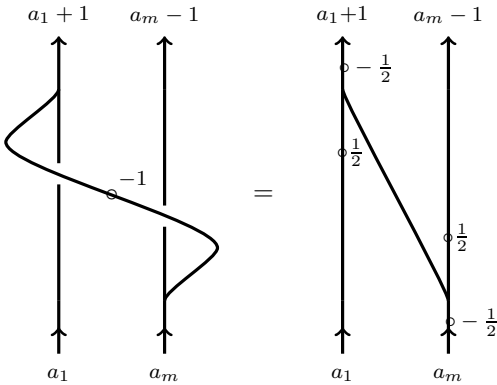
(2.10) $E_0 \mathbf{1}_\lambda \mapsto$  $=$

The negative twist on the LHS of the above equation comes from the fact that the strand goes along the cylinder with framing parallel to the cylinder. When filling the cylinder and projecting it on the back side, this produces a twist.

We have depicted here only the leftmost and the rightmost strands. This whole process is to be understood in front of the other strands. Then, a succession of Reidemeister II moves presents this piece of tangle as the elements defining the evaluation representation, presented in 2.2.

In the previous computation, the twists produce a coefficient $t_{a_1}^{\frac{1}{2}} t_{a_1+1}^{-\frac{1}{2}} t_{a_m}^{-\frac{1}{2}} t_{a_m-1}^{\frac{1}{2}} = -q^{-e(a_1+a_m)+en+e}$, while the evaluation representation provides $aq^{-e(a_1+a_m)}$. Choosing $a = -q^{e(n+1)}$ adjusts the coefficients. Checking the results for F_0 is similar. \square

So, it appears that extending the skew Howe duality phenomenon to the affine case by evaluation representation gives a coherent process, but is too weak for recovering the skein module of the annulus. We miss the fact that acting by $E_1 E_2 \dots E_{m-1} E_0$, although it does not change anything on the weight, has no reason to be something trivial in the skein module. This is a well-known phenomenon in the study of $\widehat{\mathfrak{sl}}_m$: if we want to understand the non-triviality of this action, we have to keep the whole data coming from the Dynkin diagram and not only generators E_i, F_i, K_i^{\pm} . We should therefore work in the whole $U_q(\widehat{\mathfrak{sl}}_m)$ and not only with $U'_q(\widehat{\mathfrak{sl}}_m)$.

Nonetheless, we want to keep working with an analogue of Howe duality, and it would be convenient to have a process built on these particular representations. It turns out that there is an easy way to do it, called *affinization*, as explained for example in [13, p.233].

2.4. Affinization. Following [13], we now consider $\mathbb{C}(q)[z, z^{-1}] \otimes_{\mathbb{C}(q)} \bigwedge_q^N (\mathbb{C}^n \otimes \mathbb{C}^m)$. The $U_q(\mathfrak{sl}_n)$ action can be extended by acting by identity on the z -part, and the previous $U'_q(\widehat{\mathfrak{sl}}_m)$ action may be extended to an $U_q(\widehat{\mathfrak{sl}}_m)$ action by the following rules:

$$\begin{aligned} E_0(z^m \otimes v) &= z^{m+1} \otimes (E_0 v), \\ E_i(z^m \otimes v) &= z^m \otimes (E_i v) \text{ for } i \neq 0, \\ F_0(z^m \otimes v) &= z^{m-1} \otimes (F_0 v), \\ F_i(z^m \otimes v) &= z^m \otimes (F_i v) \text{ for } i \neq 0, \\ K_i(z^m \otimes v) &= z^m \otimes (K_i v), \\ K_d(z^m \otimes v) &= q^m z^m \otimes v. \end{aligned}$$

Here, K_d is the derivation element, that was neglected in the previous subsection.

We have the same decomposition as before:

$$\bigoplus_{a_1 + \dots + a_m = N} \mathbb{C}(q)[z, z^{-1}] \otimes_{\mathbb{C}(q)} \bigwedge_q^{a_1} (\mathbb{C}^n) \otimes \dots \otimes \bigwedge_q^{a_m} (\mathbb{C}^n),$$

and more precisely:

$$\bigoplus_{a_1 + \dots + a_m = N, k} \mathbb{C}(q) \cdot z^k \otimes \bigwedge_q^{a_1} (\mathbb{C}^n) \otimes \dots \otimes \bigwedge_q^{a_m} (\mathbb{C}^n).$$

The $U_q(\widehat{\mathfrak{sl}}_m)$ -weight of one summand is $(a_1 - a_m, a_2 - a_1, \dots, a_m - a_{m-1}) + k\delta$ where δ is the null root (that was neglected in the previous subsections). Note that these representations are of level 0.

We obtain here a new process: given a knotted ladder, we can turn it into an element of $\dot{U}_q(\widehat{\mathfrak{sl}}_m)$ acting on $\bigwedge_q^N (\mathbb{C}^n \otimes \mathbb{C}^m)$, and extend this into an action on $\mathbb{C}(q)[z^{\pm 1}] \otimes_{\mathbb{C}(q)} \bigwedge_q^N (\mathbb{C}^n \otimes \mathbb{C}^m)$. If we restrict to knots drawn on a cylinder, that is ladders with a boundary sequence with only 0's and n 's, we obtain an element of $Hom(\mathbb{C}(q)[z^{\pm 1}] \otimes_{\mathbb{C}(q)} \mathbb{C}[q^{\pm 1}]) = \mathbb{C}(q)[z^{\pm 1}]$.

Since all relations are local, [4, Prop 7.4] receives a direct translation:

Proposition 2.9. The previous process defines a web tangle invariant. In other words, if $\mathbf{1}_{\lambda'} X_w \mathbf{1}_{\lambda} \in \widetilde{U}'_q(\widehat{\mathfrak{sl}}_m)$ corresponds to a presentation w of an annular web-tangle mapping sequences $(a_1^{\lambda}, \dots, a_m^{\lambda})$ to $(a_1^{\lambda'}, \dots, a_m^{\lambda'})$, then the morphism of $U_q(\mathfrak{sl}_n)$ representations mapping $\mathbb{C}(q)[z, z^{-1}] \otimes_{\mathbb{C}(q)} \bigwedge_q^{a_1^{\lambda}} (\mathbb{C}^n) \otimes \dots \otimes \bigwedge_q^{a_m^{\lambda}} (\mathbb{C}^n)$ to $\mathbb{C}(q)[z, z^{-1}] \otimes_{\mathbb{C}(q)} \bigwedge_q^{a_1^{\lambda'}} (\mathbb{C}^n) \otimes \dots \otimes \bigwedge_q^{a_m^{\lambda'}} (\mathbb{C}^n)$ given by X_w is an invariant of the web-tangle.

So, to an annular web-tangle presented in a ladder form, we can assign a morphism of $U_q(\mathfrak{sl}_n)$ representations that is an invariant of the web-tangle. This morphism may be expressed in a diagrammatic way, producing a skein element. Unfortunately, this process is not well-defined: $E_1 F_0 F_1 E_0 \mathbf{1}_\lambda$ acting for example on a 2-strands sequence $(0, 2)$ acts as $[2]^2 \cdot \mathbf{1}_\lambda$, while the skein element corresponding to both these elements are not equal.

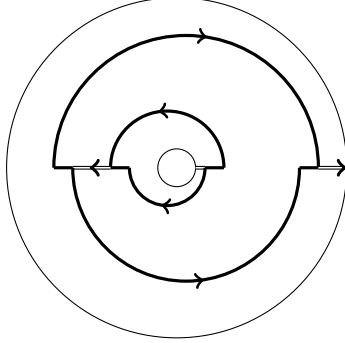

This would suggest to look for richer $U_q(\widehat{\mathfrak{sl}_m})$ representations extending the skew-Howe duality phenomenon.

The previous invariant contains two pieces of information: the same as the evaluation representation, that is, the skein element associated to the web tangle in the skein module of the filled annulus, and an information given by the action on the z -part. This traces a kind of algebraic linking number with the core of the annulus. The problem is that this algebraic number doesn't detect the possible non-triviality of an algebraically non-linked web, as explained above: the representations we have been working with are still too weak to give a full representation-theoretic counterpart of the annular webs.

In the \mathfrak{sl}_2 -case, the unoriented skein module is well understood, isomorphic to $\mathbb{Z}[q^{\pm 1}][z]$, with z the generator given by a circle around the hole. Note that, if we try to compare the obtained invariant with the usual unoriented \mathfrak{sl}_2 skein module of the annulus, the first difference comes from the fact that the 2-labeled strands don't play any role in the unoriented version, while when wrapped around the hole, it produces $z^{\pm 2}$ in the oriented version. A second difference comes from the default explained above. So, modulo z^2 and some renormalizations (since z in the unoriented case corresponds in spirit to $[2]z$ in the oriented case), we can understand the relation between both versions.

2.5. Forgetting about \mathfrak{sl}_n ... Note that the default in obtaining an algebraic object that would mimic the behavior of the skein module comes from the fact that we consider particular $U_q(\mathfrak{sl}_n)$ representations that are not powerful enough to detect all the topological data. A kind of virtual analogue would be to only keep the $U_q(\mathfrak{sl}_m)$ -part in the duality, mod out by information extracted from the usual case, and extend only this to the annular case.

Recall from [6] that we can understand the quotient of $U_q(\mathfrak{sl}_m)$ which corresponds to classes of \mathfrak{sl}_n -webs. Fix N (from the ladders we are looking at) and a dominant weight λ (corresponding to a sequence $(a_1^\lambda, \dots, a_m^\lambda)$), and denote I_λ the ideal of $\dot{U}_q(\mathfrak{sl}_m)$ generated by all weights which do not lie in the Weyl orbit of any weight μ so that λ dominates μ . Furthermore, denote $\dot{U}_q(\mathfrak{sl}_m)^n$ the quotient of $\dot{U}_q(\mathfrak{sl}_m)$ by the set of weights whose associated sequence (a_1, \dots, a_m) either does not exist or has at least one coefficient $a_i < 0$ or $a_i > n$.

Then, Cautis, Kamnitzer and Morrison tell us that the morphism $\dot{U}_q(\mathfrak{sl}_m)^n / I_\lambda \mapsto n\mathbf{Web}_m^+(a_1^\lambda, \dots, a_m^\lambda)$ is an isomorphism, where $n\mathbf{Web}_m^+(a_1^\lambda, \dots, a_m^\lambda)$ is the algebra of ladders that can be reached starting from the sequence $(a_0^\lambda, \dots, a_m^\lambda)$. In other words, these are the ladders $W: (a_1^1, \dots, a_m^1) \mapsto (a_1^2, \dots, a_m^2)$, so that the set of ladders between $(a_1^\lambda, \dots, a_m^\lambda)$ and (a_1^1, \dots, a_m^1) is non-empty.

Let us now denote $n\mathbf{AWeb}_m^+(a_1, \dots, a_m)$ the algebra of annular ladder webs built from a sequence (a_1, \dots, a_m) . Each I_λ extends in the affine case to a module $I_{\widehat{\lambda}}$ simply given by assigning to any $\mu \in I_\lambda$ the affine weight $\widehat{\mu}$ so that if $\mu = (a_2^\mu - a_1^\mu, \dots, a_m^\mu - a_{m-1}^\mu)$, $\widehat{\mu} = (a_1^\mu - a_m^\mu, a_2^\mu - a_1^\mu, \dots, a_m^\mu - a_{m-1}^\mu)$. We can then consider the quotient $\dot{\mathbf{U}}'_q(\widehat{\mathfrak{sl}}_m)^n$ of $\dot{\mathbf{U}}'_q(\widehat{\mathfrak{sl}}_m)$ by weights whose associated sequence has indices lower than 0 or bigger than n , and we have the quotient $\dot{\mathbf{U}}'_q(\widehat{\mathfrak{sl}}_m)^n / I_{\widehat{\lambda}}$. The next result then gives us somehow the result we hoped to find with an explicit $U_q(\mathfrak{sl}_n)$ -rep... but just by looking on the dual side of the picture!

Proposition 2.10. For λ a dominant \mathfrak{sl}_m weight, the map:

$$\dot{\mathbf{U}}'_q(\widehat{\mathfrak{sl}}_m)^n / I_\lambda \mapsto n\mathbf{AWeb}_m^+(a_1^\lambda, \dots, a_m^\lambda)$$

is an isomorphism. The pre-image of a knotted ladder in $\dot{\mathbf{U}}'_q(\widehat{\mathfrak{sl}}_m)^n / I_\lambda$ is therefore an invariant of the knot.

Proof. First, note that since E_0 acts on weights as $F_1 \cdots F_n$, the weights $\widehat{\mu}$ are those that cannot be reached from $\widehat{\lambda}$. On objects, the statement is therefore obvious.

The surjectivity on morphisms comes from the definition.

For morphisms, the injectivity argument is the same as before: since all relations are local (and elementary relations involve at most three strands), either the generators E_0 and F_0 are not involved and we can assume we work with \mathfrak{sl}_m , or they are but (for $m \geq 3$) there exists i so that E_i and F_i are not involved. There is then an inclusion of $U_q(\mathfrak{sl}_m)$ in $U_q(\widehat{\mathfrak{sl}}_m)$ that does not involve E_i and F_i and we can assume we work in this one. \square

2.6. ... to better recover it? The objects that appear in the previous paragraph are closely related to q -Schur algebras and affine versions of them. We refer to [11] for a clear presentation of the context in which they appear.

Following [11], we will consider in what follows an extension⁶ of $U'_q(\widehat{\mathfrak{sl}}_m)$ with two extra generators R and R^{-1} subject to relations (indices are to be understood modulo m):

$$(2.11) \quad \begin{aligned} RR^{-1} &= R^{-1}R = 0 \\ R^{-1}K_{i+1}R &= K_i \quad , \quad R^{-1}K_{i+1}^{-1}R = K_i^{-1} \\ R^{-1}E_{i+1}R &= E_i \quad , \quad R^{-1}F_{i+1}R = F_i. \end{aligned}$$

This algebra will be denoted $\widehat{U}_q(\widehat{\mathfrak{sl}}_m)$, and its idempotent version $\widehat{\mathbf{U}}_q(\widehat{\mathfrak{sl}}_m)$. Note that the previous relations in particular give us that $E_0 = R^{-1}E_1R$ and $F_0 = R^{-1}F_1R$.

Doty and Green suggest us to replace the fundamental representation \mathbb{C}^m of $U_q(\mathfrak{sl}_m)$ by an infinite-dimensional version $V_\infty = \mathbb{C}^\infty = \langle X_i, i \in \mathbb{Z} \rangle$ with action:

$$\begin{aligned} E_i X_j &= X_{j+1} \text{ if } i = j \text{ mod } (m) \quad , \quad E_i X_j = 0 \text{ otherwise,} \\ F_i X_j &= X_j \text{ if } i = j \text{ mod } (m) \quad , \quad F_i X_j = 0 \text{ otherwise,} \\ K_i X_j &= q^{-1} X_j \text{ and } K_i X_{j+1} = q X_{j+1} \text{ if } i = j \text{ mod } (m) \quad , \quad K_i X_j = X_j \text{ otherwise,} \\ R X_j &= X_{j+1}. \end{aligned}$$

As in the linear case, we can endow $\mathbb{C}^n \otimes V_\infty$ with two commutative actions of $U_q(\widehat{\mathfrak{sl}}_n)$ and $\widehat{U}_q(\widehat{\mathfrak{sl}}_m)$. We now wish to consider the quantum exterior power of this tensor product of representations and perform the same type of process as before. However, this quantum exterior power is more complicated to define in the affine case than in the linear one.

⁶This extension has the nice property that it gives us the missing generator of the braid group of the annulus that was previously discussed.

We refer to [34, 36, 37] and references therein for details about these representations and tools one could use to study them. We intend here to sketch a process allowing us to relate m -uprights annular ladders to \mathfrak{sl}_n -representation theory, but the question of completely understanding this relation, and also relating higher-level analogous phenomenon to knot theory remains open.

Denote $V_m = \langle X_1, \dots, X_m \rangle$ that we see as a subspace of V_∞ . V_m is the vector representation of $U_q(\mathfrak{sl}_m)$, (but is not a $U_q(\widehat{\mathfrak{sl}_m})$ module), and its affinization $V_m \otimes \mathbb{C}[z^{\pm 1}]$ is isomorphic to V_∞ . The precise definition of the quantum exterior power of V_∞ can be found in [37, Section 2.1]. We have in particular: $X_{i+km} \wedge X_{i+lm} + X_{i+lm} \wedge X_{i+km} = 0$.

Uglov's process consists in making $\bigwedge_q(\mathbb{C}^n \otimes \mathbb{C}[z^{\pm 1}] \otimes V_m)$ into a $U'_q(\widehat{\mathfrak{sl}_n}) \otimes U'_q(\widehat{\mathfrak{sl}_m})$ module. In particular, this implies that $\bigwedge_q(\mathbb{C}^n \otimes V_\infty)$ has two commuting actions of $U_q(\mathfrak{sl}_n)$ and $U'_q(\widehat{\mathfrak{sl}_m})$, and it is not hard to see that the latter can be extended into a $\widehat{U}_q(\widehat{\mathfrak{sl}_m})$ action.

We now want to relate annular webs, the algebra $\widehat{U}_q(\widehat{\mathfrak{sl}_m})$ and the morphisms of the $U_q(\mathfrak{sl}_n)$ representation $\bigwedge_q(\mathbb{C}^n \otimes V_\infty)$.

Let us slightly extend the definition of $n\mathbf{AWeb}_m^+(N)$ into $n\widehat{\mathbf{AWeb}}_m^+(N)$ by adding to it the image of R as the next elementary annular ladder web:

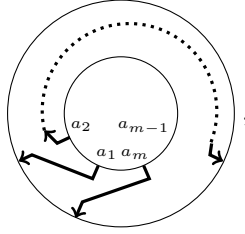

and similarly for R^{-1} .

It is a direct extension of the usual case that we have an isomorphism $\bigoplus_N \widehat{U}_q(\widehat{\mathfrak{sl}_m})^n \mapsto n\widehat{\mathbf{AWeb}}_m^+$.

Usually, when we relate $U_q(\mathfrak{sl}_m)$ and $U_q(\mathfrak{sl}_n)$ endomorphisms, the fact that we can kill in $U_q(\mathfrak{sl}_m)$ all weights corresponding to sequences (a_1, \dots, a_m) with an $a_i > n$ comes from the fact that exterior powers of \mathbb{C}^n of degree more than n are zero. Here, we can decompose:

$$\begin{aligned} \bigwedge_q^N(\mathbb{C}^n \otimes V_\infty) &\simeq \bigwedge_q^N(\mathbb{C}^n \otimes \mathbb{C}[z^{\pm 1}] \otimes V_m) \simeq \bigwedge_q^N(\mathbb{C}^n \otimes \mathbb{C}[z^{\pm 1}] \otimes (\mathbb{C} \oplus \mathbb{C} \oplus \dots \oplus \mathbb{C})) \\ &\simeq \bigoplus_{a_1 + \dots + a_m = N} \bigwedge_q^{a_1}(\mathbb{C}^n \otimes \mathbb{C}[z^{\pm 1}]) \otimes \dots \otimes \bigwedge_q^{a_m}(\mathbb{C}^n \otimes \mathbb{C}[z^{\pm 1}]). \end{aligned}$$

However, the relation $X_{i+km} \wedge X_{i+lm} + X_{i+lm} \wedge X_{i+km} = 0$ does not ensure that $\bigwedge_q^N(\mathbb{C}^n \otimes \mathbb{C}[z^{\pm 1}]) \simeq \mathbb{C}$ nor that it is zero after.

If we denote $\{z_{i,j}, i \in \{1, \dots, n\}, j \in \mathbb{Z}\}$ a basis of $\mathbb{C}^n \otimes V_\infty$, we can artificially mod out the exterior power by the ideal generated by the extra relation $z_{i,j} \wedge z_{i,j+km} = 0$ under tensor product and both actions of the two quantum groups. This ideal, J_m , is the smallest ideal of $\bigwedge_q(\mathbb{C}^n \otimes V_\infty)$ containing all the elements $z_{i,j} \wedge z_{i,j+km}$ and which is also a representation for both actions of $\widehat{U}_q(\mathfrak{sl}_n)$ and $\widehat{U}_q(\widehat{\mathfrak{sl}_m})$. Such a J_m exists, as the whole algebra would verify the conditions (but, hopefully, the minimality one). Let us denote ${}^a\bigwedge_q(\mathbb{C}^n \otimes V_\infty) = \bigwedge_q(\mathbb{C}^n \otimes V_\infty)/J_m$ this quotient.

First, we want to ensure that this extra quotient does not make this representation trivial. For this, note that we have a map:

$$\mathbb{C}^n \otimes \mathbb{C}[z, z^{-1}] \otimes V_m \xrightarrow{z=1} \mathbb{C}^n \otimes V_m$$

that preserves the actions of $U_q(\mathfrak{sl}_n)$ and $\widehat{U}_q(\widehat{\mathfrak{sl}_m})$. It extends to the exterior power, so that we have the following commutative diagram:

$$\begin{array}{ccc}
\Lambda_q(\mathbb{C}^n \otimes \mathbb{C}[z^{\pm 1}] \otimes \mathbb{C}^m) & \xrightarrow{z=1} & \Lambda_q(\mathbb{C}^n \otimes \mathbb{C}^m) \\
& \searrow & \nearrow \\
& & {}^a\Lambda_q(\mathbb{C}^n \otimes \mathbb{C}[z^{\pm 1}] \otimes \mathbb{C}^m)
\end{array}$$

This gives the following successive relations:

$$n\widehat{\mathbf{AWeb}}_m^+ \simeq \oplus_N \widehat{\mathbf{U}}_q(\widehat{\mathfrak{sl}}_m)^n \mapsto \text{End}_{U_q(\mathfrak{sl}_m)} \left({}^a\Lambda_q(\mathbb{C}^n \otimes V_\infty) \right).$$

We want to prove that the last map is actually an inclusion of algebras. A very useful tool for this is provided by [28, Proposition 3.14], which requests a little adaptation.

Assume that $N < m$ (we can restrict to that case by adding 0-labeled strands), and denote $\mathbb{1}_r$ the idempotent corresponding the sequence $(a_1, \dots, a_m) = (1, \dots, 1, 0, \dots, 0)$ containing r times the number 1. Then, $\mathbb{1}_r \widehat{\mathbf{U}}_q(\widehat{\mathfrak{sl}}_m) \mathbb{1}_r$ is isomorphic to the affine Hecke algebra $\widehat{\mathcal{H}}_{\widehat{A}_{r-1}}$ (see [28, 11]). We can present it as generated by b_1, \dots, b_r and T_ρ, T_ρ^{-1} subject to the following relations:

$$\begin{aligned}
(2.12) \quad & b_i^2 = (q + q^{-1})b_i && \text{for } i = 1, \dots, r \\
& b_i b_j = b_j b_i && \text{for distant } i, j = 1, \dots, r \\
& b_i b_{i+1} b_i + b_{i+1} = b_{i+1} b_i b_{i+1} + b_i && \text{for } i = 1, \dots, r \\
& T_\rho b_i T_\rho^{-1} = b_{i+1} && \text{for } i = 1, \dots, r.
\end{aligned}$$

The last equations is to be understood with indices modulo r . Note that we can obtain the generator b_r as $b_r = T_\rho b_{r-1} T_\rho^{-1}$.

Mackaay and Thiel then state, where $\widehat{S}(m, N)$ is the affine Schur algebra:

Proposition 2.11. [28, Proposition 3.14] Let $N < m$. Suppose that A is a $\mathbb{Q}(q)$ algebra and

$$f: \widehat{S}(m, N) \mapsto A$$

is a surjective $\mathbb{Q}(q)$ -algebra homomorphism which is an embedding when restricted to $\mathbb{1}_r \widehat{S}(m, N) \mathbb{1}_r \simeq \widehat{\mathcal{H}}_{\widehat{A}_{r-1}}$. Then f is a $\mathbb{Q}(q)$ -algebra isomorphism

$$A \simeq \widehat{S}(m, N).$$

The idea is that it is enough to check the injectivity on the Hecke algebra for deducing it for the whole Schur algebra. There is a slight difference in the context we want to consider: all versions of $\widehat{\mathbf{U}}_q(\widehat{\mathfrak{sl}}_m)$, Schur and Hecke algebras have weights killed whenever the corresponding sequence (a_1, \dots, a_m) has one term bigger than n .

However, the exact same proof can be achieved in this case: the proof consists in factorizing elements of the Hecke algebra through other weights. In our case, we have to consider that if the weight is killed, then the associated element will be killed. We can thus state:

Proposition 2.12. Let $N < m$. Suppose that A is a $\mathbb{Q}(q)$ algebra and

$$f: \widehat{S}(m, N)^n \mapsto A$$

is a surjective $\mathbb{Q}(q)$ -algebra homomorphism which is an embedding when restricted to $\mathbb{1}_r \widehat{S}(m, N)^n \mathbb{1}_r \simeq \widehat{\mathcal{H}}_{A_{r-1}}^2$. Then f is a $\mathbb{Q}(q)$ -algebra isomorphism

$$A \simeq \widehat{S}(m, N)^n.$$

We can then state:

Proposition 2.13. The map $\widehat{\mathbf{U}}_q(\widehat{\mathfrak{sl}}_m)^n \mapsto \text{End}_{U_q(\mathfrak{sl}_n)}\left({}^a\Lambda_q(\mathbb{C}^n \otimes V_\infty)\right)$ is injective.

Proof. We have:

$$\begin{array}{ccc}
 \widehat{\mathbf{U}}_q(\widehat{\mathfrak{sl}}_m)^n & \xrightarrow{\Phi} & \text{End}_{U_q(\mathfrak{sl}_n)}({}^a\Lambda_q(\mathbb{C}^n \otimes V_\infty)) \\
 & \searrow & \uparrow \\
 & & \text{Im}(\Phi) \\
 & \nearrow & \\
 \mathbb{1}_r \widehat{\mathbf{U}}_q(\widehat{\mathfrak{sl}}_m)^n \mathbb{1}_r & &
 \end{array}$$

[28, Prop 3.14] (or its reformulation) tells us that if the bottom arrow is injective, then the diagonal one is an isomorphism, and therefore the top one is an injection, which is our statement.

$\text{Im}(\mathbb{1}_r \widehat{\mathbf{U}}_q(\widehat{\mathfrak{sl}}_m)^n \mathbb{1}_r) \subset \text{End}_{U_q(\mathfrak{sl}_n)}({}^a\Lambda_q^1(\mathbb{C}^n \otimes \mathbb{C}[z^{\pm 1}]) \otimes \cdots \otimes {}^a\Lambda_q^1(\mathbb{C}^n \otimes \mathbb{C}[z^{\pm 1}]))$ where we have r copies of the first exterior power. But ${}^a\Lambda_q^1(\mathbb{C}^n \otimes \mathbb{C}[z^{\pm 1}]) = \mathbb{C}^n \otimes \mathbb{C}[z^{\pm 1}]$, and it decomposes in a sum (not necessarily direct) of copies of $\Lambda_q^1(\mathbb{C}^n) \otimes \cdots \otimes \Lambda_q^1(\mathbb{C}^n)$.

Then, from the linear case, [6] implies that $\mathbb{1}_r \widehat{\mathbf{U}}_q(\widehat{\mathfrak{sl}}_m)^n \mathbb{1}_r$ embeds into $\text{Im}(\Phi)$. For a complete understanding of the action of $\widehat{\mathcal{H}}_{A_{r-1}}$, we just need to understand the action of T_ρ and T_ρ^{-1} . T_ρ and T_ρ^{-1} are sent to isomorphisms between different copies in the decomposition which act freely on this decomposition, with only commutation relations the ones from the Hecke algebra. Indeed, the key idea is that the formal space $\langle T_\rho, T_\rho^{-1} \rangle \cdot \Lambda_q^1(\mathbb{C}^n \otimes V') \otimes \cdots \otimes \Lambda_q^1(\mathbb{C}^n \otimes V')$ injects in the module we defined:

$$\bigoplus_{\mathbb{Z}} \Lambda_q^1(\mathbb{C}^n) \otimes \cdots \otimes \Lambda_q^1(\mathbb{C}^n) \subset {}^a\Lambda_q^1(\mathbb{C}^n \otimes \mathbb{C}[z^{\pm 1}]) \otimes \cdots \otimes {}^a\Lambda_q^1(\mathbb{C}^n \otimes \mathbb{C}[z^{\pm 1}]),$$

which we can see by looking at the degree of the polynomial part (note that all defining formulas in the exterior power are homogeneous for the global polynomial degree). The map therefore extends injectively to $\mathbb{1}_r \widehat{\mathbf{U}}_q(\widehat{\mathfrak{sl}}_m)^n \mathbb{1}_r$, which concludes the proof. \square

Therefore, we obtain that webs can be interpreted as $U_q(\mathfrak{sl}_n)$ endomorphisms of the representation ${}^a\Lambda_q(\mathbb{C}^n \otimes V_\infty)$. This gives to annular webs a representation-theory-based interpretation that is to be related to the original definition of webs as an algebra of intertwiners for minuscule $U_q(\mathfrak{sl}_n)$ representations.

It would also be very interesting to better understand the relations between this representation and knot theory, and to see whether there is any translation in the knot theory side of the more general phenomenons studied in [37].

2.7. Turning an annular knot to a ladder. So far, we saw that to a ladder annular web-tangle, we can assign a $U_q(\mathfrak{sl}_n)$ morphism of tensor product of minuscule representations (possibly tensorized with $\mathbb{C}(q)[z, z^{-1}]$), whose diagrammatic depiction equals the skein element associated to the web-tangle. This holds for any annular web-tangle isotopic to a ladder, but we can extend the process used in the case of usual webs for turning webs to ladder webs.

We can present any upward annular web-tangle in a similar form as in [6]:

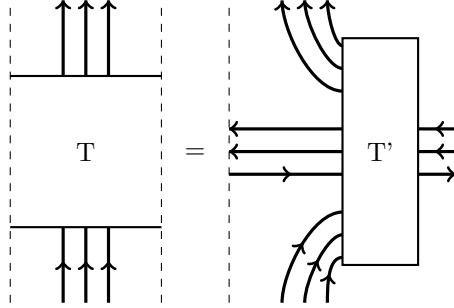

The above pictures are to be understood on an annulus.

Then, taking the Jones-Kauffman product with a set of well-placed n -strands, we can apply to T' the same process as usual and turn T to a ladder form. Note that taking the Jones-Kauffman product with n -strands is an invertible process, by taking the product with the same number of n -strands oriented downward and pairing the obtained couples of oppositely oriented n -strands.

3. CATEGORIFICATION

From the Dynkin diagram 2.1, one can build a categorified quantum group $\mathcal{U}_Q(\widehat{\mathfrak{sl}}_m)$ following [7], which generalizes works by Khovanov and Lauda [19, 21, 20, 25].

Similarly, it is a straightforward generalization of $n\mathbf{BFoam}_m(N)$ to consider foams on an annulus $n\mathbf{ABFoam}_m(N)$: local generators are the same ones as in the disk case, but instead of embedding the foams in the thickening of a disk, we embed them in the thickening of an annulus. Then, the main result from [26] generalizes at no cost:

Proposition 3.1. For $n = 2, 3$, for each $N > 0$ there is a 2-representation $\Phi_n : \mathcal{U}_Q(\widehat{\mathfrak{sl}}_m) \rightarrow n\mathbf{ABFoam}_m(N)$ defined on single strand 2-morphisms by:

$$\Phi_n \left(\begin{array}{c} \uparrow \\ i \end{array} \begin{array}{c} \lambda \\ \uparrow \end{array} \right) = \text{Diagram 1}, \quad \Phi_n \left(\begin{array}{c} \uparrow \\ i \end{array} \begin{array}{c} \lambda \\ \bullet \end{array} \right) = \text{Diagram 2}$$

on crossings by:

$$\Phi_n \left(\begin{array}{c} \nearrow \\ i \end{array} \begin{array}{c} \searrow \\ i \end{array} \begin{array}{c} \lambda \\ \times \end{array} \right) = \text{Diagram 3}$$

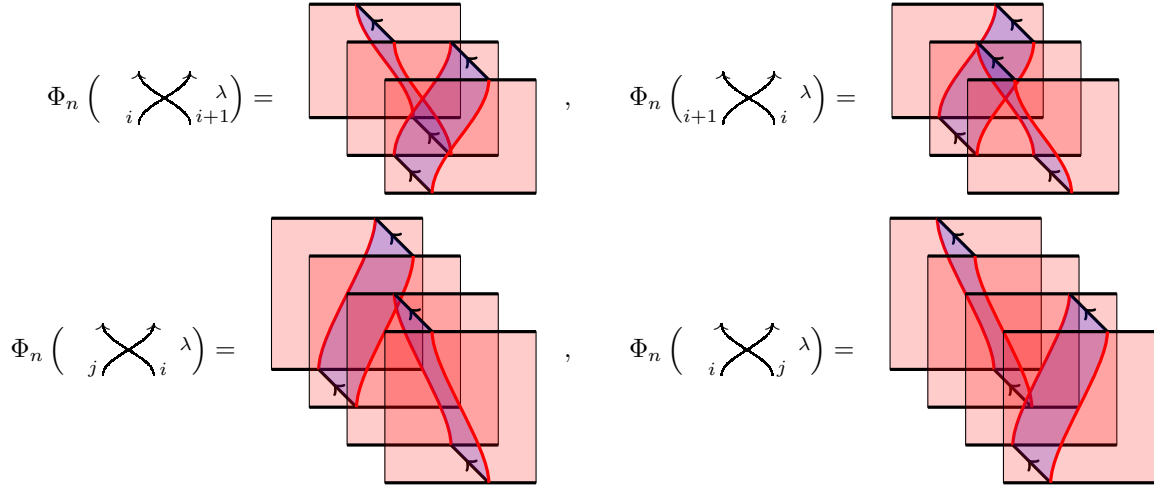

where $j - i > 1$, and on caps and cups by:

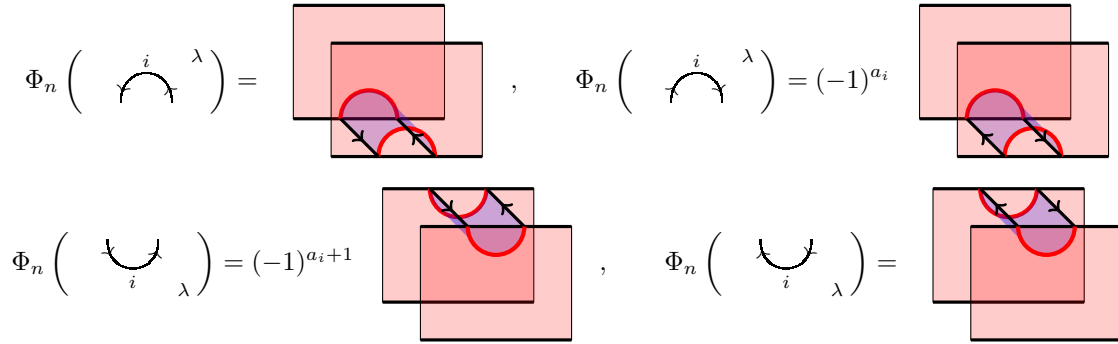

where in the above diagrams the i^{th} sheet is always in the front.

Then, following [26], we can build from any annular knot, turned into an annular entangled ladder, form a complex over the category $\mathcal{U}_Q(\mathfrak{sl}_m)$. Applying to it Φ_n (for $n = 2$ or $n = 3$), we obtain extensions to the annulus of Khovanov’s homology [16, 17, 18] built in the spirit of Bar-Natan [1]. Again, the proof of the invariance relies on checking Reidemeister moves, which are local and therefore directly extend from the usual case to the affine one.

REFERENCES

- [1] D. Bar-Natan. Khovanov’s homology for tangles and cobordisms. *Geom. Topol.*, 9:1443–1499, 2005. arXiv:math/0410495.
- [2] C. Blanchet. An oriented model for Khovanov homology. *J. Knot Theory Ramifications*, 19(2):291–312, 2010.
- [3] J. S. Carter. Reidemeister/Roseman-type Moves to Embedded Foams in 4-dimensional Space. *ArXiv e-prints*, October 2012. arXiv:1210.3608.
- [4] S. Cautis. Clasp technology to knot homology via the affine Grassmannian. 2012. arXiv:1207.2074.
- [5] S. Cautis, J. Kamnitzer, and A. Licata. Categorical geometric skew Howe duality. *Invent. Math.*, 180(1):111–159, 2010. arXiv:0902.1795.
- [6] S. Cautis, J. Kamnitzer, and S. Morrison. Webs and quantum skew Howe duality. *ArXiv e-prints*, October 2012. arXiv:1210.6437.
- [7] S. Cautis and A. D. Lauda. Implicit structure in 2-representations of quantum groups. 2011. arXiv:1111.1431.
- [8] V. Chari and A. Pressley. *A guide to quantum groups*. Cambridge University Press, Cambridge, 1995. Corrected reprint of the 1994 original.
- [9] D. Clark, S. Morrison, and K. Walker. Fixing the functoriality of Khovanov homology. *Geom. Topol.*, 13(3):1499–1582, 2009. arXiv:math/0701339.

- [10] B. Cooper and V. Krushkal. Categorification of the Jones-Wenzl projectors. Quantum Topol., 3(2):139–180, 2012. arXiv:1005.5117.
- [11] S.R. Doty and R.M. Green. Presenting affine q -schur algebras. Mathematische Zeitschrift, 256(2):311–345, 2007. arXiv:0603002.
- [12] I. Frenkel, C. Stroppel, and J. Sussan. Categorifying fractional Euler characteristics, Jones-Wenzl projectors and $3j$ -symbols. Quantum Topol., 3(2):181–253, 2012. arXiv:1007.4680.
- [13] J. Hong and S. Kang. Introduction to quantum groups and crystal bases, volume 42 of Graduate Studies in Mathematics. American Mathematical Society, Providence, RI, 2002.
- [14] J. Kamnitzer and P. Tingley. The crystal commutator and Drinfeld’s unitarized R -matrix. J. Algebraic Combin., 29(3):315–335, 2009. arXiv:0707.2248.
- [15] L.H. Kauffman. Invariants of graphs in three-space. Trans. Amer. Math. Soc., 311(2):697–710, 1989.
- [16] M. Khovanov. A categorification of the Jones polynomial. Duke Math. J., 101(3):359–426, 2000. arXiv:math/9908171.
- [17] M. Khovanov. A functor-valued invariant of tangles. Algebr. Geom. Topol., 2:665–741 (electronic), 2002. arXiv:math/0103190.
- [18] M. Khovanov. $sl(3)$ link homology. Algebr. Geom. Topol., 4:1045–1081, 2004. arXiv:math/0304375.
- [19] M. Khovanov and A. Lauda. A diagrammatic approach to categorification of quantum groups I. Represent. Theory, 13:309–347, 2009. arXiv:0803.4121.
- [20] M. Khovanov and A. Lauda. A diagrammatic approach to categorification of quantum groups III. Quantum Topology, 1:1–92, 2010. arXiv:0807.3250.
- [21] M. Khovanov and A. Lauda. A diagrammatic approach to categorification of quantum groups II. Trans. Amer. Math. Soc., 363:2685–2700, 2011. arXiv:0804.2080.
- [22] M. Khovanov, A. Lauda, M. Mackaay, and M. Stošić. Extended graphical calculus for categorified quantum $sl(2)$. Memoirs of the AMS, 219, 2012. arXiv:1006.2886.
- [23] D. Kim. Graphical calculus on representations of quantum Lie algebras. ProQuest LLC, Ann Arbor, MI, 2003. Thesis (Ph.D.)—University of California, Davis.
- [24] G. Kuperberg. Spiders for rank 2 Lie algebras. Comm. Math. Phys., 180(1):109–151, 1996. arXiv:a-alg/9712003.
- [25] A. D. Lauda. A categorification of quantum $sl(2)$. Adv. Math., 225:3327–3424, 2008. arXiv:0803.3652.
- [26] A. D. Lauda, H. Queffelec, and D. E. V. Rose. Khovanov homology is a skew Howe 2-representation of categorified quantum $sl(m)$. ArXiv e-prints, December 2012. arXiv:1212.6076.
- [27] G. Lusztig. Introduction to quantum groups, volume 110 of Progress in Mathematics. Birkhäuser Boston Inc., Boston, MA, 1993.
- [28] M. Mackaay and A.-L. Thiel. Categorifications of the extended affine Hecke algebra and the affine q -Schur algebra $S(n,r)$ for $2 < r < n$. ArXiv e-prints, February 2013. arXiv:1302.3102.
- [29] M. Mackaay, M. Stošić, and P. Vaz. The 1, 2-coloured homfly-pt link homology. Transactions of the American Mathematical Society, 363(4):2091–2124, 2011. arXiv:0809.0193.
- [30] V. Mazorchuk and C. Stroppel. A combinatorial approach to functorial quantum sl_k knot invariants. Amer. J. Math., 131(6):1679–1713, 2009. arXiv:0709.1971.
- [31] S. Morrison. A diagrammatic category for the representation theory of $(Uqsl_n)$. ProQuest LLC, Ann Arbor, MI, 2007. Thesis (Ph.D.)—University of California, Berkeley.
- [32] H. Murakami, T. Ohtsuki, and S. Yamada. Homfly polynomial via an invariant of colored plane graphs. Enseign. Math. (2), 44(3-4):325–360, 1998.
- [33] D. Rose. A categorification of quantum sl_3 projectors and the sl_3 Reshetikhin-Turaev invariant of tangles. 2011. arXiv:1109.1745.
- [34] E. Stern. Semi-infinite wedges and vertex operators. Internat. Math. Res. Notices, (4):201–219, 1995. arXiv:q-alg/9504013.
- [35] C. Stroppel and J. Sussan. Categorified Jones-Wenzl projectors: a comparison, 2011. arXiv:1105.3038.
- [36] Kouichi Takemura and Denis Uglov. Level-0 action of $U_q(\widehat{sl}_n)$ on the q -deformed Fock spaces. Comm. Math. Phys., 190(3):549–583, 1998. arXiv:q-alg/9607031.
- [37] Denis Uglov. Canonical bases of higher-level q -deformed Fock spaces and Kazhdan-Lusztig polynomials. In Physical combinatorics (Kyoto, 1999), volume 191 of Progr. Math., pages 249–299. Birkhäuser Boston, Boston, MA, 2000. arXiv:math/9905196.

UNIVERSITÉ PARIS DIDEROT-PARIS 7, INSTITUT DE MATHÉMATIQUES DE JUSSIEU - PARIS RIVE GAUCHE CNRS UMR 7586, BÂTIMENT SOPHIE GERMAIN, CASE 7012, 75205 PARIS CEDEX 13, FRANCE.

E-mail address: queffelec@math.jussieu.fr