



THÈSE DE DOCTORAT DE
L'UNIVERSITÉ PIERRE ET MARIE CURIE

Spécialité : Physique théorique

Présentée par
Sébastien LEURENT

pour obtenir le grade de
DOCTEUR DE L'UNIVERSITÉ PIERRE ET MARIE CURIE

Sujet : **Systemes intégrables et dualité AdS/CFT**

Soutenance le 20 juin 2012, devant le jury composé de

Romuald JANIK	Rapporteur
Vladimir KAZAKOV	Directeur de thèse
Gregory KORCHEMSKY	Rapporteur
Arkady TSEYTLIN	Examineur
Konstantin ZAREMBO	Examineur
Jean-Bernard ZUBER	Examineur

Thèse délivrée par l'UPMC, Place Jussieu, 75005 Paris FRANCE,
suite à des recherches effectuées au LPT-ENS, 24 rue Lhomond, 75005 Paris FRANCE.

Résumé

Cette thèse est consacrée à l'étude de systèmes quantiques intégrables tels des chaînes de spins, des théories de champs à 1+1 dimensions, et la dualité AdS/CFT. Cette dualité AdS/CFT est une conjecture, émise à la fin du siècle dernier, qui relie notamment le régime non-perturbatif d'une théorie de jauge superconforme (nommée $\mathcal{N}=4$ super Yang-Mills) au régime perturbatif d'une théorie de cordes dans un espace à 10 dimensions (de géométrie $\text{AdS}_5 \times \text{S}^5$).

Ce manuscrit explore les similarités entre des chaînes de spins intégrables et des théories de champs intégrables, tels Super Yang Mills. Il commence par une étude approfondie des chaînes de spins intégrables pour y construire explicitement un "flot de Bäcklund" et des "opérateurs Q" polynômiaux, qui permettent de diagonaliser le Hamiltonien. Des théories de champs intégrables sont ensuite étudiées et des "fonctions Q " sont obtenues, qui sont l'analogue des opérateurs Q construits pour les chaînes de spins. Il apparaît que de nombreuses informations sont contenue dans les propriétés analytiques des fonctions Q . Cela permet d'aboutir, dans le cadre de l'ansatz de Bethe thermodynamique, à un nombre fini d'équations non-linéaires intégrales qui encode le spectre des niveaux d'énergie de la théorie considérée (en taille finie). Ce système d'équations est équivalent au système infini d'équations, connu sous le nom de système Y, qui dans le cas de la dualité AdS/CFT avait été conjecturé assez récemment.

Mots-clé : Ansatz de Bethe, Chaînes de spins, Dualité AdS/CFT, Systèmes intégrables, Théories de champs conformes, Théories de jauge supersymétriques

Table des matières

Table des matières	iii
Remerciements	iv
Introduction	vi
Résumé détaillé	ix
Manuscrit (en anglais)	xii
Contents	3
I. Integrability and Bethe ansatz	10
II. Q operators for spin chains	22
III. Thermodynamic Bethe Ansätze and Y-systems	88
IV. AdS/CFT Duality	170
Conclusion and outlook	219
A. Introduction to representations of matrix groups	221
B. Properties of co-derivatives	237
Index and notations	250
References	252

Remerciements

Cette thèse s'est déroulée au LPT de l'ÉNS, sous la direction de Vladimir Kazakov, qui a su, par de nombreuses discussions, me communiquer son goût pour la recherche et me présenter des problèmes extrêmement intéressants. Que ce soit pour les collaborations qu'il a initiées, pour les explications qu'il m'a fournies, pour la liberté qu'il m'a toujours donnée, pour les nombreux voyages au cours de cette thèse, je lui suis extrêmement reconnaissant pour ce qu'il m'a apporté dans mon travail de thèse, mais aussi pour l'amitié que nous avons nouée.

Je tiens aussi à remercier Romuald Janik et Gregory Korchemsky qui ont accepté la lourde tâche d'être rapporteurs, ainsi qu'Arkady Tseytlin, Konstantin Zarembo et Jean-Bernard Zuber, qui ont bien voulu faire partie du jury pour cette soutenance.

Je tiens aussi à remercier les collaborateurs avec lesquels j'ai eu la chance de travailler de manière fructueuse sur des sujets variés : Volodya, tout d'abord, sans lequel je n'aurais probablement jamais étudié ces sujets, Dima qui a toujours si bien su partager ses trouvailles comme ses questionnements, mais aussi mes autres coauteurs Sacha Alexandrov, Nikolay Gromov, Zengo Tsuboi et Anton Zabrodin, avec lesquels j'ai eu le plaisir de travailler et de me rendre compte que ma propension naturelle à chercher seul les réponses à mes questions devait impérativement être complétée par les discussions fréquentes qui permettent de donner la place à plusieurs points de vue sur un même problème, d'avoir du recul sur son propre travail et de s'enrichir des idées d'autres chercheurs.

J'ai eu la chance de mener à bien cette thèse au sein du Laboratoire de Physique Théorique de l'ÉNS, laboratoire dont tous les membres ont été plus accueillants et stimulants les uns que les autres. J'ai eu la chance de passer presque sept ans au sein de l'ÉNS (comme élève puis comme thésard et caïman), et ces années m'apportèrent beaucoup, aussi bien professionnellement qu'humainement. J'ai tout particulièrement apprécié la vie associative dense de cette école (et de ses alentours), ainsi que la très grande diversité de parcours des étudiants et la diversité des formations que l'on peut y suivre.

Je tiens d'abord à remercier tous ceux qui (tels les secrétaires et informaticiens par exemple) simplifient tellement la vie en prenant sur eux de nombreuses préoccupations concrètes. Je tiens aussi à remercier tous les enseignants, qui m'ont permis de suivre à l'ÉNS une scolarité alliant une très grande qualité avec une variété extraordinaire de cours. Je souhaite aussi remercier les enseignants hors du commun que j'ai eu au long de ma scolarité, de l'école primaire à la prépa et à l'université.

Les meilleurs enseignants que j'ai eus étaient bien sûr beaucoup plus que des forma-

teurs, puisqu'ils m'ont aidé à grandir et m'ont (sup)porté depuis ma plus tendre enfance, jusqu'à me laisser finalement voler de mes propres ailes : il s'agit de mes parents qui méritent tout particulièrement d'être remerciés ici.

Je tiens aussi à remercier les élèves que j'ai côtoyés au long de ma scolarité, car la réussite scolaire n'est pas purement individuelle, mais résulte de l'émulation, du travail commun, des discussions avec d'autres élèves, et d'une atmosphère collective qui permette à la fois le travail et l'épanouissement personnel.

Je souhaite aussi remercier les élèves que j'ai eus en faisant mes premiers pas dans l'enseignement, en prépa comme à l'Université puis à l'ÉNS. Avoir des élèves attentifs, réactifs et assidus a été un tel plaisir, que je fus très heureux d'avoir (je l'espère) contribué à leur apprentissage.

Lors de ces années de thèse, j'ai particulièrement apprécié l'atmosphère du LPT, ses chercheurs accueillants, ses secrétaires efficaces et ses informaticiens (parfois bénévoles) tellement dévoués. Ce fut un plaisir de travailler dans le bureau qui fut le mien, et je remercie les thésards qui ont eu à me supporter et avec lesquels nous avons notamment partagé un engouement commun pour les biscuits au beurre, et diverses infusions.

De nombreux autres amis, connus sur les bancs de l'école ou dans des associations ou partis politiques m'ont aussi permis de traverser cette période, et méritent d'être remerciés ici pour leur joie de vivre communicative.

Mais bien plus encore, je remercie Céline, qui a été à mes côtés quotidiennement, m'a accompagné au cours de ces années et a toujours su me signifier son amour par ses nombreuses attentions et tout ce qu'elle fit pour moi, se chargeant même de relire cette thèse. Je tiens donc à lui témoigner ici mon amour et ma gratitude.

Introduction

La physique théorique actuelle est notamment confrontée à deux défis de taille : les propriétés non-perturbatives de certaines théories de jauge d'une part, et la description quantique de la gravité d'autre part.

Les théories de jauge sont une description quantique de particules en interaction. Dans ce formalisme, des champs (comme le champ électromagnétique) sont “quantifiés”, et leur quantification fait naturellement apparaître des particules (tels les photons), comme médiateurs des interactions. Dans ce formalisme quantique, on ne peut pas considérer qu'une particule ait une trajectoire bien définie c'est-à-dire qu'on ne peut pas lui associer une position à chaque instant. Au contraire, pour chaque mesure que l'on effectue, de nombreuses trajectoires possibles contribuent et leur contributions s'ajoutent. Parmi les différentes “trajectoires” (ou plutôt devrait-on dire les différentes histoires) qui contribuent, certaines contiennent des désintégrations de particules, des créations de nouvelles particules, ou des interactions entre particules.

Une difficulté de taille de ce formalisme est que chaque processus physique est décrit par la somme des contributions d'une infinité d'“histoires” différentes. La question naturelle qui se pose est de savoir si cette somme est bien finie. Pour certaines théories, il existe au moins certains régimes (qualifiés de perturbatifs) où plus une histoire fait intervenir de créations ou d'annihilations de particules, plus sa contribution est faible. Dans ce cas, on peut calculer de nombreuses propriétés physiques en tronquant la somme pour ne garder qu'un nombre fini d'événements, faisant intervenir un nombre limité de créations ou annihilations de particules. Plus la précision souhaitée est élevée, plus il faudra considérer de termes.

Pour certains modèles de ce type, par exemple les interactions entre les quarks (les plus petits constituants connus des noyaux atomiques), cette approche perturbative permet uniquement de décrire des processus se déroulant à une énergie suffisante. Il existe des propriétés de ces théories qui ne sont pas expliquées par cette approche perturbative, notamment le confinement des quarks à l'intérieur de hadrons, comme les neutrons et les protons (phénomène qui explique que l'on ne puisse pas observer un quark “seul” mais uniquement des particules constituées de plusieurs quarks).

Un autre défi de taille pour la physique théorique est la description quantique de la gravité. Le formalisme des théories de jauge a abouti à d'importants succès, au premier rang desquels se trouve le modèle standard. Celui-ci décrit toutes les particules observées à ce jour, et explique trois des quatre interactions fondamentales (connues) de la nature : l'interaction électromagnétique, l'interaction “faible” (responsable de certaines réactions

nucléaires) et l'interaction "forte" (décrivant les interactions entre les quarks). Seule la gravité n'est pas décrite par ce modèle, et à ce jour, les théories des cordes sont la façon la plus aboutie de la décrire de façon quantique. Une différence notoire avec les théories de jauge mentionnées ci-dessus est que les particules ne sont pas considérées comme ponctuelles mais comme unidimensionnelles (que l'on peut imaginer comme de petites cordes en mouvement).

À la fin du siècle dernier, une dualité a été conjecturée, qui relie ces deux défis majeurs. Cette dualité fait intervenir d'une part la théorie de jauge nommée super Yang-Mills, et caractérisée par de nombreuses symétries (elle est invariante sous l'effet des transformations conformes et sous quatre transformations de super-symétrie), et d'autre part une théorie des cordes dans l'espace dix-dimensionnel $AdS_5 \times S^5$, produit d'une sphère par un espace Anti de Sitter. Cette dualité conjecture par exemple que certaines quantités, difficiles à calculer en théorie de jauge dans le régime de couplage fort (régime hautement non-perturbatif), peuvent être obtenues par un calcul en théorie de cordes à couplage faible (dans un régime perturbatif de la théorie des cordes). Inversement, certaines quantités difficiles à calculer dans le régime de couplage fort de la théorie des cordes peuvent s'obtenir à partir de calculs perturbatif dans super Yang-Mills.

Cette dualité, nommée dualité AdS_5/CFT_4 (ou plus simplement AdS/CFT) est très puissante car elle relie des calculs perturbatifs et non-perturbatifs. Elle est cependant difficile à vérifier concrètement, car il faut explicitement mener à bien un calcul perturbatif et un calcul non-perturbatif pour vérifier si le résultat coïncide. Dans cette thèse, nous verrons néanmoins comment calculer certaines quantités de manière exacte (et non pas perturbative) dans le cadre de cette dualité et plus généralement dans le cadre de modèles intégrables.

Comme nous le verrons, l'intégrabilité est un outil puissant permettant des calculs exacts dans de nombreux modèles jouissant des bonnes propriétés. Ces modèles, appelés "modèles intégrables", sont notamment caractérisés par un nombre important de charges conservées. En particulier, nous verrons que des opérateurs nommés "matrices de transfert", (ou simplement "opérateurs T"), peuvent être construits pour des chaînes de spins intégrables. Nous verrons d'ailleurs aussi que des opérateurs ayant les mêmes propriétés (ils obéissent notamment à l'équation de Hirota) existent pour des théories des champs intégrables, et en particulier pour AdS/CFT . Un des résultats de cette thèse est de montrer que ces opérateurs T peuvent s'exprimer en termes d'opérateurs Q de Baxter, qui sont construits explicitement dans le cas des chaînes de spins intégrables. Ce résultat s'appuie notamment sur des arguments combinatoires élémentaires qui seront introduits et motivés.

Nous verrons ensuite que de nombreux autres modèles que ces chaînes de spins sont intégrables, en particulier des théories de champs bidimensionnelles. Plus précisément, nous verrons que si l'espace est périodique, mais suffisamment grand, ces modèles peuvent être exactement résolus grâce à l'ansatz de Bethe. Une question intéressante est dès lors de savoir ce qu'il advient pour un espace plus petit. Cette interrogation sur les corrections de taille finie trouve notamment une réponse grâce à la méthode d'ansatz de

Bethe thermodynamique, très utilisée dans cette thèse. Cette méthode est d'autant plus intéressante qu'elle s'applique notamment à la dualité AdS/CFT, dont elle permet de calculer exactement le spectre (c'est-à-dire les niveaux d'énergie de la théorie des cordes, ou les dimensions des opérateurs de super Yang-Mills). Nous verrons que cette méthode d'ansatz de Bethe thermodynamique donne lieu à des fonctions T qui généralisent les opérateurs des chaînes de spins, et satisfont l'équation de Hirota.

Nous verrons ensuite comment résoudre de manière plus générale l'équation de Hirota pour certains groupes de (super)-symétrie. Cette solution, qui constitue en partie un résultat original de cette thèse, fait intervenir des fonctions Q qui généralisent les opérateurs Q construits pour les chaînes de spins.

S'appuyant sur cette solution, un résultat très important de cette thèse est l'écriture, pour plusieurs modèles intégrables, d'un système fini d'équations intégrales non linéaires qui décrit les corrections de tailles finies. Ce résultat est obtenu en trouvant les propriétés analytiques de ces fonctions Q . Ces propriétés peuvent être obtenues à partir des équations issues de l'ansatz de Bethe thermodynamique, ou elles peuvent être postulées à partir des symétries du modèle et de considérations physiques. Nous verrons comment cette nouvelle méthode peut être appliquée aussi bien dans le cas du champ chiral principal que pour la dualité AdS/CFT. Dans le cas de la dualité AdS/CFT, les équations issues de l'ansatz de Bethe thermodynamique sont bien connues et ont été largement étudiées. Nous montrerons qu'une forme de ces équations permet de prouver les propriétés postulées pour les fonctions T et Q . Réciproquement, ces propriétés analytiques des fonctions T et Q permettent de démontrer les équations traditionnellement obtenues à partir de l'ansatz de Bethe thermodynamique. Cela signifie que les conditions d'analyticité sur lesquelles s'appuie notre système fini d'équations intégrales constitue une nouvelle formulation des équations d'ansatz de Bethe thermodynamique, mais qui se ramène désormais à un nombre fini d'équations.

Résumé détaillé et plan de ce manuscrit

Ce manuscrit, rédigé essentiellement en anglais, est principalement divisé en chapitres, mais contient aussi quelques annexes, dont la lecture n'est pas forcément nécessaire mais donne au lecteur les éléments pour comprendre les outils utilisés. On pourra noter l'existence d'un index par mots clés (page 250), où sont aussi indiquées de nombreuses notations utilisées dans ce texte, avec un renvoi à la page correspondante. Par ailleurs la bibliographie (page 252) regroupe les différents articles cités dans ce manuscrit, par ordre alphabétique. Seuls les articles [10KL], [11GKLT], [12KLT], [11GKLV] et [11AKL⁺] sont regroupés à part. Il s'agit des articles écrits pendant ma thèse, et qui présentent les résultats exposés dans ce manuscrit.

Le présent manuscrit ne se donne pas uniquement pour objectif de reproduire le contenu de ces articles, mais aussi d'introduire les idées ayant mené à ces articles, et de justifier de manière détaillée les constructions utilisées. Ce souhait d'écrire une présentation pédagogique des résultats a parfois abouti à présenter des arguments différents de ceux donnés dans ces articles, et tous les résultats de ces articles n'ont pas forcément été reproduits dans ce manuscrit de façon exhaustive. Un lecteur souhaitant aller un peu plus loin est donc invité à lire aussi ces articles en complément du présent manuscrit.

La structure de ce manuscrit et la suivante :

Chapitre introductif Le premier chapitre de ce manuscrit introduit la notion d'intégrabilité et l'ansatz de Bethe à partir de l'exemple simple de la chaîne de spins de Heisenberg, avec conditions de bord périodiques. Nous verrons dans ce chapitre comment il est possible, pour cette chaîne de spins, de déterminer les états propres du Hamiltonien. Nous verrons que si l'on cherche des états propres sous la forme de combinaisons linéaires d'ondes de spins, alors des équations appelées "équations de Bethe" apparaissent naturellement, et décrivent à quelle condition une combinaison linéaire d'ondes planes est un état propre du Hamiltonien.

Cet exemple de chaîne de spins, étudié dans la section I.1, permettra de montrer ce que l'on entend dans cette thèse par système intégrable, à savoir un système où les fonctions d'onde des états propres sont des superpositions d'ondes planes obéissant à des équations de Bethe. Ces modèles sont exactement solubles, non pas au sens où l'on connaît une expression complètement explicite des vecteurs propres et de leurs énergies, mais où l'on sait les construire de manière exacte si l'on résout une équation (l'équation de Bethe), dont la forme est la même pour tous les modèles intégrables, mais qui est en

général difficile à résoudre analytiquement. Cette équation fait apparaître une matrice \hat{S} , qui dépend du modèle et caractérise l'interaction de deux particules. Nous verrons que dans ces modèles intégrables les interactions entre un nombre arbitraire de particules s'expriment en termes d'interactions entre deux particules.

Comme indiqué en section I.2, il existe des théories de champs quantiques, généralement bidimensionnelles (avec une dimension spatiale et une dimension temporelle), qui sont intégrables au sens ci-dessus. En revanche, nous verrons aussi que ces théories ne sont intégrables que si la dimension spatiale est de grande taille (et périodique). Nous nous intéresserons ici aux corrections de taille finie, pour lesquelles les niveaux d'énergie peuvent aussi être calculés de manière exacte, grâce à la méthode dite d'ansatz de Bethe thermodynamique (présentée dans le chapitre III).

Enfin la section I.3 introduira brièvement la dualité AdS/CFT, et indiquera pourquoi elle constitue un modèle intégrable. L'étude des corrections de taille finie de ce modèle fera l'objet du chapitre IV.

Chapitre II Le chapitre II propose une analyse beaucoup plus détaillée d'une première classe de modèles intégrables, à savoir certaines chaînes de spins généralisant la chaîne de spins de Heisenberg étudiée dans le chapitre introductif I.1. Ce chapitre II montrera comment obtenir les équations de Bethe et le spectre du Hamiltonien pour ces chaînes de spins intégrables, en introduisant des charges conservées (les opérateurs T et les opérateurs Q) et en définissant un "flot de Bäcklund".

Ces chaînes de spins seront introduites dans la section II.1. Nous y construirons de nombreuses charges conservées appelées "opérateurs T", en faisant appel à des notions de théorie des groupes et des représentations introduites dans l'annexe A. Ces opérateurs T sont construits en section II.1.1, puis sont exprimés en termes d'un opérateur différentiel \hat{D} , dont de nombreuses propriétés sont données dans l'annexe B. Cela permet de montrer en section II.1.4 que ces opérateurs T satisfont une équation bilinéaire appelée équation de Hirota. La preuve de cette équation est donnée en suivant [KV08], et repose sur les propriétés combinatoires de l'opérateur \hat{D} . Nous montrerons ensuite comment cette équation peut se réécrire comme une identité combinatoire, obtenue au cours de cette thèse, que nous avons appelée "Master identity" dans l'article [12KLT], et que nous appellerons "main identity on co-derivatives" dans ce manuscrit.

La section II.2 présentera des résultats connus sur les transformées de Bäcklund. Cette section montrera comment exprimer une solution assez générale de l'équation de Hirota en termes de "fonctions Q". Nous y supposerons l'existence d'un flot de Bäcklund polynômial et montrerons que sous cette hypothèse, les équations de Bethe découlent de conditions d'analyticité.

La section II.3 présente des résultats obtenus au cours de cette thèse [12KLT]. Il y est démontré explicitement, pour toutes les chaînes de spins définies en section II.1 qu'un flot de Bäcklund polynômial existe. Cette section permet aussi d'écrire explicitement les opérateurs T en termes des opérateurs Q, qui sont eux-mêmes définis à partir de l'opérateur différentiel \hat{D} . Ils peuvent aussi être vus comme une certaine limite des opérateurs T.

Enfin la section II.4 présente un autre résultat obtenu pendant cette thèse [11AKL⁺],

à savoir le lien entre cette construction du flot de Bäcklund et les constructions de “fonctions τ ” qui décrivent l’intégrabilité classique.

Chapitre III Le chapitre III se concentre sur les corrections de taille finie : il décrit la résolution de théories de champs intégrables avec une dimension spatiale de taille finie et des conditions au bord périodiques. La méthode de résolution, présentée en section III.1 dans le cas du modèle chiral principal, est l’ansatz de Bethe thermodynamique, décrit dans la littérature pour de nombreux modèles. Elle aboutit en général à un système Y , qui donne lieu à la même équation de Hirota que dans le chapitre précédent. C’est pourquoi l’on a besoin de décrire de la façon la plus générale possible les solutions de l’équation de Hirota.

La section III.2 décrit donc des solutions assez générales de l’équation de Hirota, qui prennent exactement la même forme que les solutions trouvées au chapitre II. Une condition est identifiée (la condition de typicalité) sous laquelle on peut écrire les fonctions T à partir d’un nombre fini de fonctions Q . Cette expression en termes de fonctions Q était déjà connue dans certains cas [KLWZ97], mais constitue pour partie (pour les “T-hooks”) un résultat obtenu dans cette thèse [11GKLT].

Enfin la section III.3 introduit un important résultat [10KL] de cette thèse, à savoir la possibilité d’écrire le système Y sous la forme d’un nombre fini d’équations portant sur un nombre fini de densités. De plus ces équations expriment simplement des conditions d’analyticité assez naturelles.

Chapitre IV Enfin le chapitre IV conclut ce manuscrit en s’attaquant à la dualité AdS/CFT. Cette dualité suscite un fort intérêt scientifique du fait des espoirs qu’elle engendre notamment pour comprendre des théories de champs à un niveau non-perturbatif.

La méthode d’ansatz de Bethe thermodynamique a déjà permis d’obtenir un système Y pour les niveaux d’énergie de cette dualité. Dans ce chapitre nous montrerons comment écrire des conditions d’analyticité naturelles sur les fonctions T , qui sont équivalentes au système Y déjà connu. Ces résultats [11GKLV] éclairent singulièrement la nature de ce système Y , en trouvant de nouvelles symétries qu’il satisfait et qui s’interprètent physiquement.

Suivant la même méthode que dans le cas du champs chiral principal, nous commençons par exprimer en section IV.3 la solution générale de l’équation de Hirota en termes de trois fonctions réelles. Les principales équations et les nouvelles symétries qui caractérisent ces fonctions T sont ensuite présentées en section IV.4, avant de présenter nos résultats numériques.

Enfin une conclusion page 219 discute les apports de cette approche et les questions soulevées par cette thèse.

Abstract

This thesis is devoted to the study of integrable quantum systems such as spin chains, two-dimensional field theories and the AdS/CFT duality. This AdS/CFT duality is a conjecture, stated in the end of the last century, which relates (for instance) the non-perturbative regime of a superconformal gauge theory (called $\mathcal{N}=4$ super Yang-Mills) and the perturbative regime of a string theory on a 10-dimensional space with the geometry $\text{AdS}_5 \times \text{S}^5$.

This thesis explores the similarities between integrable spin chains and quantum field theories, such as Super Yang Mills. We first study integrable spin chains and build explicitly a polynomial “Bäcklund flow” and polynomial “Q-operators”, which allow to diagonalize the Hamiltonian. We then study integrable field theories et show how to obtain “Q-functions”, analogous to the Q-operators built for spin chains. It turns out that several important informations are contained in the analytic properties of these Q-functions. That allows to obtain, in the framework of the thermodynamic Bethe ansatz, a finite number of non-linear integral equations encoding the spectrum of the theory which we study. This system of equations is equivalent to an infinite system of equations, known as “Y-system”, which had been quite recently conjectured in the case of the AdS/CFT duality.

Acknowledgements

I want to thank very deeply my PhD advisor V. Kazakov for the way he managed to introduce me to some very interesting problems and the way he guided me through this couple of years of research.

I also thank Romuald Janik and Gregory Korchemsky who accepted to be the *rapporteurs* for this thesis, and Arkady Tseytlin, Konstantin Zarembo and Jean-Bernard Zuber, for taking part in the jury.

I also want to thank my coauthors A. Alexandrov, N. Gromov, V. Kazakov, Z. Tsuboi, D. Volin and A. Zabrodin, for the work we did together during this PhD. I also wish to thank all the AdS/CFT community for many discussions (for instance with I. Kostov, T. Łukowski, D. Serban, M. Staudacher, P. Vieira and many others). I also want to thank A. Bobenko, L. Fevrier, and W. Krauth for fruitful discussions.

Contents

Acknowledgements	1
Contents	3
Introduction	4
Detailed summary	7
I Integrability and Bethe ansatz	10
I.1 Coordinate Bethe ansatz for the Heisenberg spin chain	11
I.2 Generalization to other integrable models	15
I.3 AdS/CFT duality	18
II Q operators for spin chains	22
II.1 Spin chains and T-operators	23
II.1.1 Construction of the T-operators	24
II.1.2 Differential expression of the T-operators	33
II.1.3 Generalization to super-groups	36
II.1.4 Hirota equation and CBR determinant formula	38
II.1.5 Jacobi identity and bilinear equations	45
II.1.6 Conservation of the number of particles	51
II.2 Bäcklund transform and Bethe equations	52
II.2.1 Introduction of the Bäcklund flow	53
II.2.2 Bethe equations and energy spectrum	58
II.3 Differential expression of Q-operators	68
II.3.1 Derivation of the simplest Q-operators, when $L = 1$	68
II.3.2 General expression of the Bäcklund flow	70
II.3.3 Degree of the T-operators	80
II.4 Relation to the classical integrability	82
II.4.1 The MKP hierarchy and the CBR formula	82
II.4.2 The rational solution of the MKP hierarchy	86
III Thermodynamic Bethe Ansätze and Y-systems	88
III.1 Example of the principal chiral model	90
III.1.1 The asymptotic Bethe ansatz	90
III.1.2 Thermodynamic Bethe ansatz	94
III.2 General solution of Hirota equation	103
III.2.1 Examples of (a, s) lattice	105
III.2.2 Equivalence of Hirota equation and Y-system equation	111

III.2.3	Typical solution of Hirota equation	116
III.2.4	Gauge conditions and Wronskian expressions of the T -functions	129
III.2.5	Writing FiNLIEs	131
III.3	FiNLIE for the principal chiral model	133
III.3.1	Y-system equation	133
III.3.2	Asymptotic limit	133
III.3.3	Parameterization of the q -functions	142
III.3.4	Set of equations	152
III.3.5	Computation of the energy	160
III.4	Conclusion	168
IV	FiNLIE for the AdS/CFT Duality	170
IV.1	The Y-system for AdS/CFT	171
IV.2	The asymptotic limit	174
IV.3	Parameterization of the T - and q -functions	178
IV.3.1	Analyticity strips	178
IV.3.2	Parameterization of the q -functions	184
IV.4	Set of equations	189
IV.4.1	The “Physical Gauge”	189
IV.4.2	The \mathbb{Z}_4 symmetry	198
IV.4.3	Set of equations and iterative algorithm	207
IV.5	Numerical results	217
IV.6	Conclusion	218
	Conclusion and outlook	219
A	Introduction to representations of matrix groups	221
A.1	Notations and tensor product	222
A.2	Representations of $SU(2)$	223
A.3	Young diagrams and representations of $GL(K)$	225
A.3.1	Young diagrams	225
A.3.2	Decomposition of the tensor representation of $GL(K)$	225
A.3.3	Finite rank groups	230
A.3.4	Characters	232
A.4	Generalization to the super-group $GL(K M)$	233
B	Properties of co-derivatives	237
B.1	Diagrammatic expressions for co-derivatives	238
B.2	Identities involving co-derivatives	243
B.2.1	Yang-Baxter Equation	244
B.2.2	Bilinear identities	245
B.3	Co-derivatives and eigenvalues	247
	Index and notations	250
	References	252

Introduction

Theoretical quantum physics currently faces two very important challenges: the non perturbative understanding of gauge theories on the one hand, and the quantum description of gravity on the other hand.

Gauge theories are a quantum description of interacting particles. In this formalism, some fields (such as the electromagnetic field) are “quantized”, and their quantization gives rise to particles (such as the photons), which transmit interactions. In this quantum formalism, one cannot say that a particle has a well-defined trajectory, in the sense that it does not have a well-defined position at every time. Instead, in every process which we can measure, many possible trajectories do contribute, and one should sum their contributions. In fact, one should even sum over different histories (which generalize the idea of “trajectories”), including some histories which involve creations or annihilations of particles.

We see that this formalism describes the interaction of quantum particles by summing infinitely many different “histories”. A natural question is then whether this sum is finite or not. For some of these theories (called asymptotically free), there exist at least some regimes (called perturbative regimes), where an history contributes less and less as it contains more and more creations or annihilations of particles. In this regime, it is possible to compute some physical quantities by truncating the sum, keeping only a finite number of terms, which involve only a limited number of creations or annihilations of particles. The better accuracy we wish to obtain, the more terms we have to keep in the sum.

For some of these models, such as the interactions between quarks (the smallest known components of atomic nuclei), this perturbative approach only allows to describe processes which take place at an high enough energy. There are some properties of these theories which are not explained by this perturbative approach, such as the confinement of quarks inside hadrons (such as neutrons and protons). This confinement is a property of quarks which means that it is not possible to observe one single quark, and which only allows to observe particles made of several quarks.

Another key challenge of theoretical physics is the quantum description of gravity. The formalism of gauge theories has already led to important successes, such as the construction of the “standard model”. This model describes all particles that we have observed so far, and it explains three out of the four (known) fundamental interactions of nature: the electromagnetic interaction, the “weak” interaction (involved in some nuclear reactions) and the “strong” interaction (which describes the interactions between quarks).

But gravity does not fit this picture, and up to now our most successful description of gravity at the quantum level is given by “string theories”. A key difference between gauge theories and string theories is that the particles are not viewed as point-like, but as one-dimensional extended objects (which can be viewed as small strings).

In the end of the last century, a duality was conjectured, which connects these two key challenges. On the one hand, this duality involves the gauge theory called super Yang-Mills, which exhibits many symmetries (it is invariant under conformal transformations, and under four super-symmetric transformations). On the other hand, it involves a string theory on the ten-dimensional spacetime $AdS_5 \times S^5$, made out of a sphere and an “Anti de Sitter” space. This duality conjectures that for instance, some quantities which are hard to compute in the strong coupling regime of the gauge theory (in the non-perturbative regime), can be obtained by a perturbative computation in the string theory. Conversely, properties of the (non-perturbative) strong coupling regime of the string theory can be obtained from the perturbative regime of the super Yang-Mills gauge theory.

This duality, called AdS_5/CFT_4 (or simply AdS/CFT) is very powerful because it relates perturbative and non-perturbative regimes. But this property also makes it very hard to test this duality explicitly, because in order to check it, we should perform independently a perturbative and a non-perturbative computation to compare them. In this thesis, we will see that some quantities can be computed exactly (in the sense that the computation will not involve the truncation of a sum, and that it will not be restricted to a perturbative regime), in the framework of this duality and, more generally, in the framework of integrable systems.

As we will see, integrability is a powerful tool which allows to perform exact computations in several models exhibiting quite specific features. These models, called “integrable models”, have for instance an important number of conserved charges. In particular we will see how to construct, for integrable spin chains, some operators called “transfer matrices” (or simply “T-operators”). We will also see that some operators having the same properties (they obey the same Hirota equation) exist for integrable field theories, and in particular in the case of AdS/CFT . One of the results of this thesis is that these T-operators can be written through “Q-operators”, which we construct explicitly in the case of integrable spin chains. This result involves elementary combinatorial arguments which will be introduced and motivated.

Next, we will see that several other models than spin chains (in particular some two-dimensional field theories) are integrable. More precisely, we will see that if the space is periodic, but large enough, these models can be solved exactly by means of the “Bethe ansatz”. Hence we will come to the question of finite size effects, i.e. the question whether anything can still be obtained when the space is smaller. In this thesis, we will answer this question by means of the thermodynamic Bethe ansatz, a method which is all the more interesting as it applies for instance to the AdS/CFT duality. In the framework of this duality, this method allows to compute exactly (i.e. non-perturbatively) the spectrum (i.e. the energy levels of the string theory, or the scaling dimensions of the operators of super Yang-Mills). We will see that this thermodynamic Bethe ansatz gives

rise to “ T -functions” which generalize the T -operators of spin chains, and obey the same Hirota equation.

Then, we will construct the general¹ solution of Hirota equation for several symmetry groups. This result, part of which is a new result of this PhD, involves “ Q -functions” which generalize the “ Q -operators” constructed explicitly for spin chains.

Using this solution, a very important result of this thesis is the possibility to write, for several integrable field theories, a finite set of non-linear integral equations (FiNLIE), encoding the finite size corrections. This FiNLIE is obtained by finding the analytical properties of these Q -functions, and we will see that these analytical properties can either be conjectured from the symmetries of the model and from physical considerations, or they can be derived from the thermodynamic Bethe ansatz. We will see how this new approach can be applied in the case of the principal chiral model as well as in the case of the AdS/CFT duality.

In the case of the AdS/CFT duality, the equations arising from the thermodynamic Bethe ansatz are well known and have already been quite extensively studied in the literature. We will see that one form of these equations allows to prove the analytical properties conjectured for the T - and Q -functions. Conversely these analytical properties of the T - and Q -functions imply the equations which are usually obtained from the thermodynamic Bethe ansatz. This means that the analytical conditions giving rise to our FiNLIE are a new formulation of the thermodynamic Bethe ansatz’s equations, reduced to a finite set of equations.

¹More exactly, the solution which we will construct is the “typical solution” of Hirota equation, and we will define what typicality means.

Detailed summary

This manuscript is mainly divided into chapters, but it also contains two appendices. It is not necessary to read through these appendices, but it should give some basic tools to the reader, which will allow to understand the arguments of the main text. One should note the existence of an index (page 250), which lists several notations and keywords used in the text and which refers to the corresponding pages. There is also a bibliography, (page 252), which lists, in alphabetic order, the articles cited in this text. Only the articles [10KL], [11GKLT], [12KLT], [11GKLV] and [11AKL⁺] are listed separately. They are the articles written during my thesis, and they give the results written in this thesis.

The present thesis aims not only at repeating the content of these articles, but it also aims at motivating the constructions we used, with a quite high level of details. This aim to write a pedagogical presentation of these articles sometimes led to showing arguments which differ from the one exposed in these articles, and all the results of these articles were not necessarily repeated in this thesis. Therefore, a reader who wishes to go further than the present manuscript is invited to read these articles in addition to this thesis.

The structure of this thesis is as follows :

Introductory chapter The first chapter of this thesis introduces the notion of integrability and of Bethe ansatz from the simple example of the Heisenberg spin chain with periodic boundary conditions. In this chapter we will see how it is possible to find the eigenstates of the Hamiltonian of this spin chain. We will see that these eigenstates can be found in the form of linear combinations of planar waves obeying some equation called the “Bethe equations” (these equations are the conditions under which a combination of planar waves is an eigenstate of the Hamiltonian).

This spin chain example, studied in section I.1, will be used to introduce what we will mean by an integrable system, i.e. a system where the wave functions of the eigenstates are given by superpositions of planar waves obeying some Bethe equations. These models are exactly solvable, not in the sense that we know a completely explicit expression of the eigenstates and of their energy, but rather in the sense that we know how to construct them if we solve an equation (the Bethe equation), which takes the same form for all integrable models but is in general quite hard to solve analytically. This equation involves an \hat{S} -matrix, which depends on the model and characterizes the interaction between two particles. We will see that for these integrable models, the interactions between an arbitrary number of particles can be expressed in terms of successive interactions between two particles.

As we will see in section I.2, there exist quantum field theories which are integrable in

the above sense. These models are usually two-dimensional (with one space dimension and one time dimension), and we will see that they are integrable only if the space dimension has a very large size (and is periodic). In this thesis, we will be interested in the finite size corrections, which means the exact (i.e. non-perturbative) computation of the energy levels when the size of the space dimension is finite, and we will study them by means of a method called the thermodynamic Bethe ansatz (explained in the chapter III).

Then the section I.3 will briefly introduce the AdS/CFT duality, and explain why it is an integrable model. In the framework of this duality, the finite size corrections will be studied in the chapter IV.

Chapter II The chapter II gives a more detailed analysis of a first integrable model, namely a spin chain, generalizing the analysis of the Heisenberg spin chain presented in the introductory chapter I.1. This chapter II will show one derivation of the Bethe equations for these integrable spin chains, obtained by introducing some conserved charges (the “T-operators” and the “Q-operators”) and by defining a “Bäcklund flow”.

These spin chains will be introduced in section II.1. In this section, we will construct many conserved charges called “T-operators”, using some notions of group theory and representations, introduced in the appendix A. These T-operators are constructed in section II.1.1, and are then expressed through a differential operator \hat{D} . Many important properties of this operator are given in the appendix B. This construction allows to show in section II.1.4 that these T-operators obey a bilinear equation called the Hirota equation. The proof of this equation is given by following [KV08], and it relies on the combinatorial properties of the operator \hat{D} . Next we will see how this equation can be rewritten as a combinatorial identity obtained in this PhD, which we called “Master identity” in the article [12KLT], and which we will call “main identity on co-derivatives” in the present thesis.

The section II.2 will then give known results on the Bäcklund transforms. This section will show how to express a quite general solution of the Hirota equation in terms of a finite number of “Q-functions”. In this section, we will assume that a polynomial Bäcklund flow exists, and we will show that then, the Bethe equations follow from the analyticity constraints (i.e. from the polynomiality).

Next, the section II.3 gives results obtained in this PhD. It is explicitly derived, for all the spin chains introduced in section II.1, that a polynomial Bäcklund flow exists. This section also allows to explicitly write the T-operators in terms of some Q-operators, which are themselves defined through the differential operator \hat{D} . These Q-operators can also be viewed as a quite singular limit of the T-operators.

Finally the section II.4 sketches another result of this PhD [11AKL⁺], namely the relation between this construction of the Bäcklund flow and the construction of the “ τ -functions” which describe classical integrability.

Chapter III The chapter III is focussed on the finite size corrections: it explains the solution of integrable field theories with a space dimension of size $L < \infty$ and with periodic boundary conditions. This solution is based on the method called thermodynamic

Bethe ansatz, presented in section III.1 for the principal chiral model. This method is described in the literature for several integrable models, and it usually gives rise to a Y-system, which implies the same Hirota equation as in the previous chapter. Therefore we become interested in writing the most general possible solution of this Hirota equation.

The section III.2 describes quite general solutions of the Hirota equation, and these solutions take exactly the same form as the solutions found in chapter II. A condition is identified (the typicality condition) under which the T -functions are expressed in terms of a finite number of Q -functions. This expression was already known in some cases [KLWZ97], but part of it (for the “T-hooks”) is a new result of this PhD.

Finally, the section III.3 presents a very important result of this thesis [10KL]: it is shown that the Y-system can be recast into a finite set of equations on a finite set of “densities”. Moreover these equations simply express some quite natural analyticity conditions.

Chapter IV To finish with, the chapter IV concludes this manuscript with the case of the AdS/CFT duality. This duality is a very active field of research because it gives (for instance) very interesting hopes for a non-perturbative understanding of field theories.

The thermodynamic Bethe ansatz already allowed to obtain a Y-system (described in the literature [GKV09a]) which gives the energy levels in this AdS/CFT duality. In this chapter, we will show how to write some natural analyticity conditions on the T -functions, which are equivalent to the previously-known Y-system. This result sheds light on the nature of the Y-system, by finding new symmetries which it obeys, and which have a very physical interpretation.

Following the same method as in the case of the principal chiral model, we start by parameterizing in section IV.3 a general solution of Hirota equation in terms of three real functions. The main equations and symmetries which constrain these T -functions are then given in section IV.4, where the FiNLIE is derived, before we show our numerical results.

Finally, a conclusion (page 219) discusses how our approach solves the initial problem, and what new questions arise from this.

Chapter I

Integrability and Bethe ansatz

I.1 Coordinate Bethe ansatz for the Heisenberg spin chain

As a first introduction to this manuscript, let us briefly recall the solution to the so-called Heisenberg “ $XXX_{1/2}$ ” spin chain, which corresponds to a quantum version of the Ising model.

This chain consists of L spins, labeled by $i \in \llbracket 1, L \rrbracket$, where we use the notation $\llbracket n_1, n_2 \rrbracket$ to denote the set $[n_1, n_2] \cap \mathbb{Z}$. Each spin is in a superposition $|\psi\rangle \in \mathcal{H}_i = \mathbb{C}^2$ of the states $|\uparrow\rangle$ and $|\downarrow\rangle$. The Hilbert space is therefore $\mathcal{H} = \bigotimes_{i=1}^L \mathcal{H}_i = (\mathbb{C}^2)^{\otimes L}$, while the Hamiltonian is

$$\boxed{H = L - 2 \sum_i \mathcal{P}_{i,i+1}}. \quad (\text{I.1})$$

It is expressed in terms of a permutation operator $\mathcal{P}_{i,j}$ defined by

$$\mathcal{P}_{i,j} (|\phi_1\rangle \otimes |\phi_2\rangle \otimes \cdots \otimes |\phi_L\rangle) = |\phi_{\tau_{[i,j]}(1)}\rangle \otimes |\phi_{\tau_{[i,j]}(2)}\rangle \otimes \cdots \otimes |\phi_{\tau_{[i,j]}(L)}\rangle \quad (\text{I.2})$$

$$\text{where } \tau_{[i,j]}(k) = \begin{cases} j & \text{if } k = i \\ i & \text{if } k = j \\ k & \text{otherwise} \end{cases}. \quad (\text{I.3})$$

This operator exchanges the values of two spins, giving for instance $\mathcal{P}_{1,3} |\downarrow\downarrow\uparrow\rangle = |\uparrow\downarrow\downarrow\rangle$.

More precisely, we will study a spin chain with periodic boundary conditions, which means that the Hamiltonian (I.1) is defined as

$$H = L - 2 \sum_{i=1}^{L-1} \mathcal{P}_{i,i+1} - 2 \mathcal{P}_{L,1}. \quad (\text{I.4})$$

The expression (I.1) may seem unusual, but we will actually show in section II.1.1.1 that it coincides with the usual ferromagnetic Hamiltonian $H = -\sum_i \vec{\sigma}_i \cdot \vec{\sigma}_{i+1}$.

The simplest eigenstate of the Hamiltonian (I.1) is the following state, which we will call the vacuum:

$$|\{\ \}\rangle \equiv |\underbrace{\downarrow\downarrow\downarrow \cdots \downarrow}_L\rangle. \quad (\text{I.5})$$

It is clearly an eigenstate, and its energy is $E_0 \equiv -L$ (i.e. it satisfies $H|\{\ \}\rangle = -L|\{\ \}\rangle$). It is an arbitrary convention to choose a state with all spins down, while the opposite convention (choosing $|\{\ \}\rangle$ with all spins up) would give the same results.

Single-particle states The next simplest states one can think of are the states

$$|\{i\}\rangle \equiv |\underbrace{\downarrow\downarrow\downarrow \cdots \downarrow}_{i-1} \uparrow \underbrace{\downarrow\downarrow\downarrow \cdots \downarrow}_{L-i}\rangle. \quad (\text{I.6})$$

These states will be viewed as the presence of a “particle”, called magnon, at site i . This magnon physically is just a flip of one spin with respect to the vacuum $|\{ \} \rangle$. More generally we will call “number of particles” the number of “spins up”, and this number turns out to be invariant under H . Therefore we can look for a basis of eigenstates of H having fixed “number of particles”. The states (I.6) are actually not eigenstates of H if $L \geq 2$ but we will show that some combinations of them are eigenstates.

To this end, let us recall that the permutation operator $\mathcal{P}_{i,j}$ exchanges the spins at position i and j , hence

$$\mathcal{P}_{i,j} |\{k\}\rangle = |\{\tau_{[i,j]}(k)\}\rangle \quad (\text{I.7})$$

where $\tau_{[i,j]}$ is defined by (I.3). We can then write the action of H on the state

$$|p\rangle \equiv \sum_{j=1}^L e^{ipj} |\{j\}\rangle : \quad (\text{I.8})$$

$$H|p\rangle = L|p\rangle - 2 \sum_{j=1}^L \sum_{i=1}^L e^{ipj} \mathcal{P}_{i,i+1} |\{j\}\rangle \quad (\text{I.9})$$

$$= L|p\rangle - 2 \left((L-2)|p\rangle + \sum_{j=1}^L e^{ipj} (|\{j+1\}\rangle + |\{j-1\}\rangle) \right) \quad (\text{I.10})$$

$$= (-L + 4 - 4 \cos(p)) |p\rangle - 2 (e^{iLp} - 1) |\{1\}\rangle - 2 (e^{ip} - e^{i(L+1)p}) |\{L\}\rangle, \quad (\text{I.11})$$

where i denotes the imaginary number with imaginary part equal to one, and we identified $|\{L+1\}\rangle = |\{1\}\rangle$ in (I.10). From (I.11), we see that $|p\rangle$ is an (unnormalized) eigenstate of the Hamiltonian if and only if $e^{iLp} = 1$. This condition is simply the constraint that the wave function $\Psi(j) = \langle \{j\} | p \rangle = e^{ipj}$ has to be periodic with period L , as imposed by the identification $|\{L+1\}\rangle = |\{1\}\rangle$.

This already allowed us to identify L “single-particle” eigenstates (corresponding to $p = 0, \frac{2\pi}{L}, \frac{4\pi}{L}, \dots, \frac{2(L-1)\pi}{L}$). They have energy $(E_0 + 4 - 4 \cos(p))$, with $e^{iLp} = 1$.

Two-particles states Next, one can consider the following “two-particles” states:

$$|\{j, k\}\rangle \equiv \underbrace{|\downarrow\downarrow\downarrow \cdots \downarrow\rangle}_{j-1} \uparrow \underbrace{|\downarrow\downarrow\downarrow \cdots \downarrow\rangle}_{k-j-1} \uparrow \underbrace{|\downarrow\downarrow\downarrow \cdots \downarrow\rangle}_{L-k}, \quad \text{where } j < k \quad (\text{I.12})$$

$$|p_1, p_2; S\rangle \equiv \sum_{j < k} (e^{i(p_1j + p_2k)} + S e^{i(p_1k + p_2j)}) |\{j, k\}\rangle. \quad (\text{I.13})$$

The action of H is a bit harder to compute explicitly than in (I.9-I.11), but we can see that

$$H|\{i, j\}\rangle = L|\{i, j\}\rangle - 2 \left((L-4)|\{i, j\}\rangle + |\{i+1, j\}\rangle + |\{i-1, j\}\rangle + |\{i, j+1\}\rangle + |\{i, j-1\}\rangle \right) \quad \text{if } 1 < i < j-1 < L-1. \quad (\text{I.14})$$

If we do the natural identifications $|\{i, L+1\}\rangle = |\{1, i\}\rangle$ and $|\{0, i\}\rangle = |\{i, L\}\rangle$, then this equation holds even if $j = L$ or $i = 1$.

From (I.14) we can see that up to “boundary” terms generalizing the last terms of (I.11), we have $H|p_1, p_2; S\rangle = (E_0 + 8 - 4(\cos(p_1) + \cos(p_2)))|p_1, p_2; S\rangle$, and we therefore expect that by setting these “boundary” terms to zero, we will find eigenstates with energy $E_{p_1, p_2} \equiv E_0 + 4 - 4\cos(p_1) + 4 - 4\cos(p_2)$. The boundary terms, which are given by $H|p_1, p_2; S\rangle - E_{p_1, p_2}|p_1, p_2; S\rangle$, are of two types:

- First, the terms below arise from the fact that (I.14) fails if $j = i + 1$:

$$(2(e^{ip_1}S + e^{ip_2}) - (1+S)(1 + e^{i(p_1+p_2)})) \sum_{j=1}^L e^{ij(p_1+p_2)} |\{j, j+1\}\rangle .$$

To have an eigenstate of H , it is necessary that these terms vanish, i.e.

$$\boxed{S = S(p_2, p_1) \equiv -\frac{1 + e^{i(p_1+p_2)} - 2e^{ip_2}}{1 + e^{i(p_1+p_2)} - 2e^{ip_1}}} . \quad (\text{I.15})$$

- Other terms appear at the boundary of the chain, as in (I.11). One can show that they cancel if the proper periodicity condition is imposed. This periodicity condition is

$$\forall 1 \leq k < L, \Psi(k, L) = \Psi(0, k) \quad \text{where } \Psi(j, k) \equiv e^{i(p_1 j + p_2 k)} + S e^{i(p_1 k + p_2 j)} \quad (\text{I.16})$$

and it is solved by

$$\boxed{e^{iLp_2} = S}, \quad \boxed{e^{iLp_1} = 1/S} . \quad (\text{I.17})$$

One can check that the above conditions (I.15, I.17) are sufficient conditions, under which $|p_1, p_2; S\rangle$ is an (unnormalized) eigenstate. One can also check (see for instance [KM97]), that this gives $\frac{L(L-1)}{2}$ independent eigenstates of this form. This means that all the “two-particles” eigenstates of the Hamiltonian are of this form.

M -particles states More generally, the Bethe ansatz tells that for an arbitrary number M of particles, the eigenstates should be looked for in the form

$$|p_1, p_2, \dots, p_M; \{\mathcal{A}_\sigma\}_{\sigma \in \mathcal{S}^M}\rangle \equiv \sum_{1 \leq j_1 < j_2 < \dots < j_M \leq L} \Psi(j_1, j_2, \dots, j_M) |\{j_1, j_2, \dots, j_M\}\rangle , \quad (\text{I.18})$$

$$\text{where } \Psi(j_1, j_2, \dots, j_M) \equiv \sum_{\sigma \in \mathcal{S}^M} \mathcal{A}_\sigma e^{i \sum_k p_{\sigma(k)} j_k} , \quad (\text{I.19})$$

where \mathcal{S}^M denotes the set of all permutations of $\{1, 2, \dots, M\}$. This state is a linear combination of M planar waves, and it is parameterized by the M momenta (or impulsions) p_i of these planar waves, and by the $M!$ coefficients \mathcal{A}_σ of the linear combination. This definition (I.19) generalizes the special cases (I.8) and (I.13) corresponding to $M = 1$

or $M = 2$, written with the normalization choice $\mathcal{A}_\mathbb{1} = 1$, where $\mathbb{1}$ denotes the identity permutation.

Like before, we can first see that

$$\begin{aligned} \mathbb{H} |\{j_1, j_2, \dots, j_M\}\rangle &= +L |\{j_1, j_2, \dots, j_M\}\rangle - 2(L - 2M) |\{j_1, j_2, \dots, j_M\}\rangle \\ &\quad - 2 \sum_{k=1}^M \left(|\{j_1, \dots, j_{k-1}, j_k + 1, j_{k+1}, \dots, j_M\}\rangle \right. \\ &\quad \left. + |\{j_1, \dots, j_{k-1}, j_k - 1, j_{k+1}, \dots, j_M\}\rangle \right) \end{aligned} \quad (\text{I.20})$$

if $j_1 > 1$ and $\forall k < M, j_{k+1} > j_k + 1$ and $j_M < L$.

This implies that up to ‘‘boundary’’ terms, $\mathbb{H} |p_1, p_2, \dots, p_M; \{\mathcal{A}_\sigma\}\rangle$ is equal to $\left(E_0 + \sum_{k=1}^M 4 - 4 \cos(p_k)\right) |p_1, p_2, \dots, p_M; \{\mathcal{A}_\sigma\}\rangle$. As a consequence, if this state is an eigenstate, its energy is

$$E = E_0 + \sum_{k=1}^M (4 - 4 \cos(p_k)) . \quad (\text{I.21})$$

Physically, this expression means that each particle has an energy $4 - 4 \cos(p_k) = 8 \sin^2(p_k/2)$. The energy of an ‘‘ M -particles state’’ is simply the vacuum energy E_0 , plus the sum of the energies of the particles. As in the two-particles case, one can then investigate all the extra-terms which have to be set to zero in order to obtain an eigenstate of \mathbb{H} :

- First, some terms arise from the states $|\{j_1, j_2, \dots, j_M\}\rangle$ where there is one k such that $j_{k+1} = j_k + 1$. For a given k , the cancellation of these terms reduces to the constraint

$$\forall \sigma, \quad \mathcal{A}_{\sigma \circ \tau_{[k, k+1]}} = - \frac{1 + e^{i(p_{\sigma(k)} + p_{\sigma(k+1)})} - 2e^{ip_{\sigma(k+1)}}}{1 + e^{i(p_{\sigma(k)} + p_{\sigma(k+1)})} - 2e^{ip_{\sigma(k)}}} \mathcal{A}_\sigma . \quad (\text{I.22})$$

These constraints impose that

$$\mathcal{A}_\sigma = N \epsilon(\sigma) \prod_{j < k} (1 + e^{i(p_{\sigma(j)} + p_{\sigma(k)})} - 2e^{ip_{\sigma(k)}}) , \quad (\text{I.23})$$

where N is a σ -independent normalization, and $\epsilon(\sigma) \equiv \prod_{i < j} \frac{\sigma(i) - \sigma(j)}{i - j}$ is the signature of the permutation σ .

- Then some extra terms arise at the boundaries of the spin chain, and their vanishing requires the periodicity of the wave function. More explicitly, the requirement $\Psi(j_1, j_2, \dots, j_{M-1}, L) = \Psi(0, j_1, j_2, \dots, j_{M-1})$ is satisfied if the momenta p_j satisfy:

$$\boxed{\forall 1 \leq j \leq M, \quad e^{iLp_j} = \prod_{k \neq j} S(p_j, p_k)} , \quad (\text{I.24})$$

where $S(p_j, p_k)$ is defined by (I.15).

One can actually show that finding sets of momenta satisfying the “Bethe equation” (I.24) always gives the wave function of an eigenstate, by plugging these momenta into (I.19) and (I.23). Moreover one can show that all eigenstates are obtained this way.

The “Bethe ansatz” is the name given to the “guess” that eigenstates should be found in the form (I.19). Solving the Bethe equations allows to find exactly the eigenstates, and their energy (I.21). This is why we say that the Heisenberg spin chain is “integrable”. That does not really mean that we know a completely explicit expression of the eigenstates and of their energy, but only that we know a simple equation (I.24) called “Bethe equation”, and we know that solving this equation solves exactly this model. Solving the Bethe equation analytically can nevertheless be a difficult task, especially when the number of particles (i.e. the number of planar waves, also called magnons) is large.

A more detailed account of this Bethe ansatz can be found in [Bet31, KM97]. The method given above is often called the “coordinate Bethe ansatz”, because it gives an expression for the wave function. There actually exist other ways to derive (I.21), (I.24) and (I.15), and one of them, based on the Hirota equation will be detailed in the chapter II of this manuscript. An nice introduction to the Bethe ansatz, as well as several alternative methods to obtain the Bethe equations (I.21), (I.24) and (I.15) are introduced for instance in the review [Sta12] and the references therein.

The chapter II will introduce a method based on the construction of a family of conserved charges called “T-operators”. We also see how to construct operators called the “Q-operators”, which belong to same family of commuting operators, and are the building blocks to express T-operators. The chapter II will introduce a few spin chains which generalize the Heisenberg $XXX_{1/2}$ spin chain and for which we can construct these operators explicitly (which is an original result obtained during this PhD). We will also see how these operators allow to diagonalize the Hamiltonian and recover these Bethe equations.

I.2 Generalization to other integrable models

In the previous section, we saw how the Bethe ansatz arises for the Heisenberg spin chain. Interestingly enough the same procedure can be used for many other integrable models, including spin chains with various Hamiltonians, as well as a few two-dimensional quantum field theories, also called “ σ -models” (some of them can be viewed as the limit of spin chains when the space is continuous instead of discrete).

As it is argued in [ZZ79], the wave function of several field theories can be obtained by a Bethe ansatz generalizing the ansatz of the previous section. The ansatz is then that the eigenstates, parameterized by sets of rapidities p_k (or momenta), have a wave function of the form

$$\Psi(j_1, j_2, \dots, j_M) \equiv \sum_{\sigma \in \mathcal{S}^M} \mathcal{A}_\sigma e^{i \sum_k p_{\sigma(k)} j_k}, \quad (\text{I.25})$$

where (by contrast to the previous section) the positions j_1, j_2, \dots, j_M are not necessarily integers. In general, the wave function has several components (if the theory has several

different types of particles), and the coefficients \mathcal{A}_σ are vectors¹.

To write the ansatz (I.25), it is clearly crucial² that the space is one-dimensional, i.e. that the positions j_1, j_2, \dots, j_M are numbers, and not vectors. It also assumes that the number of particles is conserved.

In field theories, planar waves describe free particles and the ansatz (I.25) only describes a specific domain in the physical space: the domain where the positions j_1, j_2, \dots, j_M are separated by distances large enough compared to the interaction range. Describing particles coming close to each other is a more complicated, but fortunately not necessary task. In fact it is enough to know the main features of the wave function of two-particles states (when the two particles are separated by small distances), and from this one can construct the wave function when two particles are close to each other and all the other ones are far away. One can then argue that the only properties of two-particles states which we need to know are encoded into an \hat{S} -matrix $\hat{S}(p, p')$, and that the wave function is constrained to obey the equation

$$\forall \sigma, \quad \mathcal{A}_{\sigma \circ \tau_{[k, k+1]}} = -\hat{S}(p_{\sigma(k+1)}, p_{\sigma(k)}) \mathcal{A}_\sigma, \quad (\text{I.26})$$

which generalizes the equation (I.22). One should note that $\hat{S}(p, p')$ has to be a matrix because \mathcal{A}_σ and $\mathcal{A}_{\sigma \circ \tau_{[k, k+1]}}$ are vectors. This matrix encodes all the information that we need to know about the behavior of the wave function when two particles are close to each other (compared to the interaction range).

If this ansatz holds, then the eigenstates are completely fixed by the two-particles interactions, encoded into the \hat{S} -matrix $\hat{S}(p, p')$. This \hat{S} -matrix cannot be completely arbitrary, and if (I.26) has a solution, then $\hat{S}(p, p')$ has to obey the following constraint

$$A_{\sigma \circ \tau_{[k, k+1]} \circ \tau_{[k-1, k]} \circ \tau_{[k, k+1]}} = A_{\sigma \circ \tau_{[k-1, k]} \circ \tau_{[k, k+1]} \circ \tau_{[k-1, k]}} \quad (\text{I.27})$$

$$\text{hence } \hat{S}(p', p) \cdot \hat{S}(p'', p) \cdot \hat{S}(p'', p') = \hat{S}(p'', p') \cdot \hat{S}(p'', p) \cdot \hat{S}(p', p) \quad (\text{I.28})$$

which arises from the fact that $\tau_{[k, k+1]} \circ \tau_{[k-1, k]} \circ \tau_{[k, k+1]} = \tau_{[k-1, k]} \circ \tau_{[k, k+1]} \circ \tau_{[k-1, k]}$, by denoting $p = p_{\sigma(k-1)}$, $p' = p_{\sigma(k)}$ and $p'' = p_{\sigma(k+1)}$. This factorization formula (illustrated by figure I.1) actually means that the interaction of three particles is obtained as a product of two-particles interactions, and this product is invariant under a specific reordering.

We see that this ansatz puts very strong constraints on the theory, and it can only work for very specific models. These models should be two-dimensional (with a one-dimensional space dimension, and a time dimension) with a conservation of the number of particles, and a factorization property. It is argued in [ZZ79] that the ansatz holds if the number of conserved charges is infinite.

¹For a field theory with K different types of particles, the analogous of the state (I.6, I.12, ...) is the states $|\{n_1(j_1), n_2(j_2), \dots, n_M(j_M)\}\rangle$ denoting the presence of a particle of type n_1 at position j_1 , and of a particle of type n_2 at position j_2 , etc. Then a general state (with M particles) is written as $\sum \Psi_{n_1, n_2, \dots, n_M}(j_1, j_2, \dots, j_M) |\{n_1(j_1), n_2(j_2), \dots, n_M(j_M)\}\rangle$, where $\Psi_{n_1, n_2, \dots, n_M}(j_1, j_2, \dots, j_M)$ denotes the coordinates of $\Psi(j_1, j_2, \dots, j_M) \in (\mathbb{C}^K)^{\otimes M}$. Hence we see that the wave function belongs to $(\mathbb{C}^K)^{\otimes M}$, and hence \mathcal{A}_σ also belongs to $(\mathbb{C}^K)^{\otimes M}$.

²The fact that the space dimension is one-dimensional is necessary here to have a sum over permutations. This sum corresponds to the fact that if the momenta of the spin waves are numbers (and not vectors), then they are necessarily ordered in one out of $M!$ possible ways.

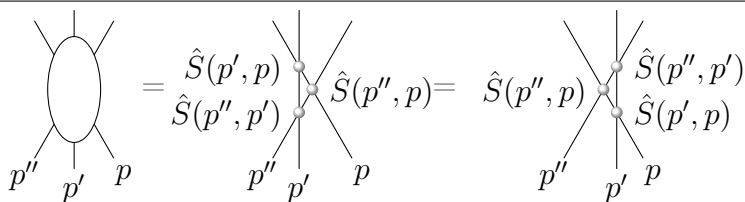

Figure I.1: Illustration of the Yang Baxter factorization formula (I.27): the three-points interaction (left) can be written in two different ways as a product of two-points interactions, and the result has to be the same. The same property holds for the interaction of arbitrarily many particles.

Investigating the symmetry properties of a model sometimes allows to put even more constraints and to completely solve it. For instance for the principal chiral model (which will be introduced in section III.1), the integrability can be motivated by finding an infinite set of conserved charges [Pol77], and the symmetries of the model (which is relativistic, has an $SU(N) \times SU(N)$ symmetry, and obeys “unitarity” and “crossing” constraints) allow to fix the \hat{S} -matrix uniquely [ZZ79] (it is also discussed in section III.1).

In the very specific field theories (such as the principal chiral model) where it holds, this ansatz only describes the wave function when the particles are separated by large distances (compared to the interaction range). It is therefore necessary that the size L of the spatial dimension is large enough (otherwise the particles cannot be separated by long distances).

In this manuscript, we will be interested in the finite size effects which occur when the size L is not large enough compared to the interaction range, and the ansatz above cannot be used. In this case we have to use a method called the “thermodynamic Bethe ansatz”. This method is explained in the chapter III, which is more specifically focussed on the principal chiral model.

We will see in this section that a trick (sometimes called “double Wick rotation” or “Matsubara transform”) allows to write equations for these finite size effects. For several models, this trick allows to express the finite size-effects from a set of non-linear integral equations, which is often infinite, and can be reduced³ to a functional relation taking the universal form of a “Y-system”. This system of equations is tightly related to the Hirota equation [KNS94] found for the spin chains.

An important result of this thesis is that the “Q-operators”, the fundamental objects introduced in section II for spin chains, have a direct analogue (the q -functions) for integrable field theories and this allows to solve several Y-systems. These results are presented in chapter III in the case of the principal chiral model, and the results of [10KL] are presented.

³More precisely, this (usually infinite) set of integral equation implies the functional relation called Y-system equation. On the other hand, the Y-system equation has to be supplemented with analyticity conditions in order to imply the original (usually infinite) set of integral equation.

I.3 AdS/CFT duality

The arguments suggested above allow to solve several two-dimensional gauge theories with one space dimension and one time dimension. Many such models are relativistic and have massive particles⁴.

On the other hand, the known particle physics (described by the standard model), is a four-dimensional relativistic gauge theory, which is asymptotically free. This means that the interactions which occur above an energy scale are well described by sums of “Feynman diagrams” which correspond to different possible interaction processes. For instance, the simplest way for two electrons to interact is by exchanging one photon. But they could as well exchange two photons, or more. Or an electron could emit a photon which transforms afterwards into an electron-positron pair which annihilates into photons that are finally absorbed by the other electron. All the processes which can happen are described by “Feynman diagrams”, and in general one should sum an infinite series of these processes. Asymptotic freedom (which occurs for instance in the standard model) means that above a given energy scale, the more complicated⁵ a diagram is, the less it contributes to the sum. This allows to show that, in order to compute the properties of an interaction to a given accuracy, it is sufficient to keep a finite number of terms.

We see that in general, for these gauge theories, what we can do is to write an infinite series (which is an asymptotic expansion), which is called a perturbative expansion. This captures important physical properties of the interactions, but it cannot be used below a given energy scale. As a consequence, there are some aspects of these gauge theories that are not captured by this approach. For instance, one of these non-perturbative aspects is the confinement of quarks inside hadrons (such as the neutrons and the protons), which explains that we cannot observe an isolated quark, but only some particles made of multiple quarks.

These questions arise for lots of different gauge theories and we will see that there exists at least one four-dimensional gauge theory, the so-called super Yang-Mills field theory with four supersymmetries ($\mathcal{N} = 4$ SYM) for which some exact computations can be done (as opposed to the perturbative expansion mentioned above). This theory is a conformal field theory (CFT), which means that it is invariant under several transformations including dilatations (see below).

Conformal invariance and dimension of operators Every field theory describes some fields which are functions of the positions (these functions are operator-valued for quantum field theories). Conformal field theories are invariant under the transformations of positions which preserves angles (i.e. these transformations locally look like compositions of translations, rotations, and dilatations).

When the space has dimension $D > 2$, all the conformal transformations take the

⁴The fact that the particles are massive introduces a mass scale m and a length scale $\frac{1}{m}$. We have seen that this length scale was important because integrability comes from the regime where $L \gg \frac{1}{m}$.

⁵More precisely, the statement is that the more loops a diagram has, the less it contributes.

form

$$x_\mu \mapsto x'_\mu = x_\mu + a_\mu + \Omega_{\mu,\nu} x_\nu \quad \text{where } a \in \mathbb{R}^D \quad \text{and } \omega \in O(D) \quad (\text{I.29a})$$

$$x_\mu \mapsto x'_\mu = \lambda x_\mu \quad \text{where } \lambda \in \mathbb{R} \quad (\text{I.29b})$$

$$\text{or } x_\mu \mapsto x'_\mu = \frac{\frac{x_\mu}{(x)^2} + \alpha_\mu}{\left(\frac{x_\rho}{(x)^2} + \alpha_\rho\right)^2} \quad \text{where } (x)^2 \equiv x_\nu x_\nu = \|x\|^2 \quad \text{and } \alpha \in \mathbb{R}^D \quad (\text{I.29c})$$

(or a composition of these three transformations) where we use Einstein's sum convention in an Euclidean metric (which means that the repeated indices are summed over, i.e. that $\Omega_{\mu,\nu} x_\nu$ denotes the sum $\sum_{\nu=1}^D \Omega_{\mu,\nu} x_\nu$).

These transformations locally conserve the ratios of distances (i.e. the angles), which means that conformal transformations are the transformations $x_\mu \mapsto x'_\mu$ such that there exists a positive function $\lambda(x)$ such that⁶

$$(dx')^2 = \lambda(x)^2 (dx)^2. \quad (\text{I.30})$$

In conformal fields theories, the coordinates can be transformed as in (I.29), and then some fields $\Phi_i(x)$ (called primary operators) transform as

$$\Phi_i(x) \mapsto \Phi'_i(x') \quad \text{where } \Phi'_i(x') \equiv \lambda(x)^{\Delta_i} \Phi_i(x) \quad (\text{I.31})$$

where Δ_i is called the conformal dimension of the field $\Phi_i(x)$, which indicates how $\Phi_i(x)$ is rescaled when the coordinates are rescaled.

An important information that we want to extract in a field theory is the correlation functions such as $\langle \Phi_1(x) \Phi_2(y) \rangle$, $\langle \Phi_1(x) \Phi_2(y) \Phi_3(z) \rangle$, etc. These correlations functions capture the properties of the quantum fluctuations, and they are strongly constrained by the above symmetry: in conformal field theories, they are invariant under the transformations (I.29,I.31).

It is then possible to show [Pol70] that the ‘‘two-points’’ and ‘‘three-points’’ correlation functions are given by

$$\langle \Phi_i(x) \Phi_j(y) \rangle = \frac{\delta_{\Delta_i, \Delta_j}}{\|x - y\|^{2\Delta_i}}, \quad (\text{I.32})$$

$$\langle \Phi_i(x) \Phi_j(y) \Phi_k(z) \rangle = \frac{C_{i,j,k}}{\|x - y\|^{\Delta_i + \Delta_j - \Delta_k} \|x - z\|^{\Delta_i - \Delta_j + \Delta_k} \|y - z\|^{-\Delta_i + \Delta_j + \Delta_k}}, \quad (\text{I.33})$$

where the expression (I.32) fixes the normalization of the fields⁷. The ‘‘conformal dimensions’’ Δ_i and the ‘‘structure constants’’ $C_{i,j,k}$ are important properties a theory, as they allow to compute the correlation functions (I.32) and (I.33).

In the present manuscript we will specifically focus on the conformal dimensions of the operators in $\mathcal{N} = 4$ super Yang-Mills. We will see that they can be obtained using integrable properties of this model.

⁶Here, $(dx')^2$ denotes the bilinear form which is formally constructed as $dx'_\mu dx'_\mu = \frac{\partial x'_\mu}{\partial x_\nu} dx_\nu \frac{\partial x'_\mu}{\partial x_\rho} dx_\rho$

⁷If each field Φ_k is multiplied by an arbitrary constant, then the relation (I.32) clearly has to be multiplied by a constant. The choice to have only $\delta_{\Delta_i, \Delta_j}$ in the numerator (without any extra constant) fixes this degree of freedom in the definition of the fields.

Integrability in the AdS/CFT duality Interestingly enough the integrable properties of the super Yang-Mills field theory are best understood and tested in the framework of the “AdS/CFT correspondence”. This conjectured duality [Mal98, GKP98, Wit98] says that several quantities (such as correlation functions) that we wish to compute on one side of the duality, for instance in super Yang-Mills, can be obtained by computing other quantities in the other side of the duality, for instance AdS. This “AdS” denotes a string theory (i.e. a quantum theory of gravity) on a 10-dimensional space-time having the geometry $AdS_5 \times S^5$, where AdS_5 denotes the 5-dimensional anti de Sitter space, a curved manifold which is roughly speaking a multi-dimensional hyperboloid.

Given a quantity that we want to compute (for instance) in super Yang-Mills, it is not easy to understand what computation in the AdS string theory is associated to this quantity. Nevertheless, this duality is very interesting because it turns out to relate the perturbative domain of one model to the non-perturbative domain of the other model. It means that for instance, classical string theory is related to deeply non-perturbative gauge theory.

We will not enter deeply into the details of this duality, but we will simply work with one of the predictions of this duality: the fact that the energy spectrum of the superstrings is equal to the spectrum of the conformal dimensions of the super Yang-Mills operators.

On the super Yang-Mills side, integrability was first noticed in [Lip94], and in the planar limit (a limit when the rank of the gauge group is large), a mapping was noticed [FK95, MZ03] between the study of the spectrum of the conformal dimensions in super Yang-Mills and an $SL(2)$ spin chain (see for instance [Min12]⁸). More precisely, it was shown that in this planar limit the only relevant operators are linear combinations of operators of the form $\text{tr}(\mathcal{O}_1, \mathcal{O}_2, \dots, \mathcal{O}_L)$ where $\mathcal{O}_1, \mathcal{O}_2, \dots, \mathcal{O}_L$ are arbitrary fields. In general, the operator $\Phi_{n_1, \dots, n_L} \equiv \text{tr}(\mathcal{O}_{n_1}, \dots, \mathcal{O}_{n_L})$ is not a primary operator, which transforms as in (I.31). Instead it is a linear combination of primary operators, and the operators of this form transform as $\Phi'_A(x') = Z_A^B \Phi_B(x)$ where the “mixing matrix” Z_A^B has eigenvalues $\lambda(x)^{\Delta_i}$ where Δ_i denotes the dimensions of primary operators. In particular there is a sector called $SU(2)$ sector, where only two elementary operators can appear (i.e. each \mathcal{O}_i is either equal to X or Y). Then the operator $\text{tr}(XXYY)$ can be mapped to the state $|\uparrow\uparrow\downarrow\downarrow\rangle$ of an $SU(2)$ spin chain of size $L = 4$. Then it was shown that for “long operators”, i.e. for composite operators made of the trace of the product of many elementary operators, this mapping transforms the mixing matrix into an integrable spin chain Hamiltonian, and some Bethe equations arise that allow to find the spectrum of super Yang-Mills’ long operators.

The equations obtained for these “long operators” can then be continued to short operators. This gives a Y-system which was conjectured in [GKV09a] and then understood in terms of the thermodynamic Bethe ansatz approach [BFT09, GKKV10, AF09]. This Y-system was successfully tested in the weak coupling regime, by comparison with perturbative expansion in super Yang-Mills [JL07, HJL08, BJ09, FSSZ08, Vel09, MOSS11, AFS10, BH10], but also in the strong coupling regime [Gro10].

⁸The review [Min12] is part of the collection [BAA⁺12] of reviews, which provide an excellent introduction to the subject.

In this manuscript, we will take these equations as the starting point for the chapter IV, and derive a simpler set of equations [11GKLV]. This work, performed during this PhD, is similar in spirit to the analysis of the principal chiral model in the chapter III, but we will see that the analyticity conditions are much richer. In particular we will find a new symmetry of the Y-system (which we call “quantum- \mathbb{Z}_4 symmetry”, and which we interpret from the string theory on $AdS_5 \times S^5$), and show how to recast the infinite set of equations arising from the thermodynamic Bethe ansatz into a finite set of equations, where the analyticity of several functions is much better understood than in previous analyses.

Chapter II

Q operators for spin chains

In this chapter we will prove the integrability of a class of spin chains which generalize the Heisenberg spin chain studied in chapter I.1.

To do this, we will first construct a family of commuting operators (and which also commute with the Hamiltonian H), called the T-operators [BR90]. We will then show, following the paper [KV08], that these T-operators obey some fusion relations governed by the “Cherednik-Bazhanov-Reshetikhin” determinant formula (II.80) [Che86, BR90], which can also be recast into the bilinear form of the Hirota equation [KP92, KN92, KLWZ97, Tsu97]. The proof of this relies on combinatorial identities introduced in the appendix B.1, and it will conclude the section II.1. In the next sections, we will show how to diagonalize the T-operators and the Hamiltonian, by writing a “Bäcklund flow”. More precisely we will start by motivating the introduction of the Bäcklund flow in section II.2, where we will show (as in [KLWZ97, Zab96, KSZ08, Zab08]) that if this flow exists and is polynomial, then some strong constraints arise that allow to diagonalize the T-operators. Finally new results of this PhD will be presented in the section II.3, where this Bäcklund flow is constructed explicitly at the operatorial level, and an original construction of the so-called “Q-operators” is presented for the $GL(K|M)$ spin chain.

Starting from the introduction of “Q-operators” in [Bax72] for the eight-vertex lattice model, some Q-operators have been constructed for a large variety of integrable systems¹ The construction given in this thesis for the $GL(K|M)$ spin chain is quite different from these constructions, and allows to define Q-operators directly as operators and to show their polynomiality. In particular, this gives Wronskian determinant expressions for the T-operators in terms of Q-operators. These Wronskian expressions are given in section II.3.2.3, and can also be found in the literature [BLZ97a, KLWZ97, BT08, 11GKLT, Tsu10]. These Wronskian expressions are known solutions of the Hirota equation, and we will prove that these expression apply to the T-operators of these spin chains².

Interestingly, this construction turns out to have very deep connections [11AKL⁺] with the “classical integrability”, as explained in the section II.4.

II.1 Spin chains and T-operators

Spin chains are particularly simple examples of integrable systems. In this section, we will see how to construct the family of conserved charges which will allow to diagonalize the Hamiltonian. We will also see that these charges can be expressed through the action of a “co-derivative”, and we will see that it allows to prove the “Cherednik-Bazhanov-Reshetikhin” determinant formula (II.80).

¹For instance, constructions of Q-operators for different models are given in [Bax72, BLZ97a, BLZ99, Hik01, BHK02a, FM03, KMS03, KZ05, Kor05, BT06, BJM⁺07, BDKM07, Koj08, BT08, DM09, BGK⁺10, BŁMS10, BFL⁺11, Sta12, FLMS11b, FLMS11a, Tsu12].

²One can easily see that there also exists solutions of the Hirota equation which cannot be written as a Wronskian determinant. This will be discussed in chapter III, where a sufficient condition (called typicality) is given, under which one can write such Wronskian determinants.

II.1.1 Construction of the T-operators

II.1.1.1 Heisenberg spin chain

The ‘‘Heisenberg $XXX_{1/2}$ spin chain’’ is the simplest spin chain, and corresponds to a quantum version of the Ising model. As we already saw in the introductory section I.1, its Hilbert space is $\mathcal{H} = \bigotimes_{i=1}^L \mathcal{H}_i = (\mathbb{C}^2)^{\otimes L}$. In this spin chain, the interactions are only between nearest neighbors, and are governed by the Hamiltonian (I.1), or by the (more physical) expression below (we will show that the two expressions coincide)

$$\boxed{H = \sum_i H_{i,i+1} = - \sum_i \vec{\sigma}_i \cdot \vec{\sigma}_{i+1}} \quad (\text{II.1})$$

$$\text{where } \vec{\sigma}_i \cdot \vec{\sigma}_j \equiv \sum_{l=1}^3 \sigma_i^{(l)} \cdot \sigma_j^{(l)}, \quad \sigma_i^{(l)} = \mathbb{I}^{\otimes i-1} \otimes \sigma^{(l)} \otimes \mathbb{I}^{\otimes L-i}. \quad (\text{II.2})$$

In the expression, $\sigma^{(1)}$, $\sigma^{(2)}$ and $\sigma^{(3)}$ denote Pauli matrices

$$\sigma^{(1)} = \begin{pmatrix} 0 & 1 \\ 1 & 0 \end{pmatrix} \quad \sigma^{(2)} = \begin{pmatrix} 0 & -\mathfrak{i} \\ \mathfrak{i} & 0 \end{pmatrix} \quad \sigma^{(3)} = \begin{pmatrix} 1 & 0 \\ 0 & -1 \end{pmatrix}, \quad (\text{II.3})$$

and \mathbb{I} denotes the unity matrix. The symbol \mathfrak{i} denotes the imaginary number with imaginary part equal to one.

The minus sign in front of $\sum_i \vec{\sigma}_i \cdot \vec{\sigma}_{i+1}$ in the definition of the Hamiltonian means that the spin chain is ferromagnetic. With this choice, the state $|\{ \} \rangle$ introduced in (I.5) is a state of lowest energy. To define the Hamiltonian (II.1) completely, a boundary condition has to be specified. For instance, if the chain is ‘‘open’’, the sum (II.1) runs over $i \in \llbracket 1, L-1 \rrbracket$. On the contrary, if the chain is periodic, the sum runs over $i \in \llbracket 1, L \rrbracket$, and the identification $\sigma_{L+1}^{(l)} = \sigma_1^{(l)}$ is used.

As we already saw in the introductory section, the proof that this spin chain is ‘‘integrable’’ is obtained by rewriting the Hamiltonian (and $\vec{\sigma}_i \cdot \vec{\sigma}_j$) in terms of the permutation operator $\mathcal{P}_{i,j}$ defined by (I.2). For instance if $L = 2$, $\mathcal{P}_{1,2}$ is the operator defined by

$$\mathcal{P}_{1,2} (|\phi\rangle \otimes |\psi\rangle) = |\psi\rangle \otimes |\phi\rangle, \quad (\text{II.4})$$

$$\text{i.e. } \mathcal{P}_{1,2} = \sum_{\alpha, \beta \in \{\uparrow, \downarrow\}} e_{\alpha, \beta} \otimes e_{\beta, \alpha} \quad \text{where } e_{\alpha, \beta} = |\alpha\rangle \langle \beta| \quad (\text{II.5})$$

One can write for instance

$$\sigma^{(1)} \otimes \sigma^{(1)} + \sigma^{(2)} \otimes \sigma^{(2)} = (e_{\downarrow, \uparrow} + e_{\uparrow, \downarrow}) \otimes (e_{\downarrow, \uparrow} + e_{\uparrow, \downarrow}) \quad (\text{II.6})$$

$$\begin{aligned} &+ (\mathfrak{i} e_{\downarrow, \uparrow} - \mathfrak{i} e_{\uparrow, \downarrow}) \otimes (\mathfrak{i} e_{\downarrow, \uparrow} - \mathfrak{i} e_{\uparrow, \downarrow}) \\ &= 2 (e_{\downarrow, \uparrow} \otimes e_{\uparrow, \downarrow} + e_{\uparrow, \downarrow} \otimes e_{\downarrow, \uparrow}) \end{aligned} \quad (\text{II.7})$$

$$\text{and } \sigma^{(3)} \otimes \sigma^{(3)} = 2 (e_{\uparrow, \uparrow} \otimes e_{\uparrow, \uparrow} + e_{\downarrow, \downarrow} \otimes e_{\downarrow, \downarrow}) - \mathbb{I}, \quad (\text{II.8})$$

whence we can deduce

$$\vec{\sigma}_1 \cdot \vec{\sigma}_2 = 2 \mathcal{P}_{1,2} - \mathbb{I}. \quad (\text{II.9})$$

The same result holds if $L > 2$, and then it reads

$$\mathcal{P}_{i,j} = \frac{1}{2} (\vec{\sigma}_i \cdot \vec{\sigma}_j + \mathbb{I}), \quad (\text{II.10})$$

which allows to rewrite the Hamiltonian as

$$\mathbb{H} = - \sum_i (2\mathcal{P}_{i,i+1} - \mathbb{I}) = L - 2 \sum_i \mathcal{P}_{i,i+1}. \quad (\text{II.11})$$

In (II.11), L implicitly denotes the operator $L \mathbb{I}$.

We will see in the next section that this property allows to define a family of operators commuting with the Hamiltonian (II.1). Before we construct these operators, let us notice that the Heisenberg spin chain can be generalized to spins in a superposition of K states. In that case the Hilbert space is $\mathcal{H} = \bigotimes_{i=1}^L \mathcal{H}_i = (\mathbb{C}^K)^{\otimes L}$, whereas the Hamiltonian is

$$\boxed{\mathbb{H} = - \sum_i \vec{\lambda}_i \cdot \vec{\lambda}_{i+1} = - \sum_i \left(2 \mathcal{P}_{i,i+1} - \frac{2}{K} \mathbb{I} \right)}, \quad (\text{II.12})$$

where $\vec{\lambda} = (\lambda^{(1)}, \lambda^{(2)}, \dots, \lambda^{(K^2-1)})$ denotes the Gell-Mann matrices, which generalize the Pauli matrices: $\frac{K^2-K}{2}$ of them are of the form $e_{\alpha,\beta} + e_{\beta,\alpha}$ or $i e_{\alpha,\beta} - i e_{\beta,\alpha}$, (where $e_{\alpha,\beta} = |\alpha\rangle \langle \beta|$), while the other $K-1$ Gell-Mann matrices are zero-trace diagonal matrices. The form of these matrices is then such that the computation (II.6-II.8) holds for Gell-Mann matrices as well. That implies

$$\frac{2}{K} \mathbb{I} + \sum_{l=1}^{K^2-1} \frac{\lambda_i^{(l)} \cdot \lambda_j^{(l)}}{2} = 2\mathcal{P}_{i,j}, \quad (\text{II.13})$$

which generalizes (II.9) to the $K \neq 2$ case, and explains the second equality in (II.12).

II.1.1.2 Yang-Baxter equation and the construction of conserved charges

Rewriting the Hamiltonian (II.1) in terms of permutation operators will be useful due to the simple algebra satisfied by these permutation operators: for instance, the relation $\mathcal{P}_{i,j} \mathcal{P}_{j,k} = \mathcal{P}_{j,k} \mathcal{P}_{i,k}$ allows to check the following equality

$$\boxed{R_{i,j}(\mathbf{u} - \mathbf{v}) R_{i,k}(\mathbf{u}) R_{j,k}(\mathbf{v}) = R_{j,k}(\mathbf{v}) R_{i,k}(\mathbf{u}) R_{i,j}(\mathbf{u} - \mathbf{v})} \quad (\text{II.14})$$

$$\text{where } R_{m,n}(\mathbf{u}) = \mathbf{u} + \mathcal{P}_{m,n}. \quad (\text{II.15})$$

The equality (II.14) will be crucial in what follows, and it is called the ‘‘Yang-Baxter’’ identity. More precisely, we will say that the R -matrix defined by (II.15) does satisfy the ‘‘Yang-Baxter’’ identity (II.14).

Now, we will see how this identity allows to define a family of operators which commute with each other and with the Hamiltonian. To this end, we need to introduce a larger Hilbert space $\mathcal{H} \otimes \mathcal{H}_{a_1} \otimes \mathcal{H}_{a_2} \otimes \cdots \otimes \mathcal{H}_{a_n}$, where each $\mathcal{H}_{a_k} = \mathbb{C}^K$ is an ‘‘auxiliary’’ space. Here, the symbol \mathcal{H} denotes the original Hilbert space, $\mathcal{H} = \bigotimes_{i=1}^L \mathcal{H}_i = (\mathbb{C}^K)^{\otimes L}$, whereas the smaller symbol \mathcal{H} denotes the smaller spaces (isomorphic to \mathbb{C}^K) which appear in the tensor products. Each K -dimensional space $\mathcal{H}_i = \mathbb{C}^K$ corresponds to one spin in a superposition of K states.

We will then show by recurrence that

$$R_{a_1, a_2}(\mathbf{u} - \mathbf{v})L^{(1)}(\mathbf{u})L^{(2)}(\mathbf{v}) = L^{(2)}(\mathbf{v})L^{(1)}(\mathbf{u})R_{a_1, a_2}(\mathbf{u} - \mathbf{v}) \quad (\text{II.16})$$

$$\text{where } L^{(k)}(\mathbf{u}) = R_{L, a_k}(\mathbf{u})R_{L-1, a_k}(\mathbf{u}) \cdots R_{1, a_k}(\mathbf{u}). \quad (\text{II.17})$$

In the definition (II.17), the ‘‘monodromy matrix’’ $L^{(k)}(\mathbf{u})$ is an operator acting on $\mathcal{H} \otimes \mathcal{H}_{a_k}$. By contrast the operators in (II.16) are acting on $\mathcal{H} \otimes \mathcal{H}_{a_1} \otimes \mathcal{H}_{a_2}$, and in this equation it is implicit that for instance $L^{(1)}(\mathbf{u})$ rigorously denotes the operator $L^{(1)}(\mathbf{u}) \otimes \mathbb{I}$.

Proof of the relation (II.16). The proof relies on the following recurrence relation:

$$R_{a_1, a_2}(\mathbf{u} - \mathbf{v})L^{(1)}(\mathbf{u})L^{(2)}(\mathbf{v}) = L_{L, i+1}^{(2)}(\mathbf{v})L_{L, i+1}^{(1)}(\mathbf{u})R_{a_1, a_2}(\mathbf{u} - \mathbf{v})L_{i, 1}^{(1)}(\mathbf{u})L_{i, 1}^{(2)}(\mathbf{v}), \quad (\text{II.18})$$

$$\text{where } L_{i, j}^{(k)}(\mathbf{u}) = R_{i, a_k}(\mathbf{u})R_{i-1, a_k}(\mathbf{u}) \cdots R_{j, a_k}(\mathbf{u}), \quad (\text{II.19})$$

where we see that $L^{(k)}(\mathbf{u}) = L_{L, 1}^{(k)}(\mathbf{u})$. The initialization of the recurrence for $i = L$ is trivial, whereas the case $i = 0$ is the statement (II.16) that we want to prove. As explained graphically in the figure II.1, going from i to $i - 1$ in (II.18) is done by using the Yang-Baxter relation (II.14), together with the commutation relation

$$\langle\langle R_{i, a_1}(\mathbf{u}), R_{j, a_2}(\mathbf{v}) \rangle\rangle_- = 0 \quad \text{if } i \neq j \quad (\text{II.20})$$

$$\text{where } \langle\langle A, B \rangle\rangle_{\pm} \equiv A \cdot B \pm B \cdot A. \quad (\text{II.21})$$

Indeed, the R -operators have the form $\mathbb{I} \otimes R \otimes \mathbb{I}$, and the commutation relation (II.20) is nothing but the statement that

$$\langle\langle A \otimes \mathbb{I}, \mathbb{I} \otimes B \rangle\rangle_- = 0. \quad (\text{II.22})$$

It can be interesting to write diagrammatically the structure of this iterative proof, which is done in figure II.1. In this figure, the vertical lines stand for the Hilbert spaces $\mathcal{H}_1, \mathcal{H}_2, \dots$, whereas the horizontal lines stand for the auxiliary spaces \mathcal{H}_{a_1} et \mathcal{H}_{a_2} . The dots (colored in the online version) stand for the R -operators and the order of multiplications is given by the arrows. These arrows allow an ambiguity in the order of operators, which is fully consistent with (II.20), and crucial for the proof. Graphically, we see that the iterative structure of the proof simply consists in moving vertical lines from the right side of the blue dot to its left side, and the relation (II.14) exactly allows to move lines this way across each other. \square

$$R_{a_1, a_2}(\mathbf{u} - \mathbf{v})L^{(1)}(\mathbf{u})L^{(2)}(\mathbf{v}) =$$

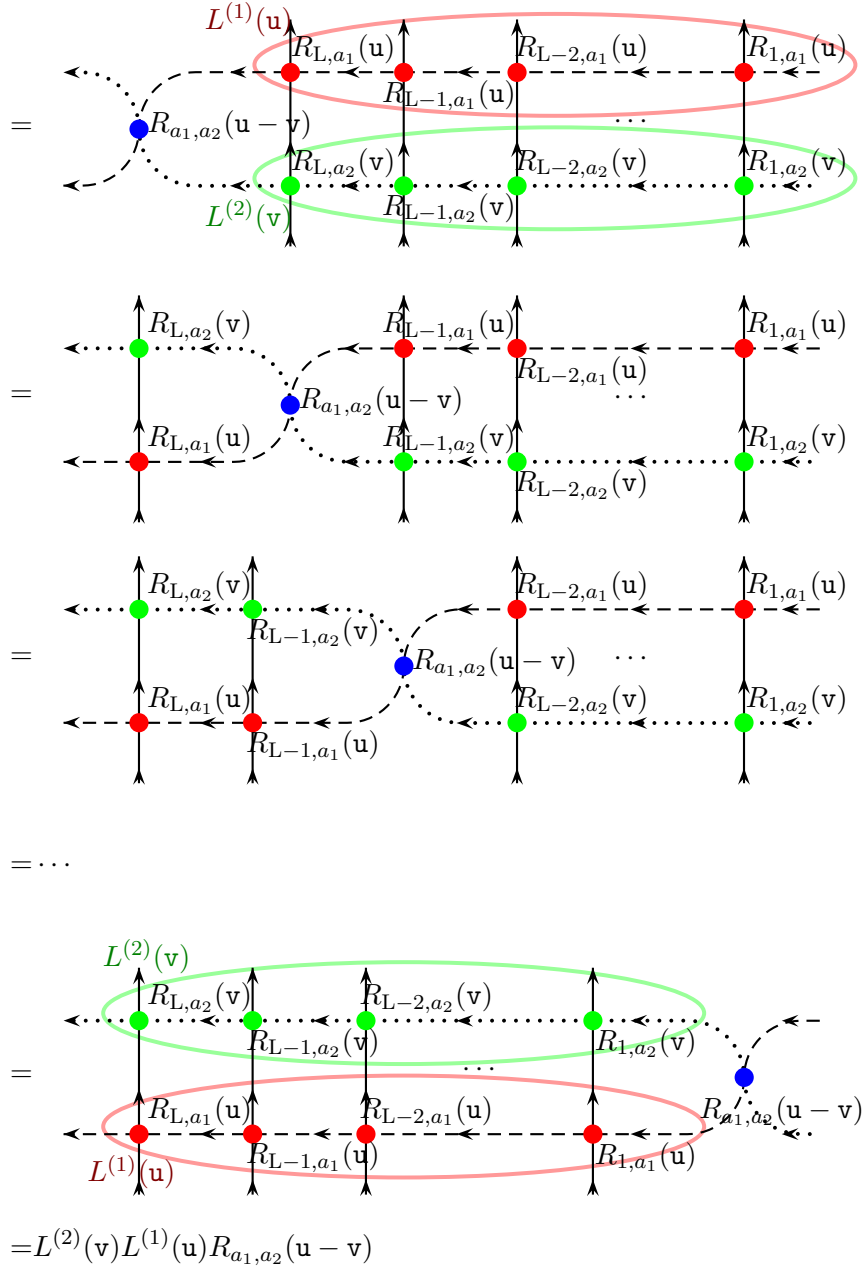

Figure II.1: Illustration of the proof of (II.16)

This equation (II.16) turns out to be very important, as it allows to define a family of operators, (denoted by $T(\mathbf{u})$), which commute with each other:

$$\boxed{\langle T(\mathbf{u}), T(\mathbf{v}) \rangle_- = 0} \quad \text{where} \quad \boxed{T(\mathbf{u}) \equiv \text{tr}_{a_i} L^{(i)}(\mathbf{u})}. \quad (\text{II.23})$$

These T-operators (also called “transfer matrices”) are labeled by different values of the scalar parameter \mathbf{u} , which will be called the “spectral parameter”. One should note that in (II.23), each $T(\mathbf{u})$ is defined by introducing an auxiliary space, and taking a partial trace defined by (A.10) in appendix A.1. After this trace, we get an operator acting on the initial Hilbert space \mathcal{H} . The two operators $T(\mathbf{u})$ and $T(\mathbf{v})$ are defined by introducing two different auxiliary spaces (denoted by a_1 and a_2 in (II.16)).

Proof of (II.23). This relation is obtained from (II.16), which implies that if $R_{a_1, a_2}(\mathbf{u} - \mathbf{v})$ is invertible, i.e. if $\mathbf{u} - \mathbf{v} \neq \pm 1$, then $T(\mathbf{u}) \cdot T(\mathbf{v}) = \text{tr}_{a_1 \otimes a_2} L^{(1)}(\mathbf{u}) L^{(2)}(\mathbf{v}) = \text{tr}_{a_1 \otimes a_2} L^{(2)}(\mathbf{v}) L^{(1)}(\mathbf{u}) = T(\mathbf{v}) \cdot T(\mathbf{u})$.

As $T(\mathbf{u})$ is a polynomial in the variable \mathbf{u} , (II.23) also holds for arbitrary \mathbf{u} and \mathbf{v} (by continuation). \square

At this point, we have defined a family of commuting operators $T(\mathbf{u})$, labeled by an arbitrary $\mathbf{u} \in \mathbb{C}$. For periodic spin chains, we will now see that they are conserved charges, i.e. that the Hamiltonian commutes with them. As shown in figure II.2, the Hamiltonian can be written as

$$H = - \sum_i \left(2\mathcal{P}_{i, i+1} - \frac{2}{K} \mathbb{I} \right) = \frac{2}{K} L - 2 \left. \frac{\partial_{\mathbf{u}} T(\mathbf{u})}{T(\mathbf{u})} \right|_{\mathbf{u}=0} \quad (\text{II.24})$$

$$\boxed{H = \frac{2}{K} L - 2 \partial_{\mathbf{u}} \log T(\mathbf{u})|_{\mathbf{u}=0}}, \quad (\text{II.25})$$

which immediately implies the commutation

$$\langle H, T(\mathbf{u}) \rangle_- = 0. \quad (\text{II.26})$$

Let us note that in (II.25), the expression $\frac{\partial_{\mathbf{u}} T(\mathbf{u})}{T(\mathbf{u})}$ makes sense due to the commutation relation (II.23). Let us also remark that the identity operator \mathbb{I} was omitted, like in (II.11). This omission of implicit identity operators will be frequent in this manuscript.

We have now shown that for a periodic Heisenberg spin chain, with Hamiltonian (II.1) (or more generally (II.12)), there exists a family of commuting charges called T-operators. We also showed how the Hamiltonian can be expressed from T-operators. This construction can also be found in [Nep99] or in [Fad96], where the method of “algebraic Bethe ansatz” is reviewed. This method allows to derive the Bethe equations (I.24) and to diagonalize the T-operators, to recover the spectrum (I.21). In this manuscript, we will diagonalize T-operators through a different path, relying on a “Bäcklund flow”, introduced in the next sections.

But in order to proceed with this flow, we actually need to define the T-operators in a more general context (as in [KV08]) : we will deform the periodicity condition (by introducing a twist $g \in GL(K)$), add “inhomogeneities”, and choose more general auxiliary spaces than \mathbb{C}^K .

$$\partial_{\mathbf{u}} T(\mathbf{u})|_{\mathbf{u}=0} = \sum_i \text{tr}_{a_1} (\mathcal{P}_{L,a_1} \mathcal{P}_{L-1,a_1} \cdots \mathcal{P}_{i+1,a_1} \mathcal{P}_{i-1,a_1} \cdots \mathcal{P}_{1,a_1})$$

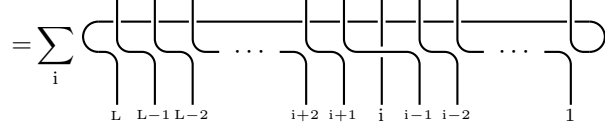

$$\left(T(0) \right)^{-1} = \left(\begin{array}{c} \text{Diagram with vertical lines } L, L-1, L-2, \dots, 4, 3, 2, 1 \end{array} \right)^{-1}$$

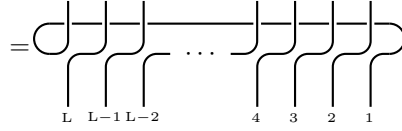

$$\frac{\partial_{\mathbf{u}} T(\mathbf{u})}{T(\mathbf{u})} \Big|_{\mathbf{u}=0} = \left(T(0) \right)^{-1} \cdot \partial_{\mathbf{u}} T(\mathbf{u})|_{\mathbf{u}=0}$$

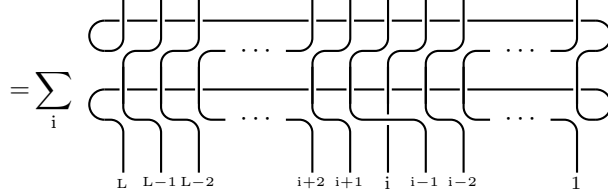

$$= \sum_i \mathcal{P}_{i,i+1}$$

Figure II.2: Proof of (II.25)

Products of permutations are symbolized by a set of lines. If a line ends at position k in the bottom of a diagram and at position l in the top of the diagram, then this line stands for a factor $\delta_{j_k}^{i_l}$ in the expression of the coordinates $\mathcal{O}_{j_1, j_2, \dots, j_L}^{i_1, i_2, \dots, i_L}$ of the operator \mathcal{O} corresponding to this diagram. Vertical lines are associated to the Hilbert spaces $\mathcal{H}_L, \mathcal{H}_{L-1}, \dots, \mathcal{H}_1$, while the auxiliary space is horizontal. With these diagrammatic rules, one immediately notices that for instance $T(0)^{-1} = \mathcal{P}_{\sigma_c}$, where σ_c is the cyclic permutation such that $\forall i > 1, \sigma_c(i) = i - 1$, and where \mathcal{P}_{σ} is defined by (A.6) (which generalizes (I.2) to an arbitrary permutation) in appendix A.1. We finally get $\frac{\partial_{\mathbf{u}} T(\mathbf{u})}{T(\mathbf{u})} \Big|_{\mathbf{u}=0} = \sum_i \mathcal{P}_{i,i+1}$, which gives (II.25).

II.1.1.3 Inhomogeneous twisted spin chain

Let us now define T-operators generalizing the operators we constructed for the Heisenberg spin chain. We will do this by finding more general definitions of R -operators such that the Yang-Baxter (II.14) still holds. This way, all the results above will immediately apply and define a family of commuting T-operators.

Introduction of a twist and of inhomogeneities The first generalization consists in a modification of the periodicity condition, and involves a “twist” $g \in GL(\mathbb{K})$. In this case, the definition (II.17) is replaced with

$$\mathcal{L}_g^{(k)}(\mathbf{u}) = L^{(k)}(\mathbf{u}) \cdot g_{a_k} = R_{L,a_k}(\mathbf{u}) R_{L-1,a_k}(\mathbf{u}) \cdots R_{1,a_k}(\mathbf{u}) \cdot g_{a_k}, \quad (\text{II.27})$$

where g_{a_k} denotes the operator $\mathbb{I} \otimes g$, which acts on $\mathcal{H} \otimes \mathcal{H}_{a_k}$. Noticing that g_{a_k} commutes with $L^{(l)}(\mathbf{u})$, as soon as $k \neq l$, we get

$$R_{a_1,a_2}(\mathbf{u} - \mathbf{v}) \mathcal{L}_g^{(1)}(\mathbf{u}) \mathcal{L}_g^{(2)}(\mathbf{v}) = R_{a_1,a_2}(\mathbf{u} - \mathbf{v}) L^{(1)}(\mathbf{u}) L^{(2)}(\mathbf{v}) \cdot g_{a_1} \cdot g_{a_2} \quad (\text{II.28})$$

$$= L^{(2)}(\mathbf{v}) L^{(1)}(\mathbf{u}) R_{a_1,a_2}(\mathbf{u} - \mathbf{v}) \cdot g_{a_1} \cdot g_{a_2} \quad (\text{II.29})$$

$$= L^{(2)}(\mathbf{v}) L^{(1)}(\mathbf{u}) \cdot g_{a_1} \cdot g_{a_2} \cdot R_{a_1,a_2}(\mathbf{u} - \mathbf{v}) \quad (\text{II.30})$$

$$= \mathcal{L}_g^{(2)}(\mathbf{v}) \mathcal{L}_g^{(1)}(\mathbf{u}) R_{a_1,a_2}(\mathbf{u} - \mathbf{v}) \quad (\text{II.31})$$

which means that introducing this twist does not break the relation (II.16). The line (II.29) is obtained from (II.28) by simply writing the equation (II.16), whereas (II.30) is obtained by using the commutation between $g_{a_1} \cdot g_{a_2}$ and \mathcal{P}_{a_1,a_2} . As before, (II.31) implies that the T-operators commute with each other:

$$\boxed{(\mathbb{T}(\mathbf{u}), \mathbb{T}(\mathbf{v}))_- = 0} \quad \text{where} \quad \boxed{\mathbb{T}(\mathbf{u}) = \text{tr}_{a_i} \mathcal{L}_g^{(i)}(\mathbf{v})}. \quad (\text{II.32})$$

The “twist” in the boundary condition gives a different Hamiltonian, expressed from $\partial_{\mathbf{u}} \log \mathbb{T}(\mathbf{u})|_{\mathbf{u}=0}$. This Hamiltonian is equal to

$$\mathbb{H} = \frac{2}{\mathbb{K}} L - 2 \partial_{\mathbf{u}} \log \mathbb{T}(\mathbf{u})|_{\mathbf{u}=0} \quad (\text{II.33})$$

$$= \frac{2}{\mathbb{K}} L - 2 \left(\sum_{i=1}^{L-1} \mathcal{P}_{i,i+1} \right) - 2 \mathcal{P}_{1,L} \cdot g_L^{-1} \cdot g_1. \quad (\text{II.34})$$

The last term, which contains $\mathcal{P}_{1,L}$, acts only on the first and the last spins and is associated to the periodicity condition. Only this term is changed with respect to (II.25).

Proof of (II.34). This relation is checked by exactly the same argument as (II.25). Using

the notations of figure II.2, the result is obtained by writing

$$\left. \frac{\partial_{\mathbf{u}} T(\mathbf{u})}{T(\mathbf{u})} \right|_{\mathbf{u}=0} = \left(T(0) \right)^{-1} \cdot \partial_{\mathbf{u}} T(\mathbf{u})|_{\mathbf{u}=0} \quad (\text{II.35})$$

$$= \sum_{i=1}^{L-1} \left(\begin{array}{c} \text{Diagram 1} \\ \text{Diagram 2} \end{array} \right) + \left(\begin{array}{c} \text{Diagram 3} \\ \text{Diagram 4} \end{array} \right) \quad (\text{II.36})$$

The diagrams in (II.36) are R-matrices. The first diagram shows a sum over $i=1$ to $L-1$. Each term consists of two horizontal strands. The top strand has a loop labeled g^{-1} at the right end. The bottom strand has a loop labeled g at the right end. The strands are connected by vertical lines at positions $L, L-1, L-2, \dots, i+2, i+1, i, i-1, i-2, \dots, 1$. The second diagram is similar but with vertical lines at positions $L, L-1, L-2, \dots, 3, 2, 1$.

$$= \sum_{i=1}^{L-1} \mathcal{P}_{i,i+1} + \mathcal{P}_{1,L} \cdot g_L \cdot g_1^{-1}. \quad (\text{II.37})$$

□

A second convenient generalization is obtained by introducing inhomogeneities θ_i . The definition (II.27) is then replaced with

$$\mathcal{L}_g^{(k)}(\mathbf{u}) = R_{L,a_k}(\mathbf{u} - \theta_L) R_{L-1,a_k}(\mathbf{u} - \theta_{L-1}) \cdots R_{1,a_k}(\mathbf{u} - \theta_1) \cdot g_{a_k}, \quad (\text{II.38})$$

and it still gives (by the same arguments as before)

$$\boxed{\langle T(\mathbf{u}), T(\mathbf{v}) \rangle_- = 0} \quad \text{where} \quad \boxed{T(\mathbf{u}) = \text{tr}_{a_i} \mathcal{L}_g^{(i)}(\mathbf{u})}. \quad (\text{II.39})$$

In this commutation relation (II.39), the two T-operators must be defined with the same torsion g , and the same inhomogeneities θ_i , but with two different (but isomorphic) auxiliary spaces.

General auxiliary space Finally, one can also define other T-operators by changing the auxiliary space. This will give rise to other T-operators, which commute with the T-operators defined in (II.39), and are therefore conserved charges. In (II.16), the ‘‘auxiliary’’ spaces $\mathcal{H}_{a_k} = \mathbb{C}^K$ are isomorphic to the ‘‘physical’’ spaces $\mathcal{H}_i = \mathbb{C}^K$ (corresponding to spins in a superposition of K different states $|1\rangle, |2\rangle, \dots, |K\rangle$). By contrast, we will now choose the auxiliary spaces to be in a different representation of $GL(K)$, which means that \mathcal{H}_{a_k} is a given vector space, and that there exists a morphism $\pi : GL(K) \rightarrow GL(\mathcal{H}_{a_k})$ such that

$$\forall g, g' \in GL(K), \pi(g \cdot g') = \pi(g)\pi(g'). \quad (\text{II.40})$$

We will actually choose a representation characterized by an arbitrary Young diagram λ (see appendix A for an introduction to representations and Young diagrams), and the morphism of equation (II.40) will be denoted as $\pi_\lambda(g)$.

Since the “physical” spaces \mathcal{H}_i are in general not isomorphic to the “auxiliary” ones, the definition (I.2) of the permutation operator \mathcal{P} does not make sense any more. In order to define a new set of T-operators associated to various representations, let us first define a generalization of the permutation operator and of the R -matrix:

$$R_{i,\lambda}(\mathbf{u}) = \mathbf{u} + \mathcal{P}_{i,\lambda}, \quad (\text{II.41})$$

$$\text{where } \boxed{\mathcal{P}_{i,\lambda} = \sum_{1 \leq k, l \leq K} e_{k,l} \otimes \boldsymbol{\pi}_\lambda(e_{l,k})}. \quad (\text{II.42})$$

In (II.42), $e_{k,l}$ is a generator of $\text{GL}(K)$ and it acts on the space \mathcal{H}_i . It can be defined as $e_{k,l} = |(k)\rangle \langle (l)|$ (in the basis of appendix A.1), or as a matrix with coefficients $(e_{k,l})^i_j = \delta_{k,i} \delta_{l,j}$ which are all equal to zero except at position (k, l) . By contrast, $\boldsymbol{\pi}_\lambda(e_{l,k})$ denotes the corresponding generator in the representation λ , and it acts on the auxiliary space. This generator, defined by

$$\boldsymbol{\pi}_\lambda(\exp e_{k,l}) = \exp \boldsymbol{\pi}_\lambda(e_{\alpha,\beta}) \quad (\text{II.43})$$

is introduced in more details in the appendix A.3.3.

For the fundamental³ representation $\mathcal{H}_{a_k} = \mathbb{C}^K$ (denoted by $\lambda = \square$) we recover the definition (I.2) of the permutation operator. Indeed, we have

$$\sum_{1 \leq k, l \leq K} e_{k,l} \otimes e_{l,k} |(n, m)\rangle = e_{m,n} \otimes e_{n,m} |(n, m)\rangle = |(m, n)\rangle, \quad (\text{II.44})$$

$$\text{where } |(m, n)\rangle \equiv |(m)\rangle \otimes |(n)\rangle. \quad (\text{II.45})$$

As we will show below, the R -matrix defined by (II.41) satisfies a Yang-Baxter equation generalizing (II.14):

$$\boxed{R_{i,\lambda}(\mathbf{u} - \mathbf{v}) R_{j,\lambda}(\mathbf{u}) R_{i,j}(\mathbf{v}) - R_{i,j}(\mathbf{v}) R_{j,\lambda}(\mathbf{u}) R_{i,\lambda}(\mathbf{u} - \mathbf{v}) = 0}. \quad (\text{II.46})$$

Proof. For “standard” permutation operators, we proved the equation (II.14) using the relation $\mathcal{P}_{i,j} \mathcal{P}_{j,k} = \mathcal{P}_{j,k} \mathcal{P}_{i,k}$. By contrast, the algebra of generalized permutations is more subtle: although $\mathcal{P}_{i,j} \mathcal{P}_{i,\lambda}$ is equal to $\mathcal{P}_{j,\lambda} \mathcal{P}_{i,j}$, the product $\mathcal{P}_{i,\lambda} \mathcal{P}_{j,\lambda}$ is in general not equal to $\mathcal{P}_{i,j} \mathcal{P}_{i,\lambda}$.

Nevertheless, as explained in appendix A (see (A.51), which holds for arbitrary representations), the commutation relations are the same as for the fundamental representations. For instance, this implies that

$$(\mathcal{P}_{i,j} + \mathcal{P}_{i,\lambda}, \mathcal{P}_{j,\lambda})_- = 0 \quad (\text{II.47})$$

holds even for generalized permutations. This allows to prove that the left-hand-side of (II.46), as a polynomial of \mathbf{u} and \mathbf{v} , has all its coefficients equal to zero. For instance the coefficient of $\mathbf{u}^0 \mathbf{v}^1$ is zero due to (II.47). The same argument proves that the coefficient of $\mathbf{u}^1 \mathbf{v}^0$ is zero, whereas the coefficients of $\mathbf{u}^2 \mathbf{v}^1$, $\mathbf{u}^1 \mathbf{v}^2$, $\mathbf{u}^2 \mathbf{v}^0$, $\mathbf{u}^0 \mathbf{v}^2$ and $\mathbf{u}^1 \mathbf{v}^1$ are trivially zero. Finally, the constant term is $\mathcal{P}_{i,\lambda} \mathcal{P}_{j,\lambda} \mathcal{P}_{i,j} - \mathcal{P}_{i,j} \mathcal{P}_{j,\lambda} \mathcal{P}_{i,\lambda}$, and vanishes due to the relation $\mathcal{P}_{i,j} \mathcal{P}_{i,\lambda} = \mathcal{P}_{j,\lambda} \mathcal{P}_{i,j}$. \square

³The fundamental representation is the representation given by the vector space $\mathcal{H}_{a_k} = \mathbb{C}^K$ and by the morphism $\pi(g) = g$.

As a consequence of the Yang-Baxter equation (II.46), we can now define T-operators associated to each Young diagram:

$$\boxed{T^{(\lambda)}(\mathbf{u}) = \text{tr}_\lambda (R_{L,\lambda}(\mathbf{u}_L) R_{L-1,\lambda}(\mathbf{u}_{L-1}) \cdots R_{1,\lambda}(\mathbf{u}_1) \cdot \pi_\lambda(g))}, \quad (\text{II.48})$$

$$\text{where } \mathbf{u}_i \equiv \mathbf{u} - \theta_i \quad (\text{II.49})$$

where the partial trace is performed on the auxiliary space, which corresponds to the representation λ . This generalizes the previous T-operators to the case when $\lambda \neq \square$.

The commutation relation

$$\boxed{\forall \mathbf{u}, \mathbf{v}, \lambda, \quad \left(T^{(\lambda)}(\mathbf{u}), T(\mathbf{v}) \right)_- = 0}, \quad (\text{II.50})$$

is then obtained from (II.46), and it holds for two T-operators defined with the same twist g , and the same inhomogeneities θ_i . They only differ by the spectral parameter \mathbf{u} and the representation λ .

The commutation relation (II.50) ensures that the operators $T^{(\lambda)}(\mathbf{u})$ are conserved charges, because the Hamiltonian is expressed in terms of the operators $T(\mathbf{u})$. It is also possible to prove another commutation relation:

$$\forall \mathbf{u}, \mathbf{v}, s, s' \quad \left(T^{\overbrace{(\square \cdots \square)}^s}(\mathbf{u}), T^{\overbrace{(\square \cdots \square)}^{s'}}(\mathbf{v}) \right)_- = 0, \quad (\text{II.51})$$

where $\overbrace{(\square \cdots \square)}^s$ denotes the Young diagram $\lambda = (s, 0, 0, \dots)$ (see (A.21)). This diagram corresponds to the representation obtained by symmetrizing $(\mathbb{C}^K)^{\otimes s}$.

To this end, we should consider the expression (A.52) of the generators, shown in appendix A. Then, it is actually possible to rewrite the projector⁴ $P_{\overbrace{(\square \cdots \square)}^s}$ as a product of fundamental R -matrices defined in (II.15), as explained in section 6 of the paper [KV08]. Then, the commutation relation (II.51) arises from manipulations of this fundamental R -matrix (see [KV08]).

Actually we will even show in section II.1.4.3 that all the T-operators commute with each other:

$$\forall \mathbf{u}, \mathbf{v}, \lambda, \mu \quad \left(T^{(\lambda)}(\mathbf{u}), T^{(\mu)}(\mathbf{v}) \right)_- = 0. \quad (\text{II.52})$$

II.1.2 Differential expression of the T-operators

In [KV08], it was shown that these T-operators can be expressed in terms of differential operators, by differentiating with respect to the twist g .

⁴As explained in the appendix A, this projector performs a projection from $(\mathbb{C}^K)^{\otimes s}$ to the representation $\overbrace{(\square \cdots \square)}^s$ by symmetrizing with respect to all indices.

In [KV08], a differential operator \hat{D} called co-derivative is introduced and defined by

$$\hat{D} \otimes f(g) \equiv \frac{\partial}{\partial \phi^t} \otimes f(e^{\langle \phi, e \rangle} g) \Big|_{\phi=0} \quad (\text{II.53})$$

$$= \sum_{\alpha, \beta} e_{\alpha, \beta} \otimes \left(\frac{\partial}{\partial \phi_{\beta, \alpha}} f(e^{\sum_{\gamma, \delta} e_{\gamma, \delta} \phi_{\gamma, \delta}} g) \right) \Big|_{\phi \rightarrow 0}, \quad (\text{II.54})$$

where $\phi \in M(K)$ is a $K \times K$ matrix and $\langle \phi, e \rangle$ denotes $\sum_{\alpha, \beta} e_{\alpha, \beta} \phi_{\alpha, \beta}$, where the $e_{\alpha, \beta}$ are the generators of $GL(K)$, introduced in the appendix A.3.2 (they are matrices with one single non-zero coefficient at position α, β). The operator $\frac{\partial}{\partial \phi^t}$ is a matrix, whose coefficients are differentiations with respect to the coefficients of the transpose ϕ^t of ϕ :

$$\frac{\partial}{\partial \phi^t} \equiv \sum_{\alpha, \beta} e_{\alpha, \beta} \frac{\partial}{\partial \phi_{\beta, \alpha}}. \quad (\text{II.55})$$

If $f(g)$ belongs to a space E , we see that $\hat{D} \otimes f(g) \in M(K) \otimes E$. In practice $f(g)$ will be a linear operator on a Hilbert space $(\mathbb{C}^K)^{\otimes i}$:

$$f(g) : (\mathbb{C}^K)^{\otimes i} \rightarrow (\mathbb{C}^K)^{\otimes i} \quad (\text{II.56})$$

$$\hat{D} \otimes f(g) : (\mathbb{C}^K)^{\otimes i+1} \rightarrow (\mathbb{C}^K)^{\otimes i+1}, \quad (\text{II.57})$$

and we see that in terms of Hilbert space, the co-derivative \hat{D} “adds a spin” to the spin chain. In the particular case when $f(g)$ is not an operator but a scalar, we will usually write $\hat{D} f(g)$ instead of $\hat{D} \otimes f(g)$.

This definition (II.53) is useful to obtain permutation operators:

$$\begin{aligned} \hat{D} \otimes \pi_\lambda(g) &= \sum_{\alpha, \beta} e_{\alpha, \beta} \otimes \left(\frac{\partial}{\partial \epsilon} \pi_\lambda(e^{\epsilon e_{\beta, \alpha}} \cdot \pi_\lambda(g)) \right) \Big|_{\epsilon \rightarrow 0} \\ &= \sum_{\alpha, \beta} e_{\alpha, \beta} \otimes \left(\frac{\partial}{\partial \epsilon} e^{\epsilon} \pi_\lambda(e_{\beta, \alpha}) \cdot \pi_\lambda(g) \right) \Big|_{\epsilon \rightarrow 0} \\ &= \left(\sum_{\alpha, \beta} e_{\alpha, \beta} \otimes \pi_\lambda(e_{\beta, \alpha}) \right) \cdot (\mathbb{I} \otimes \pi_\lambda(g)) = \mathcal{P}_{i, \lambda} \cdot (\mathbb{I} \otimes \pi_\lambda(g)). \end{aligned} \quad (\text{II.58})$$

Moreover, the usual Leibniz rule $((u v)' = u' v + u v')$ has a generalization for this co-derivative operator:

$$\hat{D} \otimes (f_1(g) \cdot f_2(g)) = \left[\hat{D} \otimes f_1(g) \right] \cdot (\mathbb{I} \otimes f_2(g)) + (\mathbb{I} \otimes f_1(g)) \cdot \left[\hat{D} \otimes f_2(g) \right], \quad (\text{II.59})$$

Where the “dot” symbol (\cdot) denotes the multiplication of operators, and where \hat{D} only acts on what is inside the same brackets $[\]$.

This implies

$$\hat{D} \otimes \hat{D} \otimes \pi_\lambda(g) = \hat{D} \otimes (\mathcal{P}_{2, \lambda} \cdot (\mathbb{I} \otimes \pi_\lambda(g))) = \mathcal{P}_{2, \lambda} \mathcal{P}_{1, \lambda} \cdot (\mathbb{I} \otimes \mathbb{I} \otimes \pi_\lambda(g)), \quad (\text{II.60})$$

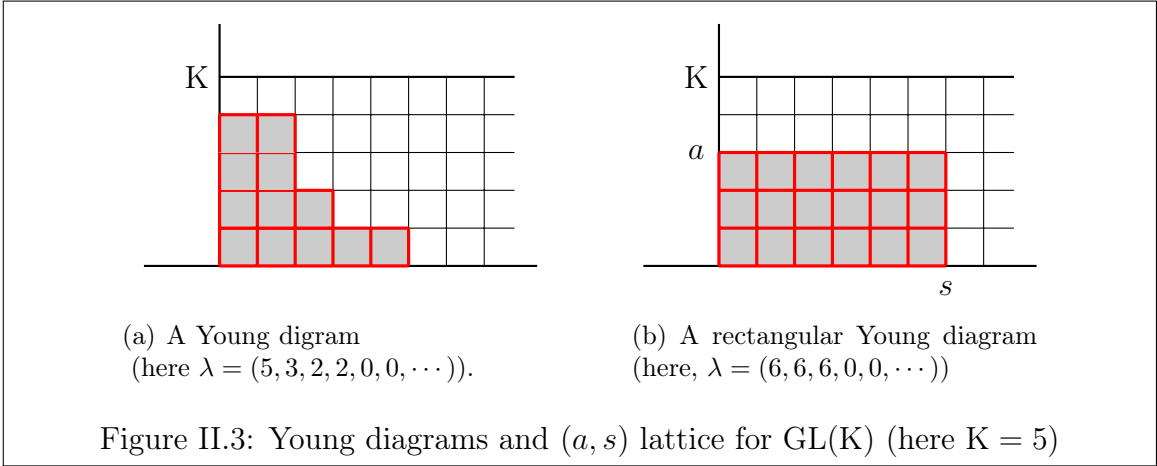

and more generally

$$(\mathbf{u}_1 + \hat{D}) \otimes (\mathbf{u}_2 + \hat{D}) \otimes \cdots \otimes (\mathbf{u}_L + \hat{D}) \otimes \pi_\lambda(g)$$

$$= (\mathbf{u}_L + \mathcal{P}_{L,\lambda}) \cdot (\mathbf{u}_{L-1} + \mathcal{P}_{L-1,\lambda}) \cdots (\mathbf{u}_1 + \mathcal{P}_{1,\lambda}) \cdot (\mathbb{I}^{\otimes L} \otimes \pi_\lambda(g)) \quad (\text{II.61})$$

$$= \mathcal{L}_g^{(\lambda)}(\mathbf{u}). \quad (\text{II.62})$$

Hence, the T-operators, which are the partial trace of \mathcal{L}_g , can be written as

$$\boxed{\mathbf{T}^{(\lambda)}(\mathbf{u}) = \left[\bigotimes_{i=1}^L (\mathbf{u}_i + \hat{D}) \quad \chi_\lambda(g) \right]} \quad \text{where } \mathbf{u}_i \equiv \mathbf{u} - \theta_i, \quad (\text{II.63})$$

where $\chi_\lambda(g)$ denotes the character of g in the representation λ , i.e. the trace of $\pi_\lambda(g)$ (see appendix A.3.4).

An important property that we can notice from this expression (II.63) is that $\mathbf{T}^{(\lambda)}(\mathbf{u})$ is polynomial in the variable \mathbf{u} . Let us define

$$\boxed{|\lambda| \equiv \text{Max} \{i | \lambda_i > 0\}}. \quad (\text{II.64})$$

Then we can see that for generic $g \in GL(K)$ (for instance in a vicinity of identity), this polynomial has degree L if $|\lambda| \leq K$, whereas if $|\lambda| > K$, the polynomial is identically zero. Indeed, as explained in appendix A, $\chi_\lambda(g)$ is identically zero if and only if $|\lambda| > K$. This statement can be easily understood as the impossibility to antisymmetrize more than K indices if they take values in $\llbracket 1, K \rrbracket$.

The condition $|\lambda| \leq K$ means that the Young diagram λ has to lie inside the lattice of figure II.3, where the Young diagrams are drawn as in (A.21), and the constraint $|\lambda| \leq K$ forces the Young-diagram to live inside the lattice $\llbracket 0, K \rrbracket \times \mathbb{N}$, where \mathbb{N} denotes the set $\{0, 1, 2, \dots\}$ of all non-negative integers. .

Let us also notice that, in this formalism, the T-operators are obtained by the action of co-derivatives on characters. The expression (II.63) of T-operators has the specificity that it starts from characters (obtained from a trace), and then spins are “created” by the action of co-derivative. This is conceptually quite different from usual definitions like

(II.48), where one should first multiply R -matrices corresponding to each spin, and take the trace afterwards. As a consequence, several non-trivial properties of the representations become irrelevant because the only thing we have to know about representations is their character.

Symmetry group In this construction, one point which may look surprising is that for the $SU(2)$ Heisenberg spin chain, we introduce a twist $g \in GL(2)$ and various representations of $GL(2)$. Actually choosing $GL(K)$ instead of $SU(K)$ simply makes the structure a little more general, and $SU(K)$ can be obtained by restricting the authorized values of g to $SU(K)$. Then all the representations of $GL(K)$ would be replaced by representations of $SU(K)$.

To elaborate a little more, let us notice that using the generators $\lambda^{(l)}$ of $SU(K)$ (i.e. the Gell-Mann matrices), we could define an “ $SU(K)$ co-derivative” as $\sum_l \lambda^{(l)} \otimes \frac{\partial}{\partial \phi_l} f \left(e^{-i \sum \phi_k \lambda^{(k)}} \right) \Big|_{\phi \rightarrow 0}$, where ϕ is vector with $K^2 - 1$ components. Then the formula (II.58) would become (for the representation μ)

$$\begin{aligned} \hat{D} \otimes \pi_\mu(g) &= \sum_l \lambda^{(l)} \otimes \left(\frac{\partial}{\partial \epsilon} \pi_\mu(e^{-i \epsilon \lambda^{(l)}}) \cdot \pi_\mu(g) \right) \Big|_{\epsilon \rightarrow 0} \\ &= -i \left(\sum_l \lambda^{(l)} \otimes \pi_\mu(\lambda^{(l)}) \right) \cdot (\mathbb{I} \otimes \pi_\mu(g)) \end{aligned} \quad (\text{II.65})$$

But one can show that $(\sum_l \lambda^{(l)} \otimes \pi_\mu(\lambda^{(l)})) = 4\mathcal{P}_{i,\mu} - \frac{4}{K}\mathbb{I}$, which means that this “ $SU(K)$ co-derivative” obeys exactly the same algebra as the $GL(K)$ co-derivative up to multiplicative factors $-4i$ and additive terms proportional to \mathbb{I} .

This means that the analysis we will perform applies as efficiently to the group $SU(K)$ (or even $SL(K)$) as to $GL(K)$.

II.1.3 Generalization to super-groups

Super-groups, such as $GL(K|M)$ introduced in appendix A.4, are groups of “matrices” such that the property (II.22) sometimes holds up to a sign, i.e. there exist “anticommuting” objects such that $(A \otimes \mathbb{I}) \cdot (\mathbb{I} \otimes B) = -(\mathbb{I} \otimes B) \cdot (A \otimes \mathbb{I})$. For these groups, the construction of the R matrix in equation (II.15) (or more generally (II.41)) has to be modified so that the Yang-Baxter equation still holds.

For these super-groups, the “physical” Hilbert spaces \mathcal{H}_i are linear combinations of $|1\rangle, |2\rangle, \dots, |K+M\rangle$, where $|1\rangle, |2\rangle, \dots, |K\rangle$ are “commuting” and $|K+1\rangle, |K+2\rangle, \dots, |K+M\rangle$ are “anti-commuting”. This means that for instance $(\langle i| \otimes \langle j|) \cdot (|k\rangle \otimes |l\rangle) = \pm \langle i|k\rangle \langle j|l\rangle$ where the sign is plus if $\min(j, k) \leq K$ (i.e. if either $|j\rangle$ or $|k\rangle$ is “commuting”) and minus otherwise. The signs can be summarized by saying that both $|i\rangle$ and $\langle i|$ have the grading $p_i \in \mathbb{Z}/2\mathbb{Z}$ defined by:

$$(-1)^{p_i} = 1 \quad \text{if } i \in [1, K] \quad (\text{II.66})$$

$$(-1)^{p_i} = -1 \quad \text{if } i \in [K+1, M]. \quad (\text{II.67})$$

For arbitrary objects A and B with well-defined gradings p_A and p_B , we have $(A \otimes \mathbb{I}) \cdot (\mathbb{I} \otimes B) = A \otimes B = (-1)^{p_A p_B} (\mathbb{I} \otimes B) \cdot (A \otimes \mathbb{I})$. For usual matrix groups such as $GL(K)$, all gradings are zero and there is no such sign.

The simplest way to define a permutation operator would be to keep the definition (II.5) unchanged. Let us see how it would then act on $|i\rangle \otimes |j\rangle$:

$$\begin{aligned} \left(\sum_{1 \leq k, l \leq K+M} |k\rangle \langle l| \otimes |l\rangle \langle k| \right) \cdot |i\rangle \otimes |j\rangle &= \sum_{1 \leq k, l \leq K+M} (-1)^{(p_k + p_l) p_i} (|k\rangle \langle l| |i\rangle) \otimes (|l\rangle \langle k| |j\rangle) \\ &= (-1)^{(p_j + p_i) p_i} |j\rangle \otimes |i\rangle, \end{aligned} \quad (\text{II.68})$$

using the fact that the grading of $|l\rangle \langle k|$ is $p_k + p_l$.

Finally, one can check that if the permutation operator was defined as $\mathcal{P}_{1,2} = \sum_{1 \leq k, l \leq K+M} |k\rangle \langle l| \otimes |l\rangle \langle k|$, then due to the sign in (II.68) the Yang-Baxter equation (II.14) would fail. To ensure that the Yang-Baxter equation still holds, it is actually sufficient to change the signs in the definition of \mathcal{P} , which gives the definition

$$\mathcal{P}_{1,2} = \sum_{1 \leq k, l \leq K+M} (-1)^{p_l} |k\rangle \langle l| \otimes |l\rangle \langle k|. \quad (\text{II.69})$$

This equation gives very naturally

$$\mathcal{P}_{1,2} \cdot |i\rangle \otimes |j\rangle = (-1)^{p_i p_j} |j\rangle \otimes |i\rangle, \quad (\text{II.70})$$

which is the natural generalization of (I.2) when some vectors are anti-commuting.

For more spins, one gets for instance

$$\mathcal{P}_{1,3} \cdot |i\rangle \otimes |j\rangle \otimes |n\rangle = \left(\sum_{1 \leq k, l \leq K+M} (-1)^{p_l} |k\rangle \langle l| \otimes \mathbb{I} \otimes |l\rangle \langle k| \right) |i\rangle \otimes |j\rangle \otimes |n\rangle \quad (\text{II.71})$$

$$= \left(\sum_{1 \leq k, l \leq K+M} (-1)^{p_l + (p_l + p_k)(p_i + p_j)} (|k\rangle \langle l| |i\rangle) \otimes |j\rangle \otimes (|l\rangle \langle k| |n\rangle) \right) \quad (\text{II.72})$$

$$= (-1)^{p_i + (p_i + p_n)(p_i + p_j)} |n\rangle \otimes |j\rangle \otimes |i\rangle \quad (\text{II.73})$$

To show that (II.14) holds with the definition (II.69), it is sufficient to prove that $\mathcal{P}_{i,j} \mathcal{P}_{j,k} = \mathcal{P}_{j,k} \mathcal{P}_{i,k}$ holds. For instance for three spins:

$$\mathcal{P}_{1,2} \mathcal{P}_{2,3} |i, j, k\rangle = (-1)^{p_k (p_i + p_j)} |k, i, j\rangle = \mathcal{P}_{2,3} \mathcal{P}_{1,3} |i, j, k\rangle, \quad (\text{II.74})$$

where we used (II.73). It is not complicated to deduce that $\mathcal{P}_{i,j} \mathcal{P}_{j,k} = \mathcal{P}_{j,k} \mathcal{P}_{i,k}$ also holds for more spins.

Finally with this definition of the permutation operator, the construction of section II.1 still gives a family of commuting T-operators.

This definition of the permutation operator, introduced here to reproduce the Yang-Baxter identity (II.14), actually also allows to define representations associated to Young

diagrams (see appendix A.4), and to define T-operators associated to arbitrary Young diagrams.

In order to also write the expression of T-operators in terms of co-derivatives, as in section II.1.2, we then have to incorporate the same sign into the definition of the co-derivative, by replacing (II.55) with

$$\frac{\partial}{\partial \phi^t} \equiv \sum_{\alpha, \beta} (-1)^{p_\beta} e_{\alpha, \beta} \frac{\partial}{\partial \phi_{\beta, \alpha}}. \quad (\text{II.75})$$

The introduction of this sign is such that the relation $\hat{D} \otimes \pi_\lambda(g) = \mathcal{P}_{i, \lambda} \cdot (\mathbb{I} \otimes \pi_\lambda(g))$ holds by the same argument as in (II.58).

Therefore, the relation (II.63) holds for super-groups as well, and we will now be indistinctly working with either a super-group, or a more “standard” matrix group such as $\text{GL}(\mathbb{K})$.

This construction gives a set of commuting operators, which we want to interpret as conserved quantities of a given model. For this we can for instance define the Hamiltonian

$$H = \frac{2}{K + M} L - 2 \partial_u \log T^\square(\mathbf{u}) \Big|_{\mathbf{u}=0}, \quad (\text{II.76})$$

where $T^\square(\mathbf{u})$ is the T-operator corresponding to the fundamental representation (this operator was denoted $T(\mathbf{u})$ in the section II.1.1.2).

In the case when all inhomogeneities are set to zero, it can be rewritten as

$$H = \frac{2}{K + M} \mathbb{I} - 2 \left(\sum_{i=1}^{L-1} \mathcal{P}_{i, i+1} \right) - 2 \mathcal{P}_{1, L} \cdot g_L \cdot g_1^{-1}, \quad (\text{II.77})$$

exactly like in (II.34). This Hamiltonian corresponds to interactions between nearest neighbors, because it is the sum over i of an operator (the generalized permutation) acting only on the spins i and $i+1$. We will see that with this Hamiltonian, the spin chain is integrable, due to the relation (II.76) between H and $T^\square(\mathbf{u})$. For this Hamiltonian, the T-operators are conserved quantities, because they commute with $T^\square(\mathbf{u})$.

An important difference with the bosonic case (i.e. the $\text{GL}(\mathbb{K})$ spin chain of section II.1.1) is that the character $\chi_\lambda(g)$ is nonzero when $\lambda_{K+1} \leq M$ [DM92]. This condition reduces to the condition $|\lambda| \leq K$ if $M = 0$, but if $M \neq 0$, it gives rise to the lattice of figure II.4, where we see that the Young diagrams are forced to lie inside a lattice, having the shape of a fat letter L. This lattice will be called a fat hook in this manuscript.

II.1.4 Hirota equation and Cherednik-Bazhanov-Reshetikhin determinant formula

In this section, we will introduce the “fusion relations” between the T-operators corresponding to various representations. We will introduce the results obtained in [KV08] (in particular the derivation of the CBR determinant formula (II.80) found in [Che86, BR90]), and briefly introduce the proof of these results.

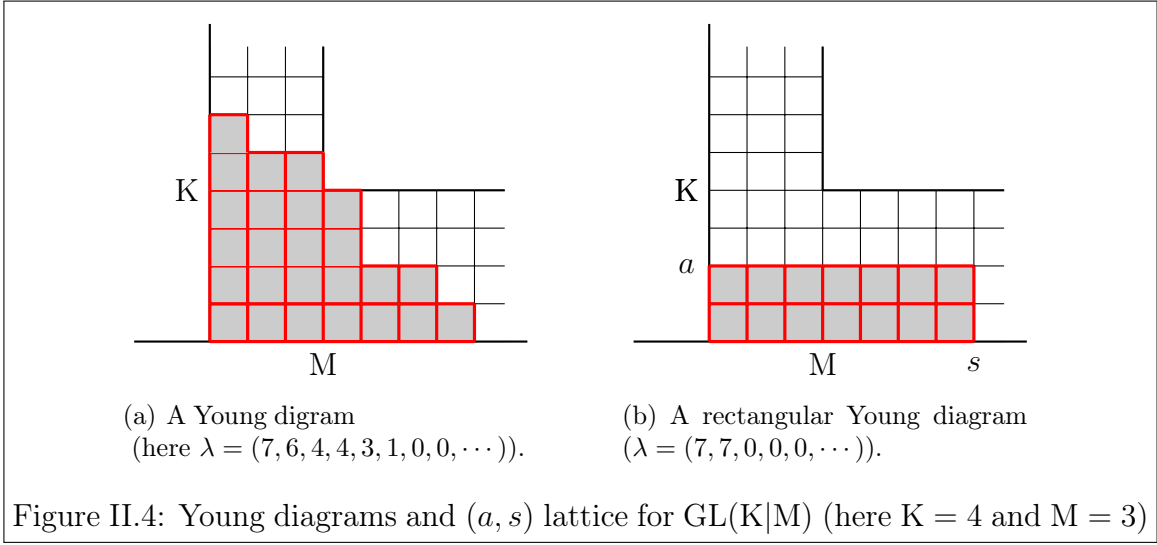

First let us introduce a particular family of T-operators corresponding to “rectangular” Young diagrams: in view of the parameterization (A.21) let us define

$$\boxed{T^{a,s}(\mathbf{u}) \equiv T^{(\lambda_{[a,s]})}(\mathbf{u}) \quad \text{where } \lambda_{[a,s]} \equiv \underbrace{(s, s, \dots, s, s, 0, 0, \dots)}_{a \text{ times}}} \quad (\text{II.78})$$

which corresponds to a rectangular Young diagram of horizontal size s and vertical size a .

As explained in appendix A, the character of a generic group element $g \in GL(K|M)$ is nonzero if and only if λ obeys the condition $\lambda_{K+1} \leq M$. Using (II.63) we deduce that $T^{(\lambda)}(\mathbf{u})$ is a nonzero polynomial of the variable \mathbf{u} for Young diagrams if and only if $\lambda_{K+1} \leq M$. For rectangular representations, that means that $T^{a,s}(\mathbf{u})$ is nonzero if and only if $(a, s) \in \mathbb{L}(K, M)$, where the “fat hook” $\mathbb{L}(K, M)$ is defined by

$$\mathbb{L}(K, M) \equiv \left\{ (a, s) \in \mathbb{N} \times \mathbb{Z} \left| \begin{array}{l} s \geq 0 \quad \text{and } 0 \leq a \leq K \\ \text{or} \\ a \geq 0 \quad \text{and } 0 \leq s \leq M \\ \text{or} \\ a = 0 \end{array} \right. \right\}. \quad (\text{II.79})$$

This lattice of authorized values of (a, s) is shown in the figure II.3 (page 35) for $GL(K) = GL(K|0)$ and in the figure II.3 (page 35) for $GL(K|M)$. Moreover, one should note that the representations associated to $(a = 0; s \in \mathbb{Z})$ or to $(s = 0; a \in \mathbb{N})$ are identical (they correspond to $\lambda = (0, 0, 0, \dots)$), which means that $T^{0,s}(\mathbf{u}) = T^{a,0}(\mathbf{u}) = T^{0,0}(\mathbf{u})$. In the present case, this representation is associated to the T-operator $T^{0,0}(\mathbf{u}) = \prod_{i=1}^L u_i$.

An important relation satisfied by T-operators is then the following determinant relation (which is called the “Cherednik-Bazhanov-Reshetikhin” formula [Che86, BR90],

and which we will prove below)

$$\mathbb{T}^{(\lambda)}(\mathbf{u}) = \frac{\left| \left(\mathbb{T}^{1, \lambda_j + i - j}(\mathbf{u} + 1 - i) \right)_{1 \leq i, j \leq |\lambda|} \right|}{\prod_{k=1}^{|\lambda|-1} \mathbb{T}^{0,0}(\mathbf{u} - k)}, \quad (\text{II.80})$$

where $|\lambda|$ is defined by (II.64).

The numerator of the right-hand-side is the determinant of the $|\lambda| \times |\lambda|$ matrix whose coefficients are the commuting operators $\mathbb{T}^{1, \lambda_j + i - j}(\mathbf{u} + 1 - i)$, where $\mathbb{T}^{1,s}(\mathbf{u})$ corresponds to the symmetric representation $\lambda_{[1,s]} = \underbrace{\square \square \dots \square}_s$.

This equation generalizes the relation

$$\chi_\lambda(g) = \left| \left(\chi^{(\lambda_i + j - i)}(g) \right)_{1 \leq i, j \leq |\lambda|} \right|, \quad (\text{II.81})$$

on characters (see appendix A.3.4), where $\chi^{(s)}$ denotes the character associated to the representation $\lambda_{[1,s]}$. It allows to express an arbitrary \mathbb{T} -operator in terms of the operators $\mathbb{T}^{1,s}(\mathbf{u})$. That will allow to prove the commutation relation (II.52), but also to show the Hirota equation (II.101), found in [KP92, KN92, KLVZ97, Tsu97].

Though this determinant relation was proven in [KV08], it will be helpful to recall this proof, which extensively relies on the ‘‘co-derivative’’ formalism. The proof is done in two main steps: the first step shows that the right-hand-side of (II.80) is a polynomial (by showing the vanishing of specific minors (II.83) of the determinant), and the second step checks that it really coincides with $\mathbb{T}^{(\lambda)}(\mathbf{u})$.

II.1.4.1 Proof of the CBR formula : Part one

Let us start by proving that the right-hand-side of (II.80) is polynomial:

By definition, all the $\mathbb{T}^{1,s}(\mathbf{v})$ inside the determinant are polynomial functions of the variable \mathbf{v} . Moreover, the denominator is a polynomial, which can be written explicitly due to the relation

$$\mathbb{T}^{0,0}(\mathbf{u}) \equiv \prod_{i=1}^L u_i = \prod_{i=1}^L (u - \theta_i). \quad (\text{II.82})$$

This relation is nothing but the definition (II.63), where the representation associated to an empty Young diagram $\lambda_{[0,0]} = \lambda_{[a,0]} = \lambda_{[0,s]}$ has the character $\chi_{\lambda_{[1,0]}}(g) = 1$, as it can be seen from the relation (A.55) in the appendix A.3.2.

Hence in order to prove that the right-hand-side of (II.80) is polynomial, it is sufficient to prove that it has no pole, i.e. that the determinant is zero⁵ when $\mathbf{u} = \theta_i + k$ for arbitrary $i \in \llbracket 1, L \rrbracket, k \in \llbracket 1, |\lambda| - 1 \rrbracket$. To do this, we can expand the determinant with respect to the two successive lines at position k and $k + 1$. That gives a sum of terms of the form

⁵Rigorously, the argument works under the condition that the denominator only has simple zeroes i.e. under the condition that the $\theta_i - \theta_j$'s are not integer. We will explain later in the text how to deal with this constraint.

$(T^{1,s_1}(\theta_i + 1)T^{1,s_2}(\theta_i) - T^{1,s_2-1}(\theta_i + 1)T^{1,s_1+1}(\theta_i)) \cdot D(k, k + 1; j_0, j_1)$, where $D(k, k'; l, l')$ denotes the $(|\lambda| - 2) \times (|\lambda| - 2)$ minor obtained by removing the lines k and k' and the columns l and l' from the determinant, and where we introduced $s_1 = \lambda_{j_0} + k - j_0$ and $s_2 = \lambda_{j_1} + k + 1 - j_1$.

In order to prove that this numerator is zero when $\mathbf{u} = \theta_i + k$, we will prove the relation

$$\boxed{T^{1,s_1}(\theta_i + 1) \cdot T^{1,s_2}(\theta_i) - T^{1,s_1+1}(\theta_i) \cdot T^{1,s_2-1}(\theta_i + 1) = 0}, \quad (\text{II.83})$$

which means that all the terms of the determinant (expanded with respect to the columns k and $k + 1$) vanish. That will prove that the right-hand-side of (II.80) has no pole, and is indeed a polynomial function of the variable \mathbf{u} .

In order to prove (II.83), it is very convenient to introduce the generating series of $T^{1,s}(\mathbf{u})$ and to rewrite (II.83) as the equivalent statement

$$\mathcal{W}(\theta_i + 1; z) \cdot \mathcal{W}(\theta_i; y) - \frac{y}{z} \mathcal{W}(\theta_i; z) \cdot \mathcal{W}(\theta_i + 1; y) = 0 \quad (\text{II.84})$$

$$\text{where } \boxed{\mathcal{W}(\mathbf{u}; z) \equiv \sum_{s=0}^{\infty} T^{1,s}(\mathbf{u}) z^s} = \left[\bigotimes_{i=1}^L (\mathbf{u}_i + \hat{D}) \quad w(z) \right], \quad (\text{II.85})$$

where $w(z) \equiv \sum_{s=0}^{\infty} z^s \chi^{(s)}$ is defined by (A.58) in the appendix A.3 introducing the representations associated to given Young diagrams.

To prove the relation (II.84) for arbitrary inhomogeneities θ_j , we will first prove it in the simplest case : when all inhomogeneities are equal to zero. In that case, the relation that we have to prove is simply

$$z \left[(1 + \hat{D})^{\otimes L} w(z) \right] \cdot \left[\hat{D}^{\otimes L} w(y) \right] = y \left[\hat{D}^{\otimes L} w(z) \right] \cdot \left[(1 + \hat{D})^{\otimes L} w(y) \right] \quad (\text{II.86})$$

Proof of (II.86). Using the appendix B.1, we will now see that (II.86) has a remarkably simple proof, which relies on a diagrammatic expression of operators like $\left[(1 + \hat{D})^{\otimes L} w(z) \right]$. For instance, one can show the relation $\hat{D} w(x) = \frac{gx}{1-gx} w(x)$, which can be graphically represented as

$$\hat{D} w(x) = \begin{array}{c} \vdots \\ | \\ w(x) \end{array}. \quad (\text{II.87})$$

where the line $\begin{array}{c} \vdots \\ | \end{array}$ stands for the operator $\frac{gx}{1-gx}$. Next, one computes $\hat{D} \otimes \hat{D} w(x) = \left(\frac{gx}{1-gx} \otimes \frac{gx}{1-gx} + \mathcal{P}_{1,2} \left(\frac{1}{1-gx} \otimes \frac{gx}{1-gx} \right) \right) w(x)$, which can be written diagrammatically as

$$\hat{D} \otimes \hat{D} w(x) = \left(\begin{array}{c} \vdots \\ | \\ | \end{array} + \begin{array}{c} \times \\ \vdots \\ \times \end{array} \right) w(x), \quad (\text{II.88})$$

where $\begin{array}{c} \vdots \\ | \end{array}$ denotes the operator $\frac{1}{1-gx}$. More details about this diagrammatic can be found in the appendix B.1, including a very simple pattern to write $\hat{D}^{\otimes L} w(x)$: one should write

a term for each permutation, and dash all the lines going up to the right. For instance, this rule gives

$$\hat{D}^{\otimes 3} w(x) = \left(\begin{array}{|l} \vdots \\ \vdots \\ \vdots \end{array} + \begin{array}{|l} \vdots \\ \times \\ \vdots \end{array} + \begin{array}{|l} \times \\ \vdots \\ \vdots \end{array} + \begin{array}{|l} \times \\ \times \\ \vdots \end{array} + \begin{array}{|l} \times \\ \times \\ \times \end{array} + \begin{array}{|l} \times \\ \times \\ \times \end{array} \right) w(x). \quad (\text{II.89})$$

In this expression each picture is a graphical representation of a given operator: for instance $\begin{array}{|l} \vdots \\ \vdots \\ \vdots \end{array}$ stands for the operator $\frac{gx}{1-gx} \otimes \frac{gx}{1-gx} \otimes \frac{gx}{1-gx}$, whereas $\begin{array}{|l} \vdots \\ \times \\ \vdots \end{array}$ stands for the operator $\mathcal{P}_{1,2} \cdot \left(\frac{1}{1-gx} \otimes \frac{gx}{1-gx} \otimes \frac{gx}{1-gx} \right)$. These representations of operators will be called \hat{D} -diagrams, because they arise from the Leibniz rule when the effect of successive co-derivatives is computed.

One can also show that a very similar diagrammatic rule can be used to compute $(1 + \hat{D})^{\otimes 3} w(x)$: in this case, one should dash all the lines which are either vertical, or going up to the right. For instance, one gets

$$(1 + \hat{D})^{\otimes 3} w(x) = \left(\begin{array}{|l} \vdots \\ \vdots \\ \vdots \end{array} + \begin{array}{|l} \vdots \\ \times \\ \vdots \end{array} + \begin{array}{|l} \times \\ \vdots \\ \vdots \end{array} + \begin{array}{|l} \times \\ \times \\ \vdots \end{array} + \begin{array}{|l} \times \\ \times \\ \times \end{array} + \begin{array}{|l} \times \\ \times \\ \times \end{array} \right) w(x). \quad (\text{II.90})$$

Let us then consider the operator $\left[(1 + \hat{D})^{\otimes 3} w(x) \right] \cdot \mathcal{P}_{\sigma_c}$ where σ_c is the cyclic permutation $\sigma_c(1) = L$, $\sigma_c(i+1) = i$. For an arbitrary operator \mathcal{O} , the coordinates of the product $\mathcal{O} \cdot \mathcal{P}_{\sigma_c}$ are easily obtained as

$$(\mathcal{O} \cdot \mathcal{P}_{\sigma_c})_{j_1, j_2, \dots, j_L}^{i_1, i_2, \dots, i_L} = \mathcal{O}_{j_2, j_3, \dots, j_L, j_1}^{i_1, i_2, \dots, i_L}. \quad (\text{II.91})$$

As a consequence, if the operator \mathcal{O} corresponds to a given \hat{D} -diagram (as introduced above, or with more details in the appendix B.1), then the operator $\mathcal{O} \cdot \mathcal{P}_{\sigma_c}$ corresponds to another \hat{D} -diagram, obtained by (cyclicly) shifting to the left the lower dots of each \hat{D} -diagram, to get (for instance for $L = 3$)

$$\left[(1 + \hat{D})^{\otimes 3} w(x) \right] \cdot \mathcal{P}_{\sigma_c} = \left(\begin{array}{|l} \times \\ \times \\ \times \end{array} + \begin{array}{|l} \times \\ \times \\ \times \end{array} + \begin{array}{|l} \vdots \\ \times \\ \vdots \end{array} + \begin{array}{|l} \times \\ \vdots \\ \vdots \end{array} + \begin{array}{|l} \vdots \\ \vdots \\ \vdots \end{array} + \begin{array}{|l} \times \\ \times \\ \times \end{array} \right) w(x). \quad (\text{II.92})$$

This coincides exactly with (II.89) up to the fact that one line (emphasized, in red in the online version) is dashed instead of solid. Indeed, both (II.90) and (II.92) are sums over all permutations $\sigma \in \mathcal{S}^L$, with a specific dashing rule: in (II.90), the solid lines are the lines going up to the left. After multiplication by the permutation, these lines go up either vertically or to the left, and the fact that they are solid consistently reproduces (II.89). The same argument holds for dashed lines, except for the line connected to the bottom-right-dot in (II.90). Thus, for arbitrary $L \geq 1$, $\left[(1 + \hat{D})^{\otimes L} w(x) \right] \cdot \mathcal{P}_{\sigma_c}$ coincides with $\hat{D}^{\otimes L} w(x)$ up to the fact that in every \hat{D} -diagram, the line connected to the bottom-right-dot is dashed instead of solid. If we recall that solid (resp dashed) lines stand for $\frac{gx}{1-gx}$ (resp $\frac{1}{1-gx}$), one gets the statement

$$\left[(1 + \hat{D})^{\otimes L} w(x) \right] \cdot \mathcal{P}_{\sigma_c} \cdot (\mathbb{I}^{\otimes(L-1)} \otimes gx) = \hat{D}^{\otimes L} w(x). \quad (\text{II.93})$$

The same arguments allow to prove that

$$(\mathbb{I}^{\otimes(L-1)} \otimes g y)^{-1} \cdot \mathcal{P}_{\sigma_c}^{-1} \cdot \left[\hat{\mathbb{D}}^{\otimes L} w(y) \right] = \left(1 + \hat{\mathbb{D}} \right)^{\otimes L} w(y). \quad (\text{II.94})$$

Multiplying (II.93) by (II.94) gives exactly (II.86). \square

Proof of (II.84). As shown in the section B.2.2 (in appendix B), a simple recurrence allows to show that the identity (II.86) implies the more general relation (B.40), which reads

$$\mathcal{W}(\mathbf{u} + 1; z) \cdot \mathcal{W}(\mathbf{u}; y) - \frac{y}{z} \mathcal{W}(\mathbf{u}; z) \cdot \mathcal{W}(\mathbf{u} + 1; y) = \left(1 - \frac{y}{z} \right) \mathcal{W}(\mathbf{u} + 1; y, z) \cdot \left[\prod_{i=1}^L \mathbf{u}_i \right], \quad (\text{II.95})$$

$$\text{where } \mathcal{W}(\mathbf{u}; y, z) \equiv \left[\bigotimes_{i=1}^L \left(\mathbf{u}_i + \hat{\mathbb{D}} \right) w(y)w(z) \right]. \quad (\text{II.96})$$

If we recall that $\mathbf{u}_i \equiv \mathbf{u} - \theta_i$, this relation immediately implies (II.84). \square

This proves the vanishing (II.83) of the determinant (II.80) at the zeroes of the denominator, because all terms in its expansion with respect to the lines k and $k + 1$ vanish.

If the denominator only has simple zeroes, this is enough to show that the right-hand-side of (II.80) is indeed polynomial in the variable \mathbf{u} .

On the other hand, the denominator has multiple zeroes only if there exist some inhomogeneities θ_i and θ_j such that $\theta_i - \theta_j$ is an integer. If this is the case, the zeroes of the denominator are easily transformed into simple zeroes by adding small perturbations to the \mathbf{u}_i 's. When these perturbations are removed, several zeroes of the denominator collide (to form a zero of multiplicity greater than one), while the same number of zeroes collide in the numerator, giving rise to a zero with (at least) the same multiplicity. This shows that the right-hand-side of (II.80) is indeed polynomial in the variable \mathbf{u} , even when the denominator has zeroes with multiplicities.

II.1.4.2 Proof of the CBR formula : part two

Having proven that the right-hand-side of (II.80) is a polynomial (as a function of the spectral parameter \mathbf{u}), the next step is now to show that it coincides exactly with the left-hand-side. To this end, the denominator in (II.80) can be explicitated from (II.82) and then incorporated into the determinant:

$$\frac{\left| \left(\mathbb{T}^{1, \lambda_j + i - j}(\mathbf{u} + 1 - i) \right)_{1 \leq i, j \leq a} \right|}{\prod_{k=1}^{a-1} \mathbb{T}^{0,0}(\mathbf{u} - k)} = \left| \left(\bigotimes_{i=1}^L \left(1 + \frac{1}{\mathbf{u}_i + 1 - i} \hat{\mathbb{D}} \right) \chi^{(\lambda_j + i - j)}(g) \right)_{1 \leq i, j \leq a} \right| \cdot \prod_{i=1}^L \mathbf{u}_i, \quad (\text{II.97})$$

where $\chi^{(s)}$ is the character of the symmetric representation, introduced in (A.58).

This expression can be expanded in each variable u_i around $u_i \rightarrow \infty$. For instance, when $u_1 \rightarrow \infty$, (II.97) becomes

$$\begin{aligned} & \left| \frac{(\mathbb{T}^{1, \lambda_j + i - j}(\mathbf{u} + 1 - i))_{1 \leq i, j \leq a}}{\prod_{k=1}^{a-1} \mathbb{T}^{0,0}(\mathbf{u} - k)} \right| \\ &= (u_1 + \hat{D}) \left| \left(\bigotimes_{i=2}^L \left(1 + \frac{1}{u_i + 1 - i} \hat{D} \right) \chi^{(\lambda_j + i - j)}(g) \right)_{1 \leq i, j \leq a} \right| \cdot \prod_{i=2}^L u_i + \mathcal{O}\left(\frac{1}{u_1}\right). \end{aligned} \quad (\text{II.98})$$

Proof of (II.98). In the determinant on the right-hand-side of (II.97), the term of degree 0 in u_1 is simply $\left| \left(\bigotimes_{i=2}^L \left(1 + \frac{1}{u_i + 1 - i} \hat{D} \right) \chi^{(\lambda_j + i - j)}(g) \right)_{1 \leq i, j \leq a} \right|$, obtained by neglecting all terms with $\frac{1}{u_1}$. After multiplication by $\prod_{i=1}^L u_i$, this gives the term of degree 1 in u_1 . The next term is obtained by recalling that a determinant is a sum (running over permutations) of products of coefficients. For each term of this sum, the coefficient of $\frac{1}{u_1}$ is obtained by keeping a $\frac{\hat{D}}{u_1}$ in one (and only one) of the factors. This prescription exactly coincides with the co-derivative of $\frac{1}{u_1} \left| \left(\bigotimes_{i=2}^L \left(1 + \frac{1}{u_i + 1 - i} \hat{D} \right) \chi^{(\lambda_j + i - j)}(g) \right)_{1 \leq i, j \leq a} \right|$, expressed through the Leibniz rule. \square

Moreover, we can note that due to the polynomiality of the left-hand-side, the term $\mathcal{O}\left(\frac{1}{u_1}\right)$ in (II.98) is necessarily equal to zero. We can then reproduce the argument to expand the result (II.98) around $u_2 \rightarrow \infty$, and iterate up to $u_L \rightarrow \infty$. After these iterations, we get

$$\left| \frac{(\mathbb{T}^{1, \lambda_j + i - j}(\mathbf{u} + 1 - i))_{1 \leq i, j \leq a}}{\prod_{k=1}^{a-1} \mathbb{T}^{0,0}(\mathbf{u} - k)} \right| = \bigotimes_{i=1}^L (u_i + \hat{D}) \left| (\chi^{(\lambda_j + i - j)}(g))_{1 \leq i, j \leq a} \right|. \quad (\text{II.99})$$

Finally, the Weyl formula (II.81) allows to write the right-hand-side of (II.99) as $\left[\bigotimes_{i=1}^L (u_i + \hat{D}) \chi_\lambda(g) \right]$, which is equal to $\mathbb{T}^{(\lambda)}(\mathbf{u})$. As a consequence, (II.99) is exactly the CBR formula (II.80).

II.1.4.3 Fusion rule and commutation relation (II.52)

As explained in the construction of the model, the T-operators obey the commutation (II.51)⁶. This means that all the T-operators in the right-hand side of (II.80) commute with each other, and therefore, (II.80) implies the general commutation relation

$$\forall \mathbf{u}, \mathbf{v}, \lambda, \mu, \quad \boxed{\left(\mathbb{T}^{(\lambda)}(\mathbf{u}), \mathbb{T}^{(\mu)}(\mathbf{v}) \right)_- = 0}. \quad (\text{II.100})$$

⁶One should remember that $\mathbb{T}^{\overbrace{(\square \square \dots \square)}^s}(\mathbf{u}) = \mathbb{T}^{1,s}(\mathbf{u})$

But of course, the CBR determinant formula (II.80) tells much more than just a commutation relation: it tells how to express the T-operators for an arbitrary representation in terms of T-operators for simpler representations corresponding to Young-diagrams with one single row. This result is often called a “fusion rule”.

Moreover, we will now show (in section II.1.5.1) that when restricted to rectangular representations (II.78), this CBR determinant formula (II.80) is equivalent to the following bilinear identity, called the Hirota Identity [KP92, KN92, KLWZ97, Tsu97]:

$$T^{a,s}(\mathbf{u} + 1) \cdot T^{a,s}(\mathbf{u}) = T^{a+1,s}(\mathbf{u} + 1) \cdot T^{a-1,s}(\mathbf{u}) + T^{a,s-1}(\mathbf{u} + 1) \cdot T^{a,s+1}(\mathbf{u}) \quad (\text{II.101})$$

This identity involves the product of commuting operators, and it occurs frequently for integrable models. What we will show in the next sections is that this identity allows to diagonalize the T-operators and to recover the spectrum of the theory.

Moreover, as we have already seen, the T-operators are nonzero only inside the lattice $\mathbb{L}(\mathbf{K}, \mathbf{M})$ of figure II.4 (page 39). In the next section we will investigate some properties of the solutions of Hirota equation on this lattice. An explicit proof of these properties will then be given in section II.3, where fundamental quantities of interests, called Q-operators, will be defined.

II.1.5 Jacobi identity and bilinear equations

Let us now show in what sense the Hirota equation (II.101) is equivalent to the CBR formula (II.80). To do this we will use an important tool, which is the Jacobi identity. It is a general identity on determinants and allows to prove an equivalence between bilinear relations and determinant formulae.

We will see that this Jacobi identity allows to prove on the one hand that the CBR formula (II.80), once restricted to rectangular representations, is equivalent to the Hirota equation (II.101). On the other hand, we will see that the CBR formula is also equivalent to another bilinear relation, which we will call the main identity on co-derivatives.

This will involve the minors of an arbitrary determinant. Let us define

$$\mathcal{D}(k, l; m, n) = \left| (a_{i,j})_{\substack{k \leq i \leq l \\ m \leq j \leq n}} \right|. \quad (\text{II.102})$$

Then the Jacobi identity is the very general statement that for any coefficients $a_{i,j}$ (which are either numbers, or operators commuting with each other),

$$\begin{aligned} \mathcal{D}(1, n; 1, n) \mathcal{D}(2, n-1; 2, n-1) &= \mathcal{D}(1, n-1; 1, n-1) \mathcal{D}(2, n; 2, n) \\ &\quad - \mathcal{D}(1, n-1; 2, n) \mathcal{D}(2, n; 1, n-1). \end{aligned} \quad (\text{II.103})$$

This identity is represented graphically in figure II.5, where the matrix with coefficients $(a_{i,j})$ is represented by a blue square. Its minors are denoted by a square where some lines and columns are grayed-out. If the matrix is of size 2×2 , we can recognize the usual definition of the determinant.

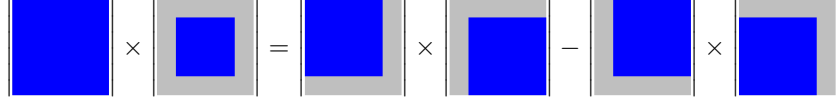

Figure II.5: The Jacobi identity on determinants.

II.1.5.1 CBR determinant formula and Hirota equation

Let us start by illustrating this in the case of Hirota equation: first, we restrict the CBR determinant formula to the rectangular representation $\lambda_{[a,s]}$ defined in (II.78):

$$\mathbb{T}^{a,s}(\mathbf{u}) = \frac{\left| \left(\mathbb{T}^{1,s+i-j}(\mathbf{u} + 1 - i) \right)_{1 \leq i, j \leq a} \right|}{\prod_{k=1}^{a-1} \mathbb{T}^{0,0}(\mathbf{u} - k)}, \quad (\text{II.104})$$

$$\text{i.e. } \frac{\mathbb{T}^{a,s}(\mathbf{u})}{\mathbb{T}^{0,0}(\mathbf{u})} = \left| \left(\frac{\mathbb{T}^{1,s+i-j}(\mathbf{u} + 1 - i)}{\mathbb{T}^{0,0}(\mathbf{u} + 1 - i)} \right)_{1 \leq i, j \leq a} \right|. \quad (\text{II.105})$$

We then choose the coefficients

$$a_{i,j} = \frac{\mathbb{T}^{1,s+i-j}(\mathbf{u} + 1 - i)}{\mathbb{T}^{0,0}(\mathbf{u} + 1 - i)} \quad (\text{II.106})$$

and write the Jacobi identity (II.103) for $n = a + 1$:

$$\frac{\mathbb{T}^{a+1,s}(\mathbf{u})}{\mathbb{T}^{0,0}(\mathbf{u})} \frac{\mathbb{T}^{a-1,s}(\mathbf{u} - 1)}{\mathbb{T}^{0,0}(\mathbf{u} - 1)} = \frac{\mathbb{T}^{a,s}(\mathbf{u})}{\mathbb{T}^{0,0}(\mathbf{u})} \frac{\mathbb{T}^{a,s}(\mathbf{u} - 1)}{\mathbb{T}^{0,0}(\mathbf{u} - 1)} - \frac{\mathbb{T}^{a,s-1}(\mathbf{u})}{\mathbb{T}^{0,0}(\mathbf{u})} \frac{\mathbb{T}^{a,s+1}(\mathbf{u} - 1)}{\mathbb{T}^{0,0}(\mathbf{u} - 1)}. \quad (\text{II.107})$$

This way, we see that the Hirota equation (II.101) is a direct consequence of the CBR determinant formula (II.80) (or actually its restriction (II.104) to rectangular Young diagrams).

Interestingly enough, we can also go the other way round, and show that the Hirota equation (II.101) implies the rectangular CBR formula (II.104), under the condition that $\mathbb{T}^{a,s}(\mathbf{u}) = 0$ if $a < 0$, that $\mathbb{T}^{0,s}(\mathbf{u}) = \mathbb{T}^{0,0}(\mathbf{u})$ is not identically zero, and that the solution is “typical” in a sense which will be explained below. Indeed, if we assume that (II.101) holds, then its restriction to $a = 1$ gives

$$\mathbb{T}^{2,s}(\mathbf{u}) = \frac{\begin{vmatrix} \mathbb{T}^{1,s}(\mathbf{u}) & \mathbb{T}^{1,s-1}(\mathbf{u}) \\ \mathbb{T}^{1,s+1}(\mathbf{u} - 1) & \mathbb{T}^{1,s}(\mathbf{u} - 1) \end{vmatrix}}{\mathbb{T}^{0,0}(\mathbf{u} - 1)}, \quad (\text{II.108})$$

which gives the ($a = 2$) case of the rectangular CBR formula (II.104).

Then one can iteratively express $\mathbb{T}^{a,s}(\mathbf{u})$ for increasing values of a . For instance if we plug the expression (II.108) of $\mathbb{T}^{2,s}(\mathbf{u})$ into the Hirota equation, we get

$$\mathbb{T}^{3,s}(\mathbf{u}) = \frac{\begin{vmatrix} \mathbb{T}^{2,s}(\mathbf{u}) & \mathbb{T}^{2,s-1}(\mathbf{u}) \\ \mathbb{T}^{2,s+1}(\mathbf{u} - 1) & \mathbb{T}^{2,s}(\mathbf{u} - 1) \end{vmatrix}}{\mathbb{T}^{1,s}(\mathbf{u} - 1)} \quad (\text{II.109})$$

if $T^{1,s}(\mathbf{u}-1)$ is non-zero. We can then plug the expression (II.108) to get

$$T^{3,s}(\mathbf{u}) = \frac{\begin{vmatrix} T^{1,s}(\mathbf{u}) & T^{1,s-1}(\mathbf{u}) \\ T^{1,s+1}(\mathbf{u}-1) & T^{1,s}(\mathbf{u}-1) \end{vmatrix} \cdot \begin{vmatrix} T^{1,s}(\mathbf{u}-1) & T^{1,s-1}(\mathbf{u}-1) \\ T^{1,s+1}(\mathbf{u}-2) & T^{1,s}(\mathbf{u}-2) \end{vmatrix}}{T^{1,s}(\mathbf{u}-1)T^{0,0}(\mathbf{u}-1)T^{0,0}(\mathbf{u}-2)} - \frac{\begin{vmatrix} T^{1,s-1}(\mathbf{u}) & T^{1,s-2}(\mathbf{u}) \\ T^{1,s}(\mathbf{u}-1) & T^{1,s-1}(\mathbf{u}-1) \end{vmatrix} \cdot \begin{vmatrix} T^{1,s+1}(\mathbf{u}-1) & T^{1,s}(\mathbf{u}-1) \\ T^{1,s+2}(\mathbf{u}-2) & T^{1,s+1}(\mathbf{u}-2) \end{vmatrix}}{T^{1,s}(\mathbf{u}-1)T^{0,0}(\mathbf{u}-1)T^{0,0}(\mathbf{u}-2)} \quad (\text{II.110})$$

$$= \frac{T^{1,s+1}(\mathbf{u}-2) (T^{1,s-2}(\mathbf{u})T^{1,s+1}(\mathbf{u}-1) - T^{1,s-1}(\mathbf{u}-1)T^{1,s}(\mathbf{u}))}{T^{0,0}(\mathbf{u}-1)T^{0,0}(\mathbf{u}-2)} + \frac{T^{1,s}(\mathbf{u}-2) (T^{1,s}(\mathbf{u}-1)T^{1,s}(\mathbf{u}) - T^{1,s-1}(\mathbf{u})T^{1,s-1}(\mathbf{u}-1))}{T^{0,0}(\mathbf{u}-1)T^{0,0}(\mathbf{u}-2)} + \frac{T^{1,s+2}(\mathbf{u}-2) (T^{1,s-1}(\mathbf{u}-1)T^{1,s-1}(\mathbf{u}) - T^{1,s-2}(\mathbf{u})T^{1,s}(\mathbf{u}-1))}{T^{0,0}(\mathbf{u}-1)T^{0,0}(\mathbf{u}-2)} \quad (\text{II.111})$$

$$= \frac{\begin{vmatrix} T^{1,s}(\mathbf{u}) & T^{1,s-1}(\mathbf{u}) & T^{1,s-2}(\mathbf{u}) \\ T^{1,s+1}(\mathbf{u}-1) & T^{1,s}(\mathbf{u}-1) & T^{1,s-1}(\mathbf{u}-1) \\ T^{1,s+2}(\mathbf{u}-2) & T^{1,s+1}(\mathbf{u}-2) & T^{1,s}(\mathbf{u}-2) \end{vmatrix}}{T^{0,0}(\mathbf{u}-1)T^{0,0}(\mathbf{u}-2)}, \quad (\text{II.112})$$

The equation (II.112) obtained this way is exactly the ($a = 3$) case of the rectangular CBR formula (II.104). The reason why the result coincides with (II.104) is simply that (II.104) satisfies the Hirota equation. Then a simple recurrence shows that if the Hirota equation (II.101) holds, then one gets iteratively the rectangular CBR formula (II.104) when $a \geq 2$. The case $a = 1$ of (II.104) is also trivially true because it reduces to $T^{1,s}(\mathbf{u}) = T^{1,s}(\mathbf{u})$.

This proof that the bilinear equation (II.101) is equivalent to the determinant expression (II.104) holds provided the recurrence sketched above never involves a division by a T -operator which is identically zero. Let us now see how to deal with this constraint: as we will see, a correct statement is that the ‘‘typical’’ solutions of the Hirota equation (II.101) are given by the determinant expression (II.104). In this statement, a ‘‘typical solution’’ of the Hirota equation (II.101) is a solution $T_{(0)}^{a,s}(\mathbf{u})$ of Hirota equation such that, for every small perturbation $T_{(\epsilon)}^{1,s}(\mathbf{u}) = T_{(0)}^{1,s}(\mathbf{u}) + \mathcal{O}(\epsilon)$ of $T_{(0)}^{1,s}(\mathbf{u})$, there exists a solution $T_{(\epsilon)}^{a,s}(\mathbf{u})$ of Hirota equation such that $T_{(0)}^{a,s}(\mathbf{u}) = \lim_{\epsilon \rightarrow 0} T_{(\epsilon)}^{a,s}(\mathbf{u})$ and such that $T_{(\epsilon)}^{a,s}(\mathbf{u}) = 0$ if $a < 0$. I will not enter into the details here, but it is easy to show that for a ‘‘typical solution’’ of the Hirota equation, for every (a, s, \mathbf{u}) one can find a small perturbation $T_{(\epsilon)}^{1,s}(\mathbf{u})$ such that in the vicinity of $\epsilon = 0$, $T^{a-2,s}(\mathbf{u}-1) \neq 0$ and the Hirota equation allows to express $T^{a,s}(\mathbf{u})$ and to proceed with the recurrence.

To conclude this remark about typical solutions, let us give an example of a non-typical solution of Hirota equation:

$$T^{a,s}(\mathbf{u}) = 1 \quad \text{if } (a, s) \in \mathbb{L}(1, 0) \text{ or if } a = 4 \text{ and } s \geq 0, \quad (\text{II.113})$$

$$T^{a,s}(\mathbf{u}) = 0 \quad \text{otherwise.} \quad (\text{II.114})$$

Then one possible choice of perturbation $T_{(\epsilon)}^{1,s}(\mathbf{u})$ is given by

$$T_{(\epsilon)}^{1,s}(\mathbf{u}) = \chi^{(1,s)}(g_{(\epsilon)}) \quad \text{where } g_{(\epsilon)} \equiv \text{diag}(1, \epsilon, \epsilon, \dots, \epsilon) \in \text{GL}(5). \quad (\text{II.115})$$

For this choice of perturbation, if a solution $T_{(\epsilon)}^{a,s}(\mathbf{u})$ exists for all a , then we can show by recurrence (with the arguments above) that for $a \leq 5$, we get

$$T_{(\epsilon)}^{a,s}(\mathbf{u}) = \chi^{(a,s)}(g_{(\epsilon)}), \quad (\text{II.116})$$

and (for $a \leq 5$), this recurrence never involves a division by zero. Then we see that for $s \geq 1$, $\lim_{\epsilon \rightarrow 0} T_{(\epsilon)}^{4,s}(\mathbf{u}) = 0 \neq T^{4,s}(\mathbf{u})$, which proves that the solution (II.113,II.114) of Hirota equation is a non-typical solution, which is why it does not satisfy the CBR determinant formula (II.104).

II.1.5.2 Main identity on co-derivatives

To construct the Q-operators and the Bäcklund flow, we will need a combinatorial identity on co-derivatives, which reads as follows:

$$\begin{aligned} (z_1 - z_n) \mathcal{W}(\mathbf{u} + 1; z_1, \dots, z_n) \cdot \mathcal{W}(\mathbf{u}; z_2, \dots, z_{n-1}) \\ = z_1 \mathcal{W}(\mathbf{u} + 1; z_1, \dots, z_{n-1}) \cdot \mathcal{W}(\mathbf{u}; z_2, \dots, z_n) \\ - z_n \mathcal{W}(\mathbf{u}; z_1, \dots, z_{n-1}) \cdot \mathcal{W}(\mathbf{u} + 1; z_2, \dots, z_n) \end{aligned} \quad (\text{II.117})$$

$$\text{where } \mathcal{W}(\mathbf{u}; z_1, \dots, z_m) \equiv \left[\bigotimes_{i=1}^L (\mathbf{u}_i + \hat{\mathbf{D}}) \quad w(z_1)w(z_{l+1})w(z_{l+2}) \cdots w(z_m) \right], \quad (\text{II.118})$$

where $w(z) \equiv \sum_{s=0}^{\infty} z^s \chi^{(s)}$ is the generating series of symmetric characters. This formula holds for arbitrary $g \in \text{GL}(\mathbb{K}|\mathbb{M})$, $L \geq 0$, $n \geq 2$, $\mathbf{u} \in \mathbb{C}$, $\{\theta_i\} \in \mathbb{C}^L$ and $\{z_i\} \in \mathbb{C}^n$. It generalizes the identity (II.95) to the $n \geq 2$ case.

To prove this identity, let us first use the Jacobi identity to prove that (II.117) is equivalent to the determinant expression

$$\mathcal{W}(\mathbf{u}; z_1, z_2, \dots, z_n) = \frac{1}{\prod_{k=1}^{n-1} \mathcal{W}(\mathbf{u} - k; \emptyset)} \frac{\left| (z_j^{1-k} \mathcal{W}(\mathbf{u} + 1 - k; z_j))_{1 \leq j, k \leq n} \right|}{\Delta(z_1, \dots, z_n)} \quad (\text{II.119})$$

$$\text{where } \mathcal{W}(\mathbf{u}; \emptyset) = \prod_{i=1}^L \mathbf{u}_i \quad \text{and} \quad \Delta(z_a, \dots, z_b) = \left| (z_j^{a-k})_{a \leq j, k \leq b} \right|. \quad (\text{II.120})$$

Proof. This equivalence between (II.119) and (II.117) is proven by the same means as the equivalence between (II.104) and (II.101), and we will just sketch it here.

First, one proves that the determinant (II.119) satisfies the equation (II.117). For this, one writes the Jacobi identity (II.103) for the coefficients $a_{j,k} = z_j^{1-k} \frac{\mathcal{W}(\mathbf{u} + 1 - k; z_j)}{\mathcal{W}(\mathbf{u} + 1 - k; \emptyset)}$. For instance the minor $\mathcal{D}(2, n-1; 2, n-1)$ is equal to $\frac{\mathcal{W}(\mathbf{u}-1; z_2, \dots, z_{n-1})}{\mathcal{W}(\mathbf{u}-1; \emptyset)} \Delta(z_2, \dots, z_{n-1}) / \prod_{j=2}^{n-1} z_j$. By writing carefully all terms of the Jacobi identity, and using the following property of the Vandermonde determinant $\Delta(z_1, \dots, z_n)$:

$$\Delta(z_2, \dots, z_{n-1}) \Delta(z_1, \dots, z_n) = \left(\frac{1}{z_n} - \frac{1}{z_1} \right) \Delta(z_1, \dots, z_{n-1}) \Delta(z_2, \dots, z_n), \quad (\text{II.121})$$

we exactly obtain (II.117).

To finish the proof of the equivalence between (II.117) and (II.119), one proves that (II.117) implies (II.119) by a recurrence over the number n of parameters z_1, \dots, z_n . Indeed, (II.117) allows to express $\mathcal{W}(\mathbf{u}; z_1, z_2, \dots, z_n)$ in terms of $\mathcal{W}(\mathbf{u}; J)$, for different strict subsets J of $\{z_1, z_2, \dots, z_n\}$. Exactly like in (II.110-II.112), one can compute explicit expressions, but it is not necessary, since the Jacobi identity ensures that the outcome will be exactly (II.119). This recurrence completes the proof of the equivalence between (II.117) and (II.119). \square

Now, in order to finish with the proof of (II.117), we just have to prove the determinant expression (II.119). Let us present two different proofs: first a simple proof which reproduces the arguments used in section II.1.4 to prove the CBR formula. The second proof will show that the equality (II.119) itself is actually equivalent to the CBR formula.

First proof of (II.119). A simple way to show this relation is by first checking that the right-hand-side is polynomial, and then by expanding it. This proof is exactly the same as the proof given in section II.1.4 for the CBR formula (II.80), and it relies on the fact that when $\mathbf{u} = \theta_i + k$ (for arbitrary $i \in \llbracket 1, L \rrbracket, k \in \llbracket 1, n-1 \rrbracket$), the minors associated to the lines k and $k+1$ vanish due to the identity (II.84). Then the expansion of the determinant around $\mathbf{u}_i = \infty$ is performed exactly like in (II.98). It gives

$$\begin{aligned} & \frac{1}{\prod_{k=1}^{n-1} \mathcal{W}(\mathbf{u} - k; \emptyset)} \left| \left(z_j^{1-k} \mathcal{W}(\mathbf{u} + 1 - k; z_j) \right)_{1 \leq j, k \leq n} \right| \\ & \quad = \bigotimes_{i=1}^L \left(\mathbf{u}_i + \hat{\mathbf{D}} \right) \frac{\left| \left(z_j^{1-k} w(z_j) \right)_{1 \leq j, k \leq n} \right|}{\Delta(z_1, \dots, z_n)} = \mathcal{W}(\mathbf{u}; z_1, \dots, z_n). \quad \square \quad (\text{II.122}) \end{aligned}$$

Another proof of the main identity on co-derivatives, written in [12KLT], sheds more light into the relation between (II.119) and the CBR formula (II.80). Understanding this proof will also be interesting for further generalizations of this result.

Second proof: Equivalence between (II.119) and (II.80). Let us expand the quantity $\mathcal{W}(\mathbf{u}; z_1, z_2, \dots, z_n) \cdot \Delta(z_1, \dots, z_n)$ in powers of z_1, z_2, \dots, z_n :

$$\begin{aligned} & \mathcal{W}(\mathbf{u}; z_1, z_2, \dots, z_n) \cdot \Delta(z_1, \dots, z_n) \\ & \quad = \bigotimes_{i=1}^L \left(\mathbf{u}_i + \hat{\mathbf{D}} \right) \sum_{\sigma \in \mathcal{S}^n} \sum_{(s_1, s_2, \dots, s_n) \in \mathbb{N}^n} \epsilon(\sigma) \prod_{k=1}^n \chi^{(s_k)}(g) z_k^{s_k + 1 - \sigma(k)} \quad (\text{II.123}) \end{aligned}$$

where $\epsilon(\sigma) \equiv \prod_{i < j} \frac{\sigma(i) - \sigma(j)}{i - j}$ is the signature of the permutation σ . In (II.123), we can see that the coefficient of $\prod_{k=1}^n z_k^{\lambda_k + 1 - k}$ is

$$\begin{aligned} & \bigotimes_{i=1}^L \left(\mathbf{u}_i + \hat{\mathbf{D}} \right) \sum_{\sigma \in \mathcal{S}^n} \epsilon(\sigma) \prod_{k=1}^n \chi^{(\lambda_k + \sigma(k) - k)}(g) \\ & \quad = \bigotimes_{i=1}^L \left(\mathbf{u}_i + \hat{\mathbf{D}} \right) \left| \left(\chi^{(\lambda_k + j - k)}(g) \right)_{1 \leq j, k \leq |\lambda|} \right| = \mathbf{T}^{(\lambda)}(\mathbf{u}). \quad (\text{II.124}) \end{aligned}$$

By comparison, we can expand $\left| (z_j^{1-k} \mathcal{W}(\mathbf{u} + 1 - k; z_j))_{1 \leq j, k \leq n} \right|$, which reads

$$\left| (z_j^{1-k} \mathcal{W}(\mathbf{u} + 1 - k; z_j))_{1 \leq j, k \leq n} \right| = \sum_{\sigma \in \mathcal{S}^n} \sum_{(s_1, s_2, \dots, s_n) \in \mathbb{N}^n} \epsilon(\sigma) \prod_{k=1}^n T^{1, s_k}(\mathbf{u} + 1 - \sigma(k)) z_k^{1 - \sigma(k) + s_k}, \quad (\text{II.125})$$

where the coefficient of $\prod_{k=1}^n z_k^{\lambda_k + 1 - k}$ is

$$\sum_{\sigma \in \mathcal{S}^n} \epsilon(\sigma) \prod_{k=1}^n T^{1, \lambda_k + \sigma(k) - k}(\mathbf{u} + 1 - \sigma(k)) = \left| (T^{1, \lambda_k + j - k}(\mathbf{u} + 1 - \sigma(k)))_{1 \leq j, k \leq |\lambda|} \right|. \quad (\text{II.126})$$

Then we immediately see that the equality (of the coefficient of a given degree in each z_k in) (II.119) is simply equivalent to the CBR formula (II.80), which was already proven earlier in the text. \square

To finish this section, let us note that due to the diagrammatic expressions given in appendix B, the main identity on co-derivatives (II.117) can also be written in the following, slightly stronger form:

$$\begin{aligned} & (z - t) \left[\bigotimes_{i=1}^L (\mathbf{u}_i + 1 + \hat{D}) \quad w(z)w(t)\mathbf{\Pi} \right] \cdot \left[\bigotimes_{i=1}^L (\mathbf{u}_i + \hat{D}) \quad \mathbf{\Pi} \right] \\ &= z \left[\bigotimes_{i=1}^L (\mathbf{u}_i + 1 + \hat{D}) \quad w(z)\mathbf{\Pi} \right] \cdot \left[\bigotimes_{i=1}^L (\mathbf{u}_i + \hat{D}) \quad w(t)\mathbf{\Pi} \right] \\ & \quad - t \left[\bigotimes_{i=1}^L (\mathbf{u}_i + \hat{D}) \quad w(z)\mathbf{\Pi} \right] \cdot \left[\bigotimes_{i=1}^L (\mathbf{u}_i + 1 + \hat{D}) \quad w(t)\mathbf{\Pi} \right], \end{aligned} \quad (\text{II.127})$$

$$\text{where } \mathbf{\Pi} = \prod_{k=1}^n (w(z_k))^{a_k}, \quad (\text{II.128})$$

for n arbitrary pairs of numbers (z_k, a_k) .

Proof. First, if all a_k are equal to 1, then (II.127) is exactly the identity (II.117) written for $\tilde{n} = n + 2$, $\tilde{z}_1 = z$, $\tilde{z}_{\tilde{n}} = t$, and $\tilde{z}_k = z_{k-1}$ for $k = 2, 3, \dots, n + 1$.

Next if all the powers a_k in (II.128) are non-negative integers, then $\mathbf{\Pi}$ can be written as

$$\mathbf{\Pi} = \prod_{k=1}^{\sum a_i} w(\tilde{z}_k) \quad \text{where } \tilde{z}_k \equiv z_{\max\{j \mid \sum_{i \leq j} a_i \leq k\}}. \quad (\text{II.129})$$

Therefore, the case when all the powers a_k are non-negative integer reduces to the case when they are all equal to 1, which reduces to (II.117).

Finally, it is easy to see from the diagrammatic introduced in appendix B that $\frac{1}{w(z)^a} \left[\bigotimes_{i=1}^L (\mathbf{u}_i + \hat{D}) \quad f(g) (w(z)^a) \right]$ is a polynomial in the variable a . As a consequence, if (II.127) holds when the powers a_k are non-negative integer, then it holds for arbitrary powers a_k . \square

II.1.6 Conservation of the number of particles

The CBR formula (II.80) which we have just shown also allows to find simple eigenspaces of all T-operators. To this end it is enough to find some spaces which are stable under all $T^{1,s}(\mathbf{u})$, and the CBR formula (II.80) will then imply that these spaces are stable under all T-operators.

As we have seen for instance in (II.89) (see appendix B.1 for more details), $\mathcal{W}(\mathbf{u}; z) \equiv \sum_{s=0}^{\infty} T^{1,s}(\mathbf{u})z^s$ can be written as a sum of \hat{D} -diagrams. To each \hat{D} -diagram is associated an expression of the form $\mathcal{P}_\sigma \cdot \left(\bigotimes_{i=1}^L \mathcal{O}_i \right)$, where $\sigma \in \mathcal{S}^L$ is a permutation, and \mathcal{O}_i is an operator (equal to either $\frac{1}{1-g}z$, $\frac{g}{1-g}z$ or $\mathbf{u}_i \mathbb{I}$), which commutes with g . As a consequence,

$$\left((f(g))^{\otimes L}, \mathcal{W}(\mathbf{u}; z) \right)_- = 0, \quad (\text{II.130})$$

for any analytic function f .

Proof. First, each operator \mathcal{O}_i is diagonal in the same basis as g (and $f(g)$). That is why $\left((f(g))^{\otimes L}, \left(\bigotimes_{i=1}^L \mathcal{O}_i \right) \right)_- = 0$. Next one sees that $(f(g))^{\otimes L}$ commutes with any permutation operator \mathcal{P}_σ , so that finally it commutes with each $\mathcal{P}_\sigma \cdot \left(\bigotimes_{i=1}^L \mathcal{O}_i \right)$, and with their sum $\mathcal{W}(\mathbf{u}; z)$. \square

If we denote by $(v_j)_{1 \leq j \leq K+M}$ the eigenvectors of the twist g , and by $(x_j)_{1 \leq j \leq K+M}$ the corresponding eigenvalues, then we can notice that

$$(f(g))^{\otimes L} |v_{j_1}, v_{j_2}, \dots, v_{j_L}\rangle = \left(\prod_{i=1}^L f(x_{j_i}) \right) |v_{j_1}, v_{j_2}, \dots, v_{j_L}\rangle. \quad (\text{II.131})$$

For fixed M_1, M_2, \dots, M_{K+M} , we can introduce the sets

$$E_{M_1, M_2, \dots, M_{K+M}} \equiv \text{Vect} \left\{ |v_{j_1}, v_{j_2}, \dots, v_{j_L}\rangle \mid \forall \mathbf{k}, M_{\mathbf{k}} = \sum_{i=1}^L \delta_{j_i, \mathbf{k}} \right\}. \quad (\text{II.132})$$

These spaces are the sets of states having a fixed number $M_{\mathbf{k}}$ of spins pointing in each direction $|v_{\mathbf{k}}\rangle$. In the spirit of the introductory section I.1, they are the sets of states having a fixed number $M_{\mathbf{k}}$ of particles of each type.

One can see that for any state $|\phi\rangle \in E_{M_1, M_2, \dots, M_{K+M}}$,

$$(f(g))^{\otimes L} |\phi\rangle = \prod_{j=1}^{K+M} f(x_j)^{M_j} |\phi\rangle. \quad (\text{II.133})$$

It is also possible to promote the numbers $M_{\mathbf{k}}$ into operators $\mathbf{M}_{\mathbf{k}}$ having eigenvalue $M_{\mathbf{k}}$ on the eigenspace $E_{M_1, M_2, \dots, M_{K+M}}$. Then the operator $(f(g))^{\otimes L}$ is equal to $\prod_{j=1}^{K+M} f(x_j)^{\mathbf{M}_j}$.

The relation (II.130) shows that all T-operators commute with $(f(g))^{\otimes L}$ (in addition to commuting with each other), and if we assume that the eigenvalues x_j are distinct, we can choose some functions $f_{\mathbf{k}}$ such that $f_{\mathbf{k}}(x_j) = 1 + \delta_{j, \mathbf{k}}$, i.e. such that $(f_{\mathbf{k}}(g))^{\otimes L} = 2^{\mathbf{M}_{\mathbf{k}}}$.

In this case we see that the T-operators commute with $2^{\mathbf{M}_k}$ and hence they commute with each \mathbf{M}_k . In other words, the sets $E_{M_1, M_2, \dots, M_{K+M}}$ are therefore stable under all the T-operators.

If the eigenvalues of g are not distinct, one can show that the spaces $E_{M_1, M_2, \dots, M_{K+M}}$ are still stable under all T-operators, provided g is diagonalizable. To show this, we can for instance show that $E_{M_1, M_2, \dots, M_{K+M}}$ is stable under the operator $\mathcal{P}_\sigma \cdot \left(\bigotimes_{i=1}^L \mathcal{O}_i \right)$ associated to each \hat{D} -diagram.

Therefore, we have seen that the spaces $E_{M_1, M_2, \dots, M_{K+M}}$ are stable under all T-operators, i.e. that all the T-operators commute with the operator \mathbf{M}_j . This means that the number of “particles” of each type is invariant under the action of all T-operators, and therefore it is preserved under the action of the Hamiltonian as well.

This remark will be useful in section II.3, because it allows to build some operators which trivially commute with all T-operators (for instance, this will be the case of the operator B_I which we will define in (II.231)).

II.2 Bäcklund transform and Bethe equations

As we saw in the previous section, the “2nd” Weyl character formula (II.81), satisfied by characters (which are the T-operators of a spin chain with length $L = 0$), can be generalized to u -dependent T-operators by introducing the correct shift. This gives the CBR formula (II.80), and we also saw that (for rectangular representations (II.78)), this CBR formula is equivalent to the Hirota equation (II.101), a bilinear equation on T-operators.

In this section and the next section, we will show how to perform the same program for the “1st Weyl formula” below (see appendix A.3.4)

$$\chi_\lambda(g) = \frac{\left| (x_j^{\lambda_i + K - i})_{1 \leq i, j \leq K} \right|}{\left| (x_j^{K - i})_{1 \leq i, j \leq K} \right|}, \quad (\text{II.134})$$

where x_1, x_2, \dots, x_K denote the eigenvalues of $g \in \text{GL}(K)$.

First we will see that this formula gives rise to a bilinear identity on characters of $\text{GL}(K)$ as compared to $\text{GL}(K-1)$. We will see how this bilinear identity generalizes to T-operators (or to their eigenvalues) by adding a dependence on the spectral parameter u [KP92, KN92, KLWZ97, Tsu97]. Then we will see that if this bilinear identity is satisfied, it gives an expression for T-operators, out of which the spectrum of the theory can be obtained. In particular we will obtain some Bethe equations [Zab08, Lai74, Sut75, BdVV82, KR83, KSZ08] which generalize the equations of section I.1. Finally, we will prove in the next section II.3 that these bilinear relations are indeed satisfied by polynomial operators.

In order to do this, we will restrict, from now on, to the case when g is diagonalizable and has distinct non-zero eigenvalues. The eigenvalues of $g \in \text{GL}(K|M)$ will be denoted as $(x_1, x_2, \dots, x_{K+M})$, and they are supposed to be distinct and non-zero. The case when

g is not diagonalizable or when several eigenvalues are equal can in principle be obtained as a limit, but this point will not be discussed much in the present manuscript.

The present section reviews results which were known before the start of the PhD. In this section, we will not use any explicit definition of the T-operators obtained in the previous section, but instead we will consider some T -functions, which are functions of the spectral parameter \mathbf{u} and obey the Hirota equation. We will assume that a polynomial⁷ “Bäcklund flow” exists, which gives rise to so-called Q -functions.

The T -functions and Q -functions will be denoted by slant letters as opposed to the vertical letters for T- and Q-operators. What we will see in the next section II.3 is that some Q-operators can be explicitly constructed and a polynomial Bäcklund flow can be constructed at the level of operators. Then we will be able to identify the Q -functions (and the T -functions) of the present section with the eigenvalues of the Q-operators (and the T-operators). It will then be obvious that writing an equation on the T-operators or on the T -functions is strictly equivalent, because the T -functions are the eigenvalues of the T-operators, which commute with each other. For instance the equation

$$T^{a,s}(\mathbf{u} + 1) T^{a,s}(\mathbf{u}) = T^{a+1,s}(\mathbf{u} + 1) T^{a-1,s}(\mathbf{u}) + T^{a,s-1}(\mathbf{u} + 1) T^{a,s+1}(\mathbf{u}), \quad (\text{II.135})$$

will mean that the eigenvalues of T-operators obey the same Hirota equation as the operators themselves. In (II.135), the symbols like $T^{a,s}(\mathbf{u} + 1)$, $T^{a,s}(\mathbf{u})$ etc. denote the eigenvalues of the operators $T^{a,s}(\mathbf{u} + 1)$, $T^{a,s}(\mathbf{u})$ etc., but these eigenvalues all correspond to the same eigenspace (we use the fact that the T-operators commute with each other, so that they have common eigenstates).

For the moment, we will introduce a “Bäcklund flow”, for some T -functions, which obey the Hirota equation (II.135). For $L > 0$, we will assume (but not prove yet) the existence of this polynomial Bäcklund flow, and we will restrict to results which were known [KLWZ97, Zab96, KSZ08, Zab08] before the start of this PhD, as opposed to the results of the sections II.3 and II.4, which are original results of this thesis [12KLT, 11AKL⁺].

This Bäcklund flow, can for instance be found in [KLWZ97] (for usual matrix groups), in [KSZ08] (for super groups) and in [Zab08] (for twisted super-spin chains), and is the starting point for original works of this PhD [12KLT, 11AKL⁺], including the explicit operatorial constructions of the T- and Q-operators given in the next section II.3.

II.2.1 Introduction of the Bäcklund flow

As written in appendix A.3.4, the characters of the $GL(K)$ group are expressed through the Weyl formula (II.134). The idea behind the Bäcklund flow will be to write this expression for the character of

$$g_I \equiv \text{diag}((x_i)_{i \in I}) \in GL(|I|), \quad \text{where } |I| = \text{Card}\{I\}, \quad (\text{II.136})$$

for an arbitrary subset I of $\llbracket 1, K \rrbracket$. For such a set we will denote

$$\bar{I} \equiv \llbracket 1, K \rrbracket \setminus I, \quad \text{and} \quad \bar{\emptyset} \equiv \llbracket 1, K \rrbracket. \quad (\text{II.137})$$

⁷ We will call “Bäcklund flow” any solution of the equations (II.154, II.155) given in the first subsection II.2.1.

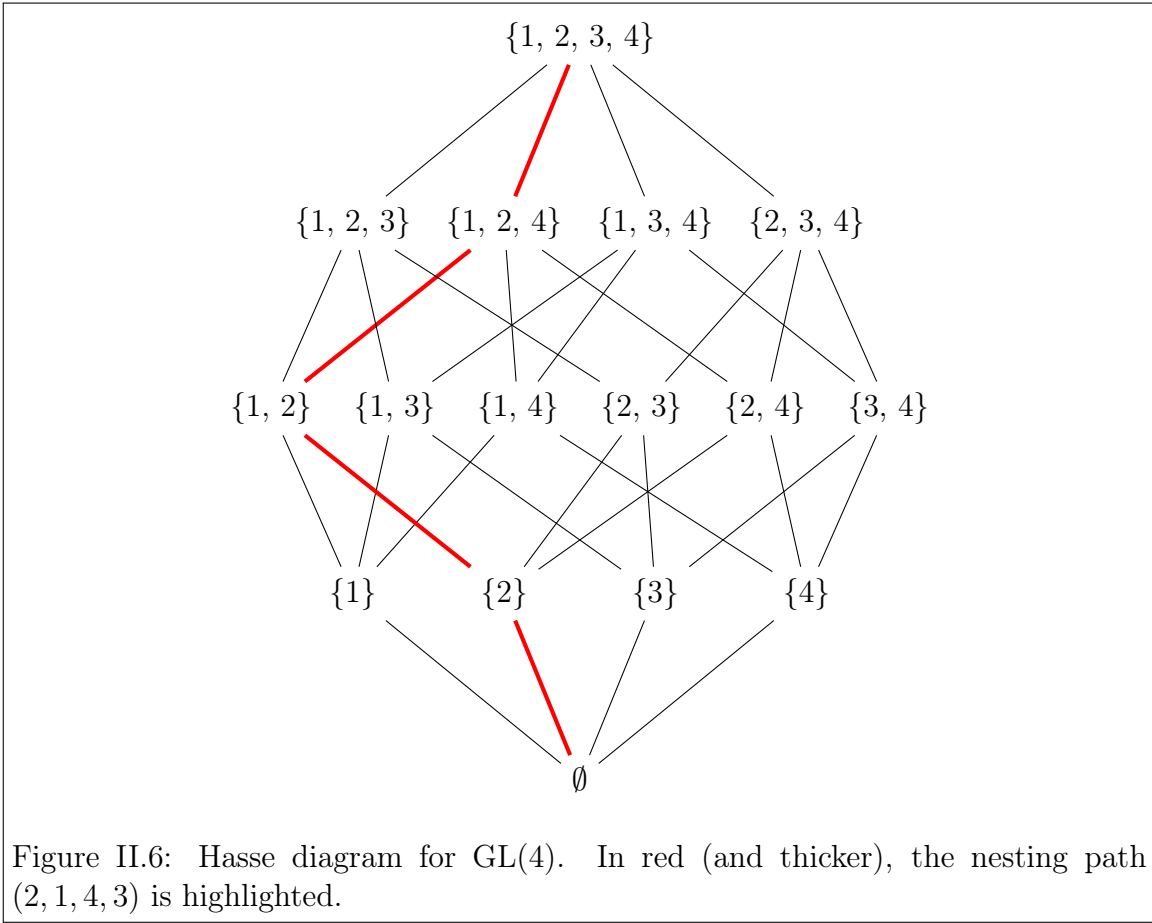

Figure II.6: Hasse diagram for $GL(4)$. In red (and thicker), the nesting path $(2, 1, 4, 3)$ is highlighted.

Given an ordering (i_1, i_2, \dots, i_K) of $\{i_1, i_2, \dots, i_K\} = \llbracket 1, K \rrbracket$, we will be interested in an undressing procedure

$$\begin{array}{ccccccc}
 g_{I_K} & \rightsquigarrow & g_{I_{K-1}} & \rightsquigarrow & g_{I_{K-2}} & \cdots & g_{\emptyset} \\
 \cap & & \cap & & \cap & & \cap \\
 GL(K) & \supset & GL(K-1) & \supset & GL(K-2) & \cdots & \{1\}
 \end{array} \tag{II.138}$$

$$\text{where } I_n \equiv \{i_1, i_2, \dots, i_n\}. \tag{II.139}$$

This procedure gradually decreases the rank of the group, and it is dependent on the ordering (i_1, i_2, \dots, i_K) of the set $\llbracket 1, K \rrbracket$. This ordering, which governs the undressing procedure, will be called a “nesting path”. For a given set $I \subset \llbracket 1, K \rrbracket$, the number $K - |I|$ will be called the “nesting level”. It is the number of steps, in the undressing procedure (II.138), which are needed to reach g_I by starting from $g = g_{\emptyset}$.

The “Hasse diagram” [Tsu10] (see figure II.6) shows all the possible sets $I \subset \bar{\emptyset}$, with lines connecting each set to its subsets. On this diagram, each nesting path is one (out of $K!$) path connecting $\bar{\emptyset} = \llbracket 1, K \rrbracket$ to \emptyset .

For the character $\chi^{(a,s)} \equiv \chi_{\lambda_{[a,s]}}$ associated to rectangular representations, the formula

(II.134) can be written at an arbitrary nesting level and it reads

$$\chi^{(a,s)}(g_I) = \frac{\left| \begin{array}{c} \left(x_{\mathbf{j}}^{s+|I|-i} \right)_{\substack{1 \leq i \leq a \\ \mathbf{j} \in I}} \\ \left(x_{\mathbf{j}}^{|I|-i} \right)_{\substack{a+1 \leq i \leq |I| \\ \mathbf{j} \in I}} \end{array} \right|}{\left| \left(x_{\mathbf{j}}^{|I|-i} \right)_{\substack{1 \leq i \leq |I| \\ \mathbf{j} \in I}} \right|}, \quad (\text{II.140})$$

where the numerator is the determinant of a matrix made of two blocks of respective size $a \times K$ and $(K - a) \times K$. This expression is valid for $0 \leq a \leq |I|$, whereas $\chi_{\lambda_{[a,s]}}(g_I) = 0$ if $a > |I|$.

Writing Plücker identities (a generalization of the Jacobi identity [KLWZ97]) for the determinant (II.140), one gets

$$\left\{ \begin{array}{l} \chi^{(a+1,s)}(g_{I,\mathbf{j}}) \chi^{(a,s)}(g_I) = \chi^{(a,s)}(g_{I,\mathbf{j}}) \chi^{(a+1,s)}(g_I) + x_{\mathbf{j}} \chi^{(a+1,s-1)}(g_{I,\mathbf{j}}) \chi^{(a,s+1)}(g_I), \\ \chi^{(a,s+1)}(g_{I,\mathbf{j}}) \chi^{(a,s)}(g_I) = \chi^{(a,s)}(g_{I,\mathbf{j}}) \chi^{(a,s+1)}(g_I) + x_{\mathbf{j}} \chi^{(a+1,s)}(g_{I,\mathbf{j}}) \chi^{(a-1,s+1)}(g_I), \end{array} \right. \quad (\text{II.141})$$

$$\left\{ \begin{array}{l} \chi^{(a,s+1)}(g_{I,\mathbf{j}}) \chi^{(a,s)}(g_I) = \chi^{(a,s)}(g_{I,\mathbf{j}}) \chi^{(a,s+1)}(g_I) + x_{\mathbf{j}} \chi^{(a+1,s)}(g_{I,\mathbf{j}}) \chi^{(a-1,s+1)}(g_I), \\ \chi^{(a+1,s)}(g_{I,\mathbf{j}}) \chi^{(a,s)}(g_I) = \chi^{(a,s)}(g_{I,\mathbf{j}}) \chi^{(a+1,s)}(g_I) + x_{\mathbf{j}} \chi^{(a+1,s-1)}(g_{I,\mathbf{j}}) \chi^{(a,s+1)}(g_I), \end{array} \right. \quad (\text{II.142})$$

where I, \mathbf{j} denotes the set $I \cup \{\mathbf{j}\}$, for an arbitrary $\mathbf{j} \in \llbracket 1, K \rrbracket \setminus I$.

An interesting particular case of (II.141), when $a = 0$ is the relation

$$\chi^{(s)}(g_I) = \chi^{(s)}(g_{I,\mathbf{j}}) - x_{\mathbf{j}} \chi^{(s-1)}(g_{I,\mathbf{j}}), \quad (\text{II.143})$$

where $\chi^{(s)} \equiv \chi^{(1,s)}$ denotes the character associated to the symmetric representation $\lambda = (s, 0, 0, \dots)$.

If we remember the expression of the generating series (see appendix A.3.4)

$$w_I(z) \equiv \sum_{s \geq 0} z^s \chi^{(s)}(g_I) = \prod_{\mathbf{j} \in I} \frac{1}{1 - x_{\mathbf{j}} z}, \quad (\text{II.144})$$

the relation (II.143) actually reduces to the simple statement that

$$w_I(z) \equiv (1 - x_{\mathbf{j}} z) w_{I,\mathbf{j}}(z). \quad (\text{II.145})$$

The relations (II.141, II.142) are written for the characters of $\text{GL}(K)$. For $\text{GL}(K|M)$, the equations (II.141, II.142) hold provided $(-1)^{p_{\mathbf{j}}} = 1$. Moreover, the generating series (II.144) becomes

$$w_I(z) \equiv \sum_{s \geq 0} z^s \chi^{(s)}(g_I) = \text{Sdet} \left(\frac{1}{1 - g z} \right) = \prod_{\mathbf{j} \in I} (1 - x_{\mathbf{j}} z)^{(-1)^{p_{\mathbf{j}}}} \quad (\text{II.146})$$

where $\text{Sdet} \left(\frac{1}{1-g z} \right)$ is the super-determinant of $\frac{1}{1-g z}$ (see appendix A.4).

The generalization of (II.143) is then

$$\chi^{(s)}(g_I) = \chi^{(s)}(g_{I\Delta\mathbf{j}}) - x_{\mathbf{j}} \chi^{(s-1)}(g_{I\Delta\mathbf{j}}). \quad (\text{II.147})$$

$$\text{where } I \subset \llbracket 1, K + M \rrbracket \text{ and } \begin{cases} (-1)^{p_{\mathbf{j}}} = +1, & \mathbf{j} \notin I \quad \text{and} \quad I\Delta\mathbf{j} \equiv I \cup \{\mathbf{j}\} \\ \text{or} \\ (-1)^{p_{\mathbf{j}}} = -1, & \mathbf{j} \in I \quad \text{and} \quad I\Delta\mathbf{j} \equiv I \setminus \{\mathbf{j}\} \end{cases} \quad (\text{II.148})$$

For these super-groups, the undressing procedure (along a given nesting path $(\mathbf{i}_1, \mathbf{i}_2, \dots, \mathbf{i}_{K+M})$) can become for instance

$$\begin{array}{ccccccc} g_{I_{K+M}} & \rightsquigarrow & g_{I_{K+M-1}} & \rightsquigarrow & g_{I_{K+M-2}} & \cdots & g_\emptyset \\ \cap & & \cap & & \cap & & \cap \\ \text{GL}(K|M) & \supset & \text{GL}(K-1|M) & \supset & \text{GL}(K-1|M-1) & \cdots & \{1\} \end{array} \quad (\text{II.149})$$

$$\text{where } I_{\mathbf{n}} \equiv \{\mathbf{i}_1, \mathbf{i}_2, \dots, \mathbf{i}_{\mathbf{n}}\}. \quad (\text{II.150})$$

At every step, either K or M is decreased by one, and (II.149) involves the inclusions $\text{GL}(K|M) \supset \text{GL}(K-1|M) \supset \text{GL}(K-1|M-1)$ which correspond to the case $(-1)^{p_{i_{K+M}}} = 1$ and $(-1)^{p_{i_{K+M-1}}} = -1$.

We will also call nesting level (associated to a set $I \subset \llbracket 1, K+M \rrbracket$) the integer $K+M-|I|$, which is the number of steps necessary to reach g_I from $g = g_\emptyset$ following the procedure (II.149). We also define the complement of a set (as a generalization of (II.137)) by

$$\bar{I} \equiv \llbracket 1, K+M \rrbracket \setminus I, \quad \text{and} \quad \bar{\emptyset} \equiv \llbracket 1, K+M \rrbracket. \quad (\text{II.151})$$

In (II.147), we see that the case $(-1)^{p_j} = 1$ corresponds to the transformation $\text{GL}(k|m) \rightsquigarrow \text{GL}(k-1|m)$, where $\text{GL}(k-1|m)$ corresponds to I on the left-hand-side and $\text{GL}(k|m)$ corresponds to $I\Delta\mathbf{j} \equiv I \cup \{\mathbf{j}\}$ on the right-hand-side. By contrast, the case $(-1)^{p_j} = -1$ corresponds to the transformation $\text{GL}(k|m) \rightsquigarrow \text{GL}(k|m-1)$, where $\text{GL}(k|m)$ corresponds to I on the left-hand-side and $\text{GL}(k|m-1) \rightsquigarrow$ corresponds to $I\Delta\mathbf{j} \equiv I \setminus \{\mathbf{j}\}$ on the right-hand-side.

With the notations (II.148), the generalization of (II.141, II.142) to super-groups is simply

$$\left\{ \begin{array}{l} \chi^{(a+1,s)}(g_{I\Delta\mathbf{j}}) \chi^{(a,s)}(g_I) = \chi^{(a,s)}(g_{I\Delta\mathbf{j}}) \chi^{(a+1,s)}(g_I) \\ \qquad \qquad \qquad \qquad \qquad \qquad + x_j \chi^{(a+1,s-1)}(g_{I\Delta\mathbf{j}}) \chi^{(a,s+1)}(g_I), \quad (\text{II.152}) \\ \chi^{(a,s+1)}(g_{I\Delta\mathbf{j}}) \chi^{(a,s)}(g_I) = \chi^{(a,s)}(g_{I\Delta\mathbf{j}}) \chi^{(a,s+1)}(g_I) \\ \qquad \qquad \qquad \qquad \qquad \qquad + x_j \chi^{(a+1,s)}(g_{I\Delta\mathbf{j}}) \chi^{(a-1,s+1)}(g_I). \quad (\text{II.153}) \end{array} \right.$$

We have already shown that the T -functions, which depend non-trivially on the spectral parameter \mathbf{u} , generalize characters in a way which satisfies the Hirota equation (II.101). We should therefore generalize (II.152, II.153) in a way which is consistent with this Hirota equation.

The correct generalization of (II.152, II.153) is then [KLWZ97, Zab96, KSZ08, Zab08]

$$\left\{ \begin{array}{l} T_{I\Delta\mathbf{j}}^{a+1,s}(\mathbf{u}) T_I^{a,s}(\mathbf{u}) - T_{I\Delta\mathbf{j}}^{a,s}(\mathbf{u}) T_I^{a+1,s}(\mathbf{u}) = x_j T_{I\Delta\mathbf{j}}^{a+1,s-1}(\mathbf{u}+1) T_I^{a,s+1}(\mathbf{u}-1), \quad (\text{II.154}) \\ T_{I\Delta\mathbf{j}}^{a,s+1}(\mathbf{u}) T_I^{a,s}(\mathbf{u}) - T_{I\Delta\mathbf{j}}^{a,s}(\mathbf{u}) T_I^{a,s+1}(\mathbf{u}) = x_j T_{I\Delta\mathbf{j}}^{a+1,s}(\mathbf{u}+1) T_I^{a-1,s+1}(\mathbf{u}-1), \quad (\text{II.155}) \end{array} \right.$$

where the ‘‘nested T -functions’’ $T_I^{a,s}(\mathbf{u})$ (defined by this equation) generalize the characters $\chi^{(a,s)}(g_I)$.

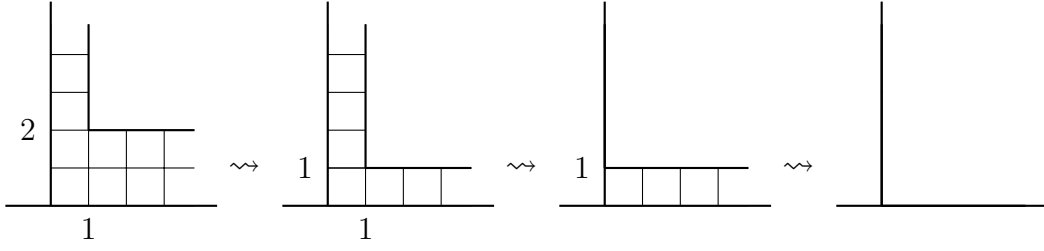

Figure II.7: Bäcklund flow for a nesting path of $GL(2|1)$. This shows the successive (a, s) -lattices for a nesting path corresponding to $GL(2|1) \supset GL(1|1) \supset GL(1) \supset \{1\}$, as in (II.149).

In the case $(-1)^{p_j} = +1$ (corresponding to a transformation $GL(k|m) \rightsquigarrow GL(k-1|m)$), we will say that if we know a function $T_{I\Delta\mathbf{j}}^{a,s}(\mathbf{u}) = T_{I,\mathbf{j}}^{a,s}(\mathbf{u})$ (where $I \not\supset \mathbf{j}$ and $I, \mathbf{j} \equiv I \cup \{\mathbf{j}\}$) which satisfies the Hirota equation (II.101), then any solution $T_I^{a,s}(\mathbf{u})$ of (II.154, II.155) is a “Bäcklund transformed” of $T_{I,\mathbf{j}}^{a,s}(\mathbf{u})$.

On the other hand, in the case $(-1)^{p_j} = -1$ (which corresponds to a transformation $GL(k|m) \rightsquigarrow GL(k|m-1)$), we will say that if we know a function $T_J^{a,s}(\mathbf{u}) \equiv T_{I,\mathbf{j}}^{a,s}(\mathbf{u})$ (where $I \not\supset \mathbf{j}$ and $J \equiv I, \mathbf{j} \equiv I \cup \{\mathbf{j}\}$) which satisfies the Hirota equation (II.101), then any solution $T_{J\Delta\mathbf{j}}^{a,s}(\mathbf{u}) = T_I^{a,s}(\mathbf{u})$ of (II.154, II.155) is a “Bäcklund transformed” of $T_{I,\mathbf{j}}^{a,s}(\mathbf{u})$.

In [Zab08], (where the function $T_{\{1,2,\dots,k,K+1,K+2,K+m\}}^{a,s}(\mathbf{u})$ is denoted as $T_{k,m}(a, s, s - a + 2\mathbf{u})$), it is shown that if these Bäcklund transforms exist, then

- If the function $T_{I,\mathbf{j}}^{a,s}(\mathbf{u})$ satisfies the Hirota equation, then its Bäcklund transformed also satisfies Hirota equation. Symmetrically, if the Bäcklund transformed $T_I^{a,s}(\mathbf{u})$ of a function $T_{I,\mathbf{j}}^{a,s}(\mathbf{u})$ satisfies the Hirota equation, then $T_{I,\mathbf{j}}^{a,s}(\mathbf{u})$ also satisfies the Hirota equation.
- If $T_{I\Delta\mathbf{j}}^{a,s}(\mathbf{u})$ is zero outside $\mathbb{L}(k, m)$ (defined by (II.79)), then one can show that $T_I^{a,s}(\mathbf{u})$ is zero outside $\mathbb{L}(k', m')$, where

$$\begin{cases} k' = k - 1 \\ m' = m \end{cases} \quad \text{or} \quad \begin{cases} k' = k \\ m' = m + 1 \end{cases} \quad (\text{II.156})$$

We will be interested in solutions of (II.154, II.155) such that $k' = k - 1$ and $m' = m$ if $(-1)^{p_j} = 1$, whereas $k' = k$ and $m' = m + 1$ if $(-1)^{p_j} = -1$. Then the Bäcklund transformed of a T -function lives in a “fat hook” with one less row (if $(-1)^{p_j} = 1$) or one less column (if $(-1)^{p_j} = -1$) than the original T -function (see figure II.7).

For the characters this statement about the size of the “fat hook” is trivial, but for the T -functions, it is an important statement which is not completely obvious because we do not use any explicit expression of the T -functions, but simply the fact that $T_{\emptyset}^{a,s}(\mathbf{u})$ obeys the Hirota equation on the “fat hook” $\mathbb{L}(K, M)$.

This statement about the size of the “fat hook” justifies that, for the T -functions, the Bäcklund flow can be interpreted as the sequence of inclusions (II.149).

This Bäcklund flow is then often called “undressing procedure”: from a solution of Hirota on a given lattice $\mathbb{L}(k, m)$, it produces a solution of Hirota on a smaller and

smaller lattice. On the last step, the lattice $\mathbb{L}(0, 0)$ is trivial and the T -function $T_\emptyset^{a,s}(\mathbf{u})$ is a constant (independent of \mathbf{u} , a , and s) inside $\mathbb{L}(0, 0)$.

In the section II.3 we will see how to explicitly construct the $T_I^{a,s}(\mathbf{u})$ for all I , and we will check that they are polynomial and satisfy the Hirota equation. Before this construction is presented, let us now see how it will be used: the “dressing procedure” will allow to recover the spectrum of T -operators from the existence of this polynomial Bäcklund flow.

II.2.2 Bethe equations and energy spectrum

In this section, we will assume that for all subsets $I \subset \llbracket 1, K + M \rrbracket$, the T -functions satisfying (II.154, II.155) are polynomial functions of the spectral parameter \mathbf{u} . We can then define some Q -functions, which are T -functions associated to empty Young diagrams:

$$\boxed{Q_I(\mathbf{u}) \equiv T_I^{0,0}(\mathbf{u})}. \quad (\text{II.157})$$

This defines 2^{K+M} different Q -functions, which are all polynomial in the spectral parameter \mathbf{u} .

We will also assume that the function $Q_\emptyset(\mathbf{u})$ is independent of \mathbf{u} (see also section III.2 for an interpretation of this constraint in terms a physical gauge).

We will show that under these hypotheses, we will be able to recover the Bethe equations (derived in section I.1 in the case of the $\text{XXX}_{1/2}$ Heisenberg spin chain), and to express the spectrum of the model.

In the next section II.3, we will construct an explicit realization of this Bäcklund flow, and prove that the polynomiality condition is satisfied (and that $Q_\emptyset(\mathbf{u})$ is independent of \mathbf{u}).

II.2.2.1 “Dressing” procedure and Q -functions

For characters, we noticed that the relation (II.147) was tightly connected to the expression (II.146) of the generating series of symmetric characters. Let us now generalize this to T -functions: the restriction of (II.154) to $a = 0$ reads

$$T_{I\Delta j}^{1,s}(\mathbf{u}) Q_I(\mathbf{u}) - Q_{I\Delta j}(\mathbf{u}) T_I^{1,s}(\mathbf{u}) = x_j T_{I\Delta j}^{1,s-1}(\mathbf{u} + 1) Q_I(\mathbf{u} - 1), \quad (\text{II.158})$$

which will be called the “ TQ -relation”. It can be rewritten in terms of a generating series if we define

$$\boxed{\mathcal{W}_I(\mathbf{u}; z) \equiv \sum_{s=0}^{\infty} z^s T_I^{1,s}(\mathbf{u})}. \quad (\text{II.159})$$

Then, the equation (II.158) is equivalent to

$$\mathcal{W}_{I\Delta j}(\mathbf{u}; z) Q_I(\mathbf{u}) - \mathcal{W}_I(\mathbf{u}; z) Q_{I\Delta j}(\mathbf{u}) = x_j z \mathcal{W}_{I\Delta j}(\mathbf{u} + 1; z) Q_I(\mathbf{u} - 1), \quad (\text{II.160})$$

or equivalently

$$\mathcal{W}_I(\mathbf{u}; z) = \frac{Q_I(\mathbf{u})}{Q_{I\Delta\mathbf{j}}(\mathbf{u})} \left(1 - x_j z \frac{Q_I(\mathbf{u}-1)}{Q_I(\mathbf{u})} e^{\partial_{\mathbf{u}}^j} \right) \mathcal{W}_{I\Delta\mathbf{j}}(\mathbf{u}; z), \quad (\text{II.161})$$

where the operator $e^{\partial_{\mathbf{u}}}$ is defined by

$$[e^{\partial_{\mathbf{u}}} f(\mathbf{u})] = \sum_{n=0}^{\infty} \left[\frac{\partial_{\mathbf{u}}^n}{n!} f(\mathbf{u}) \right] = f(\mathbf{u} + 1). \quad (\text{II.162})$$

We see that

$$\left[e^{\partial_{\mathbf{u}}} f(\mathbf{u}) \tilde{f}(\mathbf{u}) \right] = f(\mathbf{u} + 1) \tilde{f}(\mathbf{u} + 1) = f(\mathbf{u} + 1) \left[e^{\partial_{\mathbf{u}}} \tilde{f}(\mathbf{u}) \right] \quad (\text{II.163})$$

so that $e^{\partial_{\mathbf{u}}}$ actually obeys the rule

$$e^{\partial_{\mathbf{u}}} f(\mathbf{u}) = f(\mathbf{u} + 1) e^{\partial_{\mathbf{u}}}. \quad (\text{II.164})$$

If we recall the definition (II.148) of $I\Delta\mathbf{j}$, (II.160) can be rewritten as

$$\mathcal{W}_{I,\mathbf{j}}(\mathbf{u}; z) = \mathcal{O}_I(\mathbf{j}) \mathcal{W}_I(\mathbf{u}; z) \quad (\text{II.165})$$

$$\text{where } \mathcal{O}_I(\mathbf{j}) = \begin{cases} \left(1 - x_j z \frac{Q_I(\mathbf{u}-1)}{Q_I(\mathbf{u})} e^{\partial_{\mathbf{u}}^j} \right)^{-1} \frac{Q_{I,\mathbf{j}}(\mathbf{u})}{Q_I(\mathbf{u})} & \text{if } (-1)^{p_j} = 1 \\ \frac{Q_{I,\mathbf{j}}(\mathbf{u})}{Q_I(\mathbf{u})} \left(1 - x_j z \frac{Q_{I,\mathbf{j}}(\mathbf{u}-1)}{Q_{I,\mathbf{j}}(\mathbf{u})} e^{\partial_{\mathbf{u}}^j} \right) & \text{if } (-1)^{p_j} = -1 \end{cases}. \quad (\text{II.166})$$

In the case $(-1)^{p_j} = -1$, this expression is obtained from (II.160) by the substitution $I \rightarrow I'$, \mathbf{j} and $I\Delta\mathbf{j} \rightarrow I'$. In (II.166), the operator $\left(1 - x_j z \frac{Q_I(\mathbf{u}-1)}{Q_I(\mathbf{u})} e^{\partial_{\mathbf{u}}^j} \right)^{-1} \frac{Q_{I,\mathbf{j}}(\mathbf{u})}{Q_I(\mathbf{u})}$ is defined by

$$\left(1 - x_j z \frac{Q_I(\mathbf{u}-1)}{Q_I(\mathbf{u})} e^{\partial_{\mathbf{u}}^j} \right)^{-1} \frac{Q_{I,\mathbf{j}}(\mathbf{u})}{Q_I(\mathbf{u})} \equiv \sum_{n=0}^{\infty} \left(x_j z \frac{Q_I(\mathbf{u}-1)}{Q_I(\mathbf{u})} e^{\partial_{\mathbf{u}}^j} \right)^n \frac{Q_{I,\mathbf{j}}(\mathbf{u})}{Q_I(\mathbf{u})} \quad (\text{II.167})$$

$$= \sum_{n=0}^{\infty} \frac{Q_I(\mathbf{u}-1)}{Q_I(\mathbf{u}+n-1)} \frac{Q_{I,\mathbf{j}}(\mathbf{u}+n)}{Q_I(\mathbf{u}+n)} (x_j z e^{\partial_{\mathbf{u}}^j})^n. \quad (\text{II.168})$$

As it was already said, the T -functions associated to the set I are non-zero only inside the lattice $\mathbb{L}(k_I, m_I)$ where k_I and m_I denote the number of elements of I with gradings $+1$ and -1 :

$$k_I = \text{Card}\{\mathbf{i} \in I | (-1)^{p_i} = 1\} \quad m_I = \text{Card}\{\mathbf{i} \in I | (-1)^{p_i} = -1\}. \quad (\text{II.169})$$

In particular, we see that $\forall s \geq 1$, $T_{\emptyset}^{1,s}(\mathbf{u}) = 0$, so that the definition (II.159) gives $\mathcal{W}_{\emptyset}(\mathbf{u}; z) = Q_{\emptyset}(\mathbf{u})$. Therefore, the T -functions $T_I^{1,s}(\mathbf{u})$ can be reconstructed from (II.165) by choosing a nesting path i.e. an ordering of the elements of $I = \{\mathbf{i}_1, \mathbf{i}_2, \dots, \mathbf{i}_{|I|}\}$:

$$\boxed{\mathcal{W}_I(\mathbf{u}; z) = \mathcal{O}_{I_{|I|-1}}(\mathbf{i}_{|I|}) \cdot \mathcal{O}_{I_{|I|-2}}(\mathbf{i}_{|I|-1}) \cdots \mathcal{O}_{I_0}(\mathbf{i}_1) Q_{\emptyset}(\mathbf{u})} \quad (\text{II.170})$$

$$\text{where } I_n \equiv \{\mathbf{i}_1, \mathbf{i}_2, \dots, \mathbf{i}_n\} \quad \text{and } I_0 = \emptyset. \quad (\text{II.171})$$

This expression provides a “dressing procedure”, in the sense that it gives an expression of $\mathcal{W}_I(\mathbf{u}; z) = \sum T_I^{1,s}(\mathbf{u}) z^s$ (hence it also gives an expression of $T_I^{1,s}(\mathbf{u})$) in terms of the Q -functions $Q_{I'}(\mathbf{u})$ associated to subsets $I' \subset I$ (which were defined through the “undressing procedure”). To recover the T -functions associated to an arbitrary representation λ , one should simply use the Cherednik-Bazhanov-Reshetikhin formula (II.80) (we will do it in section II.3.2.3).

Let us now see how this “dressing procedure” allows to recover the Bethe equations and the spectrum of our spin chain, under the assumption that Q -functions are polynomial functions of the variable \mathbf{u} .

II.2.2.2 QQ -relations

In the dressing procedure above, the choice of the nesting path is arbitrary, whereas the expression of $\mathcal{W}_I(\mathbf{u}; z)$ should not depend on the path. We will show that in order to make $\mathcal{W}_I(\mathbf{u}; z)$ independent of the path, a consistency condition called “ QQ -relation” has to hold. For that purpose, let us write (II.170) for the two nesting paths $(\mathbf{i}_1, \mathbf{i}_2, \dots, \mathbf{i}_n, \mathbf{j}, \mathbf{k})$ and $(\mathbf{i}_1, \mathbf{i}_2, \dots, \mathbf{i}_n, \mathbf{k}, \mathbf{j})$ of the set $I, \mathbf{j}, \mathbf{k}$ (where $I = \{\mathbf{i}_1, \mathbf{i}_2, \dots, \mathbf{i}_n\}$). For these paths, the relation (II.170) gives

$$\mathcal{W}_{I,\mathbf{j},\mathbf{k}}(\mathbf{u}; z) = \mathcal{O}_{I,\mathbf{j}}(\mathbf{k}) \cdot \mathcal{O}_I(\mathbf{j}) \cdot \mathcal{W}_I(\mathbf{u}; z) = \mathcal{O}_{I,\mathbf{k}}(\mathbf{j}) \cdot \mathcal{O}_I(\mathbf{k}) \cdot \mathcal{W}_I(\mathbf{u}; z), \quad (\text{II.172})$$

which gives the consistency constraint:

$$\mathcal{O}_{I,\mathbf{j}}(\mathbf{k}) \cdot \mathcal{O}_I(\mathbf{j}) = \mathcal{O}_{I,\mathbf{k}}(\mathbf{j}) \cdot \mathcal{O}_I(\mathbf{k}). \quad (\text{II.173})$$

Let us show how to write a constraint on Q -functions from the equation (II.173). For simplicity let us start with the case $(-1)^{p_{\mathbf{j}}} = (-1)^{p_{\mathbf{k}}} = 1$. Then (II.173) implies

$$\mathcal{O}_I(\mathbf{k})^{-1} \cdot \mathcal{O}_{I,\mathbf{k}}(\mathbf{j})^{-1} = \mathcal{O}_I(\mathbf{j})^{-1} \cdot \mathcal{O}_{I,\mathbf{j}}(\mathbf{k})^{-1}. \quad (\text{II.174})$$

If we plug the expression (II.166) into (II.174), we get

$$\frac{Q_I(\mathbf{u})}{Q_{I,\mathbf{k}}(\mathbf{u})} \left(1 - x_{\mathbf{k}} z \frac{Q_I(\mathbf{u}-1)}{Q_I(\mathbf{u})} e^{\partial_{\mathbf{u}}} \right) \frac{Q_{I,\mathbf{k}}(\mathbf{u})}{Q_{I,\mathbf{j},\mathbf{k}}(\mathbf{u})} \left(1 - x_{\mathbf{j}} z \frac{Q_{I,\mathbf{k}}(\mathbf{u}-1)}{Q_{I,\mathbf{k}}(\mathbf{u})} e^{\partial_{\mathbf{u}}} \right) - \mathbf{j} \leftrightarrow \mathbf{k} = 0, \quad (\text{II.175})$$

where $f(\mathbf{j}, \mathbf{k}) - \mathbf{j} \leftrightarrow \mathbf{k}$ denotes $f(\mathbf{j}, \mathbf{k}) - f(\mathbf{k}, \mathbf{j})$. The term of degree 0 in z is $\frac{Q_I(\mathbf{u})}{Q_{I,\mathbf{j},\mathbf{k}}(\mathbf{u})} - \mathbf{j} \leftrightarrow \mathbf{k}$, which is trivially zero. The term of degree 2 in z is $z^2 x_{\mathbf{j}} x_{\mathbf{k}} \frac{Q_I(\mathbf{u}-1)}{Q_{I,\mathbf{j},\mathbf{k}}(\mathbf{u}+1)} - \mathbf{j} \leftrightarrow \mathbf{k}$, which is also trivially zero. Therefore, (II.173) reduces to

$$\left(x_{\mathbf{j}} \frac{Q_I(\mathbf{u}) Q_{I,\mathbf{k}}(\mathbf{u}-1)}{Q_{I,\mathbf{j},\mathbf{k}}(\mathbf{u}) Q_{I,\mathbf{k}}(\mathbf{u})} + x_{\mathbf{k}} \frac{Q_I(\mathbf{u}-1) Q_{I,\mathbf{k}}(\mathbf{u}+1)}{Q_{I,\mathbf{j},\mathbf{k}}(\mathbf{u}+1) Q_{I,\mathbf{k}}(\mathbf{u})} - \mathbf{j} \leftrightarrow \mathbf{k} \right) z e^{\partial_{\mathbf{u}}} = 0. \quad (\text{II.176})$$

After division by $z e^{\partial_{\mathbf{u}}}$, and multiplication by $Q_{I,\mathbf{j},\mathbf{k}}(\mathbf{u}) Q_{I,\mathbf{j},\mathbf{k}}(\mathbf{u}+1) Q_{I,\mathbf{k}}(\mathbf{u}) Q_{I,\mathbf{j}}(\mathbf{u})$, this equation can be written in terms of 2×2 determinants:

$$\begin{aligned} & Q_{I,\mathbf{j},\mathbf{k}}(\mathbf{u}+1) Q_I(\mathbf{u}) \begin{vmatrix} x_{\mathbf{j}} Q_{I,\mathbf{j}}(\mathbf{u}) & x_{\mathbf{k}} Q_{I,\mathbf{k}}(\mathbf{u}) \\ Q_{I,\mathbf{j}}(\mathbf{u}-1) & Q_{I,\mathbf{k}}(\mathbf{u}-1) \end{vmatrix} \\ &= Q_{I,\mathbf{j},\mathbf{k}}(\mathbf{u}) Q_I(\mathbf{u}-1) \begin{vmatrix} x_{\mathbf{j}} Q_{I,\mathbf{j}}(\mathbf{u}+1) & x_{\mathbf{k}} Q_{I,\mathbf{k}}(\mathbf{u}+1) \\ Q_{I,\mathbf{j}}(\mathbf{u}) & Q_{I,\mathbf{k}}(\mathbf{u}) \end{vmatrix}. \end{aligned} \quad (\text{II.177})$$

This is equivalent to

$$\mathcal{A}(\mathbf{u} + 1) = \mathcal{A}(\mathbf{u}) \quad (\text{II.178})$$

$$\text{where } \mathcal{A}(\mathbf{u}) = \left| \begin{array}{cc} x_j Q_{I,j}(\mathbf{u}) & x_k Q_{I,k}(\mathbf{u}) \\ Q_{I,j}(\mathbf{u} - 1) & Q_{I,k}(\mathbf{u} - 1) \end{array} \right| / (Q_{I,j,k}(\mathbf{u}) Q_I(\mathbf{u} - 1)) . \quad (\text{II.179})$$

Due to the polynomiality of Q -functions, \mathcal{A} is then a constant. The value of this constant can be viewed as a normalization, because the equations (II.154, II.155) are invariant under the transformation

$$Q_I(\mathbf{u}) \rightsquigarrow_{c_I} Q_I(\mathbf{u}) , \quad T_I^{a,s}(\mathbf{u}) \rightsquigarrow_{c_I} T_I^{a,s}(\mathbf{u}) , \quad (\text{II.180})$$

where c_I is independent of a , s , and \mathbf{u} (it is only a function of I). For instance, the freedom (II.180) can be used to enforce that the coefficient of highest degree in $Q_I(\mathbf{u})$ is equal to one. With this choice, (II.179) becomes the following “ QQ -relation”:

$$Q_{I,j,k}(\mathbf{u}) Q_I(\mathbf{u} - 1) = \left| \begin{array}{cc} x_j Q_{I,j}(\mathbf{u}) & x_k Q_{I,k}(\mathbf{u}) \\ Q_{I,j}(\mathbf{u} - 1) & Q_{I,k}(\mathbf{u} - 1) \end{array} \right| / (x_j - x_k) .$$

if $(-1)^{p_j} = (-1)^{p_k} = 1$. (II.181)

If $(-1)^{p_j}$ or $(-1)^{p_k}$ is equal to -1 , then one can repeat this chain of arguments for all possible values of $(-1)^{p_j}$ and $(-1)^{p_k}$. This way, we get a generalization of (II.181) to arbitrary grading which reads (with the notations (II.148)):

$$\boxed{Q_{I\Delta j\Delta k}(\mathbf{u}) Q_I(\mathbf{u} - 1) = \left| \begin{array}{cc} x_j Q_{I\Delta j}(\mathbf{u}) & x_k Q_{I\Delta k}(\mathbf{u}) \\ Q_{I\Delta j}(\mathbf{u} - 1) & Q_{I\Delta k}(\mathbf{u} - 1) \end{array} \right| / (x_j - x_k)} . \quad (\text{II.182})$$

This is very natural because we can see from (II.160) that the effect of gradings can be encoded into the notation $I\Delta\mathbf{j}$, which adds the element \mathbf{j} if $(-1)^{p_j} = 1$ or removes it if $(-1)^{p_j} = -1$.

In this section, QQ -relations were derived as a consistency condition for (II.170). They were obtained by asking that the generating series $\mathcal{W}_I(\mathbf{u}; z)$ is the same for two specific different nesting paths (where only the last two indices are interchanged).

Actually, the QQ -relations even imply that the generating series $\mathcal{W}_I(\mathbf{u}; z)$ is the same for two arbitrary nesting paths $(\mathbf{i}_1, \mathbf{i}_2, \dots, \mathbf{i}_n)$ and $(\mathbf{i}_{\sigma(1)}, \mathbf{i}_{\sigma(2)}, \dots, \mathbf{i}_{\sigma(n)})$. Indeed, the permutation σ can be written as a product of transpositions of the form $\tau_{[n, n+1]}$ (defined in (I.3)). As the arguments above ensure that $\mathcal{W}_I(\mathbf{u}; z)$ is invariant under the change of path associated to each $\tau_{[n, n+1]}$, they imply that $\mathcal{W}_I(\mathbf{u}; z)$ is indeed the same for two arbitrary nesting paths.

II.2.2.3 Bethe equations

Now we can show how to find the Q -functions which have to be plugged into the operators $\mathcal{O}_I(\mathbf{i})$ in the right-hand-side of (II.170). We will find a set of equations on these Q -functions (called the Bethe equations) [Lai74, Sut75, KR83, BdVV82] such that, if we find a solution of these equations, we will be able to plug it into the right-hand-side of

(II.170) and to write a consistent (i.e. polynomial) expression for the T -functions. In particular we will see that for $K = 2$, we find the same Bethe equation as the equation (I.24), which was obtained in the introductory section I.1 for the $XXX_{1/2}$ Heisenberg spin chain.

To show this, we will assume that Q -functions are polynomials. Let us then denote by $\mathbf{u}_I^{(n)}$ their roots, which we will call ‘‘Bethe roots’’:

$$Q_I(\mathbf{u}) = \alpha_I \prod_{n=1}^{d_I} (\mathbf{u} - \mathbf{u}_I^{(n)}) . \quad (\text{II.183})$$

Then, the QQ-relation (II.182) can be written at positions $\mathbf{u} = \mathbf{u}_{I\Delta\mathbf{j}}^{(n)}$ and $\mathbf{u} = \mathbf{u}_{I\Delta\mathbf{j}}^{(n)} + 1$. In both of these positions one term is zero in the right-hand-side, and we get

$$\left\{ \begin{array}{l} (x_j - x_k) Q_{I\Delta\mathbf{j}\Delta\mathbf{k}}(\mathbf{u}) Q_I(\mathbf{u} - 1) + x_k Q_{I\Delta\mathbf{j}}(\mathbf{u} - 1) Q_{I\Delta\mathbf{k}}(\mathbf{u}) \Big|_{\mathbf{u}=\mathbf{u}_{I\Delta\mathbf{j}}^{(n)}} = 0, \\ (x_j - x_k) Q_{I\Delta\mathbf{j}\Delta\mathbf{k}}(\mathbf{u} + 1) Q_I(\mathbf{u}) - x_j Q_{I\Delta\mathbf{j}}(\mathbf{u} + 1) Q_{I\Delta\mathbf{k}}(\mathbf{u}) \Big|_{\mathbf{u}=\mathbf{u}_{I\Delta\mathbf{j}}^{(n)}} = 0. \end{array} \right. \quad (\text{II.184})$$

$$\left\{ \begin{array}{l} (x_j - x_k) Q_{I\Delta\mathbf{j}\Delta\mathbf{k}}(\mathbf{u} + 1) Q_I(\mathbf{u}) - x_j Q_{I\Delta\mathbf{j}}(\mathbf{u} + 1) Q_{I\Delta\mathbf{k}}(\mathbf{u}) \Big|_{\mathbf{u}=\mathbf{u}_{I\Delta\mathbf{j}}^{(n)}} = 0. \end{array} \right. \quad (\text{II.185})$$

We can then take a linear combination of (II.184) and (II.185) in such a way that the coefficient of $Q_{I\Delta\mathbf{k}}(\mathbf{u}_{I\Delta\mathbf{j}}^{(n)})$ cancels. This gives

$$x_j Q_{I\Delta\mathbf{j}}(\mathbf{u} + 1) (x_j - x_k) Q_{I\Delta\mathbf{j}\Delta\mathbf{k}}(\mathbf{u}) Q_I(\mathbf{u} - 1) + x_k Q_{I\Delta\mathbf{j}}(\mathbf{u} - 1) (x_j - x_k) Q_{I\Delta\mathbf{j}\Delta\mathbf{k}}(\mathbf{u} + 1) Q_I(\mathbf{u}) \Big|_{\mathbf{u}=\mathbf{u}_{I\Delta\mathbf{j}}^{(n)}} = 0. \quad (\text{II.186})$$

An equivalent way to write it is

$$\frac{Q_{I\Delta\mathbf{j}}(\mathbf{u}_{I\Delta\mathbf{j}}^{(n)} + 1) Q_{I\Delta\mathbf{j}\Delta\mathbf{k}}(\mathbf{u}_{I\Delta\mathbf{j}}^{(n)}) Q_I(\mathbf{u}_{I\Delta\mathbf{j}}^{(n)} - 1)}{Q_{I\Delta\mathbf{j}}(\mathbf{u}_{I\Delta\mathbf{j}}^{(n)} - 1) Q_{I\Delta\mathbf{j}\Delta\mathbf{k}}(\mathbf{u}_{I\Delta\mathbf{j}}^{(n)} + 1) Q_I(\mathbf{u}_{I\Delta\mathbf{j}}^{(n)})} = - \frac{x_k}{x_j}. \quad (\text{II.187})$$

In this equation, we want to choose I , \mathbf{j} and \mathbf{k} such that the Q -functions involved in (II.187) lie along a given nesting path, so as to plug them into the expression (II.170) of the generating series of the T -functions. If both \mathbf{j} and \mathbf{k} have grading $(-1)^{p_j} = (-1)^{p_k} = 1$, then from the definition (II.148) we see that I , $I\Delta\mathbf{j} = I \cup \{\mathbf{j}\}$, and $I\Delta\mathbf{j}\Delta\mathbf{k} = I \cup \{\mathbf{j}, \mathbf{k}\}$ can be chosen along the same nesting path. Similarly, if \mathbf{j} and \mathbf{k} have grading $(-1)^{p_j} = (-1)^{p_k} = -1$, then I , $I\Delta\mathbf{j} = I \setminus \{\mathbf{j}\}$, and $I\Delta\mathbf{j}\Delta\mathbf{k} = I \setminus \{\mathbf{j}, \mathbf{k}\}$ can be chosen along the same nesting path. By contrast, if $(-1)^{p_j} = -(-1)^{p_k}$, then we see that I and $I\Delta\mathbf{j}\Delta\mathbf{k}$ have the same nesting level (for instance, if $(-1)^{p_j} = 1$ and $(-1)^{p_k} = -1$, then $|I\Delta\mathbf{j}\Delta\mathbf{k}| = |I \cup \{\mathbf{j}\} \setminus \{\mathbf{k}\}| = |I|$), and therefore they cannot lie on the same nesting path. In that case we should use the relations

$$\frac{Q_{I\Delta\mathbf{j}}(\mathbf{u}_I^{(n)} + 1) Q_{I\Delta\mathbf{k}}(\mathbf{u}_I^{(n)})}{Q_{I\Delta\mathbf{j}}(\mathbf{u}_I^{(n)}) Q_{I\Delta\mathbf{k}}(\mathbf{u}_I^{(n)} + 1)} = \frac{x_k}{x_j}, \quad \text{and} \quad \frac{Q_{I\Delta\mathbf{j}}(\mathbf{u}_{I\Delta\mathbf{j}\Delta\mathbf{k}}^{(n)}) Q_{I\Delta\mathbf{k}}(\mathbf{u}_{I\Delta\mathbf{j}\Delta\mathbf{k}}^{(n)} - 1)}{Q_{I\Delta\mathbf{j}}(\mathbf{u}_{I\Delta\mathbf{j}\Delta\mathbf{k}}^{(n)} - 1) Q_{I\Delta\mathbf{k}}(\mathbf{u}_{I\Delta\mathbf{j}\Delta\mathbf{k}}^{(n)})} = \frac{x_k}{x_j}, \quad (\text{II.188})$$

which arise by setting $\mathbf{u} = \mathbf{u}_I^{(n)} + 1$ (resp $\mathbf{u} = \mathbf{u}_{I\Delta\mathbf{j}\Delta\mathbf{k}}^{(n)}$) in (II.182).

Finally, the Bethe equations are the set of $K + M - 1$ equations corresponding to an arbitrary nesting path $(\mathbf{i}_1, \mathbf{i}_2, \dots, \mathbf{i}_{K+M})$:

$$\forall \mathbf{m} \in \llbracket 1, K + M - 1 \rrbracket,$$

$$\left\{ \begin{array}{l} \frac{Q_{I_{\mathbf{m}}}(\mathbf{u}_{I_{\mathbf{m}}}^{(n)} + 1) Q_{I_{\mathbf{m}+1}}(\mathbf{u}_{I_{\mathbf{m}}}^{(n)}) Q_{I_{\mathbf{m}-1}}(\mathbf{u}_{I_{\mathbf{m}}}^{(n)} - 1)}{Q_{I_{\mathbf{m}}}(\mathbf{u}_{I_{\mathbf{m}}}^{(n)} - 1) Q_{I_{\mathbf{m}+1}}(\mathbf{u}_{I_{\mathbf{m}}}^{(n)} + 1) Q_{I_{\mathbf{m}-1}}(\mathbf{u}_{I_{\mathbf{m}}}^{(n)})} = -\frac{x_{\mathbf{i}_{\mathbf{m}+1}}}{x_{\mathbf{i}_{\mathbf{m}}}}, \\ \text{if } (-1)^{p_{\mathbf{i}_{\mathbf{m}}}} = (-1)^{p_{\mathbf{i}_{\mathbf{m}+1}}} = +1 \end{array} \right. \quad (\text{II.189a})$$

$$\left\{ \begin{array}{l} \frac{Q_{I_{\mathbf{m}}}(\mathbf{u}_{I_{\mathbf{m}}}^{(n)} + 1) Q_{I_{\mathbf{m}-1}}(\mathbf{u}_{I_{\mathbf{m}}}^{(n)}) Q_{I_{\mathbf{m}+1}}(\mathbf{u}_{I_{\mathbf{m}}}^{(n)} - 1)}{Q_{I_{\mathbf{m}}}(\mathbf{u}_{I_{\mathbf{m}}}^{(n)} - 1) Q_{I_{\mathbf{m}-1}}(\mathbf{u}_{I_{\mathbf{m}}}^{(n)} + 1) Q_{I_{\mathbf{m}+1}}(\mathbf{u}_{I_{\mathbf{m}}}^{(n)})} = -\frac{x_{\mathbf{i}_{\mathbf{m}}}}{x_{\mathbf{i}_{\mathbf{m}+1}}}, \\ \text{if } (-1)^{p_{\mathbf{i}_{\mathbf{m}}}} = (-1)^{p_{\mathbf{i}_{\mathbf{m}+1}}} = -1 \end{array} \right. \quad (\text{II.189b})$$

$$\left\{ \begin{array}{l} \frac{Q_{I_{\mathbf{m}-1}}(\mathbf{u}_{I_{\mathbf{m}}}^{(n)}) Q_{I_{\mathbf{m}+1}}(\mathbf{u}_{I_{\mathbf{m}}}^{(n)} - 1)}{Q_{I_{\mathbf{m}-1}}(\mathbf{u}_{I_{\mathbf{m}}}^{(n)} - 1) Q_{I_{\mathbf{m}+1}}(\mathbf{u}_{I_{\mathbf{m}}}^{(n)})} = \frac{x_{\mathbf{i}_{\mathbf{m}}}}{x_{\mathbf{i}_{\mathbf{m}+1}}}, \\ \text{if } (-1)^{p_{\mathbf{i}_{\mathbf{m}}}} = +1 \text{ and } (-1)^{p_{\mathbf{i}_{\mathbf{m}+1}}} = -1 \end{array} \right. \quad (\text{II.189c})$$

$$\left\{ \begin{array}{l} \frac{Q_{I_{\mathbf{m}-1}}(\mathbf{u}_{I_{\mathbf{m}}}^{(n)} + 1) Q_{I_{\mathbf{m}+1}}(\mathbf{u}_{I_{\mathbf{m}}}^{(n)})}{Q_{I_{\mathbf{m}-1}}(\mathbf{u}_{I_{\mathbf{m}}}^{(n)}) Q_{I_{\mathbf{m}+1}}(\mathbf{u}_{I_{\mathbf{m}}}^{(n)} + 1)} = \frac{x_{\mathbf{i}_{\mathbf{m}+1}}}{x_{\mathbf{i}_{\mathbf{m}}}}, \\ \text{if } (-1)^{p_{\mathbf{i}_{\mathbf{m}}}} = -1 \text{ and } (-1)^{p_{\mathbf{i}_{\mathbf{m}+1}}} = +1 \end{array} \right. \quad (\text{II.189d})$$

$$\text{where } I_{\mathbf{m}} \equiv \{\mathbf{i}_1, \mathbf{i}_2, \dots, \mathbf{i}_{\mathbf{m}}\}. \quad (\text{II.189e})$$

There, the cases (II.189a) and (II.189b) are obtained from (II.187). On the other hand, (II.189c) is obtained from (II.188) by choosing $I = I_{\mathbf{m}-1} \cup \{\mathbf{i}_{\mathbf{m}+1}\}$, and $\mathbf{j} = \mathbf{i}_{\mathbf{m}+1}$, $\mathbf{k} = \mathbf{i}_{\mathbf{m}}$ (so that $I_{\mathbf{m}-1} = I \Delta \mathbf{j}$, $I_{\mathbf{m}} = I \Delta \mathbf{j} \Delta \mathbf{k}$ and $I_{\mathbf{m}+1} = I \Delta \mathbf{k}$), whereas (II.189d) is obtained from (II.188) by choosing $I = I_{\mathbf{m}}$, and $\mathbf{j} = \mathbf{i}_{\mathbf{m}}$, $\mathbf{k} = \mathbf{i}_{\mathbf{m}+1}$ (so that $I_{\mathbf{m}-1} = I \Delta \mathbf{j}$, $I_{\mathbf{m}} = I$ and $I_{\mathbf{m}+1} = I \Delta \mathbf{k}$).

The Bethe equations (II.189) should be viewed as a set of equations on the Bethe roots $\mathbf{u}_I^{(n)}$, which fix the Q -functions on a nesting path (see (II.183), where the degree of freedom α_I is non-physical as can be seen from (II.180)). Given a solution of this set of equations, we can write corresponding polynomial expressions (from (II.183)) for the Q -functions $Q_{I_{\mathbf{m}}}(\mathbf{u})$ along a given nesting path, and plug them into the operators $\mathcal{O}_I(\mathbf{i})$ in the right-hand-side of (II.170) in order to express the T -functions.

Of course, there exist other ways to prove the Bethe equations: interestingly one of them is to ask that every possible pole vanishes when $T^{1,1}(\mathbf{u})$ is expressed from (II.170) (see next section).

Case of the $\text{XXX}_{1/2}$ Heisenberg spin chain Let us now show that (II.189) allows to recover the Bethe equation (I.24) of the introductory section I.1: the Hamiltonian (I.1) corresponds to the $\text{GL}(2)$ spin chain, with all inhomogeneities set to $\theta_i = 0$. Then

$Q_{\{1,2\}}(\mathbf{u}) = \mathbf{u}^L$. If we assume that $Q_{\emptyset}(\mathbf{u})$ is a constant (independent of \mathbf{u}), then we can write (II.189) for the nesting path $(\mathbf{i}_1, \mathbf{i}_2) = (1, 2)$:

$$\frac{Q_{\{1\}}(\mathbf{u}^{(n)} + 1)}{Q_{\{1\}}(\mathbf{u}^{(n)} - 1)} \left(\frac{\mathbf{u}^{(n)}}{\mathbf{u}^{(n)} + 1} \right)^L = -\frac{x_2}{x_1}, \quad (\text{II.190})$$

$$\text{where } \mathbf{u}^{(n)} \equiv \mathbf{u}_{\{1\}}^{(n)}, \quad (\text{II.191})$$

or equivalently

$$\left(\frac{\mathbf{u}^{(n)}}{\mathbf{u}^{(n)} + 1} \right)^L = \frac{x_2}{x_1} \prod_{m \neq n} \frac{\mathbf{u}^{(n)} - \mathbf{u}^{(m)} - 1}{\mathbf{u}^{(n)} - \mathbf{u}^{(m)} + 1}. \quad (\text{II.192})$$

In (II.190) there is a minus sign in the right-hand-side, whereas the left-hand side reads $\prod_m \frac{\mathbf{u}^{(n)} - \mathbf{u}^{(m)} - 1}{\mathbf{u}^{(n)} - \mathbf{u}^{(m)} + 1}$. To get (II.192), the factor $\frac{\mathbf{u}^{(n)} - \mathbf{u}^{(n)} - 1}{\mathbf{u}^{(n)} - \mathbf{u}^{(n)} + 1}$ is removed from the product, and that exactly absorbs the minus sign.

The Hamiltonian (I.1) is obtained in the limit $g \rightarrow 1$, where $\frac{x_2}{x_1}$ is set to 1. Then if we change the variables as $\mathbf{u}^{(n)} \equiv \frac{e^{ip_n}}{1 - e^{ip_n}}$, the left-hand-side becomes exactly $e^{iL p_n}$ while the right-hand-side becomes exactly $\prod_{m \neq n} S(p_n, p_m)$. Therefore (II.192) exactly gives the Bethe equation (I.24), found in the introductory section. In the next section we will also see that this formalism allows to recover the correct expression of the energy.

Assuming that the Bäcklund flow exists and is polynomial, we derived Bethe equations (II.187) which generalize the equation (I.24) found for the $\text{XXX}_{1/2}$ spin chain in the introductory section.

II.2.2.4 Energy spectrum

Under the assumptions of the previous sections (i.e. if the Bäcklund flow exists and is polynomial), one can even recover the spectrum of the Hamiltonian.

If the T -functions are the eigenvalues of the T -operators defined in section II.1 for spin chains, then the energy of a state is given by $\frac{2}{K+M}L - 2 \partial_{\mathbf{u}} \log T^{1,1}(\mathbf{u})|_{\mathbf{u}=0}$. This expression is simply the eigenvalue of the Hamiltonian $H = \frac{2}{K+M}L - 2 \partial_{\mathbf{u}} \log T^{1,1}(\mathbf{u})|_{\mathbf{u}=0}$, where the T -operator $T^{1,1}(\mathbf{u}) = T^{\square}(\mathbf{u})$ corresponds to the fundamental representation (it was also denoted $T(\mathbf{u})$ in the section II.1.1.2).

Therefore, we need to express $T^{1,1}(\mathbf{u})$ in order to recover the spectrum of the spin chain. From (II.159) we see that $T^{1,1}(\mathbf{u}) \equiv T_{\emptyset}^{1,1}(\mathbf{u})$ is the coefficient of z^1 in $\mathcal{W}_{\emptyset}(\mathbf{u}; z)$. If we express $\mathcal{W}_{\emptyset}(\mathbf{u}; z)$ from (II.170), we see that $T^{1,1}(\mathbf{u})$ is obtained by keeping the term in z^1 in one of the operators \mathcal{O}_I , and keeping the term of degree z^0 (which is equal to $\frac{Q_{I,j}(\mathbf{u})}{Q_I(\mathbf{u})}$) for all the other operators \mathcal{O}_I . That gives

$$T^{1,1}(\mathbf{u}) = Q_{\emptyset}(\mathbf{u}) \sum_{k=1}^{K+M} (-1)^{p_{i_k}} x_{i_k} \frac{Q_{I_{k-1}}(\mathbf{u} - (-1)^{p_{i_k}}) Q_{I_k}(\mathbf{u} + (-1)^{p_{i_k}})}{Q_{I_{k-1}}(\mathbf{u}) Q_{I_k}(\mathbf{u})}. \quad (\text{II.193})$$

$$\text{where } I_k \equiv \{\mathbf{i}_1, \mathbf{i}_2, \dots, \mathbf{i}_k\}, \quad \text{such that } I_{K+M} = \llbracket 1, K+M \rrbracket. \quad (\text{II.194})$$

In the case of the spin chain with inhomogeneities $\theta_i = 0$, we get $Q_{\bar{\theta}}(\mathbf{u}) = \mathbf{u}^L$. Therefore, if the length of the spin chain is $L \geq 2$, then $Q_{\bar{\theta}}(0) = 0$ and $\partial_{\mathbf{u}} Q_{\bar{\theta}}(\mathbf{u})|_{\mathbf{u}=0} = 0$. To write the energy of a state, we want to write $\frac{\partial_{\mathbf{u}} T(\mathbf{u})}{T(\mathbf{u})}|_{\mathbf{u}=0}$, and in (II.193), we can see that the terms $k \leq K + M - 1$ contain the prefactor $Q_{\bar{\theta}}(\mathbf{u})$, hence these terms do not contribute⁸ to $\partial_{\mathbf{u}} T(\mathbf{u})|_{\mathbf{u}=0}$ and to $T(\mathbf{u})|_{\mathbf{u}=0}$. By contrast, the last term $k = K + M$ contains $Q_{\bar{\theta}}(\mathbf{u})$ both in the numerator and the denominator, so that this term reduces to

$$(-1)^{P_{i_{K+M}}} x_{i_{K+M}} \frac{Q_{I_{K+M-1}}(\mathbf{u} - (-1)^{P_{i_{K+M}}}) Q_{\bar{\theta}}(\mathbf{u} + (-1)^{P_{i_{K+M}}})}{Q_{I_{K+M-1}}(\mathbf{u})}$$

which contributes to $\partial_{\mathbf{u}} T(\mathbf{u})|_{\mathbf{u}=0}$ and to $T(\mathbf{u})|_{\mathbf{u}=0}$. This term gives

$$\partial_{\mathbf{u}} \log T(\mathbf{u})|_{\mathbf{u}=0} = (-1)^{P_{i_{K+M}}} L + \frac{\partial_{\mathbf{u}} Q_{I_{K+M-1}}(\mathbf{u})}{Q_{I_{K+M-1}}(\mathbf{u})} \Big|_{\mathbf{u} = -(-1)^{P_{i_{K+M}}}} - \frac{\partial_{\mathbf{u}} Q_{I_{K+M-1}}(\mathbf{u})}{Q_{I_{K+M-1}}(\mathbf{u})} \Big|_{\mathbf{u}=0}. \quad (\text{II.195})$$

For the Heisenberg $XXX_{1/2}$ spin chain, we have $K = 2$, $M = 0$, and the energy $E = L - 2 \partial_{\mathbf{u}} \log T(\mathbf{u})|_{\mathbf{u}=0}$ is equal to

$$E = -L + 2 \sum_n \left(\partial_{\mathbf{u}} \log(\mathbf{u} - \mathbf{u}^{(n)})|_{\mathbf{u}=0} - \partial_{\mathbf{u}} \log(\mathbf{u} - \mathbf{u}^{(n)})|_{\mathbf{u}=-1} \right) \quad (\text{II.196})$$

$$= -L - 2 \sum_n \frac{1}{\mathbf{u}^{(n)}(\mathbf{u}^{(n)} + 1)} = -L + 4 - 4 \cos(p_n), \quad (\text{II.197})$$

where the last line, which is obtained by the change of variables⁹ $\mathbf{u}^{(n)} \equiv \frac{e^{ip_n}}{1 - e^{ip_n}}$, coincides with the energy (I.21) obtained in section I.1.

II.2.2.5 Bethe equations for $GL(K)$ with $K > 2$

The equations (II.189) (which reduce to (II.187) in the case of $GL(K)$) are often called “nested Bethe ansatz” equations [Sut75], and it is also possible to derive them by the methods of the introductory section I.1, though it is much more complicated than for the Heisenberg spin chain. Instead of this study, let us simply mention in what sense they are a generalization of (I.24).

To do this, we should remember that for $K = 2$, we have seen that each excited state can be labeled by a different set of roots¹⁰ for the Q -functions. This will be interpreted in section II.3 as the fact that each eigenstate is associated to a different eigenvalue of

⁸Rigorously, this argument assumes that the Q -functions on the denominator have no zero at $\mathbf{u} = 0$ when $k < K + M$. As a consequence the argument holds provided the roots of the Q -functions $Q_{I_1}(\mathbf{u})$, $Q_{I_2}(\mathbf{u})$, \dots , $Q_{I_{K+M-1}}(\mathbf{u})$ are all non-zero. In fact, $T^{1,1}(\mathbf{u})$ is a rational function of all these roots, and by continuity, the expression (II.195) will hold even if some $Q_{I_j}(\mathbf{u})$ has a zero at $\mathbf{u} = 0$.

⁹This change of variables was already used to express the Bethe equations in terms of the momenta p_n of the introductory section I.1.

¹⁰These roots $\mathbf{u}^{(n)}$ were indeed associated (via a change of variables) to the momenta of the spin waves of section I.1.

the Q -operators. These roots will be called Bethe roots, and for $K = 2$ they are identical (up to a simple change of variable) to the momenta parameterizing the states in (I.19).

For $K > 2$, the excited states should therefore be labeled by the $K - 1$ sets $\{\mathbf{u}_{\{1\}}^{(n)} | 1 \leq n \leq d_{\{1\}}\}$, $\{\mathbf{u}_{\{1,2\}}^{(n)} | 1 \leq n \leq d_{\{1,2\}}\}$, \dots , $\{\mathbf{u}_{\{1,2,\dots,K-1\}}^{(n)} | 1 \leq n \leq d_{\{1,2,\dots,K-1\}}\}$, where d_I denotes the degree of the polynomial $Q_I(\mathbf{u})$. They are the Bethe roots which define the Q -functions¹¹ of the nesting path $(1, 2, \dots, K)$, and we will denote them as

$$\mathbf{u}^{(\mathbf{m},n)} \equiv \mathbf{u}_{\{1,2,\dots,\mathbf{m}\}}^{(n)}, \quad \text{if } n \leq d^{(\mathbf{m})}, \quad \text{where } d^{(\mathbf{m})} \equiv d_{\{1,2,\dots,\mathbf{m}\}}. \quad (\text{II.198})$$

In (II.198), the integer \mathbf{m} will be called the ‘‘level’’ of the root.

The Hamiltonian (II.12) arises in the limit where $g = 1$ and where $\forall i, u_i = 0$. In this limit, we can write the equation (II.189) at the nesting level \mathbf{m} (i.e. we set $I = (1, 2, \dots, \mathbf{m} - 1)$, $\mathbf{j} = \mathbf{m}$ and $\mathbf{k} = \mathbf{m} + 1$) to get

$$\left(\prod_{\substack{l \neq n \\ 1 \leq l \leq d^{(\mathbf{m})}}} \frac{\mathbf{u}^{(\mathbf{m},n)} - \mathbf{u}^{(\mathbf{m},l)} + 1}{\mathbf{u}^{(\mathbf{m},n)} - \mathbf{u}^{(\mathbf{m},l)} - 1} \right) \left(\prod_{1 \leq l \leq d^{(\mathbf{m}+1)}} \frac{\mathbf{u}^{(\mathbf{m},n)} - \mathbf{u}^{(\mathbf{m}+1,l)}}{\mathbf{u}^{(\mathbf{m},n)} - \mathbf{u}^{(\mathbf{m}+1,l)} + 1} \right) \\ \times \left(\prod_{1 \leq l \leq d^{(\mathbf{m}-1)}} \frac{\mathbf{u}^{(\mathbf{m},n)} - \mathbf{u}^{(\mathbf{m}-1,l)} - 1}{\mathbf{u}^{(\mathbf{m},n)} - \mathbf{u}^{(\mathbf{m}-1,l)}} \right) = 1 \quad (\text{II.199})$$

if $2 \leq \mathbf{m} \leq K - 1$. We also get

$$\left(\prod_{\substack{l \neq n \\ 1 \leq l \leq d^{(1)}}} \frac{\mathbf{u}^{(1,n)} - \mathbf{u}^{(1,l)} + 1}{\mathbf{u}^{(1,n)} - \mathbf{u}^{(1,l)} - 1} \right) \left(\prod_{1 \leq l \leq d^{(2)}} \frac{\mathbf{u}^{(1,n)} - \mathbf{u}^{(2,l)}}{\mathbf{u}^{(1,n)} - \mathbf{u}^{(2,l)} + 1} \right) = 1 \quad (\text{II.200})$$

for $\mathbf{m} = 1$, and finally

$$\left(\prod_{\substack{l \neq n \\ 1 \leq l \leq d^{(K-1)}}} \frac{\mathbf{u}^{(K-1,n)} - \mathbf{u}^{(K-1,l)} + 1}{\mathbf{u}^{(K-1,n)} - \mathbf{u}^{(K-1,l)} - 1} \right) \left(\prod_{1 \leq l \leq d^{(K-2)}} \frac{\mathbf{u}^{(K-1,n)} - \mathbf{u}^{(K-2,l)} - 1}{\mathbf{u}^{(K-1,n)} - \mathbf{u}^{(K-2,l)}} \right) \\ = \left(\frac{\mathbf{u}^{(K-1,n)} + 1}{\mathbf{u}^{(K-1,n)}} \right)^L \quad (\text{II.201})$$

for $\mathbf{m} = K - 1$. These expressions are obtained exactly like in (II.192), and in particular the minus sign in (II.189a) is absorbed into the condition $l \neq n$ in the first product of each equality.

¹¹There are only $K - 1$ sets of Bethe roots, because the Q -function $Q_{\emptyset}(\mathbf{u}) = \prod_{i=1}^L u_i$ is known, and the function $Q_{\emptyset}(\mathbf{u})$ is supposed to be a constant, which will be proven in the next section

These three equations can be rewritten as

$$\boxed{\begin{array}{l} \forall \mathbf{m} \in \llbracket 1, K-1 \rrbracket \\ \forall \mathbf{n} \in \llbracket 1, d^{(\mathbf{m})} \rrbracket \end{array}, \quad e^{\mathbf{i} L p^{(\mathbf{m})}(\mathbf{u}^{(\mathbf{m},\mathbf{n})})} = \prod_{\substack{\mathbf{k} \in \llbracket 1, K-1 \rrbracket \\ \mathbf{l} \in \llbracket 1, d^{(\mathbf{k})} \rrbracket \\ (\mathbf{k}, \mathbf{l}) \neq (\mathbf{m}, \mathbf{n})}} S^{(\mathbf{m}, \mathbf{k})}(\mathbf{u}^{(\mathbf{m}, \mathbf{n})} - \mathbf{u}^{(\mathbf{k}, \mathbf{l})}), \quad (\text{II.202})$$

where the product on the right-hand-side runs over all the (\mathbf{k}, \mathbf{l}) such that $\mathbf{k} \neq \mathbf{m}$ or $\mathbf{l} \neq \mathbf{n}$, i.e. over all the other Bethe roots except the root $\mathbf{u}^{(\mathbf{m}, \mathbf{n})}$. In (II.202), we define

$$p^{(\mathbf{m})}(\mathbf{u}^{(\mathbf{m}, \mathbf{n})}) = \begin{cases} 0 & \text{if } \mathbf{m} < K-1 \\ \mathbf{i} \log\left(\frac{\mathbf{u}^{(\mathbf{m}, \mathbf{n})} + 1}{\mathbf{u}^{(\mathbf{m}, \mathbf{n})}}\right) & \text{if } \mathbf{m} = K-1 \end{cases}, \quad (\text{II.203})$$

$$S^{(\mathbf{m}, \mathbf{k})}(\mathbf{u} - \mathbf{v}) = \begin{cases} \frac{\mathbf{u} - \mathbf{v} - 1}{\mathbf{u} - \mathbf{v} + 1} & \text{if } \mathbf{k} = \mathbf{m} \\ \frac{\mathbf{u} - \mathbf{v} + 1}{\mathbf{u} - \mathbf{v}} & \text{if } \mathbf{k} = \mathbf{m} + 1 \\ \frac{\mathbf{u} - \mathbf{v}}{\mathbf{u} - \mathbf{v} - 1} & \text{if } \mathbf{k} = \mathbf{m} - 1 \\ 1 & \text{otherwise} \end{cases}. \quad (\text{II.204})$$

The equation (II.203) shows that the roots of level $\mathbf{m} < K-1$ have no momentum, which is consistent with the analysis of section II.2.2.4 where we see, (in (II.195)) that only the polynomial $Q_{I_{K-1}}(\mathbf{u})$ contributes to the energy, which means that only the roots $\mathbf{u}^{(K-1, \mathbf{n})}$ are massive and carry an energy. The equation (II.204) shows that the interactions of “particles” (i.e. the roots) depend on their level, and that a root of level \mathbf{m} “interacts” only with roots of level $\mathbf{m} + 1$ or $\mathbf{m} - 1$.

The form of equation (II.202) is very general, and it describes the integrable theories with various different types of particles (labeled here by the level \mathbf{m}): every excited state is labeled by a set of variables $(\mathbf{u}^{(\mathbf{m}, \mathbf{n})})$ satisfying (II.202), and its energy can be extracted from these variables (see the next paragraph).

Hence if we manage to prove that these Q -functions exist and are polynomial (which we will do in the next section), then we get the spectrum of the $\text{GL}(K)$ spin chain, generalizing the results of section I.1.

Energy spectrum The eigenstates of the spin chain’s Hamiltonian correspond to solutions of (II.189), and we can also compute their energy as in (II.195). For a $\text{GL}(K|M)$ spin chain, this energy is in general equal to $\frac{2}{K+M}L - 2 \partial_{\mathbf{u}} \log T^{1,1}(\mathbf{u})|_{\mathbf{u}=0}$, and it can be computed as in (II.197), to get

$$E = \left(\frac{2}{K+M} - 2(-1)^{p_{i_{K+M}}} \right) L - 2 \sum_{\mathbf{n} \in \llbracket 1, d^{(K+M-1)} \rrbracket} \frac{(-1)^{p_{i_{K+M}}}}{\mathbf{u}^{(K+M-1, \mathbf{n})}(\mathbf{u}^{(K+M-1, \mathbf{n})} + (-1)^{p_{i_{K+M}}})} \quad (\text{II.205})$$

where we should note that $(-1)^{p_{i_{K+M}}} = \pm 1$ denotes the $\text{GL}(K|M)$ grading introduced in section II.1.3, which should not be confused with the momenta p_n of the “particles”.

II.3 Differential expression of Q-operators

In the previous section, we saw that if the “undressing” and “dressing” procedures apply and give polynomial T -functions associated to subgroups $GL(k|m)$ of $GL(K|M)$, then (under the extra assumption that $Q_{\emptyset}(\mathbf{u})$ is independent of \mathbf{u}), we recover the spectrum of the Heisenberg spin chain and generalize it to higher-rank groups.

In this section, we will introduce original results of this PhD [12KLT], and we will explicitly construct the whole Bäcklund flow associated to a spin chain. This will allow us to prove the assumptions of section II.2 “from scratch”.

To do that, we will define some Q-operators and T-operators at all levels of nesting. they will turn out to have a very simple expression in terms of differential operators or equivalently in terms of diagrammatic expressions. These expressions will allow to show that they obey the linear system (II.154, II.155) which defines the Bäcklund transform.

The construction of “Q-operators” which we give in this section is quite different from the constructions introduced in the literature for several models¹², and in particular, it defines the Q-operators directly as operators and shows their polynomiality for these $GL(K|M)$ spin chains.

II.3.1 Derivation of the simplest Q-operators, when $L = 1$

To start with, let us see, in the case of $GL(K)$ with one single spin (i.e. $L = 1$), how to write operators satisfying the equations of section II.2, and in particular the TQ-relation. In terms of generating series, this TQ-relation (II.158) reads (for first level of nesting of the $GL(K)$ spin chain)

$$\mathcal{W}_{\bar{j}}(\mathbf{u}; z)Q_{\bar{\emptyset}}(\mathbf{u}) = \mathcal{W}_{\bar{\emptyset}}(\mathbf{u}; z)Q_{\bar{j}}(\mathbf{u}) - x_j z \mathcal{W}_{\bar{\emptyset}}(\mathbf{u} + 1; z)Q_{\bar{j}}(\mathbf{u} - 1), \quad (\text{II.206})$$

$$\text{where } \mathcal{W}_I(\mathbf{u}; z) \equiv \sum_{s=0}^{\infty} z^s T_I^{1,s}(\mathbf{u}), \quad Q_I(\mathbf{u}) \equiv T_I^{0,0}(\mathbf{u}) \quad (\text{II.207})$$

$$\bar{\emptyset} \equiv \llbracket 1, K \rrbracket, \quad \text{and } \bar{j} = \llbracket 1, K \rrbracket \setminus \{j\}. \quad (\text{II.208})$$

For a spin chain with length $L = 1$, we can insert the explicit expressions of $\mathcal{W}_{\bar{\emptyset}}(\mathbf{u}; z)$ and $Q_{\bar{\emptyset}}(\mathbf{u})$ into this TQ-relation (II.206). These expressions of $\mathcal{W}_{\bar{\emptyset}}(\mathbf{u}; z)$ and $Q_{\bar{\emptyset}}(\mathbf{u})$ read¹³

$$\mathcal{W}_{\bar{\emptyset}}(\mathbf{u}; z) = \left(\mathbf{u} + \frac{g z}{1 - g z} \right) w(z), \quad \text{and } Q_{\bar{\emptyset}}(\mathbf{u}) = Q(\mathbf{u}) = \mathbf{u}, \quad (\text{II.209})$$

and allow to view (II.206) as an equation on the function $\mathcal{W}_{\bar{j}}(\mathbf{u}; z) = Q_{\bar{j}}(\mathbf{u}) + z T_{\bar{j}}^{1,1}(\mathbf{u}) + z^2 T_{\bar{j}}^{1,2}(\mathbf{u}) + \dots$.

To find a solution to this equation, it can be interesting to remember, from section II.2, what properties we would like from this solution:

¹²See for instance [Bax72, PG92, BLZ97a, BLZ99, Hik01, BHK02a, FM03, KMS03, KZ05, Kor05, BT06, BJM⁺07, BDKM07, Koj08, BT08, DM09, BGK⁺10, BŁMS10, BFL⁺11, Sta12, FŁMS11b, FŁMS11a, Tsu12].

¹³We remind here that $\bar{\emptyset} = \llbracket 1, K \rrbracket$, and that the operators $T^{a,s}(\mathbf{u})$ defined in section II.1 are now also denoted as $T_{\bar{\emptyset}}^{a,s}(\mathbf{u})$.

and deducing $\mathcal{W}_{\bar{j}}(\mathbf{u}; z)$. But before we come to this point, let us notice that except for one eigenvalue where the behavior is singular, the operator (II.215) can be viewed as $Q_{\bar{j}}(\mathbf{u}) = \mathbf{u} + 1 + \frac{g/x_j}{1-g/x_j}$. If we change the normalization by an (infinite) factor $w(1/x_j)$, we see that $Q_{\bar{j}}(\mathbf{u}) = \left[(\mathbf{u} + 1 + \hat{D}) w(1/x_j) \right]$.

In the next sections we will see how to make this claim more rigorous, with respect to the singularities in this expression. We will also see that the generalization to more spins is very simply obtained by replacing $(\mathbf{u} + 1 + \hat{D})$ with $\bigotimes_{i=1}^L (\mathbf{u}_i + 1 + \hat{D})$.

II.3.2 General expression of the Bäcklund flow

In section II.3.1, we have found the expression of the Q-operators for a GL(K) spin chain with one single spin, at the first nesting level. Their form involves the limit of $\left[(\mathbf{u} + 1 + \hat{D}) w(z) \right]$ at $z \rightarrow 1/x_j$, which is a singular limit. Let us now generalize this to $L \in \mathbb{N}$ (but still at the first level of nesting), and we will see that the main identity on co-derivatives (II.117) which we just derived allows to write an explicit polynomial solution to the TQ-relation (II.206) (which is simply the equation (II.158), written at the first level of nesting in terms of the generating series). The $n = 2$ case of the main identity on co-derivatives (II.117) reads

$$(t - z) \mathcal{W}(\mathbf{u} + 1; t, z) \cdot Q_{\bar{\theta}}(\mathbf{u}) = t \mathcal{W}(\mathbf{u} + 1; t) \cdot \mathcal{W}_{\bar{\theta}}(\mathbf{u}; z) - z \mathcal{W}(\mathbf{u}; t) \cdot \mathcal{W}_{\bar{\theta}}(\mathbf{u} + 1; z), \quad (\text{II.216})$$

where $\mathcal{W}(\mathbf{u}; z)$ and $\mathcal{W}_{\bar{\theta}}(\mathbf{u}; z)$ denote the same object, but $\bar{\theta}$ is added to draw attention to the similarity with equation (II.206). In order to deduce (II.206) from (II.216), it would be very natural to define $\mathcal{W}_{\bar{j}}(\mathbf{u}; z) \equiv \lim_{t \rightarrow 1/x_j} (1 - \frac{z}{t}) \mathcal{W}(\mathbf{u} + 1; t, z)$ which would give $Q_{\bar{j}}(\mathbf{u}) = \mathcal{W}_{\bar{j}}(\mathbf{u}; 0) = \lim_{t \rightarrow 1/x_j} \mathcal{W}(\mathbf{u} + 1; t)$. Under this definition, (II.216) would provide an explicit polynomial and operatorial solution of the TQ-relation (II.206).

Unfortunately $(1 - \frac{z}{t}) \mathcal{W}(\mathbf{u} + 1; t, z)$ is diverging at $t \rightarrow 1/x_j$, so that in order to identify the object $\mathcal{W}_{\bar{j}}(\mathbf{u}; z)$, we should first remove this singularity. To investigate this singularity, it is convenient to write $\mathcal{W}(\mathbf{u}; t, z)$ as a sum of \hat{D} -diagrams. Such an expression is obtained in appendix (see (B.26)), and though the exact expression is not crucial for the present argument, it is instructive to see this expression, written below when $L = 2$:

$$\mathcal{W}(\mathbf{u}; t, z) = \left(\begin{array}{c} \parallel \\ \parallel \end{array} + \sum_{k=1}^2 \left(\begin{array}{c} \parallel \\ k \end{array} + \begin{array}{c} \parallel \\ k \end{array} \right) + \sum_{1 \leq k, k' \leq 2} \begin{array}{c} \parallel \\ k k' \end{array} + \sum_{k=1}^2 \begin{array}{c} \times \\ k k \end{array} \right) w(z)w(t), \quad (\text{II.217})$$

where a double vertical line \parallel at position i denotes the operator $u_i \mathbb{I}$, whereas the lines $\begin{array}{c} \parallel \\ 1 \end{array}$, $\begin{array}{c} \vdots \\ 1 \end{array}$, $\begin{array}{c} \parallel \\ 2 \end{array}$, and $\begin{array}{c} \vdots \\ 2 \end{array}$ denote respectively the operators $\frac{g}{1-g} t$, $\frac{1}{1-g} t$, $\frac{g}{1-g} z$ and $\frac{1}{1-g} z$.

We see that when $t \rightarrow \frac{1}{x_j}$, there are two sources of singularities:

- The factor $w(t) = \prod_{j=1}^K \frac{1}{1-x_j t}$ has a pole of order one at $t \rightarrow 1/x_j$. The pole is of order one because we assume that all the eigenvalues x_j of the twist g are distinct.

- every time a co-derivative acts on $w(t)$ it multiplies $w(t)$ by a factor $\frac{g}{1-g} \frac{t}{t}$. The operator $\frac{g}{1-g} \frac{t}{t}$ has one eigenvalue (associated to the value x_j of g) equal to $\frac{x_j}{1-x_j} \frac{t}{t}$. This eigenvalue has a simple pole at $t \rightarrow 1/x_j$.

In order to have a well-defined limit at $t \rightarrow 1/x_j$, we can then multiply (II.216) by $\frac{(1-g t)^{\otimes L}}{w(t)}$, to get

$$\begin{aligned} \frac{t-z}{w(t)} (1-g t)^{\otimes L} \cdot \mathcal{W}(\mathbf{u}+1; t, z) \cdot \mathcal{Q}_{\bar{\theta}}(\mathbf{u}) &= \frac{t}{w(t)} (1-g t)^{\otimes L} \cdot \mathcal{W}(\mathbf{u}+1; t) \cdot \mathcal{W}_{\bar{\theta}}(\mathbf{u}; z) \\ &\quad - \frac{z}{t} \frac{t}{w(t)} (1-g t)^{\otimes L} \cdot \mathcal{W}(\mathbf{u}; t) \cdot \mathcal{W}_{\bar{\theta}}(\mathbf{u}+1; z). \end{aligned} \quad (\text{II.218})$$

This now involves the operator $\frac{1}{w(t)} (1-g t)^{\otimes L} \cdot \mathcal{W}(\mathbf{u}+1; t, z)$, which is a polynomial in the variables t and \mathbf{u} . Hence the limit at $t \rightarrow 1/x_j$ is well defined. Let us then define

$$\begin{aligned} \mathcal{W}_{\bar{j}}(\mathbf{u}; z) &\equiv (1-z x_j) \lim_{t \rightarrow 1/x_j} \frac{1}{w(t)} (1-g t)^{\otimes L} \cdot \mathcal{W}(\mathbf{u}+1; t, z), \quad (\text{II.219}) \\ &= (1-z x_j) \lim_{t \rightarrow 1/x_j} \frac{1}{w(t)} (1-g t)^{\otimes L} \cdot \left[\bigotimes_{i=1}^L \left(\mathbf{u}_i + 1 + \hat{\mathbf{D}} \right) w(t)w(z) \right]. \end{aligned}$$

With this definition, the limit of (II.218) when $t \rightarrow 1/x_j$ is

$$\mathcal{W}_{\bar{j}}(\mathbf{u}; z) \cdot \mathcal{Q}_{\bar{\theta}}(\mathbf{u}) = \mathcal{W}_{\bar{j}}(\mathbf{u}; 0) \cdot \mathcal{W}_{\bar{\theta}}(\mathbf{u}; z) - x_j z \mathcal{W}_{\bar{j}}(\mathbf{u}-1; 0) \cdot \mathcal{W}_{\bar{\theta}}(\mathbf{u}+1; z), \quad (\text{II.220})$$

which exactly coincides with the TQ-relation (II.206).

Before we generalize this expression to arbitrary nesting levels, and to the supergroups $\text{GL}(\mathbf{K}|\mathbf{M})$, let us elaborate on the definition (II.219), and see what it teaches about the Bäcklund flow. First for zero spin ($L = 0$), we get

$$\text{if } L = 0 \quad \text{then } \mathcal{W}_{\bar{j}}(\mathbf{u}; z) \equiv \lim_{t \rightarrow 1/x_j} \left(1 - \frac{z}{t} \right) w(z) = \prod_{\substack{1 \leq \mathbf{k} \leq \mathbf{K} \\ \mathbf{k} \neq \mathbf{j}}} \frac{1}{1 - x_{\mathbf{k}} z} = w_{\bar{j}}(z) \quad (\text{II.221})$$

$$\text{where } w_I(z) \equiv \sum_{s \geq 0} \chi^{(1,s)}(g_I) z^s = \prod_{j \in I} \frac{1}{1 - x_j z}. \quad (\text{II.222})$$

As expected, when $L = 0$ we recover the characters: $T_I^{(\lambda)}(\mathbf{u}) = \chi_{\lambda}(g_I)$. For $L \geq 1$, it is proven in appendix B.3 that the definition (II.219) is equivalent to

$$\mathcal{W}_{\bar{j}}(\mathbf{u}; z) = \lim_{t \rightarrow 1/x_j} \frac{1}{w(t)} (1-g t)^{\otimes L} \cdot \left[\bigotimes_{i=1}^L \left(\mathbf{u}_i + 1 + \hat{\mathbf{D}} \right) w(t)w_{\bar{j}}(z) \right]. \quad (\text{II.223})$$

The difference with (II.219) is that the factor $1 - z x_j$ was moved to the right of the $\bigotimes_{i=1}^L \left(\mathbf{u}_i + \hat{\mathbf{D}} \right)$, and multiplied with $w(z)$ to get $w_{\bar{j}}(z)$. If we expand (II.223) in powers

of z , then we get

$$\mathbb{T}_{\bar{J}}^{1,s}(\mathbf{u}) = \lim_{t_i \rightarrow 1/x_i} \frac{1}{w(t)} (1 - g t)^{\otimes L} \cdot \left[\bigotimes_{i=1}^L \left(\mathbf{u}_i + 1 + \hat{D} \right) w(t) \chi^{(1,s)}(g_{\bar{J}}) \right]. \quad (\text{II.224})$$

At this point, we can generalize this expression to arbitrary levels of nesting, and to arbitrary Young diagrams, in the $\text{GL}(\mathbb{K}|\mathbb{M})$ case: let us define the “nested T-operators” as¹⁴

$$\mathbb{T}_I^{(\lambda)}(\mathbf{u}) = \lim_{\substack{\forall \mathbf{i} \in \bar{I} \\ t_i \rightarrow 1/x_i}} \prod_{\mathbf{i} \in \bar{I}} \left(\frac{(1 - g t_i)^{\otimes L}}{(w(t_i))^{(-1)^{P_i}}} \right) \cdot \left[\bigotimes_{i=1}^L \left(\mathbf{u}_i + k_{\bar{I}} - m_{\bar{I}} + \hat{D} \right) \left(\prod_{i \in \bar{I}} (w(t_i))^{(-1)^{P_i}} \right) \chi_{\lambda}(g_I) \right] \quad (\text{II.225})$$

$$\text{where } \mathbf{u}_i = \mathbf{u} - \mathbf{i}, \quad \bar{I} = \{1, 2, \dots, \mathbb{K} + \mathbb{M}\} \setminus I, \quad (\text{II.226})$$

$$k_{\bar{I}} = \text{Card}\{\mathbf{i} \in \bar{I} | (-1)^{P_i} = 1\}, \quad m_{\bar{I}} = \text{Card}\{\mathbf{i} \in \bar{I} | (-1)^{P_i} = -1\}. \quad (\text{II.227})$$

Compared to (II.224), the definition (II.225) contains the following generalizations: first, it says that for an arbitrary representation, $\chi^{(1,s)}$ has to be replaced with χ_{λ} . Second it says that for an arbitrary level of nesting, we should put several functions $w(t_i)$ on the right of the co-derivatives. We should put one such factor for each $\mathbf{i} \in \bar{I}$, i.e. for each eigenvalue which is “removed” in the character $\chi_{\lambda}(g_I)$. Last, it says that for super-groups, the definition should remain the same up to a few signs, which are chosen in such a way that the equations of section II.2 are preserved (as we will show in the next subsections).

This operator $\mathbb{T}_I^{(\lambda)}(\mathbf{u})$ is well defined because it is the limit (when $t_i \rightarrow 1/x_i$) of a polynomial function of t_i . With this definition, $\mathbb{T}_I^{(\lambda)}(\mathbf{u})$ is also a polynomial function of \mathbf{u} , and we will see that it obeys the commutation relation

$$\forall \mathbf{u}, \mathbf{v}, \lambda, \mu, I, J \quad \left(\mathbb{T}_I^{(\lambda)}(\mathbf{u}), \mathbb{T}_J^{(\mu)}(\mathbf{v}) \right)_- = 0. \quad (\text{II.228})$$

Like in section II.2, we will denote

$$\boxed{\mathbb{Q}_I(\mathbf{u}) \equiv \mathbb{T}_I^{0,0}(\mathbf{u})} \quad (\text{II.229})$$

$$= \lim_{\substack{\forall \mathbf{i} \in \bar{I} \\ t_i \rightarrow 1/x_i}} B_I \cdot \left[\bigotimes_{i=1}^L \left(\mathbf{u}_i + k_{\bar{I}} - m_{\bar{I}} + \hat{D} \right) \Pi_I \right], \quad (\text{II.230})$$

$$\text{where } \boxed{B_I \equiv \frac{\prod_{\mathbf{i} \in \bar{I}} (1 - g t_i)^{\otimes L}}{\Pi_I}} \quad \text{and} \quad \boxed{\Pi_I \equiv \prod_{i \in \bar{I}} w(t_i)^{(-1)^{P_i}}}. \quad (\text{II.231})$$

¹⁴In what follows, we will show that they do indeed define a Bäcklund flow, which will justify the denomination of “nested T-operators”.

We will also show that with this explicit definition of the T- and Q-operators, the TQ-relation (II.158) is satisfied, and that for each I , $T_I^{(\lambda)}(\mathbf{u})$ obeys the CBR determinant formula. We will also show how the “dressing” procedure discussed in section II.2.2.1 gives a simple determinant expression of $T_I^{(\lambda)}(\mathbf{u})$. Finally, this expression will allow to show that these operators obey the linear system (II.154, II.155) which defines the Bäcklund transform, and they also satisfy the polynomiality conditions out of which the spectrum can be deduced (as it was done in section II.2.2.4).

II.3.2.1 Proof of the TQ-relation

The first thing which can easily be shown is that the TQ-relation is satisfied by the operators defined above. At the level of eigenvalues, this relation reduces to the TQ -relation which was written in (II.158).

Let us show that the T-operators defined above by (II.225) obey the TQ-relation

$$T_{I\Delta j}^{1,s}(\mathbf{u}) \cdot Q_I(\mathbf{u}) - Q_{I\Delta j}(\mathbf{u}) \cdot T_I^{1,s}(\mathbf{u}) = x_j T_{I\Delta j}^{1,s-1}(\mathbf{u} + 1) \cdot Q_I(\mathbf{u} - 1). \quad (\text{II.232})$$

At the level of generating series, this relation reads

$$\mathcal{W}_{I\Delta j}(\mathbf{u}; z) \cdot Q_I(\mathbf{u}) - Q_{I\Delta j}(\mathbf{u}) \cdot \mathcal{W}_I(\mathbf{u}; z) = x_j z \mathcal{W}_{I\Delta j}(\mathbf{u} + 1; z) \cdot Q_I(\mathbf{u} - 1). \quad (\text{II.233})$$

On the other hand, a particular case of the main identity on co-derivatives (II.127) (proved in section II.1.5.2) is

$$\begin{aligned} (z - t_j) & \left[\bigotimes_{i=1}^L (\mathbf{u}_i + 1 + \hat{D}) \quad w(z)w(t_j)\mathbf{\Pi}_{I\Delta j} \right] \cdot \left[\bigotimes_{i=1}^L (\mathbf{u}_i + \hat{D}) \quad \mathbf{\Pi}_{I\Delta j} \right] \\ & = z \left[\bigotimes_{i=1}^L (\mathbf{u}_i + 1 + \hat{D}) \quad w(z)\mathbf{\Pi}_{I\Delta j} \right] \cdot \left[\bigotimes_{i=1}^L (\mathbf{u}_i + \hat{D}) \quad w(t_j)\mathbf{\Pi}_{I\Delta j} \right] \\ & \quad - t_j \left[\bigotimes_{i=1}^L (\mathbf{u}_i + \hat{D}) \quad w(z)\mathbf{\Pi}_{I\Delta j} \right] \cdot \left[\bigotimes_{i=1}^L (\mathbf{u}_i + 1 + \hat{D}) \quad w(t_j)\mathbf{\Pi}_{I\Delta j} \right]. \end{aligned} \quad (\text{II.234})$$

From the definition (II.231) of $\mathbf{\Pi}_I$ and B_I , we can notice that $w(t_j)\mathbf{\Pi}_{I\Delta j} = \mathbf{\Pi}_I$, and multiply by $B_{I\Delta j} \cdot B_I = B_I \cdot B_{I\Delta j}$, to get

$$\begin{aligned} (z - t_j)B_I & \cdot \left[\bigotimes_{i=1}^L (\mathbf{u}_i + 1 + \hat{D}) \quad w(z)\mathbf{\Pi}_I \right] \cdot B_{I\Delta j} \cdot \left[\bigotimes_{i=1}^L (\mathbf{u}_i + \hat{D}) \quad \mathbf{\Pi}_{I\Delta j} \right] \\ & = z B_{I\Delta j} \cdot \left[\bigotimes_{i=1}^L (\mathbf{u}_i + 1 + \hat{D}) \quad w(z)\mathbf{\Pi}_{I\Delta j} \right] \cdot B_I \cdot \left[\bigotimes_{i=1}^L (\mathbf{u}_i + \hat{D}) \quad \mathbf{\Pi}_I \right] \\ & \quad - t_j B_{I\Delta j} \cdot \left[\bigotimes_{i=1}^L (\mathbf{u}_i + \hat{D}) \quad w(z)\mathbf{\Pi}_{I\Delta j} \right] \cdot B_I \cdot \left[\bigotimes_{i=1}^L (\mathbf{u}_i + 1 + \hat{D}) \quad \mathbf{\Pi}_I \right]. \end{aligned} \quad (\text{II.235})$$

To get this expression we used the fact that for any $\mathbf{\Pi} = \prod_{k=1}^n (w(z_k))^{a_k}$, and any \mathbf{u}_i 's, we have the commutation relation

$$\left((f(g))^{\otimes L}, \left[\bigotimes_{i=1}^L (\mathbf{u}_i + \hat{D}) \quad \mathbf{\Pi} \right] \right) = 0. \quad (\text{II.236})$$

This relation was already shown in section II.1.6 if $\mathbf{\Pi}$ is the character χ_λ , and by linearity, it holds for an arbitrary sum of characters. It was shown in section II.1.5.2 (in the second proof of the main identity on co-derivatives) that $\mathbf{\Pi} = \prod_{k=1}^n (w(z_k))^{a_k}$ is a linear combination of characters χ_λ , hence the relation (II.236). This relation allowed to commute the B's through other factors in order to derive (II.235) from (II.234).

We can now see that, in each term of (II.235), the factor to the right is a Q-operator (in the limit $\forall i, t_i \rightarrow 1/x_i$). The other factors contain $w(z) = \text{Sdet} \frac{1}{1-gz}$ (see appendix A). To produce the correct function $\mathcal{W}_I(\mathbf{u}; z)$, we actually need to replace $w(z)$ with $w_I(z)$ or $w_{I\Delta j}(z)$ defined by (II.146). To this end we multiply (II.235) by $\frac{w_{I\Delta j}(z)}{w(z)} = \frac{1}{w_{I\Delta \bar{j}}(z)}$, to get (in the limit $\forall i, t_i \rightarrow 1/x_i$):

$$\begin{aligned} & \lim_{\forall i, t_i \rightarrow 1/x_i} -t_j \frac{1-z/t_j}{w_{I\Delta \bar{j}}(z)} B_I \cdot \left[\bigotimes_{i=1}^L (\mathbf{u}_i + 1 + \hat{D}) \quad w(z) \mathbf{\Pi}_I \right] \cdot Q_{I\Delta j}(\mathbf{v} + 1) \\ &= z \lim_{\forall i, t_i \rightarrow 1/x_i} \frac{1}{w_{I\Delta \bar{j}}(z)} B_{I\Delta j} \cdot \left[\bigotimes_{i=1}^L (\mathbf{u}_i + 1 + \hat{D}) \quad w(z) \mathbf{\Pi}_{I\Delta j} \right] \cdot Q_I(\mathbf{v}) \\ & \quad - \lim_{\forall i, t_i \rightarrow 1/x_i} t_j \frac{1}{w_{I\Delta \bar{j}}(z)} B_{I\Delta j} \cdot \left[\bigotimes_{i=1}^L (\mathbf{u}_i + \hat{D}) \quad w(z) \mathbf{\Pi}_{I\Delta j} \right] \cdot Q_I(\mathbf{v} + 1) \end{aligned} \quad (\text{II.237})$$

$$\text{where } \mathbf{v} \equiv \mathbf{u} - k_{\bar{I}} + m_{\bar{I}} = \mathbf{u} - k_{I\Delta \bar{j}} + m_{I\Delta \bar{j}} - 1. \quad (\text{II.238})$$

In the left-hand-side, in the limit $\forall i, t_i \rightarrow 1/x_i$, the factor $\frac{1-z/t_j}{w_{I\Delta \bar{j}}(z)}$ becomes $\frac{1-z x_j}{w_{I\Delta \bar{j}}(z)} = \frac{1}{w_{\bar{I}}(z)}$. As it is shown in the appendix B.3, this factor can be ‘‘commuted’’ to the right of the co-derivatives due to the presence of the factor B_I . In the right-hand-side of (II.3.2.1), the same argument allows to commute the factor $\frac{1}{w_{I\Delta \bar{j}}(z)}$ to the right of the co-derivatives. If we remember that $\frac{w(z)}{w_{I\Delta \bar{j}}(z)} = w_{I\Delta j}(z)$, we get

$$\begin{aligned} & -1/x_j \lim_{\forall i, t_i \rightarrow 1/x_i} B_I \cdot \left[\bigotimes_{i=1}^L (\mathbf{u}_i + 1 + \hat{D}) \quad w_I(z) \mathbf{\Pi}_I \right] \cdot Q_{I\Delta j}(\mathbf{v} + 1) \\ &= z \lim_{\forall i, t_i \rightarrow 1/x_i} B_{I\Delta j} \cdot \left[\bigotimes_{i=1}^L (\mathbf{u}_i + 1 + \hat{D}) \quad w_{I\Delta j}(z) \mathbf{\Pi}_{I\Delta j} \right] \cdot Q_I(\mathbf{v}) \\ & \quad - 1/x_j \lim_{\forall i, t_i \rightarrow 1/x_i} B_{I\Delta j} \cdot \left[\bigotimes_{i=1}^L (\mathbf{u}_i + \hat{D}) \quad w_{I\Delta j}(z) \mathbf{\Pi}_{I\Delta j} \right] \cdot Q_I(\mathbf{v} + 1). \end{aligned} \quad (\text{II.239})$$

This equation (II.239) can at last be written as

$$\begin{aligned} & -1/x_j \mathcal{W}_I(\mathbf{v} + 1; z) \cdot \mathcal{Q}_{I\Delta j}(\mathbf{v} + 1) \\ & = z \mathcal{W}_{I\Delta j}(\mathbf{v} + 2; z) \cdot \mathcal{Q}_I(\mathbf{v}) - 1/x_j \mathcal{W}_{I\Delta j}(\mathbf{v} + 1; z) \cdot \mathcal{Q}_I(\mathbf{v} + 1), \end{aligned} \quad (\text{II.240})$$

which is the TQ-relation (II.233) at point $\mathbf{u} = \mathbf{v} + 1$.

We have then proven the TQ-relation, at all levels of nesting, and the proof relied mainly on the main identity on co-derivatives (II.127).

II.3.2.2 Hirota equation

It is also possible to show that at all nesting levels I , the T-operators defined in (II.225) satisfy the CBR formula

$$\mathbb{T}_I^{(\lambda)}(\mathbf{u}) = \frac{\left| \left(\mathbb{T}_I^{1, \lambda_j + i - j}(\mathbf{u} + 1 - i) \right)_{1 \leq i, j \leq |\lambda|} \right|}{\prod_{k=1}^{|\lambda|-1} \mathcal{Q}_I(\mathbf{u} - k)}. \quad (\text{II.241})$$

It is not straightforward to prove it with the methods of section II.1.4, because the denominator is more complicated than just $\prod_{i=1}^L \mathbf{u}_i$, so that the expansion around $\mathbf{u}_i \rightarrow \infty$ would be less direct than in section II.1.4.

On the other hand, it was shown in section II.1.5.2 that the CBR formula (II.80) is equivalent to the determinant expression (II.119), which is itself equivalent to the bilinear relation (II.117). By the same argument, the ‘‘nested CBR formula’’ (II.241) is equivalent to a determinant relation and to the bilinear relation

$$\begin{aligned} & (z_1 - z_n) \mathcal{W}_I(\mathbf{u} + 1; z_1, \dots, z_n) \cdot \mathcal{W}_I(\mathbf{u}; z_2, \dots, z_{n-1}) \\ & = z_1 \mathcal{W}_I(\mathbf{u} + 1; z_1, \dots, z_{n-1}) \cdot \mathcal{W}_I(\mathbf{u}; z_2, \dots, z_n) \\ & \quad - z_n \mathcal{W}_I(\mathbf{u}; z_1, \dots, z_{n-1}) \cdot \mathcal{W}_I(\mathbf{u} + 1; z_2, \dots, z_n) \end{aligned} \quad (\text{II.242})$$

where $\mathcal{W}_I(\mathbf{u}; z_1, \dots, z_m) \equiv \lim_{\forall i, t_i \rightarrow 1/x_i} \mathbb{B}_I \cdot \left[\bigotimes_{i=1}^L \left(\mathbf{u}_i + \hat{\mathbb{D}} \right) w_I(z_1) w_I(z_{l+1}) w_I(z_{l+2}) \cdots w_I(z_m) \mathbb{\Pi}_I \right]$, (II.243)

where $\mathbb{\Pi}_I$ and \mathbb{B}_I are defined by (II.231).

In order to prove the relation (II.242), one simply has to remember that $w_I(z) = \frac{w(z)}{w_I(z)}$, and that the appendix B.3 allows to move the factor $\frac{1}{w_I(z)}$ to the left of all co-derivatives. This allows to write

$$\mathcal{W}_I(\mathbf{u}; z_1, \dots, z_m) = \prod_{k=l}^m \frac{1}{w_I(z_k)} \lim_{\forall i, t_i \rightarrow 1/x_i} \mathbb{B}_I \cdot \left[\bigotimes_{i=1}^L \left(\mathbf{u}_i + \hat{\mathbb{D}} \right) \left(\prod_{k=l}^m w(z) \right) \mathbb{\Pi}_I \right]. \quad (\text{II.244})$$

Due to this remark, the relation (II.242) is easy to prove from (II.128) by choosing $\mathbf{\Pi} = \mathbf{\Pi}_I (\prod_{k=2}^{n-1} w(z))$, multiplying by B_I (which commutes with the other operators) and taking the limit $t_i \rightarrow 1/x_i$.

This proves that the “nested CBR formula” (II.241) holds, and as a consequence, the following “nested Hirota equation” also holds:

$$\boxed{T_I^{a,s}(\mathbf{u}+1)T_I^{a,s}(\mathbf{u}) = T_I^{a+1,s}(\mathbf{u}+1)T_I^{a-1,s}(\mathbf{u}) + T_I^{a,s-1}(\mathbf{u}+1)T_I^{a,s+1}(\mathbf{u})}. \quad (\text{II.245})$$

Moreover, there is a general commutation relation

$$\left(\left[\mathbf{u} - \theta_i + \hat{D} \right] \mathbf{\Pi} \quad , \quad \bigotimes_{i=1}^L \left(\mathbf{v} - \theta_i + \hat{D} \right) \mathbf{\Pi}' \right) \Big|_- = 0, \quad (\text{II.246})$$

which is valid when $\mathbf{\Pi}$ and $\mathbf{\Pi}'$, are of the form $\prod_{k=1}^n (w(z_k))^{a_k}$, as in (II.128). This relation is obtained from (II.100), using the fact that $\mathbf{\Pi}$ and $\mathbf{\Pi}'$ are linear combinations of characters, as shown in section II.1.5.2 (in the second proof of the main identity on co-derivatives). Due to the form (II.244) of the generating series of the T-operators, this commutation relation implies

$$\forall \mathbf{u}, \mathbf{v}, s, s', I, J, \quad \left(T_I^{1,s}(\mathbf{u}), T_J^{1,s'}(\mathbf{v}) \right) \Big|_- = 0. \quad (\text{II.247})$$

Finally, the “nested CBR formula” (II.241) allows to deduce the commutation relation

$$\boxed{\forall \mathbf{u}, \mathbf{v}, \lambda, \mu, I, J \quad \left(T_I^{(\lambda)}(\mathbf{u}), T_J^{(\mu)}(\mathbf{v}) \right) \Big|_- = 0}. \quad (\text{II.248})$$

II.3.2.3 QQ-relations and Wronskian expressions

Let us now prove that the T-operators which we defined in equation (II.225) correspond indeed to the Bäcklund flow of section II.2.2. First, one can easily prove that the Q-operators defined in (II.230) obey the following QQ-relation

$$Q_{I\Delta j\Delta k}(\mathbf{u})Q_I(\mathbf{u}-1) = \left| \begin{array}{cc} x_j Q_{I\Delta j}(\mathbf{u}) & x_k Q_{I\Delta k}(\mathbf{u}) \\ Q_{I\Delta j}(\mathbf{u}-1) & Q_{I\Delta k}(\mathbf{u}-1) \end{array} \right| / (x_j - x_k). \quad (\text{II.249})$$

It is proven directly¹⁵ from the main identity on co-derivatives, like in the proof of (II.232) (see [12KLT]).

As in section II.1.5, it is then straightforward to show that (II.249) is equivalent to the determinant expression

$$Q_{I\Delta j_1\Delta j_2\Delta \dots \Delta j_n}(\mathbf{u}) = \frac{\left| \left(x_{j_k}^{1-l} Q_{I\Delta j_k}(\mathbf{u}-l+1) \right)_{1 \leq k, l \leq n} \right|}{\Delta(x_{j_1}, x_{j_2}, \dots, x_{j_n}) \prod_{k=1}^{n-1} Q_I(\mathbf{u}-k)}, \quad (\text{II.250})$$

$$\text{where } \Delta(x_{j_1}, x_{j_2}, \dots, x_{j_n}) \equiv \left| \left(x_{j_k}^{1-l} \right)_{1 \leq k, l \leq n} \right| \quad (\text{II.251})$$

¹⁵ An other proof of this QQ-relation could be obtained by repeating the arguments of section II.2.2, which allow to obtain (II.249) from (II.232). But with this method, it is not straightforward to derive the denominator $(x_j - x_k)$.

which holds for arbitrary $I \subset \{1, 2, \dots, K + M\}$ and $\mathbf{j}_1, \mathbf{j}_2, \dots, \mathbf{j}_n$ such that the \mathbf{j}_k are distinct and obey

$$\forall k \in \llbracket 1, n \rrbracket, \quad \begin{cases} (-1)^{p_{\mathbf{j}_k}} = 1 & \text{and } \mathbf{j}_k \notin I \\ \text{or} \\ (-1)^{p_{\mathbf{j}_k}} = -1 & \text{and } \mathbf{j}_k \in I \end{cases}. \quad (\text{II.252})$$

In the case of the $\text{GL}(K)$ group, this allows to write every Q-operator as a determinant, in terms of the $K + 1$ operators $Q_\emptyset(\mathbf{u}), Q_1(\mathbf{u}), Q_2(\mathbf{u}), \dots, Q_K(\mathbf{u})$ as

$$Q_I(\mathbf{u}) = \frac{\left| (x_j^{1-k} Q_j(\mathbf{u} - k + 1))_{\substack{j \in I \\ 1 \leq k \leq |I|}} \right|}{\Delta((x_j)_{j \in I}) \prod_{k=1}^{|I|-1} Q_\emptyset(\mathbf{u} - k)}. \quad (\text{II.253})$$

We will even see (in section II.3.3) that in this expression, the operator $Q_\emptyset(\mathbf{u})$ in the denominator is a \mathbf{u} -independent operator which commutes with all T- and Q-operators. (In other words, $Q_\emptyset(\mathbf{u}) = 1$ up to a normalization).

For the $\text{GL}(K|M)$ groups, a very similar expression is written as:

$$Q_I(\mathbf{u}) = \frac{\left| (x_j^{1-k} Q_j(\mathbf{u} - k + 1))_{\substack{j \in J \\ 1 \leq k \leq |J|}} \right|}{\Delta((x_{F \Delta j})_{j \in J}) \prod_{k=1}^{|J|-1} Q_F(\mathbf{u} - k)}, \quad (\text{II.254})$$

$$\text{where } F \equiv \{\mathbf{j} \in \llbracket 1, K + M \rrbracket \mid (-1)^{p_{\mathbf{j}}} = -1\} \quad (\text{II.255})$$

$$\text{and } J \equiv (F \cup I) \setminus (F \cap I). \quad (\text{II.256})$$

This result, is very natural in the notations above (it just follows from (II.250)), and it was called ‘‘bosonization trick’’ in [11GKLT], because it allows to manipulate the $\text{GL}(K|M)$ QQ-relations using the same expressions as in the $\text{GL}(K)$ case. An important difference with (II.253) is nevertheless that the operator $Q_F(\mathbf{u})$ in the denominator is a non trivial polynomial in the variable \mathbf{u} .

Determinant expression of $\text{GL}(K)$ T-operators Next one can easily show that with these definitions (II.225,II.229) of T- and Q-operators, the expression (II.170) (which defines the ‘‘dressing procedure’’ derived from the TQ-relation) of the generating series of T-functions holds at the level of operators. Hence, we get an expression of T-operators for symmetric representations in terms of Q-operators. By plugging the expression (II.253) of Q-operators we can get a simple expression of these T-operators. In the $\text{GL}(K)$ case, that gives the expression

$$T^{1,s}(\mathbf{u}) = Q_\emptyset(\mathbf{u} - K) \cdot \frac{\left| \left(x_j^{1-k+s \theta(1-k)} Q_j(\mathbf{u} - k + 1 + s \theta(1-k)) \right)_{1 \leq j, k \leq K} \right|}{\Delta(x_1, \dots, x_K) Q_\emptyset(\mathbf{u} + s - 1) \prod_{a=2}^K Q_\emptyset(\mathbf{u} - a)}, \quad (\text{II.257})$$

$$\text{where } \theta(n) = \begin{cases} 1 & \text{if } n \geq 0 \\ 0 & \text{otherwise} \end{cases}. \quad (\text{II.258})$$

This expression can be used to express the T-operators associated to arbitrary Young diagrams, by means of the CBR formula (II.80). This gives the following Wronskian expression, for the GL(K) T-operators:

$$\boxed{T^{(\lambda)}(\mathbf{u}) = Q_{\emptyset}(\mathbf{u} - \mathbf{K}) \cdot \frac{\left| \left(x_j^{1-k+\lambda_k} Q_j(\mathbf{u} - k + 1 + \lambda_k) \right)_{1 \leq j, k \leq K} \right|}{\Delta(x_1, \dots, x_K) \prod_{k=1}^K Q_{\emptyset}(\mathbf{u} - k + \lambda_k)}}. \quad (\text{II.259})$$

Of course, the same expression is obtained as easily at an arbitrary nesting level and it reads

$$T_I^{(\lambda)}(\mathbf{u}) = Q_{\emptyset}(\mathbf{u} - |I|) \cdot \frac{\left| \left(x_j^{1-k+\lambda_k} Q_j(\mathbf{u} - k + 1 + \lambda_k) \right)_{\substack{j \in I \\ 1 \leq k \leq |I|}} \right|}{\Delta \left((x_j)_{j \in I} \right) \prod_{k=1}^{|I|} Q_{\emptyset}(\mathbf{u} - k + \lambda_k)}, \quad (\text{II.260})$$

which holds if $|\lambda| \leq |I|$. By contrast, the T-operator is zero if $|\lambda| > |I|$, because $\chi_{\lambda}(g_I)$ is zero in (II.225). Here we can notice that the Bäcklund transforms, which decrease the size of the set I , simply amount to keeping the minor (II.260) of the determinant (II.259).

In order to generalize this to super-groups, it is instructive to show how this expression simplifies for rectangular representations:

Rectangular representations First, one can notice that (II.257) is equivalent to

$$T^{1,s}(\mathbf{u}) = \sum_{j=1}^K \frac{x_j^{s+K-1} Q_{\{j\}}(\mathbf{u} + s) Q_j(\mathbf{u} - 1)}{Q_{\emptyset}(\mathbf{u} + s - 1) \prod_{\substack{1 \leq k \leq K \\ k \neq j}} (x_j - x_k)}. \quad (\text{II.261})$$

This can be seen by expanding the determinant (II.257) with respect to the first column, and noticing that the minors which remain are exactly Q-operators, because they are of the form (II.253). For an arbitrary rectangular representation $\lambda_{[a,s]} \equiv (\underbrace{s, s, \dots, s, s}_{a \text{ times}}, 0, 0, \dots)$, the determinant (II.259) can also be expanded with respect to

the a first columns (in these columns, the Q-operators are shifted by $\lambda_k = s$, whereas $\lambda_k = 0$ for the other columns). This expansion gives

$$\boxed{T^{a,s}(\mathbf{u}) = \sum_{\substack{B \subset \llbracket 1, K \rrbracket \\ |B|=a}} \frac{Q_B(\mathbf{u} + s) Q_{\bar{B}}(\mathbf{u} - a) \prod_{i \in B} x_i^{s+K-a}}{Q_{\emptyset}(\mathbf{u} + s - a) \prod_{i \in B} \prod_{j \in \bar{B}} (x_i - x_j)},} \quad (\text{II.262})$$

where the sum runs over all subsets $B \subset \llbracket 1, K \rrbracket$ of size $|B| = a$.

We see that this expression is a sum of terms of the form $Q_I(\mathbf{u} + s) Q_{\bar{I}}(\mathbf{u} - a)$ (times a simpler factor). At $a = 0$, only $I = \bar{\emptyset}$ is allowed and we recover $T^{0,s}(\mathbf{u}) = Q_{\bar{\emptyset}}(\mathbf{u})$. At $a = 1$, I has the form $\{j\}$ (see (II.261)), and each time a increases by 1, the size of I is increased by one.

Of course the expression (II.262) is less general than (II.260) (because it only applies to rectangular representations), but we will see that it is much easier to manipulate, and to generalize. Moreover, in the next chapters of this manuscript, we will never have to deal with non-rectangular representations.

Expression of T-operators for super-groups If we reproduce the proof of (II.257) (i.e. we plug (II.250) into (II.170)) for the super-group $GL(K|M)$, then we obtain

$$T^{1,s}(\mathbf{u}) = \sum_{\substack{1 \leq j \leq K+M \\ (-1)^{p_j}=1}}^K \frac{x_j^{s+K-M-1} Q_{\{j\}}(\mathbf{u}+s) Q_j(\mathbf{u}-1)}{Q_\emptyset(\mathbf{u}+s-1)} \prod_{\substack{1 \leq k \leq K+M \\ k \neq j}} (x_j - x_k)^{-(-1)^{p_k}} \quad \text{if } s > M - K. \quad (\text{II.263})$$

This super-symmetric generalization of (II.261) holds only if $s > M - K$, whereas if $0 \leq s \leq M - K$, one gets a slightly different expression:

$$T^{1,s}(\mathbf{u}) = (-1)^s \sum_{\substack{F \subset [1, K+M] \\ |F|=s \\ \forall j \in F, (-1)^{p_j} = -1}} \frac{Q_F(\mathbf{u}-1) Q_{\bar{F}}(\mathbf{u}+s) \prod_{i \in F} x_i^{1-s+M-K}}{Q_\emptyset(\mathbf{u}+s-1) \prod_{i \in F} \prod_{j \in \bar{F}} (x_i - x_j)^{-(-1)^{p_j}}} \quad \text{if } s \leq M - K + 1, \quad (\text{II.264})$$

and although it is not obvious, the QQ-relations imply that these two expressions are equivalent when $s = M - K + 1$.

If we use the CBR formula (II.80) to express the T-operators for arbitrary representations, then it is not easy to recast the outcome into the form of a simple determinant like (II.260). However, in the case of rectangular representations it is possible to write expressions analogous to (II.262):

$$T^{a,s}(\mathbf{u}) = \left\{ \begin{array}{l} \sum_{\substack{B \subset [1, K]+M \\ |B|=a \\ \forall j \in B, (-1)^{p_j}=1}} \frac{Q_B(\mathbf{u}+s) Q_{\bar{B}}(\mathbf{u}-a) \prod_{i \in B} x_i^{s+K-M-a}}{Q_\emptyset(\mathbf{u}+s-a) \prod_{i \in B} \prod_{j \in \bar{B}} (x_i - x_j)^{-(-1)^{p_j}}} \\ \text{if } s - a \geq M - K, \\ \\ (-1)^{a \cdot s} \sum_{\substack{F \subset [1, K+M] \\ |F|=s \\ \forall j \in F, (-1)^{p_j} = -1}} \frac{Q_{\bar{F}}(\mathbf{u}+s) Q_F(\mathbf{u}-a) \prod_{i \in F} x_i^{a-s+M-K}}{Q_\emptyset(\mathbf{u}+s-a) \prod_{i \in F} \prod_{j \in \bar{F}} (x_i - x_j)^{-(-1)^{p_j}}} \\ \text{if } s - a \leq M - K. \end{array} \right. \quad (\text{II.265})$$

Once again, we see that this expression is a sum of terms of the form $Q_I(\mathbf{u}+s) Q_{\bar{I}}(\mathbf{u}-a)$ (times a simpler factor). If we first describe the domain $s \geq a + M - K$, we find that at $a = 0$, only $I = \bar{\emptyset}$ is allowed and we recover $T^{0,s}(\mathbf{u}) = Q_{\bar{\emptyset}}(\mathbf{u})$. At $a = 1$, I has the

form $\{\mathbf{j}\}$ where $(-1)^{p_j} = +1$, and each time a increases by 1, I can have one more element \mathbf{j}_k , which must have the grading $(-1)^{p_{j_k}} = +1$. When $a = K$, I contains all the elements with grading $(-1)^{p_{j_k}} = +1$, and we reach a boundary of the lattice. At the boundary we have $T^{K,s}(\mathbf{u}) = Q_B(\mathbf{u} + s)Q_F(\mathbf{u} - K)$ (up to a factor containing $Q_\emptyset(\mathbf{u})$ and the eigenvalues of twist), where $B = F \equiv \{\mathbf{j} \in \llbracket 1, K + M \rrbracket | (-1)^{p_j} = +1\}$ and $F = F \equiv \{\mathbf{j} \in \llbracket 1, K + M \rrbracket | (-1)^{p_j} = -1\}$. Next we can describe the domain where $a \geq s - M + K$. First we can notice that the boundary at $s = M$ has almost the same expression $T^{a,M}(\mathbf{u}) = Q_B(\mathbf{u} + K)Q_F(\mathbf{u} - a)$ as the previous boundary at $a = K$. Then if we decrease s up to zero, we still obtain sums of terms of the form $Q_I(\mathbf{u} + s)Q_{\bar{I}}(\mathbf{u} - a)$, where I has one more element at each step, and this element needs to have the grading $(-1)^{p_{j_k}} = -1$.

Therefore, we see that the structure of the determinant expression (II.265) is essentially the same as (II.262), with a specificity that the indices with grading $(-1)^{p_{j_k}} = +1$ are in some sense associated to the domain $s \geq a + M - K$, whereas the indices with grading $(-1)^{p_{j_k}} = -1$ are associated to the domain $a \geq s - M + K$.

Exactly like for the $GL(K)$ case, the expression (II.265) can be generalized to arbitrary nesting levels.

This concludes the ‘‘dressing’’ process, and shows that the Q -operators obtained by the ‘‘undressing procedure’’ of fig II.7, explicitly constructed by equation (II.225), allow to reconstruct all T -operators.

Bäcklund flow and spectrum of the spin chain We have obtained simple determinant expressions for the T -operators that we have defined in (II.225), which take the particularly simple form (II.262) and (II.265) for rectangular representations. These expressions can also be written at an arbitrary nesting level (see for instance (II.260)).

From this point, some identities on determinants [KLWZ97] (called Plücker identities, which generalize the Jacobi identity (II.103)) show that these determinant expressions imply that these T -operators obey the linear system (II.154, II.155) which defines the Bäcklund transform. This means that we have an explicit, operatorial expression of a Bäcklund flow which satisfies all the expected analyticity properties (indeed, we have shown that it is polynomial, and as shown in the next section II.3.3, the polynomial $Q_\emptyset(\mathbf{u})$ is a constant). As a consequence, this construction gives a derivation of the spectrum of the model.

II.3.3 Degree of the T -operators

By construction, the T -operators of the Bäcklund flow defined by (II.225) are polynomial functions of the variable \mathbf{u} , and we will now show that their degree depends on the eigenspace, and is explicitly given by the operator $\sum_{\mathbf{j} \in I} \mathbf{M}_{\mathbf{j}}$ (where $\mathbf{M}_{\mathbf{j}}$ is the number of particles of type \mathbf{j}). This means that for states $|\psi\rangle \in E_{M_1, M_2, \dots, M_{K+M}}$ (where the set $E_{M_1, M_2, \dots, M_{K+M}}$ was defined in (II.132)), the state $T_I^{(\lambda)}(\mathbf{u})|\psi\rangle$ is a polynomial function of \mathbf{u} which has degree $\sum_{\mathbf{j} \in I} M_{\mathbf{j}}$.

Proof. The most direct way to show this result is to write explicitly the expression (II.225) in terms of \hat{D} -diagrams.

Using this method, we can first find the degree of the polynomials $Q_I(\mathbf{u}) = \lim B_I \cdot \left[\bigotimes_{i=1}^L \left(\mathbf{u}_i + k_{\bar{I}} - m_{\bar{I}} + \hat{D} \right) \Pi_I \right]$ defined in (II.230). The expression of $\left[\bigotimes_{i=1}^L \left(\mathbf{u}_i + k_{\bar{I}} - m_{\bar{I}} + \hat{D} \right) \Pi_I \right]$ in terms of \hat{D} -diagrams is given in appendix B.1. It is given by equation (B.26) when $L = 2$ and a general rule is given in appendix B.1 to write it for arbitrary L . It gives a sum of \hat{D} diagrams multiplied by Π_I . This factor Π_I disappears when $\left[\bigotimes_{i=1}^L \left(\mathbf{u}_i + k_{\bar{I}} - m_{\bar{I}} + \hat{D} \right) \Pi_I \right]$ is multiplied by $B_I = \frac{\prod_{i \in \bar{I}} (1-g t_i)^{\otimes L}}{\Pi_I}$. But this multiplication also introduces the factor $\prod_{i \in \bar{I}} (1-g t_i)^{\otimes L}$, which means that each line of every \hat{D} -diagram should be multiplied by $\prod_{i \in \bar{I}} (1-g t_i)$.

The consequence is that $B_I \cdot \left[\bigotimes_{i=1}^L \left(\mathbf{u}_i + k_{\bar{I}} - m_{\bar{I}} + \hat{D} \right) \Pi_I \right]$ is a sum of \hat{D} -diagrams, where each double vertical line \parallel correspond to the operator $\mathbf{u}_i \prod_{j \in \bar{I}} (1-g t_j)$, whereas the line $\begin{array}{c} \downarrow \\ \mathbf{k} \end{array}$ denotes the operator $g t_{\mathbf{k}} \prod_{j \in \bar{I} \setminus \mathbf{k}} (1-g t_j)$ and the line $\begin{array}{c} \uparrow \\ \mathbf{k} \end{array}$ denotes the operator $\prod_{j \in \bar{I} \setminus \mathbf{k}} (1-g t_j)$.

Therefore, every dependence in \mathbf{u} comes from operators $\mathcal{O}_i^{(0)} = \mathbf{u}_i \prod_{j \in \bar{I}} (1-g t_j)$. If we denote by $(v_j)_{1 \leq j \leq K+M}$ the eigenvectors of g , we see that in the limit $t_i \rightarrow 1/x_i$,

$$\forall j \in \bar{I}, \quad \mathcal{O}_i^{(0)} |v_j\rangle = 0.$$

Hence, the maximal possible degree in \mathbf{u} of $Q_I(\mathbf{u}) |v_{j_1}, v_{j_2}, \dots, v_{j_L}\rangle$ is the number of indices $i \in [1, L]$ such that $\mathcal{O}_i^{(0)}$ does not give 0, i.e. the number of $i \in [1, L]$ such that $j_i \in I$.

This proves that for states belonging to the set $E_{M_1, M_2, \dots, M_{K+M}}$, the degree of $Q_I(\mathbf{u})$ is at most $\sum_{j \in I} M_j$.

In order to conclude the proof, one can check¹⁶ that $Q_\emptyset(\mathbf{u})$ has degree 0 and is given explicitly by

$$Q_\emptyset(\mathbf{u}) = \prod_{k=1}^{K+M} \mathbf{M}_k! \prod_{\substack{j=1 \\ j \neq k}}^{K+M} (1-x_k/x_j)^{\mathbf{M}_k}. \quad (\text{II.266})$$

In the right-hand-side, each \mathbf{M}_k is an operator, hence this identity means that for a state $|\psi\rangle \in E_{M_1, M_2, \dots, M_{K+M}}$, we have $Q_\emptyset(\mathbf{u}) |\psi\rangle = \prod_{k=1}^{K+M} \mathbf{M}_k! \prod_{\substack{j=1 \\ j \neq k}}^{K+M} (1-x_k/x_j)^{\mathbf{M}_k} |\psi\rangle$.

For the $GL(K)$ group, if one of the operators $Q_{\{j\}}(\mathbf{u})$ had a degree smaller than \mathbf{M}_j , then we could write $Q_{\bar{\emptyset}}(\mathbf{u})$ as the Wronskian determinant (II.253) and obtain that $Q_{\bar{\emptyset}}(\mathbf{u})$ would be a polynomial of degree smaller than $\sum_{j=1}^K \mathbf{M}_j = L$. That is impossible because $Q_{\bar{\emptyset}}(\mathbf{u}) = \prod_{i=1}^L \mathbf{u}_i$. Therefore each polynomial $Q_{\{j\}}(\mathbf{u})$ has degree \mathbf{M}_j , and when we write the Wronskian expression (II.260) we deduce that $T_I^{(\lambda)}(\mathbf{u})$ has degree $\sum_{j \in I} \mathbf{M}_j$.

For super-groups, the same conclusion is obtained by a slightly more complicated argument, because we cannot use the relation (II.253). If we denote by $d(P)$ the degree

¹⁶This check is important, because the above arguments would not forbid $Q_\emptyset(\mathbf{u})$ to be equal to zero (or to have some eigenvalues equal to zero).

of the polynomial P , then the QQ-relation implies that

$$d(Q_{I,j,k}) = d(Q_{I,j}(u)) + d(Q_{I,k}(u)) - d(Q_I(u)) \quad (\text{II.267})$$

$$\text{where } I, \mathbf{j}, \mathbf{k} \equiv I \cup \{\mathbf{j}\} \cup \{\mathbf{k}\}, \quad (\text{II.268})$$

even for super-groups. Then we can deduce recursively that $d(Q_I) = \sum_{j \in I} d(Q_{\{j\}})$, so that if any $Q_{\{j\}}(u)$ had a degree smaller than \mathbf{M}_j , then $d(Q_{\bar{0}}(u))$ would be smaller than $\sum_j \mathbf{M}_j = L$. This allows to conclude about the degree of all Q-operators. Finally the expression (II.261) gives the degree of the T-operators associated to symmetric representations, from which the degree is obtained for every representation, using the CBR formula (II.241). \square

II.4 Relation to the classical integrability

As a conclusion to this chapter, it is interesting to note that, as explained in [11AKL⁺] this construction actually corresponds to a general property of the rational τ -functions of the MKP hierarchy. This hierarchy arises for instance in the study of some specific partial differential equations, which are called “integrable” in the sense that they can be solved exactly. In this section we will not introduce completely the classical integrability¹⁷ and the MKP hierarchy, but the reader can find in [11AKL⁺] (and in the references therein), an introduction to the subject, which emphasizes the tools mentioned in this section.

The aim of this section is not to cover in great details this MKP hierarchy, but rather to explain that the construction of the previous section finds a natural interpretation in this context. This shows that the main identity on co-derivatives out of which our construction of the Bäcklund flow was proposed is not just a surprising identity very specific to this model. It is rather a meaningful identity arising in lots of different contexts, which would allow to generalize the construction to other integrable spin chains (non polynomial ones, for instance), or to other integrable systems if we prove that they are related to the MKP hierarchy.

In this section, we will restrict for simplicity to the group $\text{GL}(\mathbb{K})$ as opposed to the super-groups of the previous sections.

II.4.1 The MKP hierarchy and the CBR formula

The KP and MKP hierarchy describe some sets of functions (called τ -functions) which obey a given equation (see below). Several constructions are known for these functions, and each of these functions allows to construct a solution of several integrable differential equations.

More explicitly the τ -functions of the KP hierarchy are specific functions of an infinite sequence $\mathbf{t} = (t_1, t_2, \dots)$ of variables called “times”. A function of \mathbf{t} is called a τ -function

¹⁷The name “classical integrability” emphasizes the fact that it solves differential equations on functions, and not on quantum operators.

of the KP hierarchy if it satisfies

$$\boxed{\oint_{\mathcal{C}} e^{\xi(\mathbf{t}-\mathbf{t}',z)} \tau(\mathbf{t} - [z^{-1}]) \tau(\mathbf{t}' + [z^{-1}]) dz = 0}, \quad (\text{II.269})$$

$$\text{where } \tau(\mathbf{t} + [z^{-1}]) \equiv \tau\left(t_1 + \frac{z^{-1}}{1}, t_2 + \frac{z^{-2}}{2}, t_3 + \frac{z^{-3}}{3} + \dots\right), \quad (\text{II.270})$$

$$\text{and } \xi(\mathbf{t}, z) \equiv \sum_{k \geq 1} t_k z^k. \quad (\text{II.271})$$

In (II.269), the integration over the complex variable z is performed on a contour \mathcal{C} which encloses the singularities of $\tau(\mathbf{t} - [z^{-1}])\tau(\mathbf{t}' + [z^{-1}])$ but not the singularities of $e^{\xi(\mathbf{t}-\mathbf{t}',z)}$.

A very simple example of τ -function is the function

$$\tau(\mathbf{t}) = e^{\sum_{j=1}^K \xi(\mathbf{t}, x_j)}. \quad (\text{II.272})$$

In this case the factor $\tau(\mathbf{t} - [z^{-1}])\tau(\mathbf{t}' + [z^{-1}])$ in (II.269) is equal to $\frac{\tau(\mathbf{t})}{\tau([z^{-1}])}\tau(\mathbf{t}')\tau([z^{-1}])$ which is independent of z and has no singularity. Then the contour \mathcal{C} does not enclose any singularity, and (II.269) holds.

The modified KP hierarchy (or MKP hierarchy) is obtained by adding one more time \mathbf{u} . Then a function $\tau(\mathbf{u}, \mathbf{t})$ is a τ -function of the MKP hierarchy if

$$\boxed{\forall n \in \mathbb{N}, \quad \oint_{\mathcal{C}} e^{\xi(\mathbf{t}-\mathbf{t}',z)} z^n \tau(\mathbf{u} + n, \mathbf{t} - [z^{-1}]) \tau(\mathbf{u}, \mathbf{t}' + [z^{-1}]) dz = 0}, \quad (\text{II.273})$$

where the contour \mathcal{C} encircles all the singularities of $\tau(\mathbf{u} + n, \mathbf{t} - [z^{-1}])\tau(\mathbf{u}, \mathbf{t}' + [z^{-1}])$, but does not encircle any singularity of $e^{\xi(\mathbf{t}-\mathbf{t}',z)} z^n$.

Once again, a very simple τ -function of the MKP hierarchy is given by the function

$$\tau(\mathbf{u}, \mathbf{t}) = e^{\sum_{j=1}^K \xi(\mathbf{t}, x_j)}. \quad (\text{II.274})$$

Expression in terms of Young diagrams These τ -functions are functions of the ‘‘times’’, but they can be transformed into functions $\tau(\mathbf{u}, \lambda)$, which are functions of arbitrary Young diagrams λ :

$$\tau(\mathbf{u}, \mathbf{t}) = \sum_{\lambda} s_{\lambda}(\mathbf{t}) \tau(\mathbf{u}, \lambda) \quad (\text{II.275})$$

$$\text{where } s_{\lambda}(\mathbf{t}) = \left| (h_{\lambda_i - i + j}(\mathbf{t}))_{1 \leq i, j \leq |\lambda|} \right|, \quad (\text{II.276})$$

where $s_{\lambda}(\mathbf{t})$ denote the Schur polynomials, which can be expressed in terms of the symmetric Schur polynomials $h_i = s_{\lambda_{[1,i]}}$ defined by

$$e^{\xi(\mathbf{t}, z)} = \sum_{k \geq 0} h_k(\mathbf{t}) z^k. \quad (\text{II.277})$$

One can show that it is also possible to go the other way round and express $\tau(\mathbf{u}, \lambda)$ as

$$\tau(\mathbf{u}, \lambda) = s_\lambda(\tilde{\partial})\tau(\mathbf{u}, \mathbf{t}) \Big|_{\mathbf{t}=0}, \quad (\text{II.278})$$

$$\text{where } \tilde{\partial} = (\partial_{t_1}, \frac{1}{2}\partial_{t_2}, \frac{1}{3}\partial_{t_3}, \dots). \quad (\text{II.279})$$

For instance, for the τ -function¹⁸ $\tau(\mathbf{u}, \mathbf{t}) = e^{\sum_{j=1}^K \xi(\mathbf{t}, x_j)} = e^{\sum_{k \geq 1} t_k \text{tr}(g^k)}$, the object $s_\lambda(\tilde{\partial})\tau(\mathbf{u}, \mathbf{t})$ is equal to $s_\lambda(\tilde{\mathbf{t}})\tau(\mathbf{u}, \mathbf{t})$ where

$$\tilde{\mathbf{t}} = \left(\text{tr}(g), \frac{\text{tr}(g^2)}{2}, \frac{\text{tr}(g^3)}{3}, \dots \right). \quad (\text{II.280})$$

Therefore the τ -function $\tau(\mathbf{u}, \mathbf{t}) = e^{\sum_{j=1}^K \xi(\mathbf{t}, x_j)}$ is associated to $\tau(\mathbf{u}, \lambda) = s_\lambda(\tilde{\mathbf{t}})$. To understand this object, let us first write (II.277) to obtain $h_k(\tilde{\mathbf{t}})$:

$$\sum_{k \geq 0} h_k(\tilde{\mathbf{t}})z^k = e^{\xi(\tilde{\mathbf{t}}, z)} = e^{\sum_{k \geq 1} z^k \frac{\text{tr}(g^k)}{k}} = e^{-\text{tr} \log(1-gz)} = w(z) \quad (\text{II.281})$$

where $w(z) = \det \frac{1}{1-gz} = \sum_{s=0}^{\infty} z^s \chi^{(s)}(g)$ is the generating series of the symmetric characters (see (A.58)). This immediately implies that $h_s(\tilde{\mathbf{t}}) = \chi^{(s)}(g)$ is the character of g in the symmetric representation $\lambda_{[1, s]}$. Then the equation (II.276) ensures that for an arbitrary Young diagram λ , $s_\lambda(\tilde{\mathbf{t}})$ is the character $\chi_\lambda(g)$. This shows that the τ -function $\tau(\mathbf{u}, \mathbf{t}) = e^{\sum_{j=1}^K \xi(\mathbf{t}, x_j)}$ is associated to $\tau(\mathbf{u}, \lambda) = \chi_\lambda(g)$.

Bilinear identities for τ -functions We have defined τ -functions as functions satisfying the relation (II.273), and we have shown that the simplest example of τ -functions (II.274) was tightly related to characters. We will now see that the relation (II.273) is tightly related to bilinear identities, and we will later see that for well-chosen τ -functions, these bilinear identities correspond to the relations obtained in section II.3 for characters and for T-operators.

Let us choose $n = 1$ and $\mathbf{t}' = \mathbf{t} - [z_1^{-1}] - [z_2^{-1}]$, and write (II.273). The factor $e^{\xi(\mathbf{t}-\mathbf{t}', z)}z^n$ is then equal to

$$e^{\xi([z_1^{-1}]+[z_2^{-1}], z)}z = z e^{\sum_{k \geq 1} \frac{(z/z_1)^k}{k} + \frac{(z/z_2)^k}{k}} \quad (\text{II.282})$$

$$= z e^{-\log(1-z/z_1) - \log(1-z/z_2)} = \frac{z}{(1 - \frac{z}{z_1})(1 - \frac{z}{z_2})}. \quad (\text{II.283})$$

The prescription for the contour \mathcal{C} in (II.273) is that it should encircle all the singularities of $\tau(\mathbf{u} + n, \mathbf{t} - [z^{-1}])\tau(\mathbf{u}, \mathbf{t}' + [z^{-1}])$, but not the singularities of $e^{\xi(\mathbf{t}-\mathbf{t}', z)}z^n$. Moreover, $\tau(\mathbf{u} + n, \mathbf{t} - [z^{-1}])\tau(\mathbf{u}, \mathbf{t}' + [z^{-1}])$ is regular at $z \rightarrow \infty$ where it converges to $\tau(\mathbf{u} + n, \mathbf{t})\tau(\mathbf{u}, \mathbf{t}')$, and that implies that the singularities of $\tau(\mathbf{u} + n, \mathbf{t})\tau(\mathbf{u}, \mathbf{t}')$ lie only in a bounded domain of the complex plane.

¹⁸ Here, $g \in \text{GL}(K)$ denotes a matrix with eigenvalues x_j .

Let us consider a contour \mathcal{C}_∞ which encloses all the singularities of $e^{\xi(\mathbf{t}-\mathbf{t}',z)}z^n\tau(\mathbf{u}+n,\mathbf{t}-[z^{-1}])\tau(\mathbf{u},\mathbf{t}'+[z^{-1}])$. If we choose for instance a circle with a large radius we can compute

$$\oint_{\mathcal{C}_\infty} e^{\xi(\mathbf{t}-\mathbf{t}',z)}z^n\tau(\mathbf{u}+n,\mathbf{t}-[z^{-1}])\tau(\mathbf{u},\mathbf{t}'+[z^{-1}])dz \quad (\text{II.284})$$

$$=2i\pi z_1 z_2 \tau(\mathbf{u}+n,\mathbf{t})\tau(\mathbf{u},\mathbf{t}') \quad (\text{II.285})$$

$$=2i\pi z_1 z_2 \tau(\mathbf{u}+1,\mathbf{t})\tau(\mathbf{u},\mathbf{t}-[z_1^{-1}]-[z_2^{-1}]) \quad (\text{II.286})$$

because the integrand is equivalent to $z_1 z_2 \frac{\tau(\mathbf{u}+n,\mathbf{t})\tau(\mathbf{u},\mathbf{t}')}{z}$, in virtue of (II.282).

The difference between the contour \mathcal{C}_∞ and the contour \mathcal{C} of (II.273) is only the two singularities of $e^{\xi(\mathbf{t}-\mathbf{t}',z)}z^n$, at positions $\mathbf{u}=z_1$ and $\mathbf{u}=z_2$. Thus, the difference between these contours is

$$\begin{aligned} & \left[\oint_{\mathcal{C}_\infty} - \oint_{\mathcal{C}} \right] \left(e^{\xi(\mathbf{t}-\mathbf{t}',z)}z^n\tau(\mathbf{u}+n,\mathbf{t}-[z^{-1}])\tau(\mathbf{u},\mathbf{t}'+[z^{-1}]) \right) dz \\ &= 2i\pi \frac{z_1 z_2}{z_1 - z_2} \left(z_1 \tau(\mathbf{u}+n,\mathbf{t}-[z_1^{-1}])\tau(\mathbf{u},\mathbf{t}'+[z_1^{-1}]) \right. \\ & \quad \left. - z_2 \tau(\mathbf{u}+n,\mathbf{t}-[z_2^{-1}])\tau(\mathbf{u},\mathbf{t}'+[z_2^{-1}]) \right) \\ &= 2i\pi \frac{z_1 z_2}{z_1 - z_2} \left(z_1 \tau(\mathbf{u}+1,\mathbf{t}-[z_1^{-1}])\tau(\mathbf{u},\mathbf{t}-[z_2^{-1}]) \right. \\ & \quad \left. - z_2 \tau(\mathbf{u}+1,\mathbf{t}-[z_2^{-1}])\tau(\mathbf{u},\mathbf{t}-[z_1^{-1}]) \right) \quad (\text{II.287}) \end{aligned}$$

Finally, (II.273), (II.284) and (II.287) allow to conclude that

$$\begin{aligned} & (z_1 - z_2)\tau(\mathbf{u}+1,\mathbf{t})\tau(\mathbf{u},\mathbf{t}-[z_1^{-1}]-[z_2^{-1}]) \\ &= z_1 \tau(\mathbf{u}+1,\mathbf{t}-[z_1^{-1}])\tau(\mathbf{u},\mathbf{t}-[z_2^{-1}]) \\ & \quad - z_2 \tau(\mathbf{u}+1,\mathbf{t}-[z_2^{-1}])\tau(\mathbf{u},\mathbf{t}-[z_1^{-1}]) \quad (\text{II.288}) \end{aligned}$$

This equation is a 3-term consequence of (II.273), and we will now show that the main identity on co-derivatives is nothing but this equation (II.288), written for well-chosen τ -functions.

τ -functions for spin chains In the previous section, we defined the T-operators as $T^{(\lambda)}(\mathbf{u}) = \left[\bigotimes_{i=1}^L (\mathbf{u}_i + \hat{D}) \chi_\lambda(g) \right]$, and we would like to identify them with some $\tau(\mathbf{u}, \lambda)$. If we remember that $\tau(\mathbf{u}, \lambda) = \chi_\lambda(g)$ was associated to $\tau(\mathbf{u}, \mathbf{t}) = e^{\sum_{k \geq 1} t_k \text{tr}(g^k)}$, we see that we have to define

$$\boxed{T(\mathbf{u}, \mathbf{t}) = \left[\bigotimes_{i=1}^L (\mathbf{u}_i + \hat{D}) e^{\sum_{k \geq 1} t_k \text{tr}(g^k)} \right]}. \quad (\text{II.289})$$

Then the $T(\mathbf{u}, \mathbf{t})$ are linear combinations of the previous T-operators, written as

$$T(\mathbf{u}, \mathbf{t}) = \sum_{\lambda} s_{\lambda}(\mathbf{t}) T^{(\lambda)}(\mathbf{u}), \quad (\text{II.290})$$

and therefore they commute with each other.

Let us now show that the main identity on co-derivatives (II.127) is the statement that the function $T(\mathbf{u}, \mathbf{t})$ obeys the relation (II.288).

Proof. First, let us see what $T(\mathbf{u}, \mathbf{t} + [z^{-1}])$ means:

$$\begin{aligned} T(\mathbf{u}, \mathbf{t} + [z^{-1}]) &= \left[\bigotimes_{i=1}^L (\mathbf{u}_i + \hat{D}) \quad e^{\sum_{k \geq 1} (t_k + \frac{z^{-k}}{k}) \text{tr}(g^k)} \right] \\ &= \left[\bigotimes_{i=1}^L (\mathbf{u}_i + \hat{D}) \quad e^{-\text{tr} \log(1-g/z)} e^{\sum_{k \geq 1} t_k \text{tr}(g^k)} \right] \end{aligned} \quad (\text{II.291})$$

$$\begin{aligned} &= \left[\bigotimes_{i=1}^L (\mathbf{u}_i + \hat{D}) \quad w(1/z)\mathbf{\Pi} \right] \\ &\quad \text{where } \mathbf{\Pi} = e^{\sum_{k \geq 1} t_k \text{tr}(g^k)}. \end{aligned} \quad (\text{II.292})$$

Therefore, if we replace $\mathbf{t} \rightsquigarrow \mathbf{t} + [z_1^{-1}] + [z_2^{-1}]$ in (II.288), it reads

$$\begin{aligned} &\left(\frac{1}{z_1} - \frac{1}{z_2} \right) \left[\bigotimes_{i=1}^L (\mathbf{u}_i + 1 + \hat{D}) \quad w(1/z_1)w(1/z_2)\mathbf{\Pi} \right] \cdot \left[\bigotimes_{i=1}^L (\mathbf{u}_i + \hat{D}) \quad \mathbf{\Pi} \right] \\ &= \frac{1}{z_2} \left[\bigotimes_{i=1}^L (\mathbf{u}_i + 1 + \hat{D}) \quad w(1/z_2)\mathbf{\Pi} \right] \cdot \left[\bigotimes_{i=1}^L (\mathbf{u}_i + \hat{D}) \quad w(1/z_1)\mathbf{\Pi} \right] \\ &\quad - \frac{1}{z_2} \left[\bigotimes_{i=1}^L (\mathbf{u}_i + 1 + \hat{D}) \quad w(1/z_1)\mathbf{\Pi} \right] \cdot \left[\bigotimes_{i=1}^L (\mathbf{u}_i + \hat{D}) \quad w(1/z_2)\mathbf{\Pi} \right] \end{aligned} \quad (\text{II.293})$$

This is exactly the equation (II.127), and the condition $\mathbf{\Pi} = \prod_{k=1}^n (w(z_k))$ (resp $\mathbf{\Pi} = \prod_{k=1}^n (w(z_k))^{a_k}$ in (II.128)) corresponds to the case when $\mathbf{t} = 0 + [z_1] + [z_2] + \dots + [z_n]$ (resp $\mathbf{t} = \sum_{k=1}^n a_k [z_k]$). The more general case (where \mathbf{t} is arbitrary) can also be written as a limit of $\mathbf{t} = \sum_{k=1}^n a_k [z_k]$ when n tends to ∞ . \square

We saw in this section that the main identity on co-derivatives is the same as an important identity satisfied by the τ -functions of the MKP hierarchy. We will not detail it here, but we showed in [11AKL⁺] that the main identity on co-derivatives (or more specifically the equivalent CBR formula (II.80)) allows to show that $T(\mathbf{u}, \mathbf{t})$ is indeed a τ -function of the MKP hierarchy.

In the next sections we will see that another property of the T-operators, namely the existence of the polynomial Bäcklund flow defined in section II.3, is also related to the properties of specific τ -functions of this MKP hierarchy (the rational solutions).

II.4.2 The rational solution of the MKP hierarchy

The general polynomial solution of the KP hierarchy was constructed by Krichever in [Kri78] (see also [Kri83, DMKM88]), and can be directly extended to the MKP hierarchy. In this section, we will not reproduce in details this construction, but simply give the

most relevant expressions which allow to compare with the Bäcklund flow introduced in the section II.3.

The general polynomial solution of the MKP hierarchy is given by the determinant

$$\tau(\mathbf{u}, \mathbf{t}) = \frac{\left| (A_i(\mathbf{u} - j, \mathbf{t}))_{1 \leq i, j \leq N} \right|}{\prod_{i=1}^N p_i^{\mathbf{u}}} \quad (\text{II.294})$$

$$\text{where } A_i(\mathbf{u}, \mathbf{t}) = \sum_{m=0}^{d_i} a_{i,m} \partial_z^m (z^{\mathbf{u}} e^{\xi(\mathbf{t}, z)}) \Big|_{z=p_i} \quad (\text{II.295})$$

and it is labeled by an integer $N \geq 0$, by N numbers $\{p_i\}$, by N numbers d_i (which are the degree of the polynomials $\frac{A_i(\mathbf{u}, \mathbf{t})}{p_i^{\mathbf{u}}}$), and by the coefficients $\{a_{i,m}\}$.

If we expand at large \mathbf{u} , we see that

$$A_i(\mathbf{u}, \mathbf{t}) = a_{i,d_i} \mathbf{u}^{d_i} p_i^{\mathbf{u}} e^{\xi(\mathbf{t}, p_i)} + \mathcal{O}(\mathbf{u}^{d_i-1} p_i^{\mathbf{u}}) \quad (\text{II.296})$$

$$\text{and } \tau(\mathbf{u}, \mathbf{t}) = \mathbf{u}^{\sum_i d_i} e^{\sum_{i=1}^N \xi(\mathbf{t}, p_i)} \left| (a_{i,d_i} p_i^{-j})_{1 \leq i, j \leq N} \right| + \mathcal{O}(\mathbf{u}^{(\sum_i d_i)-1}) \quad (\text{II.297})$$

By comparison, $T(\mathbf{u}, \mathbf{t})$ has the large \mathbf{u} asymptotic behavior

$$T(\mathbf{u}, \mathbf{t}) \sim \mathbf{u}^L e^{\sum_{j=1}^K \xi(\mathbf{t}, x_j)} \quad (\text{II.298})$$

as can be seen in (II.289), from which we deduce that $T(\mathbf{u}, \mathbf{t})$ corresponds to $N = K$, $p_i = x_i$ and $\sum_i d_i = L$.

From there, one can see that $A_j(\mathbf{u}, \mathbf{t} + [z^{-1}])$ has a pole when $z \rightarrow p_j = x_j$. That allows to show that the residue of $\tau(\mathbf{u}, \mathbf{t} + [z^{-1}])$ at $z \rightarrow x_i$ gives rise to the smaller determinant

$$\frac{\left| (A_k(\mathbf{u} - l, \mathbf{t}))_{\substack{k \in \bar{j} \\ 1 \leq l \leq N-1}} \right|}{\prod_{i \in \bar{j}} p_i^{\mathbf{u}}}.$$

Hence, this residue is a minor of the original determinant, exactly like the Bäcklund transform reduces a determinant (eg (II.259)) into its minor (eg (II.260)). This explains why the Bäcklund flow was defined in (II.225) by taking a very singular limit $t_i \rightarrow 1/x_i$, which amounts to taking a residue. A more detailed dictionary between this rational solution of MKP and the Bäcklund flow constructed above is given in [11AKL⁺], but we can already see that the Bäcklund transform comes from the limit $z \rightarrow x_j$ of $T(\mathbf{u}, \mathbf{t} + [z^{-1}])$. But as we saw in (II.291), $\mathbf{t} \rightsquigarrow \mathbf{t} + [z^{-1}]$ is equivalent to a multiplication by $w(1/z)$ on the right of all co-derivatives. Therefore, we recover the prescription (II.225) which says (for $\text{GL}(K)$) that every successive Bäcklund transform inserts a $w(t_j)$ on the right of the co-derivatives, and prescribes to take the limit $t_j \rightarrow 1/x_j$.

Moreover, as \mathbf{t} is related (through (II.275)) to the choice representation for the auxiliary space¹⁹, these expressions suggest that Q-operators correspond to a specific (actually infinite-dimensional) choice of representation in the auxiliary space. This approach is frequently used in the literature (see for instance [DM06, DM09, DM11, BŁMS10, FLMS11b]) and can certainly be shown to be equivalent to the present construction.

¹⁹Another way to phrase the same remark is by arguing that in view of (II.63), one should identify what stands to the right of the corederivatives in (II.225) with a character of some representation.

Chapter III

Thermodynamic Bethe Ansätze and Y-systems

As we saw in the introductory chapter I.2, field theories (as opposed to the spin chains studied in the previous chapter) may only be described by the Bethe ansatz in a regime where the spatial dimension is large enough. Therefore this Bethe ansatz is called the asymptotic Bethe ansatz. By contrast this chapter will be devoted to the exact computation of finite-size effects in these theories.

A first step in the study of finite size effects was achieved by Lüscher [Lus86a, Lus86b], who gave (order by order) the first corrections to the asymptotic Bethe ansatz.

But there are also several models for which an exact computation of finite size effects can be obtained, in the sense that a set of (usually integral) equations can be written, which give the exact spectrum of the theory for arbitrary value of the size L . One approach to get these equations is to define an integrable discretization i.e. to write a field theory as the limit of a spin chain. This approach was introduced by Destri and de Vega [DdV87], and the corresponding equations are often called the “DdV” equations. This approach was successfully applied to models such as the Sine-Gordon model and Toda theories, but there still exist several field theories which are believed to be integrable at infinite size but for which we do not know any integrable discretization.

Another method was introduced by A. Zamolodchikov [Zam90], and is called the thermodynamic Bethe ansatz (TBA). This method can be used for many relativistic sigma-models, and will be introduced here in the example of the principal chiral model. This thermodynamic Bethe ansatz seems very general, but one drawback is that unlike the lattice discretization, it often leads to an infinite set of integral equations. It was understood in [GKV09b] that in the particular case of the $SU(2) \times SU(2)$ principal chiral model, this infinite set of equations can be recast into a single non-linear integral equation.

This chapter will introduce an important original result of this thesis: the existence of a general procedure, based on the Q -functions (expected to be the eigenvalues of Q -operators constructed as in the chapter II) which allows to recast the TBA-equations of many theories into a finite set of non-linear integral equations (we will call such a set a “FiNLIE”).

In the present chapter, we will illustrate this method on the example of the principal chiral model, (as in the article [10KL]). As we will see in the next chapter IV, we can also apply this method to the AdS/CFT spectrum.

The section III.1 will motivate the thermodynamic Bethe ansatz on the example of the principal chiral model. It gives rise to a set of equations which describes the spectrum of this field theory. The derivation of these equations for numerous integrable models is well presented in the literature, and the section III.1 does not aim at giving the most rigorous proof of this construction. It is rather designed to introduce the key concepts and hypotheses underlying the thermodynamic Bethe ansatz, and to show the equations that arise from this procedure. These equations will be the starting point of original works of this PhD, presented in the next sections.

The section III.2 gives the typical solution of the Hirota equation in several cases corresponding to different integrable models (to a large extent this was already known in the literature before this PhD (see in particular [KLWZ97]), but some of the results presented here are original results [11GKLT] of this PhD). As explained in this section, this general solution is a key ingredient to write FiNLIEs. Finally the procedure allowing

to write FiNLIEs is illustrated in the case of the principal chiral model, introducing original results of this PhD, written in the article [10KL].

III.1 Example of the principal chiral model

III.1.1 The asymptotic Bethe ansatz

In the asymptotic limit (when the spacial dimension is large enough), the solution of the principal chiral model was obtained by Wiegmann and Polyakov in [Wie84, PW83, PW84]. Let us briefly introduce the model and the main arguments and results of this approach (though without proof).

The principal chiral model is a two-dimensional relativistic field theory characterized by the action

$$\mathcal{S} = \frac{-1}{2\alpha_0} \iint dx dt \operatorname{tr} ([\partial^\mu h] \cdot [\partial_\mu h^{-1}]) = \frac{-1}{2\alpha_0} \iint dx dt \operatorname{tr} (h^{-1} \partial_\mu h)^2 \quad (\text{III.1})$$

where the integration variable x is associated to a periodic space dimension of size L , and the variable $t \in \mathbb{R}$ is associated to the time. The field $h(x, t)$ takes values in $SU(N)$, and the index μ refers to the direction x or t . This action is invariant under Lorentz transformations on the one hand, and on the other hand under the transformations $h \rightsquigarrow h \cdot g$ and $h \rightsquigarrow g \cdot h$ where $g \in SU(N)$ (these two transformations are called $SU(N)_R$ and $SU(N)_L$ respectively). Therefore, this field theory will be called the $SU(N) \times SU(N)$ principal chiral model.

The integrability of this model (in the sense that when L is large, the wave function is described by the Bethe ansatz, and the spectrum is obtained from Bethe equations) can be motivated by writing an infinite set of conserved charges [Pol77], and since the problem is relativistic, the momenta in (I.25) are parameterized by rapidities ϕ_i as follows:

$$p_i = m_i \sinh(\phi_i). \quad (\text{III.2})$$

They are also associated to energies

$$E_i = m_i \cosh(\phi_i). \quad (\text{III.3})$$

In the case of the Heisenberg spin chain, one can note that the function $S(p, p')$ (in (I.15)) can be expressed as $S(p, p') = S(\mathbf{u} - \mathbf{u}')$ where $\mathbf{u} \equiv \frac{e^{ip}}{e^{ip}-1}$ and $\mathbf{u}' \equiv \frac{e^{ip'}}{e^{ip'}-1}$. This means that the spectral parameter \mathbf{u} is an additive parameterization of the momenta. For the principal chiral model, the Lorentz invariance imposes that such an additive parameterization of the momenta is given by the rapidity ϕ and we get $\hat{S}(p_1, p_2) = \hat{S}(\phi)$ where $\phi \equiv \phi_1 - \phi_2$. To have a notation similar to the section II, we will actually denote by the letter \mathbf{u} the quantity

$$\mathbf{u} = \frac{N}{2\pi} \phi. \quad (\text{III.4})$$

In what follows, this quantity \mathbf{u} is actually what we will denote by the word ‘‘rapidity’’.

In the equation (III.2), one can show that there are massive particles of mass m_1 , given by $m_1 = \frac{\Lambda}{\alpha_0} e^{-\frac{4\pi}{N\alpha_0^2}}$ (where Λ is a cut-off). One can also show (see the explanations below and [PW83, Wie84] for more details) that these particles give rise to $N - 1$ different types of bound states (configurations of multiple particles, labeled by $a \in \llbracket 1, N - 1 \rrbracket$) with respective masses

$$m_a = m_1 \frac{\sin \frac{\pi a}{N}}{\sin \frac{\pi}{N}} \quad \text{where } 1 \leq a \leq N - 1. \quad (\text{III.5})$$

In what follows this mass m_1 will usually be set to 1 by rescaling the length L into a dimensionless parameter¹ $L \rightsquigarrow L m_1$. These massive particles carry spins for both $SU(N)_R$ and $SU(N)_L$ i.e. the wave function transforms “covariantly” under the symmetry group $SU(N)_R \times SU(N)_L$. For the massive particles of type $a = 1$, the wave-function transforms as the bifundamental representation $((\mathbb{C}^N)_L \otimes (\mathbb{C}^N)_R)$ under the symmetry group $SU(N)_R \times SU(N)_L$.

Then the matrix $\hat{S}(p_1, p_2) = \hat{S}(\mathbf{u})$ is constrained by the relation (I.27), by a unitarity condition $\hat{S}(\mathbf{u}) \cdot \hat{S}(-\mathbf{u}) = 1$ (analogous to the constraint that for two particles, the two conditions (I.17) can be recast into $e^{iLp_j} = S(p_j, p_k)$), and by a crossing condition (see (III.9)) which describes how the \hat{S} -matrix transforms when particles are replaced with anti-particles. As shown in [ZZ79], this allows to fix the \hat{S} -matrix uniquely (up to a scalar factor χ_{CDD}) and to get for the fundamental massive particles (of type $a = 1$ in (III.5))

$$\hat{S}_{i,j}(\mathbf{u}) = \chi_{\text{CDD}}(\mathbf{u}) \cdot S_0(\mathbf{u}) \frac{\hat{R}_L(\mathbf{u})}{\mathbf{u} - \mathbf{i}} \otimes S_0(\mathbf{u}) \frac{\hat{R}_R(\mathbf{u})}{\mathbf{u} - \mathbf{i}}, \quad (\text{III.6})$$

$$\text{where } S_0(\mathbf{u}) = \frac{\Gamma(\mathbf{i} \frac{\mathbf{u}}{N}) \Gamma(-\mathbf{i} \frac{\mathbf{u} + \mathbf{i}}{N})}{\Gamma(-\mathbf{i} \frac{\mathbf{u}}{N}) \Gamma(\mathbf{i} \frac{\mathbf{u} - \mathbf{i}}{N})}, \quad \chi_{\text{CDD}}(\mathbf{u}) = \frac{\sinh(\pi \frac{\mathbf{u} + \mathbf{i}}{N})}{\sinh(\pi \frac{\mathbf{u} - \mathbf{i}}{N})}, \quad (\text{III.7})$$

$$\text{and } \hat{R}_L(\mathbf{u}) \otimes \hat{R}_R(\mathbf{u}) = (\mathbf{u} \mathbb{I} + \mathbf{i} \mathcal{P}_{i_L, j_L}) \cdot (\mathbf{u} \mathbb{I} + \mathbf{i} \mathcal{P}_{i_R, j_R}). \quad (\text{III.8})$$

This \hat{S} -matrix acts on the spaces corresponding to the particles i and j , like the operator $R(\mathbf{u})$ of spin chains (see (II.15)), and the main difference is that the “physical space” associated to each particle is $(\mathbb{C}^N)_L \otimes (\mathbb{C}^N)_R$, which contains two copies of \mathbb{C}^N . The operator \mathcal{P}_{i_R, j_R} is the permutation operators (as defined in (I.2)) acting on the spaces $(\mathbb{C}^N)_R$ associated to the particles i and j , while \mathcal{P}_{i_L, j_L} acts the same way on the spaces $(\mathbb{C}^N)_L$.

The “crossing equation” [ZZ79] is the constraint

$$\frac{S_0(\mathbf{u} + \mathbf{i} \frac{N}{2})^2 \chi_{\text{CDD}}(\mathbf{u} + \mathbf{i} \frac{N}{2})}{S_0(\mathbf{u} - \mathbf{i} \frac{N}{2})^2 \chi_{\text{CDD}}(\mathbf{u} - \mathbf{i} \frac{N}{2})} = \left(\frac{\mathbf{u} + \mathbf{i} \frac{N}{2} - \mathbf{i}}{\mathbf{u} + \mathbf{i} \frac{N}{2}} \frac{\mathbf{u} - \mathbf{i} \frac{N}{2} + \mathbf{i}}{\mathbf{u} - \mathbf{i} \frac{N}{2}} \right)^2 \quad (\text{III.9})$$

on the scalar part of the \hat{S} -matrix. We will actually use another (slightly stronger)

¹In the Bethe equation, the mass and the length L only appear in the expression $e^{i L p} = e^{i L m_a \sinh \phi}$, which means that the eigenstates only depend on the product $L m_1$.

equation below

$$\prod_{n=-\frac{N-1}{2}}^{\frac{N-1}{2}} S_0(\mathbf{u} + \mathbf{i}n)^2 \chi_{\text{CDD}}(\mathbf{u} + \mathbf{i}n) = \left(\frac{\mathbf{u} - \mathbf{i}\frac{N-1}{2}}{\mathbf{u} + \mathbf{i}\frac{N-1}{2}} \right)^2 \quad (\text{III.10})$$

which implies the previous one (III.9). One can see that this equation actually comes from

$$\prod_{n=-\frac{N-1}{2}}^{\frac{N-1}{2}} \hat{S}_0(\mathbf{u} + \mathbf{i}n) = - \frac{\mathbf{u} - \mathbf{i}\frac{N-1}{2}}{\mathbf{u} + \mathbf{i}\frac{N-1}{2}}. \quad (\text{III.11})$$

In (III.9,III.10), we see that when $N \geq 3$, the non-trivial factor χ_{CDD} is a zero-mode² (in the sense that $\prod_{n=-\frac{N-1}{2}}^{\frac{N-1}{2}} \chi_{\text{CDD}}(\mathbf{u} + \mathbf{i}n) = 1$), and is not imposed by the unitarity and crossing symmetry. This factor is actually chosen to have a minimal number (and multiplicity) of poles in the \hat{S} -matrix. Indeed one expects that the only poles of the \hat{S} -matrix (inside the physical strip $-\frac{N}{2} \leq \text{Im}(\mathbf{u}) \leq \frac{N}{2}$) should be simple poles and correspond to bound states. In (III.6), the pole at $\mathbf{u} = \pm \mathbf{i}$ indicates the existence of a bound state, made of two fundamental particles with rapidities $\phi_1 = \phi_0 - \mathbf{i}\frac{\pi}{N}$ and $\phi_2 = \phi_0 + \mathbf{i}\frac{\pi}{N}$ (so that $\mathbf{u} = \frac{N}{2\pi}(\phi_1 - \phi_2) = -\mathbf{i}$). This bound state has an energy $m_1 (\cosh(\phi_1) + \cosh(\phi_2)) = m_1 \frac{\sin(\frac{2\pi}{N})}{\sin(\frac{\pi}{N})} \cosh(\phi_0)$ and a momentum $m_1 (\sinh(\phi_1) + \sinh(\phi_2)) = m_1 \frac{\sin(\frac{2\pi}{N})}{\sin(\frac{\pi}{N})} \sinh(\phi_0)$. It can therefore be viewed as a single particle of rapidity ϕ_0 , and mass $m_1 \frac{\sin \frac{2\pi}{N}}{\sin \frac{\pi}{N}}$. It is also possible to compute the \hat{S} -matrix describing the interaction of this bound state with the fundamental particles, and then the pole structure allows to find other bound states (corresponding to bound states of three particles) and to recursively identify the spectrum (III.5).

As we see, these bound states with mass m_a can be viewed as being made of several fundamental particles with specific rapidities (such as $\phi_1 = \phi_0 - \mathbf{i}\frac{\pi}{N}$ and $\phi_2 = \phi_0 + \mathbf{i}\frac{\pi}{N}$). Therefore we will restrict (for massive particles) to the fundamental particles with mass m_1 .

Bethe equations To summarize the Bethe equations obtained in this approach, let us first remind how the various excited states are parameterized. In the introductory section I.2 it appeared that in the Bethe ansatz, the excited states are labeled by rapidities of “particles” (denoting different excitations). In the present case, these “particles” are of several types:

- Massive particles with the mass $m_1 = 1$ (after rescaling L). We will denote by $\theta_1, \theta_2, \dots, \theta_{d(0)}$ the rapidities of these particles. These particles interact through the \hat{S} -matrix (III.6).

²If $N = 2$, then the χ_{CDD} factor is equal to -1 which does not contain any information. This is because there is no bound state, i.e. no pole of the \hat{S} -matrix inside the physical strip.

- “SU(N) Magnons” corresponding to the spin waves carried by the set of the $SU(N)_L$ and $SU(N)_R$ spins of the massive particles. As we saw in chapter II for an $SU(N)$ spin chain, the rapidities of these “magnons” are the roots of the $N - 1$ polynomials $Q_{I_k}(\mathbf{u})$ along a nesting path and they obey the Bethe equations (II.189), (or (II.202) in terms of Bethe roots).

Here, by contrast, we have both $SU(N)_L$ and $SU(N)_R$ spins. Therefore, we have two sets of polynomial Q -functions corresponding to the $SU(N)_L$ and $SU(N)_R$ spins. With the notations of chapter II, these polynomials are denoted as $Q_{\{1\}}^{(R)}(\mathbf{u})$, $Q_{\{1,2\}}^{(R)}(\mathbf{u})$, \dots , $Q_{\{1,2,\dots,N-1\}}^{(R)}(\mathbf{u})$ for the $SU(N)_R$ spins and $Q_{\{1\}}^{(L)}(\mathbf{u})$, $Q_{\{1,2\}}^{(L)}(\mathbf{u})$, \dots , $Q_{\{1,2,\dots,N-1\}}^{(L)}(\mathbf{u})$ for the $SU(N)_L$ spins.

The rapidities of these particles can be conveniently encoded into the polynomials

$$Q_{[\mathbf{m}]}(\mathbf{u}) \equiv Q_{\{1,2,\dots,N-\mathbf{m}\}}^{(R)} \left(-\frac{\mathbf{m}}{2} - i\mathbf{u} \right) \quad \text{if } 1 \leq \mathbf{m} \leq N - 1 \quad (\text{III.12})$$

$$Q_{[0]}(\mathbf{u}) \equiv \varphi(\mathbf{u}) \equiv \prod (\mathbf{u} - \theta_i) \quad (\text{III.13})$$

$$Q_{[\mathbf{m}]}(\mathbf{u}) \equiv Q_{\{1,2,\dots,N+\mathbf{m}\}}^{(L)} \left(\frac{\mathbf{m}}{2} - i\mathbf{u} \right) \quad \text{if } 1 - N \leq \mathbf{m} \leq -1 \quad (\text{III.14})$$

$$Q_{[\mathbf{m}]}(\mathbf{u}) \equiv 1 \quad \text{if } \mathbf{m} = \pm N. \quad (\text{III.15})$$

Their roots $\mathbf{u}^{(\mathbf{m},n)}$ are defined as

$$Q_{[\mathbf{m}]}(\mathbf{u}) = \prod_{n=1}^{d^{(\mathbf{m})}} (\mathbf{u} - \mathbf{u}^{(\mathbf{m},n)}) . \quad (\text{III.16})$$

where \mathbf{m} denotes the different type of “particles”, $d^{(\mathbf{m})}$ denotes the number of particle of type \mathbf{m} , and $\{\mathbf{u}^{(\mathbf{m},n)} | 1 \leq n \leq d^{(\mathbf{m})}\}$ is the set of the rapidities of all the particles of type \mathbf{m} .

The polynomial $Q_{[0]}(\mathbf{u})$, which describes the massive particles, will be of special importance, and it will also be denoted³ as φ .

One can notice that, compared to the Q -functions of chapter II, the change of variables above contains a “rotation” $\mathbf{u} \rightsquigarrow -i\mathbf{u}$. This is physically quite natural because in chapter II we had a change of variables $\mathbf{u}^{(n)} \equiv \frac{e^{ip_n}}{1 - e^{ip_n}}$ (for the roots of the polynomial $Q_{\{1,2,\dots,N-1\}}^{(R)}(\mathbf{u})$). This relation implied that $p_n \in \mathbb{R} \Leftrightarrow \text{Re}(\mathbf{u}^{(n)}) = -\frac{1}{2}$. That is why we change the variables as $Q_{[1]}(\mathbf{u}) \equiv Q_{\{1,2,\dots,N-1\}}^{(R)} \left(-\frac{1}{2} - i\mathbf{u} \right)$. For other Q -functions, we will see that the change of variables (III.12-III.15) allows to have real Q -functions, and that will allow to consistently write the thermodynamic Bethe ansatz.

Then the Bethe equations take the same form as (II.202), up to the change of variables (III.12-III.15), and up to the specific behavior of the massive particles, involving the \hat{S} -matrix (III.6). We will also set the twist to one $g = \mathbb{I}$ (as compared to chapter II).

³One should not confuse the symbol ϕ in (III.2, III.3) with the symbol φ (which denotes the polynomial $Q_{[0]}(\mathbf{u})$).

Explicitly, these Bethe equations read

$$\begin{aligned} \forall \mathbf{m} \in \llbracket -N + 1, N - 1 \rrbracket \setminus \{0\}, \quad \forall n \in \llbracket 1, d^{(\mathbf{m})} \rrbracket, \\ -1 = \frac{Q_{[\mathbf{m}-1]}(\mathbf{u}^{(\mathbf{m},n)} - \mathfrak{i}/2) Q_{[\mathbf{m}]}(\mathbf{u}^{(\mathbf{m},n)} + \mathfrak{i}) Q_{[\mathbf{m}+1]}(\mathbf{u}^{(\mathbf{m},n)} - \mathfrak{i}/2)}{Q_{[\mathbf{m}-1]}(\mathbf{u}^{(\mathbf{m},n)} + \mathfrak{i}/2) Q_{[\mathbf{m}]}(\mathbf{u}^{(\mathbf{m},n)} - \mathfrak{i}) Q_{[\mathbf{m}+1]}(\mathbf{u}^{(\mathbf{m},n)} + \mathfrak{i}/2)} \end{aligned} \quad (\text{III.17})$$

$$\begin{aligned} \forall n \in \llbracket 1, d^{(0)} \rrbracket, \\ e^{\mathfrak{i} L \sinh(\frac{2\pi}{N}\theta_n)} = \frac{-1}{S(\theta_n)} \frac{Q_{[1]}(\theta_n - \mathfrak{i}/2) Q_{[-1]}(\theta_n - \mathfrak{i}/2)}{Q_{[1]}(\theta_n + \mathfrak{i}/2) Q_{[-1]}(\theta_n + \mathfrak{i}/2)} \end{aligned} \quad (\text{III.18})$$

$$\text{where } S(\mathbf{u}) \equiv \prod_{\mathbf{k}=1}^{d^{(0)}} S_0(\mathbf{u} - \theta_{\mathbf{k}})^2 \chi_{\text{CDD}}(\mathbf{u} - \theta_{\mathbf{k}}). \quad (\text{III.19})$$

The Bethe equation (III.17) describes the ‘‘magnons’’ (as in chapter II) and is sometimes called the ‘‘auxiliary Bethe equation’’, as opposed to the Bethe equation (III.18) which describes the massive particles.

This can also be written (in the spirit of (II.202)) as

$$\boxed{\begin{aligned} \forall \mathbf{m} \in \llbracket 1 - N, N - 1 \rrbracket \\ \forall n \in \llbracket 1, d^{(\mathbf{m})} \rrbracket, \end{aligned} \quad e^{\mathfrak{i} L p^{(\mathbf{m})}(\mathbf{u}^{(\mathbf{m},n)})} = \prod_{\substack{\mathbf{k} \in \llbracket 1 - N, N - 1 \rrbracket \\ \mathbf{l} \in \llbracket 1, d^{(\mathbf{k})} \rrbracket \\ (\mathbf{k}, \mathbf{l}) \neq (\mathbf{m}, n)}} S^{(\mathbf{m}),(\mathbf{k})}(\mathbf{u}^{(\mathbf{m},n)} - \mathbf{u}^{(\mathbf{k},\mathbf{l})})}, \quad (\text{III.20})$$

where the product on the right-hand-side runs over all the (\mathbf{k}, \mathbf{l}) such that $\mathbf{k} \neq \mathbf{m}$ or $\mathbf{l} \neq n$, i.e. over all the other Bethe roots except the root $\mathbf{u}^{(\mathbf{m},n)}$. In (III.20), we define

$$p^{(\mathbf{m})}(\mathbf{u}) = \begin{cases} 0 & \text{if } \mathbf{m} \neq 0 \quad (\text{i.e. for magnons}) \\ \sinh\left(\frac{2\pi}{N}\theta_n\right) & \text{if } \mathbf{m} = 0 \quad (\text{i.e. for massive particles}) \end{cases}, \quad (\text{III.21})$$

$$S^{(\mathbf{m}),(\mathbf{k})}(\mathbf{u} - \mathbf{v}) = \begin{cases} \frac{\frac{\mathbf{u}-\mathbf{v}+\mathfrak{i}}{\mathbf{u}-\mathbf{v}-\mathfrak{i}}}{1} & \text{if } \mathbf{k} = \mathbf{m} \neq 0 \\ \frac{S_0(\mathbf{u}-\mathbf{v})^2 \chi_{\text{CDD}}(\mathbf{u}-\mathbf{v})}{1} & \text{if } \mathbf{k} = \mathbf{m} = 0 \\ \frac{\frac{\mathbf{u}-\mathbf{v}-\frac{\mathfrak{i}}{2}}{\mathbf{u}-\mathbf{v}+\frac{\mathfrak{i}}{2}}}{1} & \text{if } \mathbf{k} = \mathbf{m} \pm 1 \\ 1 & \text{otherwise} \end{cases}. \quad (\text{III.22})$$

These constraints give equations on the rapidities θ_n of the particles. Each excited state is associated to a solution of these equations, and the corresponding energy is

$$E = \sum_n \cosh\left(\frac{2\pi}{N}\theta_n\right). \quad (\text{III.23})$$

III.1.2 Thermodynamic Bethe ansatz

The thermodynamic Bethe ansatz is based on a ‘‘double Wick rotation’’ trick which goes as follows: in (III.1), the space is periodic $x \in [0, L]$ while the time $t \in \mathbb{R}$ is not bounded.

It means that (x, t) belongs to a cylinder of radius L . This cylinder can be viewed as a torus where one dimension has size L , and the other one has size $R \rightarrow \infty$. On this torus, we can write the partition function Z as an Euclidean path integral, which is dominated by the vacuum when $R \rightarrow \infty$ (i.e. at zero temperature):

$$Z \approx e^{-R E_0(L)} \quad R \rightarrow \infty, \quad (\text{III.24})$$

where E_0 is the vacuum energy, and the symbol \approx denotes a logarithmic equivalent.

In this Euclidean path integral, the roles of space and time are symmetric, and they can be exchanged (the corresponding transformation is called a ‘‘Matsubara transform’’). This means that Z can as well be computed from the same principal chiral model with a space period $R \rightarrow \infty$ and an Euclidean time period L . Back to the Minkowski signature, it means that the time has an imaginary period L , which is equivalent to the existence of an inverse temperature $\beta = L$. Therefore we see that a model with finite size is mapped to a ‘‘mirror’’ model with an infinite size but a finite temperature. E_0 is then extracted from the free energy in the mirror model:

$$E_0(L) = f(L). \quad (\text{III.25})$$

In this mirror model, the space period is $R \rightarrow \infty$ so that the the Bethe equations given in the previous section can be used to compute the free energy $f(L)$. Although the Bethe equations that we can write in this mirror model take exactly the same form as (III.17-III.18), the roots $\mathbf{u}^{(\mathbf{m},n)}$ entering these equations are ‘‘virtual particles’’ which do not have the same physical meaning as the original ones. Moreover, the finite temperature $\beta = L$ gives a large number of (virtual) particles, and the Bethe equations have to be written with such a large number of ‘‘particles’’ (i.e. of excitations).

III.1.2.1 The string hypothesis

Let us investigate the properties of the Bethe equations (III.17) for the magnons, in the mirror model where the temperature is finite and thus each of the polynomials $Q_{[\mathbf{m}]}(\mathbf{u})$ has a very large degree⁴. We will motivate the statement that, in the ‘‘mirror’’ theory with a finite temperature, the roots will be grouped (in the complex plane) in a very specific way. This statement will be called the ‘‘string hypothesis’’, as its derivation below is not completely rigorous.

Let us assume that the Bethe roots contributing to the free energy are symmetric with respect to complex-conjugacy, i.e. that there is no spontaneous breaking of the symmetry of the Bethe equations (III.17, III.18) under complex-conjugation, then we can see that if a given root $\mathbf{u}^{(\mathbf{m},n)}$ (where $\mathbf{m} \neq 0$) has a positive imaginary part, then

$$\frac{Q_{[\mathbf{m}-1]}(\mathbf{u}^{(\mathbf{m},n)} - \mathfrak{i}/2)Q_{[\mathbf{m}+1]}(\mathbf{u}^{(\mathbf{m},n)} - \mathfrak{i}/2)}{Q_{[\mathbf{m}-1]}(\mathbf{u}^{(\mathbf{m},n)} + \mathfrak{i}/2)Q_{[\mathbf{m}+1]}(\mathbf{u}^{(\mathbf{m},n)} + \mathfrak{i}/2)} \rightarrow 0 \quad (\text{III.26})$$

⁴We remind that the degree $d^{(\mathbf{m})}$ of $Q_{[\mathbf{m}]}(\mathbf{u})$ is equal to the number of particles of type \mathbf{m} .

because⁵ the polynomials $Q_{[\mathbf{m}-1]}(\mathbf{u}^{(\mathbf{m},n)} + \mathbf{i}/2)$ and $Q_{[\mathbf{m}+1]}(\mathbf{u}^{(\mathbf{m},n)} + \mathbf{i}/2)$ are real and their degree becomes infinite when the number of particles is infinite.

Due to the Bethe equation (III.17), we therefore expect that in this limit we have $\frac{Q_{[\mathbf{m}]}(\mathbf{u}^{(\mathbf{m},n)} + \mathbf{i})}{Q_{[\mathbf{m}]}(\mathbf{u}^{(\mathbf{m},n)} - \mathbf{i})} \rightarrow \infty$, which means that $Q_{[\mathbf{m}]}(\mathbf{u}^{(\mathbf{m},n)} - \mathbf{i}) \rightarrow 0$, i.e. that there exists⁶ another Bethe root $\mathbf{u}^{(\mathbf{m},l)}$ such that $\mathbf{u}^{(\mathbf{m},l)} = \mathbf{u}^{(\mathbf{m},n)} - \mathbf{i}$. If $\mathbf{u}^{(\mathbf{m},n)} - \mathbf{i}$ also has a positive imaginary part, then we can apply the same argument to deduce that there is another root with rapidity $\mathbf{u}^{(\mathbf{m},n)} - 2\mathbf{i}$. Iteratively, we deduce that if a Bethe root does not lie on the real axis, then it belongs to a set of roots separated by a distance \mathbf{i} . As we assume that the configuration of roots is symmetric with respect to complex-conjugacy, these sets of roots have the form

$$\mathbf{u}_a^{([\mathbf{m},k],n)} = \mathbf{u}^{([\mathbf{m},k],n)} + \mathbf{i} \left(a - \frac{k+1}{2} \right) \quad \text{where } a \in \llbracket 1, k \rrbracket, \quad (\text{III.27})$$

where k is the number of roots in this ‘‘string’’. This labeling of the roots is illustrated in figure III.1, which shows a simplified configuration of Bethe roots where only two types of strings are present.

Here $\mathbf{u}^{([\mathbf{m},k],n)} \in \mathbb{R}$ is the rapidity of ‘‘the center of the string’’, and the roots $\mathbf{u}_a^{([\mathbf{m},k],n)}$ belonging to this ‘‘string’’ stand above and below it on the complex plane. This allows to formally introduce a new type of particles labeled by $[\mathbf{m}, k]$, and which corresponds to the strings of k elementary particles of type \mathbf{m} .

This means that when $\mathbf{m} \neq 0$, the polynomial $Q_{[\mathbf{m}]}(\mathbf{u})$ can be written in terms of the real numbers $\mathbf{u}^{([\mathbf{m},k],n)}$, which correspond to the centers of the strings:

$$Q_{[\mathbf{m}]}(\mathbf{u}) = \prod_{k=1}^{\infty} \prod_{n=1}^{d^{([\mathbf{m},k])}} \prod_{a=1}^k \left(\mathbf{u} - \mathbf{u}^{([\mathbf{m},k],n)} - \mathbf{i} \left(a - \frac{k+1}{2} \right) \right), \quad (\text{III.28})$$

where we have denoted by $d^{([\mathbf{m},k])}$ the number of such sets of roots (of $Q_{[\mathbf{m}]}(\mathbf{u})$) which have size k .

For the polynomial $Q_{[0]}(\mathbf{u})$ (i.e. for massive particles) there also exist bound-states, discussed in the previous section, and which give rise to the spectrum (III.5). Hence for particles of type $\mathbf{m} = 0$, we also write (III.28), with the important difference that $k \leq N - 1$, i.e. that these bound states cannot contain more than $N - 1$ roots.

The relation (III.28) is the so-called ‘‘string hypothesis’’, and it will guide us to find the configurations of roots contributing to the free energy of the finite-temperature principal chiral model.

⁵ To understand the limit (III.26), one can think that if $\mathbf{u}^{(\mathbf{m},n)} = x + iy$, then the ratio $\frac{Q_{[\mathbf{m}-1]}(\mathbf{u}^{(\mathbf{m},n)} - \mathbf{i}/2)Q_{[\mathbf{m}+1]}(\mathbf{u}^{(\mathbf{m},n)} - \mathbf{i}/2)}{Q_{[\mathbf{m}-1]}(\mathbf{u}^{(\mathbf{m},n)} + \mathbf{i}/2)Q_{[\mathbf{m}+1]}(\mathbf{u}^{(\mathbf{m},n)} + \mathbf{i}/2)}$ is roughly speaking equal to $\left(\frac{x+iy-\mathbf{i}/2}{x+iy+\mathbf{i}/2} \right)^M$, where M denotes the degree of the polynomial $Q_{[\mathbf{m}-1]}(\mathbf{u})Q_{[\mathbf{m}+1]}(\mathbf{u})$ (hence M is very large). But if $y > 0$, then $|x + iy + \mathbf{i}/2| > |x + iy - \mathbf{i}/2|$ and we obtain (III.26) in the limit $M \rightarrow \infty$.

⁶ To motivate the existence of a Bethe root with rapidity $\mathbf{u}^{(\mathbf{m},l)} = \mathbf{u}^{(\mathbf{m},n)} - \mathbf{i}$, we assume that the convergence $Q_{[\mathbf{m}]}(\mathbf{u}^{(\mathbf{m},n)} - \mathbf{i}) \rightarrow 0$ does not reduce to the same argument as in footnote 5.

This can be motivated for instance by saying that the degree of $Q_{[\mathbf{m}]}(\mathbf{u})$ is smaller than the degree of $Q_{[\mathbf{m}-1]}(\mathbf{u})$ (resp $Q_{[\mathbf{m}+1]}(\mathbf{u})$) if \mathbf{m} is positive (resp negative), as it was seen in section II.3.3.

Using this ‘‘string hypothesis’’, we should write the Bethe equations (III.17,III.18) for roots $\mathbf{u}^{(\mathbf{m},n)}$ which belong to a given string (i.e. $\mathbf{u}^{(\mathbf{m},n)} = \mathbf{u}_a^{([\mathbf{m},k],n)}$). In fact, the equation (III.17) is not always completely well defined because the numerator contains $Q_{[\mathbf{m}]}(\mathbf{u}^{(\mathbf{m},n)} + \mathbf{i})$ which is zero if $a < k$ (because (III.27) ensures that $Q_{[\mathbf{m}]}(\mathbf{u})$ has another zero at $\mathbf{u}^{(\mathbf{m},n)} + \mathbf{i}$), and (by the same argument) the denominator is zero if $a > 1$. Therefore, we should write (III.17) for each $a \in \llbracket 1, k \rrbracket$ and multiply the resulting equations.

The most concise way to do this is with the notations of (III.21,III.22). With these notations, one gets the following Bethe equation on the ‘‘strings’’:

$$\boxed{\begin{aligned} \forall \mathbf{m} \in \llbracket 1 - N, N - 1 \rrbracket, \quad \forall k \geq 1, \quad \forall n \in \llbracket 1, d^{([\mathbf{m},k])} \rrbracket, \\ e^{\mathbf{i} L p^{([\mathbf{m},k])}(\mathbf{u}^{([\mathbf{m},k],n)})} = \prod_{\substack{\mathbf{j} \in \llbracket 1 - N, N - 1 \rrbracket \\ l \geq 0 \\ \mathbf{i} \in \llbracket 1, d^{([\mathbf{j},l])} \rrbracket \\ ([\mathbf{m},k],n) \neq ([\mathbf{j},l],\mathbf{i})}} S^{([\mathbf{m},k]),([\mathbf{j},l])}(\mathbf{u}^{([\mathbf{m},k],n)} - \mathbf{u}^{([\mathbf{j},l],\mathbf{i})}) \end{aligned}}, \quad (\text{III.29})$$

$$\text{where } S^{([\mathbf{m},k]),([\mathbf{j},l])}(\mathbf{u} - \mathbf{v}) \equiv \prod_{s=-\frac{k-1}{2}}^{\frac{k-1}{2}} \prod_{s'=-\frac{l-1}{2}}^{\frac{l-1}{2}} S^{(\mathbf{m}),(\mathbf{j})}(\mathbf{u} - \mathbf{v} + \mathbf{i}(s - s')), \quad (\text{III.30})$$

$$\text{and } p^{([\mathbf{m},k])}(\mathbf{u}) \equiv \sum_{s=-\frac{k-1}{2}}^{\frac{k-1}{2}} p^{(\mathbf{m})}(\mathbf{u} + \mathbf{i}s) = \begin{cases} 0 & \text{if } \mathbf{m} \neq 0 \\ \frac{\sin \frac{\pi k}{N}}{\sin \frac{\pi}{N}} \sinh\left(\frac{2\pi}{N} \mathbf{u}\right) & \text{if } \mathbf{m} = 0 \end{cases}. \quad (\text{III.31})$$

In (III.29), it is implicit that if $\mathbf{m} = 0$, then k should be chosen as $k \leq N - 1$. Moreover, we see that the product in the right-hand-side of (III.29) runs over all the $([\mathbf{j}, l], \mathbf{i})$ such that $\mathbf{j} \neq \mathbf{m}$ or $l \neq k$ or $\mathbf{i} \neq n$.

After taking the log, the equation (III.29) reads

$$\begin{aligned} \forall \mathbf{m} \in \llbracket 1 - N, N - 1 \rrbracket, \quad \forall k \geq 1, \quad \forall n \in \llbracket 1, d^{([\mathbf{m},k])} \rrbracket, \\ 2 \kappa \pi = -L p^{([\mathbf{m},k])}(\mathbf{u}^{([\mathbf{m},k],n)}) + \sum_{\substack{\mathbf{j} \in \llbracket 1 - K, K - 1 \rrbracket \\ l \geq 0 \\ \mathbf{i} \in \llbracket 1, d^{([\mathbf{j},l])} \rrbracket \\ ([\mathbf{m},k],n) \neq ([\mathbf{j},l],\mathbf{i})}} F^{([\mathbf{m},k]),([\mathbf{j},l])}(\mathbf{u}^{([\mathbf{m},k],n)} - \mathbf{u}^{([\mathbf{j},l],\mathbf{i})}) \end{aligned}, \quad (\text{III.32})$$

$$\text{where } F^{([\mathbf{m},k]),([\mathbf{j},l])}(\mathbf{u} - \mathbf{v}) \equiv \frac{1}{\mathbf{i}} \log \left(S^{([\mathbf{m},k]),([\mathbf{j},l])}(\mathbf{u} - \mathbf{v}) \right). \quad (\text{III.33})$$

Here $2 \kappa \pi$ denotes an arbitrary multiple of 2π .

This means that the rapidities $\mathbf{u}^{([\mathbf{m},k],n)}$ of the centers of the strings (III.27) are real numbers, solution of an equation $2 \kappa \pi = f(\mathbf{u}^{([\mathbf{m},k],n)})$, where the function f is a fixed real function (if the rapidities of the other roots are fixed). All the rapidities $\mathbf{u}^{([\mathbf{m},k],n)}$ belong to the set $\left\{ \mathbf{u} \left| \frac{f(\mathbf{u})}{2\pi} \in \mathbb{Z} \right. \right\}$, but there can exist some values of \mathbf{u} such that $2 \kappa \pi = f(\mathbf{u})$ which are not the rapidities $\mathbf{u}^{([\mathbf{m},k],n)}$ of strings (III.27) of roots. Every such value of \mathbf{u} is called a hole.

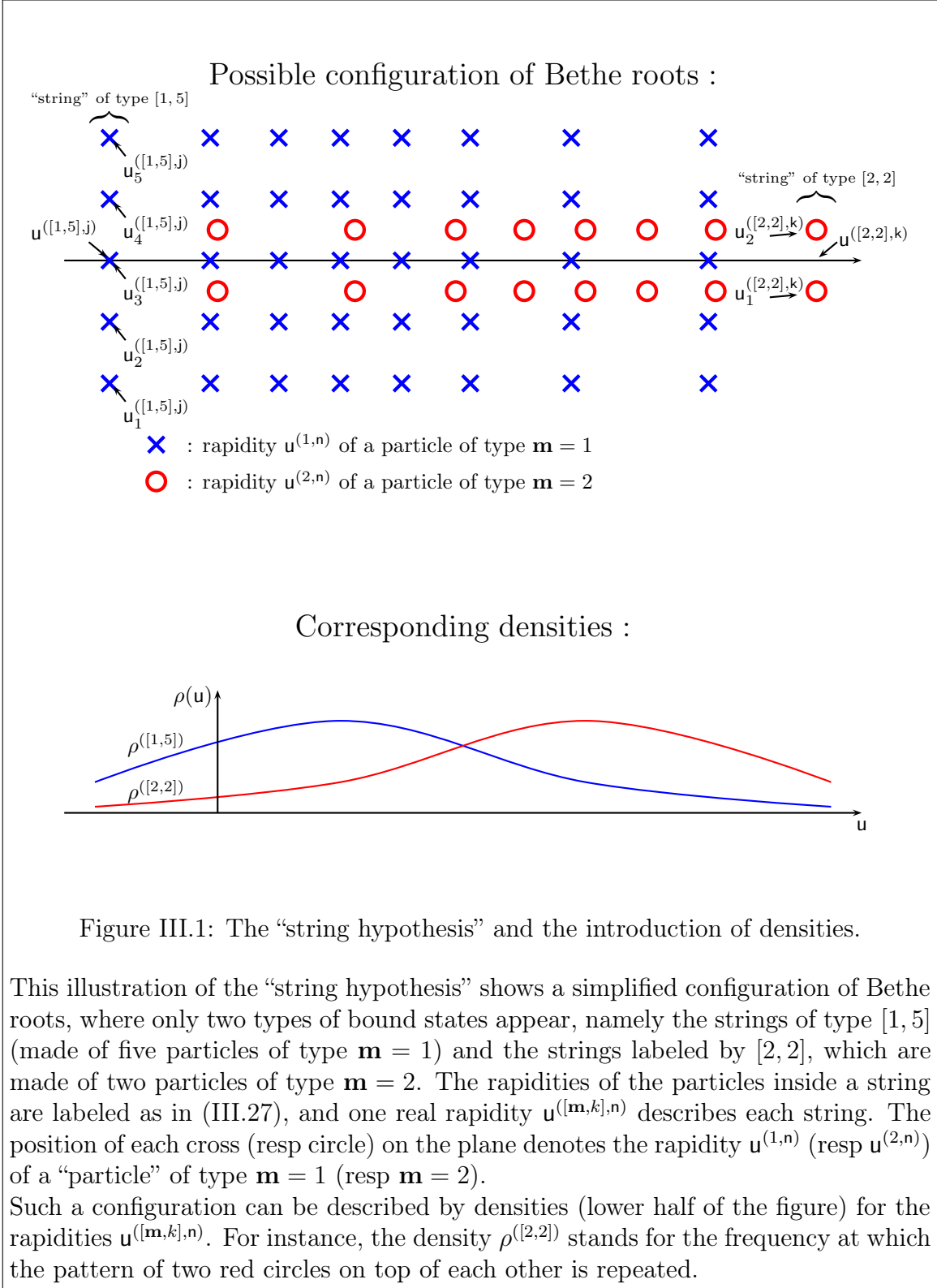

In finite temperature there are many particles (and maybe also many holes), and we can introduce a density ρ of particles and a density $\bar{\rho}$ of holes. They have to obey $\rho + \bar{\rho} = |\partial_u \frac{f}{2\pi}|$. This relation says that the number $\int_u^{u'} (\rho + \bar{\rho}) du$ of holes and particles in the interval $[u, u']$ is equal to the number $|\frac{f(u') - f(u)}{2\pi}|$, which is the number of times that $\frac{f}{2\pi}$ takes an integer value in the interval $[u, u']$ (if f is monotonous in the interval $[u, u']$).

Therefore, we introduce densities of holes and particles for each type $[\mathbf{m}, k]$ of particles (more precisely they are the densities $\rho^{([\mathbf{m}, k])}$ of the centers $\mathbf{u}^{([\mathbf{m}, k], n)} \in \mathbb{R}$ of the strings, as in figure III.1). As explained above, they have to obey the relation

$$\rho^{([\mathbf{m}, k])} + \bar{\rho}^{([\mathbf{m}, k])} = \left| \frac{L}{2\pi} \partial_u p^{([\mathbf{m}, k])}(\mathbf{u}) - \sum_{\substack{\mathbf{j} \in \llbracket 1-K, K-1 \rrbracket \\ l \geq 0}} \int_{\mathbf{v} \in \mathbb{R}} K^{([\mathbf{m}, k]), ([\mathbf{j}, l])}(\mathbf{u} - \mathbf{v}) \rho^{([\mathbf{j}, l])}(\mathbf{v}) d\mathbf{v} \right| \quad (\text{III.34})$$

$$\text{where } K^{([\mathbf{m}, k]), ([\mathbf{j}, l])}(\mathbf{u}) \equiv \frac{1}{2i\pi} \partial_u \log (S^{([\mathbf{m}, k]), ([\mathbf{j}, l])}(\mathbf{u} - \mathbf{v})) . \quad (\text{III.35})$$

In the right-hand-side, the integral $\int_{\mathbf{v} \in \mathbb{R}} K^{([\mathbf{m}, k]), ([\mathbf{j}, l])}(\mathbf{u} - \mathbf{v}) \rho^{([\mathbf{j}, l])}(\mathbf{v}) d\mathbf{v}$ can also be written as $K^{([\mathbf{m}, k]), ([\mathbf{j}, l])} * \rho^{([\mathbf{j}, l])}$ where

$$(f_1 * f_2)(\mathbf{u}) \equiv \int_{\mathbf{v} \in \mathbb{R}} f_1(\mathbf{u} - \mathbf{v}) f_2(\mathbf{v}) d\mathbf{v} \quad (\text{III.36})$$

denotes the usual convolution.

In general the sign inside the absolute value (in (III.34)) is not completely obvious. But it is at least clear that when \mathbf{u} is large enough this sign is positive, (because $\frac{L}{2\pi} \partial_u p^{([\mathbf{m}, k])}(\mathbf{u})$ is very large). We will actually assume that the densities ρ and $\bar{\rho}$ are analytic, and this imposes that this sign is always plus. Therefore, we will actually drop the absolute value in (III.34).

Let us now introduce a new labeling for the densities (i.e. for the different types of particles):

$$\rho^{a,s} \equiv \rho^{([a,s])} \quad \text{if } s > 0 \quad (\text{III.37})$$

$$\rho^{a,0} \equiv \rho^{([0,a])} \quad \text{if } s = 0 \quad (\text{III.38})$$

$$\rho^{a,s} \equiv \rho^{([-a,-s])} \quad \text{if } s < 0 . \quad (\text{III.39})$$

In this notation, the densities are labeled by two integers $(a, s) \in \llbracket 1, N-1 \rrbracket \times \mathbb{Z}$. We will use the same rule to label the densities $\bar{\rho}$ and the kernels K (for instance if $s > 0$ and $s' > 0$, then $\bar{\rho}^{a,s} \equiv \bar{\rho}^{([a,s])}$ and $K^{a,s,a',s'} \equiv K^{([a,s]), ([a',s'])}$). This choice of labeling may not seem natural, but we will see that in these new variables, the equations on the densities will turn out to be quite simple and universal.

III.1.2.2 Minimization of the free energy

In order to compute the path integral (III.24), we should find the configuration of roots having the lowest free energy in the mirror model. This free energy should contain two

terms: one term $E = \int_{\mathbf{u} \in \mathbb{R}} \sum_{a=1}^{N-1} \frac{\sin \frac{\pi a}{N}}{\sin \frac{\pi}{N}} \cosh \left(\frac{2\pi}{N} \mathbf{u} \right) \rho^{(a,0)}(\mathbf{u}) d\mathbf{u}$ corresponding to the energy, and an entropic term.

The entropic term [Zam90] corresponds to the fact that many configurations are described by the same densities of roots. This counterintuitive fact arises because the densities only contain informations about the number $N_h = \bar{\rho}(\mathbf{u})\delta_{\mathbf{u}}$ of holes and the number $N_r = \rho(\mathbf{u})\delta_{\mathbf{u}}$ of roots in a given interval $[\mathbf{u}, \mathbf{u} + \delta_{\mathbf{u}}]$. But the solutions of $2 \kappa \pi = f(\mathbf{u}^{(\mathbf{m},k),n})$ can be reshuffled between roots and holes in

$$\frac{(N_r + N_h)!}{(N_r)!(N_h)!}$$

different ways, without consequence on the densities ρ and $\bar{\rho}$. As the entropy is the logarithm of the number of configurations, one can show [Zam90] that the entropy is equal to

$$\int_{\mathbf{u} \in \mathbb{R}} (\rho + \bar{\rho}) \log(\rho + \bar{\rho}) - \rho \log(\rho) - \bar{\rho} \log(\bar{\rho}) d\mathbf{u}.$$

Therefore, the free energy is given by

$$f(L) = \min_{\rho^{a,s}, \bar{\rho}^{a,s}} \int_{\mathbf{u} \in \mathbb{R}} \left(\sum_{a=1}^{N-1} \frac{\sin \frac{\pi a}{N}}{\sin \frac{\pi}{N}} \cosh \left(\frac{2\pi}{N} \mathbf{u} \right) \rho^{a,0}(\mathbf{u}) - \frac{1}{\beta} \sum_{\substack{a \in \llbracket 1, N-1 \rrbracket \\ s \in \mathbb{Z}}} \rho^{a,s} \log \left(1 + \frac{\bar{\rho}^{a,s}}{\rho^{a,s}} \right) + \bar{\rho}^{a,s} \log \left(1 + \frac{\rho^{a,s}}{\bar{\rho}^{a,s}} \right) \right) d\mathbf{u}, \quad (\text{III.40})$$

where $\beta = L$.

The minimum in (III.40) is a minimum among all the possible densities which satisfy the Bethe equation (III.34). That means that if we vary $\rho^{a,s}$ by an amount $\delta \rho^{a,s}$, then $\bar{\rho}^{a,s}$ has to vary by the amount

$$\delta \bar{\rho}^{a,s} = -\delta \rho^{a,s} - \sum_{\substack{a' \in \llbracket 1, N-1 \rrbracket \\ s' \in \mathbb{Z}}} K^{a,s,a',s'} * \delta \rho^{a',s'}. \quad (\text{III.41})$$

With this constraint, the minimization condition reads

$$0 = L \frac{\delta f}{\delta \rho} = L \sum_{a=1}^{N-1} \frac{\sin \frac{\pi a}{N}}{\sin \frac{\pi}{N}} \cosh \left(\frac{2\pi}{N} \mathbf{u} \right) \delta_{s,0} - \log \left(1 + \frac{\bar{\rho}^{a,s}}{\rho^{a,s}} \right) - \log \left(1 + \frac{\rho^{a,s}}{\bar{\rho}^{a,s}} \right) \frac{\delta \bar{\rho}}{\delta \rho} \quad (\text{III.42})$$

$$= L \sum_{a=1}^{N-1} \frac{\sin \frac{\pi a}{N}}{\sin \frac{\pi}{N}} \cosh \left(\frac{2\pi}{N} \mathbf{u} \right) \delta_{s,0} - \log \left(\frac{\bar{\rho}^{a,s}}{\rho^{a,s}} \right) + \sum_{\substack{a' \in \llbracket 1, N-1 \rrbracket \\ s' \in \mathbb{Z}}} K^{a,s,a',s'} * \log \left(1 + \frac{\rho^{a,s}}{\bar{\rho}^{a,s}} \right) \quad (\text{III.43})$$

This equation (III.43) is the ‘‘TBA equation’’, which is an equation on the ratio $\frac{\rho^{a,s}}{\bar{\rho}^{a,s}}$.

We will see that if we denote this ratio by $Y_{a,s}$, then a simpler ‘‘Y-system equation’’ arises.

III.1.2.3 TBA equations and Y-system equation

The TBA equation (III.43) is an equation on two types of densities ρ and $\bar{\rho}$. It can be rewritten in terms of the quantities

$$Y_{a,s} = \begin{cases} \frac{\rho^{a,s}}{\bar{\rho}^{a,s}} & \text{if } s = 0, \\ \frac{\bar{\rho}^{a,s}}{\rho^{a,s}} & \text{if } s \neq 0. \end{cases} \quad \begin{matrix} \text{(III.44a)} \\ \text{(III.44b)} \end{matrix}$$

For instance, when $s \neq 0$, the TBA equation (III.43) is rewritten as

$$\log(Y_{a,s}) = \sum_{\substack{a' \in \llbracket 1, N-1 \rrbracket \\ s' \in \mathbb{Z}}} K^{a,s,a',s'} * \log\left(1 + (Y_{a',s'})^{\pm 1}\right) \quad \text{if } s \neq 0, \quad \text{(III.45)}$$

where the sign ± 1 is equal to 1 if $s' = 0$ and (resp -1 if $s' \neq 0$).

Then one can compute the quantity $\log\left(\frac{Y_{a,s}(\mathbf{u} + \frac{i}{2})Y_{a,s}(\mathbf{u} - \frac{i}{2})}{Y_{a,s+1}Y_{a,s-1}}\right)$:

$$\log\left(\frac{Y_{a,s}(\mathbf{u} + \frac{i}{2})Y_{a,s}(\mathbf{u} - \frac{i}{2})}{Y_{a,s+1}Y_{a,s-1}}\right) = \sum_{\substack{a' \in \llbracket 1, N-1 \rrbracket \\ s' \in \mathbb{Z}}} K^{a,s,a',s'} * \log\left(1 + (Y_{a',s'})^{\pm 1}\right), \quad \text{(III.46)}$$

$$\text{where } \tilde{K}^{a,s,a',s'}(\mathbf{u}) \equiv K^{a,s,a',s'}\left(\mathbf{u} + \frac{i}{2}\right) + K^{a,s,a',s'}\left(\mathbf{u} - \frac{i}{2}\right) - K^{a,s+1,a',s'}(\mathbf{u}) - K^{a,s-1,a',s'}(\mathbf{u}). \quad \text{(III.47)}$$

But one can show (see equation (30) in [GKKV10]) that this combination \tilde{K} is remarkably simple:

$$\text{if } a = a' \text{ and } |s| > 1 \text{ then } \tilde{K}^{a,s,a',s'}(\mathbf{u}) = \delta_{s,s'+1}\delta(\mathbf{u}) + \delta_{s,s'-1}\delta(\mathbf{u}) \quad \text{(III.48)}$$

$$\text{if } a = a' \pm 1 \text{ and } |s| > 1 \text{ then } \tilde{K}^{a,s,a',s'}(\mathbf{u}) = -\delta_{s,s'}\delta(\mathbf{u}) \quad \text{(III.49)}$$

whereas if $|a - a'| > 1$, then $K^{a,s,a',s'} = 0$ for all s, s' .

From there, we get that if $|s| > 1$, then

$$\boxed{\frac{Y_{a,s}(\mathbf{u} + \frac{i}{2})Y_{a,s}(\mathbf{u} - \frac{i}{2})}{Y_{a,s+1}Y_{a,s-1}} = \frac{1 + 1/Y_{a,s+1}}{1 + 1/Y_{a+1,s}} \frac{1 + 1/Y_{a,s-1}}{1 + 1/Y_{a-1,s}}}. \quad \text{(III.50)}$$

This equation (III.50) is called the Y-system equation.

In this equation, the factor $1 + 1/Y_{a-1,s}$ (resp $1 + 1/Y_{a+1,s}$) should be absent if $a = 1$ (resp $a = N - 1$), because the sum over (a', s') (in (III.45)) does not contain $s' = 0$ or $s' = N$. The condition that this term is absent can also be written as a boundary condition

$$\boxed{Y_{0,s} = Y_{N,s} = \infty}. \quad \text{(III.51)}$$

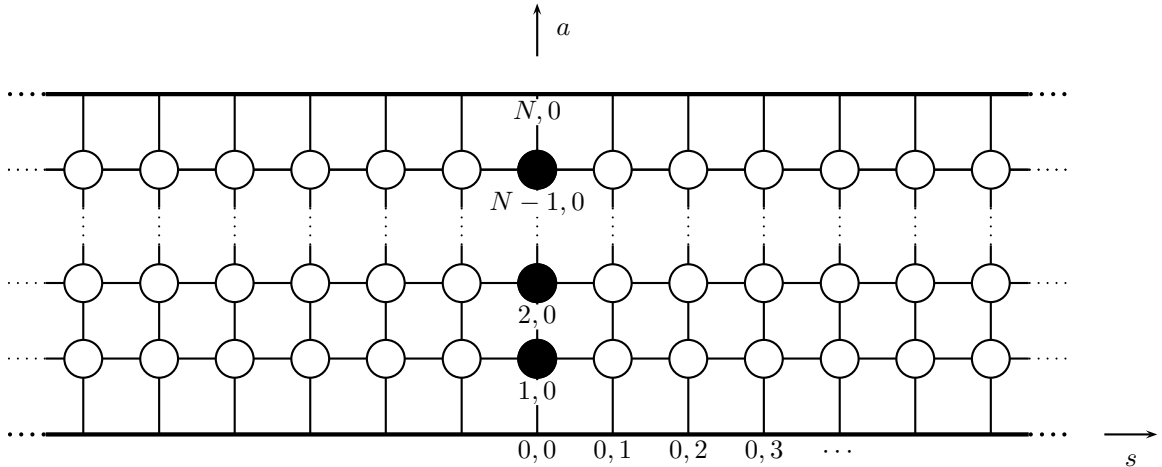

Figure III.2: The (a, s) -lattice for the principal chiral model

When $|s| \leq 1$, the derivation of the Y-system equation (III.50) from the TBA equation (III.43) is more technical. The case $N = 2$ is performed in [GKV09b], where it is also conjectured that it holds as well for $N > 2$.

It is a bit more technical, but the TBA equation (III.43) also implies that (III.50) holds even when $|s| \leq 1$ (see for instance [GKV09b]).

Moreover, one can show [GKV09b] that the free energy $f(L)$ (III.40) of the mirror theory (or the vacuum energy $E_0(L)$ of the original model) can be expressed in terms of these Y-functions as

$$E_0(L) = f(L) = -\frac{1}{N} \sum_{a=1}^{N-1} \frac{\sin \frac{\pi a}{N}}{\sin \frac{\pi}{N}} \int_{u \in \mathbb{R}} \cosh \left(\frac{2\pi}{N} u \right) \log (1 + Y_{a,0}(u)) du \quad (\text{III.52})$$

As we saw, the thermodynamic Bethe ansatz gives rise to the TBA-equation (III.43), which is an equation on the densities of roots and holes for the configurations of Bethe roots which minimize the free energy. Solving this equation allows to compute the free energy in the mirror theory with temperature, i.e. to completely find the vacuum energy (of the initial model) at any finite size. This equation can be rewritten in terms of ratios of densities, called the Y-functions (see for instance (III.45)), and the resulting equations imply the Y-system equation (III.50). This equation is very universal, and the same equation describes the finite-size effects of several other integrable models.

A first point which characterizes this $SU(N) \times SU(N)$ principal chiral model is that (a, s) , which labels the different types of particles, takes values in $\llbracket 1, N-1 \rrbracket \times \mathbb{Z}$, and that in (III.50), $Y_{a-1,s}$ (resp $Y_{a+1,s}$) should be set to ∞ if $a = 1$ (resp if $a = N-1$). The lattice of these authorized values of (a, s) is depicted in figure III.2, where the circles denote the values of (a, s) corresponding to a Y-function. The black disks in the middle stand for the functions $Y_{a,0}$ which correspond to the massive particles. Apart from this property,

the $SU(N) \times SU(N)$ principal chiral model is characterized by its large u behavior, namely

$$\log(Y_{a,s}) + L \frac{\sin \frac{\pi a}{N}}{\sin \frac{\pi}{N}} \cosh\left(\frac{2\pi}{N} u\right) \delta_{s,0} \xrightarrow[u \rightarrow \infty]{} c_{a,s}. \quad (\text{III.53})$$

where $c_{a,s}$ is a u -independent number. This condition can be read from the TBA-equations (III.43), but it is not a direct consequence of the Y-system equation (III.50). This means that the TBA equation (III.43) is slightly stronger than the Y-system equation (III.50). Nevertheless we will see that it is sufficient to know the Y-system equation (III.50) on the one hand, and the asymptotic behavior (III.53) on the other hand.

III.1.2.4 Excited states

The construction given above allows to find the energy of the vacuum at any finite size, but it does not apply to excited states.

What was proven for a few models, (and can be conjectured for many other models) is that each excited state corresponds to a different solution of the Y-system equation, with different analyticity properties (in particular regarding the existence of zeroes and poles of the Y-functions) [BLZ97b, DT96, DT99].

This means that the functions $Y_{a,s}$ are multi-valued functions of L , living on a specific Riemann surface. Each sheet of this Riemann surface corresponds to one excited state, and there exists a path connecting this state to the vacuum (which means that the excited states are obtained by an analytic continuation from the vacuum). This analytic continuation preserves the Y-system equation (III.54), the asymptotic behavior (III.53), and the form of the expression (III.52) of the energy. For this last equation (III.52), an ambiguity appears for excited states because the integrand has singularities, and the integration contour has to be specified⁷.

A rigorous analysis of the analytic continuation from one sheet to the other seems out of reach, but we will assume that for arbitrary excited states, there exists a choice of contour such that the integral (III.52) gives the energy of this state. Under some natural hypotheses, we can find this contour for several models, and in the case of the principal chiral model, that allows to go through a couple of non-trivial checks.

III.2 General solution of Hirota equation

As we saw in the previous section, the thermodynamic Bethe ansatz gives rise to the Y-system equation

$$Y_{a,s}^+ Y_{a,s}^- = \frac{1 + Y_{a,s+1}}{1 + 1/Y_{a+1,s}} \frac{1 + Y_{a,s-1}}{1 + 1/Y_{a-1,s}} \quad (\text{III.54})$$

where we have a set of functions $Y_{a,s} \equiv Y_{a,s}(u)$ of the spectral parameter u , labeled by two integers (a, s) . In (III.54), the dependence in the spectral parameter u is written as

⁷For the vacuum, we will see that the Y-functions are analytic (they do not have poles), whereas for excited states, they have poles giving rise to the ambiguity in the expression (III.52) of the energy.

a superscript:

$$\boxed{f^\pm \equiv f\left(\mathbf{u} \pm \frac{\mathbf{i}}{2}\right)}. \quad (\text{III.55})$$

This Y-system equation (III.54) is a very general equation, which arises from the thermodynamic Bethe ansatz for a large variety of models. We will see in this section that its general solution is exactly given by the construction of the chapter II. This remark will be the key point in order to recast these TBA-equations into a FiNLIE. It is motivated by noticing that under the change of variables

$$\boxed{Y_{a,s} = \frac{T_{a,s+1} T_{a,s-1}}{T_{a+1,s} T_{a-1,s}}}, \quad (\text{III.56})$$

the Y-system equation is equivalent to the following Hirota equation

$$\boxed{T_{a,s}^+ T_{a,s}^- = T_{a+1,s} T_{a-1,s} + T_{a,s+1} T_{a,s-1}}, \quad (\text{III.57})$$

where the $T_{a,s}$ are functions of the spectral parameter \mathbf{u} , labeled by two integers (a, s) . The sense in which they are equivalent, as well the proofs of this equivalence, will be given in III.2.2, while the present section only announces the key informations.

Up to the change of variables

$$T_{a,s}(\mathbf{u}) = T^{a,s} \left(-\mathbf{i}\mathbf{u} + \frac{a-s}{2} - \frac{\mathbf{N}}{4} \right) \quad (\text{III.58})$$

this equation is identical to the Hirota equation (II.101) which we derived for spin chains. For models with a known integrable lattice regularization, this result is not surprising because the field theory can be written as the limit of a spin chain. But the thermodynamic Bethe ansatz tells us that this Hirota equation even describes models without any known integrable lattice regularization, and allows to study them very efficiently.

As shown in chapter II, this Hirota equation is equivalent (for typical solutions on the half plane $a \geq 0$) to the CBR determinant formula⁸

$$T_{a,s} = \frac{\left| (T_{1,s+i-j}(\mathbf{u} + \frac{\mathbf{i}}{2}(a+1-i-j)))_{1 \leq i,j \leq a} \right|}{\prod_{k=1}^{a-1} T_{0,0}(\mathbf{u} - \mathbf{i}\frac{s}{2} + \frac{\mathbf{i}}{2}(a-2k))}. \quad (\text{III.59})$$

In this section we will write the general solution of the Hirota equation (III.57) for several boundary conditions, hence the solution of the Y-system equation (III.54). Before we delve into this, let us note the nature of the relation between (III.57) and (III.54):

⁸ The expression (III.59) for the CBR formula is identical to the expression (II.80) obtained in chapter II, up to the change of variables (III.58).

one can note that $Y_{a,s}$, written as a function of $T_{a,s}$ (see (III.56)), is invariant under the “gauge” transformation

$$\boxed{T_{a,s} \rightsquigarrow g_1^{[a+s]} g_2^{[a-s]} g_3^{[-a+s]} g_4^{[-a-s]} T_{a,s}}, \quad (\text{III.60})$$

$$\text{where } \boxed{f^{[+n]} \equiv f\left(\mathbf{u} + n\frac{\mathbf{i}}{2}\right)}, \quad (\text{III.61})$$

for four arbitrary functions g_1, g_2, g_3 and g_4 of the spectral parameter \mathbf{u} . These functions will be called “gauge-functions”. The Hirota equation (III.57) is also invariant under this gauge transformation. We will see that every solution of the Y-system equation corresponds to a set of solutions of the Hirota equation, which are obtained from each other by gauge transformations. The complete proof of this statement is more technical than one would naively expect, and it is given in subsection III.2.2. Before that, we will comment on the labels (a, s) in the Hirota and Y-system equations (III.54, III.56, III.57).

III.2.1 Examples of (a, s) lattice

In section III.1 we have derived that, for the principal chiral model, the indices a and s labeling the various Y-functions belong to the set $\llbracket 1, N-1 \rrbracket \times \mathbb{Z}$. We also saw that the Y-system equation is satisfied at $a = 0$ and $a = N$ if we define $Y_{a,0} = Y_{a,N} = \infty$.

If we try to write that in terms of T -functions, we see that $T_{a,s}$ needs to be well defined when $(a, s) \in \llbracket 0, N \rrbracket \times \mathbb{Z}$, in order to be able to compute the ratio $Y_{a,s} = \frac{T_{a,s+1} T_{a,s-1}}{T_{a+1,s} T_{a-1,s}}$. Moreover the requirement $Y_{a,0} = Y_{a,N} = \infty$ translates into $T_{-1,s} = 0$ and $T_{N+1,s} = 0$. This is very natural and corresponds very well to the analysis of chapter II, where we saw that the T -functions are zero outside a given domain of the (a,s) -plane. We also saw that this domain depends of the symmetry group of the model (see the figure II.3 (page 35) for $GL(K)$ and the figure II.4 (page 39) for $GL(K|M)$).

III.2.1.1 The lattice $\mathbb{S}(N)$ of the principal chiral model

Let us denote by $[\mathbb{S}(N)]_Y$ and $[\mathbb{S}(N)]_T$ the lattices

$$\boxed{[\mathbb{S}(N)]_Y \equiv \{(a, s) | a \in \llbracket 1, N-1 \rrbracket \text{ and } s \in \mathbb{Z}\}} \quad (\text{III.62})$$

$$\boxed{[\mathbb{S}(N)]_T \equiv \{(a, s) | a \in \llbracket 0, N \rrbracket \text{ and } s \in \mathbb{Z}\}}. \quad (\text{III.63})$$

We will say that $Y_{a,s}$ is a solution of the Y-system equation on $\mathbb{S}(N)$ if $Y_{a,s}$ is defined for all $(a, s) \in [\mathbb{S}(N)]_Y$, and if it obeys the equation (III.54) for all $(a, s) \in [\mathbb{S}(N)]_Y$, with the prescription $Y_{0,s} = \infty = Y_{N,s}$. This prescription can be summarized by rewriting the Y-system equation as

$$\frac{Y_{a,s}^+ Y_{a,s}^-}{(Y_{a+1,s})^{1-\delta_{a,N-1}} (Y_{a-1,s})^{1-\delta_{a,1}}} = \frac{1 + Y_{a,s+1}}{(1 + Y_{a+1,s})^{1-\delta_{a,N-1}}} \frac{1 + Y_{a,s-1}}{(1 + Y_{a-1,s})^{1-\delta_{a,1}}}. \quad (\text{III.64})$$

As we have seen, the Y-functions of the principal chiral model are an example of functions which obey the Y-system equation on $\mathbb{S}(N)$.

We will also say that $T_{a,s}$ is a solution of the Hirota equation on $\mathbb{S}(\mathbb{N})$ if $T_{a,s}$ is defined for all $(a, s) \in [\mathbb{S}(\mathbb{N})]_T$, and if it obeys the equation (III.57) for all $(a, s) \in \mathbb{Z} \times \mathbb{Z}$, with the prescription $T_{a,s} = 0$ for all $(a, s) \notin [\mathbb{S}(\mathbb{N})]_T$.

With these definitions, we will see (in section III.2.2) in what sense the Y-system equation on $\mathbb{S}(\mathbb{N})$ is equivalent to the Hirota equation on $\mathbb{S}(\mathbb{N})$.

We can see a representation of these lattices in figure III.2 (page 102): the set $[\mathbb{S}(\mathbb{N})]_Y$ of authorized values (of (a, s)) for the Y-functions is denoted by circles (and disks), whereas the set $[\mathbb{S}(\mathbb{N})]_T$ contains all the nodes of the grid in the background.

This lattice corresponds to the symmetry group $SU(\mathbb{N}) \times SU(\mathbb{N})$ of the principal chiral model.

III.2.1.2 The lattices $\mathfrak{w}(\mathbb{N})$ and $\mathbb{L}(\mathbb{K}, \mathbb{M})$ of $GL(\mathbb{K})$ and $GL(\mathbb{K}|\mathbb{M})$ spin chains

For $GL(\mathbb{K})$ and $GL(\mathbb{K}|\mathbb{M})$ spin chains, we have seen in the previous chapter that the T -functions live on the “fat-hook” lattice of the figures II.3 and II.4. We will therefore denote by $[\mathbb{L}(\mathbb{K}, \mathbb{M})]_T$ the lattice

$$[\mathbb{L}(\mathbb{K}, \mathbb{M})]_T \equiv \left\{ (a, s) \in \mathbb{N} \times \mathbb{Z} \left| \begin{array}{l} s \geq 0 \quad \text{and } 0 \leq a \leq \mathbb{K} \\ \text{or} \\ a \geq 0 \quad \text{and } 0 \leq s \leq \mathbb{M} \\ \text{or} \\ a = 0 \end{array} \right. \right\}. \quad (\text{III.65})$$

In the case of $GL(\mathbb{K})$ (or $SU(\mathbb{N})$), we can choose to emphasize the inclusion $SU(\mathbb{N}) \subset SU(\mathbb{N}) \times SU(\mathbb{N})$ by choosing a lattice included in $\mathbb{S}(\mathbb{N})$. Then we can define a lattice

$$[\mathfrak{w}(\mathbb{N})]_T \equiv \left\{ (a, s) \in \mathbb{N} \times \mathbb{Z} \left| \begin{array}{l} s \geq 0 \quad \text{and } 0 \leq a \leq \mathbb{N} \\ \text{or} \\ a = 0 \quad \text{or } a = \mathbb{N} \end{array} \right. \right\}. \quad (\text{III.66})$$

We will say that $T_{a,s}$ is a solution of the Hirota equation on $\mathbb{L}(\mathbb{K}, \mathbb{M})$ (resp $\mathfrak{w}(\mathbb{N})$) if $T_{a,s}$ is defined for all $(a, s) \in [\mathbb{L}(\mathbb{K}, \mathbb{M})]_T$ (resp $[\mathfrak{w}(\mathbb{N})]_T$), and if it obeys the equation (III.57) for all $(a, s) \in \mathbb{Z} \times \mathbb{Z}$, with the prescription $T_{a,s} = 0$ for all $(a, s) \notin [\mathbb{L}(\mathbb{K}, \mathbb{M})]_T$ (resp $[\mathfrak{w}(\mathbb{N})]_T$).

The two lattices $\mathfrak{w}(\mathbb{K})$ and $\mathbb{L}(\mathbb{K}, 0)$ are equivalent in the following sense: if $T_{a,s}$ is a solution of Hirota equation at every $(a, s) \in \llbracket 0, \mathbb{K} \rrbracket \times \mathbb{N}$ such that $T_{-1,s} = 0$, $T_{a,-1} = 0$ when $a \in \llbracket 1, \mathbb{K} - 1 \rrbracket$, and $T_{\mathbb{K}+1,s} = 0$ when $s > 1$, then $T_{a,s}$ can be continued into a solution of Hirota on $\mathfrak{w}(\mathbb{K})$ or into a solution of Hirota on $\mathbb{L}(\mathbb{K}, 0)$ (both are possible), by defining $T_{0,s}$ and $T_{\mathbb{N},s}$ (or $T_{a,0}$) recursively. For instance, for $\mathfrak{w}(\mathbb{K})$, this is done by a simple recurrence defining $T_{\mathbb{K},s} = \frac{T_{\mathbb{K},s+1}^+ T_{\mathbb{K},s+1}^-}{T_{\mathbb{K},s+2}}$ for $s \leq -1$. These two lattices are depicted in figure III.3.

After the change of variables $Y_{a,s} = \frac{T_{a,s+1}}{T_{a+1,s}} \frac{T_{a,s-1}}{T_{a-1,s}}$, we see that the authorized values for

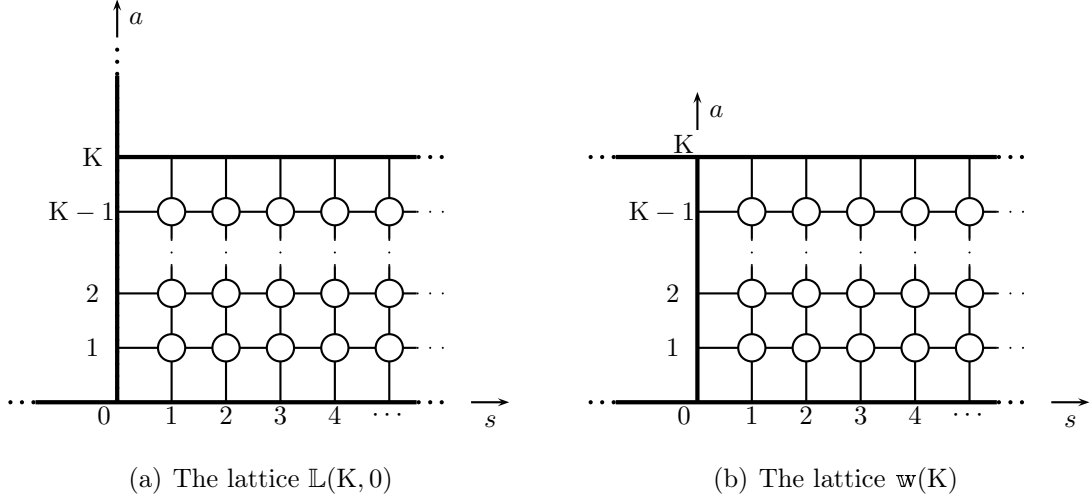

Figure III.3: The lattices $\mathbb{L}(K, 0)$ and $w(K)$ corresponding to the group $GL(K)$

Y-functions are

$$[\mathbb{L}(K, M)]_Y \equiv \left\{ (a, s) \in \mathbb{N} \times \mathbb{N} \left| \begin{array}{l} s \geq 1 \quad \text{and } 1 \leq a \leq K-1 \\ \text{or} \\ a \geq 1 \quad \text{and } 1 \leq s \leq M-1 \\ \text{or} \\ s = M \geq 1 \quad \text{and } a = K \geq 1 \end{array} \right. \right\}. \quad (\text{III.67})$$

We see that if $K \geq 1$ and $M \geq 1$, then at $(a, s) = (K, M)$, $Y_{K,M} = \frac{T_{K,M+1}}{T_{K+1,M}} \frac{T_{K,M-1}}{T_{K-1,M}}$ is well defined. On the other hand, we get $Y_{K,s} = \infty$ if $s > M$ and $Y_{a,M} = 0$ if $a > K$. If we plug this into the Y-system equation (III.54) at $(a, s) = (K, M)$, then the right-hand-side is indeterminate, because it contains $\frac{\infty}{1+1/0}$. Therefore we will say that $Y_{a,s}$ is a solution of the Y-system equation on $\mathbb{L}(K, M)$ if $Y_{a,s}$ is defined for all $(a, s) \in [\mathbb{L}(K, M)]_Y$, and if it obeys the equation (III.54) for all $(a, s) \in [\mathbb{L}(K, M)]_Y$ except $(a, s) = (K, M)$. In this Y-system equation, we use the prescriptions $Y_{0,s} = \infty$, $Y_{a,0} = 0$, $Y_{K,s} = \infty$ if $s > M$ and $Y_{a,M} = 0$ if $a > K$.

This lattice $\mathbb{L}(K, M)$ is depicted in figure III.4. Physically it appears for the spin chains of chapter II, but also for several fields theories, such as the Gross-Neveu model.

III.2.1.3 The “T-hooks”, such as in the case of AdS/CFT

We will see in the next chapter that another shape of lattice occurs in the study of the AdS/CFT spectrum. This lattice is called a T-shaped fat hook, or a “T-hook” in

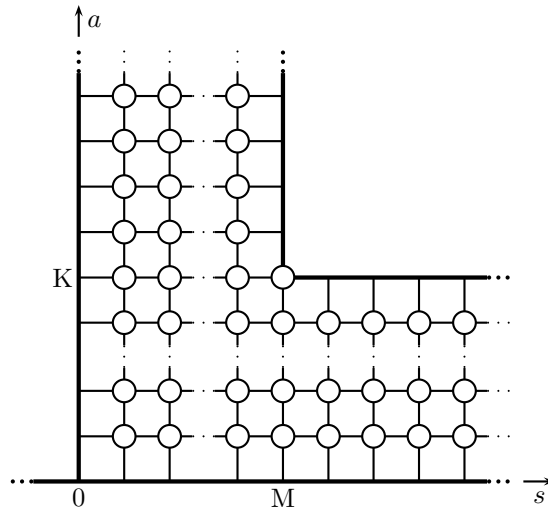

Figure III.4: The “fat-hook” $\mathbb{L}(K, M)$: the lattice $[\mathbb{L}(K, M)]_Y$ for Y-functions is denoted by circles whereas the lattice $[\mathbb{L}(K, M)]_T$ contains all the nodes of the grid in the background.

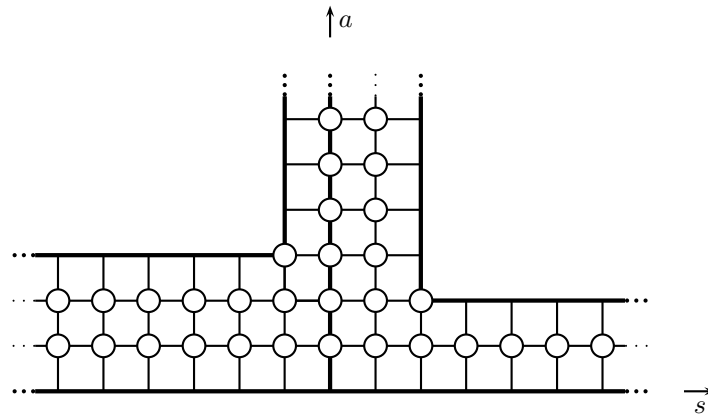

Figure III.5: The “T-hook” $\mathbb{T}(2, 3|2+1)$: the lattice $[\mathbb{T}(2, 3|2+1)]_Y$ for Y-functions is denoted by circles whereas the lattice $[\mathbb{T}(2, 3|2+1)]_T$ contains all the nodes of the grid in the background.

[GKV09a, GKKV10], and [Vol11, Vol12], and it is defined as

$$[\mathbb{T}(K, K'|M + M')]_T \equiv \left\{ (a, s) \in \mathbb{N} \times \mathbb{Z} \left| \begin{array}{l} s \geq 0 \text{ and } 0 \leq a \leq K \\ \text{or} \\ s \leq 0 \text{ and } 0 \leq a \leq K' \\ \text{or} \\ a \geq 0 \text{ and } -M' \leq s \leq M \end{array} \right. \right\}, \quad (\text{III.68})$$

$$[\mathbb{T}(K, K'|M + M')]_Y \equiv \left\{ (a, s) \in \mathbb{N} \times \mathbb{Z} \left| \begin{array}{l} s > 0 \text{ and } 1 \leq a \leq K - 1 \\ \text{or} \\ s < 0 \text{ and } 1 \leq a \leq K' - 1 \\ \text{or} \\ a > 0 \text{ and } -M' - 1 \leq s \leq M - 1 \\ \text{or} \\ a = K \geq 1 \text{ and } s = M \\ \text{if } M \geq -M' + 1 \text{ or } K \leq K' \\ \text{or} \\ a = K' \geq 1 \text{ and } s = -M' \\ \text{if } M' \geq -M + 1 \text{ or } K' \leq K \end{array} \right. \right\}, \quad (\text{III.69})$$

$$\text{where } K, K', M, M' \geq 0. \quad (\text{III.70})$$

This lattice is depicted in figure III.5, and we will say that $T_{a,s}$ is a solution of the Hirota equation on $\mathbb{T}(K, K'|M + M')$ if $T_{a,s}$ is defined for all $(a, s) \in [\mathbb{T}(K, K'|M + M')]_T$, and if it obeys the equation (III.57) for all $(a, s) \in \mathbb{Z} \times \mathbb{Z}$, with the prescription $T_{a,s} = 0$ for all $(a, s) \notin [\mathbb{T}(K, K'|M + M')]_T$.

Like in the case of the lattice $\mathbb{L}(K, M)$, the Y-system equation is ill-defined at the corners $(a, s) = (K, M)$ and $(a, s) = (K', -M')$. Therefore we will say that $Y_{a,s}$ is a solution of the Y-system equation on $\mathbb{T}(K, K'|M + M')$ if $Y_{a,s}$ is defined for all $(a, s) \in [\mathbb{T}(K, K'|M + M')]_Y$, and if it obeys the equation (III.54) for all $(a, s) \in [\mathbb{T}(K, K'|M + M')]_Y$ except when $(a, s) = (K, M)$ and when $(a, s) = (K', -M')$. In this Y-system equation, we should use the prescriptions $Y_{0,s} = \infty$, $Y_{K,s} = \infty$ if $s > M$, $Y_{K',s} = \infty$ if $s < -M$, $Y_{a,M} = 0$ if $a > K$ and $Y_{a,-M'} = 0$ if $a > K'$. These prescriptions are exactly what comes from writing a ratio of T -functions which are equal to zero outside the lattice $\mathbb{T}(K, K'|M + M')$, and they make the Y-system equation singular at positions $(a, s) = (K, M)$ and $(a, s) = (K', -M')$.

III.2.1.4 The Wronskian gauge

Let us now define a physical choice of gauge, which will fix part of the gauge freedom of equation (III.60). To this end, we should remind that the Hirota equation (III.57) is

equivalent to the Hirota equation of chapter II up to the change of variables (III.58). But in chapter II, the (a, s) -lattice had a clear interpretation in terms of representation, which allowed to say that for instance

$$T^{0,s}(\mathbf{u}) = T^{a,0}(\mathbf{u}) = T^{0,0}(\mathbf{u}). \quad (\text{III.71})$$

Additionally, we know that for $\text{GL}(\mathbb{K})$, $\chi^{(\mathbb{K},s)}(g) = \det(g)^s$, so that one can show (see the relation (B.27) in appendix B.2), that

$$T^{\mathbb{K},s}(\mathbf{u}) = T^{0,0}(\mathbf{u} + s)\det(g)^s. \quad (\text{III.72})$$

In the present section, we do not introduce any twisted boundary condition. This means that we take the limit $g \rightarrow \mathbb{I}$ of expressions like (II.63) (this limit $g \rightarrow \mathbb{I}$ is taken after acting by co-derivatives). Therefore, we will disregard the factor $\det(g)^s$ in (III.72).

After the change of variables (III.58), the constraints (III.71) and (III.72) become

$$T_{0,s} = T_{0,0}^{[-s]} \quad T_{a,0} = T_{0,0}^{[+a]} \quad T_{\mathbb{K},s} = T_{0,0}^{[+\mathbb{K}+s]} \quad (\text{III.73})$$

In the thermodynamic Bethe ansatz approach, the gauge freedom (III.60) allows to restrict to T -functions obeying the constraints (III.73).

Proof. Let $T_{a,s}$ be an arbitrary solution of the Hirota equation on the lattice $w(\mathbb{K})$. On the boundaries of the lattice, the Hirota equation implies that there exist six functions f_1, f_2, f_3, f_4, f_5 and f_6 of the spectral parameter \mathbf{u} , such that

$$T_{0,s} = f_1^{[+s]} f_2^{[-s]} \quad T_{a,0} = f_3^{[+a]} f_4^{[-a]} \quad T_{\mathbb{K},s} = f_5^{[+\mathbb{K}]} f_6^{[-s]} \quad (\text{III.74})$$

because one term is zero in the Hirota equation on the boundary of the lattice (for instance, at $a = 0$, we get $T_{0,s}^+ T_{0,s}^- = T_{0,s+1} T_{0,s-1}$, which implies that $T_{0,s} = f_1^{[+s]} f_2^{[-s]}$).

If we set

$$g_1 = \frac{1}{f_1 g_3}, \quad g_2 = \frac{g_3^{[-2\mathbb{K}]} f_4^{[-2\mathbb{K}]}}{f_6^{[-\mathbb{K}]}} \quad g_4 = \frac{1}{f_4 g_3}, \quad (\text{III.75})$$

then the function $\tilde{T}_{a,s} = g_1^{[a+s]} g_2^{[a-s]} g_3^{[-a+s]} g_4^{[-a-s]} T_{a,s}$ gives the same Y-functions and obeys the additional gauge constraints (III.73). \square

In the case of super-groups, we can also define an analogous gauge condition. The first difference is that we do not have an expression like (III.72), but on the other hand, the expression (II.265) gives

$$T^{\mathbb{K},s}(\mathbf{u}) \propto \frac{Q_B(\mathbf{u} + s) Q_F(\mathbf{u} - \mathbb{K})}{Q_\emptyset(\mathbf{u} + s - \mathbb{K})} \quad \text{if } s \geq \mathbb{M}, \quad (\text{III.76})$$

$$T^{a,\mathbb{M}}(\mathbf{u}) \propto \frac{Q_B(\mathbf{u} + \mathbb{M}) Q_F(\mathbf{u} - a)}{Q_\emptyset(\mathbf{u} + \mathbb{M} - a)} \quad \text{if } a \geq \mathbb{K}, \quad (\text{III.77})$$

$$\text{where } B = \{\mathbf{j} \in \llbracket 1, \mathbb{K} + \mathbb{M} \rrbracket \mid (-1)^{p_j} = +1\} \quad (\text{III.78})$$

$$\text{and } F = \{\mathbf{j} \in \llbracket 1, \mathbb{K} + \mathbb{M} \rrbracket \mid (-1)^{p_j} = -1\} \quad (\text{III.79})$$

where the symbol \propto means that the equality is true up to a function of the twist, analogous to the factor $\det(g)^s$ in (III.72). If we perform the change of variables (III.58), keeping in mind that $Q_\emptyset(\mathbf{u})$ is \mathbf{u} -independent, then we get

$$T_{0,s} = T_{0,0}^{[-s]} \quad T_{a,0} = T_{0,0}^{[+a]} \quad T_{K+n,M} = T_{K,M+n} \quad \text{for any } n \geq 0 \quad (\text{III.80})$$

This condition generalizes (III.73) to the lattice $\mathbb{L}(K, M)$. Like previously, the gauge freedom (III.60) is sufficient to restrict to T -functions obeying the constraints (III.80) (the proof is as easy as above, and is left to the reader).

In what follows, we will often view the choice of a gauge obeying (III.73) (or (III.80)) as a more physical choice, because if a lattice regularization turned out to exist and to give a meaning to the T -functions (identifying the (a, s) labels to rectangular Young diagrams), then the T -functions which would come out would satisfy the constraint (III.80).

We will call ‘‘Wronskian gauge’’ the gauges which obey these conditions. One should note that this requirement fixes only three out of four degrees of gauge-freedom (i.e. the function g_3 in (III.75) is not fixed by this argument).

For the lattice $\mathbb{T}(K, K'|M + M')$ (which corresponds for instance to AdS/CFT), the gauge condition (III.80) can be generalized as

$$T_{0,s} = T_{0,0}^{[-s]} \quad T_{K'+n,-M'} = T_{K',-M'-n} \quad T_{K+n,M} = T_{K,M+n} \quad \text{for any } n \geq 0 \quad (\text{III.81})$$

As we will see, the ‘‘Wronskian gauges’’ are gauges where Wronskian determinant expressions (similar to (II.260) in the previous chapter) appear in the most natural way (hence the name of Wronskian gauge). For instance, we used this gauge in the article [11GKLT], which gave the typical solution of Hirota equation on the lattice $\mathbb{T}(2, 2|2 + 2)$ in the form of a Wronskian determinant.

III.2.2 Equivalence of Hirota equation and Y-system equation

To see in what sense the Hirota equation and the Y-system equation are equivalent, the first statement that we will prove is:

Statement 1. *If $T_{a,s}$ obeys the Hirota equation (III.57), then $Y_{a,s} = \frac{T_{a,s+1} T_{a,s-1}}{T_{a+1,s} T_{a-1,s}}$ obeys the Y-system equation (III.54)*

Proof. Let $T_{a,s}$ be a set of functions which obeys the Hirota equation (III.57). Then if we define $Y_{a,s} = \frac{T_{a,s+1} T_{a,s-1}}{T_{a+1,s} T_{a-1,s}}$, we can notice that due to the Hirota equation, we have

$$1 + Y_{a,s} = \frac{T_{a,s}^+ T_{a,s}^-}{T_{a-1,s} T_{a+1,s}}, \quad 1 + 1/Y_{a,s} = \frac{T_{a,s}^+ T_{a,s}^-}{T_{a,s-1} T_{a,s+1}}. \quad (\text{III.82})$$

We can then compute

$$\frac{1 + Y_{a,s+1}}{1 + 1/Y_{a+1,s}} \frac{1 + Y_{a,s-1}}{1 + 1/Y_{a-1,s}} \quad (\text{III.83})$$

$$= \frac{T_{a,s+1}^+ T_{a,s+1}^- T_{a+1,s-1} T_{a+1,s+1} T_{a,s-1}^+ T_{a,s-1}^- T_{a-1,s-1} T_{a-1,s+1}}{T_{a-1,s+1} T_{a+1,s+1} T_{a+1,s}^+ T_{a+1,s}^- T_{a-1,s-1} T_{a+1,s-1} T_{a-1,s}^+ T_{a-1,s}^-} \quad (\text{III.84})$$

$$= \frac{T_{a,s+1}^+ T_{a,s+1}^- T_{a,s-1}^+ T_{a,s-1}^-}{T_{a+1,s}^+ T_{a+1,s}^- T_{a-1,s}^+ T_{a-1,s}^-} = Y_{a,s}^+ Y_{a,s}^-, \quad (\text{III.85})$$

which means that $Y_{a,s}$ obeys the Y-system equation (III.54). \square

The next statement which we want to prove is the following:

Statement 2. *If $Y_{a,s}$ is a typical solution of the Y-system equation (III.54), then there exists a typical solution $T_{a,s}$ of the Hirota equation (III.57) such that $Y_{a,s} = \frac{T_{a,s+1} T_{a,s-1}}{T_{a+1,s} T_{a-1,s}}$.*

As in the section II.1.5.1, a typical solution of Hirota equation (resp the Y-system equation), is a solution $T_{a,s}$ (resp $Y_{a,s}$) such that every small perturbation of a set of initial data (see below) is associated to another solution of Hirota equation (resp the Y-system equation), which converges to $T_{a,s}$ (resp $Y_{a,s}$) when the perturbation tends to zero.

For the lattice $\mathbb{S}(N)$, for instance, one possible choice of initial values is the set of functions $\{Y_{a,0} | 1 \leq a \leq N-1 \text{ and } 0 \leq s \leq 1\}$, for the Y-system equation, and $\{T_{a,0} | 0 \leq a \leq N \text{ and } 0 \leq s \leq 1\}$ for the Hirota equation. Then a typical solution of the Y-system equation on $\mathbb{S}(N)$ is a solution $Y_{a,s}$ of the Y-system equation such that, for every small perturbation $[Y_{a,0}]_\epsilon = Y_{a,0} + \mathcal{O}(\epsilon)$ (and $[Y_{a,1}]_\epsilon = Y_{a,1} + \mathcal{O}(\epsilon)$) of the initial values, there exists a solution $[Y_{a,s}]_\epsilon$ such that $Y_{a,s} = \lim_{\epsilon \rightarrow 0} [Y_{a,s}]_\epsilon$. Similarly a typical solution of the Hirota equation on $\mathbb{S}(N)$ is a solution $T_{a,s}$ of the Hirota equation such that, for every small perturbation $[T_{a,0}]_\epsilon = T_{a,0} + \mathcal{O}(\epsilon)$ (and $[T_{a,1}]_\epsilon = T_{a,1} + \mathcal{O}(\epsilon)$) of the initial values, there exists a solution $[T_{a,s}]_\epsilon$ such that $T_{a,s} = \lim_{\epsilon \rightarrow 0} [T_{a,s}]_\epsilon$.

An important properties of these typical solutions is that they are completely characterized by the initial values (the various T - or Y -functions are expressed recursively in terms of the initial values).

From the thermodynamic Bethe ansatz point of view, we will see (in the next sections) that the solution of Y-system is typical when the size L of the spatial dimension is large. If we assume that the Y-functions are analytic in the parameter L , it is quite natural to expect that at any size L , the solutions are still typical.

Moreover, for the vacuum (the case when we can derive the Y-system equation), the functions $Y_{a,s}$ are all positive (due to their definition in section III.1 as ratios of densities), and we can directly show that all the Y-functions are fixed uniquely by the initial values (because the iteration procedure cannot involve a denominator which is identically zero), and that the solution of the Y-system equations is typical.

Proof of Statement 2. The Statement 2 is slightly trickier than the previous Statement 1. We will prove it on a case-by-case basis (though we will see that the proof is identical

for the lattices considered, and it will be detailed mainly for the (a,s) -lattice $\mathbb{S}(N)$ of the principal chiral model (starting with the simplest case of $\mathbb{S}(2)$). The idea of the proof will be that, starting from a solution of the Y-system equation, we will find initial values for the T -functions such that the initial values for the Y-functions are reproduced (when we write the ratio of these initial T -functions). From these initial values we can (using the typicality condition) define all the other T -functions by recurrence so that the Hirota equation is satisfied. Then the ratio $\frac{T_{a,s+1}}{T_{a+1,s}} \frac{T_{a,s-1}}{T_{a-1,s}}$ obeys the Y-system equation and reproduces the initial values of the Y-functions, therefore it coincides with the Y-functions for all (a, s) .

$\mathbb{S}(2)$ case Let us start with the simplest lattice $\mathbb{S}(2)$ (corresponding to the $SU(2) \times SU(2)$ principal chiral model). In this case $a = 1$ is the only value of a for which $Y_{a,s}$ is defined. Assuming the typicality condition stated above, we have shown that an arbitrary solution of the Y-system equation is uniquely fixed by the initial conditions $Y_{1,0}$ and $Y_{1,1}$ and that the typical solution of the Hirota equation is fixed uniquely by the initial conditions $T_{0,0}$, $T_{0,1}$, $T_{1,0}$, $T_{1,1}$, $T_{2,0}$ and $T_{2,1}$. We can note that for this $SU(2)$ principal chiral model, the Y-functions are characterized by two initial conditions, whereas the T -functions are characterized by six initial conditions. This is absolutely consistent with the fact that as compared to the Y-functions, the T -functions have an extra gauge-freedom characterized by four functions (see (III.60)).

If we know a solution $Y_{a,s}$ of the Y-system equation, then we can write initial conditions for the T -functions. They can be chosen for instance as

$$T_{0,0} = T_{0,1} = T_{2,0} = T_{2,1} = 1 \quad (\text{III.86})$$

and $T_{1,0}$ and $T_{1,1}$ are solutions of

$$T_{1,0}^+ T_{1,0}^- = 1 + Y_{1,0}, \quad T_{1,1}^+ T_{1,1}^- = 1 + Y_{1,1}. \quad (\text{III.87})$$

We will discuss how to solve these equations, but for the moment it is enough to say that solutions of (III.87) do exist. For instance, one can choose $T_{1,0}(\mathbf{u}) = 1$ for $\text{Im}(\mathbf{u}) \in [0, 1[$ and define $T_{1,0}(\mathbf{u})$ by recurrence as $\frac{1+Y_{1,0}^-}{T_{1,0}^-}$ if $\text{Im}(\mathbf{u}) \geq 1$ and as $\frac{1+Y_{1,0}^+}{T_{1,0}^+}$ if $\text{Im}(\mathbf{u}) < 0$.

Then the (typical) solution of Hirota equation characterized by these initial values gives rise to a solution of the Y-system which is characterized by the initial values $Y_{1,0}$ and $Y_{1,1}$. This proves that there exists a solution of the Hirota equation associated to this typical solution of the Y-system equation (III.54).

Case of $\mathbb{S}(N)$ For the more general lattice $\mathbb{S}(N)$ (corresponding to the $SU(N) \times SU(N)$ principal chiral model), we can follow exactly the same argument as for $\mathbb{S}(2)$. For the Y-system equation, one possible choice of initial values is the set of functions $\{Y_{a,0} | 1 \leq a \leq N-1 \text{ and } 0 \leq s \leq 1\}$. For the Hirota equation, a possible choice of initial values is the set of functions $\{T_{a,0} | 0 \leq a \leq N \text{ and } 0 \leq s \leq 1\}$.

Given a solution of the Y-system equation, we can define initial values for the Hirota equation which obey for instance

$$T_{0,0} = T_{0,1} = T_{N,0} = T_{N,1} = 1, \quad (\text{III.88})$$

$$\text{and } \begin{pmatrix} \log(1 + Y_{1,s}) \\ \log(1 + Y_{2,s}) \\ \vdots \\ \log(1 + Y_{N-1,s}) \end{pmatrix} = M \cdot \begin{pmatrix} \log(T_{1,s}) \\ \log(T_{2,s}) \\ \vdots \\ \log(T_{N-1,s}) \end{pmatrix}, \quad \text{for } 0 \leq s \leq 1, \quad (\text{III.89})$$

$$\text{where } M = \begin{pmatrix} D + D^{-1} & -1 & & & \\ & -1 & D + D^{-1} & -1 & \\ & & \ddots & \ddots & \ddots \\ & & & -1 & D + D^{-1} & -1 \\ & & & & -1 & D + D^{-1} \end{pmatrix}, \quad (\text{III.90})$$

$$\text{and } D \equiv e^{\frac{i}{2}\partial_u}. \quad (\text{III.91})$$

The equation (III.89) is simply the requirement that $\frac{T_{a,s}^+ T_{a,s}^-}{T_{a-1,s} T_{a+1,s}} = 1 + Y_{a,s}$ should hold. In order to show how to find $T_{a,s}$ such that (III.89) holds, let us show how, for $N - 1$ functions $y_1 = \log(1 + Y_{1,s})$, $y_2 = \log(1 + Y_{2,s})$, \dots , $y_{N-1} = \log(1 + Y_{N-1,s})$, we can find $N - 1$ functions x_0, x_1, \dots, x_{N-1} such that $M \cdot (x_j)_{1 \leq j \leq N-1} = (y_j)_{1 \leq j \leq N-1}$. First one can notice that if a solution exists, then the first component of $M \cdot (x_j) - (y_j)$ is $-x_2 + x_1^+ + x_1^- - y_1$. If it is zero we get $x_2 = x_1^+ + x_1^- - y_1$. Then the second component gives $x_3 = x_1^{[+2]} + x_1^{[+0]} + x_1^{[-2]} - y_1^+ - y_1^-$, etc. This gives

$$M \cdot (x_j)_{1 \leq j \leq N-1} = (y_j)_{1 \leq j \leq N-1} \quad \Rightarrow \quad \forall k, \quad x_k = [k]_D x_1 + \sum_{l=1}^{k-1} [k-l]_D y_l \quad (\text{III.92})$$

$$\text{where } [i]_D \equiv D^{1-i} + D^{3-i} + \dots + D^{i-1} = \sum_{s=-\frac{i-1}{2}}^{\frac{i-1}{2}} D^{2s}. \quad (\text{III.93})$$

Finally, the last component of the equation $M \cdot (x_j)_{1 \leq j \leq N-1} = (y_j)_{1 \leq j \leq N-1}$ gives the constraint

$$[N]_D x_1 + \sum_{l=1}^{N-1} [N-l]_D y_l = 0. \quad (\text{III.94})$$

One easily sees that this equation always has a solution x_1 , which can for instance, be defined by recurrence⁹. Out of this solution x_1 , we obtain a solution of the equation

⁹ Let us give a possible way to solve the equation $[N]_D x_1 = f(u)$: if we notice that $D^{-N+1} ([N]_D - D^{-1}[N-1]_D) = 1$, we can define a solution of $[N]_D x_1 = f(u)$ as $x_1 = 0$ for $\text{Im}(u) \in [0, N-1[$ and then by recurrence as $x_1 = f(u - \frac{N-1}{2}) - D^{-N}[N-1]_D x_1$ if $\text{Im}(u) \geq N-1$, and as $x_1 = f(u + \frac{N-1}{2}) - D^N[N-1]_D x_1$ if $\text{Im}(u) < 0$.

$M \cdot (x_j)_{1 \leq j \leq N-1} = (y_j)_{1 \leq j \leq N-1}$.

This shows that we can find initial values $\{T_{a,0} | 0 \leq a \leq N \text{ and } 0 \leq s \leq 1\}$ which obey (III.88) and (III.89). Then a typical solution of Hirota equation can be built from these initial values, and after the change of variables $Y_{a,s} = \frac{T_{a,s+1} T_{a,s-1}}{T_{a+1,s} T_{a-1,s}}$, it gives a solution of the Y-system equation which reproduces the initial values $\{Y_{a,0} | 1 \leq a \leq N-1 \text{ and } 0 \leq s \leq 1\}$. Therefore, it reproduces all the Y-functions.

Other lattices For other shapes of the (a, s) -lattice, it is possible to proceed the same way to prove this Statement 2. The set of initial conditions may be quite different, but the method is absolutely the same.

For instance for $\mathbb{L}(K, M)$, the argument is identical to the construction above, if we use the initial values $\{Y_{a,1} | 1 \leq a \leq K+M-1\}$ for Y-functions and $\{T_{0,0}, T_{1,0}\} \cup \{T_{a,1} | 0 \leq a \leq K+M\}$ for T -functions. An analogous of (III.88) can be the choice $T_{0,0} = T_{1,0} = T_{0,1} = T_{K+M,1} = 1$, and the other initial T -functions are expressed from the equation (III.89) at $s = 1$.

For the lattice $\mathbb{T}(2, 2|4)$ of the AdS/CFT correspondence, the same argument can be used with the initial values $\{Y_{1,s} | -3 \leq s \leq 3\}$ for Y-functions and $\{T_{0,0}, T_{0,1}\} \cup \{T_{1,s} | -4 \leq s \leq 4\}$ for T -functions. An analogous of the gauge condition (III.88) can be the choice $T_{0,0} = T_{0,1} = T_{1,-4} = T_{1,4} = 1$, and the other T -functions are expressed like in (III.89), by using the relation $1 + 1/Y_{a,s} = \frac{T_{a,s}^+ T_{a,s}^-}{T_{a,s-1} T_{a,s+1}}$. \square

We have now proven that every solution of the Y-system equation corresponds to (at least) one solution of the Hirota equation.

We can now prove a concluding result which states that the gauge transformations (III.60) are the only additional freedom in the Hirota equation as compared to the Y-system equation. More precisely the statement is

Statement 3. *If $T_{a,s}$ and $\tilde{T}_{a,s}$ are two typical solutions of the Hirota equation (III.57) such that $\frac{T_{a,s+1} T_{a,s-1}}{T_{a+1,s} T_{a-1,s}} = \frac{\tilde{T}_{a,s+1} \tilde{T}_{a,s-1}}{\tilde{T}_{a+1,s} \tilde{T}_{a-1,s}}$, then there exist four functions g_1, g_2, g_3 and g_4 such that $\tilde{T}_{a,s} = g_1^{[a+s]} g_2^{[a-s]} g_3^{[-a+s]} g_4^{[-a-s]} T_{a,s}$.*

Proof. Let us write this proof for all the lattices $\mathbb{L}(K, M)$ and $\mathbb{T}(K, K'|M+M')$ at once. For all these lattices, the CBR determinant relation (III.59) holds¹⁰.

Then, we can use the relation $\frac{T_{a,s}^+ T_{a,s}^-}{T_{a,s-1} T_{a,s+1}} = 1 + 1/\frac{T_{a,s+1} T_{a,s-1}}{T_{a+1,s} T_{a-1,s}}$, which is just the Hirota equation (see (III.82)), to rewrite the condition $\frac{T_{a,s+1} T_{a,s-1}}{T_{a+1,s} T_{a-1,s}} = \frac{\tilde{T}_{a,s+1} \tilde{T}_{a,s-1}}{\tilde{T}_{a+1,s} \tilde{T}_{a-1,s}}$ as follows:

$$\frac{f_{(a,s)}^+ f_{(a,s)}^-}{f_{(a,s+1)} f_{(a,s-1)}} = 1, \quad \text{where } f_{(a,s)} = \frac{\tilde{T}_{a,s}}{T_{a,s}}. \quad (\text{III.95})$$

The general solution of this equation is $f_{(a,s)} = h_a^{[+s]} \tilde{h}_a^{[-s]}$ where $\{h_a\}$ and $\{\tilde{h}_a\}$ are two sets of arbitrary functions labeled by $a \in \mathbb{N}$.

¹⁰This CBR relation holds for all lattices such that $T_{a,s} = 0$ is $a < 0$ and $T_{1,s} \neq 0$ (at least for positive s), under a connexity condition which holds for instance for $\mathbb{L}(K, M)$ and $\mathbb{T}(K, K'|M+M')$.

If we find four functions g_1, g_2, g_3 and g_4 such that

$$h_0 = g_1 g_3, \quad h_1 = g_1^+ g_3^-, \quad \tilde{h}_0 = g_2 g_4, \quad \tilde{h}_1 = g_2^+ g_4^-, \quad (\text{III.96})$$

then we obtain the relation $\tilde{T}_{a,s} = g_1^{[a+s]} g_2^{[a-s]} g_3^{[-a+s]} g_4^{[-a-s]} T_{a,s}$ when $s = 0$ and when $s = 1$. Due to the CBR formula, these initial data completely fix the solutions $T_{a,s}$ and $\tilde{T}_{a,s}$ of the Hirota equation, which allows to conclude that $\tilde{T}_{a,s} = g_1^{[a+s]} g_2^{[a-s]} g_3^{[-a+s]} g_4^{[-a-s]} T_{a,s}$ holds for arbitrary a and s .

Let us now show that a solution of (III.96) does exist. For that, we can simply choose a solution g_1 of the relation $\frac{h_1}{h_0} = \frac{g_1^+}{g_1^-}$ (it can for instance be defined by recurrence), and define $g_3 = \frac{h_0}{g_1}$. Then $h_0 = g_1 g_3$ and $h_1 = g_1^+ g_3^-$ are satisfied. If we also define g_2 as an arbitrary solution of $\frac{g_2^+}{g_2^-} = \frac{\tilde{h}_1}{\tilde{h}_0}$ and $g_4 = \frac{\tilde{h}_0}{g_2}$, then (III.96) is satisfied, which finishes the proof. \square

Conclusion In this section we have proven the statement that every solution of the Y-system equation corresponds to a set of solutions of the Hirota equation, which are obtained from each other by gauge transformations. We have proven this statement in the case of the lattices $\mathbb{S}(N)$ and $\mathbb{T}(K, K'|M + M')$, and for their sublattices $\mathbb{L}(K, M)$ and $\mathbb{w}(K) \simeq \mathbb{L}(K, 0)$ as well, so that we covered a wide range of possible thermodynamic Bethe Ansätze. These simple properties will be used extensively in the resolution of the Y-systems, for instance in section III.3.

III.2.3 Typical solution of Hirota equation

In the previous sections, we have seen that the Y-system equation describes the finite size effects of several integrable models, and we have seen in what sense this equation is equivalent to the Hirota equation (III.57).

We will now write the typical solution of the Hirota equation for different (a, s) lattices. We will see that for the lattices $\mathbb{L}(K, M)$ of spin chains, this solution will be the same as in section II.3.2.3. More generally, we will see that for each of lattices introduced in section III.2.1, the typical solution of the Hirota equation (which is an infinite set of equations on an infinite set of functions $T_{a,s}$), is parameterized by a finite set of q -functions.

Let us start with a statement [KLWZ97, Zab96, Zab98] for the lattice $\mathbb{S}(N)$ of the $\text{SU}(N) \times \text{SU}(N)$ principal chiral model:

Statement 4. *Let $T_{a,s}$ be any typical solution of the Hirota equation on $\mathbb{S}(N)$.*

Then there exist two sets of functions $q_{\{1\}}, q_{\{2\}}, \dots, q_{\{N\}}, p_{\{1\}}, p_{\{2\}}, \dots, p_{\{N\}}$, and

two additional functions q_\emptyset and p_\emptyset such that

$$\forall a \in \llbracket 1, N \rrbracket, \quad \forall s \in \mathbb{Z}, \quad T_{a,s} = \sum_{\substack{I \subset \llbracket 1, N \rrbracket \\ |I|=a}} \epsilon(I, \bar{I}) q_I^{[+s]} p_{\bar{I}}^{[-s]} \quad (\text{III.97})$$

$$\text{where } q_{\{i_1, i_2, \dots, i_n\}} = \frac{\left| \left(q_{\{i_k\}}^{[-1-n+2l]} \right)_{1 \leq k, l \leq n} \right|}{\prod_{k=1}^{n-1} q_\emptyset^{[2k-n]}}, \quad 1 \leq i_1 < i_2 < \dots < i_n \leq N, \quad (\text{III.98})$$

$$\text{and } p_{\{i_1, i_2, \dots, i_n\}} = \frac{\left| \left(p_{\{i_k\}}^{[-1-n+2l]} \right)_{1 \leq k, l \leq n} \right|}{\prod_{k=1}^{n-1} p_\emptyset^{[2k-n]}}, \quad 1 \leq i_1 < i_2 < \dots < i_n \leq N. \quad (\text{III.99})$$

In the expression (III.97), the sum runs over all subsets $I \subset \llbracket 1, N \rrbracket$ having exactly a elements. For convenience we can write $I = \{i_1, i_2, \dots, i_a\}$ where $i_k < i_{k+1}$, $\bar{I} \equiv \llbracket 1, N \rrbracket \setminus I = \{j_1, j_2, \dots, j_{N-a}\}$ where $j_k < j_{k+1}$. Then the sign $\epsilon(I, \bar{I})$ is defined as the signature of a permutation:

$$\epsilon(I, \bar{I}) = \epsilon(\sigma), \quad \sigma(n) = \begin{cases} i_n & \text{if } n \in \llbracket 1, |I| \rrbracket \\ j_{n-|I|} & \text{if } n \in \llbracket |I| + 1, N \rrbracket \end{cases}. \quad (\text{III.100})$$

$$\text{where } I = \{i_1, i_2, \dots, i_a\}, \quad \bar{I} = \{j_1, j_2, \dots, j_{N-a}\}, \quad i_k < i_{k+1}, \quad j_k < j_{k+1}. \quad (\text{III.101})$$

For instance, if $N = 3$ and $a = 1$, then $\epsilon(\{1\}, \{2, 3\}) = +1 = \epsilon(\{3\}, \{1, 2\})$ whereas $\epsilon(\{2\}, \{1, 3\}) = -1$. Hence $T_{1,s} = q_{\{1\}}^{[+s]} p_{\{2,3\}}^{[-s]} - q_{\{2\}}^{[+s]} p_{\{1,3\}}^{[-s]} + q_{\{3\}}^{[+s]} p_{\{1,2\}}^{[-s]}$.

Proof of the statement 4. Like for the proofs of the previous section, we will use a set of initial values which characterize $T_{a,s}$. First, let us show that the T -functions $T_{0,0}$, $T_{0,1}$, and $\{T_{1,s} | 0 \leq s \leq 2N - 1\}$ are initial values, in the sense that if we know these values, then we can successively deduce all T -functions: first all $T_{0,s}$ can be expressed from $T_{0,0}$ and $T_{0,1}$. Then the Hirota equation allows to express $\{T_{2,s} | 1 \leq s \leq 2N - 2\}$, then $\{T_{3,s} | 2 \leq s \leq 2N - 3\}$ and iteratively up to $\{T_{N,s} | N - 1 \leq s \leq N\}$. As a consequence the T -functions of $\{T_{a,s} | 0 \leq s \leq 1\}$ are expressed from these initial conditions. Finally, a simple recurrence gives all the T -functions out of $\{T_{a,s} | 0 \leq s \leq 1\}$.

The proof of (III.97) will be obtained by finding functions q such that (III.97) holds for these initial values and by deducing that it holds for all (a, s) .

To this end, we can use the fact that if (III.97) holds, then the following determinant is zero:

$$\forall i \in \llbracket 1, N \rrbracket, \quad \left| \begin{array}{c} \left(q_{\{i\}}^{[2l]} \right)_{1 \leq l \leq N+1} \\ \left(T_{1, k+l-3}^{[l-k+3]} \right)_{\substack{2 \leq k \leq N+1 \\ 1 \leq l \leq N+1}} \end{array} \right| = 0 \quad (\text{III.102})$$

For instance when $N = 2$, this determinant reads

$$\begin{vmatrix} q_{\{i\}}^{[+2]} & q_{\{i\}}^{[+4]} & q_{\{i\}}^{[+6]} \\ T_{1,0}^{[+2]} & T_{1,1}^{[+3]} & T_{1,2}^{[+4]} \\ T_{1,1}^{[+1]} & T_{1,2}^{[+2]} & T_{1,3}^{[+3]} \end{vmatrix} = 0 \quad (\text{III.103})$$

$$\text{where } \begin{cases} (T_{1,0}^{[+2]}, T_{1,1}^{[+3]}, T_{1,2}^{[+4]}) = p_{\{2\}}^{[+2]}(q_{\{1\}}^{[+2]}, q_{\{1\}}^{[+4]}, q_{\{1\}}^{[+6]}) - p_{\{1\}}^{[+2]}(q_{\{2\}}^{[+2]}, q_{\{2\}}^{[+4]}, q_{\{2\}}^{[+6]}) \\ (T_{1,1}^{[+1]}, T_{1,2}^{[+2]}, T_{1,3}^{[+3]}) = p_{\{2\}}^{[0]}(q_{\{1\}}^{[+2]}, q_{\{1\}}^{[+4]}, q_{\{1\}}^{[+6]}) - p_{\{1\}}^{[0]}(q_{\{2\}}^{[+2]}, q_{\{2\}}^{[+4]}, q_{\{2\}}^{[+6]}) \end{cases} \quad (\text{III.104})$$

The expression (III.104) is directly read from (III.97), and it implies that (III.103) holds, because for any $i \in \{1, 2\}$, the first line is a linear combination of the last lines. When $N > 2$, (III.97) still implies that the determinant (III.102) is zero by the same argument.

Let us now go in the opposite direction, and assume that we have T -functions, but we do not know yet whether (III.97) holds. Then, we can view the equation (III.102) as a difference equation¹¹ which defines $q_{\{i\}}$. This equation will be called the Baxter equation. In general (i.e. under typicality condition on the T -functions) this equation has N independent solutions, which we can choose to denote as $q_{\{1\}}, q_{\{2\}}, \dots, q_{\{N\}}$. If we denote by v_i the vector $v_i = (q_{\{i\}}^{[+2]}, q_{\{i\}}^{[+4]}, \dots, q_{\{i\}}^{[+2N+2]})$, then the independence of these solutions means that the vectors $\{v_i | 1 \leq i \leq N\}$ span the N -dimensional space $\text{Vect}\{w_k | 2 \leq k \leq N+1\}$ where $w_k = (T_{1,k-2}^{[4-k]}, T_{1,k-1}^{[5-k]}, \dots, T_{1,k+N-2}^{[N+4-k]})$. Therefore w_k is a linear combination of the vectors v_i , and there exist functions $\alpha_{k,i}(u)$ such that

$$w_k = \sum_{i=1}^N \alpha_{k,i} v_i \quad (\text{III.105})$$

$$\text{i.e. } \forall k \in \llbracket 2, N+1 \rrbracket, \quad \forall l \in \llbracket 1, N+1 \rrbracket, \quad T_{1,k+l-3}^{[l-k+3]} = \sum_{i=1}^N \alpha_{k,i} q_{\{i\}}^{[2l]}. \quad (\text{III.106})$$

For instance if $N = 2$, this equation reads

$$(T_{1,0}^{[+2]}, T_{1,1}^{[+3]}, T_{1,2}^{[+4]}) = \alpha_{2,1}(q_{\{1\}}^{[+2]}, q_{\{1\}}^{[+4]}, q_{\{1\}}^{[+6]}) + \alpha_{2,2}(q_{\{2\}}^{[+2]}, q_{\{2\}}^{[+4]}, q_{\{2\}}^{[+6]}) \quad (\text{III.107a})$$

$$(T_{1,1}^{[+1]}, T_{1,2}^{[+2]}, T_{1,3}^{[+3]}) = \alpha_{3,1}(q_{\{1\}}^{[+2]}, q_{\{1\}}^{[+4]}, q_{\{1\}}^{[+6]}) - \alpha_{3,2}(q_{\{2\}}^{[+2]}, q_{\{2\}}^{[+4]}, q_{\{2\}}^{[+6]}). \quad (\text{III.107b})$$

Comparing the expressions that it gives for $T_{1,1}$ and $T_{1,2}$, we deduce that $\alpha_{3,i} = \alpha_{2,i}^{[-2]}$ (assuming that $(q_{\{1\}}^{[+4]}, q_{\{1\}}^{[+6]})$ and $(q_{\{2\}}^{[+4]}, q_{\{2\}}^{[+6]})$ are independent).

For arbitrary N , the same argument gives $\alpha_{k+1,i} = \alpha_{k,i}^{[-2]} = \alpha_{2,i}^{[4-2k]}$, if the vectors $\tilde{v}_i = (q_{\{i\}}^{[+4]}, q_{\{i\}}^{[+6]}, \dots, q_{\{i\}}^{[+2N+2]})$ are independent. Finally, if we define $p_{\{i\}} \equiv \alpha_{2,i}^{[-2]}$, then the relation (III.105) says exactly that (III.97) holds when $a = 1$ and $0 \leq s \leq 2N - 1$.

Moreover we can find two functions q_\emptyset and p_{\emptyset} such that for $s \in \llbracket 0, 1 \rrbracket$, $T_{0,s} = q_\emptyset^{[+s]} p_{\emptyset}^{[-s]}$. For this it is sufficient to find q_\emptyset such that $\frac{q_\emptyset^+}{q_\emptyset} = \frac{T_{1,0}}{T_{0,0}}$, and to define $p_{\emptyset} \equiv T_{0,0}/q_\emptyset$.

¹¹By difference equation, we mean ‘‘discrete differential equation’’, also sometimes called ‘‘recurrence equation’’.

Finally, the determinant expression (III.99) is equivalent (because of the Jacobi identity (II.103)) to the bilinear identity

$$\forall I \subset \llbracket 1, N \rrbracket, \forall i, j \in \bar{I} \text{ such that } i < j, \\ p_I p_{I, i, j} = p_{I, i}^- p_{I, j}^+ - p_{I, i}^+ p_{I, j}^-, \quad \text{where } I, i, j \equiv I \cup \{i, j\} \quad (\text{III.108})$$

The Jacobi identity also implies that this bilinear identity is equivalent to

$$P_{\{i_1, i_2, \dots, i_n\}} = \frac{\left| \left(p_{\{i_k\}}^{[n+1-2l]} \right)_{1 \leq k, l \leq n} \right|}{\prod_{k=1}^{n-1} p_{\emptyset}^{[2k-n]}}. \quad (\text{III.109})$$

Therefore, we can express $p_{\{1\}} = P_{\{2, 3, \dots, N\}}$, $p_{\{2\}} = P_{\{1, 3, \dots, N\}}$, \dots , $p_{\{N\}} = P_{\{1, 2, \dots, N-1\}}$ in terms of the functions $p_{\{i\}}$ and p_{\emptyset} defined above.

To summarize the above construction, we have seen that if $T_{a,s}$ is a typical solution of the Hirota equation on the (a, s) -lattice of the principal chiral model (i.e. $T_{a,s} = 0$ if $a < 0$ or $a > N$), then we can define $q_{\{1\}}$, $q_{\{2\}}$, \dots , $q_{\{N\}}$, $p_{\{1\}}$, $p_{\{2\}}$, \dots , $p_{\{N\}}$, and q_{\emptyset} and p_{\emptyset} such that (III.97) holds when $a = 1$ and $s \in \llbracket 1, 2N - 1 \rrbracket$, and also when $a = 0$ and $s \in \{0, 1\}$. Moreover, there exists a determinant identity, analogous to the Jacobi identity, which allows to prove [KLWZ97] that (III.97) is a solution of the Hirota equation. Therefore the quantity $\tilde{T}_{a,s} \equiv \sum_{I \subset \llbracket 1, N \rrbracket} \epsilon(I, \bar{I}) q_I^{[+s]} p_{\bar{I}}^{[-s]}$ is a solution of the Hirota equation, which coincides with $T_{a,s}$ for a set of initial values. This implies that $\tilde{T}_{a,s} = T_{a,s}$. \square

In this derivation of (III.97), we have assumed that the difference equation (III.102) has N independent solutions, and that the vectors $\tilde{v}_i = (q_{\{i\}}^{[+4]}, q_{\{i\}}^{[+6]}, \dots, q_{\{i\}}^{[+2N+2]})$ are independent.

There exist non-typical solutions of the Hirota equations for which these hypotheses do not hold, and for which the determinant expression (III.97) does not hold either. Though it is a bit more technical to prove, these hypotheses hold for typical solutions, hence the statement 4 is a statement about typical solutions. As explained in the previous sections, this typicality condition should hold for the solution of Hirota equations obtained from the solutions of the Y-system equations arising from the thermodynamic Bethe ansatz.

In (III.97), we see that two sets of functions, denoted by q and p play a completely symmetric role. In what follows, both of them will be called q -functions, although they are denoted by two different letters q and p .

Expression in terms of forms Let us comment a little bit on the form of the expression (III.97) proven above. We will see below that the expression (III.97) has the same structure as the expressions for the rectangular representations of spin chains, written in section II.3.2.3 of the previous chapter.

In particular they can be written as a determinant [KLWZ97], like for spin chains where we saw that the expression (II.262) (which has the same form as (III.97)) was

identical to the determinant expression (II.259) (as it could be seen by expanding the determinant with respect to the first lines). More explicitly, in the present case the expression (III.97) is identical to

$$T_{a,s} = \frac{\begin{vmatrix} \left(q_{\{j\}}^{[+s-1-a+2i]} \right)_{\substack{1 \leq j \leq N \\ 1 \leq i \leq a}} \\ \left(P_{\{j\}}^{[-s-1-a-N+2i]} \right)_{\substack{1 \leq j \leq N \\ a+1 \leq i \leq N-a}} \end{vmatrix}}{\prod_{k=1}^{a-1} q_{\emptyset}^{[+s-a+2k]} \prod_{k=1}^{N-a-1} P_{\emptyset}^{[-s-N+a+2k]}}. \quad (\text{III.110})$$

For instance when $a = 1$, we see that if we expand the determinant (III.110) with respect to the first line, we get N terms where each term is equal to $(-1)^j q_{\{j\}}^{[+s]}$ times the corresponding $(N-1) \times (N-1)$ minor. Finally, using the definition (III.99) of multi-indexed q -functions, we recognize that the expression (III.110) and (III.97) are identical when $a = 1$. When $a \neq 1$, one can use the ‘‘generalized Laplace expansion formula’’, which says how to expand a determinant with respect to several lines at once. If we expand with respect to the a first lines at once, this formula gives a sum of terms which are products of $a \times a$ minors (corresponding to the first lines) multiplied by $(N-a) \times (N-a)$ minors (corresponding to the last lines), and we obtain that the Wronskian determinant (III.110) is identical to the expression (III.97).

Another convenient way to rewrite this expression is by means of ‘‘exterior forms’’ [11GKLV]. Let us define N objects $\xi_1, \xi_2, \dots, \xi_N$, and an antisymmetric (and linear) product \wedge such that $\xi_1 \wedge \xi_2 \wedge \dots \wedge \xi_N = 1$. Then the linearity and antisymmetry of the product \wedge imply that for arbitrary coefficients $(c_{i,j})_{1 \leq i,j \leq N}$, we have

$$\left(\sum_{i=1}^N c_{i,1} \xi_1 \right) \wedge \left(\sum_{i=1}^N c_{i,2} \xi_2 \right) \wedge \dots \wedge \left(\sum_{i=1}^N c_{i,N} \xi_N \right) = \left| (c_{i,j})_{1 \leq i,j \leq N} \right|, \quad (\text{III.111})$$

so that we can view this product \wedge as a formal antisymmetric multiplication of objects, designed to give rise to determinants. In what follows, we call 1-form an arbitrary linear combination of ξ_1, ξ_2, \dots , and ξ_N . The product of n (1)-forms is an (n) -form, and by definition a (0)-form is a usual scalar.

Let us now rewrite, in this language, the expression (III.110) of T -functions (which is identical to the expression (III.97)). To this end, let us define the (1)-forms

$$q_{(1)} \equiv \sum_{i=1}^N q_{\{i\}} \xi_i, \quad p_{(1)} \equiv \sum_{i=1}^N p_{\{i\}} \xi_i. \quad (\text{III.112})$$

If we also introduce the (n) -forms

$$q_{(n)} \equiv \frac{q_{(1)}^{[-n+1]} \wedge q_{(1)}^{[-n+3]} \wedge q_{(1)}^{[-n+5]} \wedge \dots \wedge q_{(1)}^{[n-1]}}{q_{\emptyset}^{[-n+2]} q_{\emptyset}^{[-n+4]} \dots q_{\emptyset}^{[n-2]}}, \quad n > 1, \quad (\text{III.113})$$

$$p_{(n)} \equiv \frac{p_{(1)}^{[-n+1]} \wedge p_{(1)}^{[-n+3]} \wedge p_{(1)}^{[-n+5]} \wedge \dots \wedge p_{(1)}^{[n-1]}}{p_{\emptyset}^{[-n+2]} p_{\emptyset}^{[-n+4]} \dots p_{\emptyset}^{[n-2]}}, \quad n > 1, \quad (\text{III.114})$$

$$q_{(0)} \equiv q_{\emptyset}, \quad p_{(0)} \equiv p_{\emptyset}, \quad (\text{III.115})$$

then we see that the formula (III.110) can be rewritten as

$$T_{a,s} = q_{(a)}^{[+s]} \wedge p_{(N-a)}^{[-s]}. \quad (\text{III.116})$$

Moreover, if we wish to compare this expression with the initial notation (III.97-(III.99)), we see that (if $i_1 < i_2 < \dots < i_n$) the function $q_{\{i_1, i_2, \dots, i_n\}}$ is the coefficient of $\xi_{i_1} \wedge \xi_{i_2} \wedge \dots \wedge \xi_{i_n}$ in $q_{(n)}$, and we see that the expression (III.116) and (III.97) are identical.

The notation $q_{\{i_1, i_2, \dots, i_n\}}$ (with curly brackets around the indices) suggests that, as in chapter II, we have

$$\forall \sigma \in \mathcal{S}^n, \quad q_{\{i_{\sigma(1)}, i_{\sigma(2)}, \dots, i_{\sigma(n)}\}} = q_{\{i_1, i_2, \dots, i_n\}}. \quad (\text{III.117})$$

On the other hand, as we see that $q_{\{i_1, i_2, \dots, i_n\}}$ is the coefficient of $\xi_{i_1} \wedge \xi_{i_2} \wedge \dots \wedge \xi_{i_n}$ (which is antisymmetric), it is actually more natural to use a notation (denoted without curly brackets) where

$$\forall \sigma \in \mathcal{S}^n, \quad q_{i_{\sigma(1)}, i_{\sigma(2)}, \dots, i_{\sigma(n)}} = \epsilon(\sigma) q_{i_1, i_2, \dots, i_n}, \quad (\text{III.118})$$

$$\text{and } q_{i_1, i_2, \dots, i_n} = q_{\{i_1, i_2, \dots, i_n\}}, \quad \text{if } i_1 < i_2 < \dots < i_n. \quad (\text{III.119})$$

With this notation we see that q_{i_1, i_2, \dots, i_n} is the coefficient of $\xi_{i_1} \wedge \xi_{i_2} \wedge \dots \wedge \xi_{i_n}$ in $q_{(n)}$. For the simplicity of notations, we will try to use, as much as possible, this antisymmetric definition, denoted without curly brackets.

We can also note that the definition (III.113) is equivalent¹² to the following qq-relation [Woy83, BCFH92, BHK02b, PS00, DDM⁺07]:

$$q_{\dots, j, \mathbf{k}} q_{\dots} = q_{\dots, j}^- q_{\dots, \mathbf{k}}^+ - q_{\dots, j}^+ q_{\dots, \mathbf{k}}^-. \quad (\text{III.120})$$

where “...” stands for an arbitrary set of indices, and where the Q -functions q_{i_1, i_2, \dots, i_n} , defined in (III.118-III.119), are the coordinates of the form $q_{(n)}$ defined by (III.113).

Generalization to other lattices Let us now generalize this result to other lattices starting with the lattice $\mathfrak{w}(K)$ (corresponding for instance to an $SU(K)$ -symmetric spin chain):

Statement 5. *Let $T_{a,s}$ be any typical solution of the Hirota equation on $\mathfrak{w}(K)$ such that the “Wronskian gauge” condition (III.73) is satisfied. Then there exist K functions q_1, q_2, \dots, q_K such that*

$$T_{a,s} = (-1)^{(K-1)(K-a)} q_{(a)}^{[+s]} \wedge q_{(K-a)}^{[-s-K]}, \quad (\text{III.121})$$

$$\text{where } q_{(1)} \equiv \sum_{i=1}^K q_i \xi_i, \quad \text{and } q_{(0)} \equiv 1, \quad (\text{III.122})$$

$$\text{and } q_{(n)} \equiv q_{(1)}^{[-n+1]} \wedge q_{(1)}^{[-n+3]} \wedge q_{(1)}^{[-n+5]} \wedge \dots \wedge q_{(1)}^{[n-1]} \quad \text{if } n > 1. \quad (\text{III.123})$$

¹²This equivalence has exactly the same proof as in section II.1.5 where the Jacobi identity shows the equivalence between a determinant expression and a bilinear identity.

We can notice that the main difference with the equation (III.97) is that for the lattice $\mathbb{S}(N)$, (i.e. for the symmetry group $SU(N) \times SU(N)$), we had two sets of N functions, whereas here we only have one set of K functions (for the group $SU(K)$). Another remark is that the gauge condition (III.73) allows to set $q_{(0)} = 1$.

This solution of Hirota equation was first introduced in [BLZ97a] for $K = 2$, and generalized in [KLWZ97] to arbitrary rank K .

Proof. To prove this statement, we will first show that (when $s \geq -1$), $T_{a,s}$ is given by the same expression (III.97) (or (III.110) in terms of a Wronskian determinant, or (III.116) in terms of exterior forms) as in the previous statement. Then we will translate the additional constraint $T_{a,-1} = 0$ (which makes the difference between the lattice $w(N)$ and $\mathbb{S}(N)$) into a constraint on the q -functions, which will allow to prove that the functions p_i and q_i coincide up to a shift and to a rescaling.

The construction used in the proof of the Statement 4 (page 116) allows to find two sets of functions $q_1, q_2, \dots, q_N, p_1, p_2, \dots, p_N$, and two additional functions q_\emptyset and p_\emptyset such that the equation (III.97) (or equivalently (III.116)) holds (at least for initial values). In this construction, the two functions q_\emptyset and p_\emptyset simply have to obey

$$\forall s \in \llbracket 0, 1 \rrbracket, \quad T_{0,s} = q_\emptyset^{[+s]} p_\emptyset^{[-s]}. \quad (\text{III.124})$$

In view of the Wronskian gauge condition (III.73), we can choose $q_\emptyset = 1$ and $p_\emptyset = T_{0,0}$. We can also notice that a particular case of (III.97) is $T_{K,s} = q_\emptyset^{[+s]} p_\emptyset^{[-s]}$. Then the gauge condition $T_{K,s+1} = T_{K,s}^+$ gives $p_\emptyset^+ = p_\emptyset^-$, which means that p_\emptyset is \mathfrak{i} -periodic.

Compared to the Statement 4 (page 116), another important difference is that now, the T -functions should obey the boundary condition

$$\forall a \in \llbracket 1, K-1 \rrbracket, \quad T_{a,-1} = 0. \quad (\text{III.125})$$

In the proof of Statement 4, the equation (III.97) (or equivalently (III.116)) holds by construction for initial values, and by recurrence it holds for every (a, s) . In the present case, the same recurrence proves that (III.97) holds when $s \geq -1$. If s is smaller, then the recurrence cannot be performed because it would involve a division by zero. But this result is exactly enough to rewrite (III.125) in terms of the expression (III.116), and obtain the vanishing of the following determinants:

$$\forall a \in \llbracket 1, K-1 \rrbracket, \quad T_{a,-1} = \left| \begin{array}{c} \left(q_i^{[-a-2+2j]} \right)_{\substack{1 \leq i \leq K \\ 1 \leq j \leq a}} \\ \left(p_i^{[-K-a+2j]} \right)_{\substack{1 \leq i \leq K \\ a+1 \leq j \leq K}} \end{array} \right| = 0. \quad (\text{III.126})$$

At $a = K-1$, it implies that there exist $K-1$ functions c_k such that

$$p_{(1)} = \sum_{k=0}^{K-2} c_k q_{(1)}^{[-K+2k]}, \quad (\text{III.127})$$

$$\text{where } p_{(1)} \equiv \sum_{i=1}^K p_i \xi_i, \quad \text{and } q_{(1)} \equiv \sum_{i=1}^K q_i \xi_i. \quad (\text{III.128})$$

Then we can write the condition (III.126) at $a = K - 2$. The determinant has its two last lines made of functions p_i , and in particular, the last line is $p_{(1)}^{[+2]}$. We have just shown that $p_{(1)}^{[+2]} = \sum_{k=0}^{K-2} c_k^{[+2]} q_{(1)}^{[-K+2k+2]}$, which allows to replace the last line of the determinant by this sum. The terms $c_0^{[+2]} q_{(1)}^{[-K+2]}$, $c_1^{[+2]} q_{(1)}^{[-K+4]}$, \dots , $c_{K-3}^{[+2]} q_{(1)}^{[+K-4]}$ give a determinant equal to zero (where two lines are equal), and the only remaining term is $c_{K-2}^{[+2]} q_{(1)}^{[-K+2]}$. That gives

$$-c_{K-2}^{[+2]} \begin{vmatrix} \left(q_{\{i\}}^{[-K+2j]} \right)_{\substack{1 \leq i \leq K \\ 1 \leq j \leq K-1}} \\ \left(p_{\{i\}} \right)_{1 \leq i \leq K} \end{vmatrix} = 0, \quad (\text{III.129})$$

where we can notice that the determinant is equal to $T_{K-1,0} \neq 0$. Therefore we obtain $c_{K-2} = 0$.

Next we can write the condition (III.126) at $a = K - 3$. We can plug the expression (III.127) into the last line of the determinant, and we obtain $c_{K-3} = 0$. We can repeat the argument for $a = K - 5$, $a = K - 7$, etc up to $a = 1$. That gives $c_{K-2} = c_{K-5} = \dots = c_1 = 0$. Hence we obtain that there exists a function $c_0(u)$ such that

$$p_{(1)} = c_0 q_{(1)}^{[-K]}. \quad (\text{III.130})$$

Let us now find an expression for c_0 . To this end, let us write down

$$T_{K-1,0} = \begin{vmatrix} \left(q_i^{[-K+2j]} \right)_{\substack{1 \leq i \leq K \\ 1 \leq j \leq K-1}} \\ \left(p_i \right)_{1 \leq i \leq K} \end{vmatrix} \quad (\text{III.131})$$

$$= (-1)^{K-1} c_0 \begin{vmatrix} \left(q_i^{[-K-2+2j]} \right)_{1 \leq i, j \leq K} \end{vmatrix} = \frac{(-1)^{K-1} c_0}{p_{\emptyset}^-} T_{K-1,0}^-. \quad (\text{III.132})$$

As compared to the gauge condition (III.73), this gives

$$c_0 = (-1)^{K-1} p_{\emptyset}^-. \quad (\text{III.133})$$

Finally, we should rescale the functions q_i in order to obtain the expression (III.121). Let us define

$$\tilde{q}_i = f q_i, \quad \text{where } f \equiv \left(p_{\emptyset}^{[+K+1]} \right)^{1/K}. \quad (\text{III.134})$$

This definition is such that

$$T_{K,s} = q_{\emptyset}^{[+s]} p_{\emptyset}^{[-s]} = p_{\emptyset}^{[-s]} \begin{vmatrix} \left(q_i^{[-K-1+2j+s]} \right)_{1 \leq i, j \leq K} \end{vmatrix} \quad (\text{III.135})$$

$$= \begin{vmatrix} \left(\tilde{q}_i^{[-K-1+2j+s]} \right)_{1 \leq i, j \leq K} \end{vmatrix} \frac{p_{\emptyset}^{[-s]}}{\prod_{j=1}^K f^{[-K-1+2j+s]}} \quad (\text{III.136})$$

$$= \begin{vmatrix} \left(\tilde{q}_i^{[-K-1+2j+s]} \right)_{1 \leq i, j \leq K} \end{vmatrix} = \tilde{q}_{(K)}^{[+s]}, \quad (\text{III.137})$$

$$\text{where } \tilde{q}_{(0)} \equiv 1, \quad \text{and } \tilde{q}_{(n)} \equiv \tilde{q}_{(1)}^{[-n+1]} \wedge \tilde{q}_{(1)}^{[-n+3]} \wedge \dots \wedge \tilde{q}_{(1)}^{[n-1]}, \quad \text{for } n > 1. \quad (\text{III.138})$$

To see this, we used the identity $\frac{p_\emptyset^{[-s]}}{\prod_{j=1}^K f^{[-K-1+2j+s]}} = 1$, which arises because p_\emptyset is i -periodic.

We can also notice that (for $s \geq -1$)

$$T_{K-1,s} = \left| \begin{array}{c} \left(q_i^{[-K+2j+s]} \right)_{\substack{1 \leq i \leq K \\ 1 \leq j \leq K-1}} \\ \left(p_i^{[-s]} \right)_{1 \leq i \leq K} \end{array} \right| = c_0^{[-s]} \left| \begin{array}{c} \left(q_i^{[-K+2j+s]} \right)_{\substack{1 \leq i \leq K \\ 1 \leq j \leq K-1}} \\ \left(q_i^{[-K-s]} \right)_{1 \leq i \leq K} \end{array} \right| \quad (\text{III.139})$$

$$= (-1)^{K-1} \frac{p_\emptyset^{[-s-1]}}{(f^{[K+s]})^K} \left| \begin{array}{c} \left(\tilde{q}_i^{[-K+2j+s]} \right)_{\substack{1 \leq i \leq K \\ 1 \leq j \leq K-1}} \\ \left(\tilde{q}_i^{[-K-s]} \right)_{1 \leq i \leq K} \end{array} \right| \quad (\text{III.140})$$

$$= (-1)^{K-1} \tilde{q}_{(K-1)}^{[+s]} \wedge \tilde{q}_{(1)}^{[-K-s]} \quad (\text{III.141})$$

Therefore we have proven that $T_{a,s} = (-1)^{(K-1)(K-a)} \tilde{q}_{(a)}^{[+s]} \wedge \tilde{q}_{(K-a)}^{[-s-K]}$ holds when $a = K$ and when $a = K - 1$, which implies¹³ that it holds on the whole lattice $\mathfrak{w}(K)$. If we finally rename the q -functions as $\tilde{q} \rightsquigarrow q$, this proves the relation (III.121). \square

We can note that the solution (III.121) is very similar to the expression (II.262) obtained for spin chains. This is not a surprise because these two expressions are solution of the Hirota equation on the same lattice $\mathfrak{w}(K)$. More precisely we can see that these expressions coincide up to the change of variables

$$q_{i_1, i_2, \dots, i_n}(\mathbf{u}) = Q_{\{i_1, i_2, \dots, i_n\}} \left(-i\mathbf{u} + \frac{n}{2} \right) \prod_{k=1}^n x_{i_k}^{-i\mathbf{u} - \frac{n}{2}} \prod_{l=k+1}^n (x_l - x_k). \quad (\text{III.142})$$

The Q -functions of chapter II obeyed QQ-relations which involved the eigenvalues x_j of the twist g (see (II.181)), whereas after the change of variables (III.142), the qq-relation does not contain a twist anymore (see for instance (III.108) and (III.120)). Moreover, we see that in (III.142), we have defined the left hand side as an antisymmetric function of the indices i_1, i_2, \dots, i_n , motivated by the exterior forms formalism. In the right-hand-side, we also see an antisymmetry which comes from the factor $\prod_{l=k+1}^n (x_l - x_k)$. We see that the twist is responsible for this difference between the present chapter and the chapter II, where we explicitly constructed Q -operators which are symmetric functions of their indices.

Another difference between the Q -functions of chapter II and the present q -functions is that in general the q -functions are not polynomial. Indeed, they are constructed for an arbitrary solution of the Hirota equation, which may or may not be polynomial.

Due to these differences, we use a small letter for the q -functions of this chapter, as opposed to the capital letter of the Q -functions of chapter II. The capital letter Q will also be used in this section to denote polynomial functions, whose roots will be the rapidities of excitations (“particles”).

¹³Indeed, the set $\{T_{K,1}\} \cup \{T_{K-1,s} | \leq s \leq K-1\}$ can be used as initial value for the Hirota equation on the lattice $\mathfrak{w}(K)$ under the Wronskian gauge condition.

For an arbitrary “ \mathbb{T} -hook” $\mathbb{T}(K, K'|M+M')$, the typical solution of Hirota equation can also be easily written in terms of q -functions. This solution is written in the statement below, and it was first written for $(K, K' + M'|M) = (2, 0|1)$ in [BDKM07, BT08], then generalized to an arbitrary lattice $\mathbb{L}(K, M) = \mathbb{T}(K, 0|M)$ (corresponding to $\text{GL}(K|M)$ spin chains) in [Tsu10]. For “ \mathbb{T} -hook”, the character solution (i.e. the solution of Hirota equation without spectral parameter) was first written in [GKT10] for the AdS/CFT “ \mathbb{T} -hook” $\mathbb{T}(2, 2|4)$. We then generalized it to the u -dependent Wronskian solution of the Hirota equation in [11GKLT], and the generalization to an arbitrary “ \mathbb{T} -hook” was written in [Tsu11]. The proof can in principle be obtained by the same method as the Statement 5 (page 121), i.e. by first finding a Wronskian expression in terms of too many functions¹⁴, and then showing that they are not independent of each other and they can be expressed in terms of only $K + K' + M + M' + 1$ functions. However, this is more technical than for the Statement 5, and is not crucial for what follows, hence this solution will be given here without proof.

Statement 6. *Let $T_{a,s}$ be any typical solution of the Hirota equation on $\mathbb{T}(K, K'|M+M')$ such that the “Wronskian gauge” condition (III.81) is satisfied.*

Then there exists a set of functions $\tilde{\mathcal{Q}}_1, \tilde{\mathcal{Q}}_2, \dots, \tilde{\mathcal{Q}}_{K+K'+M+M'}$ and an additional function $\tilde{\mathcal{Q}}_\emptyset$ such that

$$T_{a,s} = \begin{cases} \sum_{\substack{I \subset \llbracket 1, K \rrbracket \\ |I|=a}} \epsilon(I, \bar{I}) \mathcal{Q}_I^{[+s + \frac{K-K'-M+M'}{2}]} \mathcal{Q}_{\bar{I}}^{[-s - \frac{K-K'-M+M'}{2}]} & \text{if } s \geq M + a - K \quad (\text{III.143}) \\ \epsilon_{a,s}^u \sum_{\substack{F \subset \llbracket K+1, K+M+M' \rrbracket \\ |F|=M-s \\ I = \llbracket 1, K \rrbracket \cup F}} \epsilon(I, \bar{I}) \mathcal{Q}_I^{[+a + \frac{-K-K'+M+M'}{2}]} \mathcal{Q}_{\bar{I}}^{[-a - \frac{-K-K'+M+M'}{2}]} & \text{if } a \geq s + K - M \text{ and } a \geq -s + K' - M' \quad (\text{III.144}) \\ \epsilon_{a,s}^l \sum_{\substack{B \subset \llbracket K+M+M'+1, K+K'+M+M' \rrbracket \\ |B|=K'-a \\ I = \llbracket 1, K+M+M' \rrbracket \cup B}} \epsilon(I, \bar{I}) \mathcal{Q}_I^{[-s + \frac{-K+K'+M-M'}{2}]} \mathcal{Q}_{\bar{I}}^{[+s - \frac{-K+K'+M-M'}{2}]} & \text{if } s \leq -a + K' - M' \quad (\text{III.145}) \end{cases}$$

$$\text{where } \epsilon_{a,s}^u \equiv (-1)^{(a+1+K+K'+M+M')(s+K'+M')}, \quad (\text{III.146})$$

$$\epsilon_{a,s}^l \equiv (-1)^{a(K+K'+M+M')} \quad (\text{III.147})$$

$$\text{and } \mathcal{Q}_I \equiv \tilde{\mathcal{Q}}_J, \quad \text{where } J \equiv (F \cup I) \setminus (F \cap I), \quad F = \llbracket K+1, K+M+M' \rrbracket, \quad (\text{III.148})$$

$$\text{and } \tilde{\mathcal{Q}}_{\{j_1, j_2, \dots, j_n\}} = \frac{\left| \left(\tilde{\mathcal{Q}}_{j_k}^{[-1-n+2l]} \right)_{1 \leq k, l \leq n} \right|}{\prod_{k=1}^{n-1} \tilde{\mathcal{Q}}_\emptyset^{[2k-n]}}, \quad \text{if } j_1 < j_2 < \dots < j_n. \quad (\text{III.149})$$

¹⁴More precisely, we would a priori obtain $2K + 2$ functions to describe the domain $s \geq M + a - K$, plus $2(M + M') + 2$ functions to describe the domain where $a \geq s + K - M$ and $a \geq -s$, plus $2K' + 2$ functions to describe the domain $s \leq K' - M' - a$.

Moreover, the functions $\tilde{Q}_1, \tilde{Q}_2, \dots, \tilde{Q}_{K+K'+M+M'}$ and \tilde{Q}_0 can be chosen such that

$$\tilde{Q}_F = \frac{\left| \left(\tilde{Q}_{K+k}^{[-1-n+2l]} \right)_{1 \leq k, l \leq M+M'} \right|}{\prod_{k=1}^{n-1} \tilde{Q}_0^{[2k-n]}} = 1. \quad (\text{III.150})$$

The letter Q (resp \tilde{Q}) denote here the Q -functions associated to a super-group (and to a lattice $\mathbb{T}(K, K'|M + M')$ or $\mathbb{L}(K, M)$, cf figure III.4 and figure III.5 (page 108)), whereas the letter q (in the previous statements) denotes the q -functions associated to the group $SU(K)$ or $SU(N) \times SU(N)$. The choice of a different letter is simply aimed at preventing confusions in the chapter IV, and does not have a deep physical meaning.

We can see that the expressions (III.143-III.145) have the same structure as the equation (II.265): namely the T -functions are sums of terms of the form $Q_I^{[+\alpha]} Q_I^{[-\alpha]}$ where α is equal to a constant plus a or $|s|$ (depending on the domain). In the row $a = 0$ of the “right band” (which means the domain $s \geq M + a - K$), the set I is equal to \emptyset , and when a increases, I acquires new elements which belong to $\llbracket 1, K \rrbracket$. Then we arrive to the “upper band” (i.e. the domain $a \geq s + K - M$ and $a \geq -s$). At the boundary ($s = M$) the T -functions are the same as at the boundary $a = K$ of the right band, and that is a consequence of the gauge constraint (III.81). Then, when s decreases, I acquires new elements which belong to the set $\llbracket K + 1, K + M + M' \rrbracket$. Finally, in the last domain $s \leq -a + K' - M'$ (the “left band”), the set I acquires the elements of $\llbracket K + M + M' + 1, K + K' + M + M' \rrbracket$. Therefore the set of indices $\llbracket 1, K \rrbracket$ is associated to the right band, while $\llbracket K + 1, K + M + M' \rrbracket$ is associated to the upper band and $\llbracket K + M + M' + 1, K + K' + M + M' \rrbracket$ is associated to the left band. This structure is summarized in figure III.6 (in the notation of exterior forms).

Like in the particular case of the lattice $\mathbb{L}(K, M)$, which was studied in chapter II for spin chains, we will see (see (III.154, III.155)) that the QQ -relations are modified by the grading of the indices. On the other hand the functions \tilde{Q} obey $\tilde{Q}\tilde{Q}$ -relations which are independent of the grading. This constructions comes from the “bozonisation trick” of equation (II.254) in section II.3.2.3 (see also [11GKLT]). More precisely, the formula (III.149) ensures the following $\tilde{Q}\tilde{Q}$ -relation, which is not grading-dependent.

$$\tilde{Q}_{i_1, i_2, \dots, i_n, j, \mathbf{k}} \tilde{Q}_{i_1, i_2, \dots, i_n} = \tilde{Q}_{i_1, i_2, \dots, i_n, j}^- \tilde{Q}_{i_1, i_2, \dots, i_n, \mathbf{k}}^+ - \tilde{Q}_{i_1, i_2, \dots, i_n, j}^+ \tilde{Q}_{i_1, i_2, \dots, i_n, \mathbf{k}}^-, \quad (\text{III.151})$$

$$\text{where } \tilde{Q}_{i_{\sigma(1)}, i_{\sigma(2)}, \dots, i_{\sigma(n)}} = \epsilon(\sigma) \tilde{Q}_{i_1, i_2, \dots, i_n}, \quad \text{for arbitrary } \sigma \in \mathcal{S}^n \quad (\text{III.152})$$

$$\text{and } \tilde{Q}_{i_1, i_2, \dots, i_n} = \tilde{Q}_{\{i_1, i_2, \dots, i_n\}}, \quad \text{if } i_1 < i_2 < \dots < i_n. \quad (\text{III.153})$$

After the change of labeling (III.148), we obtain the following QQ -relations [Tsu98,

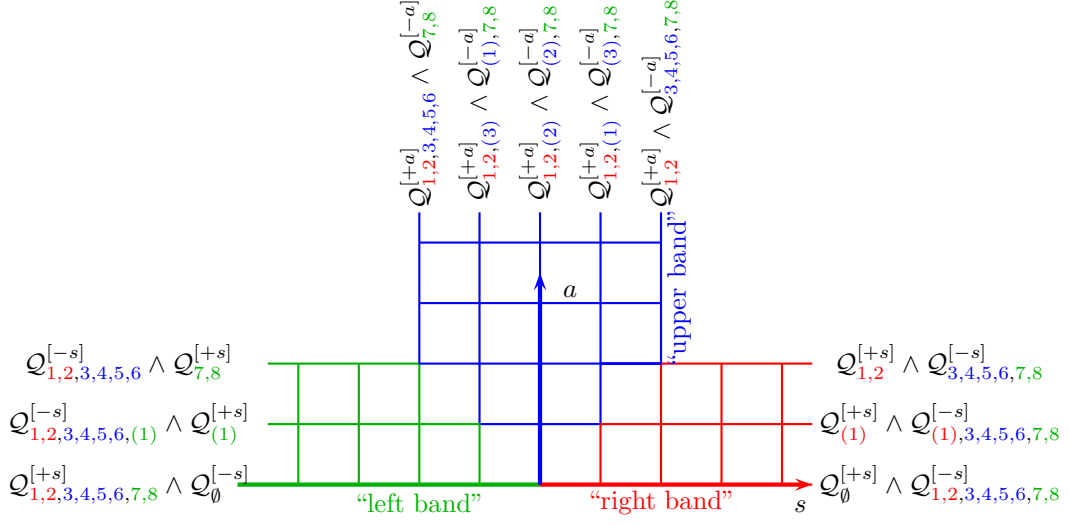

Figure III.6: The typical solution of Hirota equation for the \mathbb{T} -hook $\mathbb{T}(2, 2|2 + 2)$ of AdS/CFT (expressions are written up to a sign)

BDKM07, BT08, KSZ08, Zab08, GS03, GV08, 11GKLT]:

$$\left\{ \begin{array}{l} \mathcal{Q}_{i_1, i_2, \dots, i_n, j, \mathbf{k}} \mathcal{Q}_{i_1, i_2, \dots, i_n} = (-1)^{p_j} \left(\mathcal{Q}_{i_1, i_2, \dots, i_n, j}^- \mathcal{Q}_{i_1, i_2, \dots, i_n, \mathbf{k}}^+ \right. \\ \qquad \qquad \qquad \left. - \mathcal{Q}_{i_1, i_2, \dots, i_n, j}^+ \mathcal{Q}_{i_1, i_2, \dots, i_n, \mathbf{k}}^- \right), \qquad \text{(III.154)} \\ \qquad \qquad \qquad \text{if } (-1)^{p_j} = (-1)^{p_{\mathbf{k}}}, \\ \\ \mathcal{Q}_{i_1, i_2, \dots, i_n, j} \mathcal{Q}_{i_1, i_2, \dots, i_n, \mathbf{k}} = (-1)^{p_j} \left(\mathcal{Q}_{i_1, i_2, \dots, i_n, j, \mathbf{k}}^- \mathcal{Q}_{i_1, i_2, \dots, i_n}^+ \right. \\ \qquad \qquad \qquad \left. - \mathcal{Q}_{i_1, i_2, \dots, i_n, j, \mathbf{k}}^+ \mathcal{Q}_{i_1, i_2, \dots, i_n}^- \right), \qquad \text{(III.155)} \\ \qquad \qquad \qquad \text{if } (-1)^{p_j} \neq (-1)^{p_{\mathbf{k}}}, \end{array} \right.$$

$$\text{where } \mathcal{Q}_{i_{\sigma(1)}, i_{\sigma(2)}, \dots, i_{\sigma(n)}} = \epsilon(\sigma) \mathcal{Q}_{i_1, i_2, \dots, i_n}, \qquad \text{for arbitrary } \sigma \in \mathcal{S}^n \qquad \text{(III.156)}$$

$$\text{and } \mathcal{Q}_{i_1, i_2, \dots, i_n} = \mathcal{Q}_{\{i_1, i_2, \dots, i_n\}}, \qquad \text{if } i_1 < i_2 < \dots < i_n. \qquad \text{(III.157)}$$

Here, the grading is $(-1)^{p_j} = -1$ for the indices j associated to upper band, i.e. the indices in $[[K + 1, K + M + M']]$ (and $(-1)^{p_j} = +1$ for all the other indices).

Expression in terms of forms In terms of form, the expressions (III.143-III.145) are conveniently rewritten as¹⁵

$$T_{a,s} = \begin{cases} \mathcal{Q}_{(a)}^{[+s+\frac{K-K'-M+M'}{2}]} \wedge \mathcal{Q}_{(K-a),K+1,K+2,\dots,K+M+M'+K'}^{[-s-\frac{K-K'-M+M'}{2}]} & \text{if } s \geq M+a-K \\ \epsilon_{a,s}^u \mathcal{Q}_{1,\dots,K,(M-s)}^{[+a+\frac{-K-K'+M+M'}{2}]} \wedge \mathcal{Q}_{(M'+s),K+M+M'+1,\dots,K+M+M'+K'}^{[-a-\frac{-K-K'+M+M'}{2}]} & \text{if } a \geq s+K-M \text{ and } a \geq -s+K'-M' \\ \epsilon_{a,s}^l \mathcal{Q}_{1,\dots,K+M+M',(K'-a)}^{[-s+\frac{-K+K'+M-M'}{2}]} \mathcal{Q}_{(a)}^{[+s-\frac{-K+K'+M-M'}{2}]} & \text{if } s \leq -a+K'-M' \end{cases} \quad \begin{matrix} \text{(III.158)} \\ \text{(III.159)} \\ \text{(III.160)} \end{matrix}$$

In the case of the \mathbb{T} -hook $\mathbb{T}(2, 2|2+2)$ of AdS/CFT, these expressions are summarized in figure III.6. The differential forms which appear in (III.158-III.160) are defined by

$$\mathcal{Q}_{a,\dots,b,(n)} \equiv \mathcal{Q}_{(n),a,\dots,b} \equiv \prod_{i=a}^b (\xi_i \partial_{\xi_i}) \mathcal{Q}_{(n+1+b-a)}, \quad \text{if } a < b \quad \text{(III.161)}$$

$$\text{where } \mathcal{Q}_{(n)} \equiv \sum_{i_1 < i_2 < \dots < i_n} \mathcal{Q}_{i_1, i_2, \dots, i_n} \xi_{i_1} \wedge \xi_{i_2} \wedge \dots \wedge \xi_{i_n}, \quad \text{(III.162)}$$

$$\text{and } (\xi_j \partial_{\xi_j}) \xi_{i_1} \wedge \xi_{i_2} \wedge \dots \wedge \xi_{i_n} = \begin{cases} \xi_{i_1} \wedge \xi_{i_2} \wedge \dots \wedge \xi_{i_n} & \text{if } j \in \{i_1, i_2, \dots, i_n\} \\ 0 & \text{otherwise.} \end{cases} \quad \text{(III.163)}$$

With these definitions, we see that the form $\mathcal{Q}_{a,\dots,b,(n)}$ contains all the \mathcal{Q} -functions labeled by a set of indices which contains $\llbracket a, b \rrbracket$, and n additional other indices. Moreover, the change of variable (III.148) between \mathcal{Q} and $\tilde{\mathcal{Q}}$ allows to compute the form $\mathcal{Q}_{(n)}$ in (III.162) as a partial Hodge dual¹⁶ of the form $\tilde{\mathcal{Q}}_{(n)}$ defined by

$$\begin{aligned} \tilde{\mathcal{Q}}_{(0)} &\equiv \tilde{\mathcal{Q}}_{\emptyset}, & \tilde{\mathcal{Q}}_{(1)} &\equiv \sum_{i=1}^{K+M+M'+K'} \tilde{\mathcal{Q}}_i \xi_i, & \text{(III.164)} \\ \text{and } \tilde{\mathcal{Q}}_{(n)} &\equiv \frac{\tilde{\mathcal{Q}}_{(1)}^{[-n+1]} \wedge \tilde{\mathcal{Q}}_{(1)}^{[-n+3]} \wedge \tilde{\mathcal{Q}}_{(1)}^{[-n+5]} \wedge \dots \wedge \tilde{\mathcal{Q}}_{(1)}^{[n-1]}}{\tilde{\mathcal{Q}}_{\emptyset}^{[-n+2]} \tilde{\mathcal{Q}}_{\emptyset}^{[-n+4]} \dots \tilde{\mathcal{Q}}_{\emptyset}^{[n-2]}}, & \text{when } n > 1. & \text{(III.165)} \end{aligned}$$

¹⁵The article [KLV12] will include a deeper study of these expressions written in terms of forms.

¹⁶ Hodge duality is simply a formalism to rewrite (in terms of forms), the change of variable (III.148) between \mathcal{Q} and $\tilde{\mathcal{Q}}$. It says that up to a sign, $\mathcal{Q}_{(n)}$ can be formally viewed as $\sum_n \mathcal{Q}_{(n)} \equiv \pm \left(\sum_{(-1)^{p_j} = -1} (\xi_j + \partial_{\xi_j}) \right) \sum_{n'} \tilde{\mathcal{Q}}_{(n')}$, where a sum runs over all indices j such that $(-1)^{p_j} = -1$.

Freedom in the choice of the q -functions In section III.2.2, we have seen that if two different (typical) solutions of the Hirota equation give rise to the same Y -functions, then they are equal up to a gauge transformation.

In the same spirit, let us now conclude the present section by a statement describing the case when two different sets of q -functions give rise to the same T -functions: in such a case, the two sets of q -functions have to obey the same difference equation (III.102), which means that they are obtained from each other by linear transformation. Going carefully through the construction given in the proof of the Statement 4 (page 116) we find the following statement, written for the lattice $\mathbb{S}(N)$ of the $SU(N) \times SU(N)$ principal chiral model.

Statement 7. *Let $T_{a,s}$ be a typical solution of the Hirota equation on $\mathbb{S}(N)$, and let $q_{\{1\}}, q_{\{2\}}, \dots, q_{\{N\}}, p_{\{1\}}, p_{\{2\}}, \dots, p_{\{N\}}$, and q_\emptyset and p_\emptyset be such that (III.97) holds, i.e. such that, in the notations (III.112-III.115), we have $T_{a,s} = q_{(a)}^{[+s]} \wedge p_{(N-a)}^{[-s]}$. Let $\tilde{q}_{\{1\}}, \tilde{q}_{\{2\}}, \dots, \tilde{q}_{\{N\}}, \tilde{p}_{\{1\}}, \tilde{p}_{\{2\}}, \dots, \tilde{p}_{\{N\}}$, and \tilde{q}_\emptyset and \tilde{p}_\emptyset be another set of q -functions such that (III.97) holds, i.e. such that in these notations $T_{a,s} = \tilde{q}_{(a)}^{[+s]} \wedge \tilde{p}_{(N-a)}^{[-s]}$.*

Then, there exists an \mathfrak{i} -periodic matrix $H(\mathbf{u}) \in SL(N)$, and two \mathfrak{i} -periodic functions $C(\mathbf{u})$ and $F(\mathbf{u})$ such that

$$\tilde{p}_{\{i\}} = F C^{N-2} H_i^j p_{\{j\}}, \quad \tilde{q}_{\{i\}} = F^{-1} C^{N-2} H_i^j q_{\{j\}}, \quad (\text{III.166})$$

$$\tilde{p}_\emptyset = F C^N p_\emptyset, \quad \tilde{q}_\emptyset = F^{-1} C^N q_\emptyset. \quad (\text{III.167})$$

The converse is also true: one can easily check that this transformation does indeed leave the T -functions invariant, and out of an arbitrary set of q -functions this transformation produces another set of q -functions giving rise to the same T -functions.

Here, the statement is written only for the lattice $\mathbb{S}(N)$ of the $SU(N) \times SU(N)$ principal chiral model, but the same statement¹⁷ can be written for an arbitrary \mathbb{T} -hook. Actually, even in the case of the \mathbb{T} -hook $\mathbb{T}(2, 2|2+2)$ of AdS/CFT, we will usually restrict to either the right band or the upper band, where the Statement 7 written above for $\mathbb{S}(N)$ will be sufficient.

III.2.4 Gauge conditions and Wronskian expressions of the T -functions

As we have seen in the previous sections, the expression of the T -functions in terms of q -functions is quite simple in the ‘‘Wronskian’’ gauges obeying the constraints (III.81). We also said that an arbitrary solution of the Hirota equation can be transformed into a solution which obeys these conditions, and this transformation will essentially fix three out of four degrees of gauge freedom.

This subsection will elaborate on the meaning of these statements at the level of q -functions.

¹⁷ In the case of an arbitrary \mathbb{T} -hook, a remarkable difference is that if we write a statement which generalizes the Statement 7, then H becomes a block-matrix, where several blocks of coefficients are forced to be zero.

Relaxing the gauge constraints Let us repeat below the constraints defining the Wronskian gauges for the lattice¹⁸ $\mathbb{T}(K, K'|M + M')$:

$$T_{0,s} = T_{0,0}^{[-s]} \quad (\text{III.168a})$$

$$T_{K'+n,-M'} = T_{K',-M'-n} \quad T_{K+n,M} = T_{K,M+n} \quad \text{for any } n \geq 0 \quad (\text{III.168b})$$

We can see that the Wronskian solution (III.143-III.145) of Hirota equation directly implies the condition (III.168b). Thus, this condition (III.168b) is necessary in order to write the Wronskian solution of Hirota equation. On the other hand, Wronskian expression (III.143-III.145) of the T -functions does not directly imply that $T_{0,s} = T_{0,0}^{[-s]}$. As a consequence, we see that although the condition (III.168a) is physically meaningful, it is not necessary in order to write the Wronskian expressions of T -functions.

For instance, for the lattice $w(N)$, we see that the condition (III.168a) is reflected in the Statement 5 (page 121) by the relation $q_{(0)} \equiv q_\emptyset = 1$. If we relax this gauge constraint, we obtain that the general solution of the Hirota equation on $w(K)$ such that

$$T_{a,0} = T_{0,-a} \quad \text{and} \quad T_{K,s} = T_{0,-K-s}$$

is given by

$$T_{a,s} = (-1)^{(K-1)(K-a)} q_{(a)}^{[+s]} \wedge q_{(K-a)}^{[-s-K]}, \quad (\text{III.169})$$

$$\text{where } q_{(1)} \equiv \sum_{i=1}^K q_{\{i\}} \xi_i, \quad \text{and } q_{(0)} \equiv q_\emptyset, \quad (\text{III.170})$$

$$\text{and } q_{(n)} \equiv \frac{q_{(1)}^{[-n+1]} \wedge q_{(1)}^{[-n+3]} \wedge q_{(1)}^{[-n+5]} \wedge \cdots \wedge q_{(1)}^{[n-1]}}{q_\emptyset^{[-n+2]} q_\emptyset^{[-n+4]} \cdots q_\emptyset^{[n-2]}} \quad \text{if } n > 1. \quad (\text{III.171})$$

At the level of these expressions, the only difference, compared to the case when the gauge constraint (III.168a) is enforced, is the presence of a denominator in (III.171).

Similarly, for the case of the \mathbb{T} -hook of Statement 6 (page 125), the same Wronskian solution holds if we do not impose the gauge condition (III.168a), but we only impose (III.168b). The only difference is that in this case, the condition (III.150) does not hold any more.

Gauge transformations and q -functions Let us now investigate the form of the gauge transformations $T_{a,s} \rightsquigarrow g_1^{[a+s]} g_2^{[a-s]} g_3^{[-a+s]} g_4^{[-a-s]} T_{a,s}$ preserving the gauge constraint (III.168b). First, in order to preserve the gauge constraint (III.168b), we require that the condition $\frac{T_{K+1,M}}{T_{K,M+1}} = 1$ still holds after the gauge transformation. This imposes

$$\frac{g_2^{[+K-M+1]}}{g_3^{[+M-K+1]}} \frac{g_3^{[+M-K-1]}}{g_2^{[+K-M-1]}} = 1.$$

¹⁸The other lattices $w(K)$ and $L(K, M)$ for which the Wronskian gauge was defined in section III.2.1 can be viewed as sublattices of $\mathbb{T}(K, K'|M + M')$.

Without loss of generality¹⁹, we can deduce that $g_2^{[+K-M]} = g_3^{[+M-K]}$. If we proceed the same way to require that the gauge condition $\frac{T_{K'+1,-M'}}{T_{K',-M'-1}} = 1$ is preserved by the gauge transformation, then we see that $g_1^{[+K'-M']} = g_4^{[-K'+M']}$.

Hence we see that the general gauge transformation preserving the gauge condition (III.168b) takes the form

$$T_{a,s} \rightsquigarrow g_1^{[+a+s]} g_2^{[+a-s]} g_2^{[-a+s-2M+2K]} g_1^{[-a-s+2K'-2M']} T_{a,s}. \quad (\text{III.172})$$

If we compare this with the expression (III.143-III.145) of the T -functions, we immediately see that this transformation corresponds exactly, at the level of q -functions, to

$$\forall I, \quad \mathcal{Q}_I \rightsquigarrow f_1^{[+k_I-m_I]} f_2^{[-k_I+m_I]} \mathcal{Q}_I \quad (\text{III.173})$$

$$\text{where } k_I = \text{Card}\{i \in I | (-1)^{p_i} = 1\} \quad \text{and} \quad m_I = \text{Card}\{i \in I | (-1)^{p_i} = -1\}, \quad (\text{III.174})$$

where we should set $f_1 = g_1^{[-\frac{K-K'-M+M'}{2}]}$ and $f_2 = g_1^{[-\frac{K-K'-M+M'}{2}]}$ in order to reproduce (III.172). One can show that this transformation (III.173) preserves the determinant expressions such as ((III.148)-(III.149)), because it also preserves the underlying qq-relation.

We see that if we only impose the gauge constraint (III.168b), then the remaining gauge freedom takes the form (III.173), expressed in terms of two independent functions f_1 and f_2 . Of course, if we also add the constraint (III.168a), then the functions f_1 and f_2 are not independent anymore, and we have $f_2 = 1/f_1$. We see that in this case, there is only one degree of gauge freedom left.

III.2.5 Writing FiNLIEs

These results about the typical solutions of the Y-system equation and of the Hirota equation allow to build FiNLIEs for several different models. This means that for several integrable models, where we know that the thermodynamic Bethe ansatz gives rise to the Y-system equation (III.54), we will derive a finite set of non-linear integral equations (FiNLIE).

Let us sketch the major steps of this procedure, which we will detail in section III.3 for the case of the SU(N) principal chiral model.

1. First, one has to find the Y-system equation or the TBA equations. Though the form (III.54) of the Y-system equation is quite universal, each integrable model is characterized by a different (a, s) -lattice and by a different asymptotic behavior at large u . This asymptotic behavior is an additional constraint, to be put “on top

¹⁹In principle, one can only conclude that $\alpha \equiv g_2^{[+K-M]} = g_3^{[+M-K]}$ is an i -periodic function. But then we can redefine the functions g_2 and g_3 as $g_2 \rightsquigarrow g_2 / \sqrt{\alpha^{[+M-K]}}$ and $g_3 \rightsquigarrow g_3 \sqrt{\alpha^{[-M+K]}}$. Due to the i -periodicity of α , this transformation leaves the product $g_1^{[a+s]} g_2^{[a-s]} g_3^{[-a+s]} g_4^{[-a-s]}$, which means that we describe the same gauge transformation, but in terms of “rescaled” gauge functions g_2 and g_3 which now obey $g_2^{[+K-M]} = g_3^{[+M-K]}$.

of” the Y-system equation (we will see that it corresponds to a “zero-mode” of the Y-system equation). It can either be read from the TBA equations, or “guessed” from the asymptotic limit (the limit when the size of the space is large).

2. Then one has to understand the “asymptotic limit”, which is the limit of an infinite size model. In this limit, one should find a solution of Hirota equation which gives rise to the correct asymptotic Bethe equations. This step is important, not only because it allows to reproduce the initial asymptotic Bethe equations (which were the starting point to write the thermodynamic Bethe ansatz), but rather because it also allows to understand the behavior of the Y-functions in this limit.
3. For an arbitrary finite size L , the thermodynamic Bethe ansatz gives rise to an infinite set of Y-functions, which obey the Y-system equation. These Y-functions can be written in terms of (an infinite set of) T -functions, which are themselves written in terms of (a finite set of) q -functions. Finding the solution of the Y-system equation therefore reduces to identifying these q -functions.

In order to write the T -functions, we would a priori have to know these q -functions on the whole complex plane. By contrast the TBA-equations only involve Y-functions on the real axis. Therefore we replace an infinite number of functions on the real axis by a finite number of functions on the complex plane. To make this interesting it will be necessary to find a convenient parameterization of these q -functions, and this will be done in two steps:

- A first step is to identify some domains in the complex plane (called analyticity strips), where the Y-functions (resp the T - and q -functions) are analytic. These analyticity strips are fixed by the TBA-equations (more precisely their zero-modes), or they can also be read from the large u asymptotic behavior, and sometimes from some additional symmetries of the Y-system.
- The next step is to show, from the existence of these analyticity strips, that a parameterization of the q -functions in terms of a finite number of functions on the real axis can be found.

This step will express the general solution of Hirota equation with given analyticity strips in terms of a finite number of functions on the real axis, but these functions are still to be fixed in the next steps.

4. Finally, one has to write non-trivial equations putting enough constraints on the q -functions, so that only one solution of the Y-system is kept. To do this, one should manage to write equations containing the zero-modes of the TBA-equations (or equivalently the large u asymptotic). Non-trivial analyticity constraints or symmetries of the model can also be necessary at this point. These equations will usually take the form of closed equations on (the functions parameterizing) the q -functions, which can for instance be solved numerically by a fix-point approach. These equations will be called a FinLIE (finite set of non-linear integral equations).

5. Last, but not least, we can express the energy associated to a given solution of the Y-system equation. This allows to answer the initial question of finding the finite-size spectrum of a given integrable model.

III.3 FiNLIE for the principal chiral model

Following the general procedure of the above section III.2.5, we will now see how to proceed explicitly and to write a FiNLIE in the case of the principal chiral model introduced in the section III.1. The number of the subsections will reflect the steps listed in section III.2.5.

III.3.1 Y-system equation

As it was already discussed, the finite size effects of the principal chiral model are encoded into an infinite set of Y-functions, which obey the Y-system equation (III.54). They obey the following, large u asymptotic behavior (see (III.53)):

$$\log(Y_{a,s}) + L \frac{\sin \frac{\pi a}{N}}{\sin \frac{\pi}{N}} \cosh\left(\frac{2\pi}{N}u\right) \delta_{s,0} \xrightarrow{u \rightarrow \infty} c_{a,s}, \quad (\text{III.175})$$

where $c_{a,s}$ is an arbitrary u -independent number. This condition can be read from (III.43), and we will see that it can be viewed as the insertion of a zero-mode of the Y-system equation (III.54).

We see that in this limit the Y-functions $Y_{a,s}$ are non-zero constants, except for $Y_{a,0}$ which is roughly equal to $e^{-L \frac{\sin \frac{\pi a}{N}}{\sin \frac{\pi}{N}} \cosh(\frac{2\pi}{N}u)} \ll 1$. The only place where the quantity L appears in the Y-system is via this asymptotic behavior, and it only changes the speed at which $Y_{a,0} \xrightarrow{u \rightarrow \infty} 0$. Therefore, we expect that the asymptotic behavior (III.175) is independent of L , (i.e. that the constants $c_{a,s}$ are independent of L), and that the limit $L \rightarrow \infty$ (where we also have $e^{-L \frac{\sin \frac{\pi a}{N}}{\sin \frac{\pi}{N}} \cosh(\frac{2\pi}{N}u)} \ll 1$) is essentially the same as the limit $u \rightarrow \infty$.

Hence, we also have

$$\log(Y_{a,s}) + L \frac{\sin \frac{\pi a}{N}}{\sin \frac{\pi}{N}} \cosh\left(\frac{2\pi}{N}u\right) \delta_{s,0} \xrightarrow{L \rightarrow \infty} c_{a,s}. \quad (\text{III.176})$$

III.3.2 Asymptotic limit

The asymptotic limit is the limit when L is very large. In that case, the equation (III.175) ensures that

$$\forall a \in \llbracket 1, N-1 \rrbracket, \quad Y_{a,0} \xrightarrow{L \rightarrow \infty} 0 \quad (\text{III.177})$$

If we really set $Y_{a,0} = 0$, then we get a quite peculiar solution of the Y-system equation (III.54) in the sense that when $s = 0$, the left-hand-side is zero and the denominator in

the right-hand-side is infinite. But since this Y-system equation is degenerate at $s = 0$, one can see that the two sets of functions $\{Y_{a,s} | s > 0\}$ and $\{Y_{a,s} | s < 0\}$ are completely independent (each of them has to obey independent Y-system equations). That means that if we really set $Y_{a,0} = 0$, we describe a quite degenerate, non-typical solution.

Therefore we will keep $Y_{a,0}$ small, but not exactly zero. We will show that then, there is a (typical) solution of the Y-system equation (III.54) which allows to recover the asymptotic Bethe ansatz of section III.1.1. We will first study the degenerate leading order (corresponding to $Y_{a,0} = 0$ for all $a \in \llbracket 1, N-1 \rrbracket$). We will then add exponentially small terms which will make this solution consistent and make Bethe equations arise.

III.3.2.1 Splitting $\mathbb{S}(\mathbb{N})$ into two half strips $\mathfrak{w}(\mathbb{N})$

In the approximation $Y_{a,0} = 0$ for all $a \in \llbracket 1, N-1 \rrbracket$, the general solution of the Y-system equation on the lattice $\mathbb{S}(\mathbb{N})$ (see figure III.2 (page 102)) is given by

$$Y_{a,s}(\mathbf{u}) = \begin{cases} Y_{a,s}^{(R)}(\mathbf{u}) & \text{if } s > 0 \\ 0 & \text{if } s = 0 \\ Y_{a,-s}^{(L)}(\mathbf{u}) & \text{if } s < 0 \end{cases}, \quad (\text{III.178})$$

where $Y_{a,s}^{(R)}$ and $Y_{a,s}^{(L)}$ are two arbitrary (independent) solutions of the Y-system equation on the lattice $\mathfrak{w}(\mathbb{N})$ of figure III.3(b) (page 107).

At the level of T -functions, we can define two sets $\{T_{a,s}^{(R)}\}$ and $\{T_{a,s}^{(L)}\}$ of T -functions which obey the Hirota equation on the lattice $\mathfrak{w}(\mathbb{N})$, such that

$$Y_{a,s}^{(R)} = \frac{T_{a,s+1}^{(R)} T_{a,s-1}^{(R)}}{T_{a+1,s}^{(R)} T_{a-1,s}^{(R)}}, \quad Y_{a,s}^{(L)} = \frac{T_{a,s+1}^{(L)} T_{a,s-1}^{(L)}}{T_{a+1,s}^{(L)} T_{a-1,s}^{(L)}}. \quad (\text{III.179})$$

To make this solution less degenerate, we will find gauge functions g_1, g_2, g_3 and g_4 and glue $T_{a,s}^{(R)}$ with $T_{a,s}^{(L)}$ as follows:

$$T_{a,s} = \begin{cases} T_{a,s}^{(R)} & \text{if } s \geq 0, \\ g_1^{[a+s]} g_2^{[a-s]} g_3^{[-a+s]} g_4^{[-a-s]} T_{a,-s}^{(L)} & \text{if } s \leq 0, \end{cases} \quad (\text{III.180a})$$

$$(\text{III.180b})$$

This is consistent if the two expressions coincide at $s = 0$, i.e. if

$$g_1^{[a]} g_2^{[a]} g_3^{[-a]} g_4^{[-a]} = \frac{T_{a,0}^{(R)}}{T_{a,0}^{(L)}} \quad (\text{III.181})$$

This equation always has a solution because $T_{a,0}^{(R)}$ and $T_{a,0}^{(L)}$ are of the form $f^{[+a]} \tilde{f}^{[-a]}$ (this can be seen from the relation $\frac{T_{a,0}^+ T_{a,0}^-}{T_{a-1,0} T_{a+1,0}} = 1 + Y_{a,0} \simeq 1$). The expression (III.180a) ensures that $T_{a,s}$ obeys the Hirota equation when $s > 0$, while (III.180b) ensures that $T_{a,s}$ obeys the Hirota equation when $s < 0$. To get an approximate solution of Hirota equation at $s = 0$, which obeys $Y_{a,0} \ll 1$, we will choose the gauge functions g_1, g_2, g_3 and g_4 such that $g_1^{[a-1]} g_2^{[a+1]} g_3^{[-a-1]} g_4^{[-a+1]} \ll 1$. This will ensure that

$$T_{a,-1} = g_1^{[a-1]} g_2^{[a+1]} g_3^{[-a-1]} g_4^{[-a+1]} T_{a,1}^{(L)} \ll 1 \quad (\text{III.182})$$

is exponentially small (typically like $e^{-L\cosh(\mathbf{u})}$). This will imply that at $s = 0$,

$$T_{a,0}^+ T_{a,0}^- = (T_{a,0}^{(R)})^+ (T_{a,0}^{(R)})^- = T_{a-1,0}^{(R)} T_{a+1,0}^{(R)} \quad (\text{III.183})$$

$$\simeq T_{a-1,0}^{(R)} T_{a+1,0}^{(R)} + T_{a,-1} T_{a,1}^{(R)} = T_{a-1,s} T_{a+1,s} + T_{a,-1} T_{a,+1}, \quad (\text{III.184})$$

which means that the Hirota equation is satisfied (to the leading order) at $s = 0$.

At the level of Y-functions, the prescription (III.180) implies that (III.178) should be replaced with

$$Y_{a,s}(\mathbf{u}) = \begin{cases} Y_{a,s}^{(R)}(\mathbf{u}) & \text{if } s > 0 \\ \frac{T_{a,1}^{(R)}}{T_{a-1,0}^{(R)} T_{a+1,0}^{(R)}} g_1^{[a-1]} g_2^{[a+1]} g_3^{[-a-1]} g_4^{[-a+1]} T_{a,1}^{(L)} \ll 1 & \text{if } s = 0 \\ Y_{a,-s}^{(L)}(\mathbf{u}) & \text{if } s < 0 \end{cases}, \quad (\text{III.185})$$

which is a solution of the Y-system equation to the leading order.

III.3.2.2 Explicit expression of the T -functions

In the asymptotic limit, we have already seen that the Bethe equation (III.17) (from the asymptotic Bethe ansatz) was the same as the Bethe equation for a spin chain with inhomogeneities θ_i (which are the rapidities of the massive particles).

At the level of T -functions, that means that the T -functions $T_{a,s}^{(R)}$ and $T_{a,s}^{(L)}$, (which obey the Hirota equation on $\mathfrak{w}(\mathbb{N}) \simeq \mathbb{L}(\mathbb{N}, 0)$), correspond to two $\text{SU}(\mathbb{N})$ spin chains. These T -functions can then be expressed for instance from the Wronskian expression (II.259, II.262) derived in the chapter II for spin chains.

After the change of variables (III.58) these T -functions can be expressed in terms of a set of q -functions, as in (III.121):

$$T_{a,s}^{(R)} = (-1)^{(N-1)(N-a)} q_{(a)}^{(R)} \left(\mathbf{u} + i \frac{s}{2} \right) \wedge q_{(N-a)}^{(R)} \left(\mathbf{u} - i \frac{s+N}{2} \right) \quad (\text{III.186})$$

$$T_{a,s}^{(L)} = (-1)^{(N-1)(N-a)} q_{(a)}^{(L)} \left(\mathbf{u} + i \frac{s}{2} \right) \wedge q_{(N-a)}^{(L)} \left(\mathbf{u} - i \frac{s+N}{2} \right) \quad (\text{III.187})$$

$$\text{where } q_{(1)}^{(R/L)} \equiv \sum_{i=1}^N q_{\{i\}}^{(R/L)} \xi_i, \quad \text{and } q_{(0)}^{(R/L)} \equiv 1, \quad (\text{III.188})$$

$$\text{and } q_{(n)}^{(R/L)} \equiv q_{(1)}^{(R/L) [-n+1]} \wedge q_{(1)}^{(R/L) [-n+3]} \wedge \dots \wedge q_{(1)}^{(R/L) [+n-1]}, \quad \text{for } n > 1. \quad (\text{III.189})$$

This form for the T -functions arises from a typical solution of the Hirota equation (due to Statement 5 (page 121)), where the Hirota equation itself comes from the Y-system equation. On the other hand, we know that if the q -functions are polynomial, this solution corresponds to the transfer matrices of spin chains, defined in the chapter II, up to the change of variable (III.142). Moreover, if these q -functions are polynomial, their zeroes obey the Bethe equations (II.202-II.204), which are identical to (III.17) up to the change of variables (III.12-III.15).

This motivates the identification of q -functions, in the asymptotic limit, as

$$q_{\{1,2,\dots,N-m\}}^{(R)} = Q_{[m]}(\mathbf{u} + i\frac{N}{4}) \quad q_{\{1,2,\dots,N-m\}}^{(L)} = Q_{[-m]}^{(L)}(\mathbf{u} + i\frac{N}{4}), \quad \text{when } L \rightarrow \infty \quad (\text{III.190})$$

This identifications says that in the asymptotic limit ($L \rightarrow \infty$), the Y-functions (which are ratios of the densities of holes and particles in the mirror model) are simply obtained as the ratios of the polynomial T -functions constructed in chapter II as the eigenvalues of the T-operators.

In other words, the zeroes of the q -functions are identified with the rapidities of the “particles” (the excitations) described in section III.1.1, and this identification is motivated by noticing that the zeroes of the q -functions obey the right Bethe equations (III.17). In the upcoming subsection III.3.2.4, we will further motivate the identification (III.190), by showing that it also gives rise to the Bethe equation (III.18).

In terms of the Hasse diagram (see figure II.6 (page 54)), the identification (III.190) tells us the asymptotic limit of the q -functions along a given nesting path. Using the qq-relation (III.120), this allows to deduce the other q -functions.

III.3.2.3 Middle nodes equation

In this subsection, we will find some relations which describe in more details how the two solutions $T_{a,s}^{(R)}$ and $T_{a,s}^{(L)}$ can be glued together, and which will allow to recover the Bethe equation (III.18) in the next subsection. To this end, we will write a “middle nodes equation”, which holds not only in the asymptotic limit, but is also at any finite size.

One should be aware that the results which will be found in the present section do not only hold in the asymptotic limit ($L \rightarrow \infty$), but also for an arbitrary finite size L .

In the asymptotic limit, we wish how the T -functions $T_{a,s}^{(R)}$ and $T_{a,s}^{(L)}$ are glued together, by investigating the Y-system at $s = 0$. In view of the description (III.180) of this gluing procedure, we will usually denote $T_{a,s} = T_{a,s}^{(R)}$ (especially if $s \geq 1$), whereas $T_{a,s}^{(L)}$ denotes a different gauge (which is suitable when $s \leq 0$).

When the size L is finite, we will also use two different gauges $T_{a,s}^{(R)}$ and $T_{a,s}^{(L)}$, and we will usually write $T_{a,s} = T_{a,s}^{(R)}$. We will see in the next sections how these gauges arise at finite size L . The reason why they are interesting is that since the Y-functions are gauge-invariant, they can be expressed arbitrarily in terms of either $T_{a,s}^{(R)}$ or $T_{a,s}^{(L)}$.

Let us write the Y-system equation at $s = 0$, in the form (III.64) (which takes into account the boundary condition $Y_{0,s} = \infty = Y_{N,s}$). If we express each Y-function as a ratio of T -functions, we get

$$\frac{Y_{a,0}^+ Y_{a,0}^-}{(Y_{a+1,0})^{1-\delta_{a,N-1}} (Y_{a-1,0})^{1-\delta_{a,1}}} = \frac{1 + Y_{a,1}}{(1 + Y_{a+1,0})^{1-\delta_{a,N-1}}} \frac{1 + Y_{a,-1}}{(1 + Y_{a-1,0})^{1-\delta_{a,1}}} \quad (\text{III.191a})$$

$$= \frac{\frac{T_{a,1}^+ T_{a,1}^-}{T_{a+1,1} T_{a-1,1}}}{\left(\frac{T_{a+1,0}^+ T_{a+1,0}^-}{T_{a+2,0} T_{a,0}}\right)^{1-\delta_{a,N-1}}} \frac{\frac{T_{a,1}^{(L)}(u+i/2) T_{a,1}^{(L)}(u-i/2)}{T_{a+1,1}^{(L)} T_{a-1,1}^{(L)}}}{\left(\frac{T_{a-1,0}^+ T_{a-1,0}^-}{T_{a,0} T_{a-2,0}}\right)^{1-\delta_{a,1}}}. \quad (\text{III.191b})$$

where $T_{a,s}$ denotes here $T_{a,s}^{(R)}$. We have replaced each factor $1 + Y_{a,s}$ by a ratio of T -functions in a given gauge (usually chosen as $T_{a,s}^{(R)}$ except for $1 + Y_{a,-1}$ which is expressed through $T_{a,s}^{(L)}$).

The equation (III.191) has to be written for all $a \in \llbracket 1, N-1 \rrbracket$. Then the left-hand-side is $\frac{Y_{1,0}^+ Y_{1,0}^-}{Y_{2,0}}$ (resp $\frac{Y_{2,0}^+ Y_{2,0}^-}{Y_{3,0} Y_{1,0}}$, resp \dots) when $a = 1$ (resp $a = 2$, resp \dots). Hence its logarithm is

$$\begin{pmatrix} \log \frac{Y_{1,0}^+ Y_{1,0}^-}{Y_{2,0}} \\ \log \frac{Y_{2,0}^+ Y_{2,0}^-}{Y_{3,0} Y_{1,0}} \\ \vdots \\ \log \frac{Y_{N-2,0}^+ Y_{N-2,0}^-}{Y_{N-1,0} Y_{N-3,0}} \\ \log \frac{Y_{N-1,0}^+ Y_{N-1,0}^-}{Y_{N-2,0}} \end{pmatrix} = \begin{pmatrix} e^{\frac{i}{2}\partial_u} + e^{-\frac{i}{2}\partial_u} & -1 & & & \\ & -1 & & \ddots & \\ & & & \ddots & \\ & & & & -1 \\ & & & -1 & e^{\frac{i}{2}\partial_u} + e^{-\frac{i}{2}\partial_u} \end{pmatrix} \cdot \begin{pmatrix} \log(Y_{1,0}) \\ \log(Y_{2,0}) \\ \vdots \\ \log(Y_{N-2,0}) \\ \log(Y_{N-1,0}) \end{pmatrix},$$

This left-hand-side of equation (III.191) will then be denoted as $Y_{a,0}^{\cdot M}$ which is a short notation for $\exp(M \cdot \log Y_{a,0})$, where M is the matrix defined in equation (III.90). Using this notation the equation (III.191) reads

$$Y_{a,0}^{\cdot M} = \left(\frac{T_{a,1} T_{a,1}^{(L)}}{T_{a-1,0} T_{a+1,0}} \right)^{\cdot M} \times \left(\frac{T_{N,0}^+ T_{N,0}^-}{T_{N,1} T_{N,1}^{(L)}} \right)^{\delta_{a,N-1}} \left(\frac{T_{0,0}^+ T_{0,0}^-}{T_{0,1} T_{0,1}^{(L)}} \right)^{\delta_{a,1}}, \quad (\text{III.192})$$

where the last factors have to be added to get the correct expression at $a = 1$ and at $a = N - 1$.

From this point, it would be natural to multiply by M^{-1} and to deduce $Y_{a,0}$. One actually has to do something slightly less direct, because M^{-1} is not completely well defined. Indeed we saw in section III.2.2 that to invert M , one has to solve an equation of the form $[N]_D x = f$ (see (III.94)), and the solution to this equation is not unique. One possible way to invert M is by introducing a matrix \tilde{M} with coefficients $\tilde{m}_{i,j}$ defined by

$$\tilde{m}_{i,j} = \begin{cases} [j]_D [N-i]_D & \text{if } i > j \\ [i]_D [N-j]_D & \text{if } i \leq j \end{cases} \quad (\text{III.193})$$

$$\text{where } [i]_D \equiv D^{1-i} + D^{3-i} + \dots + D^{i-1} = \sum_{s=-\frac{i-1}{2}}^{\frac{i-1}{2}} D^{2s}, \quad \text{where } D = e^{\frac{i}{2}\partial_u}. \quad (\text{III.194})$$

One can easily check (for instance with Mathematica), that this matrix \tilde{M} is the adjugate matrix (or co-matrix)²⁰ of M , and it obeys

$$\tilde{M} \cdot M = [N]_D \mathbb{I} \quad (\text{III.195})$$

²⁰Here, we call adjugate matrix of M the transpose of the matrix whose elements are the co-factors (i.e. the minors) of M .

where \mathbb{I} denotes the identity matrix of size $(N-1) \times (N-1)$. This equation (III.195) means that

$$\left((f_a)^{\cdot M} \right)^{\cdot \tilde{M}} = f_a^{[N]_D}, \quad (\text{III.196})$$

$$\text{where } f_a^{[N]_D} \equiv \exp([N]_D \log f_a) = \prod_{k=-\frac{N-1}{2}}^{\frac{N-1}{2}} f_a^{[+2k]}. \quad (\text{III.197})$$

With these notations, the equation (III.192) becomes

$$Y_{a,0}^{[N]_D} = \left(\frac{T_{a,1} T_{a,1}^{(L)}}{T_{a-1,0} T_{a+1,0}} \right)^{[N]_D} \left(\frac{T_{N,0}^+ T_{N,0}^-}{T_{N,1} T_{N,1}^{(L)}} \right)^{\tilde{m}_{a,N-1}} \left(\frac{T_{0,0}^+ T_{0,0}^-}{T_{0,1} T_{0,1}^{(L)}} \right)^{\tilde{m}_{a,1}} \quad (\text{III.198a})$$

$$= \left(\frac{T_{a,1} T_{a,1}^{(L)}}{T_{a-1,0} T_{a+1,0}} \right)^{[N]_D} \left(\frac{T_{N,0}^+ T_{N,0}^-}{T_{N,1} T_{N,1}^{(L)}} \right)^{[a]_D} \left(\frac{T_{0,0}^+ T_{0,0}^-}{T_{0,1} T_{0,1}^{(L)}} \right)^{[N-a]_D}. \quad (\text{III.198b})$$

In order to obtain $Y_{a,0}^{[N]_D}$, we have to invert the transformation $f \mapsto f^{[N]_D}$. By doing a Fourier transform, we see that the kernel K_N with Fourier transform

$$\widetilde{K}_N(\omega) = \frac{1}{\sum_{j=-\frac{N-1}{2}}^{\frac{N-1}{2}} e^{2i\pi j\omega}} \quad (\text{III.199})$$

obeys the equation

$$(f^{*K_N})^{[N]_D} = f, \quad \text{where } f^{*K_N} \equiv \exp(K_N * \log f_a). \quad (\text{III.200})$$

After inverse Fourier transform from (III.199), we obtain the following explicit expression of the kernel K_N :

$$K_N(\mathbf{u}) = \frac{\tan\left(\frac{1}{2}\pi\left(\frac{1}{N} - \frac{2i\mathbf{u}}{N}\right)\right) + \tan\left(\frac{1}{2}\pi\left(\frac{1}{N} + \frac{2i\mathbf{u}}{N}\right)\right)}{2N}. \quad (\text{III.201})$$

Let us note at this point that the property (III.200) means that a particular solution of the equation $f^{[N]_D} = g$ is given by $f = g^{*K_N}$. This solution is not unique, and the general solution of this equation is $f = g^{*K_N} z$, where z obeys $z^{[N]_D} = 1$. Such a function z is called a ‘‘zero-mode’’.

If we did not take the zero-modes into account, we could naively expect (from (III.198)) that

$$Y_{a,0} = \left(\frac{T_{a,1} T_{a,1}^{(L)}}{T_{a-1,0} T_{a+1,0}} \right) \left(\left(\frac{T_{N,0}^+ T_{N,0}^-}{T_{N,1} T_{N,1}^{(L)}} \right)^{[a]_D} \left(\frac{T_{0,0}^+ T_{0,0}^-}{T_{0,1} T_{0,1}^{(L)}} \right)^{[N-a]_D} \right)^{*K_N}.$$

With this expression, we would actually obtain an incorrect behavior at large \mathbf{u} , in the sense that $\log(Y_{a,0})$ would have a finite limit at $\mathbf{u} \rightarrow \infty$. In order to reproduce (III.175),

we should therefore add an extra factor (zero-mode) and write

$$Y_{a,0} \simeq e^{-E_a} \left(\frac{T_{a,1} T_{a,1}^{(L)}}{T_{a-1,0} T_{a+1,0}} \right) \left(\left(\frac{T_{N,0}^+ T_{N,0}^-}{T_{N,1} T_{N,1}^{(L)}} \right)^{[a]_D} \left(\frac{T_{0,0}^+ T_{0,0}^-}{T_{0,1} T_{0,1}^{(L)}} \right)^{[N-a]_D} \right)^{*K_N}, \quad (\text{III.202})$$

$$\text{where } E_a \equiv L \frac{\sin \frac{\pi a}{N}}{\sin \frac{\pi}{N}} \cosh \left(\frac{2\pi}{N} \mathbf{u} \right), \quad (\text{III.203})$$

$$\text{and } f_1 \simeq f_2 \quad \text{denotes} \quad (f_1)^{[N]_D} = (f_2)^{[N]_D}. \quad (\text{III.204})$$

Here the symbol \simeq is used to denote an equality which holds up to a zero-mode of $[N]_D$, (i.e. $f_1 \simeq f_2$ means that $f_1 = z f_2$ where z obeys $z^{[N]_D} = 1$). In (III.202), this zero-mode has to converge to a constant when $\mathbf{u} \rightarrow \infty$, and since it is iN -periodic (because $\frac{z^{[+N]}}{z^{[-N]}} = \frac{(z^{[N]_D})^+}{(z^{[N]_D})^-} = 1$), the Liouville theorem states that it is characterized by its pole structure in the strip \mathbf{A}_N . For instance it can contain χ_{CDD} factors (defined in (III.7)). We will see in the next section how to fix this zero-mode.

This equation (III.202) will be called the ‘‘middle nodes equation’’, and it will be very useful because it encodes the large \mathbf{u} asymptotic behavior (III.175) into an equation on the T -functions.

III.3.2.4 Bethe equations

Let us now see how this ‘‘middle nodes equation’’ can be used to understand better the large L limit of the Y -system, and to obtain the Bethe equations (III.17) and (III.18). To this end, we will use the expressions (III.186-III.190) of the functions $T_{a,s}^{(R)}$ and $T_{a,s}^{(L)}$.

A first remark is that these expressions correspond to polynomial spin chains (as in chapter II) and therefore they have to obey the equation (III.17).

Next, let us express the T -functions on the right-hand-side of the ‘‘middle node equation’’ (III.202). First, we obtain (from (III.186-III.190))

$$T_{0,s}^{(R)} = q_{(N)}^{(R)} \left(\mathbf{u} - i \frac{s+N}{2} \right) = \varphi^{[-s-N/2]}, \quad T_{0,s}^{(L)} = \varphi^{[-s-N/2]}, \quad (\text{III.205})$$

$$T_{N,s}^{(R)} = q_{(N)}^{(R)} \left(\mathbf{u} + i \frac{s}{2} \right) = \varphi^{[+s+N/2]}, \quad T_{N,s}^{(L)} = \varphi^{[+s+N/2]}, \quad (\text{III.206})$$

$$T_{a,0}^{(R)} = q_{(N)}^{(R)} \left(\mathbf{u} + i \frac{a-N}{2} \right) = \varphi^{[+a-N/2]}, \quad T_{a,0}^{(L)} = \varphi^{[+a-N/2]}, \quad (\text{III.207})$$

which (unlike the equations of the previous section) are only valid in the $L \rightarrow \infty$ limit. In these expressions, φ denotes the polynomial $Q_{[0]}(\mathbf{u})$.

We will show in the next section that these expressions only hold inside specific strips of the complex plane. These strips will be such that for instance, the function $1 + Y_{1,0} = \frac{T_{1,0}^+ T_{1,0}^-}{T_{2,0} T_{0,0}}$ will actually²¹ have a zero at every $\mathbf{u} = \theta_j + i \frac{N}{4}$, where θ_j denotes an

²¹As we will see, this zero arises because the numerator has a zero due to (III.207), whereas the denominator lies in a domain of the complex plane where (III.205) does not hold, hence the denominator does not have a zero at the same position.

arbitrary root of $\varphi = Q_{[0]}(\mathbf{u})$. For the moment, let us just show that if $1 + Y_{1,0} = \frac{T_{1,0}^+ T_{1,0}^-}{T_{2,0} T_{0,0}}$ has a zero at $\mathbf{u} = \theta_j + i\frac{N}{4}$, then we recover the Bethe equation (III.17).

To this end, let us see what comes out if the expressions (III.205-III.207) are plugged into (III.202). First the factor $\left(\left(\frac{T_{0,0}^+ T_{0,0}^-}{T_{0,1} T_{0,1}^{(L)}} \right)^{[N-a]_D} \right)^{*K_N}$ becomes²²

$$\left(\left(\frac{T_{0,0}^+ T_{0,0}^-}{T_{0,1} T_{0,1}^{(L)}} \right)^{[N-a]_D} \right)^{*K_N} \simeq \left(\left(\frac{\varphi^{[1-N/2]}}{\varphi^{[-1-N/2]}} \right)^{*K_N} \right)^{[N-a]_D} \simeq \left((-1)^{\frac{d^{(0)}}{N}} \frac{\mathbf{S}^{[+N/2]} \varphi^{[+N/2]}}{\varphi^{[+N/2-2]}} \right)^{[N-a]_D}, \quad (\text{III.208})$$

$$\text{where } \mathbf{S}(\mathbf{u}) = \prod_{n=1}^{d^{(0)}} S_0(\mathbf{u} - \theta_n). \quad (\text{III.209})$$

Here \mathbf{S} is the product of $\prod S_0(\mathbf{u} - \theta_n)$, which runs over all the roots θ_n of φ , and the symbol \simeq stresses that the equality holds only up to a zero-mode of $[N]_D$. This equality is obtained from the crossing relation (III.10), which gives $\left(\frac{\mathbf{S}^{[+N/2]} \varphi^{[+N/2]}}{\varphi^{[+N/2-2]}} \right)^{[N]_D} = \frac{\varphi^{[1-N/2]}}{\varphi^{[-1-N/2]}}$. The expression (III.208) can still be ‘‘simplified’’ a little, as:

$$\left(\left(\frac{T_{0,0}^+ T_{0,0}^-}{T_{0,1} T_{0,1}^{(L)}} \right)^{[N-a]_D} \right)^{*K_N} \simeq - \frac{\varphi^{[3N/2-a-1]}}{\varphi^{[-N/2+a-1]}} \left((-1)^{\frac{d^{(0)}}{N}} \mathbf{S}^{[+N/2]} \right)^{[N-a]_D} \quad (\text{III.210})$$

$$\simeq - \frac{\varphi^{[3N/2-a-1]} \varphi^{[-N/2-a+1]}}{\varphi^{[-N/2+a-1]} \varphi^{[3N/2-a-1]}} \left(\frac{(-1)^{\frac{d^{(0)}}{N}}}{\mathbf{S}^{[-N/2]}} \right)^{[a]_D}. \quad (\text{III.211})$$

Performing the same computation for the factor $\left(\left(\frac{T_{N,0}^+ T_{N,0}^-}{T_{N,1} T_{N,1}^{(L)}} \right)^{[a]_D} \right)^{*K_N}$, one obtains:

$$Y_{a,0} \simeq e^{-E_a} \left(\frac{T_{a,1} T_{a,1}^{(L)}}{T_{a-1,0} T_{a+1,0}} \right) \frac{\varphi^{[-N/2-a+1]} \varphi^{[-N/2-a+1]}}{\varphi^{[-N/2+a-1]} \varphi^{[-N/2+a+1]}} \left(\frac{1}{(\mathbf{S}^{[-N/2]})^2} \right)^{[a]_D}. \quad (\text{III.212})$$

Pole structure of $Y_{a,0}$ The zero-mode in this expression can be found by investigating the pole structure of $Y_{a,0}$: due to the expression $1 + Y_{a,0} = \frac{T_{a,0}^+ T_{a,0}^-}{T_{a+1,0} T_{a-1,0}}$, we see that $1 + Y_{a,0}$ has no pole except maybe when $T_{a+1,0} T_{a-1,0}$ cancels, i.e. at positions $\theta_j + i/2(-a \pm 1 + N/2)$. Actually, both the numerator and the denominator have zeroes at a position which tends to $\theta_j + i/2(-a \pm 1 + N/2)$ when $L \rightarrow \infty$. But if they do not coincide exactly, then they give rise to a pole of $1 + Y_{a,0}$ (and of $Y_{a,0}$ as well). Therefore we see that at most, $Y_{a,0}$ has simple poles at positions $\theta_j + i/2(-a \pm 1 + N/2)$.

²²Let us remind here that where $T_{a,s}$ is written (as opposed to $T_{a,s}^{(L)}$), it implicitly denotes $T_{a,s}^{(R)}$ which is expressed from (III.205-III.205).

This allows to find the correct zero-mode in (III.212). Explicitly, we obtain

$$Y_{a,0} = e^{-E_a} \left(\frac{T_{a,1} T_{a,1}^{(L)}}{T_{a-1,0} T_{a+1,0}} \right) \frac{\varphi^{[-N/2-a+1]} \varphi^{[-N/2-a+1]}}{\varphi^{[-N/2+a-1]} \varphi^{[-N/2+a+1]}} \left(\frac{1}{(\mathbf{S}^2 \chi_{\text{CDD}})^{[-N/2]}} \right)^{[a]_D}, \quad (\text{III.213})$$

$$\text{where } \chi_{\text{CDD}}(\mathbf{u}) = \prod_n \chi_{\text{CDD}}(\mathbf{u} - \theta_n), \quad (\text{III.214})$$

where we see that in the denominator, the product $T_{a-1,0} T_{a+1,0} \varphi^{[-N/2+a-1]} \varphi^{[-N/2+a+1]}$ has double zeroes at positions $\theta_j + \mathbf{i}/2 (-a \pm 1 + N/2)$. Due to the presence of the factor χ_{CDD} , the product $\mathbf{S}^2 \chi_{\text{CDD}}$ has simple poles at positions $\theta_j \pm \mathbf{i}$, hence $\left(\frac{1}{(\mathbf{S}^2 \chi_{\text{CDD}})^{[-N/2]}} \right)^{[a]_D}$ has simple zeroes at the positions $\theta_j + \mathbf{i}/2 (-a \pm 1 + N/2)$. Thus we see that the presence of the factor χ_{CDD} is necessary for the consistency of the pole structure of $Y_{a,0}$.

It is unfortunately not straightforward to show that there cannot be any other zero-mode in the expression (III.213) of the function $Y_{a,0}$. In order to exclude the possibility of other zero-modes, one actually has to require (in addition to the pole structure described above) a minimality of the number of zeroes of $Y_{a,0}$.

While the condition that $Y_{a,0}$ has simple poles at positions $\theta_j + \mathbf{i}/2 (-a \pm 1 + N/2)$ is a clear consequence of our analyticity conditions namely the behavior of the T -functions at $L \rightarrow \infty$, the minimality of the number of zeroes of $Y_{a,0}$ is (by contrast) rather a naturality condition, which can be viewed as an additional analyticity condition on our solution of the Y-system.

Bethe equation As indicated above, we will now show how to recover the Bethe equations under the assumption that $1 + Y_{1,0}$ has zeroes at positions $\mathbf{u} = \theta_j + \mathbf{i}\frac{N}{4}$. Therefore, we would like to express the T -functions²³ of the ratio $\left(\frac{T_{a,1} T_{a,1}^{(L)}}{T_{a-1,0} T_{a+1,0}} \right)$ which remains on the right-hand-side of (III.213). To do this, we can use the relation (II.193) which gives (after the changes of variables (III.58) and (III.12-III.15))

$$T_{1,1}^{(R)} \left(\mathbf{u} + \mathbf{i}\frac{N}{4} \right) = T^{1,1}(-\mathbf{i}\mathbf{u}) = \varphi(\mathbf{u}) \sum_{\mathbf{m}=0}^{N+1} \frac{Q_{[\mathbf{m}]}(\mathbf{u} + \mathbf{i} + \mathbf{i}\frac{\mathbf{m}}{2})}{Q_{[\mathbf{m}]}(\mathbf{u} + \mathbf{i}\frac{\mathbf{m}}{2})} \frac{Q_{[\mathbf{m}+1]}(\mathbf{u} - \mathbf{i} + \mathbf{i}\frac{\mathbf{m}+1}{2})}{Q_{[\mathbf{m}+1]}(\mathbf{u} + \mathbf{i}\frac{\mathbf{m}+1}{2})}. \quad (\text{III.215})$$

Therefore we see that in $T_{1,1}^{(R)}(\theta_n + \mathbf{i}\frac{N}{4})$, the factor $\varphi(\theta_n)$ in front of the sum vanishes. Therefore, only the term $\mathbf{m} = 0$ survives, because the denominator also contains $\varphi(\mathbf{u}) \equiv Q_{[0]}(\mathbf{u})$. Hence, we get

$$T_{1,1}^{(R)} \left(\theta_n + \mathbf{i}\frac{N}{4} \right) = \frac{\varphi(\theta_n + \mathbf{i}) Q_{[+1]}(\theta_n - \frac{\mathbf{i}}{2})}{Q_{[+1]}(\theta_n - \frac{\mathbf{i}}{2})}, \quad (\text{III.216})$$

$$T_{1,1}^{(L)} \left(\theta_n + \mathbf{i}\frac{N}{4} \right) = \frac{\varphi(\theta_n + \mathbf{i}) Q_{[-1]}(\theta_n - \frac{\mathbf{i}}{2})}{Q_{[-1]}(\theta_n - \frac{\mathbf{i}}{2})}. \quad (\text{III.217})$$

²³Let us remind here that where $T_{a,s}$ is written (as opposed to $T_{a,s}^{(L)}$), it implicitly denotes $T_{a,s}^{(R)}$.

Inserting this expression into (III.213), the equation $Y_{1,0}(\theta_n + i\frac{N}{4}) = -1$ gives the Bethe equation (III.18)

$$\boxed{-1 = e^{-iL p_1} \frac{Q_{[1]}(\mathbf{u} - i/2) Q_{[-1]}(\mathbf{u} - i/2)}{Q_{[1]}(\mathbf{u} + i/2) Q_{[-1]}(\mathbf{u} + i/2)} \frac{1}{(\mathcal{S}^2 \chi_{\text{CDD}})} \Big|_{\mathbf{u}=\theta_n}}, \quad (\text{III.218})$$

$$\text{where } L p_a \equiv L \frac{\sin \frac{\pi a}{N}}{\sin \frac{\pi}{N}} \sinh \left(\frac{2\pi}{N} \mathbf{u} \right) = -i E_a(\mathbf{u} + i\frac{N}{4}). \quad (\text{III.219})$$

This showed that the Bethe equation arises naturally from the Y-system, if the T -functions take polynomial values corresponding to two different $\text{SU}(N)$ chains. This motivates the identification (III.190) which says that in the asymptotic limit, the Y-functions (which are ratios of the densities of holes and particles in the mirror model) are the ratios of the polynomial T -functions constructed in chapter I.1 for spin chains.

These expressions will be a starting point to understand the properties of T -functions when the size L is finite. We will also see that the analysis of the next sections will explain the fact that $Y_{1,0}(\theta_n + i\frac{N}{4}) = -1$, which was assumed in the above argument.

III.3.3 Parameterization of the q -functions

As explained in section III.2.5, an important step which we now have to perform in order to obtain a FiNLIE is to parameterize the q -functions in a way which encodes their analyticity properties. To do this, we will first investigate the analyticity properties of the T - and Y-functions. Then, we will deduce the analyticity properties of the q -functions, and we will encode these properties into a convenient parameterization of these q -functions.

III.3.3.1 Analyticity strips for the Y-functions

One can see from (III.176) that the limit of the Y-functions when $L \rightarrow \infty$ is not analytic in the whole complex, and hence the T -functions (and the q -functions) which are the building blocks of the Y-functions cannot be analytic on the whole complex plane. Indeed, we have

$$\text{if } |\text{Im}(\mathbf{u})| < \frac{N}{4}, \quad Y_{a,0} \xrightarrow{L \rightarrow \infty} 0, \quad (\text{III.220})$$

$$\text{if } |\text{Im}(\mathbf{u})| \in \left] \frac{N}{4}, 3\frac{N}{4} \right[, \quad |Y_{a,0}| \xrightarrow{L \rightarrow \infty} \infty, \quad (\text{III.221})$$

because $Y_{a,0} \sim e^{L \frac{\sin \frac{\pi a}{N}}{\sin \frac{\pi}{N}} \cosh(\frac{2\pi}{N} \mathbf{u})}$.

Therefore we will call ‘‘analyticity strip’’ of $Y_{a,0}$ the domain $\mathbf{A}_{N/2}$ defined by

$$\mathbf{A}_n \equiv \left\{ z \in \mathbb{C} \mid |\text{Im}(z)| < \frac{n}{2} \right\}. \quad (\text{III.222})$$

The correct statement defining this strip is that $Y_{a,0}$ is meromorphic on $\mathbf{A}_{N/2}$ and its limit at $L \rightarrow \infty$ is well defined and meromorphic on $\mathbf{A}_{N/2}$.

We will denote this statement as $Y_{a,0} \in \mathcal{A}_{N/2}^m$, where \mathcal{A}_n^m denotes the set of meromorphic functions which have a meromorphic limit on \mathbf{A}_n when $L \rightarrow \infty$.

For $s \neq 0$, let us show that

$$Y_{a,s} \in \mathcal{A}_{|s|+N/2}^m. \quad (\text{III.223})$$

That means that on this domain $Y_{a,s}$ tends to the asymptotic solution of section III.3.2 when $L \rightarrow \infty$.

First, we see that the Y-functions obtained from the TBA-equations are analytic on the real axis, as it can be read from (III.43) (or (III.45) in terms of Y-functions). Moreover, we have seen that the TBA-equations imply the Y-system equation, which can be rewritten as

$$Y_{a,s} \simeq e^{-\delta_{s,0} E_a} \left(\frac{1 + Y_{a,s+1}}{1 + 1/Y_{a+1,s}} \frac{1 + Y_{a,s-1}}{1 + 1/Y_{a-1,s}} \right)^{*K_2}, \quad (\text{III.224})$$

$$\text{where } E_a \equiv L \frac{\sin \frac{\pi a}{N}}{\sin \frac{\pi}{N}} \cosh \left(\frac{2\pi}{N} \mathbf{u} \right) \quad \text{and } f^{*K_N} \equiv \exp(K_N * \log f_a). \quad (\text{III.225})$$

In principle, this expression contains a zero-mode z (denoted by the symbol \simeq) such that $z^+ z^- = 1$. This zero-mode is $2i$ -periodic (because $\frac{z^{[+2]}}{z^{[-2]}} = \frac{z z^{[+2]}}{z^{[-2]} z} = 1$) and bounded at infinity. Therefore the Liouville theorem shows that it is completely characterized by its singularities inside \mathbf{A}_2 (which can be deduced from its zeroes and its singularities in \mathbf{A}_1 if we use the relation $z^+ z^- = 1$). In our construction we assume the poles structure of all Y-functions smoothly converges to their asymptotic pole structure, and therefore we can expect that this zero-mode is a meromorphic function with a smooth limit when $L \rightarrow \infty$, hence this zero-mode will be assumed to preserve the analyticity strips.

We will show iteratively, by using the expression (III.224), that the analyticity strips are given by (III.223). To this end, we will disregard the zero-mode which could be hidden in the symbol \simeq , as motivated above. A more rigorous version of the argument can also be written using the TBA-equations, and it would give the same result, without having to disregard any zero-mode.

To start with, we can use the definition of the convolution (III.36) to write

$$Y_{a,s}(\mathbf{u} + \alpha i/2) = e^{-\delta_{s,0} E_a(\mathbf{u} + \alpha i/2)} \left(\frac{1 + Y_{a,s+1}}{1 + 1/Y_{a+1,s}} \frac{1 + Y_{a,s-1}}{1 + 1/Y_{a-1,s}} \right)^{*K_2^{[+\alpha]}}, \quad (\text{III.226})$$

which holds when $|\alpha| < 1$. As the right-hand side gives an analytic expression of $Y_{a,s}(\mathbf{u})$ on \mathbf{A}_1 , we can conclude that $Y_{a,s} \in \mathcal{A}_1^m$. At $|\alpha| \geq 1$, the pole of the kernel K_2 (defined in (III.201)) at position $\pm i/2$ prevents us from going through this argument, and we should understand the consequences of this pole.

To this end let us comment on the analytic structure of $K_N * f$ when the function f is analytic on a strip \mathbf{A}_n , where $n > N - 1$. Due to the presence of a pole in K_N , the function

$$h_1(\mathbf{u}) \equiv \int_{\mathbf{v} \in \mathbb{R}} K_N(\mathbf{u} - \mathbf{v}) f(\mathbf{v}) d\mathbf{v} \quad (\text{III.227})$$

has two cuts where it suddenly jumps, when $\text{Im}(u) = \pm \frac{N-1}{2}$, because K_N has a pole at position $\pm i \frac{N-1}{2}$, with residue $\pm \frac{1}{2i\pi}$. The Cauchy theorem then shows that (for $u \in \mathbb{R}$),

$$\lim_{\substack{\epsilon \rightarrow 0 \\ \epsilon > 0}} h_1 \left(u \pm i \frac{N-1}{2} + i\epsilon \right) - h_1 \left(u \pm i \frac{N-1}{2} - i\epsilon \right) = \mp f(u). \quad (\text{III.228})$$

On the other hand, we can define²⁴

$$h_2(x + iy) \equiv \int_{v \in \mathbb{R}} K_N(x - v) f(v + iy) dv, \quad x, y \in \mathbb{R} \quad (\text{III.230})$$

This function h_2 coincides with h_1 if $y < i \frac{N-1}{2}$, as it can be seen by a simple contour manipulation. But unlike h_1 , the function h_2 has no jump at $i \frac{N-1}{2}$.

In what follows, we will not explicitly choose between the definitions h_1 and h_2 , which are equivalent on the real axis. We will simply remark that as shown above, we can write (if f is analytic on A_n , and u is real)

$$(K_N * f)^{[a+b]} = K_N^{[+a]} * f^{[+b]}, \quad |a| < N - 1, |b| < n, \quad (\text{III.231})$$

$$\text{where } (K_N * f)^{[a]} \equiv e^{i \frac{a}{2} \partial_u} (K_N * f) \equiv \sum_{n=0}^{\infty} \frac{\left(i \frac{a}{2}\right)^n \partial_u^n}{n!} (K_N * f). \quad (\text{III.232})$$

Here, we have a non-ambiguous definition of the convolution when u is real, and we formally define the shifted convolution $(K_N * f)^{[a]}$ as an analytic continuation. The above discussion about h_1 and h_2 teaches us that the shift can be distributed between the functions f and K_N (see (III.231)) as long as we do not meet poles.

The same analysis can actually also be performed if f contains poles, but then an extra term should be added to the equation $(K_N * f)^{[b]} = K_N * f^{[+b]}$ in order to take into account the contribution of shifting the integration contour across the pole²⁵. This can be done case by case, and at the price of an integration by part, it also works if f has a logarithmic pole (in order to define f^{*K_N}).

Keeping these statements in mind, we can proceed to prove (III.223). First, as we said, the expression (III.224) (where the right-hand-side is analytic at least on the real axis) gives immediately $Y_{a,s} \in \mathcal{A}_1^m$, which is true for arbitrary (a, s) . This result teaches that the ratio $\frac{1+Y_{a,s+1}}{1+1/Y_{a+1,s}} \frac{1+Y_{a,s-1}}{1+1/Y_{a-1,s}}$ on the right-hand-side of (III.224) is not only analytic around the real axis, but even on A_1 . Therefore $\left(\frac{1+Y_{a,s+1}}{1+1/Y_{a+1,s}} \frac{1+Y_{a,s-1}}{1+1/Y_{a-1,s}} \right)^{*K_2}$ is analytic on A_2 . If $s \neq 0$ or if $N \geq 4$, $e^{-\delta_{s,0}} E_a$ is also analytic on A_2 . By this statement we mean

²⁴This function h_2 can equivalently be defined as

$$h_2(u) \equiv \int_{v \in \mathbb{R}} K_N(v) f(u - v) dv \quad (\text{III.229})$$

²⁵ For instance, if f has a pole at position $i/2$ with residue R_0 , then we see that $K_N p^*(f^{[+1+\epsilon]}) - K_N * (f^{[+1-\epsilon]})$ is equal (when $\epsilon \rightarrow 0$) to $-2i\pi \frac{K_N(0)}{u} R_0$. Hence in order to define $(K_N * f)^{[b]}$ as the analytic continuation of $(K_N * f)^{[b]}$, we should define $(K_N * f)^{[b]} = K_N * f^{[+b]} - 2i\pi \frac{K_N(0)}{u-i/2} R_0$ when $b > 1$.

$e^{-\delta_{s,0} E_a} \in \mathcal{A}_2^m$ as defined above, and this is true only²⁶ if $s \neq 0$ or if $N \geq 4$. Hence we deduce that $Y_{a,s} \in \mathcal{A}_2^m$ (if $s \neq 0$ or if $N \geq 4$).

In order to prove (III.223), we can therefore use an iterative procedure, where at the step n , we show that for several values of (a, s) , we have $\frac{1+Y_{a,s+1}}{1+1/Y_{a+1,s}} \frac{1+Y_{a,s-1}}{1+1/Y_{a-1,s}} \in \mathbf{A}_n$ and we deduce $Y_{a,s} \in \mathbf{A}_{n+1}$. After the step²⁷ $n = \lceil N/2 \rceil$, the iterations do not teach anything for $s = 0$, because e^{-E_a} is only analytic on the strip $\mathbf{A}_{N/2}$. Therefore we only get $Y_{a,0} \in \mathcal{A}_{N/2}^m$. Similarly, after the iteration $n = 1 + \lceil N/2 \rceil$, we cannot gain analyticity for $Y_{a,\pm 1}$, because the ratio $\frac{1+Y_{a,2}}{1+1/Y_{a+1,1}} \frac{1+Y_{a,0}}{1+1/Y_{a-1,1}}$ is only analytic on $\mathbf{A}_{N/2}$. Therefore we only get $Y_{a,\pm 1} \in \mathcal{A}_{1+N/2}^m$. In the same way, for each value of $|s|$, the iteration stops when the Y-functions on the right-hand-side stop gaining analyticity, and we get exactly

$$Y_{a,s} \in \mathcal{A}_{|s|+N/2}^m.$$

III.3.3.2 Analyticity strips for the T -functions

The analyticity strips identified in the previous section for the Y-functions can now be used to find analyticity strips for T -functions. The analyticity properties of T -functions depend on the gauge, because they can easily be spoiled by a gauge transformation (III.60) having poor analyticity properties.

One can show that there exist gauges where the T -functions have the analyticity strip

$$\begin{aligned} T_{a,s} &\in \mathcal{A}_{s+1+N/2}^m & \text{if } a \in \llbracket 1, N-1 \rrbracket \\ T_{a,s} &\in \mathcal{A}_{s+N/2}^m & \text{otherwise} \end{aligned} \quad (\text{III.233})$$

To show this one can simply use the proof of the Statement 2 (page 112), which shows how to find T -functions out of the set of Y-functions $\{Y_{a,0} | 1 \leq a \leq N-1 \text{ and } 0 \leq s \leq 1\}$. In this proof an expression of $\{T_{a,0} | 0 \leq a \leq N \text{ and } 0 \leq s \leq 1\}$ is obtained in a specific gauge, through the inversion of the operator $f \mapsto f^{[N]_D}$. This inversion can for instance²⁸ be done by means of the kernel K_N , and in that case, we obtain T -functions such that the analyticity condition (III.233) holds for $0 \leq s \leq 1$. To conclude that this analyticity condition holds for all a and s , one can for instance do a recurrence over s , and proceed quite similarly²⁹ to the proof of (III.223).

Moreover, we can for instance choose a gauge where the limit of $T_{a,s}$ is $T_{a,s}^{(R)}$, which does not have any pole. We will assume that there exists (at least) one such gauge with

$$T_{a,s} \in \mathcal{A}_{s+1+N/2} \quad \text{if } a \in \llbracket 1, N-1 \rrbracket; \quad \text{and} \quad T_{a,s} \in \mathcal{A}_{s+N/2} \quad \text{if } a \in \{0, N\}. \quad (\text{III.234})$$

²⁶By contrast the statement “for fixed L , $e^{-\delta_{s,0} E_a}$ is an analytic function of the variable u ” is always true.

²⁷Here $\lceil \dots \rceil$ denotes the ceiling function.

²⁸The inverse of $f \mapsto f^{[N]_D}$ is not unique, and choosing one specific inverse corresponds to a choice of gauge. If we use the kernel K_N and we do not add any zero-mode, then we get meromorphic T -functions.

²⁹This recurrence can be sketched as follows: if we know the analyticity strip for $T_{a,s-1}$ and $T_{a,s}$, we can use the Hirota equation (III.57) to obtain $T_{a,s+1} \in \mathcal{A}_{s+N/2}^m$ if $a \in \llbracket 1, N-1 \rrbracket$ and $T_{a,s+1} \in \mathcal{A}_{s-1+N/2}^m$ if $a \in \{0, N\}$. We can then deduce $T_{a,s}$ slightly outside its analyticity strip by writing $T_{a,s+1} + = 1 + Y_{a,s+1} T_{a+1,s+1} T_{a-1,s+1} / T_{a,s+1}$ which allows to deduce the wider strips written in (III.233).

Here \mathcal{A}_n denotes the set of holomorphic³⁰ functions which have an holomorphic limit on \mathbf{A}_n when $L \rightarrow \infty$.

The analyticity constraint (III.234) shows that the analyticity properties of the T -functions are simpler than the properties of Y -functions. In particular, we see that the T -functions do not have any poles.

Moreover, it is not difficult to show that we can choose a gauge where we have (like in the asymptotic limit)

$$T_{0,s} = T_{0,0}^{[-s]}, \quad T_{N,s} = T_{N,0}^{[+s]}. \quad (\text{III.235})$$

In that case, we see that $T_{0,0} = T_{0,s}^{[+s]}$ is analytic when $\text{Im}(u) \in [-N/4 - s, N/4]$, and this statement holds for arbitrary $s \geq 0$. Therefore $T_{0,0}$ is analytic as long as $\text{Im}(u) < \frac{N}{4}$. Proceeding the same way for $T_{N,s}$ we obtain

$$T_{0,s} \quad \text{is analytic when} \quad \text{Im}(u) < \frac{N}{4} + \frac{s}{2} \quad (\text{III.236})$$

$$T_{N,s} \quad \text{is analytic when} \quad \text{Im}(u) > -\frac{N}{4} - \frac{s}{2}. \quad (\text{III.237})$$

It is noteworthy that the analyticity domain for the functions $T_{0,0} = p_{\emptyset}^{[-N]}$ and $T_{0,0} = q_{\emptyset}$ are half-planes, and not just strips (like it is the case for the T - and Y -functions). This property of q -functions is general in the sense that it holds for q -functions with an arbitrary number of indices, and remarkably it also holds for other models than the principal chiral model.

In the next sections, we will see how to find a solution of the Hirota equation under these analyticity conditions, and we will see that the solution obtained this way passes several nontrivial consistency checks.

Remark The analyticity strips defined above (in (III.233)) give non-zero analyticity strips when $s \geq 0$ (or at least when $s \geq -N/4$), whereas for $s < -N/2$, the analyticity strip has size zero. This corresponds to one possible choice of gauge, but one can also choose a gauge having similar properties for the “left band”, i.e. such that (III.234) is replaced with

$$\tilde{T}_{a,s} \in \mathcal{A}_{-s+1+N/2} \quad \text{if } a \in \llbracket 1, N-1 \rrbracket; \quad \text{and} \quad \tilde{T}_{a,s} \in \mathcal{A}_{-s+N/2} \quad \text{if } a \in \{0, N\}. \quad (\text{III.238})$$

III.3.3.3 Analyticity strips for the q -functions

As we have seen, the q -functions are defined as a set of independent solutions of the difference equation

$$0 = \left| \begin{array}{c} \left(q_{\{i\}}^{[2l]} \right)_{1 \leq l \leq N+1} \\ \left(T_{1,k+l-3+s}^{[l-k+3-s]} \right)_{\substack{2 \leq k \leq N+1 \\ 1 \leq l \leq N+1}} \end{array} \right|, \quad 1 \leq i \leq N \quad (\text{III.239})$$

³⁰One should be careful to distinguish the symbols \mathcal{A}_n^m , introduced to describe meromorphic functions, and the symbol \mathcal{A}_n , introduced to describe holomorphic functions.

If $s = 0$, this equation coincides with (III.102), whereas if $s \neq 0$ it follows from (III.97) by the same argument as (III.102).

In this equation, we can see that each coefficients $T_{1,k+l-3+s}^{[l-k+3-s]}$ entering the determinant is analytic in the domain $\text{Im}(\mathbf{u}) \in] -\frac{N}{4} - l - \frac{1}{2}, \frac{N}{4} + k + s - \frac{5}{2}[$ (where s can be chosen arbitrarily large).

This allows to choose the q -functions such that

$$\text{For each } i \in \llbracket 1, N \rrbracket, \quad q_{\{i\}} \text{ is analytic when } \text{Im}(\mathbf{u}) > -1/2 - N/4, \quad (\text{III.240})$$

$$\text{For each } i \in \llbracket 1, N \rrbracket, \quad p_{\{i\}} \text{ is analytic when } \text{Im}(\mathbf{u}) < 1/2 + N/4, \quad (\text{III.241})$$

$$\text{and } q_\emptyset = 1, \quad p_\emptyset = 1, \quad (\text{III.242})$$

where the last constraint (III.242) corresponds to the gauge constraint (III.235).

The q -functions with multiple indices can be computed through the Wronskian determinant (III.98-III.99) to get

$$\text{For each } I \subset \llbracket 1, N \rrbracket, \quad q_I \text{ is analytic when } \text{Im}(\mathbf{u}) > -1 - N/4 + |I|/2, \quad (\text{III.243})$$

$$\text{For each } I \subset \llbracket 1, N \rrbracket, \quad p_I \text{ is analytic when } \text{Im}(\mathbf{u}) < 1 + N/4 - |I|/2, \quad (\text{III.244})$$

which implies in turn that

$$T_{a,s} = q_{(a)}^{[+s]} \wedge p_{(N-a)}^{[-s]} \in \mathcal{A}_{s+2}^{[-a+N/2]}, \quad (\text{III.245})$$

where $\mathcal{A}_s^{[a]}$ denotes the set of holomorphic functions which have an holomorphic limit when $L \rightarrow \infty$, for $\mathbf{u} \in \mathbf{A}_s^{[a]} \equiv \{\mathbf{u} \in \mathbb{C} \mid \text{Im}(\mathbf{u}) \in [-\frac{s-a}{2}, \frac{s-a}{2}]\}$. We see that when we compute the T -functions from the Wronskian determinant expression $T_{a,s} = q_{(a)}^{[+s]} \wedge p_{(N-a)}^{[-s]}$, we automatically obtain the analyticity strip (III.245), but this analyticity strip is smaller than in (III.234). The wider analyticity strip (III.234) means that in fact, there are situations where the coefficients of the determinant are not analytic, but some cancellations inside the determinant allow the determinant to be analytic. Such situations will also be described in the chapter IV.

III.3.3.4 Cauchy representations of analytic functions

In the above subsections we have found analyticity constraints on the set of q -functions. Let us now show, in a quite general context, that the information we have about analytic functions often allows to parameterize them in a very simple way.

To demonstrate this, we will give a theorem which solves a very simple ‘‘Riemann Hilbert’’ problem. This type of problems (called Riemann Hilbert problems) are situations where we know some analyticity properties of a function on the complex plane and its behavior at $z \rightarrow \infty$, and they allow to uniquely fix this function.

Statement 8. *Let $F(z)$ be an holomorphic function of z in the domain $\text{Im}(z) \geq 0$, and let $G(z)$ be an holomorphic function of z in the domain $\text{Im}(z) \leq 0$.*

If $F(z)$ and $G(z)$ go to zero at infinity, at least as a power law (i.e. if there exists $\epsilon > 0$ such that $F(z)z^\epsilon \xrightarrow{|z| \rightarrow \infty} 0$ and $G(z)z^\epsilon \xrightarrow{|z| \rightarrow \infty} 0$), then we have the equality

$$\boxed{\frac{1}{2i\pi} \int_{\mathbf{v} \in \mathbb{R}} \frac{F(\mathbf{v}) - G(\mathbf{v})}{\mathbf{v} - \mathbf{u}} d\mathbf{v} = \begin{cases} F(\mathbf{u}) & \text{if } \text{Im}(\mathbf{u}) > 0 \\ G(\mathbf{u}) & \text{if } \text{Im}(\mathbf{u}) < 0 \end{cases}} \quad \text{(III.246a)}$$

$$\frac{F(\mathbf{u}) + G(\mathbf{u})}{2} = \frac{1}{2i\pi} \int_{\mathbf{v} \in \mathbb{R}} \frac{F(\mathbf{v}) - G(\mathbf{v})}{\mathbf{v} - \mathbf{u}} d\mathbf{v}, \quad \text{if } \mathbf{u} \in \mathbb{R}, \quad \text{(III.247)}$$

where the symbol \int in (III.247) denotes a principal part integration.

Proof. Let us prove (for instance) the equality (III.246a). First, we notice that the condition that $F(z)$ and $G(z)$ go to zero at infinity, at least as a power law, ensures that the integral is convergent and is equal to $\lim_{R \rightarrow \infty} \frac{1}{2i\pi} \int_{-R}^R \frac{F(\mathbf{v}) - G(\mathbf{v})}{\mathbf{v} - \mathbf{u}} d\mathbf{v}$.

Next we can compute the integral $I_R = \int_{-R}^R \frac{F(\mathbf{v})}{\mathbf{v} - \mathbf{u}} d\mathbf{v} + \int_{\mathcal{C}_R} \frac{F(\mathbf{v})}{\mathbf{v} - \mathbf{u}} d\mathbf{v}$, where \mathcal{C}_R is an half circle of radius R which closes the contour in the direction $\text{Im}(\mathbf{v}) > 0$, (in other words $\mathcal{C}_R = \{Re^{i\theta} | \theta \in [0, \pi]\}$). In the case $\text{Im}(\mathbf{u}) > 0$, the integrand has one single singularity at $\mathbf{v} = \mathbf{u}$. Hence as soon as $R > |\mathbf{u}|$, the integral I_R is equal to $I_R = 2i\pi F(\mathbf{u})$.

Then we compute the integral $I'_R = \int_{-R}^R \frac{G(\mathbf{v})}{\mathbf{v} - \mathbf{u}} d\mathbf{v} + \int_{\mathcal{C}'_R} \frac{G(\mathbf{v})}{\mathbf{v} - \mathbf{u}} d\mathbf{v}$, where \mathcal{C}'_R is the half circle $\{Re^{-i\theta} | \theta \in [0, \pi]\}$ of radius R which closes the contour in the direction $\text{Im}(\mathbf{v}) < 0$. In the case $\text{Im}(\mathbf{u}) > 0$, the integrand does not have any singularity, and $I'_R = 0$.

Finally, one easily checks that $\lim_{R \rightarrow \infty} \int_{\mathcal{C}_R} \frac{F(\mathbf{v})}{\mathbf{v} - \mathbf{u}} d\mathbf{v} = \lim_{R \rightarrow \infty} \int_{\mathcal{C}'_R} \frac{G(\mathbf{v})}{\mathbf{v} - \mathbf{u}} d\mathbf{v} = 0$. Hence $\frac{1}{2i\pi} \int_{\mathbf{v} \in \mathbb{R}} \frac{F(\mathbf{v}) - G(\mathbf{v})}{\mathbf{v} - \mathbf{u}} d\mathbf{v}$ is the limit of $\frac{1}{2i\pi} (I_R - I'_R)$ when $R \rightarrow \infty$, and we obtain the result (III.246a).

The proof of (III.246b) is absolutely identical, and one just has to write the correct sign in the residue theorem.

Finally, we can use (III.246) to write $\frac{F(\mathbf{u} + i\epsilon) + G(\mathbf{u} - i\epsilon)}{2} = \frac{1}{2i\pi} \int_{\mathbf{v} \in \mathbb{R}} \frac{(\mathbf{v} - \mathbf{u})^2}{(\mathbf{v} - \mathbf{u})^2 + \epsilon^2} \frac{F(\mathbf{v}) - G(\mathbf{v})}{\mathbf{v} - \mathbf{u}} d\mathbf{v}$ when $\mathbf{u} \in \mathbb{R}$. Then, if we notice that the ratio $\frac{(\mathbf{v} - \mathbf{u})^2}{(\mathbf{v} - \mathbf{u})^2 + \epsilon^2}$ is an even function of $\mathbf{u} - \mathbf{v}$, which tends to one if $|\mathbf{u} - \mathbf{v}| \gg \epsilon$ and to zero if $|\mathbf{u} - \mathbf{v}| \ll \epsilon$. Therefore the limit of $\frac{1}{2i\pi} \int_{\mathbf{v} \in \mathbb{R}} \frac{(\mathbf{v} - \mathbf{u})^2}{(\mathbf{v} - \mathbf{u})^2 + \epsilon^2} \frac{F(\mathbf{v}) - G(\mathbf{v})}{\mathbf{v} - \mathbf{u}} d\mathbf{v}$ when $\epsilon \rightarrow 0$ is exactly the principal value integral which gives (III.247). \square

Cauchy kernel The expressions in the left-hand-side of (III.246) can also be written as $\mathcal{K} * (F - G)$, where \mathcal{K} denotes the Cauchy kernel

$$\mathcal{K}(\mathbf{u}) \equiv \frac{1}{2i\pi} \frac{-1}{\mathbf{u}}. \quad \text{(III.248)}$$

Therefore, expressions like $\mathcal{K} * (F - G)$ (which this theorem gives) are called ‘‘Cauchy representations’’ of complex functions.

The next subsection will show that this theorem allows to find convenient parameterizations of the q -functions. We will also see in chapter IV that the same theorem allows to find non-trivial equations giving rise to a FinLIE for the AdS/CFT Y-system.

III.3.3.5 Parameterization of the q -functions

Reality condition In the asymptotic limit ($L \rightarrow \infty$), the q -functions were related to the real polynomials $Q_{[\mathbf{m}]}(\mathbf{u})$ by the change of variables (III.190). Let us therefore introduce the following shifted q -functions:

$$\mathfrak{q}_I \equiv q_I^{[-N/2]} \qquad \mathfrak{p}_I \equiv p_I^{[+N/2]}. \quad (\text{III.249})$$

In the asymptotic limit, we have $p_I = q_I^{[-N]}$, which ensures that $\mathfrak{q}_I = \mathfrak{p}_I$. The relation (III.190) also ensures that in the asymptotic limit $\mathfrak{q}_{\{1,2,\dots,N-\mathbf{m}\}}(\mathbf{u}) = Q_{[\mathbf{m}]}(\mathbf{u})$, where we have dropped the labels (R/L) for simplicity.

Outside the asymptotic limit, i.e. when the size L is finite, we cannot a priori assume that these functions will still be real. But in order to obtain a real energy from equation (III.52), we can expect that the equation $\overline{Y_{a,s}} = Y_{N-a,s}$ (which holds in the asymptotic limit), will hold even at finite size. In this relation $\overline{Y_{a,s}}$ denotes the complex-conjugate of the function $Y_{a,s}$, defined by

$$\overline{F}(\mathbf{u}) \equiv \overline{F(\overline{\mathbf{u}})}. \quad (\text{III.250})$$

From this hypothesis, we can deduce that one can choose a gauge (for the T -functions) such that

$$\overline{T_{a,s}(\mathbf{u})} = (-1)^{\frac{N(N-1)}{2}} T_{N-a,s}(\overline{\mathbf{u}}). \quad (\text{III.251})$$

Proof. Let us assume that $\overline{Y_{a,s}(\mathbf{u})} = Y_{N-a,s}(\overline{\mathbf{u}})$, and let us denote by $T_{a,s}$ a solution of the Hirota equation such that $Y_{a,s} = \frac{T_{a,s+1} T_{a,s-1}}{T_{a+1,s} T_{a-1,s}}$. Let $\tilde{T}_{a,s}(\mathbf{u}) \equiv \overline{T_{N-a,s}(\overline{\mathbf{u}})}$, which is another solution of the Hirota equation. Then we notice that $\frac{\tilde{T}_{a,s+1} \tilde{T}_{a,s-1}}{\tilde{T}_{a+1,s} \tilde{T}_{a-1,s}} = \overline{Y_{N-a,s}(\overline{\mathbf{u}})} = Y_{a,s} = \frac{T_{a,s+1} T_{a,s-1}}{T_{a+1,s} T_{a-1,s}}$, and we deduce (from Statement 3 (page 115)) that there exist four gauge functions g_1, g_2, g_3 and g_4 such that $\tilde{T}_{a,s} = g_1^{[a+s]} g_2^{[a-s]} g_3^{[-a+s]} g_4^{[-a-s]} T_{a,s}$. This shows that the transformation

$$T_{a,s} \rightsquigarrow i^{\frac{N(N-1)}{2}} \sqrt{g_1^{[a+s]}} \sqrt{g_2^{[a-s]}} \sqrt{g_3^{[-a+s]}} \sqrt{g_4^{[-a-s]}} T_{a,s} = \sqrt{T_{a,s} \tilde{T}_{a,s}}, \quad (\text{III.252})$$

is a gauge transformation into a gauge where the condition (III.251) is satisfied. One should also note that the above construction does not spoil the analyticity strip of the T -functions. \square

Finally, (potentially at the price of a transformation of the form (III.166-III.167)), we can ensure that

$$\overline{\mathfrak{q}_\emptyset(\mathbf{u})} = \mathfrak{p}_\emptyset(\overline{\mathbf{u}}), \quad \text{and} \quad \forall \mathbf{u} \in \mathbb{C}, \quad \forall i \in \llbracket 1, N \rrbracket \quad \overline{\mathfrak{q}_{\{i\}}(\mathbf{u})} = \mathfrak{p}_{\{i\}}(\overline{\mathbf{u}}). \quad (\text{III.253})$$

In the article [10KL], we have therefore denoted these functions as q and \bar{q} .

The relation (III.253) is proven by the same argument as (III.251): we start from arbitrary q -functions producing the T -functions which obey (III.251). Then we notice that the q -functions

$$\tilde{\mathfrak{q}}_\emptyset = \overline{\mathbb{P}_\emptyset}, \quad \tilde{\mathbb{P}}_\emptyset = \overline{\mathfrak{q}_\emptyset}, \quad \tilde{\mathfrak{q}}_{\{i\}} = \overline{\mathbb{P}_{\{i\}}}, \quad \tilde{\mathbb{P}}_{\{i\}} = \overline{\mathfrak{q}_{\{i\}}}, \quad (\text{III.254})$$

reproduce the same T -functions. Indeed, the Wronskian determinant expression gives

$$\tilde{\mathfrak{q}}_{(n)} = (-1)^{\frac{n(n-1)}{2}} \overline{\mathbb{P}_{(n)}}, \quad \text{and} \quad \tilde{\mathbb{P}}_{(n)} = (-1)^{\frac{n(n-1)}{2}} \overline{\mathfrak{q}_{(n)}}, \quad (\text{III.255})$$

$$\text{hence } \tilde{\mathfrak{q}}_{(a)}^{[+s]} \wedge \tilde{\mathbb{P}}_{(N-a)}^{[-s]} = (-1)^{\frac{N(N-1)}{2}} \overline{\mathfrak{q}_{(N-a)}^{[+s]} \wedge \mathbb{P}_{(a)}^{[-s]}}. \quad (\text{III.256})$$

Therefore, the Statement 7 (page 129) shows that they are related by a transformation of the form (III.166-III.167). Up to the factors³¹ F and C , this means that $\overline{\mathfrak{q}_{\{i\}}} = H_i^j \mathbb{P}_{\{j\}}$, and that $\overline{\mathbb{P}_{\{i\}}} = H_i^j \mathfrak{q}_{\{j\}}$. The consistency of these two relations imposes $\overline{H} \cdot H = 1$, which allows to decompose H as $H = \overline{A}^{-1} A$, and to redefine $\mathfrak{q}_{\{j\}} \rightsquigarrow A_i^j \mathfrak{q}_{\{j\}}$ and $\mathbb{P}_{\{j\}} \rightsquigarrow A_i^j \mathbb{P}_{\{j\}}$, so as to ensure the relation (III.253).

In addition, it is easy to see that we can simultaneously constrain the gauge to obtain

$$\mathfrak{q}_\emptyset = 1 \quad (\text{III.257})$$

Parameterization of the q -functions Let us now write down how to parameterize the q -functions. As stated above, we can choose a gauge where

$$\mathfrak{q}_\emptyset = 1. \quad (\text{III.258})$$

Roughly speaking, the reality condition (III.253) fixes two out of four degrees of gauge freedom, whereas the above condition $\mathfrak{q}_\emptyset = 1$ fixes one more degree of gauge freedom.

As discussed in section III.3.1, the limit $\mathbf{u} \rightarrow \infty$ should be essentially the same when L is finite as in the limit $L \rightarrow \infty$. This allows to deduce that there exist polynomials P_i (where $i \in \llbracket 1, N \rrbracket$) such that $\mathfrak{q}_{\{i\}}(\mathbf{u}) - P_i(\mathbf{u}) \xrightarrow{\mathbf{u} \rightarrow \infty} 0$ and $\mathbb{P}_{\{i\}}(\mathbf{u}) - P_i(\mathbf{u}) \xrightarrow{\mathbf{u} \rightarrow \infty} 0$. These polynomials have the same degree as the polynomial $\mathfrak{q}_{\{i\}}^{L=\infty}(\mathbf{u})$ which describes the asymptotic limit. Then, we can use the Statement 8 (page 147) to write

$$P_i(\mathbf{u}) + \frac{1}{2i\pi} \int_{\mathbf{v} \in \mathbb{R}} \frac{f_i(\mathbf{v})}{\mathbf{v} - \mathbf{u}} d\mathbf{v} = \begin{cases} \mathfrak{q}_{\{i\}}(\mathbf{u}) & \text{if } \text{Im}(\mathbf{u}) > 0 \\ \mathbb{P}_{\{i\}}(\mathbf{u}) & \text{if } \text{Im}(\mathbf{u}) < 0 \end{cases} \quad (\text{III.259a})$$

$$(\text{III.259b})$$

$$\text{where } f_i \equiv \mathfrak{q}_{\{i\}}(\mathbf{u}) - \mathbb{P}_{\{i\}}(\mathbf{u}). \quad (\text{III.259c})$$

To obtain this equation, we used the Statement 8 for the functions $F = \mathfrak{q}_{\{i\}} - P_i$ and $G = \mathbb{P}_{\{i\}} - P_i$, and this argument relies on the analyticity properties (III.240-III.241).

³¹We can for instance get rid of these factors by restricting to the case where $\mathfrak{q}_\emptyset = \mathbb{P}_\emptyset = 1$.

The expression (III.259) allows to parameterize all the Y - T - and q -functions in terms of the functions f_i and the polynomials P_i . We can also notice that the “jump density”³² f_i is exponentially small in the $L \rightarrow \infty$ limit, which means that it describes the finite size corrections. Moreover $f_i(\mathbf{u}) \equiv \mathfrak{q}_{\{i\}}(\mathbf{u}) - \mathfrak{p}_{\{i\}}(\mathbf{u})$ is also exponentially small in the limit $\mathbf{u} \rightarrow \infty$, which will be convenient for numerical computation (it allows to approximate it to a good accuracy by a function with finite support).

A last comment about the function $f_i(\mathbf{u}) \equiv \mathfrak{q}_{\{i\}}(\mathbf{u}) - \mathfrak{p}_{\{i\}}(\mathbf{u})$ is that it is holomorphic when $|\text{Im}(\mathbf{u})| < 1/2$ (see (III.243-III.244)). This means that if we know this function slightly shifted from the real axis, we can write for instance (if $|\alpha| < 1$)

$$P_i(\mathbf{u} + \alpha \frac{i}{2}) + \frac{1}{2i\pi} \int_{\mathbf{v} \in \mathbb{R}} \frac{f_i(\mathbf{v} + \alpha \frac{i}{2})}{\mathbf{v} - \mathbf{u}} d\mathbf{v} = \begin{cases} \mathfrak{q}_{\{i\}}(\mathbf{u} + \alpha \frac{i}{2}) & \text{if } \text{Im}(\mathbf{u}) > 0 \\ \mathfrak{p}_{\{i\}}(\mathbf{u} + \alpha \frac{i}{2}) & \text{if } \text{Im}(\mathbf{u}) < 0 \end{cases} \quad \begin{matrix} \text{(III.260)} \\ \text{(III.261)} \end{matrix}$$

This is obtained by analytic continuation from (III.259), and it allows to express the functions $\mathfrak{q}_{\{i\}}$ on their whole analyticity domain.

Case of the U(1) sector Let us now study a specific class of states (i.e. a specific class of solutions of the Y -system) called the “U(1) sector”. It is the set of states such that in the asymptotic limit all the polynomials $Q_{[\mathbf{m}]}(\mathbf{u})$ are constant polynomials (i.e. they are equal to one up to a normalization), except the polynomial $Q_{[0]}(\mathbf{u})$. This means that these states have no spin-wave excitations, and one can show that for instance, the vacuum and the first excited state (defining the mass gap) belong to this sector. For the states in this sector, the functions $T_{a,s}^{(R)}$ and $T_{a,s}^{(L)}$ are equal. This property is clear in the $L \rightarrow \infty$ limit (because $Q_{[\mathbf{m}]}(\mathbf{u}) = Q_{[-\mathbf{m}]}(\mathbf{u})$), and we will construct solutions of the Y -system which obey this property at finite size, and converge to the asymptotic solution when $L \rightarrow \infty$.

One can then express explicitly the polynomials P_i (which converge to $\mathfrak{q}_{\{i\}}^{L=\infty}(\mathbf{u})$ when $L \rightarrow \infty$) because in the asymptotic limit we have

$$\forall \mathbf{m} \geq 1, \quad \left| \left(\mathfrak{q}_{\{i\}}^{[-1-N+\mathbf{m}+2j]} \right)_{1 \leq i, j \leq N-\mathbf{m}} \right| = \mathfrak{q}_{\{1,2,\dots,N-\mathbf{m}\}} = Q_{[\mathbf{m}]}(\mathbf{u}) = 1. \quad \text{(III.262)}$$

At $\mathbf{m} = N - 1$, this equation gives $\mathfrak{q}_{\{1\}}^{L=\infty} = 1$, then at $\mathbf{m} = N - 2$ it gives $\mathfrak{q}_{\{2\}}^+ - \mathfrak{q}_{\{2\}}^- = 1$, which can for instance be solved by $\mathfrak{q}_{\{2\}}^{L=\infty}(\mathbf{u}) = -i\mathbf{u}$. Another solution would be $\mathfrak{q}_{\{2\}}^{L=\infty}(\mathbf{u}) = -i\mathbf{u} + c$, for an arbitrary constant c , but we will disregard this term because it can be absorbed by transformations of the form (III.166-III.167). For the same reason, we will disregard the factor $-i$ in $\mathfrak{q}_{\{2\}}^{L=\infty}$.

³²The denomination “jump density” will be used to emphasize the fact that in (III.259), we define a function which is analytic on the whole complex plane except on the real axis, and which is obtained by “gluing” the function $\mathfrak{q}_{\{i\}}(\mathbf{u})$ (for $\text{Im}(\mathbf{u}) > 0$) with the function $\mathfrak{p}_{\{i\}}(\mathbf{u})$ (for $\text{Im}(\mathbf{u}) < 0$). This “gluing” gives rise to a function which “jumps” by the amount f_i on the real axis.

One should not try to interpret physically the word density in “jump density”, because the function $f_i \equiv \mathfrak{q}_{\{i\}} - \mathfrak{p}_{\{i\}}$ is imaginary, and even after division by i it does not necessarily have a constant sign.

By proceeding iteratively, we obtain

$$\boxed{\forall i \leq N-1, \quad P_i(\mathbf{u}) = \frac{\mathbf{u}^{i-1}}{(i-1)!}}, \quad (\text{III.263})$$

whereas $P_i(\mathbf{u})$ is a polynomial of degree $N-1+M$, where $M \equiv d^{(0)}$ is the degree of $\varphi \equiv Q_{[0]}(\mathbf{u})$. Out of the $N+M$ coefficients of this polynomial, only M coefficients are relevant because $N-1$ of them can be removed by transformations of the form (III.166-III.167), and one of them is an overall multiplicative factor (which can be absorbed into a gauge transformation). Moreover, we have (still in the asymptotic limit) $\varphi = \mathfrak{q}_{\emptyset} = \left| \left(\mathfrak{q}_{\{i\}}^{[-1-N+2j]} \right)_{1 \leq i, j \leq N} \right| = \left| \left(P_i^{[-1-N+2j]} \right)_{1 \leq i, j \leq N} \right|$ (if $\text{Im}(\mathbf{u}) \geq N/4$). Using the expression (III.263) of P_1, P_2, \dots, P_{N-1} , we obtain

$$\varphi = \mathfrak{i}^{\frac{(N-1)(N-2)}{2}} \left(e^{\frac{\mathfrak{i}}{2}\partial_{\mathbf{u}}} - e^{-\frac{\mathfrak{i}}{2}\partial_{\mathbf{u}}} \right)^{N-1} P_N, \quad (\text{III.264})$$

in the limit $L \rightarrow \infty$.

The above arguments show the expression (III.263) in the asymptotic limit $L \rightarrow \infty$. At finite size, this limit fixes only the large \mathbf{u} behavior, i.e. the leading coefficient of P_i . But then we can argue, exactly like in the $L \rightarrow \infty$, that the other coefficients can be dropped using a transformation of the form (III.166-III.167).

Moreover, we still have a free degree of gauge freedom which takes the form

$$\mathfrak{q}_I \rightsquigarrow h^{[n]_D} \mathfrak{q}_I, \quad \text{where } n = |I|, \quad (\text{III.265})$$

$$\mathbb{P}_I \rightsquigarrow \bar{h}^{[n]_D} \mathbb{P}_I, \quad \text{where } \bar{h}(\mathbf{u}) \equiv \overline{h(\bar{\mathbf{u}})}, \quad (\text{III.266})$$

where $h(\mathbf{u})$ is an holomorphic function when $\text{Im}(\mathbf{u}) > -1/2$, which goes to one when $L \rightarrow \infty$ or $\mathbf{u} \rightarrow \infty$. This degree of freedom is sufficient to impose for instance

$$\boxed{\mathfrak{q}_{\{1\}} = 1} \quad \text{i.e. } f_1 = 0. \quad (\text{III.267})$$

In what follows we will restrict to the study of these ‘‘U(1) sector’’ states, as we did in [10KL]. We see that for these states, the q -functions (and hence the T - and Y -functions) are parameterized by a set of $N-1$ functions f_2, f_3, \dots, f_N , and by M relevant coefficients of the polynomial P_N .

III.3.4 Set of equations

Now that we have parameterized all the relevant functions, we will write equations which allow to fix them uniquely. For simplicity, we will explain this procedure in the U(1) sector, and we will construct the solution of the Y-system obeying the conditions written in the previous sections (such as the reality condition $\overline{Y_{a,s}(\mathbf{u})} = Y_{N-a,s}(\bar{\mathbf{u}})$, the symmetry condition $Y_{a,-s} = Y_{a,s}$, the analyticity strips), and converging (at $L \rightarrow \infty$) to the asymptotic solution written in section III.3.2. Hence we will identify these solutions to the finite-size description of these U(1) sector states.

To write these equations, we will use mainly the “middle nodes equation” of section III.3.2.3, which describes the behavior of the Y-system at $s = 0$. In particular, we will rewrite this equation in a form where no zero-mode needs to be added.

This “middle nodes equation” is necessarily a key ingredient to solve the Y-system, because it is the place where the size L appears in an equation. We will rewrite this equation into an equation on the densities f_i , in such a way that this equation can be solved iteratively.

III.3.4.1 Equation on the densities f_i

Let us now insert the parameterization (III.259) of the q -functions into the middle nodes equation (III.202). First, we can notice that our parameterization ensures that

$$T_{N,s} = \mathbb{Q}_{\bar{\theta}}^{[+s+N/2]}, \quad T_{0,s} = \mathbb{P}_{\bar{\theta}}^{[-s-N/2]}, \quad (\text{III.268})$$

$$\begin{aligned} \text{hence} \quad & \left(\frac{T_{N,0}^+ T_{N,0}^-}{T_{N,1} T_{N,1}^{(L)}} \right)^{[a]_D} \left(\frac{T_{0,0}^+ T_{0,0}^-}{T_{0,1} T_{0,1}^{(L)}} \right)^{[N-a]_D} = \left(\frac{\mathbb{Q}_{\bar{\theta}}^{[N/2-1]}}{\mathbb{Q}_{\bar{\theta}}^{[N/2+1]}} \right)^{[a]_D} \left(\frac{\mathbb{P}_{\bar{\theta}}^{[-N/2+1]}}{\mathbb{P}_{\bar{\theta}}^{[-N/2-1]}} \right)^{[N-a]_D} \\ & = \frac{\mathbb{Q}_{\bar{\theta}}^{[N/2-a]} \mathbb{P}_{\bar{\theta}}^{[N/2-a]}}{\mathbb{Q}_{\bar{\theta}}^{[N/2+a]} \mathbb{P}_{\bar{\theta}}^{[-3N/2+a]}} \end{aligned} \quad (\text{III.269})$$

Therefore the middle nodes equation (III.202) simplifies to

$$Y_{a,0} \simeq e^{-E_a} \frac{T_{a,1}^2}{T_{a-1,0} T_{a+1,0}} \left(\frac{\mathbb{Q}_{\bar{\theta}}^{[N/2-a]} \mathbb{P}_{\bar{\theta}}^{[N/2-a]}}{\mathbb{Q}_{\bar{\theta}}^{[N/2+a]} \mathbb{P}_{\bar{\theta}}^{[-3N/2+a]}} \right)^{*K_N}, \quad (\text{III.270})$$

$$\text{where } f_1 \simeq f_2 \quad \text{denotes} \quad (f_1)^{[N]_D} = (f_2)^{[N]_D}, \quad (\text{III.271})$$

where we have also used the fact that (for the $U(1)$ sector states), the functions $T_{a,s}^{(R)}$ and $T_{a,s}^{(L)}$ are equal. Using the definition of $Y_{a,0} = \frac{T_{a,1} T_{a,-1}}{T_{a-1,0} T_{a+1,0}}$, we deduce

$$T_{a,-1} \simeq e^{-E_a} T_{a,1} \left(\frac{\mathbb{Q}_{\bar{\theta}}^{[N/2-a]} \mathbb{P}_{\bar{\theta}}^{[N/2-a]}}{\mathbb{Q}_{\bar{\theta}}^{[N/2+a]} \mathbb{P}_{\bar{\theta}}^{[-3N/2+a]}} \right)^{*K_N}. \quad (\text{III.272})$$

On the other hand, this T -function is also equal to the determinant

$$T_{a,-1} = \begin{vmatrix} \mathbb{Q}_{\{1\}}^{[-a+N/2]} & \mathbb{Q}_{\{2\}}^{[-a+N/2]} & \mathbb{Q}_{\{3\}}^{[-a+N/2]} & \cdots & \mathbb{Q}_{\{N\}}^{[-a+N/2]} \\ \mathbb{Q}_{\{1\}}^{[-a+2+N/2]} & \mathbb{Q}_{\{2\}}^{[-a+2+N/2]} & \mathbb{Q}_{\{3\}}^{[-a+2+N/2]} & \cdots & \mathbb{Q}_{\{N\}}^{[-a+2+N/2]} \\ \vdots & \vdots & \vdots & \vdots & \vdots \\ \mathbb{Q}_{\{1\}}^{[+a-2+N/2]} & \mathbb{Q}_{\{2\}}^{[+a-2+N/2]} & \mathbb{Q}_{\{3\}}^{[+a-2+N/2]} & \cdots & \mathbb{Q}_{\{N\}}^{[+a-2+N/2]} \\ \mathbb{P}_{\{1\}}^{[+a+2-3N/2]} & \mathbb{P}_{\{2\}}^{[+a+2-3N/2]} & \mathbb{P}_{\{3\}}^{[+a+2-3N/2]} & \cdots & \mathbb{P}_{\{N\}}^{[+a+2-3N/2]} \\ \mathbb{P}_{\{1\}}^{[+a+4-3N/2]} & \mathbb{P}_{\{2\}}^{[+a+4-3N/2]} & \mathbb{P}_{\{3\}}^{[+a+4-3N/2]} & \cdots & \mathbb{P}_{\{N\}}^{[+a+4-3N/2]} \\ \vdots & \vdots & \vdots & \vdots & \vdots \\ \mathbb{P}_{\{1\}}^{[-a+N/2]} & \mathbb{P}_{\{2\}}^{[-a+N/2]} & \mathbb{P}_{\{3\}}^{[-a+N/2]} & \cdots & \mathbb{P}_{\{N\}}^{[-a+N/2]} \end{vmatrix}. \quad (\text{III.273})$$

In this determinant (which is just an explicit rewriting of the expression (III.116) after the change of variables (III.249)), we can notice that the first line and the last line are the functions $\mathbb{Q}_{\{i\}}$ and $\mathbb{P}_{\{i\}}$ with the same shift, and they differ only by the jump density f_i . Therefore we can subtract or add these two lines, so as to replace the coefficients of the first line by $\mathbb{Q}_{\{i\}}^{[-a+N/2]} - \mathbb{P}_{\{i\}}^{[-a+N/2]}$, and the coefficients of the last line by $\frac{\mathbb{Q}_{\{i\}}^{[-a+N/2]} + \mathbb{P}_{\{i\}}^{[-a+N/2]}}{2}$. If we write this argument for $T_{a,-1}^{[a-N/2]}$ instead of $T_{a,-1}$ (in order to obtain $\mathbb{Q}_{\{i\}} - \mathbb{P}_{\{i\}}$ instead of $\mathbb{Q}_{\{i\}}^{[-a+N/2]} - \mathbb{P}_{\{i\}}^{[-a+N/2]}$), we get

$$T_{a,-1}^{[a-N/2]} = \sum_{j=2}^N d_{a,j} f_j \quad (\text{III.274})$$

$$\text{where } d_{a,j} \equiv (-1)^j \begin{vmatrix} \mathbb{Q}_{\{1\}}^{[+2]} & \cdots & \mathbb{Q}_{\{j-1\}}^{[+2]} & \mathbb{Q}_{\{j+1\}}^{[+2]} & \cdots & \mathbb{Q}_{\{N\}}^{[+2]} \\ \mathbb{Q}_{\{1\}}^{[+4]} & \cdots & \mathbb{Q}_{\{j-1\}}^{[+4]} & \mathbb{Q}_{\{j+1\}}^{[+4]} & \cdots & \mathbb{Q}_{\{N\}}^{[+4]} \\ \vdots & & & & & \vdots \\ \mathbb{Q}_{\{1\}}^{[+2a-2]} & \cdots & \mathbb{Q}_{\{j-1\}}^{[+2a-2]} & \mathbb{Q}_{\{j+1\}}^{[+2a-2]} & \cdots & \mathbb{Q}_{\{N\}}^{[+2a-2]} \\ \mathbb{P}_{\{1\}}^{[+2a-2N+2]} & \cdots & \mathbb{P}_{\{j-1\}}^{[+2a-2N+2]} & \mathbb{P}_{\{j+1\}}^{[+2a-2N+2]} & \cdots & \mathbb{P}_{\{N\}}^{[+2a-2N+2]} \\ \mathbb{P}_{\{1\}}^{[+2a-2N+4]} & \cdots & \mathbb{P}_{\{j-1\}}^{[+2a-2N+4]} & \mathbb{P}_{\{j+1\}}^{[+2a-2N+4]} & \cdots & \mathbb{P}_{\{N\}}^{[+2a-2N+4]} \\ \vdots & & & & & \vdots \\ \mathbb{P}_{\{1\}}^{[-2]} & \cdots & \mathbb{P}_{\{j-1\}}^{[-2]} & \mathbb{P}_{\{j+1\}}^{[-2]} & \cdots & \mathbb{P}_{\{N\}}^{[-2]} \\ P_1 & \cdots & P_{j-1} & P_{j+1} & \cdots & P_N \end{vmatrix}, \quad (\text{III.275})$$

where we also used the fact that $P_i = \frac{\mathbb{Q}_{\{i\}} + \mathbb{P}_{\{i\}}}{2}$.

Therefore, if we denote by $(c_{i,a})_{\substack{2 \leq i \leq N \\ 1 \leq a \leq N-1}}$ the adjugate matrix³³ of $(d_{a,j})_{\substack{1 \leq a \leq N-1 \\ 2 \leq j \leq N}}$, we obtain

$$f_i = \frac{\sum_{a=1}^{N-1} c_{i,a} T_{a,-1}^{[a-N/2]}}{\left| (d_{a,j})_{\substack{1 \leq a \leq N-1 \\ 2 \leq j \leq N}} \right|}. \quad (\text{III.276})$$

In these equations, the coefficients $c_{i,a}$ can be written in terms of the jump densities f_i (and of the M coefficients of the polynomial P_N), because when \mathbf{u} is real, all the functions $\mathbb{Q}_{\{i\}}$ which enter the determinant $d_{a,j}$ have a positive shift, while the functions $\mathbb{P}_{\{i\}}$ have a negative shift (i.e. they appear under the form $\mathbb{P}_{\{i\}}^{[-s]}$ where $s > 0$), hence they are expressed via (III.259).

³³The ‘‘adjugate matrix’’ is the transpose of the matrix of the cofactors. In other words, it is defined by $c_{i,a} = (-1)^{i+a} \left| (d_{b,j})_{\substack{b \in \llbracket 1, N-1 \rrbracket \setminus \{a\} \\ j \in \llbracket 2, N \rrbracket \setminus \{i\}}} \right|$. With this definition of the adjugate matrix, the inverse of a matrix M is its adjugate matrix divided by its determinant $\det M$.

This expression (III.276) is interesting because at large L , the coefficients $d_{b,j}$ have a well-defined limit, and the determinant in the denominator as well. On the other hand $T_{a,-1}$ is very small, and one easily obtains for instance the leading order expression of f_i out of the leading order expression of $T_{a,-1}$. At finite size the equation is less simple because the coefficients $d_{b,j}$ are functions of the f_i , but we will see that this equation (III.276) is suitable for an iterative numerical resolution.

Middle nodes equation and χ_{CDD} factor In order to efficiently use this equation (III.276) to write an equation on the jump densities f_i , we should express (when $\mathbf{u} \in \mathbb{R}$) the quantity

$$T_{a,-1}^{[a-N/2]} \simeq e^{-E_a^{[+a-N/2]}} T_{a,1}^{[a-N/2]} \left(\frac{\mathfrak{Q}_{\bar{\theta}}^{[N/2-a]} \mathbb{P}_{\bar{\theta}}^{[N/2-a]}}{\mathfrak{Q}_{\bar{\theta}}^{[N/2+a]} \mathbb{P}_{\bar{\theta}}^{[-3N/2+a]}} \right)^{*K_N^{[+a-N/2]}}, \quad (\text{III.277})$$

in terms of the densities f_i . The factor $T_{a,1}^{[a-N/2]}$ does not pose any problem, because $T_{a,1}$ is taken inside the strip \mathbf{A}_2 where it is easily expressed from the parameterization (III.259) of the q -functions. For the other factors, let us remind that since $\mathfrak{Q}_{\bar{\theta}}(\mathbf{u})$ (resp $\mathbb{P}_{\bar{\theta}}(\mathbf{u})$) is expressed as a Wronskian determinant of the functions $\mathfrak{Q}_{\{i\}}$ and $\mathbb{P}_{\{i\}}$, the parameterization of q -functions only allows to compute $\mathfrak{Q}_{\bar{\theta}}(\mathbf{u})$ (resp $\mathbb{P}_{\bar{\theta}}(\mathbf{u})$) on the domain where $\text{Im}(\mathbf{u}) \geq \frac{N-1}{2}$ (resp $\text{Im}(\mathbf{u}) \leq -\frac{N-1}{2}$). Therefore, if a is smaller than $\frac{N}{2} - 1$, we cannot express $\mathfrak{Q}_{\bar{\theta}}^{[N/2+a]}$ from this parameterization. But what we can do is to redistribute³⁴ the shifts between $\mathfrak{Q}_{\bar{\theta}}^{[N/2+a]}$ and the kernel K_N .

For instance we can write

$$\left(\frac{1}{\mathfrak{Q}_{\bar{\theta}}^{[N/2+a]}} \frac{1}{\mathbb{P}_{\bar{\theta}}^{[-3N/2+a]}} \right)^{*K_N^{[+a-N/2]}} = \left(\frac{1}{\mathfrak{Q}_{\bar{\theta}}^{[N+a-1]}} \right)^{*K_N^{[+a-N+1]}} \left(\frac{1}{\mathbb{P}_{\bar{\theta}}^{[+a-2N-1]}} \right)^{*K_N^{[+a-1]}}. \quad (\text{III.278})$$

For the numerator, one could try to proceed the same way, but it would fail because we would have to shift the kernel K_N by more than $\pm(N-1)$. Instead of that, we can use the relation

$$\left(\frac{\mathbb{P}_{\bar{\theta}}^+}{\mathbb{P}_{\bar{\theta}}^-} \right)^{[N]_D} = \frac{\mathbb{P}_{\bar{\theta}}^{[+N]}}{\mathbb{P}_{\bar{\theta}}^{[-N]}}, \quad \text{i.e. } \mathbb{P}_{\bar{\theta}}^{*K_N} \simeq \left(\mathbb{P}_{\bar{\theta}}^{[-2N]} \right)^{*K_N} \frac{\mathbb{P}_{\bar{\theta}}^{[+1-N]}}{\mathbb{P}_{\bar{\theta}}^{[-1-N]}} \quad (\text{III.279})$$

³⁴As we already said, redistributing the shifts in a convolution amounts to moving an integration contour, and this is allowed if the functions are analytic enough (otherwise the contribution of some poles may occur). Here, this shift of contour is allowed because we know from (III.237) and (III.268) that $\mathfrak{Q}_{\bar{\theta}}(\mathbf{u})$ is analytic as soon as $\text{Im}(\mathbf{u}) > 0$.

Using this relation, the numerator $\left(\mathbb{Q}_{\bar{\theta}}^{[N/2-a]} \mathbb{P}_{\bar{\theta}}^{[N/2-a]} \right)^{*K_N^{[+a-N/2]}}$ can be rewritten as

$$\begin{aligned} & \left(\mathbb{Q}_{\bar{\theta}}^{[N/2-a]} \mathbb{P}_{\bar{\theta}}^{[N/2-a]} \right)^{*K_N^{[+a-N/2]}} \\ & \simeq \frac{\mathbb{Q}_{\bar{\theta}}^{[+N-1]} \mathbb{P}_{\bar{\theta}}^{[-N+1]}}{\mathbb{Q}_{\bar{\theta}}^{[+N+1]} \mathbb{P}_{\bar{\theta}}^{[-N-1]}} \left(\mathbb{P}_{\bar{\theta}}^{[-2N-a+1]} \right)^{*K_N^{[+a-1]}} \left(\mathbb{Q}_{\bar{\theta}}^{[+2N+N-a+1]} \right)^{*K_N^{[-N+a+1]}} \end{aligned} \quad (\text{III.280})$$

Now the right-hand-side only involves q -functions in the domain where they are easily expressed from the densities f_i .

If we insert these expressions into (III.277), then we obtain

$$\begin{aligned} T_{a,-1}^{[a-N/2]} & \simeq \\ e^{-E_a^{[+a-N/2]}} T_{a,1}^{[a-N/2]} & \frac{\mathbb{Q}_{\bar{\theta}}^{[+N-1]} \mathbb{P}_{\bar{\theta}}^{[-N+1]}}{\mathbb{Q}_{\bar{\theta}}^{[+N+1]} \mathbb{P}_{\bar{\theta}}^{[-N-1]}} \left(\frac{\mathbb{P}_{\bar{\theta}}^{[-2N-a+1]}}{\mathbb{P}_{\bar{\theta}}^{[+a-2N-1]}} \right)^{*K_N^{[+a-1]}} \left(\frac{\mathbb{Q}_{\bar{\theta}}^{[+2N+N-a+1]}}{\mathbb{Q}_{\bar{\theta}}^{[N+a-1]}} \right)^{*K_N^{[-N+a+1]}} , \end{aligned} \quad (\text{III.281})$$

for $a \in \llbracket 1, N-1 \rrbracket$.

An important and interesting statement is then

$$\begin{aligned} T_{a,-1}^{[a-N/2]} & = e^{-E_a^{[+a-N/2]}} T_{a,1}^{[a-N/2]} \frac{\mathbb{Q}_{\bar{\theta}}^{[+N-1]} \mathbb{P}_{\bar{\theta}}^{[-N+1]}}{\mathbb{Q}_{\bar{\theta}}^{[+N+1]} \mathbb{P}_{\bar{\theta}}^{[-N-1]}} \\ & \quad \times \left(\frac{\mathbb{P}_{\bar{\theta}}^{[-2N-a+1]}}{\mathbb{P}_{\bar{\theta}}^{[+a-2N-1]}} \right)^{*K_N^{[+a-1]}} \left(\frac{\mathbb{Q}_{\bar{\theta}}^{[+2N+N-a+1]}}{\mathbb{Q}_{\bar{\theta}}^{[N+a-1]}} \right)^{*K_N^{[-N+a+1]}} , \end{aligned} \quad (\text{III.282})$$

which says that there is no zero-mode in the equation (III.281). To be more exact there can still be a phase $e^{2ik\pi/N}$, but the operation $f \rightsquigarrow f^{*K_N} \equiv \exp(K_N * \log f_a)$ itself is defined up to a phase $e^{2ik\pi/N}$, corresponding to the choice of the branch of the logarithm.

Exactly like for the zero-mode χ_{CDD} in the asymptotic expression (III.213) of $Y_{a,0}$, there is no complete proof of this statement, which should rather be viewed as a condition that we impose on the solution of the Y-system. It can be easily motivated by the fact that it reproduces the correct pole structure and analyticity strip for the Y-functions. In order to really prove that the zero-mode in (III.282) is exact, one should use a minimality principle for the number of zeroes of the $Y_{a,0}$ and it is not absolutely clear, whether or not this minimality principle follows from the present construction (and in particular from the regularity of the T -functions).

Relation to χ_{CDD} In the asymptotic limit ($L \rightarrow \infty$), we can use the expressions (III.205-III.207) of $T_{a,s}$, to say that inside the analyticity strips, we have

$$\mathbb{Q}_{\bar{\theta}} = T_{N,s}^{[-N/2]} = \varphi, \quad \mathbb{P}_{\bar{\theta}} = T_{0,s}^{[+N/2]} = \varphi. \quad (\text{III.283})$$

When we plug this into the equation (III.282), we can compute $Y_{a,0} = \frac{T_{a,1} T_{a,-1}}{T_{a+1,s} T_{a-1,s}}$ by explicitly computing the convolutions which appear in (III.282). Interestingly, that gives exactly (III.213), and we find that the factor χ_{CDD} is therefore reproduced by the equation (III.282). The factors \mathbf{S} and χ_{CDD} which appear in (III.213) are well defined only in the asymptotic limit, and we see that they now appear from the convolution of (the logarithm of) polynomial T -functions by the kernel K_N . At finite size, the T -functions are not polynomial anymore, but the convolution is still well defined for arbitrary size L .

In section III.3.2.4 we used the expression of $Y_{a,0}$ to find Bethe equations under the hypothesis that $Y_{1,0}(\theta_n + i\frac{N}{4}) = -1$, for any Bethe root θ_n . In the next section, we will see that at finite size, the generalization of the Bethe equations is obtained by a quite different method, but let us nevertheless elaborate on the hypothesis that in the asymptotic limit, $Y_{1,0}(\theta_n + i\frac{N}{4}) = -1$. In terms of T -functions, we know that

$$1 + Y_{1,0} \left(\mathbf{u} + i\frac{N}{4} \right) = \frac{T_{1,0}(\mathbf{u} + i\frac{N}{4} + \frac{i}{2}) T_{1,0}(\mathbf{u} + i\frac{N}{4} - \frac{i}{2})}{T_{2,0}(\mathbf{u} + i\frac{N}{4}) T_{0,0}(\mathbf{u} + i\frac{N}{4})}. \quad (\text{III.284})$$

The analyticity strips are such that in the numerator $T_{1,0}(\mathbf{u} + i\frac{N}{4} - \frac{i}{2}) \xrightarrow{L \rightarrow \infty} \varphi(\mathbf{u})$ when $\mathbf{u} \in \mathbb{R}$. That is because the argument $\mathbf{u} + i\frac{N}{4} - \frac{i}{2}$ is inside the analyticity strip $\mathbf{A}_{1+N/2}$ where the asymptotic expression (III.207) is valid. On the other hand in the denominator, the argument of $T_{0,0}(\mathbf{u} + i\frac{N}{4})$ stands at the very boundary of the analyticity strip (see (III.236)), and we cannot say that it converges to $\varphi(\mathbf{u})$. This is why it makes sense to expect that, in the asymptotic limit, $1 + Y_{1,0}(\mathbf{u} + i\frac{N}{4})$ has a zero at every root θ_n of the polynomial φ .

Equations on the densities The middle nodes equation, as rewritten in (III.282), can be inserted into the equation (III.276) for the densities. That gives

$$f_i = \frac{1}{\left| (d_{a,j})_{\substack{1 \leq a \leq N-1 \\ 2 \leq j \leq N}} \right|} \sum_{a=1}^{N-1} c_{i,a} e^{-E_a^{[+a-N/2]}} T_{a,1}^{[a-N/2]} \frac{\mathbb{Q}_{\bar{\emptyset}}^{[+N-1]} \mathbb{P}_{\bar{\emptyset}}^{[-N+1]}}{\mathbb{Q}_{\bar{\emptyset}}^{[+N+1]} \mathbb{P}_{\bar{\emptyset}}^{[-N-1]}} \\ \times \left(\frac{\mathbb{P}_{\bar{\emptyset}}^{[-2N-a+1]}}{\mathbb{P}_{\bar{\emptyset}}^{[+a-2N-1]}} \right)^{*K_N^{[+a-1]}} \left(\frac{\mathbb{Q}_{\bar{\emptyset}}^{[+2N+N-a+1]}}{\mathbb{Q}_{\bar{\emptyset}}^{[N+a-1]}} \right)^{*K_N^{[-N+a+1]}}. \quad (\text{III.285})$$

In this equation, all the functions in the right-hand-side are parameterized in terms of the densities f_i (and of the polynomial P_N). This means that this equation is a closed equation³⁵ on the densities f_i . This equation (III.285), which rewrites the middle nodes equation (III.202) in terms of the densities f_i , is convenient because the right-hand-side is made of $e^{-E_a^{[+a-N/2]}}$ (which is very small in the asymptotic limit), multiplied by several functions having a smooth limit when $L \rightarrow \infty$. As we will see, this makes the equation suitable for an iterative resolution.

³⁵More precisely, (III.285) is a set of $N - 1$ coupled equations on the $N - 1$ densities f_i . Indeed, we should write the equation (III.285) for each $i \in \llbracket 2, N \rrbracket$.

III.3.4.2 Equation on the polynomial P_N

As explained in section III.3.3.5, the q -functions are defined by the set of $N - 1$ functions f_2, f_3, \dots, f_N , and by the M relevant coefficients of the polynomial P_N .

We have just obtained the equation (III.285), which is a closed equation on the densities f_i . Actually, the same equation also fixes the polynomial P_N , if we require that the q -functions (and hence the densities $\equiv \mathfrak{q}_{\{i\}}(\mathbf{u}) - \mathfrak{p}_{\{i\}}(\mathbf{u})$) remain analytic. Indeed, this equation involves a division by the determinant $\left| \begin{matrix} (c_{i,a}) & 2 \leq i \leq N \\ & 1 \leq a \leq N-1 \end{matrix} \right|$. This determinant is a function of \mathbf{u} and we will see that for excited states, it has some zeroes³⁶. If this is the case, then the coefficients of the polynomial P_N should be fitted in such a way that these zeroes do not give rise to any pole in the functions f_i in the left-hand-side of (III.285).

Let us simply illustrate this on the case $N = 3$. We will see that for arbitrary L it gives an equation on the polynomial P_N , and that when L tends to ∞ , this equation reduces to the Bethe equation (III.218).

Finite size Bethe equations in the $N = 3$ case Let us consider a state in the $U(1)$ sector of the $SU(3) \times SU(3)$ principal chiral model, which has real asymptotic Bethe roots θ_n .

For such a state, the linear system (III.274) can be written as

$$\begin{pmatrix} A & B \\ \bar{A} & \bar{B} \end{pmatrix} \begin{pmatrix} f_2 \\ f_3 \end{pmatrix} = \begin{pmatrix} T_{1,-1}^{[-1/2]} \\ T_{2,-1}^{[+1/2]} \end{pmatrix}, \quad \text{where } \bar{A}(\bar{\mathbf{u}}) \equiv \overline{A(\mathbf{u})}. \quad (\text{III.286})$$

where³⁷ $A = \mathfrak{p}_{\{3\}}^{[-2]} - P_3$ and $B = P_2 - \mathfrak{p}_{\{2\}}^{[-2]}$.

By inverting the matrix $\begin{pmatrix} A & B \\ \bar{A} & \bar{B} \end{pmatrix}$, some singularity could occur at the zeroes of its determinant $A\bar{B} - \bar{A}B$, i.e. when the determinant is zero. If we want every f_i to be regular, we need the numerator to vanish (in (III.285)) at the same positions as the zeroes of the denominator, to cancel this pole. This gives the following finite size Bethe equation:

$$\begin{aligned} &\text{For every zero } \tilde{\theta}_j \text{ of } A\bar{B} - \bar{A}B, \\ &\begin{cases} T_{1,-1}(\tilde{\theta}_j - \mathfrak{i}/4)\bar{A}(\tilde{\theta}_j) &= T_{2,-1}(\tilde{\theta}_j + \mathfrak{i}/4)A(\tilde{\theta}_j) \\ T_{1,-1}(\tilde{\theta}_j - \mathfrak{i}/4)\bar{B}(\tilde{\theta}_j) &= T_{2,-1}(\tilde{\theta}_j + \mathfrak{i}/4)B(\tilde{\theta}_j) \end{cases} \quad (\text{III.287}) \end{aligned}$$

One can notice that at such $\tilde{\theta}_j$ the two conditions in the right-hand-side are equivalent (i.e. we have only one constraint for each $\tilde{\theta}_j$).

³⁶More precisely, we prove this statement in a vicinity of $L = \infty$, and we numerically checked it at finite size for several states when the size L is smaller.

³⁷The expressions $A = \mathfrak{p}_{\{3\}}^{[-2]} - P_3$ and $B = \mathfrak{p}_{\{2\}}^{[-2]} - P_2$ are obtained directly from (III.275), if we remember that $\mathfrak{p}_{\{1\}} = \mathfrak{q}_{\{1\}} = P_1 = 1$, and that the functions $\mathfrak{q}_{\{i\}}$ and $\mathfrak{p}_{\{i\}}$ are the complex conjugate of each other, in the sense of equation (III.253).

The $\tilde{\theta}_j$ are a finite size analogue of the Bethe roots θ_j . In particular we see that at large L , the roots of $A\bar{B} - \bar{A}B$ are precisely the Bethe roots. Indeed, at large L , $B \simeq \mathfrak{i}$ and $A \simeq P_3^{[-2]} - P_3$, giving $A\bar{B} - \bar{A}B \simeq -\mathfrak{i}(P_3^{[-2]} - P_3 + Pf[3][[+2]] - P_3) \simeq -\varphi$. This means that the roots $\tilde{\theta}_j$ coincide (in the asymptotic limit) with the roots θ_j of φ . Moreover, the complex-conjugacy relation (III.251), together with the limit $B \simeq \mathfrak{i}$, implies that the second relation in the right-hand-side of (III.287) reduces to the reality condition $\frac{T_{1,-1}(\tilde{\theta}_j - \mathfrak{i}/4)}{T_{1,-1}(\tilde{\theta}_j + \mathfrak{i}/4)} = -1$. Using the leading-order large L expression (III.213) of $Y_{a,0}$ in terms of \mathcal{S} and χ_{CDD} , we get at large L

$$T_{1,-1}(\mathbf{u} - \mathfrak{i}/4) \simeq \varphi^{[-2]} \frac{\varphi + 2\varphi^{[-2]}}{2\varphi \mathcal{S}^{[-2]}} e^{-L \cosh(\frac{2\pi}{3}(\mathbf{u} - \mathfrak{i}/4))} \quad (\text{III.288})$$

$$\text{where } \mathcal{S}(\mathbf{u}) = \prod_j S_0^2(\mathbf{u} - \theta_j) \chi_{\text{CDD}}(\mathbf{u} - \theta_j) \quad (\text{III.289})$$

Using the fact that $\varphi(\tilde{\theta}_i) = 0$ at each $\tilde{\theta}_i$ (in the asymptotic limit), and dividing by the complex conjugate, the large L regularity requirement becomes

$$\left. \frac{(\varphi^{[-2]})^2}{\varphi \mathcal{S}^{[-2]}} \frac{\varphi}{(\varphi^{[+2]})^2 \mathcal{S}^{[+2]}} \right|_{\mathbf{u}=\tilde{\theta}_j} e^{\mathfrak{i}L \sinh(\frac{2\pi}{3}\tilde{\theta}_j)} = -1 \quad (\text{III.290})$$

Using the crossing relation, the left-hand-side becomes simply $\mathcal{S}(\tilde{\theta}_j) e^{\mathfrak{i}L \sinh(\frac{2\pi}{3}\tilde{\theta}_j)}$, so that the finite size regularity condition stated above is equivalent at large L to the asymptotic Bethe equations (III.218).

For $N > 3$, one can also write finite size Bethe equations corresponding to the absence of poles for the q -functions, and check that they reproduce the asymptotic Bethe equations in the limit $L \rightarrow \infty$ (see [10KL]).

Iterative solution of the FiNLIE Let us now explain how to solve iteratively the finite set of non-linear integral equations (III.285), to obtain the finite-size spectrum of the principal chiral model. We should start by finding the asymptotic Bethe roots θ_j (hence the polynomial φ), and deducing a polynomial P_N which obeys (III.264). We also start with $f_i = 0$ (to match the asymptotic limit). Then, to solve the equation (III.285), we proceed iteratively: at each step, we compute the right-hand-side of (III.282) and the coefficients $d_{a,j}$ of (III.274), using the previous values of P_N and of the densities f_i (which parameterize the $T_{a,s}$ and the q -functions). Then we find the position of the zeroes of the numerator of (III.285), and update the polynomial P_N such that the denominator $\left| (c_{i,a})_{\substack{2 \leq i \leq N \\ 1 \leq a \leq N-1}} \right|$ has zeroes at the same position (which ensures that the right-hand-side of (III.285) has no pole). Finally we update the densities according to (III.285), and from these new densities we can start a new iteration. In its spirit this algorithm is a fix point algorithm, and if it converges, then the densities to which it converges are solutions of the equations (III.285).

If L is large enough, then one can prove that this algorithm converges³⁸, whereas when L is finite, we can find numerical evidence of a convergence, and find a numerical approximate solution.

III.3.5 Computation of the energy

In the previous sections, we have written the analyticity constraints on the T -functions which allow to completely constrain the q -functions and reduce the Y -system to a closed set of a finite number of equations.

In particular, we can see that the vacuum is a solution where the Y -functions do not have any zero or pole, whereas the excited states correspond to solutions which have several zeroes and poles. This was shown in the asymptotic limit in section III.3.2, where the poles of the Y -functions were given by the zeroes of the polynomial $\varphi \equiv Q_{[0]}(\mathbf{u})$. For the vacuum, $\varphi = 1$ has no zero, whereas it has zeroes for all the excited states. At finite size, the zeroes of the T -functions are modified, but it is a common belief (supported by our numerics) that for the vacuum, the Y -functions still have no pole when L is finite.

In the expression (III.52) of the energy, the existence of poles or zeroes of the function $1 + Y_{a,0}(\mathbf{u})$ requires to specify the integration contour for excited states.

In the section III.3.5.1 we will propose an expression for the energy of the excited states in the $U(1)$ sector. The guideline to write such an expression is that we will require the energy to be given by the same expression (III.52) as in the case of vacuum, except that the integration contour may be changed. We will require that this gives a real energy, which converges (when $L \rightarrow \infty$) to the asymptotic energy (III.23).

Then the section III.3.5.2 will discuss the numerical results and their consistency with known analytic results.

III.3.5.1 Expression of the energy of excited states

In order to generalize the expression (III.52) of the energy to excited states, let us first describe (at least when L is large enough) the singularities of the integrand $\cosh\left(\frac{2\pi}{N}\mathbf{u}\right) \log\left(1 + Y_{a,0}(\mathbf{u})\right)$.

To this end, let us denote by $\theta_j^{(a)}$ the zeroes of $T_{a,0}^{[-a+N/2]}$. In the asymptotic limit, $T_{a,0}^{[-a+N/2]} = \varphi$ and these zeroes coincide with the roots θ_j of φ . At finite size, by contrast, the zeroes $\theta_j^{(a)}$ of $T_{a,0}^{[-a+N/2]}$ are distinct in the sense that in general, the set $\left\{\theta_j^{(a)} \mid 1 \leq j \leq M\right\}$ depends on a .

This means that the function $1 + Y_{a,0}(\mathbf{u}) = \frac{T_{a,0}^+ T_{a,0}^-}{T_{a-1,0} T_{a+1,0}}$ has zeroes at positions $\theta_j^{(a)} + i/2(-a + N/2 \pm 1)$ and poles at position $\theta_j^{(a \pm 1)} + i/2(-a \pm 1 + N/2)$. When L is large, the sets $\left\{\theta_j^{(a)} \mid 1 \leq j \leq M\right\}$ almost coincide with the roots of φ , which means that in $1 + Y_{a,0}(\mathbf{u}) = \frac{T_{a,0}^+ T_{a,0}^-}{T_{a-1,0} T_{a+1,0}}$, each pole almost coincides with a zero. We also noticed

³⁸The convergence of the algorithm when L is large is obtained from the presence (in the equation (III.285)) of the factor $e^{-E_a^{[+a-N/2]}}$ which is very small. This factor means that we are looking for the fixed points of a function which is a contraction mapping, hence the convergence of the algorithm.

numerically (by iterating the algorithm given in section III.3.4) that even when L is small, the distance between the zeroes and the poles of $1 + Y_{a,0}(\mathbf{u}) = \frac{T_{a,0}^+ T_{a,0}^-}{T_{a-1,0} T_{a+1,0}}$ remains quite small (compared to $i/2$).

These zeroes and poles of $1 + Y_{a,0}(\mathbf{u})$ give rise to logarithmic singularities (branch points) in the integrand $\cosh\left(\frac{2\pi}{N}\mathbf{u}\right) \log(1 + Y_{a,0}(\mathbf{u}))$ of the expression (III.52) of the energy. In order to understand the impact of these singularities when the contour is modified, we can for instance rewrite the integral through an integration by parts:

$$E = \sum_{a=1}^{N-1} \frac{\sin \frac{\pi a}{N}}{\sin \frac{\pi}{N}} \int_{\mathbf{u} \in \mathbb{R}} \sinh\left(\frac{2\pi}{N}\mathbf{u}\right) \frac{\partial_{\mathbf{u}} Y_{a,0}}{1 + Y_{a,0}} \frac{d\mathbf{u}}{2\pi}. \quad (\text{III.291})$$

Then we see that if we denote by $\mathbf{z}_0 = \theta_j^{(a\pm 1)} + i/2(-a \pm 1 + N/2)$ the position of a pole of $Y_{a,s}$, then $\frac{\partial_{\mathbf{u}} Y_{a,0}}{1 + Y_{a,0}} \sim -\frac{1}{\mathbf{u} - \mathbf{z}_0}$ in the vicinity of $\mathbf{u} = \mathbf{z}_0$, hence the integrand has a pole with residue $\frac{-1}{2\pi} \sinh\left(\frac{2\pi}{N}\mathbf{z}_0\right)$. Similarly, if we denote by $\mathbf{z}_0 = \theta_j^{(a)} + i/2(-a \pm 1 + N/2)$ the position of a zero of $Y_{a,s}$, then $\frac{\partial_{\mathbf{u}} Y_{a,0}}{1 + Y_{a,0}} \sim \frac{1}{\mathbf{u} - \mathbf{z}_0}$ in the vicinity of $\mathbf{u} = \mathbf{z}_0$, hence the integrand has a pole with residue $\frac{1}{2\pi} \sinh\left(\frac{2\pi}{N}\mathbf{z}_0\right)$.

Having noticed this, we can try to find the correct integration contour, which we write below in the case when N is odd.

Case when N is odd If N is odd, then the function $1 + Y_{\frac{N-1}{2},0}$ has zeroes at position $\theta_j^{(\frac{N-1}{2})} + i/4 \pm i/2$ and it also has poles at position $\theta_j^{(\frac{N-1}{2} \pm 1)} + i/4 \pm i/2$. In particular, we will denote

$$\boldsymbol{\theta}_j \equiv \theta_j^{(\frac{N-1}{2})}. \quad (\text{III.292})$$

These $\boldsymbol{\theta}_j$ are the zeroes of $T_{\frac{N-1}{2},0}^{[+1/2]}$ and in the asymptotic limit, they converge to the Bethe roots. In finite size, we will call them the ‘‘finite size Bethe root’’³⁹ as they generalize the asymptotic Bethe roots. We can also notice that due to the complex-conjugacy relation (III.251), we have

$$\theta_j^{(\frac{N+1}{2})} = \overline{\boldsymbol{\theta}_j}. \quad (\text{III.293})$$

Let us then imagine a contour which encircles the zeroes $\{\boldsymbol{\theta}_j - i/4 | 1 \leq j \leq M\}$ of $1 + Y_{\frac{N-1}{2},0}$ and the zeroes $\{\overline{\boldsymbol{\theta}_j} + i/4 | 1 \leq j \leq M\}$ of $1 + Y_{\frac{N+1}{2},0}$. This choice, which we will

³⁹One should note that in this construction, several different objects tend to the Bethe roots in the limit $L \rightarrow \infty$. In the previous section, we defined the $\tilde{\theta}_j$, which obey finite size Bethe equations, and tend to the θ_j when L tends to ∞ . Here, we define another finite size version of the asymptotic Bethe roots, which enters the expression of the energy.

motivate below, gives the following expression of the energy

$$E(L) = -\frac{1}{N} \sum_{a=1}^{N-1} \frac{\sin(\frac{a\pi}{N})}{\sin(\frac{\pi}{N})} \int_{u \in \mathbb{R}} \cosh\left(\frac{2\pi}{N}u\right) \log(1 + Y_{a,0}(u)) du \\ + i \sum_j \frac{\cos\frac{\pi}{2N}}{\sin\frac{\pi}{N}} \left[\sinh\left(\frac{2\pi}{N}(\theta_j - i/4)\right) - \sinh\left(\frac{2\pi}{N}(\bar{\theta}_j + i/4)\right) \right]. \quad (\text{III.294})$$

In this expression, we have added the contribution of these singularities to the integral on the real axis. For instance the zero of $1 + Y_{\frac{N-1}{2},0}$ at position $\theta_j - i/4$ stands below the real axis, hence if the contour is deformed from the real axis to enclose this singularity, the deformation of the contour should enclose it counter-clockwise (see figure III.7). Hence this singularity contributes as $i \frac{\sin(\frac{N-1}{2}\frac{\pi}{N})}{\sin\frac{\pi}{N}} \sinh\left(\frac{2\pi}{N}(\theta_j - i/4)\right)$, as it can be seen from the integration by part (III.291). Using the same argument for the zero of $1 + Y_{\frac{N+1}{2},0}$ at position $\bar{\theta}_j + i/4$, we obtain⁴⁰ the expression (III.294) above.

Moreover, one can see that if θ_j has a positive imaginary part, then the following simple contour integration reproduces exactly the expression (III.294): (cf figure III.7)

$$E(L) = -\frac{1}{N} \sum_{a=1}^{N-1} \frac{\sin(\frac{a\pi}{N})}{\sin(\frac{\pi}{N})} \int_{u \in \mathbb{R} + i(\frac{\pi}{2} - \frac{\pi}{4})} \cosh\left(\frac{2\pi}{N}u\right) \log(1 + Y_{a,0}(u)) du. \quad (\text{III.295})$$

This case when θ_j has a positive imaginary part corresponds for instance to the first excited state, and more generally to the states having Bethe roots with even momentum number. In this statement, we call ‘‘momentum number’’ the integer κ such that in the Bethe equation (III.18), we have $2 \kappa \pi = i L \sinh\left(\frac{2\pi}{N}\theta_n\right) + \log(S(\theta_n))$. This can be shown at least when L is large enough, by the arguments which we will use in section III.3.5.3 to reproduce the ‘‘Lüscher correction’’, and we have no numerical evidence that the situation is different at smaller L .

The contour manipulation showing the equivalence of the expressions (III.295) and (III.294) (when θ_j has positive imaginary part) is illustrated in figure III.7, in the case $N = 3$.

For states where some θ_j have negative imaginary part, the contour (III.295) is not satisfactory anymore, and should be slightly deformed in the vicinity of the roots θ_j . With this deformation, we will still get the expression (III.294).

Let us now motivate the particular choice of the expression (III.294) for the energy:

- First of all, this expression is real. That is why the contour has to take into account the singularities θ_j and $\bar{\theta}_j$ on the same footing.
- Next, we see that in the asymptotic limit, θ_j becomes real. Then the term $\sinh\left(\frac{2\pi}{N}(\theta_j - i/4)\right) - \sinh\left(\frac{2\pi}{N}(\bar{\theta}_j + i/4)\right)$ becomes equal to $\cosh\left(\frac{2\pi}{N}\theta_n\right)$, and the sum (the second term in (III.294)) becomes equal to $\sum_j \cosh\left(\frac{2\pi}{N}\theta_j\right)$, as expected from (III.23). In this asymptotic limit, the integral term in (III.294) is exponentially small, and we recover the asymptotic expression of the energy.

⁴⁰To obtain (III.294) we also used the simplification $\sin\left(\frac{N-1}{2}\frac{\pi}{N}\right) = \cos\frac{\pi}{2N}$.

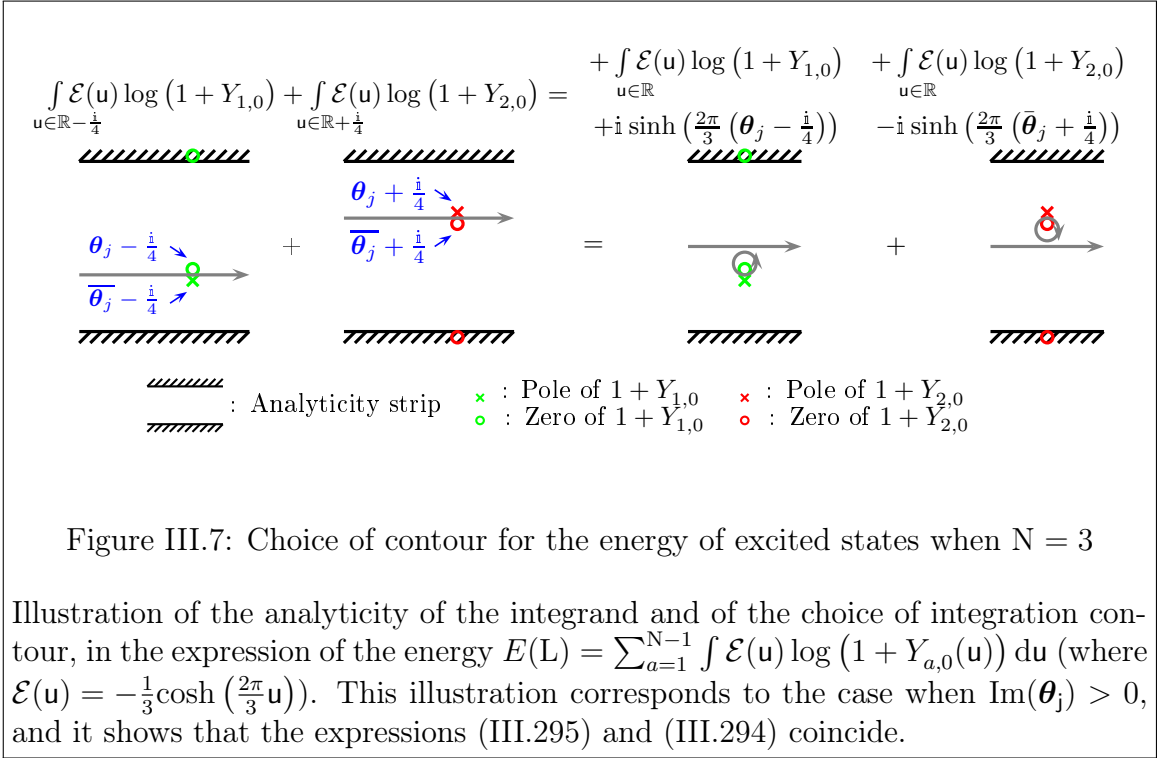

- The integration contour is natural enough in the sense that it remains inside the analyticity strip, and that it is not self-intersecting. This non-intersection condition was used in the discussion above to fix the natural sign of the contributions of the singularity. This condition can also be used to exclude contours which wind several times around the same singularity.
- At least for $N = 3$, the total number of non-intersecting contours is small: for each singularity of a Y-function, if the singularity lies inside the analyticity strip, then the contour goes either above or below this singularity. As the singularities of $1 + Y_{1,0}$ (resp $1 + Y_{2,0}$) are only at position $\theta_j - i/4$ and $\bar{\theta}_j - i/4$ (resp $\theta_j + i/4$ and $\bar{\theta}_j + i/4$) if we restrict to the interior of the analyticity strip, then one quickly sees that (III.294) is the only choice which obeys the above conditions and which reproduces the correct energy in the $L \rightarrow \infty$ limit.

If $N > 3$, (III.294) can be viewed as a natural generalization of the $N = 3$ case.

Case when N is even If N is even, then a contour can also be proposed which obeys the same naturality conditions. We proposed such a contour in [10KL]. As we will discuss in the next section, we actually did not yet manage to perform serious numerical and analytic checks of this expression when $N > 3$, and it should be viewed as one possible conjecture.

III.3.5.2 Numerical results

In order to check the consistency of the above construction, and to show the efficiency of the FiNLIE, we iterated numerically the algorithm given above to solve the Y-system. As the functions f_i decrease exponentially at large u , we could approximate them by functions with a finite support (i.e. we introduced a cutoff for the variables f_i). In practice these functions were internally defined by a polynomial interpolation from their values on a finite set of points (about 500 points) belonging to this finite support. The convolutions which appear in these FiNLIE are linear operators, and could be expressed through matrices. We could write the exact convolution of an interpolation function by the kernel K_N or the Cauchy kernel (which allows to compute the q -functions out of the densities f_i) as the multiplication⁴¹ by a matrix whose coefficients are known analytically. This allowed to iterate the FiNLIE algorithm at a reasonable speed.

When L is large enough, one can prove that the algorithm above does converge to a solution, because we find the fix point of a complicated function by iteratively defining $x_{n+1} = F(x_n)$. When L is large enough, F is a contraction mapping in some vicinity of $f_i = 0$, and the sequence x_n is therefore converging. Numerically, when L is large, we could indeed immediately notice that the algorithm converges to a solution which is very close to the asymptotic limit. Then, when the length L decreases, the algorithm looks worse and worse converging, and the densities become more and more peaked around the endpoints of the distribution. These endpoints are not artifacts from the cutoffs, but come simply from the fact that when L is small, $e^{-L\cosh(u)}$ is almost equal to one in a wide range of u (as long as $\cosh(u) \leq 1/L$) and then it quickly becomes very small when $\cosh(u) \gg 1/L$. It turned out that most of the non-trivial behavior of the Y -, T - and q -functions occurs precisely in a small vicinity of $u \simeq \operatorname{argcosh}(1/L)$. By choosing a small enough interpolation step⁴², it was nevertheless possible to make the algorithm reasonably convergent for several excited states in a range of length $10^{-3} \leq L \leq 100$, when $N = 3$. These results were written in [10KL], and they are presented in the figure III.8. They can be improved with respect to these results, and one can reach much smaller length L . These results should be soon available in the version 2 of [10KL].

Unfortunately, at $N \geq 4$ the calculations become heavier and (with the size of interpolation steps we can afford) our algorithm becomes unstable already for L of order ~ 1 (which means we cannot really check the conformal limit for instance). At the moment we cannot say whether this has a physical meaning (like some symmetry breaking down, or some new type of singularity appearing) or whether it is just a numerical artifact, due to a poor numerical accuracy, or to the choice of the equations. For instance, the function that we iterate may stop to be a contraction mapping but still have a fix point.

⁴¹As f_i is defined by its values at a finite number of positions, it is internally viewed as a vector. If functions are viewed as vectors, then the convolution is a linear operator which maps one vector to another one, hence it is described by a matrix-multiplication.

⁴²The algorithm searches for the fix point of a function F by defining $x_{n+1} = F(x_n)$, and saying that if x_n converges at $n \rightarrow \infty$, then its limit is a solution of $x = F(x)$. Then a trick which often improves the convergence is to define $x_{n+1} = \alpha F(x_n) + (1 - \alpha)x_n$, where $\alpha \in]0, 1]$. If this sequence converges, it also converges to a fix point of F .

In the numerical resolution of the FiNLIE, it was necessary to use this trick to get a satisfactory convergence when L is small.

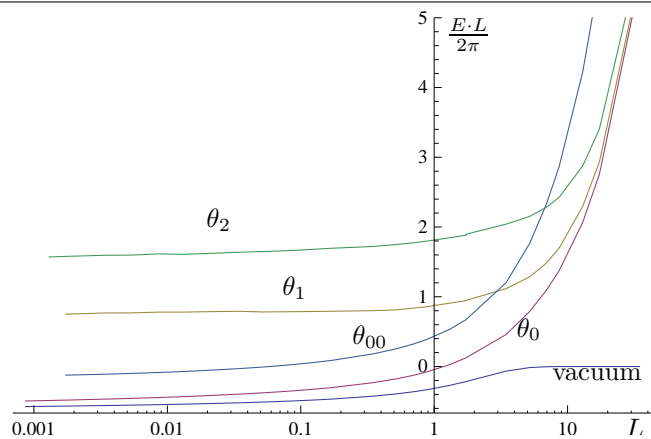

Figure III.8: Energies of the vacuum and of a few low-energy excited states, as functions of L , at $N = 3$.

This graph shows the energies of a few low-lying states in the $SU(3) \times SU(3)$ principal chiral model. The state labeled θ_0 (resp θ_1 resp θ_2) is the state with one particle, which has momentum number 0 (resp 1, resp 2). When the size L is large, this “momentum number” is the integer κ such that in the Bethe equation (III.18), we have $2 \kappa \pi = i L \sinh\left(\frac{2\pi}{N}\theta_n\right) + \log(S(\theta_n))$. On the other hand, the state labeled $\theta_{0,0}$ is the state with two particles, having momentum number 0.

We see that in the asymptotic limit ($L \rightarrow \infty$), the energy is equal to the number of particles, hence $\frac{EL}{2\pi}$ is linear in L and looks exponential in the logarithmic scale of this figure. By contrast, in the $L \rightarrow 0$ limit, $\frac{EL}{2\pi}$ goes to a constant, equal to $-\frac{2}{3}$ plus the sum of the momentum numbers.

One could for instance expect that for $N \geq 4$, if we rewrite slightly this function it could become a contraction again, and extracting its fix point would be possible by iterations.

III.3.5.3 Comparison with known limits

Once we have iterated and numerically solved the FiNLIE, we can check that it matches the known features of the principal chiral model.

Conformal limit The conformal limit is the limit where the length L is very small. In this limit, the action can be linearized giving rise to a 2-dimensional conformal theory with $N^2 - 1$ massless bosons.

As explained in [10KL], this linearization shows that when $L \ll 1$, the energy behaves like

$$E \sim \frac{2\pi}{L} \left(-\frac{N^2 - 1}{12} + \sum_j |n_j| \right) \quad (\text{III.296})$$

where n_j denotes the momentum number associated to the Bethe root θ_j . Our numerics are compatible with this result, as they show that when all particles have zero momentum, $E \frac{L}{2\pi}$ converges to $-2/3$, at a logarithmic speed. These numerics are also compatible with the fact that the states θ_1 and θ_2 have energies which behave like $\frac{2\pi}{L} (-1/3 + 1)$ and $\frac{2\pi}{L} (-1/3 + 2)$ respectively (see figure III.8).

In [10KL], we also computed the first correction to (III.296), and found a logarithmic speed of convergence which matches quite well our numerical results.

Asymptotic limit We already discussed the fact that by construction, the FiNLIE reproduces the known asymptotic limit ($L \rightarrow \infty$) of the principal chiral model. In fact one can perform deeper consistency checks of the large L behavior of the FiNLIE. More precisely there exists a general procedure, initiated by Lüscher [Lus86a, Lus86b] (see also [KM91]). This procedure allows to find the first corrections to the asymptotic energy (III.23) when the size L is large, but finite. Following [KM91], it is easy to show that when $N = 3$, these Lüscher corrections predict that the mass gap (the difference between the energy of the state denoted θ_0 on figure III.8 and the energy of the vacuum) is given by

$$E_{L \rightarrow \infty}^{\text{mass gap}} \simeq 1 - \left(\frac{32e^{-\sqrt{3}L/2\pi^3}}{\Gamma\left(\frac{1}{3}\right)^6} \right), \quad (\text{III.297})$$

where the term $\left(\frac{32e^{-\sqrt{3}L/2\pi^3}}{\Gamma\left(\frac{1}{3}\right)^6} \right)$ is a so-called μ -term.

Let us now show that this result can also be obtained analytically from our FiNLIE and from the prescription (III.294) for the energy. First we should note that when $N = 3$ it suffices to compute $Y_{1,0}$ in order to obtain the energy, because $Y_{2,0} = \overline{Y_{1,0}}$.

As we saw in the previous sections, $Y_{1,0}$ is given by (III.213), which reads

$$Y_{1,0} = e^{-L \cosh(\frac{2\pi}{N}u)} \frac{(T_{1,1})^2}{T_{0,0} T_{2,0}} \frac{\varphi^{[-3/2]}}{\varphi^{[+1/2]}} \frac{1}{(\mathcal{S}^2 \chi_{\text{CDD}})^{[-3/2]}} \quad (\text{III.298})$$

$$= e^{-L \cosh(\frac{2\pi}{N}u)} \left(\frac{3u + 5i/4}{u + i/4} \right)^2 \frac{1}{(\mathcal{S}^2 \chi_{\text{CDD}})^{[-3/2]}} \quad (\text{III.299})$$

where the last line is obtained by replacing the T -functions with their explicit value as it can be computed from section III.3.2.2.

At large L , this expression allows to compute the leading order of the integral term in (III.294). We see that this term is of the order $\mathcal{O}(e^{-L})$, which is much smaller than the μ -term $\frac{32e^{-\sqrt{3}L/2}\pi^3}{\Gamma(\frac{1}{3})^6}$ which we want to reproduce. This suggests that the second term in (III.294) gives the leading correction to the mass gap, as we will show now.

Finding the behavior of this term is a bit more tricky, as it involves the position of the Bethe root. This position can be estimated by computing the densities to the leading order, to deduce the first correction to $T_{1,0}$, in order to solve the equation $T_{1,0}(\theta_0 + i/4) = 0$.

For the mass gap, this root should be at the origin, up to exponential corrections in L . Moreover one can show⁴³ that $T_{1,0}(0 + i/4) \sim \frac{i}{6}f_2(0) + if_3(0) = \mathcal{O}(e^{-L\sqrt{3}/2})$, while $\partial_u T_{1,0}(0 + i/4) \sim i$, so that $T_{1,0}(\theta_0 + i/4) = 0$ gives $\theta_0 \sim -\frac{1}{6}f_2(0) - f_3(0)$. Using the asymptotic expression for f_j 's (which can be extracted by keeping only the asymptotic expressions of $T_{a,-1}$ and of $d_{a,j}$ in the formula (III.276)), one gets $\theta_0 \sim \frac{ie^{-\sqrt{3}L/2}\Gamma(-\frac{1}{3})^2\Gamma(\frac{2}{3})^2}{\sqrt{3}\pi\Gamma(\frac{1}{3})^2}$, so that the second term in (III.294), which is $\sinh(\frac{2\pi}{3}(\theta_0 - i/4)) - \sinh(\frac{2\pi}{3}(\theta_0 + i/4))$ can be computed at leading order.

That gives

$$E \simeq 1 - \left(\frac{32e^{-\sqrt{3}L/2}\pi^3}{\Gamma(\frac{1}{3})^6} \right), \quad (\text{III.300})$$

which coincides exactly with the μ -term of the Lüscher corrections, and this a good non-trivial test of the expression (III.294) of the energy.

Moreover, it is in good agreement with our numerical results, which is a consistency that the algorithm has no obvious mistake. The figure III.9 shows this consistency with the numerics, and we see that for this lowest-lying excited state, the Lüscher correction (III.297) gives a good approximation of the energy up to lengths of order one, while the expressions from the conformal limit give a good approximation when the length is smaller than (and up to) of order one.

⁴³These large L expressions are obtained by neglecting integral terms in the determinant expression of $T_{1,0}$.

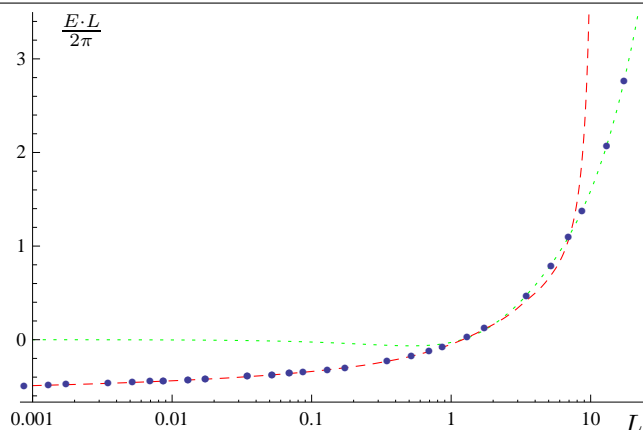

Figure III.9: Energy of the first excited state.

The numerical energy of the first excited state θ_0 (blue dots) is compared to the analytic expression (III.297) of $E_{L \rightarrow \infty}^{massgap}$ (green dotted line) and to the conformal limit $E_{\theta_0} = E_{vac} + \frac{8}{9} \frac{2\pi}{L} \frac{1}{\log(c/L) + \frac{1}{2} \log(\log(c/L))}$ (see [10KL]) (red dashed line), where $c = 12.3$ is chosen to fit the data.

III.4 Conclusion

For many integrable two-dimensional field theories (or “sigma models”), the TBA approach of Al. Zamolodchikov gives rise to a very universal system of functional equations, the Y-system. This Y-system is equivalent to the same Hirota equation which arises for spin chains in chapter II. The Hirota equation is associated to variables a and s belonging to a lattice which is fixed by the symmetry algebra of the model. In general, the Y-system equation is not sufficient to characterize and to solve a model, and some additional information, namely the analyticity properties with respect to the spectral parameter u must be specified.

As we saw, the typical solution of the Y-system for a large variety of lattices is parameterized by a finite set of q -functions (where the number of q -functions is essentially equal to the rank of the symmetry group), and the resolution of the Y-system reduces to finding the q -functions which reproduce the correct analyticity constraints on the Y-functions.

We illustrated this procedure in the case of the $SU(N) \times SU(N)$ principal chiral model, generalizing some results of [GKV09b] by using the q -functions, which provide, as we showed, the typical solution to the Y-system. Moreover, we showed how the additional analyticity constraints on the Y-functions are rewritten as natural constraints on the T - and q -functions. That allowed for instance to generalize to any finite size L the Bethe equations fixing the position of Bethe roots. We also saw that these analyticity conditions on the T -functions allowed, when the size L is large, to recover the asymptotic Bethe equations, including the factor χ_{CDD} in the phase of the \hat{S} -matrix.

The numerical and analytical checks that we performed confirm the consistency of the finite set of equations that we obtain, and of its iterative resolution, and in particular

for $N = 3$, the Lüscher corrections provide a serious check that the contour proposed and motivated in section III.3.5.1 to define the energy is very consistent.

At the present the numerics are still perfectible, and in particular it is left to understand why we have some convergence issues at length of order one when $N \geq 4$. This point would certainly be an important step in order to understand, at the level of the Y-system, the large N behavior of the principal chiral model, which exhibits a well-studied phase transition.

It would also be very enlightening to understand analytically how our FiNLIE behave in the conformal limit, and how they give rise to the analytic expressions known from conformal field theory.

In the next chapter we will see that in the example of the AdS/CFT duality the same approach also allows to write a FiNLIE. This shows that this procedure based on q -functions applies to several different models. We will see that a lot of work has to be done on a case-by-case basis, even though several common features arise.

Chapter IV

FiNLIE for the AdS/CFT Duality

In this chapter, we will see how the methods of the previous chapter can be applied to the Y-system of AdS/CFT.

This Y-system was conjectured in [GKV09a] and then understood in terms of the thermodynamic Bethe ansatz approach [BFT09, GKKV10, AF09], and it is believed to describe the exact scaling dimensions of the operators in the super Yang-Mills conformal field theory. Its derivation is conceptually slightly different to the Y-system of (for instance) the principal chiral model, because super Yang-Mills is not two-dimensional, and its integrability, comes out of a mapping between some operators (the single trace operators) and the states of an integrable spin chain.

This integrability was first noticed and understood in high-energy QCD [Lip94, FK95], and then in super Yang-Mills [MZ03, BS03, BKS03]. Inspired by the considerable activity in the string side of the duality [GKP02, FT02, Rus02, Min03, FT03, BMSZ03, ART04, AFRT03, BFST03, Kru05, KMMZ04], where integrability was also noticed [MSW02, BPR04], it was shown that integrability allowed to write Bethe equations for super Yang-Mills [BDS04, AFS04].

In order to write these Bethe equations, one key step is to find the \hat{S} -matrix. Like for the principal chiral model in chapter III, it turns out that this \hat{S} -matrix is fixed, up to an overall phase, by the symmetries of the model and consistency requirements [Sta05, BS05, Bei08]. This overall phase is fixed by a crossing equation which was identified in [Jan06].

The Y-system, which was conjectured from these Bethe equations, was successfully tested in both the weak coupling regime, (by comparison with perturbative expansion in super Yang-Mills [JL07, HJL08, BJ09, FSSZ08, Vel09, MOSS11, AFS10, BH10]), and in the strong coupling regime [Gro10]. On spectacular prediction of the Y-system, (latter checked against perturbative expansion in super Yang-Mills) was the prediction of the first subleading corrections to the dimension of the “Konishi operator” [GKV10, Fro11].

In this chapter, we will not see in great details how this Y-system was conjectured, but we will use it as the starting point of an analysis in terms of Q -functions. This analysis [11GKLV] is an original contribution of this PhD, and it allows to recast the infinite set of equations arising from the thermodynamic Bethe ansatz into a finite set of integral equations (FiNLIE).

The numbering of the sections follows the general road-map of section III.2.5, where the steps needed in order to write a FiNLIE for a given model are listed.

IV.1 The Y-system for AdS/CFT

The Y-system describing the energy spectrum of the AdS strings (or equivalently the scaling dimensions of super Yang-Mills operators) is reviewed for instance in [GK12]. It holds in the “planar limit” of super Yang-Mills, which is the limit when $N_c \rightarrow \infty$ and $\lambda \equiv g_{YM}^2 N_c$ is finite, where g_{YM} is the coupling constant of super Yang-Mills and N_c is the rank of the gauge group. The constant λ was introduced by ’t Hooft [Hoo74] who noticed that in this limit, all non-planar Feynman diagrams are suppressed. Therefore, λ is called the ’t Hooft coupling.

In this planar limit, the spectrum of AdS/CFT is given by the general Y-system

equation (III.54) on the lattice $\mathbb{T}(2, 2|2 + 2)$, which reflects the $\text{PSU}(2, 2|4)$ symmetry of the model. The dispersion relation is more subtle than for relativistic models: the massive particles (corresponding to the nodes at $s = 0$ in the Y-system) carry an energy and a momentum, given by

$$E_a \equiv a + \frac{2ig}{x^{[+a]}} - \frac{2ig}{x^{[-a]}}, \quad e^{ip_a} \equiv \frac{x^{[+a]}}{x^{[-a]}} \quad (\text{IV.1})$$

$$\text{where } x^{[\pm a]} \equiv x\left(\mathbf{u} \pm \frac{i}{2}a\right) \equiv \frac{1}{2} \left(\frac{\mathbf{u} \pm \frac{i}{2}a}{g} + i\sqrt{4 - \frac{(\mathbf{u} \pm \frac{i}{2}a)^2}{g^2}} \right), \quad (\text{IV.2})$$

where $g = \frac{\sqrt{\lambda}}{4\pi}$ is the coupling constant. In this expression, the function \sqrt{z} denotes the holomorphic function on $\mathbb{C} \setminus \mathbb{R}^-$ which coincides with the usual square root on \mathbb{R}^+ (i.e. the square root on the complex plane has a cut on \mathbb{R}^-). We see that the function $x(\mathbf{u})$ defined in (IV.2) obeys

$$x(\mathbf{u}) + \frac{1}{x(\mathbf{u})} = \frac{\mathbf{u}}{g}, \quad (\text{IV.3})$$

and that it has cuts on $] - \infty, -2g] \cup [2g, \infty[$ on the real axis¹. This function $x(\mathbf{u})$ can also be viewed as a double-valued function of \mathbf{u} , and (IV.2) gives its expression on a specific Riemann sheet. The function $1/x(\mathbf{u})$ corresponds to another sheet of the same double-valued function (because it also obeys (IV.3)), and it still has a cut on $\tilde{\mathbb{Z}}_0 \equiv] - \infty, -2g] \cup [2g, \infty[$. This cut of square-root type, associated to branch points at position $\pm 2g$, will be called Zhukovsky cuts. Another choice can for instance be

$$\hat{x}(\mathbf{u}) \equiv \frac{1}{2} \left(\frac{\mathbf{u}}{g} + \sqrt{\frac{\mathbf{u}}{g} - 2} \sqrt{\frac{\mathbf{u}}{g} + 2} \right) = \begin{cases} x(\mathbf{u}) & \text{if } \text{Im}(\mathbf{u}) > 0 \\ 1/x(\mathbf{u}) & \text{if } \text{Im}(\mathbf{u}) < 0 \end{cases}. \quad (\text{IV.4})$$

The choice (IV.4) has no cut on $[2g, \infty[$, but has a Zhukovsky cut $[-2g, 2g]$. It does not have a cut on $] - \infty, -2g]$ either, because the cuts from the two square roots compensate each other. This definition (IV.4) will be called the “magic branch” of $x(\mathbf{u})$, and more generally the “magic” sheet of multi-valued-functions will be a sheet² where all cuts are “short” i.e. of the form $[-2g, 2g]$ or $[-2g + \frac{i}{2}a, 2g + \frac{i}{2}a]$. On the other hand the definition (IV.2) will be called the “mirror” branch. This branch [AF07] is the most frequent in the study of the Y-system and will be simply denoted as $x(\mathbf{u})$ (the same symbol as the multi-valued function). These different branches of $x(\mathbf{u})$ are presented on figure IV.1.

¹These cuts correspond to $4 - \frac{u^2}{g^2} < 0$.

²One should notice that in general, the cut structure does not fix uniquely the Riemann sheet. Indeed, \hat{x} and $1/\hat{x}$ are two different determinations of x , which have the same cut structure, but correspond to distinct Riemann sheets.

In the literature, there exists another choice of sheet which has “short” cuts, like the magic branch and which is called “physical sheet”. For the function $x(\mathbf{u})$, it coincides with the “magic sheet”, and in what follows this “physical sheet” will not play an important role.

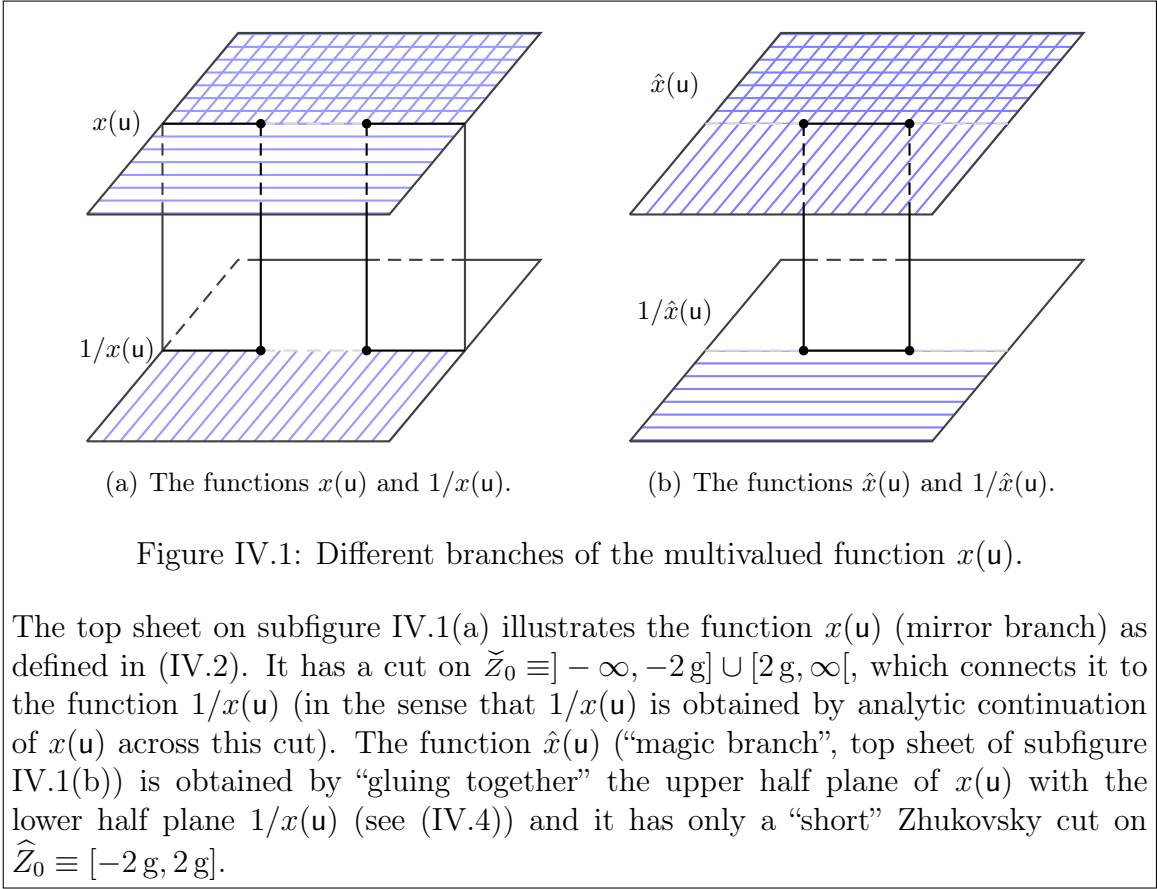

The top sheet on subfigure IV.1(a) illustrates the function $x(u)$ (mirror branch) as defined in (IV.2). It has a cut on $\tilde{Z}_0 \equiv]-\infty, -2g] \cup [2g, \infty[$, which connects it to the function $1/x(u)$ (in the sense that $1/x(u)$ is obtained by analytic continuation of $x(u)$ across this cut). The function $\hat{x}(u)$ (“magic branch”, top sheet of subfigure IV.1(b)) is obtained by “gluing together” the upper half plane of $x(u)$ with the lower half plane $1/x(u)$ (see (IV.4)) and it has only a “short” Zhukovsky cut on $\hat{Z}_0 \equiv [-2g, 2g]$.

The expression (IV.1-IV.2) of the dispersion relation is an expression in the mirror kinematics. One can also write this dispersion in another branch (called “physical”), where it reads

$$\hat{E}_a \equiv a + \frac{2ig}{\hat{x}^{[+a]}} - \frac{2ig}{\hat{x}^{[-a]}}, \quad e^{i\hat{p}_a} \equiv \frac{\hat{x}^{[+a]}}{\hat{x}^{[-a]}}. \quad (\text{IV.5})$$

Then, the AdS/CFT spectrum is obtained by solving the Y-system equation on the lattice $\mathbb{T}(2, 2|2+2)$, under some analyticity conditions which include the asymptotic behavior

$$Y_{a,0}(\mathbf{u}) \simeq \left(\frac{x^{[-a]}}{x^{[+a]}} \right)^L, \quad (\text{IV.6})$$

where L is the length of an operator³. Then the anomalous dimension γ of this operator is given by

$$\gamma = E - M, \quad \text{where } E = \sum_{j=1}^M \hat{E}_1(\mathbf{u}^{(j)}) + \sum_{a=1}^{\infty} \int_{\mathbf{u} \in \mathbb{R}} \frac{d\mathbf{u}}{2i\pi} \frac{\partial E_a(\mathbf{u})}{\partial \mathbf{u}} \log(1 + Y_{a,0}(\mathbf{u})), \quad (\text{IV.7})$$

³As mentioned in the introductory section (see for instance [Min12]) the super Yang-Mills operator $\text{tr}(XXYX)$ can be mapped to the state $|\uparrow\uparrow\downarrow\uparrow\rangle$ of an $SU(2)$ spin chain of size $L = 4$. Then $L = 4$ is called the “length” of this operator. The conformal dimension of this operator is then given by one solution of the Y-system, obeying the asymptotic behavior (IV.6) with $L = 4$.

where $E_a(\mathbf{u})$ (resp $\hat{E}_a(\mathbf{u})$) are defined in (IV.1) (resp (IV.5)), and where $\{\mathbf{u}^{(j)} | 1 \leq j \leq M\}$ is the set of the “momentum-carrying” Bethe roots (the analogue of the roots θ_j of the polynomial $Q_{[0]}(\mathbf{u})$ in the principal chiral model).

An important remark is that the Y-system equation must hold on the “mirror sheet” [AF07, GKKV10]. One cannot always continue analytically the Y-system equation to other sheets than the mirror sheet, and one can even show [11GKLV] that on the “magic” sheet, the Y-system equation takes a quite different form at $(a, s) = (1, 1)$ for instance.

To give a complete set of equations, the Y-system equation has to be supplemented with the asymptotic behavior (IV.6) and with conditions at the corner (namely, the function $Y_{1,1}$ has to be the analytic continuation of $1/Y_{2,2}$, as we will see in (IV.20)). For instance, the TBA-equations [GKKV10] contain these conditions, though they are hard to understand from the integral TBA equations. In this chapter we will see that in terms of the T -functions, a closed system of equations is obtained by imposing a few natural analyticity constraints [11GKLV].

IV.2 The asymptotic limit

The asymptotic limit ($L \rightarrow \infty$) is well presented in the Y-system literature (see for instance [GKV09a] or the review [GK12]). In this PhD, this limit was studied in [11GKLT] where we first wrote the Wronskian solution of the Hirota equation on a “T-hook” (the expressions (III.143-III.145)) and wrote the explicit expressions of all \mathcal{Q} -functions in the asymptotic limit.

In this section, we will not repeat the results of this article, but simply mention a few observations which arose in this study of the asymptotic limit. First of all let us briefly mention that the expressions of \mathcal{Q} -functions were obtained in this paper from the knowledge of the \mathcal{Q} -functions corresponding to a given nesting path. The $\mathcal{Q}\mathcal{Q}$ -relations were used to express all \mathcal{Q} -functions in terms of basis of nine⁴ \mathcal{Q} -functions (using (II.254)), and these nine functions were expressed out of the \mathcal{Q} -functions lying on the nesting path, using the $\mathcal{Q}\mathcal{Q}$ -relations. They are given by the formulae (5.6-5.9) (or (B.1-B.8) for the most general states) and proven in appendix B of [11GKLT].

We will not copy these formulae here, because they will not be used directly in what follows. Instead, let us summarize a few properties of the asymptotic solution, which were found in [11GKLT], and which correspond to symmetries of the Y-system.

Super-determinant A first nontrivial property of the asymptotic solution is that the ratio $\frac{\mathcal{Q}_\emptyset^+ \mathcal{Q}_{\bar{\emptyset}}^-}{\mathcal{Q}_{\bar{\emptyset}}^+ \mathcal{Q}_\emptyset^-}$ is equal to one. This relation means that there exists a gauge where $\mathcal{Q}_\emptyset = \mathcal{Q}_{\bar{\emptyset}} = 1$, i.e. where $T_{0,s} = 1$, in addition to the gauge constraints (III.81). In the absence of a non-trivial symmetry, there would a priori not always exist such a gauge where $T_{0,s} = 1$. Indeed, it is in general possible to choose $\mathcal{Q}_\emptyset = 1$ and that corresponds

⁴This set of nine \mathcal{Q} -functions is denoted as \mathcal{B}_2 in [11GKLT]. Using the gauge constraint $T_{0,s} = T_{0,0}^{[-s]}$ they can be reduced to a set of eight functions called \mathcal{B}_1 . As the definition of the Wronskian gauge fixes only three (out of four) gauge freedom, only seven of these eight functions are really independent.

to the gauge choice $T_{0,s} = T_{0,0}^{[-s]}$ in (III.81), but then, the remaining degree of gauge freedom⁵ takes the form $T_{a,s} \rightsquigarrow (g^{[s]_D})^{[a]_D}$. There g is an arbitrary function of \mathbf{u} , and

$$g^{[s]_D} \equiv \begin{cases} \prod_{n=-\frac{s-1}{2}}^{\frac{s-1}{2}} g^{[2n]}, & \text{if } s \geq 1, \\ 1 & \text{if } s = 0, \\ 1/g^{[-s]_D} & \text{if } s < 0. \end{cases} \quad (\text{IV.8})$$

Since $T_{0,s}$ is invariant under this transformation we see that $T_{0,s} = 1$ cannot be enforced by a gauge transformation. This means that the relation $\frac{\mathcal{Q}_0^+}{\mathcal{Q}_0^-} \frac{\mathcal{Q}_0^-}{\mathcal{Q}_0^+} = 1$ is not just obtained by a gauge transformation, but it is the manifestation of some symmetry. Interestingly enough, this relation can also be written in a gauge-invariant way as $Y_{1,-1} Y_{1,-2} = Y_{1,1} Y_{1,2}$. On this form, we see that this property is trivial for the states having the symmetry $Y_{a,s} = Y_{a,-s}$, and what we noticed in the asymptotic limit is that this constraint holds even for states which do not exhibit the symmetry $Y_{a,s} = Y_{a,-s}$.

In [11GKLT], we identified the physical meaning of the equality $\frac{\mathcal{Q}_0^+}{\mathcal{Q}_0^-} \frac{\mathcal{Q}_0^-}{\mathcal{Q}_0^+} = 1$, as the requirement that the group symmetry $\text{PSU}(2,2|4)$ only involves matrices with super-determinant equal to one.

More explicitly, there exists a limit called the classical limit (when $g \rightarrow \infty$), where the T -functions are the characters of a monodromy matrix $\Omega \in \text{PSU}(2,2|4)$, in some rectangular representations labeled by indices $(a, s) \in [\mathbb{T}(2, 2|2+2)]_T$ (see [GKT10]). As it belongs to $\text{PSU}(2,2|4)$, this matrix has its super-determinant equal to one.

This interpretation holds only in the $g \rightarrow \infty$ limit, but in the more general case of finite g , the \mathcal{Q} -functions can be viewed as a generalization of the eigenvalues of Ω , and the condition $\frac{\mathcal{Q}_0^+}{\mathcal{Q}_0^-} \frac{\mathcal{Q}_0^-}{\mathcal{Q}_0^+} = 1$ can be interpreted as the condition that the super-determinant of Ω is equal to one.

We see that although the symmetry groups $\text{PSU}(2,2|4)$ and $\text{U}(2,2|4)$ are associated to the Hirota equation on the same (a,s) -lattice $\mathbb{T}(2, 2|2+2)$, the $\text{PSU}(2,2|4)$ case gives rise to additional constraints on the T -functions. The same thing can be noticed in the setup of the chapter II: we have seen that a spin chain with symmetry $\text{GL}(K)$ or with symmetry $\text{SU}(K)$ gives rise to two T -operators which obey the Hirota equation on the same lattice. But the equation (III.72) shows that the relation $\mathbb{T}^{K,s}(\mathbf{u}) = \mathbb{T}^{0,0}(\mathbf{u} + s)$ is true only for $\text{SU}(K)$ spin chains (unless the twist takes a very specific value).

Structure of the right band Some other symmetries appear in the asymptotic limit, which we will illustrate here with the ‘‘right band’’ (when $s \geq a$) in the $\text{SL}(2)$ sector, for the simplicity of notations. This so-called $\text{SL}(2)$ sector [Min12], denotes the states having only one type of Bethe roots: the momentum carrying roots $\mathbf{u}^{(i)}$ which enter in

⁵Let us remind here that the gauge constraint (III.81) fixes only three out of the four degree of gauge freedom in (III.60).

the expression (IV.7) of the energy. This sector is analogous to the U(1) sector of the principal chiral model studied in section III.3.

In the asymptotic limit, we obtain (see formula (5.6) and (5.12) in [11GKLT])

$$\frac{\mathcal{Q}_{\{2\}}}{\mathcal{Q}_{\{1\}}} = -i\mathbf{u} + \frac{1}{2} \frac{\frac{B^{(+)}}{B^{(-)}} + 1}{\frac{B^{(+)}}{B^{(-)}} - 1}, \quad \frac{\mathcal{Q}_{\overline{\{1\}}}}{\mathcal{Q}_{\overline{\{2\}}}} = -i\mathbf{u} - \frac{1}{2} \frac{\frac{R^{(-)}}{R^{(+)}} + 1}{\frac{R^{(-)}}{R^{(+)}} - 1} = -i\mathbf{u} + \frac{1}{2} \frac{\frac{R^{(+)}}{R^{(-)}} + 1}{\frac{R^{(+)}}{R^{(-)}} - 1}, \quad (\text{IV.9})$$

$$\text{where } B^{(\pm)} \equiv \prod_{j=1}^M \sqrt{\frac{g}{\hat{x}_j^{\mp}}} \left(\frac{1}{x} - \hat{x}_j^{\mp} \right), \quad R^{(\pm)} \equiv \prod_{j=1}^M \sqrt{\frac{g}{\hat{x}_j^{\mp}}} (x - \hat{x}_j^{\mp}), \quad (\text{IV.10})$$

$$\text{and } \hat{x}_j^{\mp} \equiv \hat{x} \left(\mathbf{u}^{(j)} \mp \frac{i}{2} \right). \quad (\text{IV.11})$$

In view of the expression (III.143), this means that up to a gauge transformation, the right band of the \mathbb{T} -hook of AdS/CFT is given by

$$\forall s \geq 1, \quad T_{1,s} = \left| \begin{array}{cc} 1 & q^{[+s]} \\ 1 & \tilde{q}^{[-s]} \end{array} \right|, \quad \text{where } q \equiv \frac{\mathcal{Q}_{\{2\}}}{\mathcal{Q}_{\{1\}}} \text{ and } \tilde{q} \equiv \frac{\mathcal{Q}_{\overline{\{1\}}}}{\mathcal{Q}_{\overline{\{2\}}}} \quad (\text{IV.12})$$

In this asymptotic solution, we can notice a couple of properties:

- We see that $T_{a,s}$ is real and that $-\tilde{q}$ is the complex-conjugate of q (which is defined on the mirror-sheet). This property will still hold at finite size, and it simply comes from the reality of the Y-functions : by the same argument as in section III.3.3.5, the reality of the Y-functions allows to choose a gauge where the T -functions are real, and in turn this allows to choose \mathcal{Q} -functions which are complex-conjugated to each other, up to a sign (see for instance (5.12) in [11GKLT]). As the reality of Y-functions is not specific to the asymptotic limit, this property will still hold for arbitrary (finite) L , as we will discuss in section IV.3.1.3.
- As a function of \mathbf{u} , we see that $T_{1,s}$ is analytic on the whole complex plane, except on \check{Z}_s and \check{Z}_{-s} , where we use the notation

$$\check{Z}_n \equiv \left\{ x + i\frac{n}{2} \mid x \in]-\infty, -2g] \cup [2g, \infty[\right\}. \quad (\text{IV.13})$$

We see this analyticity property from the fact that (due to the function $x(\mathbf{u})$), the functions $B^{(\pm)}$ and $R^{(\pm)}$ are analytic on the whole complex plane except on \check{Z}_0 .

Moreover, when \mathbf{u} is large, we see that

$$T_{1,s} \xrightarrow{\mathbf{u} \rightarrow \infty} \alpha s \quad (\text{IV.14})$$

where α is a constant, independent of \mathbf{u} and s , which we can absorb into a gauge transformation if we wish. This means that

$$Y_{1,s} \xrightarrow{\mathbf{u} \rightarrow \infty} s^2 - 1 \quad (\text{IV.15})$$

- Another fact which was noticed in [11GKLT], is that the functions $\frac{\mathcal{Q}_{\{2\}}}{\mathcal{Q}_{\{1\}}}$ and $\frac{\mathcal{Q}_{\overline{\{1\}}}}{\mathcal{Q}_{\overline{\{2\}}}}$ are equal up to the replacement $B^{(\pm)} \leftrightarrow R^{(\pm)}$ (or equivalently $x \leftrightarrow 1/x$). Let us remind here that the Y-system equation holds in the mirror sheet, and that therefore the above expressions define $T_{1,s}$ in the mirror sheet.

Let us introduce

$$\hat{q} \equiv -i\mathbf{u} + \frac{1}{2} \frac{\frac{\hat{B}^{(+)}}{\hat{B}^{(-)}} + 1}{\frac{\hat{B}^{(+)} - 1}{\hat{B}^{(-)}}} \quad \text{and} \quad \hat{T}_{1,s} = \begin{vmatrix} 1 & \hat{q}^{[+s]} \\ 1 & \hat{q}^{[-s]} \end{vmatrix}, \quad (\text{IV.16})$$

$$\text{where } \hat{B}^{(\pm)} \equiv \prod_{j=1}^M \sqrt{\frac{g}{\hat{x}_j^{\mp}}} \left(\frac{1}{\hat{x}} - \hat{x}_j^{\mp} \right). \quad (\text{IV.17})$$

We can then notice that when $|\text{Im}(\mathbf{u})| < s/2$, we have $\hat{q}(\mathbf{u} + i\frac{s}{2}) = q(\mathbf{u} + i\frac{s}{2})$ and $\hat{q}(\mathbf{u} - i\frac{s}{2}) = \tilde{q}(\mathbf{u} - i\frac{s}{2})$ as we can see from the relation (IV.4) between x and \hat{x} . Hence we deduce that $\hat{T}_{1,s}$ coincides with $T_{a,s}$ when $|\text{Im}(\mathbf{u})| < s/2$.

This function $\hat{T}_{1,s}$ defines another sheet for the function $T_{1,s}$, which only differs from the mirror sheet when $|\text{Im}(\mathbf{u})| \geq s/2$. We see that it is analytic on the whole complex plane except on \hat{Z}_s and \hat{Z}_{-s} , where we use the notation

$$\hat{Z}_n \equiv \left\{ \mathbf{x} + i\frac{n}{2} \mid \mathbf{x} \in [-2g, 2g] \right\}. \quad (\text{IV.18})$$

This new choice of sheet exhibits the symmetry

$$\hat{T}_{1,s} = -\hat{T}_{1,-s}, \quad (\text{IV.19})$$

which we interpret as a generalization of the \mathbb{Z}_4 symmetry of the classical string theory on $AdS_5 \times S^5$ (see section IV.4.2). We will see that this symmetry is one of the fundamental analyticity properties which leads to our FinLIE.

As a last side remark about the right band, let us note that only the expression of $T_{1,s}$ is relevant, and it allows to express the product $T_{0,s} T_{2,s} = T_{1,s}^+ T_{1,s}^- - T_{1,s+1} T_{1,s-1}$. On the other hand, the individual expression of $T_{0,s}$ versus $T_{2,s}$ is much less relevant than their product, because there exist⁶ a gauge where $T_{0,s} = 1$ and another gauge where $T_{2,s} = 1$. Therefore, when we discuss the right band of the \mathbb{T} -hook, we will usually focus on $T_{1,s}$, and we may even omit to mention the existence of $T_{0,s}$ and $T_{2,s}$.

The structure of the upper band and the left band can also be analyzed in the same way. The left band is simply equal to the right band (up to a gauge transformation),

⁶ Indeed, $a = 0$ and $a = 2$, are boundaries of the (a,s)-lattice, which implies that we necessarily have $T_{0,s} = f_1^{[+s]} f_2^{[-s]}$ and $T_{2,s} = f_3^{[+s]} f_4^{[-s]}$ (for some functions f_1, \dots, f_4). Hence there exist a gauge where $T_{0,s} = 1$ (obtained as $(f_1^{[+s]} f_2^{[-s]})^{[a-1]D} T_{a,s}$) and another gauge where $T_{2,s} = 1$ (obtained as $(f_3^{[+s]} f_4^{[-s]})^{[1-a]D} T_{a,s}$), and these two gauges transformations leave $T_{1,s}$ invariant.

while the upper band has quite a degenerate structure in the asymptotic limit. This structure can be read from [11GKLT], and for instance it shows that there exists a gauge where $T_{a,1} = G^{[+a]} + \overline{G}^{[-a]}$, where G has essentially the same properties as the ratio $\frac{\mathcal{Q}_{\{2\}}}{\mathcal{Q}_{\{1\}}}$ of the right band: it is analytic on the whole complex plane except \check{Z}_0 , and is an imaginary polynomial when $u \rightarrow \infty$. The degree of this polynomial turns out to be equal to $M - 1$ where M is the number of Bethe roots.

Moreover it is possible, as in the case of the principal chiral model, to derive the Asymptotic Bethe equation [BDS04, AFS04] (including the crossing equation [Jan06]) from this asymptotic solution of the Y-system. This was already done in the first paper [GKV09a] conjecturing the Y-system of AdS/CFT. This derivation actually assumed that the zero-mode (denoted as ϕ in [GKV09a]) is a phase in the “physical sheet”. This condition can actually also be viewed as a consequence of the \mathbb{Z}_4 symmetry which we will use in our construction.

IV.3 Parameterization of the T - and q -functions

In this section, we will introduce the parameterization of the T - and q -functions which we will use to write the FiNLIE at any finite size L . As in the chapter III.3.3.5, this parameterization will arise by understanding the analyticity strips of all the Y-, T - and q -functions. Therefore we will start by quickly discussing this analyticity, in the section IV.3.1.

Then, we will deduce a parameterization of the q -functions, in the same spirit as in section III.3.3. The parameterization of the q -functions will involve a polynomial (corresponding to the $u \rightarrow \infty$ behavior, which will be extracted from the asymptotic limit), and a Cauchy integral (given by the Statement 8 (page 147)). In order to partially fix these polynomials, we will even restrict to states having two symmetric Bethe roots (i.e. $M = 2$ and $u^{(1)} = -u^{(2)}$).

IV.3.1 Analyticity strips

IV.3.1.1 Analyticity of the Y-functions

Like in the example of the principal chiral model in chapter III, one can find the analyticity strips of the various Y-functions out of the TBA-equations, or out of the Y-system equation, but if we want to derive them from the Y-system equation then we need to know additional constraints such as the asymptotic behavior (IV.6). The analyticity properties of the Y-functions were decrypted in the papers [CFT11, BH11a, BH11b]. In particular it was shown that if it is supplemented with these analyticity properties, then the Y-system equation becomes equivalent to the TBA-equations.

The most elementary analytic properties of the Y-functions, namely their analyticity strips, can be obtained by the same method which we used in section III.3.3.1 for the principal chiral model. In this section, there were a few nodes (the middle nodes) where the analyticity was limited by the asymptotic behavior, and the other Y-functions had

increasingly big analyticity strips when $|s|$ increased, i.e. when they were located further and further away from the middle nodes.

In the case of AdS/CFT, the asymptotic behavior (IV.6) prevents $Y_{a,0}$ from being analytic on a strip wider than \mathbf{A}_a , because $\left(\frac{x^{[-a]}}{x^{[+a]}}\right)^L$ has four branch points at positions $\pm 2g + i\frac{a}{2}$ and $\pm 2g - i\frac{a}{2}$. Hence, on the mirror sheet, this factor has cuts on \check{Z}_a and \check{Z}_{-a} , (where the notation \check{Z}_a was defined in (IV.13)).

One should note that in the principal chiral model, the factor $e^{-L \frac{\sin \frac{\pi a}{N}}{\sin \frac{\pi}{N}} \cosh(\frac{2\pi}{N} u)}$ was an analytic function for any finite L , and only its $L \rightarrow \infty$ limit was not analytic. By contrast the factor $\left(\frac{x^{[-a]}}{x^{[+a]}}\right)^L$ has branch points (and square root cuts) even when L is finite. Therefore the meaning of ‘‘analyticity strip’’ is slightly different from the case of the principal chiral model. These analyticity strips are now the biggest strip of the form \mathbf{A}_n , where the Y -functions are meromorphic. Inside these strips, one shows that the Y -functions have a well-defined limit when $L \rightarrow \infty$.

In addition to the statement that $Y_{a,0}$ behaves like $\left(\frac{x^{[-a]}}{x^{[+a]}}\right)^L$, another analyticity constraint must be used to fix these analyticity strips. This extra analyticity condition substitutes to the Y -system equation at $(a, s) = (2, \pm 2)$ (where this Y -system equation is ill-defined, as discussed in section III.2.1.3). It reads

$$\forall \mathbf{u} \in \check{Z}_0, \quad \begin{cases} Y_{1,1}(\mathbf{u} + i\epsilon) \xrightarrow[\epsilon \in \mathbb{R}]{\epsilon \rightarrow 0} 1/Y_{2,2}(\mathbf{u} - i\epsilon), & \text{(IV.20a)} \\ Y_{1,-1}(\mathbf{u} + i\epsilon) \xrightarrow[\epsilon \in \mathbb{R}]{\epsilon \rightarrow 0} 1/Y_{2,-2}(\mathbf{u} - i\epsilon). & \text{(IV.20b)} \end{cases}$$

This says that the Y -functions standing at position (a, s) such that $a = |s|$ (i.e. $(a, s) \in \{(1, 1), (2, 2), (1, -1), (2, -2)\}$) have a Zhukovsky cut on the real axis, and that the analytic continuation of $Y_{1,1}$ (resp $Y_{1,-1}$) through this Zhukovsky is $1/Y_{2,2}$ (resp $1/Y_{2,-2}$). This imposes that the analyticity strip of $Y_{1,\pm 1}$ and $Y_{2,\pm 2}$ reduces to $[-2g, 2g]$.

Then we can use the same arguments as in section III.3.3.1 to iteratively deduce the analyticity strips under the conditions (IV.6, IV.20). This way we obtain

$$\boxed{Y_{a,s} \in \mathcal{A}_{|a-|s||}^m}, \quad \text{(IV.21)}$$

$$\text{i.e. } Y_{a,0} \in \mathcal{A}_a^m, \quad Y_{a,\pm 1} \in \mathcal{A}_{a-1}^m, \quad Y_{1,s} \in \mathcal{A}_{|s|-1}^m. \quad \text{(IV.22)}$$

Remark One should note that the analyticity of the convolution kernels which appear in the TBA-equations [GKKV10] is quite complicated, and involves several Zhukovsky cuts. But the explicit expression of these kernels strongly suggest that the only possible branch points for the function $Y_{a,s}$ are $\{\pm 2g + i\frac{a+s}{2} + i n | n \in \mathbb{Z}\}$. We will therefore assume that outside its analyticity strip, the function $Y_{a,s}$ is still analytic except on

$$\bigcup_{n \in \mathbb{Z}} \check{Z}_{a+s+2n}.$$

In particular, we see that with these choices of cuts which correspond to the mirror sheet, $Y_{a,s}(\mathbf{u})$ is analytic when $|\text{Re}(\mathbf{u})| \leq 2g$.

Moreover (as suggested by the form of the convolution kernels appearing in the TBA-equations), we expect that the branch points are always of square root type. This assumption means that for any closed contour γ , $Y_{a,s} \left(\left[[\mathbf{u}]_\gamma \right]_\gamma \right) = Y_{a,s}$, where the notation $F \left([\mathbf{u}]_\gamma \right)$ denotes the analytic continuation of a function F following the contour γ from the point \mathbf{u} to the same point \mathbf{u} .

These two assumptions are very standard in this subject, and are used in all the Y-system literature. Therefore, we will also use them in the present manuscript.

IV.3.1.2 Analyticity of the T -functions

We can then deduce analyticity strips for the T -functions. In the case of the principal chiral model, we saw that there exists a gauge where the T -functions of the “right band” have a larger and larger analyticity strip when s increases (see (III.234)). We also saw that there exists another gauge where the T -functions of the “left band” are analytic inside a wider and wider strip as $-s$ increases (i.e. when we get further away from the middle nodes located at $s = 0$).

For AdS/CFT, if we deduce analyticity strips for T -functions out of the analyticity strips of the Y-functions, then the same general pattern appears: there exist gauges where the T -functions of the “upper band” (the domain where $a \geq |s|$, see figure III.6 (page 127)) have the analyticity strip

$$\underline{\mathbb{T}}_{a,s} \in \mathcal{A}_{a-|s|+1}. \quad (\text{IV.23})$$

There also exist other gauges where the T -functions of the “right band” (the domain where $s \geq a$, see fig III.6) have the analyticity strip

$$\overrightarrow{\mathbb{T}}_{a,s} \in \mathcal{A}_{s-a+1}. \quad (\text{IV.24})$$

Finally, there is a third type of gauges where the T -functions of the “left band” (the domain where $s \leq -a$, see fig III.6) have the analyticity strip

$$\overleftarrow{\mathbb{T}}_{a,s} \in \mathcal{A}_{-s-a+1}. \quad (\text{IV.25})$$

In these properties (IV.23- IV.25), the symbols $\underline{\mathbb{T}}_{a,s}$, $\overrightarrow{\mathbb{T}}_{a,s}$ and $\overleftarrow{\mathbb{T}}_{a,s}$ denote T -functions which differ only by the choice of the gauge.

IV.3.1.3 Analyticity strips for the q -functions

One can easily see that the analyticity strips for the T -functions would most naturally arise from having q -functions analytic on half planes, as in chapter III. More precisely, we will use two different gauges for the upper band and the right band, and only a subset of the 2^8 Q -functions of the general Wronskian expression (III.143-III.145) is analytic in each of these gauges. The Q -functions of this subset will be denoted by the letter q .

q -functions for the right band More explicitly we will use the following notations for a gauge (to be specified in the next paragraph) where the right band is analytic:

$$\forall s \geq 1, \quad \mathbb{T}_{\rightarrow 1, s} = \underline{q}_{\rightarrow\{1\}}^{[+s]} \underline{p}_{\rightarrow\{2\}}^{[-s]} - \underline{q}_{\rightarrow\{2\}}^{[+s]} \underline{p}_{\rightarrow\{1\}}^{[-s]}, \quad (\text{IV.26})$$

where the arrow under the q -functions denotes the fact that we write expressions in the gauge $\mathbb{T}_{\rightarrow a, s}$ which obeys (IV.24). As compared to the \mathcal{Q} -functions of the general Wronskian expression (III.143-III.145), we see that $\underline{q}_{\rightarrow\{1\}}$ (resp $\underline{q}_{\rightarrow\{2\}}$) denotes $\mathcal{Q}_{\{1\}}$ (resp $\mathcal{Q}_{\{2\}}$) in this specific gauge, while $\underline{p}_{\rightarrow\{1\}}$ (resp $\underline{p}_{\rightarrow\{2\}}$) denotes $\mathcal{Q}_{\overline{\{2\}}}$ (resp $\mathcal{Q}_{\overline{\{1\}}}$) in this gauge. They are analytic in the following half-planes

$$\underline{q}_{\rightarrow I} \quad \text{is analytic when} \quad \text{Im}(\mathbf{u}) > \frac{|I| - 1}{2} \quad (\text{and } I \subset \{1, 2\}) \quad (\text{IV.27})$$

$$\underline{p}_{\rightarrow I} \quad \text{is analytic when} \quad \text{Im}(\mathbf{u}) < \frac{1 - |I|}{2} \quad (\text{and } I \subset \{1, 2\}). \quad (\text{IV.28})$$

These analyticity strips are designed to reproduce exactly the analyticity strips of the functions $\mathbb{T}_{\rightarrow a, s}$ (see (IV.24)). As in section III.3, they can be deduced from the analyticity strips of the T -functions using the Baxter equation (III.102).

Moreover, the same arguments as in section III.3.3.5 allow to impose the reality of the functions $\mathbb{T}_{\rightarrow a, s}$. That even allows to impose, at the level of the q -functions, the following complex-conjugacy conditions:

$$\underline{p}_{\rightarrow\{1\}} = -\bar{\underline{q}}_{\rightarrow\{1\}}, \quad \underline{p}_{\rightarrow\{2\}} = \bar{\underline{q}}_{\rightarrow\{2\}}. \quad (\text{IV.29})$$

In view of our definition (III.250) of the complex-conjugate of a function, these relations mean for instance that for arbitrary $\mathbf{u} \in \mathbb{C}$, $\underline{p}_{\rightarrow\{1\}}(\mathbf{u})$ is the complex-conjugate of $\underline{q}_{\rightarrow\{1\}}(\bar{\mathbf{u}})$ (see the definition (III.250)). For T -functions, it gives

$$\forall s \geq 1, \quad \mathbb{T}_{\rightarrow 1, s} = \underline{q}_{\rightarrow\{1\}}^{[+s]} \bar{\underline{q}}_{\rightarrow\{2\}}^{[-s]} + \underline{q}_{\rightarrow\{2\}}^{[+s]} \bar{\underline{q}}_{\rightarrow\{1\}}^{[-s]}. \quad (\text{IV.30})$$

Moreover, as mentioned in section IV.2, the expression of $\mathbb{T}_{\rightarrow 0, s}$ is not very relevant and can be arbitrarily changed by a gauge transformation which leaves $\mathbb{T}_{\rightarrow 1, s}$ invariant. Therefore, we can choose

$$\mathbb{T}_{\rightarrow 0, s} = 1. \quad (\text{IV.31})$$

In that case, $\mathbb{T}_{\rightarrow 2, s} = \mathbb{T}_{\rightarrow 1, s}^+ \mathbb{T}_{\rightarrow 1, s}^- - \mathbb{T}_{\rightarrow 1, s+1} \mathbb{T}_{\rightarrow 1, s-1}$ gives

$$\forall s \geq 2, \quad \mathbb{T}_{\rightarrow 2, s} = \left(\underline{q}_{\rightarrow\{1\}}^+ \underline{q}_{\rightarrow\{2\}}^- - \underline{q}_{\rightarrow\{1\}}^- \underline{q}_{\rightarrow\{2\}}^+ \right)^{[+s]} \left(\bar{\underline{q}}_{\rightarrow\{1\}}^- \bar{\underline{q}}_{\rightarrow\{2\}}^+ - \bar{\underline{q}}_{\rightarrow\{1\}}^+ \bar{\underline{q}}_{\rightarrow\{2\}}^- \right)^{[-s]}. \quad (\text{IV.32})$$

q -functions for the upper band For the upper band, we can find a gauge where the T have analyticity strips given by (IV.23), and we will see that we can even choose the q -functions to be analytic on half-planes. In this gauge, we have

$$\forall a \geq |s|, \quad \mathbb{T}_{\square a, s} = \underline{\mathbf{q}}_{\square(2-s)}^{[+a]} \wedge \underline{\mathbf{p}}_{\square(2+s)}^{[-a]}, \quad (\text{IV.33})$$

where the brace symbol under the q -functions emphasizes the choice of the gauge $\underline{T}_{a,s}$ which obeys (IV.23). As compared to the Q -functions (or actually the forms built out of the Q -functions) of the general Wronskian expression (III.158-III.160), we see that $\underline{q}_{(n)}$ can be viewed as $\underline{Q}_{1,2,(n)}$, whereas $\underline{p}_{(n)}$ corresponds to $\underline{Q}_{(n),7,8}$. But we can equivalently view them as the exterior forms which allow to rewrite the Statement 4 (page 116) as the equation (III.116). They are then defined⁷ as

$$\underline{q}_{(1)} \equiv \sum_{i=1}^4 \underline{q}_i \xi_i, \quad \underline{p}_{(1)} \equiv \sum_{i=1}^4 \underline{p}_i \xi_i, \quad \underline{q}_{(0)} \equiv \underline{q}_\emptyset, \quad \underline{p}_{(0)} \equiv \underline{p}_\emptyset \quad (\text{IV.34})$$

$$\underline{q}_{(n)} \equiv \frac{\underline{q}_{(1)}^{[+n-1]} \wedge \underline{q}_{(1)}^{[+n-3]} \wedge \underline{q}_{(1)}^{[+n-5]} \wedge \cdots \wedge \underline{q}_{(1)}^{[-n+1]}}{\underline{q}_\emptyset^{[-n+2]} \underline{q}_\emptyset^{[-n+4]} \cdots \underline{q}_\emptyset^{[n-2]}}, \quad n > 1, \quad (\text{IV.35})$$

$$\underline{p}_{(n)} \equiv \frac{\underline{p}_{(1)}^{[+n-1]} \wedge \underline{p}_{(1)}^{[+n-3]} \wedge \underline{p}_{(1)}^{[+n-5]} \wedge \cdots \wedge \underline{p}_{(1)}^{[-n+1]}}{\underline{p}_\emptyset^{[-n+2]} \underline{p}_\emptyset^{[-n+4]} \cdots \underline{p}_\emptyset^{[n-2]}}, \quad n > 1, \quad (\text{IV.36})$$

and their coordinates obey the QQ-relations (see chapter III, and [Woy83, BCFH92, Tsu98, BHK02b, PS00, DDM⁺07, BDKM07, BT08, KSZ08, Zab08, GS03, GV08, 11GKLT])

$$\underline{q}_{\dots,j,k} \underline{q}_{\dots} = \underline{q}_{\dots,j}^+ \underline{q}_{\dots,k}^- - \underline{q}_{\dots,j}^- \underline{q}_{\dots,k}^+, \quad (\text{IV.37})$$

$$\underline{p}_{\dots,j,k} \underline{p}_{\dots} = \underline{p}_{\dots,j}^+ \underline{p}_{\dots,k}^- - \underline{p}_{\dots,j}^- \underline{p}_{\dots,k}^+, \quad (\text{IV.38})$$

where “...” stands for an arbitrary set of indices.

Then, if we want the expression (IV.33) to reproduce the analyticity strips (IV.23), it is natural to guess that

$$\underline{q}_{(n)} \quad \text{is analytic when} \quad \text{Im}(u) > -\frac{1}{2} + \left| \frac{n-2}{2} \right|, \quad (\text{IV.39})$$

$$\underline{p}_{(n)} \quad \text{is analytic when} \quad \text{Im}(u) < \frac{1}{2} - \left| \frac{n-2}{2} \right|. \quad (\text{IV.40})$$

Indeed, we see that if (IV.39-IV.40) hold, then $\underline{q}_{(s-2)}^{[+a]}$ (resp $\underline{p}_{(2-s)}^{[-a]}$) is analytic when $\text{Im}(u) > -\frac{1+a-|s|}{2}$ (resp $\text{Im}(u) < \frac{1+a-|s|}{2}$), and hence $\underline{T}_{a,s} = \underline{q}_{(s-2)}^{[+a]} \wedge \underline{p}_{(2-s)}^{[-a]} \in \mathcal{A}_{a-|s|+1}$.

⁷ Here we should notice that the sign of the shifts in the spectral parameter is changed compared to (III.113,III.114). This change is aimed at reminding that in the original Wronskian expression (III.143-III.145) for the whole “T-hook” $\mathbb{T}(2, 2|2+2)$, these q -functions, associated to the upper band, are associated to indices with grading $(-1)^{p_j} = -1$. This means that the QQ-relation has a sign (see (III.154)), which differs from (III.120).

This overall sign, which has no deep meaning and can be absorbed into a gauge transformation, reproduces the sign of [11GKLV].

The conditions (IV.39-IV.40) are therefore a very natural guess and one can actually prove that a choice of q -functions obeying (IV.39-IV.40) does exist (see appendix D.6 in [11GKLV]).

Moreover, the same arguments as in section III.3.3.5 allow to impose the reality of the functions $\mathbb{T}_{a,s}$. That even allows to impose, at the level of the q -functions, the following complex-conjugacy conditions:

$$\mathbb{p}_{\emptyset}^- = \overline{\mathbb{q}_{\emptyset}}, \quad \mathbb{p}_{234} = \overline{\mathbb{q}_2}, \quad \mathbb{p}_{134} = -\overline{\mathbb{q}_1}, \quad \mathbb{p}_{124} = \overline{\mathbb{q}_4}, \quad \mathbb{p}_{123} = -\overline{\mathbb{q}_3}, \quad (\text{IV.41})$$

$$\mathbb{p}_{34} = \overline{\mathbb{q}_{12}}, \quad \mathbb{p}_{23} = -\overline{\mathbb{q}_{23}}, \quad \mathbb{p}_{14} = -\overline{\mathbb{q}_{14}}, \quad \mathbb{p}_{24} = \overline{\mathbb{q}_{24}}, \quad \mathbb{p}_{13} = \overline{\mathbb{q}_{13}}, \quad \mathbb{p}_{12} = \overline{\mathbb{q}_{34}}. \quad (\text{IV.42})$$

where the notation \overline{f} denote the function $u \mapsto \overline{f(\overline{u})}$ (where f is an arbitrary holomorphic function). Let us also remind that in these expressions the function $\mathbb{q}_{i_1, i_2, \dots, i_n}$ (resp $\mathbb{p}_{i_1, i_2, \dots, i_n}$) denotes the coefficient of $\xi_{i_1} \wedge \xi_{i_2} \wedge \dots \wedge \xi_{i_n}$ in $\mathbb{q}_{(n)}$ (resp $\mathbb{p}_{(n)}$).

These expressions (proven in appendix D.8 in [11GKLV]), are designed to produce real T -functions: with the relations (IV.41), we obtain real expressions for $\mathbb{T}_{a,1}$ and $\mathbb{T}_{a,2}$:

$$\forall a \geq 2, \quad \mathbb{T}_{a,2} = \mathbb{q}_{\emptyset}^{[+a]} \overline{\mathbb{q}_{\emptyset}^{[-a]}}, \quad (\text{IV.43})$$

$$\forall a \geq 1, \quad \mathbb{T}_{a,1} = \mathbb{q}_1^{[+a]} \overline{\mathbb{q}_2^{[-a]}} + \mathbb{q}_2^{[+a]} \overline{\mathbb{q}_1^{[-a]}} + \mathbb{q}_3^{[+a]} \overline{\mathbb{q}_4^{[-a]}} + \mathbb{q}_4^{[+a]} \overline{\mathbb{q}_3^{[-a]}}. \quad (\text{IV.44})$$

On the other hand, the qq-relations allow to derive⁸ (IV.42) from (IV.41), and to get

$$\forall a \geq 0, \quad \mathbb{T}_{a,0} = \mathbb{q}_{12}^{[+a]} \overline{\mathbb{q}_{12}^{[-a]}} - \mathbb{q}_{13}^{[+a]} \overline{\mathbb{q}_{24}^{[-a]}} - \mathbb{q}_{14}^{[+a]} \overline{\mathbb{q}_{23}^{[-a]}} - \mathbb{q}_{23}^{[+a]} \overline{\mathbb{q}_{14}^{[-a]}} - \mathbb{q}_{24}^{[+a]} \overline{\mathbb{q}_{13}^{[-a]}} + \mathbb{q}_{34}^{[+a]} \overline{\mathbb{q}_{34}^{[-a]}}. \quad (\text{IV.45})$$

In the same way, we can write expressions for the p -functions with three or four indices, by using the qq-relations. That also gives rise to the following real expressions for $\mathbb{T}_{a,-1}$ and $\mathbb{T}_{a,-2}$

$$\forall a \geq 1, \quad \mathbb{T}_{a,-1} = \mathbb{q}_{123}^{[+a]} \overline{\mathbb{q}_{124}^{[-a]}} + \mathbb{q}_{124}^{[+a]} \overline{\mathbb{q}_{123}^{[-a]}} + \mathbb{q}_{134}^{[+a]} \overline{\mathbb{q}_{234}^{[-a]}} + \mathbb{q}_{234}^{[+a]} \overline{\mathbb{q}_{134}^{[-a]}} \quad (\text{IV.46})$$

These reality conditions say that $\mathbb{p}_{(n)}$ is the complex conjugate of $\mathbb{q}_{(4-n)}$, up to a transformation of the form (III.166-III.167), where the matrix H only has a few nonzero coefficients, which are equal to ± 1 (see [11GKLV]).

Moreover, if we restrict to symmetric states where $Y_{a,s} = Y_{a,-s}$ (like in the $SL(2)$ sector), then we know (from 7) that there exists a gauge transformation which transforms $\mathbb{T}_{a,s}$ into $\mathbb{T}_{a,-s}$. One can actually show (see appendix D.8. of [11GKLV]) that a

⁸For instance, one gets $\mathbb{p}_{14} = \frac{\mathbb{p}_{143}^+ \mathbb{p}_{142}^- - \mathbb{p}_{143}^- \mathbb{p}_{142}^+}{\mathbb{p}_{1432}} = \frac{\overline{\mathbb{q}_1^+} \overline{\mathbb{q}_4^-} - \overline{\mathbb{q}_1^-} \overline{\mathbb{q}_4^+}}{\overline{\mathbb{q}_{\emptyset}}} = -\overline{\mathbb{q}_{14}}$ from the qq-relation (or the determinant expression (IV.36)). The same argument allows to derive each expression in (IV.42).

transformation of the form (III.166-III.167) on the q -functions allows to also impose

$$\underline{\mathbf{q}}_{123} = U^2 \underline{\mathbf{q}}_1, \quad \underline{\mathbf{q}}_{124} = U^2 \underline{\mathbf{q}}_2, \quad (\text{IV.47a})$$

$$\underline{\mathbf{q}}_{134} = U^2 \underline{\mathbf{q}}_3, \quad \underline{\mathbf{q}}_{234} = U^2 \underline{\mathbf{q}}_4, \quad \underline{\mathbf{q}}_{\emptyset} = (U^+ U^-)^2 \underline{\mathbf{q}}_{\emptyset}, \quad (\text{IV.47b})$$

$$\underline{\mathbf{T}}_{a,-s} = \left(\left(U^{[+a]} \bar{U}^{[-a]} \right)^{[-s]D} \right)^2 \underline{\mathbf{T}}_{a,s}, \quad (\text{IV.47c})$$

where U is a function of \mathbf{u} , which is analytic when $\text{Im}(\mathbf{u}) \geq 0$, and we see that it defines the relation between $\underline{\mathbf{T}}_{a,-s}$ and $\underline{\mathbf{T}}_{a,s}$. In this statement, the non-trivial claim is that the transformation of the form (III.166-III.167) used to ensure the relation (IV.47) does not spoil the complex-conjugacy relations (IV.41).

Gauge freedom The requirements above do not fix completely the gauge $\underline{\mathbf{T}}$, and one can easily see that we still have one degree of gauge freedom for the right band and two degrees of gauge freedom for the upper band. These degrees of freedom take the form

$$\underline{\mathbf{q}}_{\{1\}} \rightsquigarrow g_1 \underline{\mathbf{q}}_{\{1\}}, \quad \underline{\mathbf{q}}_{\{2\}} \rightsquigarrow g_1 \underline{\mathbf{q}}_{\{2\}}, \quad \underline{\mathbf{T}}_{1,s} \rightsquigarrow g_1^{[+s]} g_1^{[-s]} \underline{\mathbf{T}}_{1,s}, \quad (\text{IV.48})$$

$$\underline{\mathbf{q}}_{(n)} \rightsquigarrow g_2^{[+n]} g_3^{[-n]} \underline{\mathbf{q}}_{(n)}, \quad \underline{\mathbf{T}}_{a,s} \rightsquigarrow g_2^{[+s-2]} g_3^{[+2-s]} g_2^{[+2-s]} g_3^{[+s-2]} \underline{\mathbf{T}}_{a,s}. \quad (\text{IV.49})$$

where $g_1(\mathbf{u})$, $g_2(\mathbf{u})$ and $g_3(\mathbf{u})$ are analytic when $\text{Im}(\mathbf{u}) > 0$.

Remark Like in the section III.3.3 where we studied the case of the $\text{SU}(N) \times \text{SU}(N)$ principal chiral model, we see that the q -functions are analytic inside half planes. This result is a manifestation of the fact that the analyticity strips for the Y -functions grow with $|s|$ (resp with a) in the “right band” and the “left band” (resp the “upper band”) of the \mathbb{T} -hook. There actually exist other Y -systems (for instance for the amplitudes of AdS/CFT [GMSV11]) which do not obey these properties, and it would be interesting to see how much the properties above would differ for these Y -systems.

IV.3.2 Parameterization of the q -functions

Let us now specify more precisely the gauges $\underline{\mathbf{T}}_{a,s}$ and $\underline{\mathbf{T}}_{\rightarrow a,s}$ considered above. In addition to the analyticity strips found above, we can impose the behavior at $\mathbf{u} \rightarrow \infty$. Indeed, one can notice that when $\mathbf{u} \rightarrow \infty$,

$$\left(\frac{x^{[-a]}}{x^{[+a]}} \right)^L \sim \left(\frac{g/\mathbf{u}}{\mathbf{u}/g} \right)^L \quad \text{when } |\text{Im}(\mathbf{u})| < \frac{a}{2} \text{ and } |\mathbf{u}| \rightarrow \infty. \quad (\text{IV.50})$$

We see that the factor $\left(\frac{x^{[-a]}}{x^{[+a]}} \right)^L$, which defines the asymptotic behavior of $Y_{a,0}$ is the only place where L appears, and the limit $L \rightarrow \infty$ makes this factor very small (because $\left| \frac{x^{[-a]}}{x^{[+a]}} \right| < 1$). As this factor is already small in the limit $|\mathbf{u}| \rightarrow \infty$, we see that the limit $\mathbf{u} \rightarrow \infty$ should be essentially independent on L .

Hence we expect that the features of the Y-functions should be the same in the $\mathbf{u} \rightarrow \infty$ limit as in the $L \rightarrow \infty$ case.

Exactly like in the case of the principal chiral model, we can use this argument to fix the polynomial behavior of the q -functions, which dominates at $\mathbf{u} \rightarrow \infty$, and to which an integral term will be added, exactly like in (III.259). The polynomial terms can be extracted from the asymptotic limit which was briefly discussed in section IV.2 (see [11GKLT] for more details).

q -functions in the right band Like in section III.3.3, the large \mathbf{u} behavior allows the following parameterization⁹:

$$\boxed{\underline{q}_{\{1\}} = 1, \quad \underline{q}_{\{2\}} = -i\mathbf{u} + \mathcal{K} * \rho \equiv -i\mathbf{u} + \frac{1}{2i\pi} \int_{\mathbf{v} \in \mathbb{R}} \frac{\rho(\mathbf{v})}{\mathbf{v} - \mathbf{u}} d\mathbf{v},} \quad (\text{IV.51})$$

where $\rho = \underline{q}_{\{2\}} + \overline{\underline{q}_{\{2\}}}$ is a real function on the real axis. More precisely the parameterization of $\underline{q}_{\{2\}}$ should be understood as

$$-i\mathbf{u} + \frac{1}{2i\pi} \int_{\mathbf{v} \in \mathbb{R}} \frac{\rho(\mathbf{v})}{\mathbf{v} - \mathbf{u}} d\mathbf{v} = \begin{cases} \underline{q}_{\{2\}}(\mathbf{u}) & \text{if } \text{Im}(\mathbf{u}) > 0 \\ -\overline{\underline{q}_{\{2\}}}(\mathbf{u}) & \text{if } \text{Im}(\mathbf{u}) < 0. \end{cases} \quad (\text{IV.52})$$

Polynomial behavior One should note that the asymptotic limit ($L \rightarrow \infty$) only specifies the leading order of $\underline{q}_{\{2\}}$ at $\mathbf{u} \rightarrow \infty$. In principle, we could very well have $\underline{q}_{\{2\}} = -i\mathbf{u} + \alpha + \mathcal{K} * \rho$ where the number α is a constant term. Then, we could impose $\text{Re}(\alpha) = 0$, using transformations of the form (III.166-III.167). If we restrict to states having symmetric Bethe roots, we actually also have the symmetry $Y_{a,s}(\mathbf{u}) = Y_{a,s}(-\mathbf{u})$, and each q -function is symmetric in the sense that $q_I(-\mathbf{u}) = \pm \overline{q_I(\mathbf{u})}$ (where the sign \pm depends on the set of indices I). This imposes $\alpha = 0$, and it explains the parameterization above.

T -functions in the right band As compared to the expression (IV.30) of $\underline{T}_{1,s}$, this parameterization gives

$$\forall s \geq 1, \quad \underline{T}_{1,s} = \underline{q}_{\{2\}}^{[+s]} + \overline{\underline{q}_{\{2\}}^{[-s]}} = -i\mathbf{u}^{[+s]} + \mathcal{K}^{[+s]} * \rho + i\mathbf{u}^{[-s]} - \mathcal{K}^{[-s]} * \rho \quad (\text{IV.54})$$

$$= s + (\mathcal{K}^{[+s]} - \mathcal{K}^{[-s]}) * \rho \quad (\text{IV.55})$$

which holds if $|\text{Im}(\mathbf{u})| < s/2$ (due to the condition on $\text{Im}(\mathbf{u})$ in (IV.52)). Hence, we obtain

$$\forall s > 2|\text{Im}(\mathbf{u})|, \quad \boxed{\underline{T}_{1,s} = s + \mathcal{K}_s * \rho}, \quad (\text{IV.56})$$

$$\text{where } \boxed{\mathcal{K}_s \equiv \mathcal{K}^{[+s]} - \mathcal{K}^{[-s]}}. \quad (\text{IV.57})$$

⁹Let us note that, as in the case of the principal chiral model, fixing the large \mathbf{u} behavior leaves some gauge freedom. Indeed the asymptotic behavior restricts the asymptotic behavior of the function g_1 in (IV.48). It still leaves enough freedom to fix $\underline{q}_{\{1\}} = 1$.

Moreover, the equations (IV.31,IV.32) give (with this parameterization)

$$\forall \mathbf{u}, \quad \forall s, \quad \mathbb{T}_{0,s} = 1, \quad (\text{IV.58})$$

$$\forall s > 1 + 2 |\text{Im}(\mathbf{u})|, \quad \mathbb{T}_{2,s} = \left(\underline{q}_{\{2\}}^{[+s+1]} - \underline{q}_{\{2\}}^{[+s-1]} \right) \left(\bar{\underline{q}}_{\{2\}}^{[-s-1]} - \bar{\underline{q}}_{\{2\}}^{[-s+1]} \right) \quad (\text{IV.59})$$

$$= \left(1 + \mathcal{K}_1^{[+s]} * \rho \right) \left(1 + \mathcal{K}_1^{[-s]} * \rho \right). \quad (\text{IV.60})$$

q -functions in the upper band For the upper band, we will have to choose a slightly less explicit parameterization of q -functions, in order to exactly reproduce the analyticity strips (IV.23) (or (IV.39-IV.40) at the level of q -functions).

The simplest possible parameterization of the q -functions would be to define the functions $\underline{q}_{(0)}$, \underline{q}_1 , \underline{q}_2 , \underline{q}_3 and \underline{q}_4 , and then the other q -functions (i.e. the coordinates of the forms $\underline{q}_{(n)}$) would be computed through the Wronskian determinant (IV.35). In order to reproduce the analyticity domains given in (IV.39), the parameterization of $\underline{q}_{(0)}$ would be analytic when $\text{Im}(\mathbf{u}) > 1/2$, whereas the parameterization of \underline{q}_1 , \underline{q}_2 , \underline{q}_3 and \underline{q}_4 would be analytic when $\text{Im}(\mathbf{u}) > 0$. But then the Wronskian expression (IV.35) would only show that $\underline{q}_{(2)}$ is analytic when $\text{Im}(\mathbf{u}) > 1/2$, whereas we would expect it to be analytic as soon as $\text{Im}(\mathbf{u}) > -1/2$. This phenomenon is exactly like in section IV.3.1, where the Wronskian expression of T -functions sometimes had non-analytic coefficients inside the determinant, but the determinant was nevertheless analytic due to some cancellations of the various non-analyticities. In the present case of AdS/CFT, the analyticity strips have a much more physical meaning than for the principal chiral model and it is really crucial to produce the correct analyticity strips. Therefore we have to find a more subtle parameterization of the q -functions than what was suggested above.

Therefore, we will choose to express all the q -functions in terms of the functions \underline{q}_1 , \underline{q}_2 , \underline{q}_{12} , \underline{q}_{123} and \underline{q}_{124} . We will show that if the parameterization of these five functions obeys the analyticity constraints (IV.39), then the other q -functions can be expressed using the qq-relations, and they will be automatically analytic in the correct domain.

We should first find the large \mathbf{u} behavior of the functions \underline{q}_1 , \underline{q}_2 , from the asymptotic limit. In this $L \rightarrow \infty$ limit, $Y_{a,0}$ is small and the Y-system splits into two lattices $\mathbb{L}(2, 2)$ (exactly like in section III.3.2, where we saw that in the asymptotic limit, the lattice $\mathbb{S}(\mathbb{N})$ of the principal chiral model splits into two sublattices $\mathbb{w}(\mathbb{N})$). One can see [11GKLT] that there is a choice of q -functions where this splitting simply corresponds to

$$\underline{q}_I \xrightarrow[L \rightarrow \infty]{} 0 \quad \text{if and only if} \quad 3 \in I \text{ or } 4 \in I. \quad (\text{IV.61})$$

Then we see that (IV.44) becomes simply $\mathbb{T}_{a,1} = \underline{q}_1^{[+a]} \bar{\underline{q}}_2^{[-a]} + \underline{q}_2^{[+a]} \bar{\underline{q}}_1^{[-a]}$. Comparing with the asymptotic limit (which imposes the behavior at large \mathbf{u}), we obtain the parameterization

$$\underline{q}_1 = 1, \quad \underline{q}_2 = W, \quad (\text{IV.62})$$

$$\text{where } W(\mathbf{u}) = P_0(\mathbf{u}) + \frac{1}{2i\pi} \int_{\mathbf{v} \in \mathbb{R}} \frac{\tilde{\rho}_2(\mathbf{v})}{\mathbf{v} - \mathbf{u}} d\mathbf{v}, \quad \text{if } \text{Im}(\mathbf{u}) > 0, \quad (\text{IV.63})$$

which parameterizes q_1 and q_2 in terms of a polynomial P_0 of degree $M - 1$ and a real function $\tilde{\rho}_2$ on the real axis. We note that in order to fix $q_1 = 1$, we used one of the two gauge freedoms of equation (IV.49).

Next we can fix the function q_{12} . We will see in the next sections that in a very natural choice of gauge, $T_{a,0}$ will have a double zero at each Bethe root $u^{(j)}$. But the above discussion ensures that in the asymptotic limit $T_{a,0} = q_{12}^{[+a]} \bar{q}_{12}^{[-a]}$. Therefore, we can use one degree of gauge freedom to choose

$$q_{12} = \tilde{Q} \quad (\text{IV.64})$$

where \tilde{Q} is a polynomial of degree M , which converges, in the asymptotic limit, to the polynomial $Q = \prod_{j=1}^M (u - u^{(j)})$.

Finally, we should parameterize the functions q_{123} and q_{124} . To this end, we simply use the relation (IV.47) to write

$$q_{123} = U^2, \quad q_{124} = U^2 W, \quad (\text{IV.65})$$

$$\text{where } U^2 = -\frac{1}{\hat{x}^{L+\gamma-1}} \frac{1}{2\pi i} \int_{-\infty}^{+\infty} \frac{\rho_U(\mathbf{v})}{u - \mathbf{v}} d\mathbf{v}, \quad \text{if } \text{Im}(u) > 0 \quad (\text{IV.66})$$

$$\text{and } \rho_U(u) = 2 \text{Re} (U^2 \cdot \hat{x}^{L+\gamma-1}) . \quad (\text{IV.67})$$

This function U defines a gauge transformation between $T_{a,-s}$ and $T_{a,s}$ (see (IV.47c)) and its parameterization corresponds to the asymptotic behavior $U \sim u^{(-L-\gamma)/2}$ of U when u is large, which will be motivated in the next sections.

Finally, our parameterization of the functions q_I reads

$$\boxed{\begin{array}{l} q_1 = 1, \quad q_2 = W, \quad q_{12} = \tilde{Q}, \\ q_{123} = U^2, \quad q_{124} = U^2 W. \end{array}} \quad (\text{IV.68})$$

$$(\text{IV.69})$$

where the functions W , \tilde{Q} and U are parameterized by two densities $\tilde{\rho}_2$ and ρ_U (see (IV.63) and (IV.66)) and two polynomials P_0 and \tilde{Q} .

Other q -functions in the upper band This defines a basis of five q -functions. Let us show that all the other q -functions on the Hasse diagram can be expressed in terms of these five functions by means of the qq-relations:

First, we know that

$$q_\emptyset = \frac{q_1^+ q_2^- - q_1^- q_2^+}{q_{12}} = \frac{W^- - W^+}{\tilde{Q}}, \quad (\text{IV.70})$$

where we see that $q_\emptyset(u)$ is analytic when $\text{Im}(u) > 1/2$. This relation was obtained by choosing $\dots = \emptyset$, $\mathbf{j} = 1$, and $\mathbf{k} = 2$ in (IV.37). On the other hand, if we set $\dots = 1$ and

$j = 2, k = 3$, we get

$$\mathfrak{q}_{1,2,3} \mathfrak{q}_1 = \mathfrak{q}_{1,2}^+ \mathfrak{q}_{1,3}^- - \mathfrak{q}_{1,2}^- \mathfrak{q}_{1,3}^+, \quad (\text{IV.71})$$

$$\text{hence } \left(\frac{\mathfrak{q}_{1,3}}{\mathfrak{q}_{1,2}} \right)^+ - \left(\frac{\mathfrak{q}_{1,3}}{\mathfrak{q}_{1,2}} \right)^- = -\frac{\mathfrak{q}_{1,2,3} \mathfrak{q}_1}{\mathfrak{q}_{1,2}^+ \mathfrak{q}_{1,2}^-} = -\frac{U^2}{\tilde{Q}^+ \tilde{Q}^-}. \quad (\text{IV.72})$$

This allows to write

$$\mathfrak{q}_{1,3} = \tilde{Q} \sum_{k=1}^{\infty} \left(\frac{U^2}{\tilde{Q}^+ \tilde{Q}^-} \right)^{[+2k-1]}. \quad (\text{IV.73})$$

At first sight, the equation (IV.72) only tells that $\frac{\mathfrak{q}_{1,3}}{\mathfrak{q}_{1,2}} - \sum_{k=1}^{\infty} \left(\frac{U^2}{\tilde{Q}^+ \tilde{Q}^-} \right)^{[+2k-1]}$ is an i -periodic function. But we know its behavior at $|u| \rightarrow \infty$, where $\frac{\mathfrak{q}_{1,3}}{\mathfrak{q}_{1,2}}$ tend to zero, and so does $\sum_{k=1}^{\infty} \left(\frac{U^2}{\tilde{Q}^+ \tilde{Q}^-} \right)^{[+2k-1]}$. That allows¹⁰ to write the equation (IV.73). We can repeat the arguments to find $\mathfrak{q}_{1,4}$, $\mathfrak{q}_{2,3}$ and $\mathfrak{q}_{2,4}$. We obtain

$$\left(\frac{\mathfrak{q}_{1,4}}{\mathfrak{q}_{1,2}} \right)^+ - \left(\frac{\mathfrak{q}_{1,4}}{\mathfrak{q}_{1,2}} \right)^- = -\frac{\mathfrak{q}_{1,2,4} \mathfrak{q}_1}{\mathfrak{q}_{1,2}^+ \mathfrak{q}_{1,2}^-} \implies \mathfrak{q}_{1,4} = \tilde{Q} \sum_{k=1}^{\infty} \left(\frac{W U^2}{\tilde{Q}^+ \tilde{Q}^-} \right)^{[+2k-1]}, \quad (\text{IV.74})$$

$$\left(\frac{\mathfrak{q}_{2,3}}{\mathfrak{q}_{1,2}} \right)^+ - \left(\frac{\mathfrak{q}_{2,3}}{\mathfrak{q}_{1,2}} \right)^- = -\frac{\mathfrak{q}_{1,2,3} \mathfrak{q}_2}{\mathfrak{q}_{1,2}^+ \mathfrak{q}_{1,2}^-} \implies \mathfrak{q}_{2,3} = \tilde{Q} \sum_{k=1}^{\infty} \left(\frac{W U^2}{\tilde{Q}^+ \tilde{Q}^-} \right)^{[+2k-1]}, \quad (\text{IV.75})$$

$$\left(\frac{\mathfrak{q}_{2,4}}{\mathfrak{q}_{1,2}} \right)^+ - \left(\frac{\mathfrak{q}_{2,4}}{\mathfrak{q}_{1,2}} \right)^- = -\frac{\mathfrak{q}_{1,2,4} \mathfrak{q}_2}{\mathfrak{q}_{1,2}^+ \mathfrak{q}_{1,2}^-} \implies \mathfrak{q}_{2,4} = \tilde{Q} \sum_{k=1}^{\infty} \left(\frac{W^2 U^2}{\tilde{Q}^+ \tilde{Q}^-} \right)^{[+2k-1]}. \quad (\text{IV.76})$$

From these expression, we can notice that $\mathfrak{q}_{2,3} = \mathfrak{q}_{1,4}$, and that all these q -functions with two indices are analytic functions of u when $\text{Im}(u) > -1/2$.

Next we can find \mathfrak{q}_3 and \mathfrak{q}_4 by the same methods. This gives

$$\left(\frac{\mathfrak{q}_3}{\mathfrak{q}_1} \right)^+ - \left(\frac{\mathfrak{q}_3}{\mathfrak{q}_1} \right)^- = -\frac{\mathfrak{q}_{1,3} \mathfrak{q}_\emptyset}{\mathfrak{q}_1^+ \mathfrak{q}_1^-} \implies \mathfrak{q}_3 = \sum_{k=1}^{\infty} \left(\mathfrak{q}_{1,3} \mathfrak{q}_\emptyset \right)^{[+2k-1]}, \quad (\text{IV.77})$$

$$\left(\frac{\mathfrak{q}_4}{\mathfrak{q}_1} \right)^+ - \left(\frac{\mathfrak{q}_4}{\mathfrak{q}_1} \right)^- = -\frac{\mathfrak{q}_{1,4} \mathfrak{q}_\emptyset}{\mathfrak{q}_1^+ \mathfrak{q}_1^-} \implies \mathfrak{q}_4 = \sum_{k=1}^{\infty} \left(\mathfrak{q}_{1,4} \mathfrak{q}_\emptyset \right)^{[+2k-1]}. \quad (\text{IV.78})$$

Finally, the qq -relations allow to express $\mathfrak{q}_{3,4}$ as follows

$$\left(\frac{\mathfrak{q}_{3,4}}{\mathfrak{q}_{1,3}} \right)^+ - \left(\frac{\mathfrak{q}_{3,4}}{\mathfrak{q}_{1,3}} \right)^- = -\frac{\mathfrak{q}_{1,3,4} \mathfrak{q}_3}{\mathfrak{q}_{1,3}^+ \mathfrak{q}_{1,3}^-} \implies \mathfrak{q}_{3,4} = \mathfrak{q}_{1,3} \sum_{k=1}^{\infty} \left(\frac{U^2 \mathfrak{q}_3^2}{\mathfrak{q}_{1,3}^+ \mathfrak{q}_{1,3}^-} \right). \quad (\text{IV.79})$$

¹⁰Indeed, the Liouville theorems implies that any i -periodic function which decreases to zero at infinity (and is analytic on the upper half-plane) is equal to zero on the whole complex plane.

These expressions express all the q -functions with zero, one or two indices, and they show that with this parameterization, $q_{\square(0)}$ (resp $q_{\square(1)}$, resp $q_{\square(2)}$) is analytic when $\text{Im}(u) > 1/2$ (resp $\text{Im}(u) > 0$, resp $\text{Im}(u) > -1/2$).

One can write in the same way the functions with three or four indices, but the expressions that we obtain simply reproduce the equation (IV.47). Hence $q_{\square(3)}$ (resp $q_{\square(4)}$) is analytic when $\text{Im}(u) > 0$ (resp $\text{Im}(u) > 1/2$).

This shows that with this parameterization, the analyticity strips (IV.39) of all the q -functions are directly imposed by our choice of parameterization. If we remind that the p -functions are essentially the complex-conjugate of the q -functions (see (IV.41)), we see that the analyticity strips (IV.40) for the p -functions are also imposed by this parameterization.

Therefore, this parameterization allows to express all the T -functions, inside their analyticity strips (IV.21), in terms of three densities and two polynomials. This parameterization, defined above, was obtained at the price of introducing two gauges denoted $\overrightarrow{T}_{a,s}$ and $\overleftarrow{T}_{a,s}$. In what follows, these two gauges will be called “parameterization gauges”. More precisely, $\overrightarrow{T}_{a,s}$ is the parameterization gauge associated to the “right band”, whereas $\overleftarrow{T}_{a,s}$ is the parameterization gauge associated to the “upper band band”.

IV.4 Set of equations

Now that we have parameterized the various T -functions in terms of three densities and two polynomials, we will write down the equations which allow to fix these densities (and these polynomials). For simplicity we focus on states in the $SL(2)$ sector, and when we will fix these polynomials, we will even restrict to states having two symmetric Bethe roots (i.e. $M = 2$ and $u^{(1)} = -u^{(2)}$).

First, we will impose some constraints motivated by the symmetries of the model. These constraints are on the one hand the existence of the “Physical gauge”, and on the other hand the “ \mathbb{Z}_4 ” symmetry. These constraints can be motivated from physical considerations, but they can also be derived if we assume that the TBA-equations hold. On the other hand, the TBA-equations can be derived from our construction, which means that our constraints are equivalent to the Y-system equation, for which they provide an alternative formulation, motivated by the symmetries of the model.

Next we will see how to deduce equations on the densities, in order to write an iterative algorithm.

IV.4.1 The “Physical Gauge”

In the previous chapter, we have defined a set of more physical gauges called “Wronskian gauges”. We will now define one such gauge, which differs slightly from the parameterization gauges constructed above. This gauge obeys specific properties (guessed in the subsection IV.4.1.1) which should make this gauge more physical if a physical construction (such as a lattice regularization) turns out to exist in the case of AdS/CFT. The

subsection IV.4.1.2 will show that the existence of such a basis can be derived from the TBA-equations, whereas the subsection IV.4.1.3 will show how express this “Physical gauge” in terms of the “Parameterization gauges” defined in the previous sections.

IV.4.1.1 Properties of the physical gauge

We will denote by a bold letter \mathbf{T} the T -functions in this particular “physical” gauge (whereas the slant letters T will denote T -functions in an unspecified gauge). The first natural conditions that we impose is that the \mathbf{T} -functions obey the Wronskian gauge condition (III.81) and the reality condition

$$\overline{\mathbf{T}_{a,s}(\mathbf{u})} = \mathbf{T}_{a,s}(\bar{\mathbf{u}}). \quad (\text{IV.80})$$

The Wronskian gauge condition ensures that in this gauge, the \mathbf{T} -functions are expressed through \mathcal{Q} -functions, as in (III.143- III.145). Then the condition $\frac{\mathcal{Q}_\emptyset^+ \mathcal{Q}_\emptyset^-}{\mathcal{Q}_\emptyset^- \mathcal{Q}_\emptyset^+} = 1$ (where $\mathcal{Q}_\emptyset = 1$ and $\mathcal{Q}_{\bar{\emptyset}} = T_{0,s}^{[-s]}$) imposes that

$$\mathbf{T}_{0,0}^+ = \mathbf{T}_{0,0}^-, \quad \mathbf{T}_{0,s} = \mathbf{T}_{0,0}^{[+s]} = \mathbf{T}_{0,0}^{[-s]}. \quad (\text{IV.81})$$

This tells that $\mathbf{T}_{0,0}$ should be an \mathfrak{i} -periodic function in the mirror sheet (indeed the mirror sheet is the sheet where the Y-system equation holds). This means that the function

$$\mathcal{F} \equiv \sqrt{\mathbf{T}_{0,0}}, \quad (\text{IV.82})$$

which is an \mathfrak{i} -periodic function on the mirror sheet, could a priori have a periodic structure of infinitely many \check{Z} -cuts.

In principle one could do a periodic gauge-transformation which sets $\mathbf{T}_{0,0}$ to one (for instance $\mathbf{T}_{a,s} \rightsquigarrow \mathbf{T}_{a,s}/\mathbf{T}_{0,0}^{[+a+s]}$). But such a gauge transformation would involve the multiplication by $\mathbf{T}_{0,0}$, which has a periodic structure of Zhukovsky cuts (separated by \mathfrak{i}), so that this gauge transformation spoils the analyticity of the \mathbf{T} -functions. If we do not do any such transformation, then we see that $\mathbf{T}_{0,s}$ a priori has a poor analyticity (due to periodic cuts, it is at most analytic on \mathbf{A}_1).

Therefore we can exclude that in the physical gauge, the \mathbf{T} -functions obey the analyticity constraint (IV.24) in the right band, or the analyticity constraint (IV.25) in the left band. But as this gauge is supposed to have a physical origin, it should obey some analyticity conditions, and therefore it must obey the analyticity constraint (IV.23) in the upper band:

$$\mathbf{T}_{a,s} \in \mathcal{A}_{a-|s|+1}. \quad (\text{IV.83})$$

In particular, we obtain that $\mathbf{T}_{0,0} \in \mathcal{A}_1$. Then as we know that \mathcal{F} is \mathfrak{i} -periodic in the mirror sheet, we can deduce that \mathcal{F} is analytic on the whole complex plane except on $\bigcup_{n \in \mathbb{Z}} \check{Z}_{2n+1}$.

The periodic cuts structure of the function \mathcal{F} is illustrated in figure IV.2.

Moreover, we will restrict to excited states belonging to the so-called SL(2) sector [Min12], which denotes the states having only one type of Bethe roots: the momentum

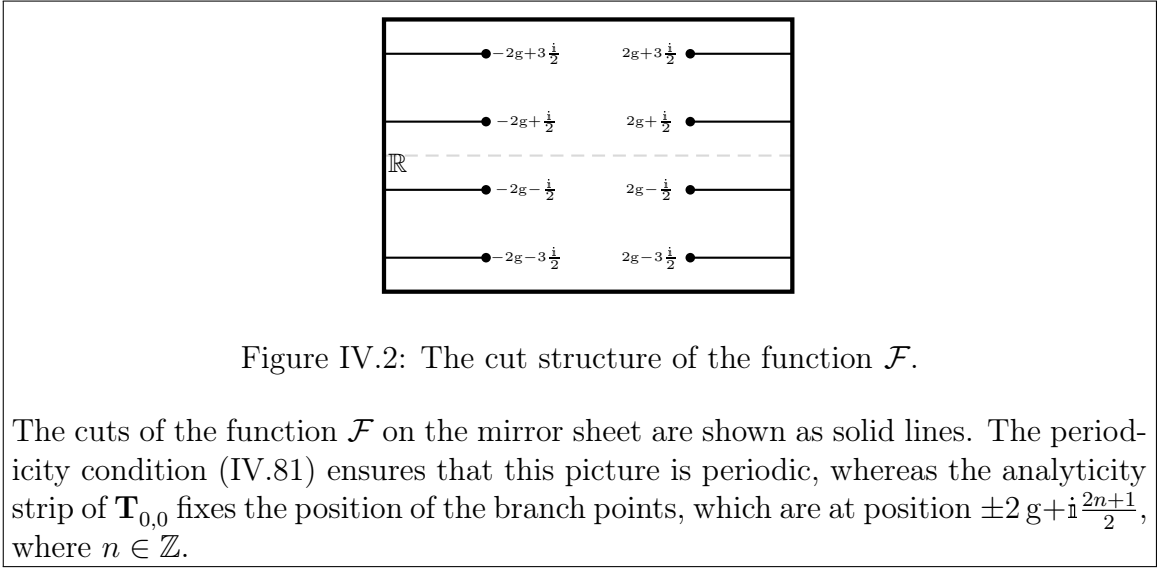

Figure IV.2: The cut structure of the function \mathcal{F} .

The cuts of the function \mathcal{F} on the mirror sheet are shown as solid lines. The periodicity condition (IV.81) ensures that this picture is periodic, whereas the analyticity strip of $\mathbf{T}_{0,0}$ fixes the position of the branch points, which are at position $\pm 2g + i\frac{2n+1}{2}$, where $n \in \mathbb{Z}$.

carrying roots which enter in the expression (IV.7) of the energy. This sector is analogous to the $U(1)$ sector of the principal chiral model studied in section III.3. For these states the Y-functions are symmetric $Y_{a,s} = Y_{a,-s}$. Then we expect that a physical construction of the \mathbf{T} -functions would preserve this symmetry, hence the relation

$$\mathbf{T}_{a,s} = \mathbf{T}_{a,-s}. \quad (\text{IV.84})$$

IV.4.1.2 Existence of the physical gauge

Now that we have written the physical properties that we expect from this physical gauge, it is actually possible to show that such a gauge does exist. Indeed, we know that there exist several gauges where the analyticity constraint (IV.23) is satisfied. Therefore we will start from one such gauge (for instance $T_{a,s} = \underline{\mathbf{T}}_{a,s}$), and we will show how to construct, out of this solution of Hirota equation, some T -functions which obey the same analyticity properties and which are additionally real ($T_{a,s}(\mathbf{u}) = \overline{T_{a,s}(\bar{\mathbf{u}})}$) and symmetric ($T_{a,s} = T_{a,-s}$). Finally, we will need to use the TBA equations in order to show that in this gauge, the Wronskian gauge conditions (III.81) hold.

Let us then start with T -functions $T_{a,s}$, which are such that the analyticity condition (IV.23) holds. As the Y-functions obey $Y_{a,s} = Y_{a,-s}$, we know¹¹ that there exists four gauge functions g_1, g_2, g_3 and g_4 such that $T_{a,-s} = g_1^{[a+s]} g_2^{[a-s]} g_3^{[-a+s]} g_4^{[-a-s]} T_{a,s}$. From this we deduce that the gauge transformation

$$T_{a,s} \rightsquigarrow \sqrt{g_1^{[a+s]}} \sqrt{g_2^{[a-s]}} \sqrt{g_3^{[-a+s]}} \sqrt{g_4^{[-a-s]}} T_{a,s} = \sqrt{T_{a,s} T_{a,-s}}$$

allows to define a T -function which still has the same analyticity strips, but which obeys the symmetry condition $T_{a,s} = T_{a,-s}$.

¹¹The argument here uses the Statement 3 (page 115). Indeed the ratio of the $T_{a,s}$ (resp of $T_{a,-s}$) gives rise to $Y_{a,s}$ (resp to $Y_{a,-s} = Y_{a,s}$). We deduce that $T_{a,s}$ and $T_{a,-s}$ give rise to the same Y-functions, hence they are equal up to a gauge transformation.

The same argument can be used to ensure that the T -functions are also real. Since $Y_{a,s}$ is real (i.e. $\overline{Y_{a,s}(\mathbf{u})} = Y_{a,s}(\overline{\mathbf{u}})$), we know that there exist four gauge functions such that¹² $\overline{T_{a,s}} = g_1^{[a+s]} g_2^{[a-s]} g_3^{[-a+s]} g_4^{[-a-s]} T_{a,s}$. Then we can use the gauge transformation

$$T_{a,s} \rightsquigarrow \sqrt{g_1^{[a+s]}} \sqrt{g_2^{[a-s]}} \sqrt{g_3^{[-a+s]}} \sqrt{g_4^{[-a-s]}} T_{a,s} = \sqrt{\overline{T_{a,s} T_{a,s}}}$$

which preserves the analyticity strips and the condition $T_{a,s} = T_{a,-s}$, and makes the T -functions real.

Continuity relation At this point we have shown how to obtain a gauge where the T -functions are analytic in the upper band, and symmetric with respect to complex conjugacy and to the exchange $s \leftrightarrow -s$. In order to obtain a Wronskian gauge conditions (III.81), we now need to use analyticity conditions, contained in the TBA-equations, which should be enforced in addition to the Y-system equation. In [CFT11], a set of analyticity conditions is written, and it is shown that these analyticity conditions are equivalent to the TBA-equations (in the sense that if both these analyticity conditions and the Y-system equation hold, then we can derive the TBA-equations, and that conversely the TBA-equations imply that both the Y-system equation and these analyticity conditions hold). One of these analyticity conditions (namely the equation (1.7) in [CFT11]) reads as follows (in the present notation):

$$\forall n \geq 1, \quad \text{disc} \left((\log Y_{1,1} Y_{2,2})^{[+2n]} \right) = - \sum_{a=1}^n \text{disc} \left(\log(1 + Y_{a,0}^{[+2n-a]}) \right) \quad (\text{IV.85})$$

$$\text{where } \text{disc } F \equiv F^{[+0]} - F^{[-0]} \equiv \lim_{\epsilon \rightarrow 0} F^{[+\epsilon]} - F^{[-\epsilon]}. \quad (\text{IV.86})$$

This equation is written at the level of Y-functions, and at the level of T -functions, it reads

$$\forall n \geq 1, \quad \text{disc} \left((\log Y_{1,1} Y_{2,2})^{[+2n]} \right) = - \text{disc} \left(\log \left(\prod_{a=1}^n \frac{T_{a,0}^{[+2n-a+1]} T_{a,0}^{[+2n-a-1]}}{T_{a+1,0}^{[+2n-a]} T_{a-1,0}^{[+2n-a]}} \right) \right) \quad (\text{IV.87})$$

$$= - \text{disc} \left(\log \left(\frac{T_{1,0}^{[+2n]} T_{n,0}^{[+n-1]}}{T_{n+1,0}^{[+n]} T_{0,0}^{[+2n-1]}} \right) \right). \quad (\text{IV.88})$$

Since we know that $\text{disc} \left(\log \left(T_{n,0}^{[+n-1]} / T_{n+1,0}^{[+n]} \right) \right) = 0$, (due to the analyticity strips (IV.40) of the T -functions), we obtain that the ratio

$$\frac{1}{Y_{1,1} Y_{2,2}} \frac{T_{1,0}}{T_{0,0}^-} \quad (\text{IV.89})$$

¹²Let us remind that here, $\overline{T_{a,s}}$ denotes the function $\mathbf{u} \mapsto \overline{T_{a,s}(\overline{\mathbf{u}})}$. Hence, when we say that $T_{a,s}$ is real, it means $T_{a,s} = \overline{T_{a,s}}$, which means that if \mathbf{u} is real, then $T_{a,s}(\mathbf{u})$ is real.

has no discontinuity over the cuts \check{Z}_{2n} . Moreover, we know from the remark at the end of the section IV.3.1.1 that the only possible non-analyticity of this ratio are Zhukovsky cuts located precisely on \check{Z}_{2n} (where $n \in \mathbb{Z}$). Hence we obtain that

$$\frac{1}{Y_{1,1}Y_{2,2}} \frac{T_{1,0}}{T_{0,0}^-} \quad \text{is analytic when } \text{Im}(u) > 0. \quad (\text{IV.90})$$

Gauge transformation constructing the physical gauge The analyticity condition (IV.90) allows to define a function f such that

$$f(u) \quad \text{is analytic when } \text{Im}(u) > -1/2, \quad \text{and} \quad \left(\frac{f^-}{f^+} \right)^2 = \frac{1}{Y_{1,1}Y_{2,2}} \frac{T_{1,0}}{T_{0,0}^-}. \quad (\text{IV.91})$$

Using this function, we can define the \mathbf{T} -functions in the physical gauge as

$$\mathbf{T}_{a,s} = f^{[a+s]} f^{[a-s]} \bar{f}^{[-a+s]} \bar{f}^{[-a-s]} T_{a,s}. \quad (\text{IV.92})$$

With this definition, $\mathbf{T}_{a,s}$ is analytic in the upper band (in the sense of equation (IV.83)), and it is symmetric with respect to complex conjugacy and to the exchange $s \leftrightarrow -s$. Moreover, the definition of the function f which appears in (IV.92) is such that

$$\frac{\mathbf{T}_{3,2} \mathbf{T}_{0,1}}{\mathbf{T}_{2,3} \mathbf{T}_{0,0}^-} = \frac{T_{3,2} T_{0,1}}{T_{2,3} T_{0,0}^-} \left(\frac{f^+}{f^-} \right)^2 = \frac{T_{3,2} T_{0,1}}{T_{2,3} T_{1,0}} Y_{1,1} Y_{2,2} = 1. \quad (\text{IV.93})$$

To conclude, one can use the reality of the \mathbf{T} -functions, and write the complex conjugate of (IV.93) to obtain $\frac{\mathbf{T}_{3,2} \mathbf{T}_{0,1}}{\mathbf{T}_{2,3} \mathbf{T}_{0,0}^+} = 1$. Dividing it by (IV.93) gives $\mathbf{T}_{0,0}^+ = \mathbf{T}_{0,0}^-$. Together with the relation $\mathbf{T}_{0,s} = \mathbf{T}_{0,-s}$ and with the Hirota equation at $a = 0$, this allows to deduce that (IV.81) holds in the physical gauge which we have just constructed. Finally, if we insert this equality into (IV.93), then we obtain $\mathbf{T}_{3,2} = \mathbf{T}_{2,3}$. This equality implies that the gauge condition (III.168b) holds (with $K = K' = M = M' = 2$ in the present case of AdS/CFT). This shows that the \mathbf{T} -functions of the physical gauge constructed above do obey the ‘‘Wronskian’’ gauge condition.

Hence we have explicitly constructed the ‘‘physical gauge’’ obeying the required conditions. Moreover, one can show (see appendix E.1 of [11GKLV]) that this gauge is unique if we impose the behavior of the T -functions when $u \rightarrow \infty$ and the structure of its zeroes.

IV.4.1.3 Relation to the ‘‘parameterization gauges’’

In the argument used above to construct the physical basis, We can choose to start from the gauge $T_{a,s} = \underline{\mathbf{T}}_{a,s}$. This allows to deduce the following relation between the \mathbf{T} -functions and the $\underline{\mathbf{T}}$ -functions:

$$\mathbf{T}_{a,s} = f^{[a+s]} f^{[a-s]} \bar{f}^{[-a+s]} \bar{f}^{[-a-s]} \left(U^{[+a]} \bar{U}^{[-a]} \right)^{[-s]D} \underline{\mathbf{T}}_{a,s}, \quad (\text{IV.94})$$

$$\text{where} \quad \left(\frac{f^-}{f^+} \right)^2 = \mathbf{B} = \frac{1}{Y_{1,1}Y_{2,2}} \frac{\underline{\mathbf{T}}_{1,0}}{\underline{\mathbf{T}}_{0,0}^-}. \quad (\text{IV.95})$$

Let us now find how to express the function f defined above. We know from the TBA equations that the function \mathbf{B} defined above is analytic on the upper-half plane. That allows to write a Cauchy representation of this function as

$$\log \mathbf{B} = \mathcal{K} * \rho_b = \frac{1}{2i\pi} \int_{v \in \mathbb{R}} \frac{\rho_b(v)}{v - u} dv, \quad \text{if } \text{Im}(u) > 0, \quad (\text{IV.96})$$

where $\rho_b = \log(\mathbf{B} \overline{\mathbf{B}})$ is equal to

$$\rho_b(v) = \begin{cases} \log \frac{\mathbb{T}_{1,0}^2}{\mathbb{T}_{0,0}^- \mathbb{T}_{0,0}^+ Y_{1,1}^2 Y_{2,2}^2} & \text{if } u \in] - 2g, 2g[\quad (\text{IV.97a}) \\ \log \frac{\mathbb{T}_{1,0}^2}{\mathbb{T}_{0,0}^{[-1+0]} \mathbb{T}_{0,0}^{[+1-0]}} & \text{if } u \in] - \infty, -2g[\cup] 2g, \infty[. \quad (\text{IV.97b}) \end{cases}$$

The expression $\log \mathbf{B} = \mathcal{K} * \rho_b$ is obtained from the Statement 8 (page 147) with the functions $F = \log \mathbf{B}$ and $G = -\log \overline{\mathbf{B}}$, using the behavior of \mathbf{B} at $|u| \rightarrow \infty$: $\mathbf{B} \xrightarrow[\text{Im}(u) \geq 0]{|u| \rightarrow \infty} 1$.

Shifts and cuts structure in (IV.97) Let us elaborate on the shifts in equation (IV.97): first let us note that at position $u \in \mathbb{R}$, the quantity $\mathbf{B} \overline{\mathbf{B}}$ is defined by continuity as $\lim_{\epsilon \rightarrow 0^+} \mathbf{B}^{[+\epsilon]} \overline{\mathbf{B}}^{[-\epsilon]}$, which we can also denote as $\mathbf{B}^{[+0]} \overline{\mathbf{B}}^{[-0]}$. We can also see that although the definition (IV.96) is written for $\text{Im}(u) > 0$, it allows to write \mathbf{B} on the real axis as follows (see (III.247) where one can set $F = \log \mathbf{B}$ and $G = -\log \overline{\mathbf{B}}$):

$$\log \mathbf{B} = \mathcal{K} * \rho_b + \frac{1}{2} \rho_b = \frac{1}{2i\pi} \int_{v \in \mathbb{R}} \frac{\rho_b(v)}{v - u} dv + \frac{1}{2} \rho_b, \quad \text{if } \text{Im}(u) = 0. \quad (\text{IV.98})$$

Let us now elaborate on the expression (IV.97a), which expresses $\mathbf{B} \overline{\mathbf{B}}$ when $u \in] - 2g, 2g[$. This expression arises from the reality of the functions $Y_{1,1}$, $Y_{2,2}$, $\mathbb{T}_{1,0}$ and $\mathbb{T}_{0,0}$ which appear in the definition (IV.95) of \mathbf{B} . As we said, $\mathbf{B} \overline{\mathbf{B}}$ actually denotes the limit $\mathbf{B}^{[+0]} \overline{\mathbf{B}}^{[-0]}$ of $\mathbf{B}^{[+\epsilon]} \overline{\mathbf{B}}^{[-\epsilon]}$ when $\epsilon \rightarrow 0$. Therefore, in the expression $\log \frac{\mathbb{T}_{1,0}^2}{\mathbb{T}_{0,0}^- \mathbb{T}_{0,0}^+ Y_{1,1}^2 Y_{2,2}^2}$, the factor $\mathbb{T}_{0,0}^- \mathbb{T}_{0,0}^+$ arises from the limit of $\mathbb{T}_{0,0}^{[-1+\epsilon]} \mathbb{T}_{0,0}^{[+1-\epsilon]}$. As the function $\mathbb{T}_{0,0}$ is analytic only in \mathbf{A}_1 (see (IV.23)), this prescription could be important to ensure that the argument of $\mathbb{T}_{0,0}$ is inside the analyticity strip (which means that we can compute it from the densities introduced in section IV.3.2). In the present case, as $u \in] - 2g, 2g[$, the function $\mathbb{T}_{0,0}$ (which is defined in the mirror sheet) is regular at $u \pm i/2$, which means that $\mathbb{T}_{0,0}^{[-1+\epsilon]} \mathbb{T}_{0,0}^{[+1-\epsilon]}$ is regular at $\epsilon = 0$, and its limit is simply $\mathbb{T}_{0,0}^+ \mathbb{T}_{0,0}^-$.

To finish with, let us elaborate on the expression (IV.97b), which expresses the limit $\mathbf{B}^{[+0]} \overline{\mathbf{B}}^{[-0]}$ when $u \in] - \infty, -2g[\cup] 2g, \infty[$. One should note that the functions $Y_{1,1}$ and $Y_{2,2}$ have cuts on the real axis (see (IV.20)) and as they are real functions, we have

$$\overline{Y_{1,1}^{[+0]}} = Y_{1,1}^{[-0]} = \frac{1}{Y_{2,2}^{[+0]}}, \quad \text{where } u \in \check{Z}_0. \quad (\text{IV.99})$$

This implies that $\frac{1}{Y_{1,1}^{[+0]} Y_{1,1}^{[+0]}} \frac{1}{\overline{Y_{1,1}^{[-0]} \overline{Y_{1,1}^{[-0]}}} = 1$, which explains that the expression (IV.97b) does not contain the functions $Y_{1,1}$ and $Y_{2,2}$. Moreover, one should note that, unlike the equation (IV.97a), we have to use the notation $\mathbb{T}_{0,0}^{[-1+0]} \mathbb{T}_{0,0}^{[+1-0]}$, which denotes the limit of $\mathbb{T}_{0,0}^{[-1+\epsilon]} \mathbb{T}_{0,0}^{[+1-\epsilon]}$ when ϵ is positive and tends to zero. It was important to specify this prescription here, because the function $\mathbb{T}_{0,0}$ has a discontinuity at $u \pm i/2$ (when $u \in \check{Z}_0$).

Equation of the function f . As we can see from (IV.95), the function f which appears in the gauge transformation (IV.94) between the gauge \mathbb{T} and the gauge \mathbf{T} has to obey the relation

$$2(\log f^- - \log f^+) = \log \mathbf{B} = \mathcal{K} * \rho_b. \quad (\text{IV.100})$$

This relation is easily solved if we impose that f decreases to zero at $|u| \rightarrow \infty$ and is analytic in the upper-half plane. It gives

$$\boxed{2 \log f = \Psi^+ * \rho_b}, \quad (\text{IV.101})$$

where Ψ denotes the convolution kernel

$$\Psi(u) = -\frac{\psi(-iu)}{2\pi} = \frac{\gamma}{2\pi} + \sum_{n=0}^{\infty} \left(\mathcal{K}^{[2n]} - \frac{1}{2\pi(n+1)} \right), \quad (\text{IV.102})$$

where γ denotes Euler's constant and ψ denotes the derivative of $\log \Gamma$. Roughly speaking, this means that the equation (IV.100) is solved by

$$2 \log f = \sum_{n=0}^{\infty} \mathcal{K}^{[2n]} * \rho_b,$$

up to a normalization (and this normalization should compensate the fact that the sum diverges).

In fact, the equation (IV.100) only fixes $\log f$ up to an additive constant. This constant is irrelevant because it only fixes the normalization of the \mathbf{T} -functions (in the physical gauge). Therefore we can freely choose a normalization such that the equation (IV.101) holds.

q -functions for the physical gauge Having expressed the gauge transformation between the physical gauge and the parameterization gauge for the upper band, we can deduce an expression of the \mathbf{T} -functions in the upper band, in terms of q -functions. It reads

$$\forall a \geq 2, \quad \mathbf{T}_{a,2} = \mathbf{q}_{\emptyset}^{[+a]} \overline{\mathbf{q}}_{\emptyset}^{[-a]}, \quad (\text{IV.103a})$$

$$\forall a \geq 1, \quad \mathbf{T}_{a,1} = \mathbf{q}_1^{[+a]} \overline{\mathbf{q}}_2^{[-a]} + \mathbf{q}_2^{[+a]} \overline{\mathbf{q}}_1^{[-a]} + \mathbf{q}_3^{[+a]} \overline{\mathbf{q}}_4^{[-a]} + \mathbf{q}_4^{[+a]} \overline{\mathbf{q}}_3^{[-a]}, \quad (\text{IV.103b})$$

$$\forall a \geq 0, \quad \mathbf{T}_{a,0} = \mathbf{q}_{12}^{[+a]} \overline{\mathbf{q}}_{12}^{[-a]} - \mathbf{q}_{13}^{[+a]} \overline{\mathbf{q}}_{24}^{[-a]} - \mathbf{q}_{14}^{[+a]} \overline{\mathbf{q}}_{23}^{[-a]} \quad (\text{IV.103c})$$

$$- \mathbf{q}_{23}^{[+a]} \overline{\mathbf{q}}_{14}^{[-a]} - \mathbf{q}_{24}^{[+a]} \overline{\mathbf{q}}_{13}^{[-a]} + \mathbf{q}_{34}^{[+a]} \overline{\mathbf{q}}_{34}^{[-a]}. \quad (\text{IV.103d})$$

$$\forall a, s, \quad \mathbf{T}_{a,-s} = \mathbf{T}_{a,s}. \quad (\text{IV.103e})$$

The bold letter \mathbf{q} denotes the q -functions in the physical gauge. These \mathbf{q} -functions are related to the $\underline{\mathbf{q}}$ -functions by the relation (in terms of (n) -forms)

$$\mathbf{q}_{(n)} \equiv U^{[2-n]_D} f^{[+s-n]} f^{[-s+n]}, \quad (\text{IV.104})$$

where $U^{[n]_D}$ is defined by (IV.8). The definition (IV.104) is designed to reproduce the relation (IV.94).

In other words, the \mathbf{q} -functions are defined by means of the $\mathbf{q}\mathbf{q}$ -relation, from the basis

$$\mathbf{q}_1 = U f^+ f^-, \quad \mathbf{q}_2 = U f^+ f^- W, \quad \mathbf{q}_{12} = f^2 \tilde{Q}, \quad (\text{IV.105})$$

$$\mathbf{q}_{123} = \mathbf{q}_1, \quad \mathbf{q}_{124} = \mathbf{q}_2. \quad (\text{IV.106})$$

Right band Up to here, we have written completely distinct gauges for the upper band and the right band. In particular, the \mathbf{T} -functions defined above are analytic only in the upper band, and we would also be interested in relating it to the $\underline{\mathbf{T}}$ -functions which we defined for the right band. To this end, we will introduce an intermediate gauge $\mathbb{T}_{a,s}$, which is very similar to the physical gauge $\mathbf{T}_{a,s}$, but is analytic in the right band. Next, we will show how this gauge is related to the parameterization gauge $\underline{\mathbb{T}}_{a,s}$.

Let us write the simplest gauge transformation which makes the T -functions analytic in the right band:

$$\boxed{\mathbb{T}_{a,s} = (-1)^{a(s+1)} \mathbf{T}_{a,s} (\mathcal{F}^{[a+s]})^{a-2}}. \quad (\text{IV.107})$$

The factor $(\mathcal{F}^{[a+s]})^{a-2}$ is necessary to obtain $\mathbb{T}_{0,s} \in \mathcal{A}_{s+1}$ (it even gives $\mathbb{T}_{0,s} = 1$), and it also gives $\mathbb{T}_{2,s} \in \mathcal{A}_{s-1}$, because $\mathbb{T}_{2,s} = \mathbf{T}_{2,s} = \mathbf{T}_{s,2} \in \mathcal{A}_{s-1}$ (when $s \geq 2$). Actually, we will see that this gauge even obeys the analyticity condition $\mathbb{T}_{1,s} \in \mathcal{A}_s$, which shows that it has the analyticity strips (IV.24). The sign $(-1)^{a(s+1)}$ has no consequence on the analyticity strips, but it is actually necessary in order to have functions with a simple asymptotic behavior when $\mathbf{u} \rightarrow \infty$.

This claim that $\mathbb{T}_{a,s}$ (defined above) is analytic in the right band can either be viewed as a fundamental hypothesis describing our solution of the Hirota equation, and out of which we will write several non-trivial equations (and we will eventually see that these equations imply the TBA-equations) or we can adopt another point of view and start from the known features of the Y-system, namely the TBA-equations, and deduce this analyticity property. Let us sketch the proof that if the TBA-equations hold, then we obtain $\mathbb{T}_{1,s} \in \mathcal{A}_{|s|}$, and we will see that this proof is very similar to the proof of the existence of the physical gauge. This proof relies on the discontinuity relation (F.5) in [CFT11]. One can see (like in section IV.4.1.2, see also appendix C.2 in [11GKLV]) that this discontinuity relation means that the ratio

$$\mathbf{C} \equiv \frac{Y_{1,1} \underline{\mathbb{T}}_{0,0}^-}{Y_{2,2} \underline{\mathbb{T}}_{1,0}^-} \left(\frac{\underline{\mathbb{T}}_{2,1}^- \underline{\mathbb{T}}_{1,1}^-}{\underline{\mathbb{T}}_{1,2}^- \underline{\mathbb{T}}_{1,1}^-} \right)^2 \quad (\text{IV.108})$$

is analytic when $\text{Im}(\mathbf{u}) > 0$.

To understand better this statement, let us introduce the function h such that

$$\mathbb{T}_{1,s} = h^{[+s]} \bar{h}^{[-s]} \underline{\mathbb{T}}_{1,s}. \quad (\text{IV.109})$$

This function exists because $\underline{\mathbb{T}}_{a,s}$ and $\mathbb{T}_{a,s}$ are real T -functions which differ only by a gauge. Moreover, due to the definition $\mathbb{T}_{0,s} = 1 = \underline{\mathbb{T}}_{0,s}$, we obtain

$$\boxed{\mathbb{T}_{a,s} = (h^{[+s]} \bar{h}^{[-s]})^{[a]D} \underline{\mathbb{T}}_{a,s}}. \quad (\text{IV.110})$$

In order to prove that $\mathbb{T}_{a,s}$ is analytic in the right band, we will prove that h is analytic on the upper-half plane (i.e. when $\text{Im}(u) > 0$). To this end, we will see that the function \mathbf{C} defined in (IV.108) can be rewritten in terms of h . To show this, let us write $\frac{Y_{1,1}}{Y_{2,2}}$ in terms of the \mathbf{T} -functions:

$$\frac{Y_{1,1}}{Y_{2,2}} = \frac{\mathbf{T}_{1,0}(\mathbf{T}_{1,2})^2}{\mathbf{T}_{0,0}(\mathbf{T}_{2,1})^2} = \left[\frac{\mathbf{T}_{1,0}(\mathbf{T}_{1,1}^-)^2}{\mathbf{T}_{0,0}(\mathbf{T}_{2,1})^2} \right] \frac{(\mathbf{T}_{1,2})^2}{(\mathbf{T}_{1,1}^-)^2}, \quad (\text{IV.111})$$

$$\text{where } \frac{\mathbf{T}_{1,0}(\mathbf{T}_{1,1}^-)^2}{\mathbf{T}_{0,0}(\mathbf{T}_{2,1})^2} = \left(\frac{U}{U^{[+2]}} \frac{f^+}{f^{[+3]}} \right)^2 \frac{\underline{\mathbb{T}}_{1,0}(\underline{\mathbb{T}}_{1,1}^-)^2}{\underline{\mathbb{T}}_{0,0}(\underline{\mathbb{T}}_{2,1})^2}, \quad \text{and } \frac{\mathbf{T}_{1,2}}{\mathbf{T}_{1,1}^-} = -\frac{h^{[+2]}}{h} \frac{\underline{\mathbb{T}}_{1,2}}{\underline{\mathbb{T}}_{1,1}^-} \quad (\text{IV.112})$$

$$\text{hence } \boxed{\mathbf{C} = \frac{Y_{1,1}}{Y_{2,2}} \frac{\underline{\mathbb{T}}_{0,0}^-}{\underline{\mathbb{T}}_{1,0}} \left(\frac{\underline{\mathbb{T}}_{2,1}}{\underline{\mathbb{T}}_{1,2}} \frac{\underline{\mathbb{T}}_{1,1}^-}{\underline{\mathbb{T}}_{1,1}^-} \right)^2 = \left(\frac{U}{U^{[+2]}} \frac{f^+ h^{[+2]}}{f^{[+3]} h} \right)^2}. \quad (\text{IV.113})$$

Therefore, we see that the analyticity of \mathbf{C} on the upper half plane proves that $h^{[+2]}/h$ is analytic on the upper-half plane, but it is not yet sufficient in order to prove that h is analytic on the upper-half plane. Indeed, one can easily find a solution h_0 of the equation $\left(\frac{U}{U^{[+2]}} \frac{f^+ h_0^{[+2]}}{f^{[+3]} h_0} \right)^2 = \mathbf{C}$ such that h_0 is analytic on the upper-half plane, but then we have $h = h_0 X$ where X is an arbitrary i -periodic function.

We can notice that the function $\tilde{h} = h_0 \sqrt{X \bar{X}}$ also obeys $\mathbb{T}_{1,s} = \tilde{h}^{[+s]} \bar{\tilde{h}}^{[-s]} \underline{\mathbb{T}}_{1,s}$, and we will actually show that \tilde{h} is analytic on the upper-half plane, which will allow to conclude by renaming the functions as $\tilde{h} \rightsquigarrow h$. To this end we simply have to notice that $\underline{\mathbb{T}}_{2,s} \in \mathcal{A}_{s-1}$ whereas $\mathbb{T}_{2,s} = \mathbf{T}_{2,s} = \mathbf{T}_{s,2} \in \mathcal{A}_{s-1}$, so that their ratio is

$$\frac{\mathbb{T}_{2,s}}{\mathbf{T}_{2,s}} = h^{[+s+1]} h^{[+s-1]} \bar{h}^{[-s+1]} \bar{h}^{[-s-1]} \in \mathcal{A}_{s-1}, \quad (\text{IV.114})$$

which gives $X \bar{X} \in \mathcal{A}_{s-2}$ for arbitrary s . Hence $X \bar{X}$ is analytic on the whole complex plane, which allows to conclude that \tilde{h} is analytic on the upper-half-plane.

The above argument proves the analyticity of the gauge $\mathbb{T}_{a,s}$ in the right strip, and in particular, it allows to conclude (from the analyticity property (IV.24) of the $\underline{\mathbb{T}}$ -functions and from their relation (IV.109) to the \mathbb{T} -functions) that

$$\mathbb{T}_{1,s} \in \mathcal{A}_s. \quad (\text{IV.115})$$

IV.4.2 The \mathbb{Z}_4 symmetry

Let us now introduce another fundamental analyticity condition on the Y - T - and q -functions, which we call the \mathbb{Z}_4 symmetry. As we have already noticed in the asymptotic limit, this symmetry is related to a symmetry between s and $-s$ in a very specific Riemann sheet, which we will introduce.

IV.4.2.1 The “magic” sheet and the \mathbb{Z}_4 symmetry.

As we have seen already, the Y -system equation holds only on a very specific Riemann sheet, called the mirror sheet, and where the Y - T - and q -functions have cuts at positions $\check{Z}_n \equiv \{x + i\frac{n}{2} | x \in]-\infty, -2g] \cup [2g, \infty[\}$. On the other hand, we have seen in the asymptotic limit (in section IV.2) that there exists another sheet, which coincides with the mirror sheet inside the analyticity strip, but has only “short” Zhukovsky cuts, at position $\hat{Z}_n \equiv \{x + i\frac{n}{2} | x \in [-2g, 2g] \}$.

“magic” T -functions We will now explain this \mathbb{Z}_4 symmetry in terms of T -functions. This symmetry will be the finite-size generalization of the relation (IV.19). With the present notations for the various gauges, it reads

$$\boxed{\hat{\mathbb{T}}_{\rightarrow a, -s} = (-1)^a \hat{\mathbb{T}}_{\rightarrow a, s}}, \quad \boxed{\hat{\mathbb{T}}_{-a, s} = (-1)^s \hat{\mathbb{T}}_{a, s}}, \quad (\text{IV.116})$$

where the T -functions with a “hat” symbol denote an analytic continuation in the variable a (resp s) performed in a sheet with “short” cuts of the form \hat{Z}_n . For instance for the right band, it means that

$$\forall s \in \mathbb{Z}, \quad \hat{\mathbb{T}}_{\rightarrow 0, s} = 1, \quad (\text{IV.117a})$$

$$\forall s \in \mathbb{Z}, \quad \hat{\mathbb{T}}_{\rightarrow 1, s} = \hat{q}_{\rightarrow \{1\}}^{[+s]} \hat{q}_{\rightarrow \{2\}}^{[-s]} + \hat{q}_{\rightarrow \{2\}}^{[+s]} \hat{q}_{\rightarrow \{1\}}^{[-s]}, \quad (\text{IV.117b})$$

$$\forall s \in \mathbb{Z}, \quad \hat{\mathbb{T}}_{\rightarrow 2, s} = \left(\hat{q}_{\rightarrow \{1\}}^+ \hat{q}_{\rightarrow \{2\}}^- - \hat{q}_{\rightarrow \{1\}}^- \hat{q}_{\rightarrow \{2\}}^+ \right)^{[+s]} \left(\hat{q}_{\rightarrow \{1\}}^- \hat{q}_{\rightarrow \{2\}}^+ - \hat{q}_{\rightarrow \{1\}}^+ \hat{q}_{\rightarrow \{2\}}^- \right)^{[-s]} \quad (\text{IV.117c})$$

where $\hat{q}_{\rightarrow \{i\}}$ denotes the analytic continuation of $q_{\rightarrow \{i\}}$ to a sheet having only “short” cuts. This definition of $\hat{q}_{\rightarrow \{i\}}$ means that

$$\text{if } \text{Im}(\mathbf{u}) > 0, \quad \text{then } \hat{q}_{\rightarrow \{i\}}(\mathbf{u}) \equiv q_{\rightarrow \{i\}}(\mathbf{u}), \quad (\text{IV.118})$$

$$\text{and } \hat{q}_{\rightarrow \{i\}}(\mathbf{u}) \text{ is analytic when } \mathbf{u} \in \mathbb{C} \setminus \bigcup_{n \leq 0} \hat{Z}_{2n} \quad (\text{IV.119})$$

$$\text{whereas } q_{\rightarrow \{i\}}(\mathbf{u}) \text{ is analytic when } \mathbf{u} \in \mathbb{C} \setminus \bigcup_{n \leq 0} \check{Z}_{2n}. \quad (\text{IV.120})$$

We can define $\hat{q}_{\leftarrow \{i\}}$ by the same prescription (namely that it coincides with $\bar{q}_{\leftarrow \{i\}}$ when $\text{Im}(\mathbf{u}) < 0$ and that it has only shorts Zhukovsky cuts), and we then notice that

$$\hat{q}_{\leftarrow \{i\}} = \overline{\hat{q}_{\rightarrow \{i\}}}. \quad (\text{IV.121})$$

The above definition (IV.117) of $\hat{\mathbb{T}}_{\rightarrow a,s}$ differs from the expressions (IV.31,IV.30,IV.32) of $\mathbb{T}_{\rightarrow a,s}$ (without “hat”) by two features:

- The expressions (IV.31,IV.30,IV.32) of $\mathbb{T}_{\rightarrow a,s}$ (without “hat”) were valid only when $s \geq a$. Indeed, the solution of Hirota equation on a \mathbb{T} -hook is given by three different Wronskian expressions in the upper band, the right band and the left band (see Statement 6 (page 125)). If we use the same Wronskian expression in the left band, it means that for $s \leq a$ the T -functions with a “hat” do not corresponds to the T -functions of the \mathbb{T} -hook. In particular the Hirota equation at $a = 2$ ensures that for all s , $\hat{\mathbb{T}}_{\rightarrow 3,s} = 0$, which shows that the upper band does not exist for the functions $\hat{\mathbb{T}}_{\rightarrow a,s}$.

This definition of $\hat{\mathbb{T}}_{\rightarrow a,s}$ having the same Wronskian expression when $s \leq a$ as when $s \geq a$ means that we are doing an analytic continuation in the variable s .

- The q -functions $\underline{q}_{\rightarrow \{i\}}$ are replaced by $\hat{q}_{\rightarrow \{i\}}$. This means that we are working in a Riemann sheet having only “short” cuts. We see that if $s \geq a$, then $\hat{\mathbb{T}}_{\rightarrow a,s}$ coincides with $\mathbb{T}_{\rightarrow a,s}$ inside the analyticity strip \mathbf{A}_{s+1-a} , and they only differ outside this analyticity strip. That is why we say that $\hat{\mathbb{T}}_{\rightarrow a,s}$ is defined on the “magic sheet”, which is the Riemann sheet which coincides with the mirror sheet inside the analyticity strip but has only “short” cuts.

These new T -functions, obtained by an analytic continuation in the variable s performed in a sheet with “short” cuts, will be called “magic” T -functions. They can also be defined for the upper band, and then the analytic continuation will be performed with respect to the variable a (instead of s) and we obtain:

$$\forall a \in \mathbb{Z}, \quad \hat{\mathbf{T}}_{a,2} = \hat{\mathbf{q}}_{\emptyset}^{[+a]} \hat{\mathbf{q}}_{\emptyset}^{[-a]}, \quad (\text{IV.122a})$$

$$\forall a \in \mathbb{Z}, \quad \hat{\mathbf{T}}_{a,1} = \hat{\mathbf{q}}_1^{[+a]} \hat{\mathbf{q}}_2^{[-a]} + \hat{\mathbf{q}}_2^{[+a]} \hat{\mathbf{q}}_1^{[-a]} + \hat{\mathbf{q}}_3^{[+a]} \hat{\mathbf{q}}_4^{[-a]} + \hat{\mathbf{q}}_4^{[+a]} \hat{\mathbf{q}}_3^{[-a]}, \quad (\text{IV.122b})$$

$$\forall a \in \mathbb{Z}, \quad \hat{\mathbf{T}}_{a,0} = \hat{\mathbf{q}}_{12}^{[+a]} \hat{\mathbf{q}}_{12}^{[-a]} - \hat{\mathbf{q}}_{13}^{[+a]} \hat{\mathbf{q}}_{24}^{[-a]} - \hat{\mathbf{q}}_{14}^{[+a]} \hat{\mathbf{q}}_{23}^{[-a]} \quad (\text{IV.122c})$$

$$- \hat{\mathbf{q}}_{23}^{[+a]} \hat{\mathbf{q}}_{14}^{[-a]} - \hat{\mathbf{q}}_{24}^{[+a]} \hat{\mathbf{q}}_{13}^{[-a]} + \hat{\mathbf{q}}_{34}^{[+a]} \hat{\mathbf{q}}_{34}^{[-a]}. \quad (\text{IV.122d})$$

$$\forall a, s, \quad \hat{\mathbf{T}}_{a,-s} = \hat{\mathbf{T}}_{a,s}. \quad (\text{IV.122e})$$

As compared to the expression (IV.103), we see that an analytic continuation with respect to the variable a is performed, and we define the functions $\hat{\mathbf{q}}_I(\mathbf{u})$ which coincide with $\mathbf{q}_I(\mathbf{u})$ when $\text{Im}(\mathbf{u}) \geq -1/2 + \left| \frac{|I|-2}{2} \right|$ (where it is analytic), and which differs from $\mathbf{q}_I(\mathbf{u})$ by the fact that it has only “short” cuts.

\mathbb{Z}_4 symmetric gauges With these definitions of the “magic” T -functions (denoted with a “hat”), there are several gauges which obey the \mathbb{Z}_4 symmetry. This allows to write, for the gauges introduced above,

$$\forall a \leq 3, \quad \forall s \in \mathbb{Z}, \quad \hat{\mathbb{T}}_{\rightarrow a,-s} = (-1)^a \hat{\mathbb{T}}_{\rightarrow a,s}, \quad \text{and} \quad \hat{\mathbf{T}}_{a,-s} = (-1)^a \hat{\mathbf{T}}_{a,s}, \quad (\text{IV.123})$$

$$\forall a \in \mathbb{Z}, \quad \forall s \in \llbracket -2, 2 \rrbracket, \quad \hat{\mathbf{T}}_{-a,s} = (-1)^s \hat{\mathbf{T}}_{a,s}. \quad (\text{IV.124})$$

IV.4.2.2 Motivation from the strong coupling limit

We already saw that in the asymptotic limit, this symmetry is (at least for the right band) easily seen from the explicit expressions of the \overrightarrow{T} -functions. There actually exists another limit where this symmetry gets all its meaning as a symmetry of the string theory on $AdS_5 \times S^5$.

This limit is the strong coupling limit, where the coupling g is very large. In the literature, one method to study this limit is called the “finite gap” approach [Gro10, GKT10]. Applying this approach to the string theory on $AdS_5 \times S^5$, one can show that the T -functions become characters, explicitly written in [11GKLT] (see eqs. (4.12-21) there), in the highest weight representation $\lambda_{[a,s]}$ of $PSU(2,2|4)$:

$$T_{a,s} = \text{trace}_{\lambda_{[a,s]}} \Omega(\mathbf{u}/g) \equiv \chi^{(a,s)} \Omega(\mathbf{u}/g). \quad (\text{IV.125})$$

Here $\Omega(\mathbf{u}) \in PSU(2,2|4)$ is the classical monodromy matrix, which depends on the ratio \mathbf{u}/g . For these representations (like for the characters used in chapter II), the characters obey an \mathbf{u} -independent Hirota equation, i.e.

$$(\chi^{(a,s)} \Omega)^2 = \chi^{(a+1,s)}(\Omega) \chi^{(a-1,s)}(\Omega) + \chi^{(a,s+1)}(\Omega) \chi^{(a,s-1)}(\Omega). \quad (\text{IV.126})$$

By comparison, it is the product $\chi^{(a,s)} \left(\Omega(\frac{\mathbf{u}+i/2}{g}) \right) \chi^{(a,s)} \left(\Omega(\frac{\mathbf{u}-i/2}{g}) \right)$ which would appear in the left-hand-side of the Hirota equation (III.57). But as $g \rightarrow \infty$, the shift $\frac{i/2}{g}$ is negligible and the expression (IV.125) becomes a solution of the Hirota equation in the strong coupling limit.

In other words, $\Omega(\mathbf{u}/g)$ varies only if \mathbf{u} varies by amounts of order g . By comparison, the shift $\pm i/2$ in the Hirota equation can be neglected. One should also note that in [11GKLT], this identification of $T_{a,s} = \chi^{(a,s)}(\Omega(\mathbf{u}/g))$ was made in the mirror sheet and the expression (IV.125) should be considered in the mirror kinematics. As a function of \mathbf{u} , $\Omega(\mathbf{u}/g)$ has only one Zhukovsky cut on \check{Z}_0 with an essential singularity at the branch points $\mathbf{u} = \pm 2g$. This can be understood as the fact that an infinite number of \check{Z} -cuts located on \check{Z}_n collide (because the shift $in/2$ can be neglected when $g \rightarrow \infty$) into a single cut \check{Z}_0 .

In this limit, the matrix Ω has a physical definition (as a string’s monodromy matrix), and the \mathbb{Z}_4 symmetry of the corresponding coset sigma model [BPR04] imposes a constraint on Ω [BKSZ06], which can be written in terms of its eigenvalues $(\mu_1, \mu_2, \dots, \mu_8)$. This constraint reads

$$\mu_1(\mathbf{u}) = 1/\mu_2([\mathbf{u}]_\gamma), \quad \mu_3(\mathbf{u}) = 1/\mu_4([\mathbf{u}]_\gamma), \quad \mu_5(\mathbf{u}) = 1/\mu_6([\mathbf{u}]_\gamma), \quad \mu_7(\mathbf{u}) = 1/\mu_8([\mathbf{u}]_\gamma), \quad (\text{IV.127})$$

where we denote by $F([\mathbf{u}]_\gamma)$ the result of the analytic continuation of a function F following a contour which encircles the branch point $\mathbf{u} = 2g$, but which avoids the other singularities arising in the finite gap solution¹³.

¹³ These singularities which we avoid are square root cuts of the functions $\mu_i(\mathbf{u})$, but these cuts are absent in the monodromy matrix

An explicit expression of the characters $\chi^{(a,s)}$ of a matrix, as functions of its eigenvalues, can be written explicitly (see [GKT10]), and it allows to see that the property (IV.127) implies the following symmetry

$$\begin{cases} T_{a,s}(\mathbf{u}) = (-1)^s T_{a,-\widehat{s}}([\mathbf{u}]_\gamma), & \text{if } |s| \geq a, \\ T_{a,s}(\mathbf{u}) = (-1)^a T_{-\widehat{a},s}([\mathbf{u}]_\gamma), & \text{if } a \geq |s|, \end{cases} \quad \begin{matrix} \text{(IV.128a)} \\ \text{(IV.128b)} \end{matrix}$$

where the functions $T_{a,-\widehat{s}}([\mathbf{u}]_\gamma)$ (resp $T_{-\widehat{a},s}([\mathbf{u}]_\gamma)$) denote the analytic continuations of the functions T with respect to the argument s (resp a) from the values $s > a$ (resp $a > |s|$).

One can expect that the symmetry (IV.128), will hold even at finite g , but if we want to generalize from the strong coupling to the “quantum case” (when g is finite), one difficulty is that we have to identify the contour γ . Indeed, at strong coupling, we saw that several branch point “collide” into the position $\pm 2g$, whereas in the quantum case, there are distinct branch points at the position $\pm 2g + \frac{i}{2}n$, and the position of the contour with respect to each branch point has to be specified. From the study of the asymptotic limit and from our study of the analytic properties of the T and q -functions, we can propose one natural generalization of the equation (IV.128) to the quantum case.

Let us first consider the T -functions in the right band. They can be expressed as follows in terms of q -functions:

$$\forall s \geq 1, \quad T_{1,s} = q_{\{1\}}^{[+s]} p_{\{2\}}^{[-s]} - q_{\{2\}}^{[+s]} p_{\{1\}}^{[-s]}, \quad \text{(IV.129)}$$

$$\forall s \in \mathbb{Z}, \quad T_{1,\widehat{s}} = q_{\{1\}}^{[+s]} p_{\{2\}}^{[-s]} - q_{\{2\}}^{[+s]} p_{\{1\}}^{[-s]}. \quad \text{(IV.130)}$$

If we restrict to the q -functions (as opposed to the p -functions), we can see that in (IV.128a), the transformation $T_{a,s}(\mathbf{u}) \rightsquigarrow T_{a,-\widehat{s}}(\mathbf{u})$ can be rewritten as

$$T_{a,s}(\mathbf{u}) \rightsquigarrow T_{a,-\widehat{s}}(\mathbf{u}) \quad \Rightarrow \quad q_{\{i\}} \left(\mathbf{u} + \frac{i}{2}s \right) \rightsquigarrow q_{\{i\}} \left(\mathbf{u} - \frac{i}{2}s \right).$$

To obtain the transformation of equation (IV.128a), we should also apply the transformation $T_{a,-\widehat{s}}(\mathbf{u}) \rightsquigarrow T_{a,-\widehat{s}}([\mathbf{u}]_\gamma)$ which reads

$$T_{a,-\widehat{s}}(\mathbf{u}) \rightsquigarrow T_{a,-\widehat{s}}([\mathbf{u}]_\gamma) \quad \Rightarrow \quad q_{\{i\}} \left(\mathbf{u} - \frac{i}{2}s \right) \rightsquigarrow q_{\{i\}} \left(\left[\mathbf{u} - \frac{i}{2}s \right]_\gamma \right),$$

where $[\mathbf{u} - \frac{i}{2}s]_\gamma$ denotes the analytic continuation from position $\mathbf{u} - \frac{i}{2}s$, around the branch point $\mathbf{u} = 2g$, and then back to position $\mathbf{u} - \frac{i}{2}s$. If we perform this continuation clockwise, as in figure IV.3, then we notice that the transformation

$$T_{a,s}(\mathbf{u}) \rightsquigarrow T_{a,-\widehat{s}}([\mathbf{u}]_\gamma) \quad \Rightarrow \quad q_{\{i\}} \left(\mathbf{u} + \frac{i}{2}s \right) \rightsquigarrow q_{\{i\}} \left(\left[\mathbf{u} - \frac{i}{2}s \right]_\gamma \right),$$

is the continuation $\mathbf{u} + \frac{i}{2}s \rightsquigarrow [\mathbf{u} - \frac{i}{2}s]_\gamma$, which is nothing but the continuation from position $\mathbf{u} + \frac{i}{2}s$ into position $\mathbf{u} - \frac{i}{2}s$ avoiding a short Zhukovsky cut \widehat{Z}_0 . The same

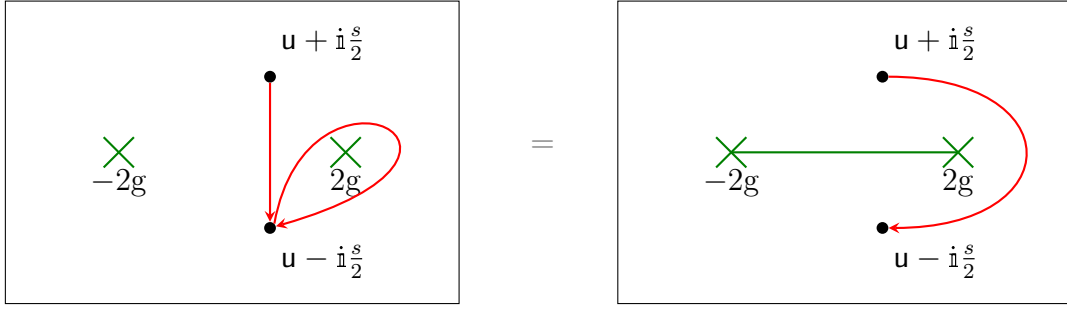

Figure IV.3: Equivalent representations of the analytic continuation of the q -functions in (IV.128).

observation holds for p -functions if the continuation $[u]_\gamma$ is made counterclockwise¹⁴. Therefore (IV.128) can be reformulated as follows (for the right band):

$$T_{a,s}(\mathbf{u}) = (-1)^a \hat{T}_{a,-s}(\mathbf{u}). \quad (\text{IV.131})$$

where $\hat{T}_{a,-s}$ is defined by the analytic continuation $s \rightsquigarrow -s$ performed in sheet which only has “shorts” Zhukovsky cuts.

Generically, the q -functions have an infinite number of cuts in the quantum case (when g is finite), and then the above argument does not explain what path should be used (which branch points should, or should not be encircled by the path γ). But we will see that in the right band, in the gauges \underline{T} and T , the \hat{q} -functions have only one single Zhukovsky cut (on the real axis), and the above argument is non-ambiguous. Hence, we obtain that in the right band, the relation (IV.131) is the most natural generalization of the classical \mathbb{Z}_4 symmetry (IV.128a).

A similar analysis for the upper band is more tricky. However, one can show (see appendix (C.4) in [11GKLV]), that the \mathbb{Z}_4 symmetry (IV.124) for the upper band can be derived from the \mathbb{Z}_4 symmetry (IV.131) in the right band.

IV.4.2.3 Relation to the thermodynamic Bethe ansatz

Exactly like the statements about the physical gauge in the previous section, the above statement of the \mathbb{Z}_4 symmetry can be derived from the TBA-equations. We presented this proof in [11GKLV] and we will not repeat it here in details. This proof relies on the TBA-equations [GKKV10] for the functions $Y_{1,s}$ (where $s \geq 2$), where we can write the Y-functions as $Y_{1,s} = 1 / \left(\frac{T_{1,s}^+ T_{1,s}^-}{T_{1,s+1} T_{1,s-1}} - 1 \right)$ (see (III.82)), which allows to notice the cancellations between several T -functions (the idea is the same as in section IV.4.1.2, but it is more technical). At the end of the day we obtain $\hat{\underline{T}}_{1,0} = 0$. As compared to the expression (IV.117b) of $\hat{\underline{T}}_{1,s}$ (where we should note, from (IV.29) and (IV.51), that

¹⁴There is no apparent contradiction in this prescription which uses opposite directions for the contour γ in the continuation of the p - and q -functions. Indeed, we see in (IV.127) that $\Omega\left(\frac{[u]_\gamma}{g}\right) = \Omega\left(\frac{u}{g}\right)$, which means that the continuation through the contours γ and γ^{-1} are identical.

$\underline{\hat{q}}_{\{1\}} = 1 = -\underline{\hat{p}}_{\{1\}}$ and that $\underline{\hat{p}}_{\{2\}} = \underline{\hat{q}}_{\{1\}}$, it gives

$$\underline{\hat{T}}_{1,0} = \underline{\hat{q}}_{\{1\}} \underline{\hat{q}}_{\{2\}} + \underline{\hat{q}}_{\{2\}} \underline{\hat{q}}_{\{1\}} = \underline{\hat{q}}_{\{2\}} - \underline{\hat{q}}_{\{2\}} = 0. \quad (\text{IV.132})$$

This shows that the functions $\underline{\hat{q}}_{\{2\}}$ and $\underline{\hat{q}}_{\{1\}}$ are equal, which implies that

$$\underline{\hat{T}}_{1,s} = \underline{\hat{q}}_{\{2\}}^{-s} - \underline{\hat{q}}_{\{2\}}^{+s} = -\underline{\hat{T}}_{1,-s}. \quad (\text{IV.133})$$

We will see in the next section how to prove that the function h (in (IV.109)) gives rise to a function \hat{h} which has only one cut \widehat{Z}_0 on the magic sheet, but this property allows to prove that the \mathbb{Z}_4 symmetry holds in the gauge $\mathbb{T}_{a,s}$ as well, which gives the equation (IV.123). Finally, one can show that the condition $\underline{\hat{T}}_{1,0} = 0$ (which is obtained from the TBA-equations) allows to prove that $\underline{\hat{T}}_{0,1} = 0$, which gives the equation (IV.124) (see [11GKLV] for more details).

IV.4.2.4 Relation to the analyticity of $Y_{1,1}$ and $Y_{2,2}$

Instead of giving here a detailed proof of this \mathbb{Z}_4 symmetry from the TBA-equations, let us show on a simple example (for the right band) the relation between this symmetry and the analyticity conditions (IV.20) on the function $Y_{1,1}$ and $Y_{2,2}$.

The analyticity conditions (IV.20) are equivalent to the conditions¹⁵

$$\forall u \in]-\infty, -2g] \cup [2g, \infty[, \quad \begin{cases} \mathbf{r}(u + 0i) = 1/\mathbf{r}(u - 0i), \\ \mathbf{s}(u + 0i) = 1/\mathbf{s}(u - 0i), \end{cases} \quad (\text{IV.134a})$$

$$\quad \quad \quad (\text{IV.134b})$$

$$\text{where } \mathbf{r} \equiv \frac{1 + 1/Y_{2,2}}{1 + Y_{1,1}} = \frac{T_{2,2}^+ T_{2,2}^- T_{0,1}}{T_{1,1}^+ T_{1,1}^- T_{2,3}}, \quad \mathbf{s} \equiv \frac{1 + Y_{2,2}}{1 + 1/Y_{1,1}} = \frac{T_{2,2}^+ T_{2,2}^- T_{1,0}}{T_{1,1}^+ T_{1,1}^- T_{3,2}}. \quad (\text{IV.135})$$

When these (gauge-invariant) ratios are written in terms of T -functions, we see that \mathbf{s} only involves the functions $T_{a,s}$ where $a \geq |s|$ (i.e. the T -functions which lie in the upper band). We also see that \mathbf{r} only involves the functions $T_{a,s}$ where $s \geq a$ (i.e. the T -functions which lie in the right band). This allows to write the gauge invariant ratio \mathbf{r} in terms of the T -functions in the gauge $\underline{\mathbb{T}}$, which we parameterized in section IV.3.2 when $s \geq a$:

$$\mathbf{r} = \frac{\underline{\mathbb{T}}_{2,2}^+ \underline{\mathbb{T}}_{2,2}^- \underline{\mathbb{T}}_{0,1}}{\underline{\mathbb{T}}_{1,1}^+ \underline{\mathbb{T}}_{1,1}^- \underline{\mathbb{T}}_{2,3}} = \frac{\left(\underline{q}_{\{2\}}^{[+2]} - \underline{q}_{\{2\}} \right) \left(-\underline{\bar{q}}_{\{2\}} + \underline{\bar{q}}_{\{2\}}^{[-2]} \right)}{\left(\underline{q}_{\{2\}}^{[+2]} + \underline{\bar{q}}_{\{2\}} \right) \left(\underline{q}_{\{2\}} + \underline{\bar{q}}_{\{2\}}^{[-2]} \right)}. \quad (\text{IV.136})$$

¹⁵We use here the notation $F(u \pm 0i) \equiv F^{[\pm 0]}$ to denote the limit of $F(u \pm i\epsilon)$ when ϵ tends to zero (but $\epsilon > 0$).

More generally, we will use the notation $F(u + \frac{i}{2}n \pm 0i) \equiv F^{[+n \pm 0]}$ to denote the limit of $F(u + \frac{i}{2}n \pm i\epsilon)$ when ϵ tends to zero (but $\epsilon > 0$).

In order to understand the relation between $\mathbf{r}^{[+0]}$ and $\mathbf{r}^{[-0]}$, we can notice that due to the analyticity domains given in (IV.52,IV.53), we have

$$\forall \mathbf{u} \in \mathbb{R}, \quad \underline{q}_{\{2\}}^{[+2+0]} = \underline{q}_{\{2\}}^{[+2-0]}, \quad \text{and} \quad \bar{q}_{\{2\}}^{[-2+0]} = \bar{q}_{\{2\}}^{[-2-0]}. \quad (\text{IV.137})$$

Hence we see that the condition (IV.134a) reads

$$\forall \mathbf{u} \in \check{Z}_0, \quad \frac{\left(\underline{q}_{\{2\}}^{[+2]} - \underline{q}_{\{2\}}^{[+0]} \right) \left(-\bar{q}_{\{2\}}^{[+0]} + \bar{q}_{\{2\}}^{[-2]} \right)}{\left(\underline{q}_{\{2\}}^{[+2]} + \bar{q}_{\{2\}}^{[+0]} \right) \left(\underline{q}_{\{2\}}^{[+0]} + \bar{q}_{\{2\}}^{[-2]} \right)} = \frac{\left(\underline{q}_{\{2\}}^{[+2]} + \bar{q}_{\{2\}}^{[-0]} \right) \left(\underline{q}_{\{2\}}^{[-0]} + \bar{q}_{\{2\}}^{[-2]} \right)}{\left(\underline{q}_{\{2\}}^{[+2]} - \bar{q}_{\{2\}}^{[-0]} \right) \left(-\bar{q}_{\{2\}}^{[-0]} + \bar{q}_{\{2\}}^{[-2]} \right)} \quad (\text{IV.138})$$

The simplest way to ensure this property is to have

$$\forall \mathbf{u} \in \check{Z}_0, \quad \underline{q}_{\{2\}}^{[-0]} = -\bar{q}_{\{2\}}^{[+0]}, \quad (\text{IV.139a})$$

$$\forall \mathbf{u} \in \check{Z}_0, \quad \bar{q}_{\{2\}}^{[-0]} = -\underline{q}_{\{2\}}^{[+0]}. \quad (\text{IV.139b})$$

We will now show that the condition (IV.139b)¹⁶ is exactly the \mathbb{Z}_4 property $\hat{\mathbb{T}}_{\mathbf{a},-s} = (-1)^a \hat{\mathbb{T}}_{\mathbf{a},s}$. Then we will show how to obtain (IV.139a) from (IV.139b). That will show that the \mathbb{Z}_4 symmetry implies the relation (IV.134a). The same program can be followed for the ratio \mathbf{r} (see [11GKLV]), but we will not repeat it here.

\mathbb{Z}_4 symmetry from (IV.139b) As we see from the definition (IV.52,IV.52) (and from the Statement 8 (page 147)), the jump density ρ which parameterizes the function $\underline{q}_{\{2\}}$ is equal to $\rho = \underline{q}_{\{2\}}^{[+0]} + \bar{q}_{\{2\}}^{[-0]}$. Therefore, the condition (IV.139b) implies that

$$\forall \mathbf{u} \in \check{Z}_0, \quad \rho(\mathbf{u}) = 0. \quad (\text{IV.140})$$

This means that the function $G \equiv -i\mathbf{u} + \mathcal{K} * \rho$ has no jump on \check{Z}_0 , and is therefore analytic on $\mathbb{C} \setminus [-2g, 2g]$. Hence we see that G is a function which coincides with $\underline{q}_{\{2\}}$ when $\text{Im}(\mathbf{u}) > 0$ and which has only short Zhukovsky cuts. In our notations, this means that $G = \hat{\underline{q}}_{\{2\}}$. Moreover we also see that G coincides with $\bar{q}_{\{2\}}$ when $\text{Im}(\mathbf{u}) < 0$, which gives $\hat{\bar{q}}_{\{2\}} = G = \hat{\underline{q}}_{\{2\}}$. Hence we have

$$\hat{T}_{0,s} = 1 = \hat{T}_{0,-s} \quad (\text{IV.141})$$

$$\hat{T}_{1,s} = \hat{\underline{q}}_{\{2\}}^{[+s]} + \hat{\bar{q}}_{\{2\}}^{[-s]} = \hat{\underline{q}}_{\{2\}}^{[+s]} + \hat{\underline{q}}_{\{2\}}^{[-s]} = -\hat{T}_{1,-s}. \quad (\text{IV.142})$$

$$\hat{T}_{2,s} = \left(\hat{\underline{q}}_{\{2\}}^{[+s+1]} - \hat{\underline{q}}_{\{2\}}^{[+s-1]} \right) \left(\hat{\bar{q}}_{\{2\}}^{[-s-1]} - \hat{\bar{q}}_{\{2\}}^{[-s+1]} \right) \quad (\text{IV.143})$$

$$= \left(\hat{\underline{q}}_{\{2\}}^{[+s+1]} - \hat{\underline{q}}_{\{2\}}^{[+s-1]} \right) \left(\hat{\underline{q}}_{\{2\}}^{[-s-1]} - \hat{\underline{q}}_{\{2\}}^{[-s+1]} \right) = \hat{T}_{1,1}^{[+s]} \hat{T}_{1,1}^{[-s]} = \hat{T}_{2,-s}. \quad (\text{IV.144})$$

¹⁶The present argument is a motivation (not a proof) for the \mathbb{Z}_4 symmetry, hence the equation is simply guessed (IV.139b). A more rigorous proof, sketch in the previous section, can be found in [11GKLV].

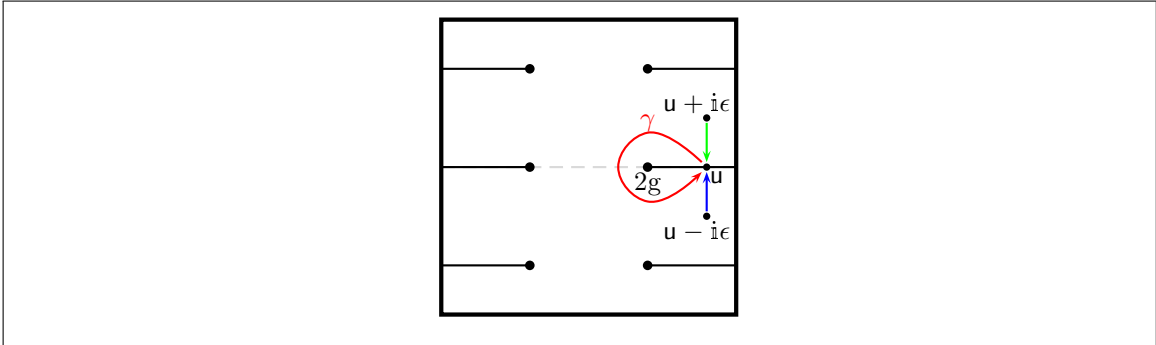

Figure IV.4: path γ around the branch point $2g$.

The path γ (in red) is a path which starts from point $u \in \check{Z}_0$, encircles the branch point at position $2g$, and comes back to the point u . We see that if a function F has a long cut on \check{Z}_0 , then $F(u+i0)$ denotes the limit of $F(u+i\epsilon)$, obtained by continuation of the function F along the green arrow. This means that the argument u of $F(u+i0)$ sits exactly on the real axis, but that the value $F(u+i0)$ is obtained by continuation from the expression of F above the cut. Then we see that after the continuation along the contour γ (in red), we still obtain the function F at position $u \in \mathbb{R}$, but now u is approached from below, exactly like a continuation from $F(u-i\epsilon)$ along the blue arrow which defines $F(u-i0)$. Hence, we have $F([u+i0]_\gamma) = F(u-i0)$.

This shows that the \mathbb{Z}_4 symmetry $\hat{T}_{a,-s} = (-1)^a \hat{T}_{a,s}$ (see (IV.116)) is implied by the property (IV.139b). One easily shows that the converse is true, and that the equation $\hat{T}_{\gamma a,-s} = (-1)^a \hat{T}_{\gamma a,s}$, which states the \mathbb{Z}_4 symmetry of the right band, is equivalent to the condition (IV.139b).

Relation between (IV.139a) and (IV.139b) It is usual in this study on integrability to assume that the branch points are quadratic, in the sense that for a contour γ which encircles a branch point of a function F , we have $F\left(\left[[u]_\gamma\right]_\gamma\right) = F(u)$, where the notation $F([u]_\gamma)$, introduced in section IV.4.2.2, denotes the analytic continuation of $F(u)$ along the contour γ .

For $u > 2g$ (for instance), we can define a contour γ which encircles $2g$ in the counter-clockwise direction (see figure IV.4) and then for an arbitrary function F having a cut on \check{Z}_0 , we see that $F([u+i0]_\gamma) = F(u-i0)$. Hence we see that the condition (IV.139b) can be rewritten as

$$\underline{q}_{\{2\}}(u+i0) = -\bar{\underline{q}}_{\{2\}}\left([u+i0]_\gamma\right). \quad (\text{IV.145})$$

Assuming that the cuts are of square root type, this allows to deduce that

$$\underline{q}_{\{2\}}\left([u+i0]_\gamma\right) = -\bar{\underline{q}}_{\{2\}}(u+i0), \quad (\text{IV.146})$$

which exactly gives $\underline{q}_{\{2\}}^{[-0]} = -\bar{\underline{q}}_{\{2\}}^{[+0]}$, which is the identity (IV.139a). This shows that

how (IV.139a) follows from (IV.139b), under the assumption that the branch point is of square root type.

conclusion As we said the \mathbb{Z}_4 symmetry can be either motivated from physical symmetries of the string theory on $AdS_5 \times S^5$, or proven from the TBA-equations. For simplicity, we did not repeat here the proof of this symmetry from the TBA-equations (see [11GKLV]), but we illustrated it on a simple example, showing that the analyticity condition (IV.134a) was implied by the \mathbb{Z}_4 symmetry of the right band. The same program can be performed for the upper band, to relate the condition (IV.134b) to the \mathbb{Z}_4 symmetry of the upper band. As the condition (IV.134) is equivalent to the condition (IV.20), we will not view the condition (IV.20) as a fundamental input, but as a consequence of the \mathbb{Z}_4 symmetry.

IV.4.2.5 Consequences on the parameterization of the q -functions.

In the previous subsection, we obtained the equation (IV.140), which states that

$$\hat{\underline{q}}_{\{2\}} = \hat{\underline{q}}_{\{2\}} \quad i.e. \quad \forall \mathbf{u} \in \check{Z}_0, \quad \rho(\mathbf{u}) = 0. \quad (\text{IV.147})$$

This means that the density ρ introduced in section IV.3.2 actually only has the finite support $[-2g, 2g]$.

For the upper band, similar equations can be obtained. Indeed, we have $\hat{\mathbf{T}}_{0,1} = 0$, and $\hat{\underline{\mathbf{T}}}_{0,1} = 0$. As compared to the equation (IV.44), this gives

$$\hat{\underline{\mathbf{T}}}_{0,1} = 0 = \hat{\underline{\mathbf{q}}}_2 + \hat{\underline{\mathbf{q}}}_2 + \hat{\underline{\mathbf{q}}}_3 \hat{\underline{\mathbf{q}}}_4 + \hat{\underline{\mathbf{q}}}_4 \hat{\underline{\mathbf{q}}}_3. \quad (\text{IV.148})$$

We can write this expression on the real axis, but then we have to specify on which side of the cut. For instance if we choose to have a positive imaginary part, then this equation reads

$$\hat{\underline{\mathbf{T}}}_{0,1}^{[+0]} = 0 = \hat{\underline{\mathbf{q}}}_2^{[+0]} + \hat{\underline{\mathbf{q}}}_2^{[+0]} + \hat{\underline{\mathbf{q}}}_3^{[+0]} \hat{\underline{\mathbf{q}}}_4^{[+0]} + \hat{\underline{\mathbf{q}}}_4^{[+0]} \hat{\underline{\mathbf{q}}}_3^{[+0]}. \quad (\text{IV.149})$$

If we remember that by definition the functions $\hat{\underline{\mathbf{q}}}_I$ only have short Zhukovsky cuts, we get

$$\forall \mathbf{u} \in \check{Z}_0, \quad \hat{\underline{\mathbf{q}}}_i^{[+0]} = \hat{\underline{\mathbf{q}}}_i^{[-0]} = \bar{\underline{\mathbf{q}}}_i^{[-0]}, \quad (\text{IV.150})$$

$$\text{hence } \forall \mathbf{u} \in \check{Z}_0, \quad \bar{\underline{\mathbf{q}}}_2^{[-0]} + \underline{\mathbf{q}}_2^{[+0]} + \underline{\mathbf{q}}_3^{[+0]} \bar{\underline{\mathbf{q}}}_4^{[-0]} + \underline{\mathbf{q}}_4^{[+0]} \bar{\underline{\mathbf{q}}}_3^{[-0]} = 0. \quad (\text{IV.151})$$

On this form, this equation involves q -functions which can be written in terms of the parameterization written in section IV.3.2 (because the functions $\underline{\mathbf{q}}_i$ have positive shift and the functions $\bar{\underline{\mathbf{q}}}_i$ have negative shift).

Moreover, we know that both in the $L \rightarrow \infty$ limit and in the $\mathbf{u} \rightarrow \infty$ limit, the two last terms in (IV.151) tend to zero. In the $\mathbf{u} \rightarrow \infty$ limit, this allows to deduce that (in view of the parameterization (IV.63) of $\bar{\underline{\mathbf{q}}}_2^{[-0]} + \underline{\mathbf{q}}_2^{[+0]}$)

$$\bar{P}_0 = -P_0, \quad (\text{IV.152})$$

which means that the polynomial P_0 is imaginary. Moreover in the case of a state with two symmetric Bethe roots (i.e. $M = 2$ and $\mathbf{u}^{(1)} = -\mathbf{u}^{(2)}$), the polynomial P_0 has degree one. Then (up to an irrelevant normalization which we set to one), $P_0(\mathbf{u})$ has to be equal to $-\mathbf{i}\mathbf{u} + \alpha$, where $\alpha \in \mathbf{i}\mathbb{R}$ is a constant term (which is a pure imaginary). But for a symmetric configuration of roots, we know that $q_2(-\mathbf{u}) = \pm \bar{q}_2(\mathbf{u})$, which imposes $\alpha = 0$. Hence, the definition (IV.63) of W becomes

$$W(\mathbf{u}) = -\mathbf{i}\mathbf{u} + \frac{1}{2\mathbf{i}\pi} \int_{\mathbf{v} \in \mathbb{R}} \frac{\tilde{\rho}_2(\mathbf{v})}{\mathbf{v} - \mathbf{u}} d\mathbf{v}, \quad \text{if } \text{Im}(\mathbf{u}) > 0. \quad (\text{IV.153})$$

The equation (IV.151) can also be used to constrain the density $\tilde{\rho}_2$. Indeed, the first terms are $\bar{\mathbf{q}}_2^{[-0]} + \mathbf{q}_2^{[+0]} = \tilde{\rho}_2$, hence we obtain

$$\forall \mathbf{u} \in \check{Z}_0, \quad \tilde{\rho}_2 = -\mathbf{q}_3^{[+0]} \bar{\mathbf{q}}_4^{[-0]} - \mathbf{q}_4^{[+0]} \bar{\mathbf{q}}_3^{[-0]}. \quad (\text{IV.154})$$

Hence we can for instance define a function $\rho_2 \equiv \tilde{\rho}_2 + \mathbf{q}_3^{[+0]} \bar{\mathbf{q}}_4^{[-0]} + \mathbf{q}_4^{[+0]} \bar{\mathbf{q}}_3^{[-0]}$, which is a real function on \mathbb{R} , such that

$$\rho_2 = 0 \quad \text{when } \mathbf{u} \in \check{Z}_0, \quad (\text{IV.155a})$$

$$W = -\mathbf{i}\mathbf{u} + \mathcal{K} * \left(\rho_2 - \mathbf{q}_3^{[+0]} \bar{\mathbf{q}}_4^{[-0]} - \mathbf{q}_4^{[+0]} \bar{\mathbf{q}}_3^{[-0]} \right) \quad \text{when } \text{Im}(\mathbf{u}) > 0. \quad (\text{IV.155b})$$

Then the expressions (IV.147) and (IV.155) are useful because they give rise to densities with finite support, and because they allow to encode the \mathbb{Z}_4 symmetry into the parameterization of the q -functions.

IV.4.3 Set of equations and iterative algorithm

Let us now derive a finite set of equations which allows to write an iterative algorithm leading to a solution to the Y-system equation which obeys the analyticity constraints mentioned above. That will allow to solve the Y-system and to solve the initial spectral problem. As it was said in section IV.3.2, we will restrict for simplicity to the states in the $\text{SL}(2)$ sector, and more specifically to states having two symmetric Bethe roots (i.e. $M = 2$ and $\mathbf{u}^{(1)} = -\mathbf{u}^{(2)}$).

IV.4.3.1 Equation on $Y_{1,1}$ and $Y_{2,2}$

Equation on the product $Y_{1,1}Y_{2,2}$ We already noticed in section IV.4.1 that the existence of the physical gauge was related to the analyticity of the function $\mathbf{B}(\mathbf{u})$ (defined by (IV.95)) when $\text{Im}(\mathbf{u}) > 0$. We also noticed that this analyticity condition allows to write a spectral representation (IV.96) of \mathbf{B} in terms of a jump density ρ_b , where $\rho_b = \log(\mathbf{B} \bar{\mathbf{B}})$ has the piecewise expression (IV.97). In this piecewise expression, we could see that reality conditions could make the functions $Y_{1,1}$ and $Y_{2,2}$ partially disappear in the expression of ρ_b .

Inspired by these observations, we can introduce a new function $\tilde{\mathbf{B}}$ which has a similar expression, but is specifically chosen in such a way that $Y_{1,1}$ and $Y_{2,2}$ disappear from the expression of the corresponding density. Let us define this function as

$$\log \tilde{\mathbf{B}}(\mathbf{u}) \equiv \frac{\log \mathbf{B}(\mathbf{u})}{\sqrt{4g^2 - u^2}}, \quad \text{where } \mathbf{B} = \frac{1}{Y_{1,1}Y_{2,2}} \frac{\mathbb{T}_{\mathbf{0},0}^{1,0}}{\mathbb{T}_{\mathbf{0},0}^-}. \quad (\text{IV.156})$$

Then, if we use the Statement 8 (page 147) with the functions $F(\mathbf{u}) = \log \tilde{\mathbf{B}}(\mathbf{u})$ and $G(\mathbf{u}) = \log \overline{\tilde{\mathbf{B}}(\mathbf{u})} \equiv \log \tilde{\mathbf{B}}(\bar{\mathbf{u}})$, we obtain

$$\log \tilde{\mathbf{B}}(\mathbf{u}) = \mathcal{K} * \tilde{\eta}_b, \quad \text{when } \text{Im}(\mathbf{u}) > 0 \quad (\text{IV.157})$$

where $\tilde{\eta}_b(\mathbf{u}) \equiv \log \tilde{\mathbf{B}}(\mathbf{u}) - \log \overline{\tilde{\mathbf{B}}(\mathbf{u})}$ is equal to

$$\tilde{\eta}_b(\mathbf{u}) = \begin{cases} \frac{1}{\sqrt{4g^2 - u^2}} \log \frac{\mathbb{T}_{\mathbf{0},0}^+}{\mathbb{T}_{\mathbf{0},0}^-}, & \text{if } \mathbf{u} \in \hat{Z}_0 \quad (\text{IV.158a}) \\ \frac{i}{\sqrt{u - 2g}\sqrt{u + 2g}} \log \frac{\mathbb{T}_{\mathbf{0},0}^2}{\mathbb{T}_{\mathbf{0},0}^{[-1+0]}\mathbb{T}_{\mathbf{0},0}^{[+1-0]}}, & \text{if } \mathbf{u} \in \check{Z}_0 \quad (\text{IV.158b}) \end{cases}$$

where $\frac{i}{\sqrt{u-2g}\sqrt{u+2g}}$ appears because it coincides on the real axis with the continuation $\left(\frac{1}{\sqrt{4g^2 - u^2}}\right)^{[+0]}$ of $\frac{1}{\sqrt{4g^2 - u^2}}$ (which is analytic on the upper-half-plane) to the real axis.

The expression (IV.158a) is obtained for $\mathbf{u} \in [-2g, 2g]$ because $\frac{1}{\sqrt{4g^2 - u^2}}$ is real, hence $\tilde{\eta}_b(\mathbf{u}) = \frac{\log(\mathbf{B}(\mathbf{u})/\overline{\mathbf{B}}(\mathbf{u}))}{\sqrt{4g^2 - u^2}}$, where $\log(\mathbf{B}(\mathbf{u})/\overline{\mathbf{B}}(\mathbf{u})) = \log \frac{\mathbb{T}_{\mathbf{0},0}^+}{\mathbb{T}_{\mathbf{0},0}^-}$ (due to the reality of the Y - and T -functions), which gives (IV.158a). On the other hand, the expression (IV.158b) is obtained for $\mathbf{u} \in]-\infty, -2g] \cup [2g, \infty[$ because $\left(\frac{1}{\sqrt{4g^2 - u^2}}\right)^{[+0]} = \frac{i}{\sqrt{u-2g}\sqrt{u+2g}}$ is a phase, hence $\tilde{\eta}_b(\mathbf{u}) = i \frac{\log(\mathbf{B}(\mathbf{u})\overline{\mathbf{B}}(\mathbf{u}))}{\sqrt{u-2g}\sqrt{u+2g}}$, where $\log(\mathbf{B}(\mathbf{u})\overline{\mathbf{B}}(\mathbf{u})) = \rho_b = \log \frac{\mathbb{T}_{\mathbf{0},0}^2}{\mathbb{T}_{\mathbf{0},0}^{[-1+0]}\mathbb{T}_{\mathbf{0},0}^{[+1-0]}}$. This shows that the expression (IV.156) of $\tilde{\mathbf{B}}$ is indeed such that we have a density where $Y_{1,1}$ and $Y_{2,2}$ disappear completely.

These arguments allow to write the equation

$$\mathcal{K} * \tilde{\eta}_b = \log \tilde{\mathbf{B}}(\mathbf{u}) = \frac{\log \mathbf{B}(\mathbf{u})}{\sqrt{4g^2 - u^2}} = \frac{1}{\sqrt{4g^2 - u^2}} \log \left(\frac{1}{Y_{1,1}Y_{2,2}} \frac{\mathbb{T}_{\mathbf{0},0}^{1,0}}{\mathbb{T}_{\mathbf{0},0}^-} \right) \quad (\text{IV.159})$$

which gives

$$\boxed{\log(Y_{1,1}Y_{2,2}) = \log \left(\frac{\mathbb{T}_{\mathbf{0},0}^{1,0}}{\mathbb{T}_{\mathbf{0},0}^-} \right) - \sqrt{4g^2 - u^2} \mathcal{K} * \tilde{\eta}_b} \quad \text{when } \text{Im}(\mathbf{u}) > 0. \quad (\text{IV.160})$$

Remark One can also plug the expression (IV.158) of the density $\tilde{\eta}_b$ into the equation, to write an equivalent form of (IV.160). We wrote this expression (see equation (5.24) in [11GKLV]), which we do not repeat here to keep the simplest possible notations.

Interestingly, the form obtained by this substitution is (after a shift of integration contour, allowed by understanding the structure of the zeroes of the T -functions, written in section IV.4.3.6) directly related to the TBA-equations. It is one of the elements which allows to prove that the TBA-equations are implied by our analyticity conditions and by the resulting FiNLIE.

Equation on the ratio $Y_{1,1}/Y_{2,2}$ The same procedure applies to writing an equation on the ratio $Y_{1,1}/Y_{2,2}$. To this end, we should consider the function \mathbf{C} defined in (IV.161) :

$$\mathbf{C} \equiv \frac{Y_{1,1}}{Y_{2,2}} \frac{\mathbb{T}_{\mathbf{0},0}^-}{\mathbb{T}_{\mathbf{1},0}} \left(\frac{\mathbb{T}_{\mathbf{2},1}}{\mathbb{T}_{\mathbf{1},2}} \frac{\mathbb{T}_{\mathbf{1},1}^-}{\mathbb{T}_{\mathbf{1},1}} \right)^2 \quad (\text{IV.161})$$

This ratio is analytic when $\text{Im}(u) > 0$, and it therefore admits a Cauchy representation as

$$\log \mathbf{C} = \mathcal{K} * \eta_c, \quad \text{when } \text{Im}(u) > 0, \quad (\text{IV.162})$$

$$\text{where } \eta_c \equiv \log \mathbf{C} - \log \bar{\mathbf{C}} = \log \frac{\mathbb{T}_{\mathbf{0},0}^{[-1+0]}}{\mathbb{T}_{\mathbf{0},0}^{[+1-0]}} \left(\frac{\mathbb{T}_{\mathbf{1},1}^{[-1+0]} \mathbb{T}_{\mathbf{1},1}^{[+1-0]}}{\mathbb{T}_{\mathbf{1},1}^{[-1+0]} \mathbb{T}_{\mathbf{1},1}^{[+1-0]}} \right)^2. \quad (\text{IV.163})$$

By inserting the relation (IV.162) into the definition (IV.161) of \mathbf{C} , we can write

$$\boxed{\log \frac{Y_{1,1}}{Y_{2,2}} = \mathcal{K} * \eta_c - \log \left(\frac{\mathbb{T}_{\mathbf{0},0}^-}{\mathbb{T}_{\mathbf{1},0}} \left(\frac{\mathbb{T}_{\mathbf{2},1}}{\mathbb{T}_{\mathbf{1},2}} \frac{\mathbb{T}_{\mathbf{1},1}^-}{\mathbb{T}_{\mathbf{1},1}} \right)^2 \right)} \quad \text{when } \text{Im}(u) \in]0, 1[. \quad (\text{IV.164})$$

Remark Like for the previous expression, it is possible to simplify slightly this expression if we know the structure of the zeroes of the T -functions. Indeed we can plug the expression (IV.163) of η_c into the equation (IV.164). Then, we can redistribute the shifts by moving the integration contours, and this steps requires a precise knowledge of the zeroes of the T -functions (to know what singularities are involved when we move the contours). That gives rise to the expression¹⁷

$$\log \frac{Y_{1,1}}{Y_{2,2}} = \log \frac{\mathbb{T}_{\mathbf{1},0}}{Q^+ Q^-} \left(\frac{\mathbb{T}_{\mathbf{1},2}}{\mathbb{T}_{\mathbf{2},1}} \right)^2 - \mathcal{K}_1 * \log \frac{\mathbb{T}_{\mathbf{0},0}}{Q^2} \left(\frac{\mathbb{T}_{\mathbf{1},1}}{\mathbb{T}_{\mathbf{1},1}} \right)^2, \quad (\text{IV.165})$$

which turns out to be directly related to the TBA-equations.

¹⁷Here Q denotes the polynomial $\prod(u - u^{(j)})$, where the product runs over the Bethe roots $u^{(j)}$. At a finite size $L \neq \infty$, these Bethe roots will be defined in the subsection IV.4.3.6

IV.4.3.2 Equation on \mathcal{F}

The Wronskian gauge condition (III.81), satisfied by the \mathbf{T} -functions, implies that

$$Y_{1,1}Y_{2,2} = \frac{\mathbf{T}_{1,0}\mathbf{T}_{2,3}}{\mathbf{T}_{0,1}\mathbf{T}_{3,2}} = \frac{\mathbf{T}_{1,0}}{(\mathcal{F}^+)^2}. \quad (\text{IV.166})$$

If we note that $\mathbf{T}_{1,0}$ is regular on the real axis, and that $\frac{Y_{1,1}^{[+0]}Y_{2,2}^{[+0]}}{Y_{1,1}^{[-0]}Y_{2,2}^{[-0]}} = \left(Y_{1,1}^{[+0]}Y_{2,2}^{[+0]}\right)^2$ for $\mathbf{u} \in \check{Z}_0$ (see (IV.20)), we can deduce that

$$\forall \mathbf{u} \in \check{Z}_0, \quad \left(Y_{1,1}^{[+0]}Y_{2,2}^{[+0]}\right)^2 = \left(\frac{\mathcal{F}^{[+1-0]}}{\mathcal{F}^{[+1+0]}}\right)^2. \quad (\text{IV.167})$$

As we know, the function $\log \mathcal{F}$ is i -periodic and has cuts on $\bigcup_{n \in \mathbb{Z}} \check{Z}_{2n+1}$. The equation (IV.167) tells us that on each of these cuts, $\log \mathcal{F}$ jumps by the amount

$$\log \mathcal{F}^{[+2n+1+0]} - \log \mathcal{F}^{[+2n+1-0]} = -\log \left(Y_{1,1}^{[+0]}Y_{2,2}^{[+0]}\right) \quad \text{where } \mathbf{u} \in \check{Z}_0. \quad (\text{IV.168})$$

In the right-hand-side, the expression of $Y_{1,1}^{[+0]}Y_{2,2}^{[+0]}$ obtained in (IV.160) can also be plugged into this equation (IV.168).

The above equation (IV.168) can be solved to express \mathcal{F} as a function of $Y_{1,1}^{[+0]}Y_{2,2}^{[+0]}$. To this end we should anticipate on the section IV.4.3.6, where we will show that \mathcal{F} has simple zeroes at the positions $\mathbf{u}^{(j)}$ of the Bethe roots. This allows to fix \mathcal{F} as

$$\mathcal{F}(\mathbf{u}) = \mathcal{F}_0(\mathbf{u})\Lambda_{\mathcal{F}} \prod_{j=1}^M \sinh(\pi(\mathbf{u} - \mathbf{u}^{(j)})), \quad (\text{IV.169})$$

where \mathcal{F}_0 is defined by the integral expression

$$\mathcal{F}_0(\mathbf{u}) = \exp \left[\int_{\mathbf{v} \in \check{Z}_0} \frac{1}{2i} \left(\tanh \pi(\mathbf{u} - \mathbf{v}) + \text{sign}(\mathbf{v}) \right) \log \left(Y_{1,1}(\mathbf{v} + i0)Y_{2,2}(\mathbf{v} + i0) \right) d\mathbf{v} \right], \quad (\text{IV.170})$$

and the constant $\Lambda_{\mathcal{F}}$ is a normalization. This normalization depends on the normalization of the gauge $\mathbf{T}_{a,s}$, which was already fixed by the equation (IV.101). It can be fixed by the constraint

$$\mathcal{F} = f\bar{f}\sqrt{\mathbf{T}_{0,0}}. \quad (\text{IV.171})$$

IV.4.3.3 Equation on h

Let us now obtain the equation on the gauge function h defined in (IV.109). In particular we will show that in the mirror sheet, this function gives rise to a function \hat{h} which has a single, short, Zhukovsky cut on \hat{Z}_0 .

derivation of the equation To obtain this equation we first write the Hirota equation (III.57) for the \mathbb{T} -functions :

$$\mathbb{T}_{2,2}^+ \mathbb{T}_{2,2}^- = \mathbb{T}_{3,2} \mathbb{T}_{1,2} + \mathbb{T}_{2,1} \mathbb{T}_{2,3} , \quad (\text{IV.172})$$

$$\mathbb{T}_{1,1}^+ \mathbb{T}_{1,1}^- = \mathbb{T}_{1,0} \mathbb{T}_{1,2} + \mathbb{T}_{2,1} \mathbb{T}_{0,1} . \quad (\text{IV.173})$$

But we know that $\mathbb{T}_{0,1} = 1$ (see (IV.31)) and that $\hat{\mathbb{T}}_{2,s} = \hat{\mathbb{T}}_{1,1}^{[+s]} \hat{\mathbb{T}}_{1,1}^{[-s]}$ (see (IV.144)). We also have $\mathbb{T}_{3,2} = \mathbb{T}_{3,2} / (h^{[+4]} h^{[+2]} h^{[+0]} \bar{h}^{[-0]} \bar{h}^{[-2]} \bar{h}^{[-4]})$ (see (IV.110)), where $\mathbb{T}_{3,2} = -\mathbf{T}_{3,2} \mathcal{F}^+ = -\mathbf{T}_{2,3} \mathcal{F}^+ = -\mathbf{T}_{2,3} \mathcal{F}^+ = -\mathbb{T}_{2,3} \mathcal{F}^+ h^{[+4]} h^{[+2]} \bar{h}^{[-2]} \bar{h}^{[-4]}$ (see (IV.107)), hence $\mathbb{T}_{3,2} = -\mathbb{T}_{2,3} \mathcal{F}^+ / (h^{[+0]} \bar{h}^{[-0]})$. We also know from the Wronskian gauge condition on the \mathbf{T} -functions that $Y_{1,1} Y_{2,2} = \mathbf{T}_{1,0} / \mathbf{T}_{0,1} = -\mathbf{T}_{1,0} / \mathcal{F}^+ = -h^{[+0]} \bar{h}^{[-0]} \mathbb{T}_{1,0} / \mathcal{F}^+$. Finally, we should note¹⁸ that for $\mathbf{u} \in [-2g, 2g]$, $\mathbb{T}_{1,1}^+ = \mathbb{T}_{1,1}^{[+1-0]} = \hat{\mathbb{T}}_{1,1}^{[+1-0]}$ (because the argument is inside the inside the analyticity strip), and similarly we have $\mathbb{T}_{2,2}^\pm = \hat{\mathbb{T}}_{2,2}^{[\pm 1 \mp 0]}$. With all these substitutions, the Hirota equations (IV.172, IV.173) can be rewritten as

$$\forall \mathbf{u} \in [-2g, 2g], \quad \hat{\mathbb{T}}_{1,1}^{[+1+0]} \hat{\mathbb{T}}_{1,1}^{[-1-0]} = -\mathbb{T}_{1,2} \mathcal{F}^+ / (h^{[+0]} \bar{h}^{[-0]}) + \mathbb{T}_{2,1} , \quad (\text{IV.174})$$

$$\forall \mathbf{u} \in [-2g, 2g], \quad \hat{\mathbb{T}}_{1,1}^{[+1-0]} \hat{\mathbb{T}}_{1,1}^{[-1+0]} = -\mathbb{T}_{1,2} Y_{1,1} Y_{2,2} \mathcal{F}^+ / (h^{[+0]} \bar{h}^{[-0]}) + \mathbb{T}_{2,1} . \quad (\text{IV.175})$$

If we subtract these two equations, then we obtain

$$\forall \mathbf{u} \in [-2g, 2g], \quad \frac{\hat{\mathbb{T}}_{1,1}^{[+1+0]} \hat{\mathbb{T}}_{1,1}^{[-1-0]} - \hat{\mathbb{T}}_{1,1}^{[+1-0]} \hat{\mathbb{T}}_{1,1}^{[-1+0]}}{\mathbb{T}_{1,2}} = - (1 - Y_{1,1} Y_{2,2}) \mathcal{F}^+ / (h^{[+0]} \bar{h}^{[-0]}) . \quad (\text{IV.176})$$

Using the parameterization (IV.56), we also see that

$$\begin{aligned} & \hat{\mathbb{T}}_{1,1}^{[+1+0]} \hat{\mathbb{T}}_{1,1}^{[-1-0]} - \hat{\mathbb{T}}_{1,1}^{[+1-0]} \hat{\mathbb{T}}_{1,1}^{[-1+0]} \\ &= (1 + \mathcal{K}^{[+2]} * \rho - \mathcal{K} * \rho - \rho/2) (1 + \mathcal{K} * \rho - \rho/2 - \mathcal{K}^{[-2]} * \rho) \\ & \quad - (1 + \mathcal{K}^{[+2]} * \rho - \mathcal{K} * \rho + \rho/2) (1 + \mathcal{K} * \rho + \rho/2 - \mathcal{K}^{[-2]} * \rho) \end{aligned} \quad (\text{IV.177})$$

$$= -\rho (2 + \mathcal{K}^{[+2]} * \rho - \mathcal{K}^{[-2]} * \rho) = -\rho \mathbb{T}_{1,2} . \quad (\text{IV.178})$$

Plugging this expression into the left-hand-side of (IV.176), we finally obtain

$$\forall \mathbf{u} \in [-2g, 2g], \quad \boxed{h^{[+0]} \bar{h}^{[-0]} = \frac{(1 - Y_{1,1} Y_{2,2}) \mathcal{F}^+}{\rho}} . \quad (\text{IV.179})$$

¹⁸ In this argument, the condition $\mathbf{u} \in [-2g, 2g]$ is crucial since it allows to write $\mathbb{T}_{1,1}^{[+1+0]} = \mathbb{T}_{1,1}^{[+1-0]} = \mathbb{T}_{1,1}^+$. To write this, we use the fact that $\mathbb{T}_{a,s}$ is defined on the mirror sheet, hence it has cuts only when $|\text{Re}(\mathbf{u})| > 2g$.

In general the left-hand-side of the Hirota equation (IV.173) should be written either as $\mathbb{T}_{1,1}^{[+1+0]} \mathbb{T}_{1,1}^{[+1+0]}$ or as $\mathbb{T}_{1,1}^{[-1+0]} \mathbb{T}_{1,1}^{[-1+0]}$, and there is always one of the two factors which is outside the analyticity strip, giving rise to difficulties if $|\text{Re}(\mathbf{u})| > 2g$.

We see here that it is important to remember that the Hirota equation holds specifically in the mirror sheet.

Analyticity and \mathbb{Z}_4 symmetry In this expression, we will now show that the right-hand-side has no branch point at $\pm 2g$. To this end, we will denote by γ a contour which encircles $2g$ (or $-2g$) but no other singularity, and we will use the notations of section IV.4.2 (i.e. we denote by $F([u]_\gamma)$ the result of the analytic continuation of a function F following the contour γ). If we note that $\rho = \hat{\mathfrak{q}}_{\{2\}}^{[+0]} - \hat{\mathfrak{q}}_{\{2\}}^{[-0]}$, we can write

$$\begin{aligned} \forall \mathbf{u} \in [-2g, 2g], \quad \rho([u]_\gamma) &= \hat{\mathfrak{q}}_{\{2\}} \left([u + i0]_\gamma \right) - \hat{\mathfrak{q}}_{\{2\}} \left([u - i0]_\gamma \right) \\ &= \hat{\mathfrak{q}}_{\{2\}}(\mathbf{u} - i0) - \hat{\mathfrak{q}}_{\{2\}}(\mathbf{u} + i0) = -\rho(\mathbf{u}). \end{aligned} \quad (\text{IV.180})$$

Here we used the fact that, for instance, if γ a clockwise contour around $2g$, then $\hat{\mathfrak{q}}_{\{2\}} \left([u + i0]_\gamma \right) = \hat{\mathfrak{q}}_{\{2\}}(\mathbf{u} - i0)$. We also used the assumption that the cuts are of quadratic type, so that this relation implies $\hat{\mathfrak{q}}_{\{2\}}(\mathbf{u} + i0) = \hat{\mathfrak{q}}_{\{2\}} \left(\left[[u + i0]_\gamma \right]_\gamma \right) = \hat{\mathfrak{q}}_{\{2\}} \left([u - i0]_\gamma \right)$. By analytic continuation from $[-2g, 2g]$, this also implies that $\rho([u]_\gamma) = -\rho(\mathbf{u})$ for arbitrary \mathbf{u} .

The same arguments allow to write

$$(1 - Y_{1,1}Y_{2,2}) \left([u]_\gamma \right) = 1 - \frac{1}{Y_{1,1}(\mathbf{u})Y_{2,2}(\mathbf{u})}, \quad (\text{IV.181})$$

$$\text{and} \quad \mathcal{F} \left([u + i/2]_\gamma \right) = \mathcal{F}(\mathbf{u} + i/2)Y_{1,1}(\mathbf{u})Y_{2,2}(\mathbf{u}). \quad (\text{IV.182})$$

Hence we deduce that the ratio $\frac{(1 - Y_{1,1}Y_{2,2})^{\mathcal{F}^+}}{\rho}$ is regular on the real axis, i.e. that it is invariant under analytic continuation along the path γ .

This regularity exactly allows to deduce that $\hat{\mathbb{T}}_{1,0} = 0$, which means that the \mathbb{Z}_4 symmetry of the $\underline{\mathbb{T}}$ -functions is also satisfied by the \mathbb{T} -functions. This property also allows to deduce that $\hat{h} = \hat{\bar{h}}$, where we define \hat{h} (resp $\hat{\bar{h}}$) as the function which coincides with h (resp \bar{h}) when $\text{Im}(\mathbf{u}) > 0$ (resp $\text{Im}(\mathbf{u}) < 0$) and which only has short Zhukovsky cuts. Then the equation (IV.179) can be written as

$$\forall \mathbf{u} \in [-2g, 2g], \quad \boxed{\hat{h}^{[+0]}\hat{h}^{[-0]} = \frac{(1 - Y_{1,1}Y_{2,2}) \mathcal{F}^+}{\rho}}, \quad (\text{IV.183})$$

where the function \hat{h} is real and is analytic on $\mathbb{C} \setminus \hat{\mathbb{Z}}_0$ (see also the appendix C.3 in [11GKLV]).

Expression of h The solution of the equation (IV.183) which is analytic on $\mathbb{C} \setminus \hat{\mathbb{Z}}_0$ and has the correct behavior at $\mathbf{u} \rightarrow \infty$ (see [11GKLV]) is solved by the following convolution

$$\boxed{\log \hat{h} = -\frac{L+2}{2} \log \hat{x} + \mathcal{Z} \hat{\star} \log \left(\frac{\mathcal{F}^+(1 - Y_{1,1}Y_{2,2})}{\rho} \right)}, \quad (\text{IV.184})$$

where we introduce (for any function F), the convolution $\mathcal{Z} \hat{*} F$ defined by

$$\mathcal{Z} \hat{*} F(\mathbf{u}) = \int_{-2g}^{2g} \frac{-1}{2i\pi} \frac{\sqrt{4g^2 - \mathbf{u}^2}}{\sqrt{4g^2 - \mathbf{v}^2}} \frac{1}{\mathbf{u} - \mathbf{v}} F(\mathbf{v}) d\mathbf{v}. \quad (\text{IV.185})$$

IV.4.3.4 Equation on U

In section IV.4.1, we have already defined a function \mathbf{C} (defined by (IV.108)) which is analytic on the upper half plane. This allows to introduce a Cauchy representation of this function as

$$\log \mathbf{C} = \mathcal{K} * \rho_c, \quad \text{when } \text{Im}(\mathbf{u}) > 0, \quad (\text{IV.186})$$

$$(\text{IV.187})$$

where $\rho_c \equiv \log \mathbf{C} + \log \overline{\mathbf{C}}$. We see that this representation differs slightly from (IV.162), and it is chosen because ρ_c decreases more quickly when $|\mathbf{u}| \rightarrow \infty$ (see [11GKLV]).

As we know that $\mathbf{C} = \left(\frac{U}{U^{[+2]}} \frac{f^+ \hat{h}^{[+2]}}{f^{[+3] \hat{h}}} \right)^2$ (see (IV.113)), this representation allows to write

$$\boxed{\log U = \log \Lambda + \log \frac{\hat{h}}{f^+} + \frac{1}{2} \Psi * \rho_c}, \quad (\text{IV.188})$$

where Ψ denotes the convolution kernel defined by (IV.102). In this equation, Λ denotes a normalization constant which can for instance be fixed [11GKLV] from the relation

$$\sqrt{\mathbf{T}_{0,0}^+ \mathbf{T}_{0,0}^-} = U \bar{U} \mathbf{T}_{0,1} = U \bar{U} \frac{\rho_2}{1 - Y_{1,1} Y_{2,2}}, \quad \text{when } \mathbf{u} \in [-2g, 2g], \quad (\text{IV.189})$$

which is derived by the same arguments as (IV.183).

IV.4.3.5 Equation on the densities ρ and ρ_2

In order to write an iterative algorithm in the same spirit as in chapter III, we should express the densities in terms of which all the Y -, T - and q -functions are parameterized. We already showed how to express the density U in terms of the functions f , h , $Y_{1,1}$, $Y_{2,2}$ and ρ . From the equations of the previous sections, we know how to express all these functions in terms of the three densities ρ , ρ_2 and ρ_v and the polynomial \tilde{Q} , which parameterize all our q -functions. Hence we have already written the closed equation on the function U .

Let us now see how to write equations for the functions ρ and ρ_2 , even though it is less explicit. We have seen in the previous sections how to express to product $Y_{1,1} Y_{2,2}$ and the ratio $\frac{Y_{1,1}}{Y_{2,2}}$. This allows to compute both $Y_{1,1}$ and $Y_{2,2}$, and even the ratio $\mathbf{r} \equiv \frac{1+1/Y_{2,2}}{1+Y_{1,1}}$. But on $[-2g, 2g]$, we know that this ratio should be equal to

$$\mathbf{r} = \frac{(1 + \mathcal{K}_1^+ * \rho - \frac{\rho}{2})(1 + \mathcal{K}_1^- * \rho - \frac{\rho}{2})}{(1 + \mathcal{K}_1^+ * \rho + \frac{\rho}{2})(1 + \mathcal{K}_1^- * \rho + \frac{\rho}{2})} \quad \text{when } \mathbf{u} \in \widehat{Z}_0. \quad (\text{IV.190})$$

Analytically, it is not clear how to invert this equation and write ρ and a function of \mathbf{r} , but numerically it allows to express quite easily ρ as a function of \mathbf{r} . For instance, we can analytically use (IV.190) to express ρ as a function of \mathbf{r} and $\mathcal{K}_1^+ * \rho$. This expression is used to iteratively find ρ as a function of \mathbf{r} (using a fixed-point algorithm).

Although it is numerically slightly more complicated, the same procedure can be used to extract ρ_2 from the ratio $\mathbf{s} \equiv \frac{1+Y_{2,2}}{1+1/Y_{1,1}}$. Due to our parameterization, this ratio takes almost the same form as (IV.190), except that ρ is replaced with ρ_2 , and that several other terms (involving $\mathbf{q}_{\{3\}}$ and $\mathbf{q}_{\{4\}}$) appear. Numerically¹⁹ this equation allows to write ρ_2 as a function of \mathbf{s} and $\mathbf{q}_{\{3\}}$ and $\mathbf{q}_{\{4\}}$.

IV.4.3.6 Bethe equation

As in chapter III, we would now like to fix the coefficients of the polynomial \tilde{Q} contained in our parameterization. We expect that an analyticity condition like the absence of poles of the T -functions could impose a Bethe equation on these coefficients, as it was the case in section III.3.4.2 for the principal chiral model.

In order to find equations on these polynomials, we should first investigate the properties of the zeroes and poles of the \mathbf{T} -functions. As explained in section IV.3.1.2, the T -functions have no pole inside their analyticity strip, but they can have zeroes which give rise to poles of the Y -functions. We will analyze these zeroes assuming that the gauges \mathbf{T} and \mathbb{T} do not have poles inside their analyticity strip.

Let us suppose that $\mathbf{T}_{0,0}$ has some zeroes in its analyticity strip A_1 . Since $\mathcal{F} = \sqrt{\mathbf{T}_{0,0}}$ defines the gauge transformation between the gauges \mathbf{T} and \mathbb{T} (see (IV.107)), $\mathbf{T}_{0,0}$ should not have zeroes with an odd multiplicity, since it would give rise to branch points in $\mathcal{F} = \sqrt{\mathbf{T}_{0,0}}$, which would spoil the analyticity of the \mathbf{T} - or \mathbb{T} -functions. Hence we obtain that $\mathbf{T}_{0,0}$ only has double²⁰ zeroes so that \mathcal{F} has only simple zeroes. We will denote these zeros as $u^{(j)}$ and assume that there are M such zeroes.

If we compare with the Bethe roots of the TBA-equations, we can see that these zeroes $u^{(j)}$ are exactly the Bethe roots, and they should satisfy

$$Y_{1,0} \left([u^{(j)}]_{\gamma} \right) = -1, \quad (\text{IV.191})$$

where $Y_{1,0} \left([u]_{\gamma} \right)$ denotes the analytic continuation of the function $Y_{1,0}$ following the contour γ defined on figure IV.5. This contour encircles one single branch point of the function $Y_{1,0}$ (at position $2g + \frac{i}{2}$), and then comes back to the point $u^{(j)}$.

This condition can actually be rewritten as a regularity condition on the T -functions, as we will now see. Since $\mathbb{T}_{1,2} = \mathbf{T}_{1,2}/\mathcal{F}^+$, the absence of poles in $\mathbb{T}_{1,2}$ is only possible

¹⁹Quite interestingly, it is numerically much easier to invert the relation (IV.190) and find ρ as a function of \mathbf{r} than to invert the analogous expression for \mathbf{s} and express ρ_2 as a function of \mathbf{s} and $\mathbf{q}_{\{3\}}$ and $\mathbf{q}_{\{4\}}$. What we numerically found is that we can invert the equation and find ρ_2 efficiently if we impose the condition that $\mathbb{T}_{1,2}(u^{(j)} \pm i/2) = 0$ for all the Bethe roots $u^{(j)}$. We will derive this condition in section IV.4.3.6.

²⁰The function $\mathbf{T}_{0,0}$ may also have zeroes with even multiplicity $2n > 2$. If this case arise, we say that it has n double zeroes which coincide.

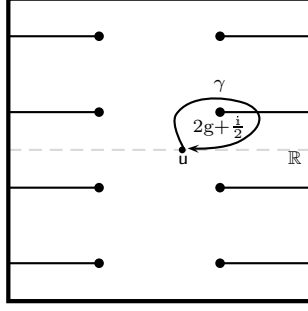

Figure IV.5: Paths used for analytical continuation in the Bethe equation (IV.191).

if $\mathbf{T}_{1,2}$ has zeroes at positions $\mathbf{u}^{(j)} \pm \mathbf{i}/2$. Assuming that $\mathbf{T}_{2,1}$ does not have zeroes at $\mathbf{u}^{(j)} \pm \mathbf{i}/2$, $Y_{2,2} = \mathbf{T}_{2,1}/\mathbf{T}_{1,2}$ should have poles at $\mathbf{u}^{(j)} \pm \mathbf{i}/2$. On the other hand, we can write the Y-system equation at $a = 1, s = 1$, and continue it along the contour γ . Using (IV.20), we get

$$\left(1 + Y_{1,0}([\mathbf{u}]_\gamma)\right) Y_{2,2}^-(\mathbf{u}) = \left(\frac{Y_{1,1}^+(1 + 1/Y_{2,1})}{(1 + Y_{1,2})}\right) ([\mathbf{u}]_\gamma) \quad (\text{IV.192})$$

The equation (IV.191) is then the condition that, in the left-hand-side, the poles of $Y_{2,2}^-$ at the Bethe roots are canceled with the zeroes of $\left(1 + Y_{1,0}([\mathbf{u}]_\gamma)\right)$. Therefore we see that the condition (IV.191), which fixes the position of the Bethe roots from the TBA-equations, can as well be viewed as the condition that the right-hand-side is regular at $\mathbf{u} = \mathbf{u}^{(j)}$.

More details about this Bethe equations can be found in [11GKLV]. In particular it is shown in appendix E.2 that the condition (IV.191) can be rewritten as

$$\left(\frac{\hat{h}^+}{\hat{h}^-}\right)^2 + \frac{Y_{2,2}^+ \mathbb{T}_{1,2}^+ \hat{\mathbb{T}}_{1,1}^{[-2]}}{Y_{2,2}^- \mathbb{T}_{1,2}^- \hat{\mathbb{T}}_{1,1}^{[+2]}} \Bigg|_{\mathbf{u}=\mathbf{u}^{(j)}} = 0 \quad (\text{IV.193})$$

This expression is numerically more convenient than the expression (IV.191), because it only involves functions with argument inside the analyticity strip (where we do not have to do any analytic continuation around a branch point). It means that this equation allows to update the position $\mathbf{u}^{(j)}$ of the Bethe roots, provided we know the densities ρ, ρ_2 and ρ_U (and the polynomial \tilde{Q}), which parameterize the q -functions as defined in section IV.3.2.

Expression of \tilde{Q} The above discussion only fixes the position of the Bethe roots, which are the zeroes of (for instance) $\mathbf{T}_{0,0}$. The position of these Bethe roots is important because it enters several equations (see for instance (IV.169) and (IV.165)), but it can also be used to write a constraint on the polynomial \tilde{Q} . Indeed if we find the Bethe roots from the equation (IV.193), then we can write the constraint $\mathbf{T}_{0,0}(\mathbf{u}^{(j)}) = \mathbf{T}_{1,0}(\mathbf{u}^{(j)} \pm \mathbf{i}/2) = 0$ to fix the coefficients of the polynomial \tilde{Q} .

IV.4.3.7 Expression of the energy

The expression of the energy (or the anomalous dimension γ of operators), is given by (IV.7) in terms of the Y-functions. Once we know the pole structure of the Y-functions, as identified in the previous subsection, it is possible to show that E is exactly given by the large u behavior of the product $Y_{1,1}Y_{2,2}$. More precisely we have

$$\boxed{\log \left(Y_{1,1}^{[+0]} Y_{2,2}^{[+0]} \right) \sim iE/u}, \quad \text{when } u \rightarrow \pm\infty, \quad u \in \mathbb{R}. \quad (\text{IV.194})$$

This is proven in [11GKLV] using the TBA-equations, but interestingly enough, it can be rewritten (using (IV.167)) as

$$E = \frac{1}{2} \lim_{u \rightarrow \infty} u \partial_u \log \mathbf{T}_{0,0} \quad u \in \mathbb{R}. \quad (\text{IV.195})$$

One can expect that if a physical construction of the T-operators for AdS/CFT can be found, for instance from a lattice regularization, or from string theory, then this expression will come naturally because the \mathbf{T} -functions define a gauge which is expected to have a physical origin. This expression is quite similar to the expression of the energy in chapter II, which involves the derivative of the logarithm of a T-operator.

Remark and large u behavior In the definition of the parameterization of the q -functions it was used that the behavior of the q -functions when $u \rightarrow \infty$ can be extracted from the asymptotic limit ($L \rightarrow \infty$). This assumption allowed for instance to fix the degree of the polynomial in the definition of W (see (IV.153)) and of $\underline{q}_{\{2\}}$ (see (IV.51)). These polynomial asymptotic were in direct relation to the limit of $Y_{a,1}$ (resp $Y_{1,s}$) when $|u| \rightarrow \infty$ and $|\text{Im}(u)| < \frac{a-1}{2}$, (resp $|\text{Im}(u)| < \frac{s-1}{2}$), which can be extracted from the $L \rightarrow \infty$ limit, as one can check from the TBA-equations. Roughly speaking, this was motivated by equation (IV.50), which shows that inside the analyticity strip, $\left(\frac{x^{[-a]}}{x^{[+a]}} \right)^L$ is small both in the $L \rightarrow \infty$ limit and in the $u \rightarrow \infty$ limit.

The same argument cannot easily be used for the functions $Y_{1,1}$ and $Y_{2,2}$, because their analyticity strip has size zero. Therefore the asymptotic behavior of these Y-functions is not exactly the same as in the $L \rightarrow \infty$ limit. One can actually show (see the end of appendix B in [11GKLV]) that several functions behave at $u \rightarrow \infty$ as a power of u , where the exact power does not coincide with the $L \rightarrow \infty$ limit.

For instance we obtain $f \sim u^{\gamma/2}$, $U \sim u^{-(L+\gamma)/2}$, etc.

IV.4.3.8 Iterative algorithm

From all these equation, one can write an iterative algorithm, exactly like in section III.3 for the principal chiral model. In this algorithm, we can start from the asymptotic limit ($L \rightarrow \infty$) of the densities ρ and ρ_2 , of the Bethe roots and of the polynomial \tilde{Q} . We can also start from $U = 0$, because U is exponentially small when $L \rightarrow \infty$. Then for each iteration, we should use these densities to compute the q -functions and the functions $\underline{\mathbf{T}}_{a,s}$ (when $a \geq |s|$) and $\overline{\mathbf{T}}_{a,s}$ (when $s \geq a$) inside their analyticity strips (see section

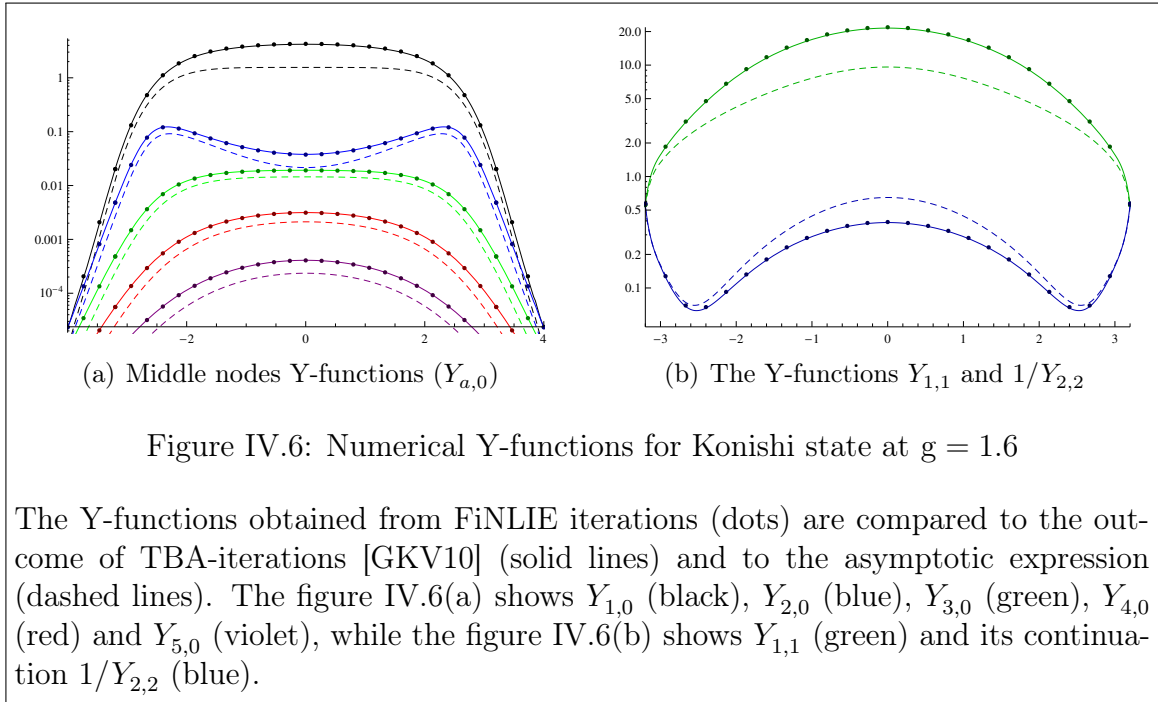

IV.3.2). Hence, we can compute the functions $Y_{1,1}$ and $Y_{2,2}$ (see (IV.160) and (IV.165)), as well as the functions f (see (IV.101)) and h (see (IV.184)). The expressions of $Y_{1,1}$ and $Y_{2,2}$ can then be used to find a new expression of the densities ρ and ρ_2 , whereas the expression of h and f can be plugged into the equation (IV.188) for U . Finally, we should update the value of the Bethe roots (to use a more accurate position of these roots in the next iteration), and the polynomial \tilde{Q} (see section IV.4.3.6).

And the end of an iteration, we get new expressions for the densities, the positions of the Bethe roots, and the polynomial \tilde{Q} . These expressions can be used as starting point of a next iteration. If the algorithm converges, then it provides a solution to the equations written above.

IV.5 Numerical results

We iterated this algorithm in the case of the operator called Konishi operator, which has two symmetric Bethe roots (i.e. $M = 2$ and $u^{(1)} = -u^{(2)}$) and has length $L = 2$. Our numerical results, obtained for a coupling g of order 1 (or smaller), confirmed that our FiNLIE reproduces exactly the solution of the TBA-equations, with the main difference that the number of functions (and of equations) is finite. Our numerical results, shown on figure IV.6 show a very good agreement with previous results obtained from the TBA-equations, and confirms the equivalence of our equations with the TBA-equations.

This equivalence is also proven analytically in the appendices of [11GKL].

IV.6 Conclusion

We have shown in this chapter that for the Y-system of AdS/CFT, a finite set of nonlinear integral equation allows to express the exact anomalous dimension of a few simple operators of the super Yang-Mills conformal field theory. As we saw, this result was obtained by first solving the Y-system equation in terms of a finite number of q -functions, and then by imposing some analyticity properties which completely fix these q -functions. We argued that these analyticity conditions look very physical, and are certainly the hints that a physical construction of the T -functions is possible, and obeys natural regularity conditions. In particular, we identified a quantum \mathbb{Z}_4 symmetry which generalizes the \mathbb{Z}_4 symmetry of the classical string theory to the quantum level.

At the moment we cannot derive these analyticity conditions from an explicit, physical construction of the T -functions (or of the T-operators) corresponding to this Y-system from a lattice regularization or directly from string theory, and we can simply prove that these conditions are equivalent to the known TBA-equations. But it will be very interesting to see if such a construction can be obtain. In particular that would allow to derive more rigorously that the energy spectrum of the AdS/CFT duality is expressed from the Y-functions of the Y-system. This would be particularly interesting since the known derivations of these equations are still not completely well controlled (for instance regarding the analytic continuation from the vacuum to the excited states).

In this work, we restricted for simplicity to excited states which belong to the $SL(2)$ sector and have a symmetric configuration of two Bethe roots (i.e. $M = 2$ and $u^{(1)} = -u^{(2)}$). The condition that there are only two symmetric Bethe roots was only used to drop a few coefficients in the polynomial behavior of the q -functions in the limit $u \rightarrow \infty$, and it would probably not be very difficult to relax this condition. For states outside the $SL(2)$ sector, by contrast, more work would certainly be needed. We already know the expression of the Q -functions in the asymptotic limit [11GKLT] for these states, but in order to write a FiNLIE for these states, it will be necessary to know very well the position of poles and zeroes of the Y- T - and q -functions, and to see whether they affect the equations we have written. In principle the asymptotic limit should already contain important informations about these poles, so that it is certainly feasible to generalize our equations. We expect that if we perform this generalization, then we will have equations on five densities instead of three, because in general $Y_{a,-s}$ will not be equal to $Y_{a,s}$.

The efficiency of this finite system of equations, both analytically and numerically, remains to be studied. The numerical interest in computing energies from the Y-system has already led to several important results, and it will be interesting to see whether our FiNLIE allows a better accuracy or a generalization to more excited states. At the analytic level, it may be better suited than the usual Y-system to derive analytic expansions in the limit $g \rightarrow \infty$ or $g \rightarrow 0$. In the strong coupling limit, in particular, our formula looks more directly related to the symmetries of the classical string theory, and we can have reasonable hope that it will allow to perform an analytic expansion of energy.

Conclusion and outlook

This manuscript presented the research performed during this PhD, which was devoted to the study of several integrable models. We saw that various models, which are qualitatively very different from each other, involve the same equation (the Hirota equation), related to the existence of Q -functions.

We clarified the existence of these Q -functions, by constructing them explicitly for spin chains (where they are the eigenvalues of the Q -operators), and by proving their existence under a typicality condition in the case of integrable quantum field theories. In both of these cases, we showed that they are the building blocks of the T -functions (in the sense that the T -functions are written as a Wronskian determinant of these Q -functions). Interestingly enough, we also showed (in the case of spin chains) the relation between this construction and the general polynomial solution of the MKP hierarchy.

It would be very interesting to deeper understand the relation between these objects. In particular, we may wonder whether explicit expressions like the ones we wrote in chapter II for polynomial spin chains can be written for more complicated models such as non-polynomial spins chains or field theory. In chapter II, our construction is written by means of an ad-hoc operator \hat{D} , specifically designed to give rise to polynomial spin chains, but we saw in section II.4 that the construction which we obtained can as well be written in terms of τ -functions, making the origin of our construction clearer. This remark will certainly be very inspiring in order to generalize our construction to other integrable models.

We also saw that even without understanding explicitly their construction for integrable field theory, the existence of these Q -functions allowed to simplify noticeably the study of the finite size corrections. In particular, the usual formulation of the Y -system can be replaced by a few analyticity conditions on these Q -functions. These requirements can also be written as a finite set of nonlinear integral equations (FiNLIE) which is expected to be more efficient, both for its numerical resolution and for analytical expansions.

Interestingly, it was proven [Cae10] in the case of the $SU(2) \times SU(2)$ principal chiral model that the equation obtained by this method in [GKV09b] is equivalent to the “DdV” equations obtained from a lattice regularization. As opposed to a lattice regularization (which is not always known to exist) our method seems to be quite generally applicable to numerous models (since we know how to express the solution of the Hirota equation in terms of a finite number of functions). However, we saw that an important part of the analysis (namely the study of the analytical properties) had to be performed on a case-by-case basis, even though some common features emerge (such as the fact that the

q -functions are analytic on half-planes). In the cases where DdV equations are known, it would be very interesting to clarify the relation between this DdV equation and this study of the analyticity properties. In particular this may lead to a better understanding of the existence of the Y -system.

Appendix A

Introduction to representations of matrix groups

The first section A.1 of this annex consists of a few definitions, mainly introducing the tensor product. It is not necessary to linearly read this subsection, and the reader can definitely postpone reading these definitions until they are referred to at some point.

The next sections A.2, A.3.1 and A.4, will introduce some representations of the matrix groups such as $GL(K)$, $SU(K)$ and $GL(K|M)$. These representations will be labeled by so-called “Young diagrams”.

To start with, let us recall that a representation of a group G is defined by a vector space V and a morphism $\pi : G \rightarrow GL(V)$, i.e. a map from G to $GL(V)$ such that

$$\forall g, g' \in G, \pi(g \cdot g') = \pi(g) \cdot \pi(g'). \quad (\text{A.1})$$

We will sometimes identify a representation (V, π) to the space V alone, if the morphism π is unambiguously defined by the context.

The character of a representation (V, π) is the map

$$\chi : \begin{cases} G & \rightarrow \mathbb{C} \\ g & \mapsto \text{tr}(\pi(g)) \end{cases} . \quad (\text{A.2})$$

A.1 Notations and tensor product

Let us first briefly remind what is meant by a tensor product of Hilbert spaces, and introduce the corresponding notations.

We will consider a set of Hilbert spaces $\mathcal{H}_1, \mathcal{H}_2, \dots, \mathcal{H}_L$, where each \mathcal{H}_i has (finite) dimension d_i and is defined through an orthonormal basis denoted as $| (1) \rangle_i, | (2) \rangle_i, \dots, | (d_i) \rangle_i$.

Then one can construct a bigger Hilbert space $\mathcal{H} \equiv \bigotimes_{i=1}^L \mathcal{H}_i$ (denoted by a bigger \mathcal{H} letter), defined through an orthonormal basis which is the set of the vectors

$$| (n_1, n_2, \dots, n_L) \rangle \equiv | (n_1) \rangle_1 \otimes | (n_2) \rangle_2 \otimes \dots \otimes | (n_L) \rangle_L , \quad (\text{A.3})$$

where each n_i belongs to $\llbracket 1, d_i \rrbracket$.

For an arbitrary linear operator \mathcal{O} on this space, it is convenient to introduce the coordinates

$$\mathcal{O}_{j_1, j_2, \dots, j_L}^{i_1, i_2, \dots, i_L} = \langle (i_1, i_2, \dots, i_L) | \mathcal{O} | (j_1, j_2, \dots, j_L) \rangle . \quad (\text{A.4})$$

For instance, if A and B are operators on \mathcal{H} and \mathcal{H}' , their tensor product is an operator on $\mathcal{H} \otimes \mathcal{H}'$ with coordinates

$$(A \otimes B)_{j_1, j_2}^{i_1, i_2} = A_{j_1}^{i_1} B_{j_2}^{i_2} . \quad (\text{A.5})$$

There is a specific set of operators which will be of crucial importance in what follows, and which exists if all the “local” spaces \mathcal{H}_i are isomorphic: the permutation operators defined by

$$\mathcal{P}_{(\sigma)} : | (n_1, n_2, \dots, n_L) \rangle \mapsto | (n_{\sigma(1)}, \dots, n_{\sigma(L)}) \rangle \quad (\text{A.6})$$

$$\text{i.e.} \quad (\mathcal{P}_{\sigma})_{j_1, j_2, \dots, j_L}^{i_1, i_2, \dots, i_L} = \prod_{k=1}^L \delta_{\sigma(j_k)}^{i_k} \quad (\text{A.7})$$

for any permutation $\sigma \in \mathcal{S}^L$ (where \mathcal{S}^L denotes the set of all permutations of $\llbracket 1, L \rrbracket$). In the particular case when σ is the identity permutation, one gets the identity operator \mathbb{I} . On the other hand, if $\sigma = \tau_{[k,l]}$ is the transposition $k \leftrightarrow l$ defined in (I.3), then one gets the permutation operator $\mathcal{P}_{k,l}$ such that

$$(\mathcal{P}_{k,l})_{j_1, j_2, \dots, j_L}^{i_1, i_2, \dots, i_L} = \delta_{j_k}^{i_l} \delta_{j_l}^{i_k} \prod_{n \in \llbracket 1, L \rrbracket \setminus \{k, l\}} \delta_{j_n}^{i_n}. \quad (\text{A.8})$$

This operator satisfies for instance (for $L = 2$)

$$\mathcal{P}_{1,2}(A \otimes B) = (B \otimes A) \mathcal{P}_{1,2}, \quad (\text{A.9})$$

and it will turn out to have a crucial role in what follows.

To finish this section, let \mathcal{O} be an operator on $\bigotimes_{i=1}^L \mathcal{H}_i$. One can define its partial trace $\text{tr}_L \mathcal{O}$ with respect to \mathcal{H}_L (for instance): it is an operator on $\bigotimes_{i=1}^{L-1} \mathcal{H}_i$ defined by

$$(\text{tr}_L \mathcal{O})_{j_1, j_2, \dots, j_{L-1}}^{i_1, i_2, \dots, i_{L-1}} = \sum_{k=1}^{d_L} \mathcal{O}_{j_1, j_2, \dots, j_{L-1}, k}^{i_1, i_2, \dots, i_{L-1}, k}. \quad (\text{A.10})$$

In particular it satisfies $\text{tr}_2(A \otimes B) = A \text{tr}(B)$.

A.2 Representations of SU(2)

The representations of SU(2) are the simplest example of representations, and are very frequently encountered in quantum mechanics, where they describe the spin of different objects.

The three following 2×2 matrices

$$J^{(l)} = \frac{\sigma^{(l)}}{2} \quad l = 1, 2, 3, \quad (\text{A.11})$$

(where $\sigma^{(l)}$ denote the Pauli matrices defined by (II.3)) form a linear basis of the space of all traceless, hermitian matrices. This allows us to write¹

$$\text{SU}(2) = \{U \mid \exists (\phi_1, \phi_2, \phi_3) \in \mathbb{R}^3 : U = e^{i \sum_{l=1}^3 \phi_l J^{(l)}}\}. \quad (\text{A.12})$$

Therefore, we say that $J^{(l)}$ are the “generators” of SU(2).

The irreducible representations² of SU(2) are labeled by a number $j \in \mathbb{N}/2$, and j is usually called the spin of the representations. The representation with spin j is given by the vector space V_j and the morphism π_j defined by

$$V_j = \text{Vect} \{ |j, j\rangle, |j, j-1\rangle, |j, j-2\rangle, \dots, |j, -j\rangle \} \quad (\text{A.13})$$

$$\pi_j : e^{i \sum_{l=1}^3 \phi_l J^{(l)}} \mapsto e^{i \sum_{l=1}^3 \phi_l J_j^{(l)}} \quad (\text{A.14})$$

$$\text{where } J_j^{(3)} |j, m\rangle = m |j, m\rangle \quad (\text{A.15})$$

$$\left(J_j^{(1)} \pm i J_j^{(2)} \right) |j, m\rangle = \sqrt{(j \mp m)(j \pm m + 1)} |j, m \pm 1\rangle, \quad (\text{A.16})$$

¹One can note that for $U \in \text{SU}(2)$, there are in general several different vectors $(\phi_1, \phi_2, \phi_3) \in \mathbb{R}^3$ such that $U = e^{i \sum_{l=1}^3 \phi_l J^{(l)}}$. For instance, we have $\mathbb{I} = e^{4\pi J^{(1)}} = e^{4\pi J^{(2)}} = e^{4\pi J^{(3)}}$.

² The definition of an irreducible representation will be given in the section A.3.

where $|j, m\rangle$ denotes an orthonormal basis of a $2j + 1$ -dimensional Hilbert space. In (A.16), we use the convention $|j, j + 1\rangle = 0 = |j, -j - 1\rangle$.

Proof that (A.13- A.16) is a morphism . First, one can check that the equation (A.14) does indeed define a function π_j . What has to be checked is that if $e^{i\sum_{l=1}^3 \phi_l J^{(l)}} = e^{i\sum_{l=1}^3 \psi_l J^{(l)}}$, then $e^{i\sum_{l=1}^3 \phi_l J_j^{(l)}} = e^{i\sum_{l=1}^3 \psi_l J_j^{(l)}}$. One way to check it is by noticing³ that the coefficients of the matrix $e^{i\sum_{l=1}^3 \phi_l J_j^{(l)}}$ are a polynomial function of the coefficients of the matrix $e^{i\sum_{l=1}^3 \phi_l J^{(l)}}$.

Next, one should check that the relation (A.1) holds. To do this, one can notice that $J_j^{(l)}$ obeys the same commutation relation⁴ $[J_j^{(l)}, J_j^{(m)}] = i \epsilon^{l,m,n} J_j^{(n)}$ as the operators $J^{(l)}$ defined in (A.11). From this we can prove that π_j is a morphism, i.e. that

$$\text{if } e^{i\sum_{l=1}^3 \phi_l J^{(l)}} \cdot e^{i\sum_{l=1}^3 \phi'_l J^{(l)}} = e^{i\sum_{l=1}^3 \psi_l J^{(l)}}, \quad (\text{A.17})$$

$$\text{then } e^{i\sum_{l=1}^3 \phi_l J_j^{(l)}} \cdot e^{i\sum_{l=1}^3 \phi'_l J_j^{(l)}} = e^{i\sum_{l=1}^3 \psi_l J_j^{(l)}}. \quad (\text{A.18})$$

This result is obtained by the Baker-Campbell-Hausdorff formula, which allows to express ψ as a function of ϕ and ϕ' . This Baker-Campbell-Hausdorff formula reads

$$e^X e^Y = \exp \left(X + Y + \frac{1}{2}[X, Y] + \frac{1}{12}[X - Y, [X, Y]] + \dots \right), \quad (\text{A.19})$$

and it only involves the commutation relations between the $J^{(l)}$. This Baker-Campbell-Hausdorff formula provides the explicit expression of a $\psi \in \mathbb{R}^3$ such that (A.17) holds. But since the $J_j^{(l)}$ obey the same commutation relation as $J^{(l)}$, we immediately see that the same expression ψ obeys (A.18) as well. \square

Among these representations, the $j = 0$ case corresponds to $V_0 = \mathbb{C}$ and $\forall g, \pi_0(g) = \mathbb{I}$. This representation is usually called the trivial representation.

By contrast, the representation with spin $j = 1/2$ corresponds to $V_{1/2} = \mathbb{C}^2$ and $\forall g, \pi_{1/2}(g) = g$. It will be called the fundamental representation of $SU(2)$.

For the unity of notations, let us also introduce the following notation:

$$\boldsymbol{\pi}_j(J^{(l)}) \equiv J_j^{(l)}, \quad (\text{A.20})$$

where the bold letter $\boldsymbol{\pi}$ denotes the transformation of the generators, whereas the letter π denotes the transformation of a group element.

³The matrix coefficients of $e^{i\sum_{l=1}^3 \phi_l J_j^{(l)}}$ are not a very simple function of (ϕ_1, ϕ_2, ϕ_3) , and it is not very easy to notice that they are a polynomial function of the matrix coefficients of $e^{i\sum_{l=1}^3 \phi_l J^{(l)}}$.

We will actually see in the next section that there exists another construction of the function π_j , making it easy to write the explicit (polynomial) expression of the coefficients of the matrix $e^{i\sum_{l=1}^3 \phi_l J_j^{(l)}}$ as a function of the coefficients of the matrix $e^{i\sum_{l=1}^3 \phi_l J^{(l)}}$.

⁴Here, the symbol $\epsilon^{l,m,n}$ denotes the antisymmetric function of l, m and n such that $\epsilon^{1,2,3} = 1$.

A.3 Young diagrams and representations of $GL(K)$

We will now see that the representations defined above can be generalized not only to $SU(K)$, but even⁵ to $GL(K)$.

In this section, we will define some representations of $GL(K)$, which are indexed by Young diagrams. Their restriction to unitary matrices will give the irreducible representations of $SU(K)$. In this manuscript, the construction will be introduced with less details than (for instance) in [FH91], but it will be generalized to super-groups, following for instance [BBB81].

A.3.1 Young diagrams

The Young diagrams are diagrams which can be identified to non-increasing sequences $\lambda_i \geq 0$ of integers where there is an n such that $\lambda_i = 0$ for all $i \geq n$. The identification between diagrams (made out of ‘‘boxes’’) and these sequences goes as follows:

$$\boxed{(5, 3, 2, 2, 0, 0, 0, \dots) \leftrightarrow \begin{array}{|c|c|c|c|c|} \hline \square & \square & \square & \square & \square \\ \hline \square & \square & \square & \square & \square \\ \hline \square & \square & \square & \square & \square \\ \hline \square & \square & \square & \square & \square \\ \hline \end{array}}. \quad (\text{A.21})$$

We see that λ_i becomes the number of boxes in the i^{th} row (counted from below) of the diagram.

A Young tableau will denote a Young diagram where positive integers are written inside each box. We will see that each Young diagram labels a representation of $GL(K)$, and that if we write integers in each box of the diagram (following a given rule⁶), then we obtain Young tableaux which label a basis of this representation.

A.3.2 Decomposition of the tensor representation of $GL(K)$

A very natural representation of $GL(K)$ is given by the space $V_N = (\mathbb{C}^K)^{\otimes N}$ and the morphism $\pi_N : M \mapsto M^{\otimes N}$. Then $\pi_N(M)$ acts on the basis (A.3) as follows

$$\pi_N(M) |(n_1, n_2, \dots, n_N)\rangle = \sum_{n'_1, n'_2, \dots, n'_N \in \llbracket 1, K \rrbracket^N} \prod_{i=1}^N M_{n'_i}^{n_i} |(n'_1, n'_2, \dots, n'_N)\rangle. \quad (\text{A.22})$$

If $N = 1$, this defines the ‘‘fundamental’’ representation of $GL(K)$, i.e. the representation such that $\pi(M) = M$. This representation will be denoted by the Young diagram \square . Then the tensor representation (A.22) will be denoted by $\underbrace{\square \otimes \square \otimes \dots \otimes \square}_N$.

⁵ In general it is obvious that every representation of $GL(K)$ gives rise to a representation of the subgroup $SU(K) \subset GL(K)$. But it is a priori not trivial that these representations of $SU(K)$ also define representations of $GL(K)$.

⁶This rule will be that the integers are increasing in each column and non-decreasing in each row.

Reducibility of the tensor representation If $N \geq 2$, this representation is reducible. This means that there exists at least one sub-space of V_N which is stable under $\pi_N(M)$, for every $M \in \text{GL}(\mathbb{K})$. For instance we will see that the set of all symmetric tensors is stable under all $\pi_N(M)$. This set will be denoted by $V_{\underbrace{\square \square \dots \square}_N}$, which is labeled by the Young tableau $(N, 0, 0, \dots) = \underbrace{\square \square \dots \square}_N$ (see (A.21)). It can be defined using

the projector $P_{\underbrace{\square \square \dots \square}_N}$:

$$V_{\underbrace{\square \square \dots \square}_N} \equiv \text{Im}(P_{\underbrace{\square \square \dots \square}_N}) \quad (\text{A.23})$$

$$\text{where } P_{\underbrace{\square \square \dots \square}_N} |(n_1, n_2, n_3, \dots, n_N)\rangle = \frac{1}{N!} \left(\sum_{\sigma \in \mathcal{S}^N} |(n_{\sigma(1)}, n_{\sigma(2)}, \dots, n_{\sigma(N)})\rangle \right),$$

$$\text{i.e. } P_{\underbrace{\square \square \dots \square}_N} = \frac{1}{N!} \sum_{\sigma \in \mathcal{S}^N} \mathcal{P}_\sigma, \quad (\text{A.24})$$

where the permutation operator \mathcal{P}_σ is defined by (A.6).

An orthonormal basis of $V_{\underbrace{\square \square \dots \square}_N}$ can be written as

$$\mathcal{B}_{\underbrace{\square \square \dots \square}_N} \equiv \left\{ \begin{array}{c} \boxed{n_1} \boxed{n_2} \boxed{n_3} \dots \boxed{n_N} \\ \left| \right. \\ 1 \leq n_1 \leq n_2 \leq \dots \leq n_N \leq \mathbb{K} \end{array} \right\} \quad (\text{A.25})$$

$$\text{where } \boxed{n_1} \boxed{n_2} \boxed{n_3} \dots \boxed{n_N} \equiv \mathcal{N} \left(P_{\underbrace{\square \square \dots \square}_N} |(n_1, n_2, n_3, \dots, n_N)\rangle \right) \quad (\text{A.26})$$

$$\text{where } \mathcal{N}(|\psi\rangle) \equiv \frac{|\psi\rangle}{\sqrt{\langle \psi | \psi \rangle}}. \quad (\text{A.27})$$

We see that the elements of this basis are Young tableaux obtained by filling the corresponding Young diagram with ordered numbers belonging to $\llbracket 1, \mathbb{K} \rrbracket$.

The very definition of the operators \mathcal{P}_σ implies that

$$(\mathcal{O}_1 \otimes \mathcal{O}_2 \otimes \dots \otimes \mathcal{O}_N) \cdot \mathcal{P}_\sigma = \mathcal{P}_\sigma \cdot (\mathcal{O}_{\sigma(1)} \otimes \mathcal{O}_{\sigma(2)} \otimes \dots \otimes \mathcal{O}_{\sigma(N)}) , \quad (\text{A.28})$$

for any set of operators $(\mathcal{O}_1, \mathcal{O}_2, \dots, \mathcal{O}_N)$ on \mathcal{H}_1 (resp \mathcal{H}_2 resp \dots). In particular we see that $M^{\otimes N}$ commutes with any \mathcal{P}_σ , hence it also commutes with $P_{\underbrace{\square \square \dots \square}_N}$. As a consequence, $V_{\underbrace{\square \square \dots \square}_N} = \text{Im}(P_{\underbrace{\square \square \dots \square}_N})$ is stable under all $\pi_N(M)$, for all $M \in \text{GL}(\mathbb{K})$.

This allows to introduce a representation of $\text{GL}(\mathbb{K})$, labeled by the Young diagram $(N, 0, 0, \dots) = \underbrace{\square \square \dots \square}_N$, defined by the space $V_{\underbrace{\square \square \dots \square}_N}$ and the morphism π_N below:

$$\pi_{\underbrace{\square \square \dots \square}_N}(M) : \left\{ \begin{array}{ll} V_{\underbrace{\square \square \dots \square}_N} & \rightarrow V_{\underbrace{\square \square \dots \square}_N} \\ |\Psi\rangle & \mapsto M^{\otimes N} |\Psi\rangle \end{array} \right. . \quad (\text{A.29})$$

Hence we have shown that when $N \geq 2$, the representation $\square \otimes \square \otimes \dots \otimes \square$ is reducible, which means that it contains at least one stable subspace. This stable subspace also defines another representation of $\text{GL}(\mathbb{K})$, which has a smaller dimension.

Decomposability of the tensor representation In addition to being reducible, the representation V_N is actually decomposable, which means that it can be written as a direct sum of representations corresponding to stable subspaces. For instance, when $N = 2$, we will show that one can write

$$\square \otimes \square = \square\square \oplus \begin{array}{|c|} \hline \square \\ \hline \end{array}, \quad (\text{A.30})$$

where the representation $\begin{array}{|c|} \hline \square \\ \hline \end{array}$ is defined from the space of antisymmetric tensors. For arbitrary N , we introduce the representation

$$V_{\begin{array}{|c|} \hline \square \\ \vdots \\ \square \\ \hline \end{array}} \equiv \text{Im} \left(P_{\begin{array}{|c|} \hline \square \\ \vdots \\ \square \\ \hline \end{array}} \right) \quad \text{where } P_{\begin{array}{|c|} \hline \square \\ \vdots \\ \square \\ \hline \end{array}} \equiv \frac{1}{N!} \sum_{\sigma \in S^N} \epsilon(\sigma) \mathcal{P}_\sigma. \quad (\text{A.31})$$

Here, $\epsilon(\sigma) \equiv \prod_{i < j} \frac{\sigma(i) - \sigma(j)}{i - j}$ is the signature of the permutation σ .

An orthonormal basis of this space can be written as

$$\mathcal{B}_{\begin{array}{|c|} \hline \square \\ \vdots \\ \square \\ \hline \end{array}} \equiv \left\{ \begin{array}{|c|} \hline \square \\ \vdots \\ \square \\ \hline \end{array} \left| \begin{array}{l} n_N \\ \vdots \\ n_3 \\ n_2 \\ n_1 \end{array} \right. \begin{array}{l} 1 \leq n_1 < n_2 < \dots < n_N \leq K \end{array} \right\} \quad (\text{A.32})$$

$$\text{where } \begin{array}{|c|} \hline \square \\ \vdots \\ \square \\ \hline \end{array} \equiv \sqrt{N!} P_{\begin{array}{|c|} \hline \square \\ \vdots \\ \square \\ \hline \end{array}} |n_1, n_2, n_3, \dots, n_N\rangle. \quad (\text{A.33})$$

Since $M^{\otimes N}$ commutes with all \mathcal{P}_σ (see (A.28)), this space is invariant under the action of $\pi_N(M)$ for every $M \in \text{GL}(K)$, and it therefore defines a representation of $\text{GL}(K)$. The

Young diagram $N \begin{array}{|c|} \hline \square \\ \vdots \\ \square \\ \hline \end{array} = \underbrace{(1, 1, 1, \dots, 1)}_N, 0, 0, 0, \dots$ will now denote this representation.

The equality (A.30) states that when $N = 2$, the spaces $V_{\square\square}$ and $V_{\begin{array}{|c|} \hline \square \\ \hline \end{array}}$ are not only stable under $\pi_N(M)$ for all M (and therefore they define representations), but even that they are linearly independent and span the whole space $V_2 = (\mathbb{C}^K)^{\otimes 2}$.

Proof of (A.30). The only thing which was not proven above, is that the spaces $V_{\square\square}$ and $V_{\begin{array}{|c|} \hline \square \\ \hline \end{array}}$ are linearly independent and span the whole space $V_2 = (\mathbb{C}^K)^{\otimes 2}$. First their linear independence is easily shown from the equality $P_{\square\square} \circ P_{\begin{array}{|c|} \hline \square \\ \hline \end{array}} = 0 = P_{\begin{array}{|c|} \hline \square \\ \hline \end{array}} \circ P_{\square\square}$. Indeed, if $P_{\square\square} |\phi\rangle + P_{\begin{array}{|c|} \hline \square \\ \hline \end{array}} |\psi\rangle = 0$, then we get $P_{\square\square} (P_{\square\square} |\phi\rangle + P_{\begin{array}{|c|} \hline \square \\ \hline \end{array}} |\psi\rangle) = P_{\square\square} |\phi\rangle = 0$. Moreover, the dimension of these spaces is $\frac{K(K+1)}{2}$ and $\frac{K(K-1)}{2}$, as we can see from (A.25) and (A.31). It follows that their direct sum is the whole space $V_2 = (\mathbb{C}^K)^{\otimes 2}$. \square

If $N > 2$, the relation (A.30) can be generalized, and the right-hand-side will be a sum over the Young diagrams with N boxes, which label different representations. For instance, when $N = 3$, we will show that

$$\square \otimes \square \otimes \square = \square\square\square \oplus 2 \begin{array}{|c|c|} \hline \square & \square \\ \hline \square & \square \\ \hline \end{array} \oplus \begin{array}{|c|} \hline \square \\ \hline \square \\ \hline \square \\ \hline \end{array}. \quad (\text{A.34})$$

In the right-hand-side, the representations $\square\square\square$ and $\begin{array}{|c|} \hline \square \\ \hline \square \\ \hline \square \\ \hline \end{array}$ were already introduced in (A.23,A.31). On the other hand the representation $\begin{array}{|c|c|} \hline \square & \square \\ \hline \square & \square \\ \hline \end{array}$ is obtained by combining symmetrizations (as in (A.24)) and antisymmetrizations (as in (A.31)). Let us define the spaces

$$V_{\begin{array}{|c|c|} \hline \square & \square \\ \hline \square & \square \\ \hline \end{array}} \equiv \text{Im} \left(c_{\begin{array}{|c|c|} \hline \square & \square \\ \hline \square & \square \\ \hline \end{array}} \right) \equiv \text{Im} \left((1 - \mathcal{P}_{1,3}) (1 + \mathcal{P}_{1,2}) \right) \quad (\text{A.35})$$

$$\text{and } \tilde{V}_{\begin{array}{|c|c|} \hline \square & \square \\ \hline \square & \square \\ \hline \end{array}} \equiv \text{Im} \left(\tilde{c}_{\begin{array}{|c|c|} \hline \square & \square \\ \hline \square & \square \\ \hline \end{array}} \right) \equiv \text{Im} \left((1 + \mathcal{P}_{1,3}) (1 - \mathcal{P}_{1,2}) \right). \quad (\text{A.36})$$

These two spaces $V_{\begin{array}{|c|c|} \hline \square & \square \\ \hline \square & \square \\ \hline \end{array}}$ and $\tilde{V}_{\begin{array}{|c|c|} \hline \square & \square \\ \hline \square & \square \\ \hline \end{array}}$ give rise to two isomorphic⁷ representations of $\text{GL}(K)$, which will both be denoted by $\begin{array}{|c|c|} \hline \square & \square \\ \hline \square & \square \\ \hline \end{array}$ in (A.34). The two operators $c_{\begin{array}{|c|c|} \hline \square & \square \\ \hline \square & \square \\ \hline \end{array}}$ and $\tilde{c}_{\begin{array}{|c|c|} \hline \square & \square \\ \hline \square & \square \\ \hline \end{array}}$ generalize the projection operators introduced in (A.24) and (A.31) for the symmetric and antisymmetric representation. One important difference is that $c_{\begin{array}{|c|c|} \hline \square & \square \\ \hline \square & \square \\ \hline \end{array}}$ and $\tilde{c}_{\begin{array}{|c|c|} \hline \square & \square \\ \hline \square & \square \\ \hline \end{array}}$ are not projectors.

Proof of (A.34). First let us show that the four subspaces corresponding to these representations are linearly independent:

$$\text{If } \Sigma \equiv P_{\begin{array}{|c|} \hline \square \\ \hline \square \\ \hline \square \\ \hline \end{array}} |\Psi_1\rangle + P_{\square\square\square} |\Psi_2\rangle + c_{\begin{array}{|c|c|} \hline \square & \square \\ \hline \square & \square \\ \hline \end{array}} |\Psi_3\rangle + \tilde{c}_{\begin{array}{|c|c|} \hline \square & \square \\ \hline \square & \square \\ \hline \end{array}} |\Psi_4\rangle = 0 \quad (\text{A.37})$$

$$\text{then } \left. \begin{array}{l} 0 = P_{\begin{array}{|c|} \hline \square \\ \hline \square \\ \hline \square \\ \hline \end{array}} \Sigma = P_{\begin{array}{|c|} \hline \square \\ \hline \square \\ \hline \square \\ \hline \end{array}} |\Psi_1\rangle \\ 0 = P_{\square\square\square} \Sigma = P_{\square\square\square} |\Psi_2\rangle \end{array} \right\} \text{hence } \tilde{\Sigma} \equiv c_{\begin{array}{|c|c|} \hline \square & \square \\ \hline \square & \square \\ \hline \end{array}} |\Psi_3\rangle + \tilde{c}_{\begin{array}{|c|c|} \hline \square & \square \\ \hline \square & \square \\ \hline \end{array}} |\Psi_4\rangle = 0$$

$$\text{and } 0 = (1 - \mathcal{P}_{1,3}) \tilde{\Sigma} = 2c_{\begin{array}{|c|c|} \hline \square & \square \\ \hline \square & \square \\ \hline \end{array}} |\Psi_3\rangle, \quad (\text{A.38})$$

which shows that they are independent indeed.

Finally, we will conclude by finding the dimension of $V_{\begin{array}{|c|c|} \hline \square & \square \\ \hline \square & \square \\ \hline \end{array}}$. To do this, we just have to notice that the vectors in the set

$$\mathcal{B}_{\begin{array}{|c|c|} \hline \square & \square \\ \hline \square & \square \\ \hline \end{array}} \equiv \left\{ \begin{array}{|c|c|} \hline n_3 & \\ \hline n_1 & n_2 \\ \hline \end{array} \mid n_1 \leq n_2 \text{ and } n_1 < n_3 \right\} \quad (\text{A.39})$$

$$\text{where } \begin{array}{|c|c|} \hline n_3 & \\ \hline n_1 & n_2 \\ \hline \end{array} \equiv \mathcal{N} \left(c_{\begin{array}{|c|c|} \hline \square & \square \\ \hline \square & \square \\ \hline \end{array}} |n_1, n_2, n_3\rangle \right) \quad (\text{A.40})$$

⁷A funny way to see that they are isomorphic is as follows:

First notice that $\text{Im}((1 + \mathcal{P}_{1,3})(1 - \mathcal{P}_{1,2}))$ and $\text{Im}((1 + \mathcal{P}_{1,2})(1 - \mathcal{P}_{1,3}))$ are identical up to a relabelling of \mathcal{H}_2 and \mathcal{H}_3 . Then the Yang-Baxter equation (II.14) tells us that $(1 + \mathcal{P}_{1,2})(1 - \mathcal{P}_{1,3})$ and $(1 - \mathcal{P}_{1,3})(1 + \mathcal{P}_{1,2})$ are equal up to the multiplication, to the right and to the left, by invertible matrices which commute with $\pi_3(M)$. This implies that these representations are isomorphic indeed.

are linearly independent⁸, so that the dimension of $\begin{array}{|c|c|} \hline \square & \square \\ \hline \end{array}$ is at least $\frac{(K-1)K(K+1)}{3}$. If we note that the dimensions of $\begin{array}{|c|c|c|} \hline \square & \square & \square \\ \hline \end{array}$ and $\begin{array}{|c|} \hline \square \\ \hline \square \\ \hline \end{array}$ are respectively $\binom{K+2}{3}$ and $\binom{K}{3}$, we conclude that $\begin{array}{|c|c|c|} \hline \square & \square & \square \\ \hline \end{array} \oplus 2 \begin{array}{|c|c|} \hline \square & \square \\ \hline \end{array} \oplus \begin{array}{|c|} \hline \square \\ \hline \square \\ \hline \end{array}$ has dimension at least K^3 . This dimension argument implies that (A.34) holds and that (A.39) defines a basis of $V_{\begin{array}{|c|c|} \hline \square & \square \\ \hline \end{array}}$. \square

For arbitrary N , the representations associated to Young diagrams with N boxes are constructed like above, by describing some invariant subspaces of $\square \otimes \square \otimes \cdots \otimes \square$. For instance, when $N = 4$, we get

$$\square \otimes \square \otimes \square \otimes \square = \begin{array}{|c|c|c|c|} \hline \square & \square & \square & \square \\ \hline \end{array} \otimes 3 \begin{array}{|c|c|} \hline \square & \square \\ \hline \end{array} \otimes 2 \begin{array}{|c|c|} \hline \square & \square \\ \hline \end{array} \otimes 3 \begin{array}{|c|} \hline \square \\ \hline \square \\ \hline \end{array} \otimes \begin{array}{|c|} \hline \square \\ \hline \square \\ \hline \end{array}. \quad (\text{A.41})$$

For a general Young diagram, the associated representation is the image of a ‘‘Young symmetrizer’’ generalizing the operator $c_{\begin{array}{|c|c|} \hline \square & \square \\ \hline \end{array}}$ of (A.35). For instance for the representations in equation (A.41), one possible expression of the Young symmetrizers is

$$c_{\begin{array}{|c|c|c|} \hline \square & \square & \square \\ \hline \end{array}} = (1 - \mathcal{P}_{1,4}) \cdot (1 + \mathcal{P}_{1,2} + \mathcal{P}_{2,3} + \mathcal{P}_{1,3} + \mathcal{P}_{(1,2,3)} + \mathcal{P}_{(3,2,1)}), \quad (\text{A.42})$$

$$c_{\begin{array}{|c|c|} \hline \square & \square \\ \hline \end{array}} = (1 - \mathcal{P}_{1,3}) \cdot (1 - \mathcal{P}_{2,4}) \cdot (1 + \mathcal{P}_{1,2}) \cdot (1 + \mathcal{P}_{3,4}), \quad (\text{A.43})$$

$$c_{\begin{array}{|c|} \hline \square \\ \hline \square \\ \hline \end{array}} = (1 - \mathcal{P}_{1,3} - \mathcal{P}_{3,4} - \mathcal{P}_{1,4} + \mathcal{P}_{(1,3,4)} + \mathcal{P}_{(4,3,1)}) \cdot (1 + \mathcal{P}_{1,2}), \quad (\text{A.44})$$

where $\mathcal{P}_{(4,3,1)}$ (for instance) is the permutation operator (A.6) associated to the permutation σ such that $\sigma(4) = 3$, $\sigma(3) = 1$, $\sigma(1) = 4$ and $\sigma(2) = 2$. The expressions of these symmetrizers is obtained by first writing a Young tableau with the numbers 1, 2, \dots , N . For instance, let us demonstrate how to get (A.43), by writing the tableau $\begin{array}{|c|c|} \hline 3 & 4 \\ \hline 1 & 2 \\ \hline \end{array}$. Then for each column, we should write the operator which antisymmetrizes with respect to the corresponding indices: that gives $(1 - \mathcal{P}_{1,3}) \cdot (1 - \mathcal{P}_{2,4})$. We should also write for each line the operator which symmetrizes with respect to these indices to get $(1 + \mathcal{P}_{1,2}) \cdot (1 + \mathcal{P}_{3,4})$. Finally we multiply them, and we see that (A.43) arises from the tableau $\begin{array}{|c|c|} \hline 3 & 4 \\ \hline 1 & 2 \\ \hline \end{array}$.

The construction above associates a representation to each Young diagram. It can be proven⁹ that this representation is actually irreducible. In the literature [FH91], the approach suggested above is justified using the ‘‘Schur-Weyl’’ duality, which relies on the fact that the representations of the symmetric group \mathcal{S}^N are also labeled by Young diagrams.

⁸ The linear independence of these vectors can for instance be shown by projecting on the space $\text{Vect}\{|x, y, z\rangle \mid x \leq y \text{ and } x < z\}$.

⁹The converse is not true, and there exist some irreducible representations which are not described by Young diagrams. The correct statement is that all the irreducible, polynomial representations of $\text{GL}(K)$ are described by Young diagrams.

A.3.3 Finite rank groups

In the previous section, we saw how to construct irreducible representations of $GL(K)$, and we wrote a basis for each of them (in terms of Young tableaux). One thing that can be noted is then that the antisymmetric representation (A.31) has dimension $\binom{K}{N}$. If $N = K$, we get a 1-dimensional representation given by $\pi_\lambda(M) = \det(M)$. But if $N > K$, the dimension would be zero, i.e. the antisymmetric representation is not defined. This means that the projector $P_{\left\{ \begin{array}{c} \square \\ \vdots \\ \square \end{array} \right\}_N}$ is zero as soon as $N > K$.

More generally, a Young diagram λ gives rise to a representation of $GL(K)$ only if $|\lambda| \leq K$, where $|\lambda|$ is the number of rows in the Young diagram λ , as defined in (II.64). Indeed, if $|\lambda| > K$, then when we write the Young symmetrizer, the factor corresponding to first column is $P_{\left\{ \begin{array}{c} \square \\ \vdots \\ \square \end{array} \right\}_{|\lambda|}}$, which is zero.

Furthermore, the representations that we have defined are representations of $GL(K)$, thus they also define representations of $SL(K)$ and $SU(K)$, which can actually be shown to be irreducible.

Relation to the representations of $SU(2)$ Finally, let us show that the representations of $SU(2)$ built in section A.2 are also described by Young diagrams. The representation with spin 0 is the trivial representation associated to the empty Young diagram¹⁰. Let us denote this representation by (0) . Then the condition $\det(M) = 1$ (which is automatic for $M \in SU(2)$) shows that $\square = (0)$. Indeed we have seen that this representation obeys $\pi_\lambda(M) = \det(M)$. One can also show that $\square \square = \square$, and this result generalizes to bigger diagrams. As the only possible Young diagrams (i.e. the diagrams obeying $|\lambda| \leq K = 2$) have at most two rows (i.e. $\lambda = (\lambda_1, \lambda_2, 0, 0, \dots)$), we obtain that each representation associated to one of these Young diagrams is isomorphic to a symmetric representation (A.23) (corresponding to $\lambda' = (\lambda_1 - \lambda_2, 0, 0, \dots)$). We will show below that the representation with spin j can be identified with the symmetric representation (A.23) associated to the Young diagram $\lambda_{[1,2j]} = (2j, 0, 0, \dots)$. In this setup, the equality (A.30) corresponds to the well-known fact that the product of two spins $1/2$ is written as the sum of a spin 0 and a spin 1. In the same way, (A.34) implies that the product of three spins $1/2$ is made of two spins $1/2$ and one spin $3/2$.

Let us now prove the identification between the representations of $SU(2)$ defined in section A.2 and the symmetric representations (A.23). To do this, let us define the generators associated to representations of $GL(K)$. In the fundamental representation we can define the operators $e_{i,j}$

$$e_{i,j} |k\rangle = \delta_{j,k} |i\rangle . \tag{A.45}$$

¹⁰As explained in section A.2, this representation corresponds to the vector space \mathbb{R} , and to the morphism $\pi : g \mapsto \mathbb{I}$

It means that $e_{i,j}$ can be viewed as a matrix with all coefficients equal to zero except the coefficient at position (i, j) .

They are such that

$$\text{GL}(K) = \{M \mid \exists (\phi_{i,j})_{1 \leq i,j \leq K} \in \mathbb{C}^{K \times K} : M = \exp \left(\sum_{1 \leq i,j \leq K} \phi_{i,j} e_{i,j} \right)\}. \quad (\text{A.46})$$

This relation can for instance be shown by means of a Jordan decomposition, and it means that the operators $e_{i,j}$ are the generators of $\text{GL}(K)$ in the fundamental representation. They obey the commutation relation

$$[e_{i,j}, e_{k,l}] = \delta_{j,k} e_{i,l} - \delta_{l,i} e_{k,j}. \quad (\text{A.47})$$

By writing the action $\pi_\lambda(M)$ of a group element $M = \exp(\epsilon e_{i,j})$ in the representation λ , one can easily find the expression $\pi_\lambda(e_{i,j})$ of the corresponding generator, which is such that

$$\pi_\lambda(\exp(\epsilon e_{i,j})) = \exp(\epsilon \pi_\lambda(e_{i,j})). \quad (\text{A.48})$$

For instance, in the case when $K = 2$, for the representation $\square\square$, it is easy to write explicitly $\pi_{\square\square}(M)$ in the basis (A.25). Then if we write (A.48) for a small ϵ (keeping only the terms linear in ϵ), we deduce the following expression of the generators of $\text{GL}(2)$ in the representation $\square\square$

$$\pi_{\square\square}(e_{1,1}) = \begin{pmatrix} 2 & 0 & 0 \\ 0 & 1 & 0 \\ 0 & 0 & 0 \end{pmatrix} \quad \pi_{\square\square}(e_{1,2}) = \begin{pmatrix} 0 & \sqrt{2} & 0 \\ 0 & 0 & \sqrt{2} \\ 0 & 0 & 0 \end{pmatrix} \quad (\text{A.49})$$

$$\pi_{\square\square}(e_{2,1}) = \begin{pmatrix} 0 & 0 & 0 \\ \sqrt{2} & 0 & 0 \\ 0 & \sqrt{2} & 0 \end{pmatrix} \quad \pi_{\square\square}(e_{2,2}) = \begin{pmatrix} 0 & 0 & 0 \\ 0 & 1 & 0 \\ 0 & 0 & 2 \end{pmatrix}. \quad (\text{A.50})$$

As expected $\pi_{\square\square}(e_{i,j})$ obeys the same commutation relation as $e_{i,j}$:

$$(\pi_{\square\square}(e_{i,j}), \pi_{\square\square}(e_{k,l}))_- = \delta_{j,k} \pi_{\square\square}(e_{i,l}) - \delta_{l,i} \pi_{\square\square}(e_{k,j}). \quad (\text{A.51})$$

One should nevertheless note that the relation $e_{i,j}e_{k,l} = \delta_{j,k}e_{i,l}$ does not generalize to the generators $\pi_{\square\square}(e_{i,l})$. The same result is easily obtained for an arbitrary Young diagram.

In order to identify them with the generators of (A.15), we should introduce the generators $J^{(1)} = \frac{e_{12} + e_{21}}{2}$, $J^{(2)} = \frac{e_{21} - e_{12}}{2}$, and $J^{(3)} = \frac{e_{11} - e_{22}}{2}$. In a given representation, their action becomes $\pi_\lambda(J^{(1)}) = \frac{\pi_\lambda(e_{12}) + \pi_\lambda(e_{21})}{2}$, $\pi_\lambda(J^{(2)}) = \frac{\pi_\lambda(e_{21}) - \pi_\lambda(e_{12})}{2}$, and $\pi_\lambda(J^{(3)}) = \frac{\pi_\lambda(e_{11}) - \pi_\lambda(e_{22})}{2}$, as it can be seen from (A.48). Then, the expressions (A.49,A.50) allow to check that $\pi_{\square\square}(J^{(l)})$ coincides exactly with $J_1^{(l)}$ defined in (A.15). Thus we have shown the identification between the representation $\square\square$ and the representation with spin $j = 1$ constructed in section A.2.

This analysis of the generators can be generalized to an arbitrary Young diagram. For instance for the representation $\lambda = (N, 0, 0, \dots) = \underbrace{\square\square\dots\square}_N$, it gives

$$\pi_{\underbrace{\square\square\dots\square}_N}(e_{i,j}) = P_{\underbrace{\square\square\dots\square}_N} \cdot \left(\sum_{k=1}^N \mathbb{I}^{\otimes(i-1)} \otimes e_{i,j} \otimes \mathbb{I}^{\otimes(N-k)} \right) \cdot P_{\underbrace{\square\square\dots\square}_N}, \quad (\text{A.52})$$

expressed in terms of the projector (A.24). Writing explicitly these generators, as in (A.49- A.50), allows to prove the identification between this representation (if we restrict it to $SU(2)$) and the representation of $SU(2)$ with spin $j = N/2$.

A.3.4 Characters

We have seen that to each Young diagram λ is associated a representation, and for several examples we defined an orthonormal basis, and wrote the morphism $g \mapsto \pi_\lambda(g)$. It is then possible to compute the characters χ_λ of these representations, using the definition (A.2).

To do this, the first useful relation is that for any representation λ ,

$$\begin{aligned} \chi_\lambda(h \cdot g \cdot h^{-1}) &= \text{tr}_\lambda(\pi_\lambda(h)\pi_\lambda(g)\pi_\lambda(h^{-1})) = \text{tr}_\lambda(\pi_\lambda(g)\pi_\lambda(h^{-1})\pi_\lambda(h)) \\ &= \chi_\lambda(g). \end{aligned} \quad (\text{A.53})$$

This relation shows that the characters are ‘‘class functions’’, and allows to find the character of an arbitrary g provided we know the characters of diagonal matrices. Let us show explicitly how to express these characters for the symmetric representation $\underbrace{\square\square\dots\square}_N$, by starting with the particular case of a diagonal matrix $g = \text{diag}(x_1, x_2, \dots, x_K) \in \text{GL}(K)$. In order to compute the trace of $\pi_{\underbrace{\square\square\dots\square}_N}(g)$, let us first note that

$$\pi_{\underbrace{\square\square\dots\square}_N}(g) \begin{array}{|c|c|c|} \hline n_1 & n_2 & n_3 \\ \hline \end{array} \dots \begin{array}{|c|} \hline n_N \\ \hline \end{array} = \left(\prod_{i=1}^N x_{n_i} \right) \begin{array}{|c|c|c|} \hline n_1 & n_2 & n_3 \\ \hline \end{array} \dots \begin{array}{|c|} \hline n_N \\ \hline \end{array}. \quad (\text{A.54})$$

By summing over these basis vectors (defined in (A.25)), one can deduce that the character of g is equal to

$$\chi_{\underbrace{\square\square\dots\square}_N}(g) = \sum_{\substack{C_1, C_2, \dots, C_K \geq 0 \\ C_1 + C_2 + \dots + C_K = N}} \prod_{j=1}^K x_j^{C_j}. \quad (\text{A.55})$$

The relation (A.53) allows to deduce the character of an arbitrary diagonalizable matrix. Moreover the set of the diagonalizable matrices is dense in $\text{GL}(K)$, and for diagonalizable matrices the character is a continuous function of the eigenvalues (it is even a polynomial), hence we can deduce that for an arbitrary $g \in \text{GL}(K)$, if we denote the eigenvalues of g as x_1, x_2, \dots, x_K , then the character of g is given by (A.55).

Schur polynomials and Weyl formulae For an arbitrary Young diagram λ , the same procedure allows to compute the character of any group element $g \in \text{GL}(\mathbb{K})$. Because of the relation (A.53), that gives a symmetric function of the eigenvalues of g . Moreover, for any Young diagram, this character is a polynomial function of the eigenvalues of g , because the matrix elements of the operator $\pi_\lambda(g)$ are polynomial functions of the matrix elements of g . These polynomials, which are symmetric functions of \mathbb{K} variables are called ‘‘Schur polynomials’’.

Performing this analysis for an arbitrary Young diagram λ (identified to a set of integers, as in (A.21)), yields the following expression of characters as ratios of determinants:

$$\chi_\lambda(g) = \frac{\left| (x_j^{\lambda_i + \mathbb{K} - i})_{1 \leq i, j \leq \mathbb{K}} \right|}{\left| (x_j^{\mathbb{K} - i})_{1 \leq i, j \leq \mathbb{K}} \right|}, \quad (\text{A.56})$$

where the x_j still denote the eigenvalues of g , and this expression holds even if g is not diagonalizable. This formula is sometimes called the ‘‘first Weyl formula’’.

Another relation holds for these characters, which can be obtained from (A.56). It reads

$$\chi_\lambda(g) = \left| \left(\chi_{\underbrace{\square \dots \square}_{\lambda_i + j - i}}(g) \right)_{1 \leq i, j \leq |\lambda|} \right|, \quad (\text{A.57})$$

where $|\lambda|$ denotes the number of rows in the Young diagram λ (i.e. the largest integer a such that $\lambda_a > 0$). The formula (A.57) is sometimes called the ‘‘second Weyl formula’’, and if we insert the expression (A.55) into it, it allows to recover the expression (A.56).

Moreover, the expression (A.55) can be very conveniently recast into the following generating series:

$$w(z) \equiv \sum_{s=0}^{\infty} z^s \chi^{(s)}(g) = \prod_{j=1}^{\mathbb{K}} \frac{1}{1 - x_j z} = \det \frac{1}{1 - g z} \quad (\text{A.58})$$

$$\text{where } \chi^{(s)} \equiv \chi_{\underbrace{\square \dots \square}_s}. \quad (\text{A.59})$$

This expression will be convenient to write the character of symmetric representations, in order to plug it into the ‘‘second Weyl Formula’’ (A.57).

A.4 Generalization to the super-group $\text{GL}(\mathbb{K}|\mathbb{M})$

Introduction to $\text{GL}(\mathbb{K}|\mathbb{M})$ The group $\text{GL}(\mathbb{K}|\mathbb{M})$ is obtained by introducing some matrices such that $(A \otimes \mathbb{I}) \cdot (\mathbb{I} \otimes B) = -(\mathbb{I} \otimes B) \cdot (A \otimes \mathbb{I})$. Two matrices A and B such that $(A \otimes \mathbb{I}) \cdot (\mathbb{I} \otimes B) = -(\mathbb{I} \otimes B) \cdot (A \otimes \mathbb{I})$ are said to be anti-commuting, and associated to the grading $p_A = p_B = 1 \in \mathbb{Z}/2\mathbb{Z}$. On the other hand, if A is such that for all B , $(A \otimes \mathbb{I}) \cdot (\mathbb{I} \otimes B) = (\mathbb{I} \otimes B) \cdot (A \otimes \mathbb{I})$, then A is said to be commuting, and associated to

the grading $p_A = 0 \in \mathbb{Z}/2\mathbb{Z}$. We can see that with these definitions, if both A and B have a well-defined grading, then

$$(A \otimes \mathbb{I}) \cdot (\mathbb{I} \otimes B) = (-1)^{p_A p_B} (\mathbb{I} \otimes B) \cdot (A \otimes \mathbb{I}) . \quad (\text{A.60})$$

Similarly to the section A.1, it is convenient to introduce coordinates for operators, as well as for vectors. In coordinates, the relation (A.60) means that $A_{j_1}^{i_1} B_{j_2}^{i_2} = \pm B_{j_2}^{i_2} A_{j_1}^{i_1}$, which means that the coordinates of matrices can be commuting or anti-commuting variables. In what follows, we will introduce these coordinates in such a way that the matrix multiplications and tensor products have the same expression in terms of coordinates as for usual matrices in $\text{GL}(\mathbb{K})$.

Let us then define a basis of vectors $| (1) \rangle, | (2) \rangle, \dots, | (K + M) \rangle$, and define a hermitian product such that the basis is orthonormal, i.e. such that $\langle (m) | (n) \rangle = \delta_{m,n}$. $\text{GL}(\mathbb{K} | M)$ is defined by choosing an arbitrary grading $i \mapsto p_i$ (where $i \in \llbracket 1, K + M \rrbracket$ and $p_i \in \mathbb{Z}/2\mathbb{Z}$) taking K times the value 0 and M times the value 1. For instance one can choose

$$p_i = 0 \quad \text{if } i \in \llbracket 1, K \rrbracket \quad (\text{A.61})$$

$$p_i = 1 \quad \text{if } i \in \llbracket K + 1, M \rrbracket , \quad (\text{A.62})$$

Then we will say that $\langle (n) |$ and $| (n) \rangle$ have the grading p_n , and the rule (A.60) implies that

$$\langle (i) | \otimes \langle (j) | \cdot (| (k) \rangle \otimes | (l) \rangle) = (-1)^{p_j p_k} \delta_{i,k} \delta_{j,l} \quad (\text{A.63})$$

Let us denote by $v = | (n_1, n_2, \dots, n_L) \rangle$ the vector $| (n_1) \rangle \otimes | (n_2) \rangle \otimes \dots \otimes | (n_L) \rangle$. We define its coordinates as $v^{i_1, i_2, \dots, i_L} = \prod_{j=1}^L \theta_j^{p_{n_j}} \delta_{n_j}^{i_j}$, where $(\theta_i)_{i=1 \dots L}$ is a set of anti-commuting variables, which obey the relation

$$(\theta_i, \theta_j)_+ \equiv \theta_i \theta_j + \theta_j \theta_i = \delta_{i,j} . \quad (\text{A.64})$$

These coordinates are designed to manipulate products of matrices and vector with the same notation as for usual matrices, and the price for that is that the coordinates of some vectors are anti-commuting objects.

For an arbitrary vector $| v \rangle$, this definition of the coordinates means that

$$v^{i_1, i_2, \dots, i_L} \equiv \theta_1^{p_{i_1}} \theta_2^{p_{i_2}} \dots \theta_L^{p_{i_L}} \langle (i_1, i_2, \dots, i_L) | v \rangle . \quad (\text{A.65})$$

In this definition, $\langle (i_1, i_2, \dots, i_L) |$ is defined by

$$\langle (i_1, i_2, \dots, i_L) | (j_1, j_2, \dots, j_L) \rangle = \prod_{s,p,k=1}^L \delta_{i_k, j_k} . \quad (\text{A.66})$$

For instance if $L = 2$ it means that

$$\langle (i_1, i_2) | = (-1)^{p_{i_1} p_{i_2}} \langle (i_1) | \otimes \langle (i_2) | . \quad (\text{A.67})$$

We can also define the coordinates of an operator \mathcal{O} as

$$\mathcal{O}_{j_1, j_2, \dots, j_L}^{i_1, i_2, \dots, i_L} = \theta_1^{p_{i_1}} \theta_2^{p_{i_2}} \dots \theta_L^{p_{i_L}} \theta_L^{p_{j_L}} \theta_{L-1}^{p_{j_{L-1}}} \dots \theta_1^{p_{j_1}} \langle (i_1, i_2, \dots, i_L) | \mathcal{O} | (j_1, j_2, \dots, j_L) \rangle \quad (\text{A.68})$$

which is defined in such a way that

$$(\mathcal{O} | v) \rangle^{i_1, i_2, \dots, i_L} = \mathcal{O}_{k_1, k_2, \dots, k_L}^{i_1, i_2, \dots, i_L} v^{k_1, k_2, \dots, k_L}, \quad (\text{A.69})$$

which means that the manipulation of products (in terms of contracted indices) is exactly the same as for usual groups.

Moreover one can show that¹¹

$$(A \otimes B)_{j_1, j_2}^{i_1, i_2} = A_{j_1}^{i_1} B_{j_2}^{i_2}. \quad (\text{A.70})$$

The group $\text{GL}(\mathbf{K}|\mathbf{M})$, is then the group of the invertible operators acting on $\text{Vect} \{ |(1)\rangle, |(2)\rangle, \dots, |(\mathbf{K} + \mathbf{M})\rangle \}$. By writing their coordinates as defined above, we see that they are of the form

$$M = \begin{pmatrix} \mathcal{A} & \theta_i \mathcal{B} \\ \theta_i \mathcal{C} & \mathcal{D} \end{pmatrix} \quad (\text{A.71})$$

where \mathcal{A} , \mathcal{B} , \mathcal{C} and \mathcal{D} are complex matrices of respective size $\mathbf{K} \times \mathbf{K}$, $\mathbf{K} \times \mathbf{M}$, $\mathbf{M} \times \mathbf{K}$ and $\mathbf{M} \times \mathbf{M}$. The coefficients θ_i are anti-commuting variables in the sense of (A.64). We see that for a matrix of the form (A.71), the grading associated to the matrix element M_j^i of is exactly $p_i + p_j$.

Representations of $\text{GL}(\mathbf{K}|\mathbf{M})$ We will call fundamental representation of $\text{GL}(\mathbf{K}|\mathbf{M})$ the representation defined by the space $\text{Vect} \{ |(1)\rangle, |(2)\rangle, \dots, |(\mathbf{K} + \mathbf{M})\rangle \}$ and by the morphism $\pi(M) = M$. We will denote it as \square .

For any matrix of this group, we define its “super-trace” and its “super-determinant” as

$$\text{Str} \begin{pmatrix} \mathcal{A} & \mathcal{B} \\ \mathcal{C} & \mathcal{D} \end{pmatrix} = \text{tr} \mathcal{A} - \text{tr} \mathcal{D} \quad \text{Sdet}(M) = e^{\text{Str}(\log M)} \quad (\text{A.72})$$

With these definitions, one can generalize to these super-groups the construction given in section A.3.2. First we should generalize the permutation operators \mathcal{P} which appear in the definitions (A.24), (A.31), (A.35), etc. For bosonic groups, an interesting property of \mathcal{P} was that the permutation operator commutes with $M^{\otimes N}$. This property was crucial as it allowed to prove that several vector spaces were stable under the action of $\pi_\lambda(M)$, for all $M \in \text{GL}(\mathbf{K})$. For a super-group, the definition (A.6) of the permutation operator has to be slightly modified. Indeed, one can check that if we keep the definition

¹¹ In (A.70), the coordinates of A and B are given by $A_{j_1}^{i_1} = \theta_1^{p_{i_1} + p_{j_1}} \langle (i_1) | A | (j_1) \rangle$ and $B_{j_2}^{i_2} = \theta_2^{p_{i_2} + p_{j_2}} \langle (i_2) | B | (j_2) \rangle$.

(A.6) then $\mathcal{P}_\sigma \cdot M^N$ and $M^N \cdot \mathcal{P}_\sigma$ are equal only up to a sign. In order to make this sign disappear, one can define the permutation operator as

$$\mathcal{P}_{(\sigma)} : |(n_1, n_2, \dots, n_L)\rangle \mapsto \prod_{k < l} \left(\frac{\sigma(k) - \sigma(l)}{|k - l|} \right)^{p_{n_k} + p_{n_l}} |(n_{\sigma(1)}, \dots, n_{\sigma(L)})\rangle. \quad (\text{A.73})$$

With this definition of the generalized permutation, one can associate representations of $\text{GL}(\mathbb{K}|\mathbb{M})$ to Young diagrams. This is done as in section A.3.2 by considering tensor products of the form $\underbrace{\square \otimes \square \otimes \dots \otimes \square}_N$ (where \square denotes the fundamental representation), and restricting it to the image of combinations of the permutation operators generalized according to (A.73). This gives rise to a set of irreducible representations of $\text{GL}(\mathbb{K}|\mathbb{M})$.

Unlike the $\text{GL}(\mathbb{K})$ case, there also exist other polynomial irreducible representations of $\text{GL}(\mathbb{K}|\mathbb{M})$, because the fundamental representation is not unique. Indeed, we have chosen to define the fundamental representation \square as a set of vectors who have \mathbb{K} coordinates with grading $(-1)^{p_n} = +1$ and \mathbb{M} coordinates with grading $(-1)^{p_n} = -1$. But one could also consider a set \square of vectors who have \mathbb{M} coordinates with grading $(-1)^{p_n} = +1$ and \mathbb{K} coordinates with grading $(-1)^{p_n} = -1$. Several representations can then be built from tensor products involving both \square and \square , which makes the representation theory of $\text{GL}(\mathbb{K}|\mathbb{M})$ richer than for $\text{GL}(\mathbb{K})$. In the present manuscript, tensor products involving \square will not be considered, and we will restrict to representations described by usual Young diagrams.

For these representations, we can define characters (like in section A.3.4, except that the character should now be defined as a super-trace), and one can show [BBB81] that (A.58) is generalized as follows :

$$w(z) \equiv \sum_{s=0}^{\infty} z_s \chi^{(s)} = \text{Sdet} \left(\frac{1}{1 - g z} \right) \quad (\text{A.74})$$

which allows to find the characters of arbitrary representations using the second Weyl formula (A.57). On the contrary, the first Weyl formula (A.56) does not hold in the case of super-groups.

“fat-hook” condition For usual groups we saw that only the Young diagrams with less than \mathbb{K} rows gave rise to representations of $\text{GL}(\mathbb{K})$. It is interesting to see how this condition generalizes to $\text{GL}(\mathbb{K}|\mathbb{M})$: for super-groups, the projector $\mathbb{P} \left. \begin{array}{c} \square \\ \vdots \\ \square \end{array} \right\} N = \frac{1}{N!} \sum_{\sigma \in \mathcal{S}^N} \epsilon(\sigma) \mathcal{P}_\sigma$

(associated to the representation $\left. \begin{array}{c} \square \\ \vdots \\ \square \end{array} \right\} N$) does not vanish when $N > \mathbb{K}$ because \mathcal{P} itself contains a sign. This sign is such that the indices with grading $(-1)^{p_i} = +1$ are antisymmetrized and the indices with grading $(-1)^{p_i} = -1$ are symmetrized. It can be shown [DM92, Tsu97] that the Young diagrams which give rise to representations of $\text{GL}(\mathbb{K}|\mathbb{M})$ are the diagrams such that $\lambda_{\mathbb{K}+1} \leq \mathbb{M}$. They are represented in figure II.4 page 39.

Appendix B

Properties of co-derivatives

B.1 Diagrammatic expressions for co-derivatives

This section will explain how to explicitly compute expressions involving co-derivatives, mainly by using the Leibniz rule (II.59). We will see that the repeated action of co-derivatives, computed through this Leibniz rule, gives rise to diagrammatic expressions.

As indicated by expression (II.63), we will be specifically interested in co-derivatives acting on characters. As it can be seen in (A.57), arbitrary characters are linear combinations of products of characters of symmetric representations. Moreover the characters of symmetric representations are simply encoded into the function $w(z)$ defined in (A.58). We will therefore focus on co-derivative acting on $w(z)$ or on products like $w(x)w(y)w(z)$.

First properties of the co-derivatives Let us first remind a few simple properties of the co-derivatives, defined in chapter II. This co-derivative is defined by

$$\hat{D} \otimes f(g) \equiv \frac{\partial}{\partial \phi^i} \otimes f(e^{\langle \phi, e \rangle} g) \Big|_{\phi=0} \quad (\text{B.1})$$

$$= \sum_{\alpha, \beta} e_{\alpha, \beta} \otimes \left(\frac{\partial}{\partial \phi_{\beta, \alpha}} f(e^{\sum_{\gamma, \delta} e_{\gamma, \delta} \phi_{\gamma, \delta}} g) \right) \Big|_{\phi \rightarrow 0}, \quad (\text{B.2})$$

where $\phi \in M(K)$ is a $K \times K$ matrix and $\langle \phi, e \rangle$ denotes $\sum_{\alpha, \beta} e_{\alpha, \beta} \phi_{\alpha, \beta}$, where the $e_{\alpha, \beta}$ are the generators of $GL(K)$, introduced in the appendix A.3.2 (they are matrices with one single non-zero coefficient at position α, β).

From this definition, let us show how to compute $\hat{D}w(z)$. As a first step, the simplest explicit computation one can do is the co-derivative of g itself :

$$\begin{aligned} \hat{D} \otimes g &= \sum_{\alpha, \beta} e_{\alpha, \beta} \otimes \left(\frac{\partial}{\partial \phi_{\beta, \alpha}} \left(1 + \langle \phi, e \rangle + \frac{\langle \phi, e \rangle^2}{2} + \dots \right) \cdot g \Big|_{\phi \rightarrow 0} \right) \\ &= \sum_{\alpha, \beta} e_{\alpha, \beta} \otimes (e_{\beta, \alpha} \cdot g) = \mathcal{P}_{1,2} \cdot (\mathbb{I} \otimes g). \end{aligned} \quad (\text{B.3})$$

The next simplest thing that we can compute is $\hat{D} \otimes g^n$, and in order to write it, we need to use the Leibniz rule (II.59) below :

$$\hat{D} \otimes (f_1(g) \cdot f_2(g)) = \left[\hat{D} \otimes f_1(g) \right] \cdot (\mathbb{I} \otimes f_2(g)) + (\mathbb{I} \otimes f_1(g)) \cdot \left[\hat{D} \otimes f_2(g) \right]. \quad (\text{B.4})$$

From the expression (B.3), this Leibniz rule allows to deduce iteratively that

$$\hat{D} \otimes g^n = \mathcal{P}_{1,2} \cdot \left(\sum_{k=1}^n g^{n-k} \otimes g^k \right). \quad (\text{B.5})$$

As the trace is linear, we can also easily compute

$$\hat{D} \operatorname{tr}(g^n) = \operatorname{tr}_2 \left(\hat{D} \otimes g^n \right) = n g^n, \quad (\text{B.6})$$

because $\text{tr}_2(\mathcal{P}_{1,2} \cdot (A \otimes B)) = B \cdot A$. Then we get

$$\hat{D} \text{tr}(\log(1 - g z)) = - \sum_{n \geq 1} \hat{D} \text{tr} \frac{(g z)^n}{n} = - \sum_{n \geq 1} (g z)^n = - \frac{g z}{1 - g z} \quad (\text{B.7})$$

And finally, we can compute the derivative of $w(z) = e^{-\text{tr}(\log(1-g z))}$:

$$\hat{D} w(z) = - \left[\hat{D} \text{tr}(\log(1 - g z)) \right] \cdot e^{-\text{tr}(\log(1-g z))} = \frac{g z}{1 - g z} w(z). \quad (\text{B.8})$$

Now, let us see the effect of multiple successive co-derivatives, using the Leibniz rule (II.59):

$$\hat{D} \otimes \hat{D} w(z) = \hat{D} \otimes \left(\frac{g z}{1 - g z} w(z) \right) \quad (\text{B.9})$$

$$= \left[\hat{D} \otimes \frac{g z}{1 - g z} \right] w(z) + \left[\hat{D} w(z) \otimes \mathbb{I} \right] \cdot \left(\mathbb{I} \otimes \frac{g z}{1 - g z} \right) \quad (\text{B.10})$$

$$= \left(\frac{g z}{1 - g z} \otimes \frac{g z}{1 - g z} + \mathcal{P}_{1,2} \cdot \left(\frac{1}{1 - g z} \otimes \frac{g z}{1 - g z} \right) \right) w(z) \quad (\text{B.11})$$

where we used

$$\hat{D} \otimes \frac{g z}{1 - g z} = \sum_{n \geq 1} \hat{D} \otimes (g z)^n = \mathcal{P}_{1,2} \cdot \sum_{\substack{m \geq 0 \\ p \geq 1}} g^m \otimes g^p \quad (\text{B.12})$$

$$= \mathcal{P}_{1,2} \cdot \left(\frac{1}{1 - g z} \otimes \frac{g z}{1 - g z} \right). \quad (\text{B.13})$$

Expression of $\hat{D}^{\otimes L} w(z)$ from \hat{D} -diagrams Let us now write the relations (B.8) and (B.11) at the level of coordinates, and introduce diagrams summarizing these relations :

$$\left(\hat{D} w(z) \right)_j^i = \left(\frac{g z}{1 - g z} \right)_j^i w(z) \equiv \begin{array}{c} i \\ | \\ j \end{array} w(z) \quad (\text{B.14})$$

$$\begin{aligned} \left(\hat{D} \otimes \hat{D} w(z) \right)_{j_1, j_2}^{i_1, i_2} &= \left(\left(\frac{g z}{1 - g z} \right)_{j_1}^{i_1} \left(\frac{g z}{1 - g z} \right)_{j_2}^{i_2} \right. \\ &\quad \left. + \left(\frac{1}{1 - g z} \right)_{j_1}^{i_2} \left(\frac{g z}{1 - g z} \right)_{j_2}^{i_1} \right) w(z) \end{aligned} \quad (\text{B.15})$$

$$\equiv \left(\begin{array}{c} i_1 i_2 \\ | | \\ j_1 j_2 \end{array} + \begin{array}{c} i_1 i_2 \\ \times \\ j_1 j_2 \end{array} \right) w(z). \quad (\text{B.16})$$

In this notation, the dots are labeled by the indices i_k and j_k , and solid lines connecting them correspond to the operator $\frac{g z}{1 - g z}$, while dashed line correspond to the operator $\frac{1}{1 - g z}$.

We will call \hat{D} -diagrams these pictures which stand for operators : for instance the \hat{D} -diagram $\begin{array}{c} \cdot \\ \diagup \quad \diagdown \\ \cdot \end{array}$ will stand for the operator $\mathcal{P}_{1,2} \cdot \left(\frac{1}{1-gz} \otimes \frac{gz}{1-gz} \right)$ which has coordinates

$$\begin{array}{c} i_1 i_2 \\ \cdot \\ \diagup \quad \diagdown \\ \cdot \\ j_1 j_2 \end{array} \equiv \left(\frac{1}{1-gz} \right)_{j_1}^{i_2} \left(\frac{gz}{1-gz} \right)_{j_2}^{i_1}.$$

As we will see, these \hat{D} -diagrams actually allow to generalize the results (B.14) and (B.16) to an arbitrary number of spins. For instance we will get, for 3 spins,

$$\begin{aligned} & \left(\hat{D}^{\otimes 3} w(z) \right)_{j_1, j_2, j_3}^{i_1, i_2, i_3} \\ &= \left(\begin{array}{c} i_1 i_2 i_3 \\ \parallel \parallel \parallel \\ j_1 j_2 j_3 \end{array} + \begin{array}{c} i_1 i_2 i_3 \\ \parallel \cdot \cdot \\ j_1 j_2 j_3 \end{array} + \begin{array}{c} i_1 i_2 i_3 \\ \cdot \cdot \parallel \\ j_1 j_2 j_3 \end{array} + \begin{array}{c} i_1 i_2 i_3 \\ \cdot \cdot \cdot \\ j_1 j_2 j_3 \end{array} + \begin{array}{c} i_1 i_2 i_3 \\ \cdot \cdot \cdot \\ j_1 j_2 j_3 \end{array} + \begin{array}{c} i_1 i_2 i_3 \\ \cdot \cdot \cdot \\ j_1 j_2 j_3 \end{array} \right) w(z), \end{aligned} \quad (\text{B.17})$$

from where one easily finds the generalization to L spins : $\hat{D}^{\otimes L} w(z)$ contains L! terms, corresponding to the L! permutations $\sigma \in \mathcal{S}^L$, where \mathcal{S}^L denotes the set of all permutations of $\llbracket 1, L \rrbracket$. For each given permutation, the corresponding \hat{D} -diagram is obtained by connecting j_k to $i_{\sigma(k)}$ through a dashed line if $\sigma(k) > k$ and through a solid line otherwise. The corresponding expression

$$\boxed{\left(\hat{D}^{\otimes L} w(z) \right)_{j_1, j_2, \dots, j_L}^{i_1, i_2, \dots, i_L} = \sum_{\sigma \in \mathcal{S}^L} \prod_{k=1}^L \left(\frac{(gz)^{\theta(k-\sigma(k))}}{1-gz} \right)_{j_k}^{i_{\sigma(k)}} w(z)} \quad (\text{B.18})$$

$$\text{where } \theta(n) = \begin{cases} 1 & \text{if } n \geq 0 \\ 0 & \text{otherwise} \end{cases} \quad (\text{B.19})$$

can be proven by recurrence over L.

Proof. To perform this recurrence, one assumes (B.18) and length L and gets from L to L + 1 using the Leibniz rule to describe the action of a co-derivative :

$$\begin{aligned} & \hat{D}_{j_1}^{i_1} \left(\hat{D}^{\otimes L} w(z) \right)_{j_2, j_3, \dots, j_{L+1}}^{i_2, i_3, \dots, i_{L+1}} \\ &= \hat{D}_{j_1}^{i_1} \sum_{\sigma \in \mathcal{S}^L} \prod_{k=1}^L \left(\frac{(gz)^{\theta(k-\sigma(k))}}{1-gz} \right)_{j_{k+1}}^{i_{\sigma(k)+1}} w(z) \end{aligned} \quad (\text{B.20})$$

$$\begin{aligned} &= \left(\frac{gz}{1-gz} \right)_{j_1}^{i_1} \sum_{\sigma \in \mathcal{S}^L} \prod_{k=1}^L \left(\frac{(gz)^{\theta(k-\sigma(k))}}{1-gz} \right)_{j_{k+1}}^{i_{\sigma(k)+1}} w(z) \\ &+ \sum_{\sigma \in \mathcal{S}^L} \sum_{k=1}^L \left(\frac{gz}{1-gz} \right)_{j_{k+1}}^{i_1} \left(\frac{1}{1-gz} \right)_{j_1}^{i_{\sigma(1)+1}} \prod_{l \neq k} \left(\frac{(gz)^{\theta(1-\sigma(l))}}{1-gz} \right)_{j_{l+1}}^{i_{\sigma(l)+1}} w(z), \end{aligned} \quad (\text{B.21})$$

where we also use the notation $\hat{D}_{j_1}^{i_1} \hat{D}_{j_2}^{i_2} \dots \hat{D}_{j_L}^{i_L} f(g) \equiv \left(\hat{D}^{\otimes L} f(g) \right)_{j_1, j_2, \dots, j_L}^{i_1, i_2, \dots, i_L}$.

In (B.21), the first line is the contribution of the co-derivative to the left acting on $w(z)$. It can be rewritten as

$$\sum_{\substack{\sigma \in \mathcal{S}^{L+1} \\ \sigma(1)=1}} \prod_{k=1}^{L+1} \left(\frac{(g z)^{\theta(k-\sigma(k))}}{1-g z} \right)_{j_k}^{i_{\sigma(k)}} w(z).$$

The second line is the contribution of the co-derivative to the left acting on the k^{th} factor of (B.18). It is obtained by noticing that $\hat{D} \frac{1}{1-g z} = \hat{D} \frac{g z}{1-g z}$, and by writing (B.13) in coordinates. This term is equal to

$$\sum_{k=1}^L \sum_{\substack{\sigma \in \mathcal{S}^{L+1} \\ \sigma(k+1)=1}} \prod_{k=1}^{L+1} \left(\frac{(g z)^{\theta(k-\sigma(k))}}{1-g z} \right)_{j_k}^{i_{\sigma(k)}} w(z).$$

Grouping these terms together, we get (B.18) for $L \rightarrow L+1$, which proves the relation by a recurrence which starts from the most case $L=0$. \square

generalization to $u_i \neq 0$ A first generalization of this result is to express the operator $\left[\bigotimes_{i=1}^L (u_i + \hat{D}) w(z) \right]$: this is not complicated and for instance at $L=2$, it is obtained as $(u_1 + \hat{D}) \otimes (u_2 + \hat{D}) w(z) = u_1 u_2 \mathbb{I} w(z) + u_1 \mathbb{I} \otimes [\hat{D} w(z)] + u_2 [\hat{D} w(z)] \otimes \mathbb{I} + [\hat{D} \otimes \hat{D} w(z)]$.

For arbitrary L , we get the expression

$$\left[\bigotimes_{i=1}^L (u_i + \hat{D}) w(z) \right] = \sum_{\sigma \in \mathcal{S}^L} \prod_{k=1}^L \left(u_k \delta_k^{\sigma(k)} \delta_{j_k}^{i_k} + \left(\frac{(g z)^{\theta(k-\sigma(k))}}{1-g z} \right)_{j_k}^{i_{\sigma(k)}} \right) w(z). \quad (\text{B.22})$$

In particular, in the case $\forall i, u_i = 1$, this simplifies to

$$\left[(1 + \hat{D})^{\otimes L} w(z) \right] = \sum_{\sigma \in \mathcal{S}^L} \prod_{k=1}^L \left(\frac{(g z)^{\theta(k-\sigma(k)-1)}}{1-g z} \right)_{j_k}^{i_{\sigma(k)}} w(z), \quad (\text{B.23})$$

which means, in terms of \hat{D} -diagrams (B.14, B.16, B.17), that the vertical lines become dashed instead of solid.

Generalization to $\left[\bigotimes_{i=1}^L (u_i + \hat{D}) w(z_1) \cdots w(z_n) \right]$ Let us now generalize the equation (B.22) to the operator $\mathcal{W}(u; z_1, \dots, z_n) \equiv \left[\bigotimes_{i=1}^L (u_i + \hat{D}) w(z_1) \cdots w(z_n) \right]$. First, if $L=1$, we get

$$\left[(u_1 + \hat{D}) w(z_1) \cdots w(z_n) \right] = \left(u_1 + \sum_{k=1}^n \frac{g z_k}{1-g z_k} \right) w(z_1) \cdots w(z_n), \quad (\text{B.24})$$

by using a Leibniz rule where the co-derivative can either act on $w(z_1)$ or on $w(z_2)$ or on any other $w(z_k)$. This can be represented diagrammatically as

$$\left[(\mathbf{u}_1 + \hat{D}) \quad w(z_1) \cdots w(z_n) \right] = \left(\mathbb{I} + \sum_{k=1}^n \mathbb{I}_k \right) w(z_1) \cdots w(z_n), \quad (\text{B.25})$$

where \mathbb{I}_k denotes the operator $\frac{g}{1-g} \frac{z_k}{z_k}$, and a line \mathbb{I} at position i denotes the operator $\mathbf{u}_i \mathbb{I}$ (here $i = 1$). For two spins the action of the next co-derivative gives

$$\begin{aligned} & \left[\bigotimes_{i=1}^2 (\mathbf{u}_i + \hat{D}) \quad w(z_1) \cdots w(z_n) \right] \\ &= \left(\mathbb{I} \mathbb{I} + \sum_{k=1}^n \left(\mathbb{I}_k \mathbb{I} + \mathbb{I} \mathbb{I}_k \right) + \sum_{1 \leq k, k' \leq n} \mathbb{I}_{kk'} + \sum_{k=1}^n \mathbb{X}_{kk} \right) w(z_1) \cdots w(z_n), \end{aligned} \quad (\text{B.26})$$

where the last term arises from $\left[\hat{D} \otimes \sum_{k=1}^n \mathbb{I}_k \right]$, using the relation $\left[\hat{D} \otimes \mathbb{I}_k \right] = \mathbb{X}_{kk}$ where \mathbb{X}_{kk} stands for the operator $\frac{1}{1-g} \frac{z_k}{z_k}$. On the other hand, the first terms correspond to

$$\left(\mathbb{I} + \sum_{k=1}^n \mathbb{I}_k \right) \otimes \left(\mathbb{I} + \sum_{k=1}^n \mathbb{I}_k \right) w(z_1) \cdots w(z_n),$$

which arises if all co-derivatives act directly on $w(z_1) \cdots w(z_n)$. In this notation, the \hat{D} -diagram \mathbb{I}_k (for instance) denotes the operator $\frac{g}{1-g} \frac{z_k}{z_k} \otimes (\mathbf{u}_2 \mathbb{I})$.

This expression can be generalized for L spin, where it is expressed as a sum of \hat{D} -diagrams. We saw above that the expression $\hat{D}^{\otimes L} w(z)$ can be written as a sum of \hat{D} diagrams obeying certain rules (there is one \hat{D} -diagram for each permutation, and a rule says what line is dashed or solid). This sum can also be explicitly expressed more mathematically by the expression (B.18). For the operator $\mathcal{W}(\mathbf{u}; z_1, \dots, z_n) \equiv \left[\bigotimes_{i=1}^L (\mathbf{u}_i + \hat{D}) \quad w(z_1) \cdots w(z_n) \right]$, it is more complicated to write an explicit expression like (B.18), but it is easy to describe what \hat{D} -diagrams should be summed (this description is convenient for instance in order to write these expressions for arbitrary L on a computer). To compute $\mathcal{W}(\mathbf{u}; z_1, \dots, z_n)$, one should sum all the \hat{D} -diagrams such that :

- All vertical lines are either double lines (associated to $\mathbf{u}_i \mathbb{I}$) or solid lines \mathbb{I}_k for a given value of k .

- The slant lines are solid if they go up to the left, or dashed if they go up to the right. They are associated to a given value of k .
- The permutation¹ σ can be decomposed into “cycles”, which are the minimal subsets of $\llbracket 1, L \rrbracket$ stable under σ . For instance, for two spins ($L = 2$), the identity permutation $\mathbb{1}$ has two cycles (1) and (2), whereas the permutation $\tau_{\llbracket 1, 2 \rrbracket}$ has one single cycle (1, 2).

From the point of view of the Leibniz rule, the cycle (1, 2) arises in (B.26) if the derivative $\hat{D}_{j_2}^{i_2}$ (associated to the second site of the spin chain) acts on a given $w(z_k)$ to give rise to $\left(\frac{g}{1-g} \frac{z_k}{z_k}\right)_{j_2}^{i_2}$, and then the derivative $\hat{D}_{j_1}^{i_1}$ (associated to the first site of the spin chain) acts on this to produce $\left(\frac{1}{1-g} \frac{z_k}{z_k}\right)_{j_1}^{i_2} \left(\frac{g}{1-g} \frac{z_k}{z_k}\right)_{j_2}^{i_1}$, which diagrammatically corresponds to two lines associated to the same value of k . As a consequence, the \hat{D} -diagram  can only arise for $k = k'$.

The generalization of these constraints for an arbitrary number L of spins is that for every cycle, all lines should be associated to the same k , because in the Leibniz rule, they correspond to derivatives acting on the derivative of a single $w(z)$ factor.

The rules above allow to compute explicitly the operator $\mathcal{W}(\mathbf{u}; z_1, \dots, z_n)$, as it can be proven by the same recurrence as in the proof of (B.22). This expression is suitable to analyze its analyticity properties (poles structure), or to do explicit computations on a computer.

Moreover these rules can be generalized to $\left[\bigotimes_{i=1}^L (\mathbf{u}_i + \hat{D}) \quad w(z_1)^{\alpha_1} \dots w(z_n)^{\alpha_n}\right]$. The only difference with the discussion above is that each \hat{D} -diagram is then multiplied by the factor $\prod_{k=1}^n (\alpha_k)^{n_k}$ where n_k is the number of cycles containing lines associated to the label k .

B.2 Identities involving co-derivatives

From the \hat{D} -diagrams introduced above, one can deduce identities such as the identity (II.86), proven in section II.1.4.1.

In the next paragraphs, we will explain how to deduce \mathbf{u} -dependent versions of equations like (II.86), and for that we will also use the following nice consequence of the Leibniz rule (and of the relation² $\hat{D} \det g = \mathbb{1} \det g$) :

$$\left[\hat{D}^{\otimes L} A(g) \det g\right] = \det g \left[\left(1 + \hat{D}\right)^{\otimes L} A(g)\right], \quad (\text{B.27})$$

which holds for an arbitrary function $A(g)$.

¹We remind here that in the case of the expression $\hat{D}^{\otimes L} w(z)$, one single diagram was associated to each permutation (see for instance (B.17)). By contrast, in the present case, several different diagrams may be associated to the same permutation.

²The relation $\hat{D} \det g = \mathbb{1} \det g$ can be proven by the same elementary methods as the equations (B.3 B.8) proven at the beginning of this section.

B.2.1 Yang-Baxter Equation

First, it can be instructing to rewrite the Yang-Baxter equation (II.46) in terms of co-derivatives : indeed, as we saw that the R -matrices can be expressed in terms of co-derivatives, we can expect that the Yang-Baxter identity itself is nothing but an identity on co-derivatives.

The Yang-Baxter equation (II.46) can be rewritten as

$$R_{i,j}(\mathbf{u}_j - \mathbf{u}_i)R_{j,\lambda}(\mathbf{u}_j)R_{i,\lambda}(\mathbf{u}_i) = R_{i,\lambda}(\mathbf{u}_i)R_{j,\lambda}(\mathbf{u}_j)R_{i,j}(\mathbf{u}_j - \mathbf{u}_i), \quad (\text{B.28})$$

or, equivalently³

$$R_{i,j}(\mathbf{u}_j - \mathbf{u}_i)\mathcal{P}_{i,j}R_{i,\lambda}(\mathbf{u}_j)R_{j,\lambda}(\mathbf{u}_i) = R_{i,\lambda}(\mathbf{u}_i)R_{j,\lambda}(\mathbf{u}_j)R_{i,j}(\mathbf{u}_j - \mathbf{u}_i)\mathcal{P}_{i,j}, \quad (\text{B.29})$$

Using the relation (II.61) between co-derivatives and R -operators, this relation becomes (for $j < k$)

$$\begin{aligned} (1 + (\mathbf{u}_k - \mathbf{u}_j)\mathcal{P}_{j,k}) \cdot \left[\bigotimes_{i=1}^L (\mathbf{u}_i + \hat{D}) \chi_\lambda(g) \right] \\ = \left[\bigotimes_{i=1}^L (\mathbf{u}_{\tau_{[j,k]}(i)} + \hat{D}) \chi_\lambda(g) \right] \cdot (1 + (\mathbf{u}_k - \mathbf{u}_j)\mathcal{P}_{j,k}). \end{aligned} \quad (\text{B.30})$$

where the transposition $\tau_{[j,k]} : j \leftrightarrow k$ was defined in (I.3).

As the Yang-Baxter relation (II.46) was proven for an arbitrary representation λ , the relation (B.30) holds for the character $\chi_\lambda(g)$ in an arbitrary representation λ . By linearity,

$$\begin{aligned} (1 + (\mathbf{u}_k - \mathbf{u}_j)\mathcal{P}_{j,k}) \cdot \left[\bigotimes_{i=1}^L (\mathbf{u}_i + \hat{D}) A(g) \right] \\ = \left[\bigotimes_{i=1}^L (\mathbf{u}_{\tau_{[j,k]}(i)} + \hat{D}) A(g) \right] \cdot (1 + (\mathbf{u}_k - \mathbf{u}_j)\mathcal{P}_{j,k}) \end{aligned} \quad (\text{B.31})$$

holds as soon as $A(g)$ is a linear combination of characters. In particular it holds when $A = w(z)$ and even when A is a product of w functions⁴ (like $w(x)w(y)w(z)$). Indeed, it is shown in the main text (see the ‘‘second proof’’ of the main identity on co-derivatives in section II.1.5.2), that this product can be written as a linear combination of the characters associated to different Young diagrams.

Moreover, the relation (B.31) implies for instance

$$\begin{aligned} (1 + (\mathbf{u}_k - \mathbf{u}_j)\mathcal{P}_{j,k}) \cdot \left[\bigotimes_{i=1}^L (\mathbf{u}_i + \hat{D}) A(g) \right] \cdot \left[\bigotimes_{i=1}^L (\mathbf{u}_i + \hat{D}) B(g) \right] = \\ \left[\bigotimes_{i=1}^L (\mathbf{u}_{\tau_{[j,k]}(i)} + \hat{D}) A(g) \right] \cdot \left[\bigotimes_{i=1}^L (\mathbf{u}_{\tau_{[j,k]}(i)} + \hat{D}) B(g) \right] \cdot (1 + (\mathbf{u}_k - \mathbf{u}_j)\mathcal{P}_{j,k}), \end{aligned} \quad (\text{B.32})$$

³The equivalence of these equations relies on the relation $\mathcal{P}_{i,j}\mathcal{P}_{i,\lambda} = \mathcal{P}_{j,\lambda}\mathcal{P}_{i,j}$.

⁴One should remember that $w(z) = \sum_s z^s \chi^{(s)}$ is the generating series of the characters of symmetric representation.

which will be useful to prove the relations of the next section.

B.2.2 Bilinear identities

In order to show how strongly-constrained the internal structure of co-derivatives is, let us prove a nice statement which we will apply to find the bilinear identity (II.95), used to derive the CBR formula in section II.1.4.

Statement 9. *Let us consider a set of $2k$ arbitrary functions $(A_j(g))_{1 \leq j \leq k}$ and $(B_j(g))_{1 \leq j \leq k}$ such that*

$$\forall L \in \mathbb{N}, g \in GL(K), \quad \sum_j \left[\hat{D}^{\otimes L} A_j(g) \right] \cdot \left[\hat{D}^{\otimes L} B_j(g) \right] = 0, \quad (\text{B.33})$$

Then these functions also obey the stronger relation

$$\sum_j \left[\bigotimes_{i=1}^L (\mathbf{u}_i + \hat{D}) A_j(g) \right] \cdot \left[\bigotimes_{i=1}^L (\mathbf{u}_i + \hat{D}) B_j(g) \right] = 0$$

$$\forall L \in \mathbb{N}, (\mathbf{u}_1, \mathbf{u}_2, \dots, \mathbf{u}_L) \in \mathbb{C}^L, g \in GL(K). \quad (\text{B.34})$$

Proof. The quantity $\mathcal{A} \equiv \sum_j \left[\bigotimes_{i=1}^L (\mathbf{u}_i + \hat{D}) A_j(g) \right] \cdot \left[\bigotimes_{i=1}^L (\mathbf{u}_i + \hat{D}) B_j(g) \right]$ is (by hypothesis) equal to zero if $\mathbf{u}_1 = \mathbf{u}_2 = \dots = \mathbf{u}_L = \mathbf{0}$. A first step is to prove that it is still equal to zero if $\mathbf{u}_1 = \mathbf{u}_2 = \dots = \mathbf{u}_{L-1} = \mathbf{0}$ with $\mathbf{u}_L \neq \mathbf{0}$. In that case we can expand \mathcal{A} with respect to \mathbf{u}_L and we see that the coefficient of degree two in \mathbf{u}_L is equal to $\sum_j \left[\hat{D}^{\otimes L-1} \otimes \mathbb{I} A_j(g) \right] \cdot \left[\hat{D}^{\otimes L-1} \otimes \mathbb{I} B_j(g) \right]$, which is equal to zero by hypothesis (see (B.33)). To show that the term of degree one in \mathbf{u}_L is also equal to zero, we can use the Yang-Baxter equation (B.32) to write

$$\sum_j (1 + \mathbf{u} \mathcal{P}_{L-1,L}) \cdot \left[\hat{D}^{\otimes L-1} \otimes (\mathbf{u} + \hat{D}) A_j(g) \right] \cdot \left[\hat{D}^{\otimes L-1} \otimes (\mathbf{u} + \hat{D}) B_j(g) \right]$$

$$- \sum_j \left[\hat{D}^{\otimes L-2} \otimes (\mathbf{u} + \hat{D}) \otimes \hat{D} A_j(g) \right] \cdot \left[\hat{D}^{\otimes L-2} \otimes (\mathbf{u} + \hat{D}) \otimes \hat{D} B_j(g) \right] \cdot (1 + \mathbf{u} \mathcal{P}_{L-1,L})$$

$$= 0. \quad (\text{B.35})$$

Then, the coefficient of the term of degree one \mathbf{u} (in (B.35)) contains the following terms :

- The terms where \mathbf{u} is kept in $(1 + \mathbf{u} \mathcal{P}_{L-1,L})$ (and set to zero in the other factors) is equal to

$$\mathcal{P}_{L-1,L} \cdot \sum_j \left[\hat{D}^{\otimes L} A_j(g) \right] \cdot \left[\hat{D}^{\otimes L} B_j(g) \right] - \sum_j \left[\hat{D}^{\otimes L} A_j(g) \right] \cdot \left[\hat{D}^{\otimes L} B_j(g) \right] \cdot \mathcal{P}_{L-1,L},$$

$$(\text{B.36})$$

which is equal to zero by hypothesis (see (B.33)).

- The other terms in the first line are exactly the coefficient of \mathcal{A} with degree one in \mathbf{u}_L (and degree zero in $\mathbf{u}_1, \mathbf{u}_2, \dots$ and \mathbf{u}_{L-1}).

- The other terms in the second line are exactly the coefficient of \mathcal{A} with degree one in \mathbf{u}_{L-1} (and degree zero in the other variables \mathbf{u}_i).

Therefore, in order to prove that the coefficient of \mathcal{A} with degree one in \mathbf{u}_L (and degree zero in the other variables \mathbf{u}_i) vanishes, it is sufficient to prove that the coefficient of \mathcal{A} with degree one in \mathbf{u}_{L-1} vanishes. By iterating this argument, we simply have to prove that the coefficient of \mathcal{A} with degree one in \mathbf{u}_1 (and degree zero in the other variables \mathbf{u}_i) is equal to zero. But this coefficient is equal to

$$\begin{aligned} \sum_j \left[\hat{D}^{\otimes L} A_j(g) \right] \cdot \left[\mathbb{I} \otimes \hat{D}^{\otimes L-1} B_j(g) \right] + \sum_j \left[\mathbb{I} \otimes \hat{D}^{\otimes L-1} A_j(g) \right] \cdot \left[\hat{D}^{\otimes L} B_j(g) \right] \\ = \hat{D} \otimes \sum_j \left[\hat{D}^{\otimes L-1} A_j(g) \right] \cdot \left[\hat{D}^{\otimes L-1} B_j(g) \right], \quad (\text{B.37}) \end{aligned}$$

where the right-hand-side is equal to zero (see (B.33)), and is equal to the left-hand-side due to the Leibniz rule (II.59). This concludes the proof that \mathcal{A} is equal to zero when $\mathbf{u}_1 = \mathbf{u}_2 = \dots = \mathbf{u}_{L-1} = 0$, even with $\mathbf{u}_L \neq 0$.

Next, one can easily see that this first result allows to show that \mathcal{A} is equal to zero when $\mathbf{u}_1 = \mathbf{u}_2 = \dots = \mathbf{u}_{L-2} = 0$. Indeed, if we expand it with respect to \mathbf{u}_{L-1} , then the coefficient of degree two (in \mathbf{u}_{L-1}) corresponds to the identity (B.34) for a chain of length $L - 1$ where all the variables \mathbf{u}_i are equal to zero except the last one (hence this coefficient is equal to zero as we have just shown). The term of degree one in \mathbf{u}_{L-1} is also equal to zero, as it can be shown by repeating the arguments above⁵.

Repeating this argument allows to show that (B.34) still holds if we only assume that $\mathbf{u}_1 = \mathbf{u}_2 = \dots = \mathbf{u}_{L-3} = 0$, and by iterations, it holds for arbitrary $(\mathbf{u}_1, \mathbf{u}_2, \dots, \mathbf{u}_L) \in \mathbb{C}^L$. \square

This property is very interesting because we have seen in section II.1.4.1 that the formula (II.86) holds when $L \geq 1$. This statement can be rewritten as :

$$\begin{aligned} \forall L \geq 0, \quad \left[\hat{D}^{\otimes L} z w(z) \det g \right] \cdot \left[\hat{D}^{\otimes L} w(y) \right] \\ - \left[\hat{D}^{\otimes L} w(z) \right] \cdot \left[\hat{D}^{\otimes L} y w(y) \det g \right] \\ - \left[\hat{D}^{\otimes L} ((z - y) w(z) w(y) \det g) \right] \cdot \left[\hat{D}^{\otimes L} 1 \right] = 0, \quad (\text{B.39}) \end{aligned}$$

⁵ More precisely, one has to write the Yang-Baxter equation

$$\begin{aligned} \sum_j (1 + \mathbf{u} \mathcal{P}_{L-2, L-1}) \cdot \left[\hat{D}^{\otimes L-2} \otimes (\mathbf{u} + \hat{D}) \otimes (\mathbf{u}_L + \hat{D}) A_j(g) \right] \cdot \left[\hat{D}^{\otimes L-2} \otimes (\mathbf{u} + \hat{D}) \otimes (\mathbf{u}_L + \hat{D}) B_j(g) \right] \\ - \sum_j \left[\hat{D}^{\otimes L-3} \otimes (\mathbf{u} + \hat{D}) \otimes \hat{D}^{\otimes 2} A_j(g) \right] \cdot \left[\hat{D}^{\otimes L-3} \otimes (\mathbf{u} + \hat{D}) \otimes \hat{D}^{\otimes 2} B_j(g) \right] \cdot (1 + \mathbf{u} \mathcal{P}_{L-2, L-1}) \\ = 0. \quad (\text{B.38}) \end{aligned}$$

and to keep only the terms of degree one in \mathbf{u} . Exactly like in (B.36), the terms containing the permutation $\mathcal{P}_{L-2, L-1}$ vanish, and by iterations the problem is reduced to showing that the coefficient of \mathcal{A} with degree one in \mathbf{u}_1 (and degree zero in the variables \mathbf{u}_i when $1 < i < L$) vanishes. Then one sees that this coefficient is zero by using the Leibniz rule, exactly like in (B.37).

which is exactly of the form (B.33). The first two terms of this relation are exactly the terms of equation (II.86), up to the rewriting (B.27). It was also necessary to add a third term, involving $\left[\hat{D}^{\otimes L} \ 1\right]$ which is zero if $L \geq 1$. If $L = 0$, the factor $\left[\hat{D}^{\otimes L} ((z - y)w(z)w(y) \det g)\right]$ is fitted so that the identity (B.39) is true even when $L = 0$. This condition is important to initialize the recurrence proving the property (B.34).

Then the property (B.34) allows to conclude that for arbitrary u_i 's,

$$\begin{aligned} \forall L \geq 0, \quad z \left[\bigotimes_{i=1}^L (u_i + 1 + \hat{D}) \quad w(z) \right] &\cdot \left[\bigotimes_{i=1}^L (u_i + \hat{D}) \quad w(y) \right] \\ &= y \left[\bigotimes_{i=1}^L (u_i + \hat{D}) \quad w(z) \right] \cdot \left[\bigotimes_{i=1}^L (u_i + 1 + \hat{D}) \quad w(y) \right] \\ &\quad + (z - y) \left[\bigotimes_{i=1}^L (u_i + 1 + \hat{D}) \quad w(z)w(y) \right] \cdot \left[\prod_{i=1}^L u_i \right]. \end{aligned} \quad (\text{B.40})$$

This equation is an important step to derive the CBR formula in section II.1.4.

B.3 Co-derivatives and eigenvalues

In this appendix, we will prove the equivalence between the definitions (II.219) and (II.223). This equivalence means that one can freely move a factor $1 - z x_j$ from the left of $\bigotimes_{i=1}^L (u_i + \hat{D})$ to its right. Of course, such a result would not be expected in general, and it holds only because in these definitions, there is a prefactor $(1 - g t)^{\otimes L}$. Indeed, some eigenvalues of this prefactor are zero when $t \rightarrow 1/x_j$, which makes a few terms vanish.

To do this, the first question which arises is actually “what is the definition of $\hat{D}x_j$?”. In order to use the definition (II.53) of \hat{D} , x_j should be defined as a function of g , which can be computed at the point $e^{\phi \cdot e} g$. The most natural definition is based on the fact that x_j is the j^{th} eigenvalue of g , or in other words the j^{th} root of its characteristic polynomial. In this sense, x_j is a function of the group element g : $x_j = x_j(g)$. In particular, $x_j(\Omega g \Omega^{-1}) = x_j(g)$ for any similarity transformation.

With this definition, we can now show that

$$\hat{D} x_j = P_j x_j \quad (\text{B.41})$$

where P_j denotes the projector into the eigenspace of g associated to the eigenvalue x_j .

Proof. If g is a diagonal matrix, the contribution of the non-diagonal-elements of the matrix $e^{(\phi, e)} g$ to the characteristic polynomial $\det(\lambda \mathbb{I} - e^{(\phi, e)} g)$ is at least quadratic in ϕ . This means that at the point $e^{(\phi, e)} g$, x_j is equal to $(e^{(\phi, e)} g)_j^j$ to the first order in ϕ . As a consequence, we get $\hat{D}_{j_1}^{i_1} x_j = \hat{D}_{j_1}^{i_1} g_j^j = \delta_j^{i_1} \delta_{i_1}^j x_j$, so that $\hat{D} x_j = P_j x_j$, where the projector to the eigenspace for the j -th eigenvalue x_j is $P_j = e_{jj}$ in this case.

More generally, if $g = \Omega^{-1}\tilde{g}\Omega$ where \tilde{g} is diagonal and Ω is an arbitrary similarity transformation, then we obtain

$$\begin{aligned}\hat{D} x_j &= \frac{\partial}{\partial\phi} x_j (e^{\langle\phi,e\rangle}\Omega^{-1}\tilde{g}\Omega)|_{\phi=0} = \frac{\partial}{\partial\phi} (\Omega e^{\langle\phi,e\rangle}\Omega^{-1}\tilde{g})^j_j|_{\phi=0} \\ &= \sum_{i_1,j_1} e_{i_1j_1}\Omega_{j_1}^j(\Omega^{-1})^{i_1}_j x_j = \sum_{i_1,j_1} e_{i_1j_1}(\Omega^{-1}e_{jj}\Omega)^{i_1}_{j_1}x_j.\end{aligned}\tag{B.42}$$

This exactly means that for a non-diagonal matrix g , $\hat{D} x_j = P_j x_j$, where the projector to the eigenspace for x_j has the form $P_j = \Omega^{-1}e_{jj}\Omega$. \square

Now that we have defined $\hat{D} x_j$, we can investigate the equivalence between the definitions (II.219) and (II.223). We can start with the $L = 1$ case, where we easily show how to commute x_j through the co-derivative :

$$\begin{aligned}\lim_{t \rightarrow \frac{1}{x_j}} (1 - gt) \langle (\mathbf{u} + \hat{D}), x_j \mathbb{I} \rangle_- &= \left(1 - \frac{g}{x_j}\right) \cdot [\hat{D} x_j] \\ &= \left(1 - \frac{g}{x_j}\right) x_j P_j = 0,\end{aligned}\tag{B.43}$$

where we see that a key point is the multiplication by $\lim_{t \rightarrow \frac{1}{x_j}} (1 - gt) = (1 - g/x_j)$, which makes the $\hat{D} x_j = x_j P_j$ vanish, due to the property $(1 - g/x_j) P_j = 0$.

For larger values of L , we have to prove that

$$\begin{aligned}C_{m,L} &= 0, \quad \text{where } C_{m,L} \equiv (1 - g/x_j)^{\otimes(L)} B_{m,L}, \\ B_{m,L} &\equiv \left(\bigotimes_{i=1}^m (\mathbf{u}_i + \hat{D})\right) \otimes \langle \mathbf{u}_{m+1} + \hat{D}, x_j \mathbb{I} \rangle_- \otimes \left(\bigotimes_{i=m+2}^L (\mathbf{u}_i + \hat{D})\right),\end{aligned}\tag{B.44}$$

where $0 \leq m \leq L - 1$. This statement (B.44) is exactly the statement that x_j can be commuted through the co-derivatives, to give the equivalence of (II.219) and (II.223). We will prove it by recurrence over m , keeping $L - m$ constant:

Proof of (B.44). For $m = 0$, (B.44) follows from (B.43). Let us show how $C_{m+1,L+1}$ vanishes under the assumption that $C_{m,L} = 0$ for all $g \in GL(K)$ and any $\{\mathbf{u}_i\} \in \mathbb{C}^L$. Then for any $\mathbf{u}_0 \in \mathbb{C}$, one can calculate:

$$\begin{aligned}0 &= ((1 - g/x_j) \otimes \mathbb{I}^{\otimes(L)}) \cdot ((\mathbf{u}_0 + \hat{D}) \otimes C_{m,L}) \\ &= C'_{m+1,L+1} + ((1 - g/x_j) \otimes \mathbb{I}^{\otimes(L)}) \cdot [\hat{D} \otimes (1 - g/x_j)^{\otimes(L)}] \cdot (\mathbb{I} \otimes B_{m,L}),\end{aligned}\tag{B.45}$$

$$\text{where } C'_{m+1,L+1} \equiv (1 - g/x_j)^{\otimes(L+1)} B'_{m+1,L+1},\tag{B.46}$$

$$B'_{m+1,L+1} \equiv \left(\bigotimes_{i=0}^m (\mathbf{u}_i + \hat{D})\right) \otimes \langle \mathbf{u}_{m+1} + \hat{D}, x_j \mathbb{I} \rangle_- \otimes \left(\bigotimes_{i=m+2}^L (\mathbf{u}_i + \hat{D})\right).\tag{B.47}$$

This expression (B.45) is obtained by computing $(\mathbf{u}_0 + \hat{D}) \otimes C_{m,L}$ using the Leibniz rule : $\hat{D} \otimes \left((1 - g/x_j)^{\otimes L} \cdot B_{m,L} \right) = \left[\hat{D} \otimes (1 - g/x_j)^{\otimes L} \right] \cdot (\mathbb{I} \otimes B_{m,L}) + \left(\mathbb{I} \otimes (1 - g/x_j)^{\otimes L} \right) \cdot \left[\hat{D} \otimes B_{m,L} \right]$.

Using the relation $\hat{D} \otimes g/x_j = \mathcal{P}_{1,2} \cdot (1 \otimes g/x_j) - P_j \otimes g/x_j$, the second term in (B.45) can be expanded to get

$$0 = C'_{m+1,L+1} + \sum_{k=1}^{m+1} (1 - g/x_j)_{0,\dots,k-1} \cdot \mathcal{P}_{0,k} \cdot \left(\frac{g}{x_j} \right)_k \cdot (1 - g/x_j)_{k+1,\dots,L} \cdot (\mathbb{I} \otimes B_{m,L}) - \sum_{k=1}^{m+1} (1 - g/x_j)_{0,\dots,k-1} \cdot \left(P_j \frac{g}{x_j} \right)_k \cdot (1 - g/x_j)_{k+1,\dots,L} \cdot (\mathbb{I} \otimes B_{m,L}) \quad (\text{B.48})$$

$$\text{where} \quad \left(P_j \frac{g}{x_j} \right)_k \equiv \mathbb{I}^{\otimes k} \otimes \left(P_j \frac{g}{x_j} \right) \otimes \mathbb{I}^{\otimes L-k}, \quad (\text{B.49})$$

$$\left(\frac{g}{x_j} \right)_k \equiv \mathbb{I}^{\otimes k} \otimes \frac{g}{x_j} \otimes \mathbb{I}^{\otimes L-k}, \quad (1 - g/x_j)_{a,\dots,b} \equiv \prod_{k=a}^b \left(\mathbb{I} - \left(\frac{g}{x_j} \right)_k \right). \quad (\text{B.50})$$

By commuting $\mathcal{P}_{0,k}$ to the left of the other terms, the first sum of (B.48) can be written $\sum_{k=1}^{m+1} \mathcal{P}_{0,k} \cdot \left(\frac{g}{x_j} \right)_k \cdot \mathbb{I} \otimes \left((1 - g/x_j)^{\otimes L} \cdot B_{m,L} \right)$, which is zero because it contains $C_{m,L}$. The second term is also zero because it contains $(1 - g/x_j)P_j$.

This completes the proof of the fact that $C'_{m+1,L+1} = 0$, from which $C_{m+1,L+1} = 0$ follows. \square

As a consequence, we can indeed commute the factor $1 - x_j z$ to the right of all co-derivatives in (II.219) to get (II.223).

Index

- * (convolution), 99
- $f^\pm \equiv f(u \pm \frac{i}{2})$, 104
- $f^{[+n]} \equiv f(u + n\frac{i}{2})$, 105
- $\overline{F} \equiv u \mapsto \overline{F}(\overline{u})$, 149
- $\overline{\emptyset} \equiv \llbracket 1, K + M \rrbracket$, 54, 56, 68
- $\llbracket n_1, n_2 \rrbracket \equiv [n_1, n_2] \cap \mathbb{Z}$, 11
- $(A, B)_\pm \equiv A \cdot B \pm B \cdot A$, 26
- \simeq , 139
- A_a , 142
- \mathcal{A}_n^m , 143
- \mathcal{A}_n , 146
- asymptotic limit ($L \rightarrow \infty$), 90
- Bazhanov-Reshetikhin, *see* CBR
- Bethe ansatz, 11–21
- Bethe equations, 15, 94
- Bethe equations, 61–67
- Bethe roots, 62, 93, 174
- CBR formula, 40, 75
- Cherednik-Bazhanov-Reshetikhin, *see* CBR
- $\chi^{(s)} \equiv \chi^{(1,s)}$, 43
- \hat{D} -diagrams, 42
- $\epsilon(\sigma)$ (signature of a permutation), 14
- $\epsilon(I, \overline{I})$, 117
- e^{∂_a} , 59
- exterior forms, 120
 - (n)-form, 120
- FiNLIE, 89, 131
- gauge transformation, 105
- Generators (of a matrix group), 223
 - of $GL(K)$, 230
 - of $SU(2)$, 223
- $GL(K|M)$, 233
- Hirota equation, 45, 53, 76, 104
- $i \equiv \sqrt{-1}$, 12, 24
- $\overline{I} \equiv \llbracket 1, K + M \rrbracket \setminus I$, 54, 56
- $\overline{j} \equiv \llbracket 1, K + M \rrbracket \setminus \{j\}$, 68
- $\mathbb{L}(K, M)$, 39
- $M(K)$: $K \times K$ matrices, 34
- Magnon, 12
- momentum number, 162, 165
- $\mathbb{N} = \{0, 1, 2, \dots\}$, 35
- Nesting
 - nesting level, 54, 56
 - nesting path, 54
- \mathcal{P} (permutation operator), 11, 24, 223
 - generalized permutation, 236
- Q -functions, 53, 58, 93, 116
 - QQ-relations, 60–61, 119, 121, 126, 182
- Q -operators, 53, 68, 72
 - QQ-relations, 76
- Representation, 222–236
 - character, 222, 232
 - irreducible, 226
 - of $GL(K)$, 225
 - of $SU(2)$, 223
- \mathcal{S} (symmetric group), 13, 223, 240
- Schur polynomials, 233
- sector
 - $SL(2)$ sector, 175
 - $U(1)$ sector, 151
- sheet (Riemann sheet)
 - magic sheet, 172
- strip

- physical strip, 92
- Supergroups
 - $GL(K|M)$, 233
- T -functions, 53, 104
 - TQ-relation, 58
- T-operators, 23–33, 72
 - TQ-relation, 68, 73
- $\tau_{[i,j]}$ (transposition), 11
- θ_i (inhomogeneities), 31, 40
- Typical (solution), 47, 112
- u (rapidity), 90
 - $u^{(m,n)}$, *see* Bethe roots
- u (spectral parameter), 28
 - u_i , 33, 40
 - $u_I^{(n)}$, *see* Bethe roots
- x_j (eigenvalue of the twist), 52
- Y-functions, 101
- Young diagrams, 225
- Young tableaux, 225
- Zhukovsky cuts
 - \widehat{Z}_n , 177
 - \check{Z}_n , 172, 176

Bibliography

Articles written during This PhD

Not yet published in a peer-reviewed journal

- [11AKL⁺] Alexander Alexandrov, Vladimir Kazakov, Sébastien Leurent, Zengo Tsuboi, and Anton Zabrodin. “Classical tau-function for quantum spin chains”. 2011. [arXiv : 1112.3310](#).
- [10KL] V. Kazakov and S. Leurent. “Finite Size Spectrum of SU(N) Principal Chiral Field from Discrete Hirota Dynamics”. July 2010. [arXiv : 1007.1770](#).

Accepted for publication

- [11GKLV] Nikolay Gromov, Vladimir Kazakov, Sébastien Leurent, and Dmytro Volin. “Solving the AdS/CFT Y-system”. 2011. [arXiv : 1110.0562](#).

Published

- [11GKLT] Nikolay Gromov, Vladimir Kazakov, Sébastien Leurent, and Zengo Tsuboi. “Wronskian Solution for AdS/CFT Y-system”. *JHEP* , 1101:155, 2011. [arXiv : 1010.2720](#).
- [12KLT] Vladimir Kazakov, Sébastien Leurent, and Zengo Tsuboi. “baxter’s q-operators and operatorial bäcklund flow for quantum (super)-spin chains”. *Communications in Mathematical Physics* , 311:787–814, 2012. [arXiv : 1010.4022](#).

General references

- [AF07] Gleb Arutyunov and Sergey Frolov. “On String S-matrix, Bound States and TBA”. *JHEP*, 0712:024, 2007. [arXiv: 0710.1568](#).
- [AF09] Gleb Arutyunov and Sergey Frolov. “Thermodynamic Bethe Ansatz for the AdS(5) x S(5) Mirror Model”. *JHEP*, 0905:068, 2009. [arXiv: 0903.0141](#).
- [AFRT03] G. Arutyunov, S. Frolov, J. Russo, and Arkady A. Tseytlin. “Spinning strings in AdS(5) x S**5 and integrable systems”. *Nucl.Phys.*, B671:3–50, 2003. [arXiv: hep-th/0307191](#).
- [AFS04] Gleb Arutyunov, Sergey Frolov, and Matthias Staudacher. “Bethe ansatz for quantum strings”. *JHEP*, 0410:016, 2004. [arXiv: hep-th/0406256](#).
- [AFS10] Gleb Arutyunov, Sergey Frolov, and Ryo Suzuki. “Five-loop Konishi from the Mirror TBA”. *JHEP*, 1004:069, 2010. [arXiv: 1002.1711](#).
- [ART04] G. Arutyunov, J. Russo, and Arkady A. Tseytlin. “Spinning strings in AdS(5) x S**5: New integrable system relations”. *Phys.Rev.*, D69:086009, 2004. [arXiv: hep-th/0311004](#).
- [BAA⁺12] Niklas Beisert, Changrim Ahn, Luis F. Alday, Zoltan Bajnok, James M. Drummond, et al. “Review of AdS/CFT Integrability: An Overview”. *Lett. Math. Phys.*, 99:3–32, 2012. [arXiv: 1012.3982](#).
- [Bax72] Rodney J. Baxter. “Partition function of the eight vertex lattice model”. *Annals Phys.*, 70:193–228, 1972.
- [BBB81] A. Baha Balantekin and Itzhak Bars. “Dimension and Character Formulas for Lie Supergroups”. *J.Math.Phys.*, 22:1149, 1981.
- [BCFH92] P.-A. Bares, J. M. P. Carmelo, J. Ferrer, and P. Horsch. “Charge-spin recombination in the one-dimensional supersymmetric t-J model”. *Phys. Rev. B*, 46:14624–14654, December 1992.
- [BDKM07] A. V. Belitsky, S. É. Derkachov, G. P. Korchemsky, and A. N. Manashov. “The Baxter Q-operator for the graded $SL(2|1)$ spin chain”. *Journal of Statistical Mechanics: Theory and Experiment*, 1:5, January 2007. [arXiv: hep-th/0610332](#).
- [BDS04] N. Beisert, V. Dippel, and M. Staudacher. “A Novel long range spin chain and planar N=4 super Yang-Mills”. *JHEP*, 0407:075, 2004. [arXiv: hep-th/0405001](#).
- [BdVV82] O. Babelon, H.J. de Vega, and C.M. Viallet. “Exact solution of the $Z_{n+1} \times Z_{n+1}$ symmetric generalization of the XXZ model”. *Nucl.Phys.*, B200:266, 1982.

- [Bei08] Niklas Beisert. “The $SU(2|2)$ dynamic S-matrix”. *Adv.Theor.Math.Phys.* , 12:945, 2008. arXiv : hep-th/0511082.
- [Bet31] H. Bethe. “zur theorie der metalle”. *Zeitschrift für Physik A Hadrons and Nuclei* , 71:205–226, 1931.
- [BFL⁺11] V. V. Bazhanov, R. Frassek, T. Łukowski, C. Meneghelli, and M. Staudacher. “Baxter Q-operators and representations of Yangians”. *Nuclear Physics B* , 850:148–174, September 2011. arXiv : 1010.3699.
- [BFST03] N. Beisert, S. Frolov, M. Staudacher, and Arkady A. Tseytlin. “Precision spectroscopy of AdS / CFT”. *JHEP* , 0310:037, 2003. arXiv : hep-th/0308117.
- [BFT09] D. Bombardelli, D. Fioravanti, and R. Tateo. “Thermodynamic Bethe ansatz for planar AdS/CFT: a proposal”. *Journal of Physics A Mathematical General* , 42:K5401, September 2009. arXiv : 0902.3930.
- [BGK⁺10] H. Boos, F. Göhmann, A. Klümper, K. S. Nirov, and A. V. Razumov. “Exercises with the universal R-matrix”. *Journal of Physics A Mathematical General* , 43:5208, October 2010. arXiv : 1004.5342.
- [BH10] Janos Balog and Arpad Hegedus. “5-loop Konishi from linearized TBA and the XXX magnet”. *JHEP* , 1006:080, 2010. arXiv : 1002.4142.
- [BH11a] Janos Balog and Arpad Hegedus. “ $AdS_5 \times S^5$ mirror TBA equations from Y-system and discontinuity relations”. *JHEP* , 1108:095, 2011. arXiv : 1104.4054.
- [BH11b] Janos Balog and Arpad Hegedus. “Quasi-local formulation of the mirror TBA”. 2011. arXiv : 1106.2100.
- [BHK02a] V. V. Bazhanov, A. N. Hibberd, and S. M. Khoroshkin. “Integrable structure of W_3 Conformal Field Theory, Quantum Boussinesq Theory and Boundary Affine Toda Theory”. *Nuclear Physics B* , 622:475–547, February 2002. arXiv : hep-th/0105177.
- [BHK02b] Vladimir V. Bazhanov, Anthony N. Hibberd, and Sergey M. Khoroshkin. “Integrable structure of $W(3)$ conformal field theory, quantum Boussinesq theory and boundary affine Toda theory”. *Nucl.Phys.* , B622:475–547, 2002. arXiv : hep-th/0105177.
- [BJ09] Zoltan Bajnok and Romuald A. Janik. “Four-loop perturbative Konishi from strings and finite size effects for multiparticle states”. *Nucl.Phys.* , B807:625–650, 2009. arXiv : 0807.0399.
- [BJM⁺07] H. Boos, M. Jimbo, T. Miwa, F. Smirnov, and Y. Takeyama. “Hidden Grassmann Structure in the XXZ Model”. *Communications in Mathematical Physics* , 272:263–281, May 2007. arXiv : hep-th/0606280.

- [BKS03] N. Beisert, C. Kristjansen, and M. Staudacher. “The Dilatation operator of conformal $N=4$ superYang-Mills theory”. *Nucl.Phys.* , B664:131–184, 2003. arXiv : hep-th/0303060.
- [BKSZ06] N. Beisert, V. A. Kazakov, K. Sakai, and K. Zarembo. “The algebraic curve of classical superstrings on $AdS(5) \times S^{*5}$ ”. *Commun. Math. Phys.* , 263:659–710, 2006. arXiv : hep-th/0502226.
- [BLMS10] V. V. Bazhanov, T. Łukowski, C. Meneghelli, and M. Staudacher. “A shortcut to the Q-operator”. *Journal of Statistical Mechanics: Theory and Experiment* , 11:2, November 2010. arXiv : 1005.3261.
- [BLZ97a] V. V. Bazhanov, S. L. Lukyanov, and A. B. Zamolodchikov. “Integrable Structure of Conformal Field Theory II. Q-operator and DDV equation”. *Communications in Mathematical Physics* , 190:247–278, 1997. arXiv : hep-th/9604044.
- [BLZ97b] Vladimir V. Bazhanov, Sergei L. Lukyanov, and Alexander B. Zamolodchikov. “Integrable quantum field theories in finite volume: Excited state energies”. *Nucl.Phys.* , B489:487–531, 1997. arXiv : hep-th/9607099.
- [BLZ99] V. V. Bazhanov, S. L. Lukyanov, and A. B. Zamolodchikov. “Integrable Structure of Conformal Field Theory III. The Yang-Baxter Relation”. *Communications in Mathematical Physics* , 200:297–324, 1999. arXiv : hep-th/9805008.
- [BMSZ03] N. Beisert, J.A. Minahan, M. Staudacher, and K. Zarembo. “Stringing spins and spinning strings”. *JHEP* , 0309:010, 2003. arXiv : hep-th/0306139.
- [BPR04] Iosif Bena, Joseph Polchinski, and Radu Roiban. “Hidden symmetries of the $AdS(5) \times S^{*5}$ superstring”. *Phys.Rev.* , D69:046002, 2004. arXiv : hep-th/0305116.
- [BR90] V. V. Bazhanov and N. Reshetikhin. “Restricted solid-on-solid models connected with simply laced algebras and conformal field theory”. *Journal of Physics A Mathematical General* , 23:1477–1492, May 1990.
- [BS03] Niklas Beisert and Matthias Staudacher. “The $N=4$ SYM integrable super spin chain”. *Nucl.Phys.* , B670:439–463, 2003. arXiv : hep-th/0307042.
- [BS05] Niklas Beisert and Matthias Staudacher. “Long-range $psu(2,2|4)$ Bethe Ansatz for gauge theory and strings”. *Nucl.Phys.* , B727:1–62, 2005. arXiv : hep-th/0504190.
- [BT06] A. G. Bytsko and J. Teschner. “Quantization of models with non-compact quantum group symmetry: modular XXZ magnet and lattice sinh-Gordon model”. *Journal of Physics A Mathematical General* , 39:11, October 2006. arXiv : hep-th/0602093.

- [BT08] V. V. Bazhanov and Z. Tsuboi. “Baxter’s Q-operators for supersymmetric spin chains”. *Nuclear Physics B* , 805:451–516, December 2008. [arXiv : 0805.4274](#).
- [Cae10] Joao Caetano. “Unified approach to the SU(2) Principal Chiral Field model at Finite Volume”. 2010. [arXiv : 1012.2600](#).
- [CFT11] Andrea Cavaglia, Davide Fioravanti, and Roberto Tateo. “Extended Y-system for the AdS_5/CFT_4 correspondence”. *Nucl. Phys.* , B843:302–343, 2011. [arXiv : 1005.3016](#).
- [Che86] I. V. Cherednik. “special bases of irreducible representations of a degenerate affine hecke algebra”. *Functional Analysis and Its Applications* , 20:76–78, 1986.
- [DDM⁺07] Patrick Dorey, Clare Dunning, Davide Masoero, Junji Suzuki, and Roberto Tateo. “Pseudo-differential equations, and the Bethe ansatz for the classical Lie algebras”. *Nucl.Phys.* , B772:249–289, 2007. [arXiv : hep-th/0612298](#).
- [DdV87] C. Destri and H. J. de Vega. “Light cone lattice approach to fermionic theories in 2-d: the massive Thirring model”. *Nucl. Phys.* , B290:363, 1987.
- [DM92] Tetsuo Deguchi and Paul P. Martin. “An Algebraic approach to vortex models and transfer matrix spectra”. *Int.J.Mod.Phys.* , A7S1A:165–196, 1992.
- [DM06] Sergey E. Derkachov and Alexander N. Manashov. “R-matrix and baxter Q-operators for the noncompact SL(N,C) invariant spin chain”. *SIGMA* , 2:084, 2006. [arXiv : nlin/0612003](#).
- [DM09] S. É. Derkachov and A. N. Manashov. “Factorization of $mathcal{R}$ -matrix and Baxter $mathcal{R}$ -operators for generic $sl(N)$ spin chains”. *Journal of Physics A Mathematical General* , 42(7):075204, February 2009. [arXiv : 0809.2050](#).
- [DM11] Sergey E. Derkachov and Alexander N. Manashov. “Noncompact $sl(N)$ spin chains: BGG-resolution, Q-operators and alternating sum representation for finite dimensional transfer matrices”. *Lett.Math.Phys.* , 97:185–202, 2011. [arXiv : 1008.4734](#).
- [DMKM88] BA Dubrovin, TM Malanyuk, IM Krichever, and VG Makhankov. “Exact solutions of the time-dependent Schrödinger equation with self-consistent potentials”. *Soviet J. Particles and Nuclei*, 19(3):252–269, 1988.
- [DT96] Patrick Dorey and Roberto Tateo. “Excited states by analytic continuation of TBA equations”. *Nucl.Phys.* , B482:639–659, 1996. [arXiv : hep-th/9607167](#).

- [DT99] Patrick Dorey and Roberto Tateo. “Anharmonic oscillators, the thermodynamic Bethe ansatz, and nonlinear integral equations”. *J.Phys.A* , A32:L419–L425, 1999. arXiv : hep-th/9812211.
- [Fad96] L. D. Faddeev. “How Algebraic Bethe Ansatz works for integrable model”. 1996. arXiv : hep-th/9605187.
- [FH91] William Fulton and Joe Harris. *Representation Theory*, volume 129 of *Grad. Texts Math.* Springer-Verlag, New York, 1991.
- [FK95] L.D. Faddeev and G.P. Korchemsky. “High-energy QCD as a completely integrable model”. *Phys.Lett.* , B342:311–322, 1995. arXiv : hep-th/9404173.
- [FŁMS11a] R. Frassek, T. Łukowski, C. Meneghelli, and M. Staudacher. “Baxter Operators and Hamiltonians for ”nearly all” Integrable Closed $gl(n)$ Spin Chains”. December 2011. arXiv : 1112.3600.
- [FŁMS11b] R. Frassek, T. Łukowski, C. Meneghelli, and M. Staudacher. “Oscillator construction of $su(n|m)$ Q-operators”. *Nuclear Physics B* , 850:175–198, September 2011. arXiv : 1012.6021.
- [FM03] K. Fabricius and B. M. McCoy. “New Developments in the Eight Vertex Model”. *Journal of Statistical Physics* , 111:323–337, 2003. arXiv : 0207177.
- [Fro11] Sergey Frolov. “Konishi operator at intermediate coupling”. *J.Phys.A* , A44:065401, 2011. arXiv : 1006.5032.
- [FSSZ08] F. Fiamberti, A. Santambrogio, C. Sieg, and D. Zanon. “Finite-size effects in the superconformal beta-deformed $N=4$ SYM”. *JHEP* , 0808:057, 2008. arXiv : 0806.2103.
- [FT02] S. Frolov and Arkady A. Tseytlin. “Semiclassical quantization of rotating superstring in $AdS(5) \times S^{*5}$ ”. *JHEP* , 0206:007, 2002. arXiv : hep-th/0204226.
- [FT03] S. Frolov and Arkady A. Tseytlin. “Multispin string solutions in $AdS(5) \times S^{*5}$ ”. *Nucl.Phys.* , B668:77–110, 2003. arXiv : hep-th/0304255.
- [GK12] Nikolay Gromov and Vladimir Kazakov. “Review of AdS/CFT Integrability, Chapter III.7: Hirota Dynamics for Quantum Integrability”. *Lett.Math.Phys.* , 99:321–347, 2012. arXiv : 1012.3996.
- [GKKV10] Nikolay Gromov, Vladimir Kazakov, Andrii Kozak, and Pedro Vieira. “Exact Spectrum of Anomalous Dimensions of Planar $N = 4$ Supersymmetric Yang-Mills Theory: TBA and excited states”. *Lett.Math.Phys.* , 91:265–287, 2010. arXiv : 0902.4458.

- [GKP98] S.S. Gubser, Igor R. Klebanov, and Alexander M. Polyakov. “Gauge theory correlators from noncritical string theory”. *Phys.Lett.* , B428:105–114, 1998. arXiv : hep-th/9802109.
- [GKP02] S.S. Gubser, I.R. Klebanov, and Alexander M. Polyakov. “A Semiclassical limit of the gauge / string correspondence”. *Nucl.Phys.* , B636:99–114, 2002. arXiv : hep-th/0204051.
- [GKT10] Nikolay Gromov, Vladimir Kazakov, and Zengo Tsuboi. “PSU(2, 2|4) Character of Quasiclassical AdS/CFT”. *JHEP* , 1007:097, 2010. arXiv : 1002.3981.
- [GKV09a] N. Gromov, V. Kazakov, and P. Vieira. “Exact Spectrum of Anomalous Dimensions of Planar $\mathcal{N}=4$ Supersymmetric Yang-Mills Theory”. *Physical Review Letters* , 103(13):131601, September 2009. arXiv : 0901.3753.
- [GKV09b] N. Gromov, V. Kazakov, and P. Vieira. “Finite volume spectrum of 2D field theories from Hirota dynamics”. *Journal of High Energy Physics* , 12:60, December 2009. arXiv : 0812.5091.
- [GKV10] Nikolay Gromov, Vladimir Kazakov, and Pedro Vieira. “Exact Spectrum of Planar $\mathcal{N} = 4$ Supersymmetric Yang- Mills Theory: Konishi Dimension at Any Coupling”. *Phys. Rev. Lett.* , 104:211601, 2010. arXiv : 0906.4240.
- [GMSV11] Davide Gaiotto, Juan Maldacena, Amit Sever, and Pedro Vieira. “Bootstrapping Null Polygon Wilson Loops”. *JHEP* , 1103:092, 2011. arXiv : 1010.5009.
- [Gro10] Nikolay Gromov. “Y-system and Quasi-Classical Strings”. *JHEP* , 1001:112, 2010. arXiv : 0910.3608.
- [GS03] F. Göhmann and A. Seel. “A Note on the Bethe Ansatz Solution of the Supersymmetric t-J Model”. *Czechoslovak Journal of Physics* , 53:1041–1046, November 2003. arXiv : 0309138.
- [GV08] Nikolay Gromov and Pedro Vieira. “Complete 1-loop test of AdS/CFT”. *JHEP* , 0804:046, 2008. arXiv : 0709.3487.
- [Hik01] K. Hikami. “The Baxter equation for quantum discrete Boussinesq equation”. *Nuclear Physics B* , 604:580–602, June 2001. arXiv : nlin/0102021.
- [HJŁ08] Michal P. Heller, Romuald A. Janik, and Tomasz Łukowski. “A New derivation of Luscher F-term and fluctuations around the giant magnon”. *JHEP* , 0806:036, 2008. arXiv : 0801.4463.
- [Hoo74] G.’t Hooft. “a planar diagram theory for strong interactions”. *Nuclear Physics B* , 72(3):461 – 473, 1974.
- [Jan06] Romuald A. Janik. “The AdS(5) x S**5 superstring worldsheet S-matrix and crossing symmetry”. *Phys.Rev.* , D73:086006, 2006. arXiv : hep-th/0603038.

- [JŁ07] Romuald A. Janik and Tomasz Łukowski. “Wrapping interactions at strong coupling: The Giant magnon”. *Phys.Rev.* , D76:126008, 2007. [arXiv : 0708.2208](#).
- [KLV12] Vladimir Kazakov, Sébastien Leurent, and Dmytro Volin. “to appear”.
- [KLWZ97] I. Krichever, O. Lipan, P. Wiegmann, and A. Zabrodin. “quantum integrable models and discrete classical Hirota equations”. *Communications in Mathematical Physics* , 188:267–304, 1997. [arXiv : hep-th/9604080](#).
- [KM91] Timothy R. Klassen and Ezer Melzer. “On the relation between scattering amplitudes and finite size mass corrections in QFT”. *Nucl.Phys.* , B362:329–388, 1991.
- [KM97] M. Karbach and G. Müller. “Introduction to the Bethe ansatz I”. *Computers in Physics*, 11, 1997. [arXiv : cond-mat/9809162](#).
- [KMMZ04] V.A. Kazakov, A. Marshakov, J.A. Minahan, and K. Zarembo. “Classical/quantum integrability in AdS/CFT”. *JHEP* , 0405:024, 2004. [arXiv : hep-th/0402207](#).
- [KMS03] V. B. Kuznetsov, V. V. Mangazeev, and E. K. Sklyanin. “Q-operator and factorised separation chain for Jack polynomials”. *Indagationes Mathematicae* , 14(3–4):451 – 482, 2003. [arXiv : math/0306242](#).
- [KN92] Atsuo Kuniba and Tomoki Nakanishi. “Rogers dilogarithm in integrable systems”. 1992. [arXiv : hep-th/9210025](#).
- [KNS94] A. Kuniba, T. Nakanishi, and J. Suzuki. “Functional Relations in Solvable Lattice Models I: Functional Relations and Representation Theory”. *International Journal of Modern Physics A* , 9:5215–5266, 1994. [arXiv : hep-th/9309137](#).
- [Koj08] T. Kojima. “Baxter’s Q-operator for the W-algebra W_N ”. *Journal of Physics A Mathematical General* , 41:I5206, September 2008. [arXiv : 0803.3505](#).
- [Kor05] C. Korff. “A Q-operator identity for the correlation functions of the infinite XXZ spin-chain”. *Journal of Physics A Mathematical General* , 38:6641–6657, July 2005. [arXiv : hep-th/0503130](#).
- [KP92] A. Klümper and P. A. Pearce. “Conformal weights of RSOS lattice models and their fusion hierarchies”. *Physica A Statistical Mechanics and its Applications* , 183:304–350, May 1992.
- [KR83] P.P. Kulish and N. Yu. Reshetikhin. “Diagonalization of $GL(N)$ invariant transfer matrices and quantum N wave system (Lee model)”. *J.Phys.A* , A16:L591–L596, 1983.

- [Kri78] I. M. Krichever. “rational solutions of the kadomtsev — petviashvili equation and integrable systems of n particles on a line”. *Functional Analysis and Its Applications* , 12:59–61, 1978.
- [Kri83] I. M. Krichever. “rational solutions of the zakharov-shabat equations and completely integrable systems of n particles on a line”. *Journal of Mathematical Sciences* , 21:335–345, 1983.
- [Kru05] Martin Kruczenski. “Spiky strings and single trace operators in gauge theories”. *JHEP* , 0508:014, 2005. [arXiv : hep-th/0410226](#).
- [KSZ08] Vladimir Kazakov, Alexander Savelievich Sorin, and Anton Zabrodin. “Supersymmetric Bethe ansatz and Baxter equations from discrete Hirota dynamics”. *Nucl.Phys.* , B790:345–413, 2008. [arXiv : hep-th/0703147](#).
- [KV08] V. Kazakov and P. Vieira. “From characters to quantum (super)spin chains via fusion”. *Journal of High Energy Physics* , 10:50, October 2008. [arXiv : 0711.2470](#).
- [KZ05] P. P. Kulish and A. M. Zeitlin. “Superconformal field theory and SUSY $N=1$ KdV hierarchy II: the Q-operator”. *Nuclear Physics B* , 709:578–591, March 2005. [arXiv : hep-th/0501019](#).
- [Lai74] C. K. Lai. “Lattice gas with nearest-neighbor interaction in one dimension with arbitrary statistics”. *Journal of Mathematical Physics* , 15(10):1675, October 1974.
- [Lip94] L.N. Lipatov. “High-energy asymptotics of multicolor QCD and exactly solvable lattice models”. *Soviet Journal of Experimental and Theoretical Physics Letters*, 59:596, May 1994. [arXiv : hep-th/9311037](#).
- [Lus86a] M. Luscher. “Volume Dependence of the Energy Spectrum in Massive Quantum Field Theories. 1. Stable Particle States”. *Commun. Math. Phys.* , 104:177, 1986.
- [Lus86b] M. Luscher. “Volume Dependence of the Energy Spectrum in Massive Quantum Field Theories. 2. Scattering States”. *Commun. Math. Phys.* , 105:153–188, 1986.
- [Mal98] Juan Martin Maldacena. “The Large N limit of superconformal field theories and supergravity”. *Adv.Theor.Math.Phys.* , 2:231–252, 1998. [arXiv : hep-th/9711200](#).
- [Min03] Joseph A. Minahan. “Circular semiclassical string solutions on $AdS(5) \times S(5)$ ”. *Nucl.Phys.* , B648:203–214, 2003. [arXiv : hep-th/0209047](#).
- [Min12] Joseph A. Minahan. “Review of AdS/CFT Integrability, Chapter I.1: Spin Chains in $N=4$ Super Yang-Mills”. *Lett.Math.Phys.* , 99:33–58, 2012. [arXiv : 1012.3983](#).

- [MOSS11] J.A. Minahan, O. Ohlsson Sax, and C. Sieg. “Anomalous dimensions at four loops in $N=6$ superconformal Chern-Simons theories”. *Nucl.Phys.* , B846:542–606, 2011. arXiv : 0912.3460.
- [MSW02] Gautam Mandal, Nemani V. Suryanarayana, and Spenta R. Wadia. “Aspects of semiclassical strings in $AdS(5)$ ”. *Phys.Lett.* , B543:81–88, 2002. arXiv : hep-th/0206103.
- [MZ03] J.A. Minahan and K. Zarembo. “The Bethe ansatz for $N=4$ superYang-Mills”. *JHEP* , 0303:013, 2003. arXiv : hep-th/0212208.
- [Nep99] Rafael I. Nepomechie. “A Spin chain primer”. *Int.J.Mod.Phys.* , B13:2973–2986, 1999. arXiv : hep-th/9810032.
- [PG92] V. Pasquier and M. Gaudin. “The periodic Toda chain and a matrix generalization of the Bessel function recursion relations”. *Journal of Physics A Mathematical General* , 25:5243–5252, October 1992.
- [Pol70] Alexander M. Polyakov. “Conformal symmetry of critical fluctuations”. *JETP Lett.* , 12:381–383, 1970.
- [Pol77] A.M. Polyakov. “hidden symmetry of the two-dimensional chiral fields”. *Physics Letters B* , 72(2):224 – 226, 1977.
- [PS00] G. P. Pronko and Y. G. Stroganov. “Families of solutions of the nested Bethe ansatz for the A_2 spin chain”. *Journal of Physics A Mathematical General* , 33:8267–8273, November 2000. arXiv : hep-th/9902085.
- [PW83] A. Polyakov and P.B. Wiegmann. “theory of nonabelian goldstone bosons in two dimensions”. *Physics Letters B* , 131(1–3):121 – 126, 1983.
- [PW84] A.M. Polyakov and P.B. Wiegmann. “goldstone fields in two dimensions with multivalued actions”. *Physics Letters B* , 141(3–4):223 – 228, 1984.
- [Rus02] J.G. Russo. “Anomalous dimensions in gauge theories from rotating strings in $AdS(5) \times S^{*5}$ ”. *JHEP* , 0206:038, 2002. arXiv : hep-th/0205244.
- [Sta05] Matthias Staudacher. “The Factorized S-matrix of CFT/ AdS ”. *JHEP* , 0505:054, 2005. arXiv : hep-th/0412188.
- [Sta12] Matthias Staudacher. “Review of AdS/CFT Integrability, Chapter III.1: Bethe Ansätze and the R-Matrix Formalism”. *Lett.Math.Phys.* , 99:191–208, 2012. arXiv : 1012.3990.
- [Sut75] Bill Sutherland. “model for a multicomponent quantum system”. *Phys. Rev. B* , 12:3795–3805, Nov 1975.
- [Tsu97] Z. Tsuboi. “Analytic Bethe ansatz and functional equations for Lie superalgebra?”. *Journal of Physics A Mathematical General* , 30:7975–7991, November 1997. arXiv : 0911.5386.

- [Tsu98] Zengo Tsuboi. “Analytic Bethe Ansatz And Functional Equations Associated With Any Simple Root Systems Of The Lie Superalgebra $sl(r+1|s+1)$ ”. *Physica* , A252:565–585, 1998. [arXiv : 0911.5387](#).
- [Tsu10] Z. Tsuboi. “Solutions of the T-system and Baxter equations for supersymmetric spin chains”. *Nuclear Physics B* , 826:399–455, February 2010. [arXiv : 0906.2039](#).
- [Tsu11] Zengo Tsuboi. “Wronskian solutions of the T, Q and Y-systems related to infinite dimensional unitarizable modules of the general linear superalgebra $gl(M|N)$ ”. 2011. [arXiv : 1109.5524](#).
- [Tsu12] Z. Tsuboi. “Asymptotic representations and q-oscillator solutions of the graded Yang-Baxter equation related to Baxter Q-operators”. May 2012. [arXiv : 1205.1471](#).
- [Vel09] V.N. Velizhanin. “Leading transcendentality contributions to the four-loop universal anomalous dimension in N=4 SYM”. *Phys.Lett.* , B676:112–115, 2009. [arXiv : 0811.0607](#).
- [Vol11] Dmytro Volin. “Quantum integrability and functional equations: Applications to the spectral problem of AdS/CFT and two-dimensional sigma models”. *J.Phys.* , A44:124003, 2011. [arXiv : 1003.4725](#).
- [Vol12] Dmytro Volin. “String hypothesis for $gl(n|m)$ spin chains: a particle/hole democracy”. *Lett.Math.Phys.* , 102:1–29, 2012. [arXiv : 1012.3454](#).
- [Wie84] P.B. Wiegmann. “On the theory of nonabelian goldstone bosons in two dimensions; exact solution of the $SU(N)\otimes SU(N)$ nonlinear σ model”. *Physics Letters B* , 141(3–4):217 – 222, 1984.
- [Wit98] Edward Witten. “Anti-de Sitter space and holography”. *Adv.Theor.Math.Phys.*, 2:253–291, 1998. [arXiv : hep-th/9802150](#).
- [Woy83] F Woynarovich. “low-energy excited states in a hubbard chain with on-site attraction”. *Journal of Physics C: Solid State Physics* , 16(34):6593, 1983.
- [Zab96] A. Zabrodin. “Discrete Hirota’s equation in quantum integrable models”. 1996. [arXiv : hep-th/9610039](#).
- [Zab98] A. V. Zabrodin. “Hirota equation and Bethe ansatz”. *Theoretical and Mathematical Physics* , 116:782–819, July 1998.
- [Zab08] A. Zabrodin. “Backlund transformations for difference Hirota equation and supersymmetric Bethe ansatz”. *Theoretical and Mathematical Physics* , 155:567–584, 2008. [arXiv : 0705.4006](#).
- [Zam90] A. B. Zamolodchikov. “Thermodynamic Bethe ansatz in relativistic models. scaling three state Potts and Lee-Yang models”. *Nucl. Phys.* , B342:695–720, 1990.

- [ZZ79] Alexander B Zamolodchikov and Alexey B Zamolodchikov. “factorized s-matrices in two dimensions as the exact solutions of certain relativistic quantum field theory models”. *Annals of Physics* , 120(2):253 – 291, 1979.