

The Spin Foam Approach to Quantum Gravity

Alejandro Perez

Centre de Physique Théorique

Unité Mixte de Recherche (UMR 6207) du CNRS et des
Universités Aix-Marseille I, Aix-Marseille II, et du Sud Toulon-Var;

laboratoire affilié à la FRUMAM (FR 2291)

email: perez@cpt.univ-mrs.fr

Abstract

This article reviews the present status of the *spin foam approach* to the quantization of gravity. Special attention is paid to the pedagogical presentation of the recently introduced new models for four dimensional quantum gravity. The models are motivated by a suitable implementation of the path integral quantization of the Plebanski formulation of gravity on a simplicial regularization. The article also includes a self-contained treatment of the 2+1 gravity. The simple nature of the latter provides the basis and a perspective for the analysis of both conceptual and technical issues that remain open in four dimensions.

Part I
Introduction

1 Quantum Gravity: A Unifying Framework for Fundamental Physics

The revolution brought by Einstein's theory of gravity lays more in the discovery of the principle of *general covariance* than in the form of the dynamical equations of general relativity. General covariance brings the relational character of nature into our description of physics as an essential ingredient for the understanding of the gravitational force. In general relativity the gravitational field is encoded in the dynamical geometry of space-time, implying a strong form of universality that precludes the existence of any non-dynamical reference system – or non-dynamical background – on top of which things occur. This leaves no room for the old view where fields evolve on an rigid preestablished space-time geometry (e.g., Minkowski space-time): to understand gravity one must describe the dynamics of fields with respect to one another, and independently of any background structure.

General relativity realizes the requirements of general covariance as a classical theory, i.e., for $\hbar = 0$. Einstein's theory is, in this sense, incomplete as a fundamental description of nature. A clear indication of such incompleteness is the generic prediction of space-time *singularities* in the context of gravitational collapse. Near space-time *singularities* the space-time curvature and energy density become so large that any classical description turns inconsistent. This is reminiscent of the foundational examples of quantum mechanics – such as the UV catastrophe of black body radiation or the instability of the classical model of the hydrogen atom – where similar singularities appear if quantum effects are not appropriately taken into account. General relativity must be replaced by a more fundamental description that appropriately includes the quantum degrees of freedom of gravity.

At first sight the candidate would be a suitable generalization of the formalism of quantum field theory (QFT). However, the standard QFT's used to describe other fundamental forces are not appropriate to tackle the problem of quantum gravity. Firstly, because standard QFT's are not generally covariant as they can only be defined if a non-dynamical space-time geometry is provided: the notion of particle, Fourier modes, vacuum, Poincare invariance are essential tools that can only be constructed on a given space-time geometry. This is a strong limitation when it comes to quantum gravity since the very notion of space-time geometry is most likely not defined in the deep quantum regime. Secondly, quantum field theory is plagued by singularities too (UV divergences) coming from the contribution of arbitrary high energy quantum processes. This limitation of standard QFT's is expected to disappear once the quantum fluctuations of the gravitational field, involving the dynamical treatment of spacetime geometry, are appropriately taken into account. But because of its intrinsically background dependent definition, standard QFT cannot be used to shed light on this issue. A general covariant approach to the quantization of gravity is needed.

This is obviously not an easy challenge as in the construction of a general covariant QFT one must abandon from the starting point most of the concepts that are essential in the description of 'no-gravitational' physics. One has to learn to formulate a quantum theory in the absence of preferred reference systems or pre-existent notion of space and time. Loop quantum gravity (LQG) is a framework to address this task. The degrees of freedom of gravity are quantized in accordance to the principles of general covariance. At the present stage there are some indications that both the singularity problems of classical general relativity as well as the UV problem of standard QFT's might vanish in the framework.

However, these indications are not conclusive mainly because the systematic description of dynamical processes remain an open problem at the present stage. In this article we review the status of the construction of a promising approach for handling the difficult dynamical question in LQG: the *spin foam formulation*.

1.1 Why non-perturbative quantum gravity?

Let us make some observations about the problems of standard perturbative quantum gravity. In doing so we will revisit the general discussion above, in a special situation. In standard perturbative approaches to quantum gravity one attempts to describe the gravitational interaction using the same techniques applied to the definition of the standard model. As these techniques require a notion of non dynamical background one (arbitrarily) separates the degrees of freedom of the gravitational field in terms of a background geometry η_{ab} for $a, b = 1 \dots 4$ – fixed once and for all – and dynamical metric fluctuations h_{ab} . Explicitly, one writes the spacetime metric as

$$g_{ab} = \eta_{ab} + h_{ab}. \quad (1)$$

Notice that the previous separation of degrees of freedom has no intrinsic meaning in general relativity. In other words, for a generic spacetime metric g_{ab} we can write

$$g_{ab} = \eta_{ab} + h_{ab} = \tilde{\eta}_{ab} + \tilde{h}_{ab}, \quad (2)$$

where η_{ab} and $\tilde{\eta}_{ab}$ can lead to different background light-cone structures of the underlying spacetime (M, g_{ab}) ; equally natural choices of flat background metrics lead to different Minkowski metrics in this sense. This is quite dangerous if we want to give any physical meaning to the background, e.g., the light cone structures of the two ‘natural’ backgrounds will be generally different providing different notions of causality! Equation (1) is used in the classical theory in very special situations when one considers perturbations of a given background η_{ab} . In quantum gravity one has to deal with arbitrary superpositions of spacetimes; the above splitting can at best be meaningful for very special semi-classical states ‘peaked’, so to say, around the classical geometry η_{ab} with small fluctuations, i.e., it might only make sense only *a posteriori* in the framework of a quantum gravity theory defined independently of any background geometry. Consequently, even when perturbations should be remain useful to approximate special situations, the splitting in Equation (1) is inconsistent when considering general states with their arbitrary quantum excitations at all scales.

This is specially so in gravity due to the dual role of the gravitational field that simultaneously describes the geometry and its own dynamical degrees of freedom. More explicitly, in the standard background dependent quantization the existence of a fixed background geometry is fundamental in the definition of the theory. In the usual treatment one imposes fields at space-like separated points to commute alluding to standard causality considerations. Even when this is certainly justified for matter fields (at least in the range of applicability of the standard model) it makes no sense in the case of gravity: one would be using the causal structure provided by the unphysical background η_{ab} . This difficulty has been raised several times (see, for instance, [361]).

Therefore, treating the gravitational field according to the splitting given in Equation (1) is inconsistent with the fundamental nature of the gravitational degrees of freedom. Treating h_{ab} with the standard perturbative techniques is equivalent to viewing h_{ab} as another matter field with no special properties. As mentioned above, gravitons would propagate respecting the causal structure of the unphysical background *to all orders in perturbation theory!*¹ Radiative corrections do not affect causality. Even though such thing is quite sensible when dealing with matter fields in the regime where gravity is neglected it would be clearly wrong for the gravitational interaction.

1.2 Non-renormalizability of general relativity

If we ignore all these issues and try to setup a naive perturbative quantization of gravity we find that the theory is non renormalizable. This can be expected from dimensional analysis as the

¹One can in principle avoid this by carefully devising a theory of perturbations for generally covariant systems. For some ideas on this see [147, 233].

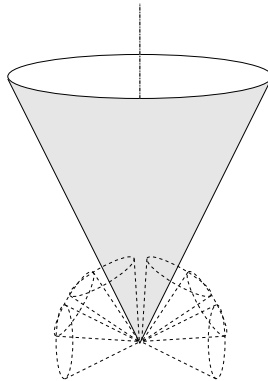

Figure 1: The larger cone represents the light-cone at a point according to the ad hoc background η_{ab} . The smaller cones are a cartoon representation of the fluctuations of the true gravitational field represented by g_{ab} . Gravitons respect the causal structure of the unphysical metric to *all orders* in perturbation theory.

quantity playing the role of the coupling constant turns out to be the Planck length ℓ_p . The non-renormalizability of perturbative gravity is often explained through an analogy with the (non-renormalizable) Fermi's four fermion effective description of the weak interaction. Fermi's four fermions theory is known to be an effective description of the (renormalizable) Weinberg–Salam theory. The non-renormalizable UV behavior of Fermi's four fermion interaction is a consequence of neglecting the degrees of freedom of the exchanged massive gauge bosons which are otherwise disguised as the dimension-full coupling $\Lambda_{\text{Fermi}} \approx 1/m_W^2$ at momentum transfer much lower than the mass of the W particle ($q^2 \ll m_W^2$). A similar view is applied to gravity to promote the search of a more fundamental theory which is renormalizable or finite (in the perturbative sense) and reduces to general relativity at low energies. From this perspective it is argued that the quantization of general relativity is a hopeless attempt to quantizing a theory that does not contain the fundamental degrees of freedom.

These arguments, based on background dependent concepts, seem at the very least questionable in the case of gravity. Although one should expect the notion of a background geometry to be useful in certain semi-classical situations, the assumption that such structure exists all the way down to the Planck scale is inconsistent with what we know about gravity and quantum mechanics. General considerations indicate that standard notions of space and time are expected to fail near the Planck scale ℓ_p^2 . In the field of loop quantum gravity people usually tend to interpret the severe divergences of perturbative quantum gravity as an indication of the inconsistency of the separation of degrees of freedom in Equation (1). According to concrete results in LQG the nature of spacetime is very different from the classical notion in quantum gravity. The treatment that uses Equation (1) as the starting point is assuming a well defined notion of background geometry at all scales which directly contradicts these results.

It is possible that new degrees of freedom would become important at more fundamental scales. It is also possible that including these degrees of freedom might be very important for the consistency of the theory of quantum gravity. However, there is a constraint that seem hardly avoidable:

² For instance a typical example is to use a photon to measure distance. The energy of the photon in our lab frame is given by $E_\gamma = hc/\lambda$. We put the photon in a cavity and produce a standing wave measuring the dimensions of the cavity in units of the wavelength. The best possible precision is attained when the Schwarzschild radius corresponding to energy of the photon is of the order of its wavelength. Beyond that the photon can collapse to form a black hole around some of the maxima of the standing wave. This happens for a value λ_c for which $\lambda_c \approx GE_\gamma/c^4 = hG/(\lambda_c c^3)$. The solution is $\lambda_c \approx \sqrt{hG/c^3}$ which is Planck length.

if we want to get a quantum theory that reproduces gravity in the semi-classical limit we should have a background independent formalism. In loop quantum gravity one stresses this viewpoint. The hope is that learning how to define quantum field theory in the absence of a background is a key ingredient in a recipe for quantum gravity.

One of the achievements of the background independent formulation of LQG is the discovered intrinsic discreteness of quantum geometry. Geometric operators have discrete spectra yielding a physical mechanism for the cut-off of UV degrees of freedom around the Planck scale. In this way LQG is free of UV divergences. Is this a complete answer to the non-renormalizability problem of gravity mentioned above? Unfortunately, the answer to this question is in the negative at this stage. The reason is that the true answer to the question of renormalizability or not renormalizability is not in the presence of divergences but in the degree of intrinsic ambiguity of the quantization recipe applied to a field theory.

In standard background dependent quantum field theories, in order to avoid UV divergences one has to provide a regularization prescription (e.g., an UV cutoff, dimensional regularization, point splitting, etc.). Removing the regulator is a subtle task involving the tuning of certain terms in the Lagrangian (counter-terms) that ensure finite results when the regulator is removed. In fact by taking special care in the mathematical definition of the products of distributions at the same point, in good cases, one can provide a definition of the quantum theory which is completely free of UV divergences [165] (see also [336, 218, 219]). However, any of these regularization procedures is intrinsically ambiguous. The dimension of the parameter space of ambiguities depends on the structure of the theory. The right theory must be fixed by comparing predictions with observations (by the so-called renormalization conditions). In loop quantum gravity there is strong indications that the mathematical framework of the theory provides a regularization of divergences. It remains to settle the crucial issue of how to fix the associated ambiguities.

According to the previous discussion, ambiguities associated to the UV regularization allow for the classification of theories as renormalizable or non renormalizable quantum field theories. In a renormalizable theory such as QED there are finitely many ambiguities which can be fixed by a finite number of renormalization conditions, i.e., one selects the suitable theory by appropriate tuning of the ambiguity parameters in order to match observations. In a nonrenormalizable theory (e.g., perturbative quantum gravity) the situation is similar except for the fact that there are infinitely many parameters to be fixed by renormalization conditions. As the latter must be specified by observations, a non-renormalizable theory has very limited predictive power. In the case of gravity there is evidence indicating that the theory might be non-perturbatively renormalizable coming from the investigations of non trivial fix points of the renormalization group flow in truncated models (see [311] and references therein).

Removing UV divergences by a regularization procedure and ambiguities are two sides of the same coin quantum field theory. Although this can happen in different ways in particular formulations, the problem is intrinsic to the formalism of quantum field theory. In this respect, it is illustrative to analyze the non-perturbative treatment of gauge theories in the context of lattice gauge theory (where the true theory is studied by means of a regulated theory defined on a space-time discretization or lattice). It is well known that here too the regulating procedure leads to ambiguities; the relevance of the example resides in the fact that these ambiguities resemble in nature those appearing in loop quantum gravity. More precisely, let us take for concreteness $SU(2)$ Yang–Mills theory which can be analyzed non-perturbatively using the standard (lattice) Wilson action

$$S_{\text{LYM}} = \frac{1}{g^2} \sum_p \left(1 - \frac{1}{4} \text{Tr}[U_p + U_p^\dagger] \right). \quad (3)$$

In the previous equation $U_p \in SU(2)$ is the holonomy around plaquettes p , and the sum is over all plaquettes of a regulating (hyper-cubic) lattice. It is easy to check that the previous action approximates the Yang–Mills action when the lattice is shrunk to zero for a fixed smooth field

configuration. This property is referred to as the *naive continuum limit*. Moreover, the quantum theory associated to the previous action is free of any UV problem due to the UV cut-off provided by the underlying lattice.

Is this procedure unique? As it is well known the answer is no: one can regulate Yang–Mills theory equally well using the following action instead of Equation (3):

$$S_{\text{LYM}}^{(m)} \propto \frac{1}{g^2} \sum_p \left(1 - \frac{1}{2(2m+1)} \text{Tr}^{(m)}[\Pi^{(m)}(U_p) + \Pi^{(m)}(U_p^\dagger)] \right), \quad (4)$$

where $\Pi^{(m)}(U_p)$ denotes to the $SU(2)$ unitary irreducible representation matrix (of spin m) evaluated on the plaquette holonomy U_p . Or more generally one can consider suitable linear combinations

$$S_{\text{LYM}} = \sum_m a_m S_{\text{LYM}}^{(m)}. \quad (5)$$

From the view point of the classical continuum theory all these actions are equally good as they all satisfy the *naive continuum limit*. Do these theories approximate in a suitable sense the continuum quantum field theory as well? and are these ambiguities un-important in describing the physics of quantum Yang–Mills theory? The answer to both of these questions is yes and the crucial property that leads to this is the renormalizability of Yang–Mills theory. Different choices of actions lead indeed to different discrete theories. However, in the low energy effective action the differences appear only in local operators of dimension five or higher. This simple dimensional argument leads to the expectation that in the continuum limit (i.e., when the regulating lattice dependence is removed by shrinking it to zero) all the above theories should produce the same predictions in the sense that can safely ignore non-renormalizable contributions. This is indeed the case in usual cases, and thus the ambiguities at the ‘microscopic level’ do not have any effect at low energies where one recovers quantum Yang–Mills theory.

Similar ambiguities are present in LQG, they appear in the regularization of the constraints in the canonical formulation [297]. These ambiguities are also present in the spin foam formulation which is the central subject of this review. The simple dimensional argument given for Yang–Mills theory is no longer valid in the case of gravity, and a full dynamical investigation of their effect in physical predictions must be investigated. The spin foam approach is best suited for getting the necessary insights into this important question.

2 Why Spin Foams?

We now provide the basic motivation for the study and definition of spin foams. We present this motivation from the perspective of the canonical quantization approach known as *loop quantum gravity* (see [315, 353, 31]). In such context spin foams appear as the natural tool for studying the dynamics of the canonically defined quantum theory from a covariant perspective. In order to introduce the spin foam approach it is therefore convenient to start with a short introduction of the quantum canonical formulation.

2.1 Loop quantum gravity

Loop quantum gravity is an attempt to define a quantization of gravity paying special attention to the conceptual lessons of general relativity. The theory is explicitly formulated in a background independent, and therefore, non perturbative fashion. The theory is based on the Hamiltonian (or canonical) quantization of general relativity in terms of variables that are different from the standard metric variables. In terms of these variables general relativity is cast into the form of a background independent $SU(2)$ gauge theory whose phase space structure is similar in various ways

to that of $SU(2)$ Yang–Mills theory (the key difference being the absence of any background metric structure). The main prediction of loop quantum gravity (LQG) is the discreteness [337] of the spectrum of geometrical operators such as area and volume. The discreteness becomes important at the Planck scale while the spectrum of geometric operators crowds very rapidly at ‘low energy scales’ (large geometries). This property of the spectrum of geometric operators is consistent with the smooth spacetime picture of classical general relativity.

Thus, from the perspective of LQG, it is not surprising that perturbative approaches would lead to inconsistencies. In splitting the gravitational field degrees of freedom as in Equation (1) one is assuming the existence of a background geometry which is smooth all the way down to the Planck scale. As we consider contributions from ‘higher energies’, this assumption is increasingly inconsistent with the fundamental structure discovered in the non perturbative treatment. However, despite of the many achievements of LQG there remain important issues to be addressed. At the heart of the completion of the definition of the theory the clear-cut definition of the quantum dynamics remains open. The spin foam approach is one of the main avenues to exploring this problem.

The background independence of general relativity implies that the canonical formulation of the field theory is that of a gauge theory with diffeomorphism as part of the gauge group. LQG is constructed by quantizing a phase space formulation of general relativity in terms of $SU(2)$ connection variables. This introduces an extra $SU(2)$ gauge symmetry group. The presence of gauge symmetries implies the existence of relations among phase space variables – defined on a spacelike initial value hypersurface – known as constraints. These constraints define the Poisson algebra of infinitesimal generators of gauge transformations. There are three local constraints G^i – the Gauss constraints – generating $SU(2)$ gauge transformations, three local constraints V_a – the vector constraints – generating three dimensional diffeomorphisms of the initial spacelike hypersurface, and finally a scalar local constraint S related to the remaining gauge symmetry related to the four-diffeomorphism symmetry of the Lagrangian formulation.

The canonical quantization of systems with gauge symmetries is often called the Dirac program. The Dirac program [137, 217] applied to the quantization of general relativity in connection variables leads to the LQG approach.

The first step in the recipe consists in finding a representation of the phase space variables of the theory as operators in a kinematical Hilbert space \mathcal{H}_{kin} satisfying the standard commutation relations, i.e., $\{ , \} \rightarrow -i/\hbar[,]$. This step has been successfully completed in LQG. One chooses the polarization where the $SU(2)$ connection is the configuration variable. Unconstrained phase space variables are replaced by the so-called holonomy-flux algebra which is represented by associated operators in a kinematical Hilbert space of suitable functionals of the generalized-connection $\psi[A]$ which are square integrable with respect to the so-called Ashtekar–Lewandowski [28] (gauge invariant and diffeomorphism invariant) measure $d\mu_{AL}[A]$. A key input is the use of the holonomy flux algebra as a starting point for quantization. Many peculiar properties of LQG follow from this choice this choice is motivated by having an observable algebra leading to simple (diffeomorphism covariant) Poisson brackets ³.

The kinematical inner product is given by

$$\langle \psi, \phi \rangle = \mu_{AL}[\bar{\psi}\phi] = \int d\mu_{AL}[A] \bar{\psi}[A]\phi[A]. \quad (6)$$

The representation of the basic unconstrained phase space variables as suitable operators in \mathcal{H}_{kin} used in LQG – which has the additional key property of containing a special state that is diffeomorphism invariant – has been shown to be unique [239].

³Interestingly, and as a side remark, the structure of the phase space of gravity with boundaries used in the description of concrete physical models seem to provide an extra justification of the use of the holonomy flux variables (see section IV E in [159] for a more detailed discussion of this intriguing fact).

The next step is to promote the constraints to (self-adjoint) operators in \mathcal{H}_{kin} in such a way that the classical Poisson algebra is respected by the appropriate quantum commutator algebra (if this last part is achieved the quantization is said to be non-anomalous). In the case of gravity one must quantize the seven constraints G_i , V_a , and S . Both the Gauss constraint and (finite) diffeomorphism transformations have a natural (unitary) action on states on \mathcal{H}_{kin} . For that reason the quantization (and subsequent solution) is rather direct. The quantization of the scalar constraint presents difficulties. Concrete quantizations producing well defined operators are available: no UV divergences are encountered by these proposals; the fundamental discreteness of quantum geometry in LQG plays the role physical regulator at the Planck scale [348]. Despite of this partial success, problems partly related to special features of the constraint algebra (field dependent structure constant) and partly related to the non-existence of an infinitesimal generator of diffeomorphism at the quantum level make the issue of whether any of the proposed quantizations of the constraints are anomaly-free a difficult open question.

In the third step one needs to characterize the space of solutions of the constraints and define the corresponding inner product that defines a notion of physical probability. This defines the so-called physical Hilbert space \mathcal{H}_{ph} . In LQG physical states are those who satisfy the quantum constraints which, in this sense, could be called Quantum Einstein's equations. More precisely $\Psi \in \mathcal{H}_{ph}$ if

$$\begin{aligned}\widehat{G}_i(A, E)|\Psi > &= 0 \\ \widehat{V}_a(A, E)|\Psi &>= 0, \\ \widehat{S}(A, E)|\Psi &>= 0.\end{aligned}\tag{7}$$

The space of solutions of the first six equations is well understood. The space of solutions of quantum scalar constraint remains open. For some mathematically consistent definitions of \widehat{S} the characterization of the solutions is well understood [31]. The definition of the physical inner product is still an open issue. The completion of this step is intimately dependent on the previously mentioned consistency of the quantum constraint algebra.

Finally, physical interpretation necessitates the definition of a (complete) set of gauge invariant observables, i.e., operators commuting with the constraints. They represent the questions that are well-posed in a generally covariant quantum theory. Already in classical gravity the construction of gauge independent quantities is a subtle issue. At the present stage of the approach physical observables are explicitly known only in some special cases. Understanding the set of physical observables is however intimately related with the problem of characterizing the solutions of the scalar constraint described before.

The spin foam approach was constructed as a means to tackle the difficult question of dynamics and the definition of observable quantities in LQG. It is an attempt to address the difficulties associated last three steps of the list given above by rethinking the problem of dynamics from a path integral covariant perspective. So we need first to briefly discuss the special features of the path integral formulation in the case of generally covariant systems.

2.2 The path integral for generally covariant systems

LQG is based on the canonical (Hamiltonian) quantization of general relativity whose gauge symmetry is diffeomorphism invariance. In the Hamiltonian formulation the presence of gauge symmetries [137] gives rise the constraints mentioned in the previous section. In the present discussion we will schematically represent the latter by the equation $C(p, q) = 0$ for $(p, q) \in \Gamma$. The constraints restrict the set of possible states of the theory by requiring them to lay on the constraint hypersurface. In addition, through the Poisson bracket, the constraints generate motion associated to gauge transformations on the constraint surface (see Figure (2)). The set of physical states (the so

called reduced phase space Γ_{red}) is isomorphic to the space of orbits, i.e., two points on the same gauge orbit represent the same state in Γ_{red} described in different gauges (Figure 2).

In general relativity the absence of a preferred notion of time implies that the Hamiltonian of gravity is a linear combination of constraints. This means that Hamilton equations cannot be interpreted as time evolution and rather correspond to motion along gauge orbits of general relativity. In generally covariant systems conventional time evolution is pure gauge: from an initial data satisfying the constraints one recovers a spacetime by selecting a particular one-parameter family of gauge-transformations (in the standard ADM context this amounts to choosing a particular lapse field $N(x, t)$ and shift $N^a(x, t)$).

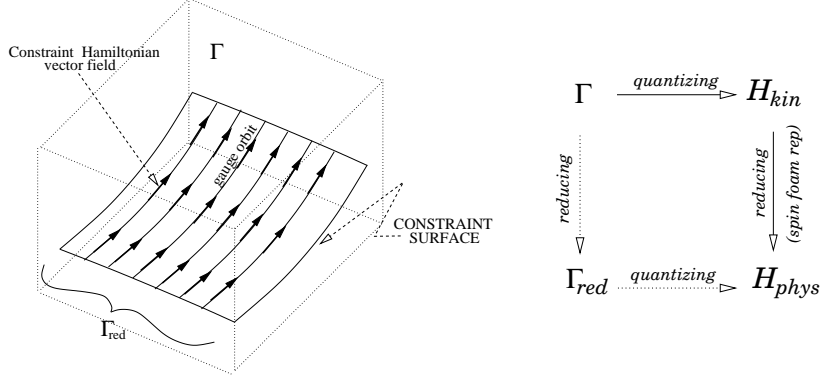

Figure 2: On the left: the geometry of phase space in gauge theories. On the right: the quantization path of LQG (continuous arrows).

From this perspective the notion of spacetime becomes secondary and the dynamical interpretation of the theory seems problematic (in the quantum theory this is referred to as the “*problem of time*”). A reason for this is the central role played by the spacetime representation of classical gravity solutions useful only if can be interpreted via the notion of *test observers* (or more generally *test fields*)⁴. Due to the fact that this idealization is a good approximation to the (classical) process of observation the notion of spacetime is a useful concept only in classical gravity.

As emphasized by Einstein with his hole argument (see [315] for a modern explanation) only the information in relational statements (independent of any spacetime representation) have physical meaning. In classical gravity it remains useful to have a spacetime representation when dealing with idealized test observers. For instance to solve the geodesic equation and then ask *diff-invariant-questions* such as: what is the proper time elapsed on particle 1 between two successive crossings with particle 2? However, already in the classical theory the advantage of the spacetime picture becomes, by far, less clear if the test particles are replaced by real objects coupling to the gravitational field⁵.

The possibility of using the notion of test observers and test fields to construct our interpretative framework is no longer available in quantum gravity. At the Planck scale (ℓ_p) the quantum

⁴ Most (if not all) of the applications of general relativity make use of this concept together with the knowledge of certain exact solutions. In special situations there are even preferred coordinate systems based on this notion which greatly simplify interpretation (e.g., co-moving observers in cosmology, or observers at infinity for isolated systems).

⁵ In this case one would need first to solve the constraints of general relativity in order to find the initial data representing the self-gravitating objects. Then one would have essentially two choices: 1) Fix a lapse $N(t)$ and a shift $N^a(t)$, evolve with the constraints, obtain a spacetime (out of the data) in a particular gauge, and finally ask the *diff-invariant-question*; or 2) try to answer the question by simply studying the data itself (without t-evolution). It is far from obvious whether the first option (the conventional one) is any easier than the second.

fluctuations of the gravitational field become so important that there is no way (not even in principle⁶) to make observations without affecting the gravitational field. The notion of test fields and test observer is lost and with it the usual spacetime representation. In this context there cannot be any, *a priori*, notion of time and hence no notion of spacetime is possible at the fundamental level. A spacetime picture would only arise in the semi-classical regime with the identification of some subsystems that approximate the notion of test observers.

What is then the meaning of the path integral in such background independent context? The previous discussion rules out the conventional interpretation of the path integral. There is no meaningful notion of transition amplitude between states at different times $t_1 > t_0$ or equivalently a notion of “*unitary time evolution*” represented by an operator $U(t_1 - t_0)$. Nevertheless, a path integral representation of generally covariant systems exists and arises as a tool for implementing the constraints in the quantum theory as we argue below.

Due to the difficulty associated with the explicit description of the reduced phase space Γ_{red} , in LQG one follows Dirac’s prescription. One starts by quantizing unconstrained phase space Γ , representing the canonical variables as self-adjoint operators in a *kinematical Hilbert space* \mathcal{H}_{kin} . Poisson brackets are replaced by commutators in the standard way, and the constraints are promoted to self-adjoint operators (see Figure 2). If there are no anomalies the Poisson algebra of classical constraints is represented by the commutator algebra of the associated quantum constraints. In this way the quantum constraints become the infinitesimal generators of gauge transformations in \mathcal{H}_{kin} . The physical Hilbert space $\mathcal{H}_{\text{phys}}$ is defined as the kernel of the constraints, and hence to *gauge invariant* states. Assuming for simplicity that there is only one constraint we have

$$\psi \in \mathcal{H}_{\text{phys}} \quad \text{iff} \quad \exp[iN\hat{C}]\psi = \psi \quad \forall \quad N \in \mathbb{R},$$

where $U(N) = \exp[iN\hat{C}]$ is the unitary operator associated to the gauge transformation generated by the constraint C with parameter N . One can characterize the set of gauge invariant states, and hence construct $\mathcal{H}_{\text{phys}}$, by appropriately defining a notion of ‘averaging’ along the orbits generated by the constraints in \mathcal{H}_{kin} . For instance if one can make sense of the *projector*

$$P : \mathcal{H}_{\text{kin}} \rightarrow \mathcal{H}_{\text{phys}} \quad \text{where} \quad P := \int dN U(N). \quad (8)$$

It is apparent from the definition that for any $\psi \in \mathcal{H}_{\text{kin}}$ then $P\psi \in \mathcal{H}_{\text{phys}}$. The path integral representation arises in the representation of the unitary operator $U(N)$ as a sum over *gauge-histories* in a way which is technically analogous to standard path integral in quantum mechanics. The physical interpretation is however quite different. The *spin foam representation* arises naturally as the path integral representation of the field theoretical analog of P in the context of LQG. Needles is to say that many mathematical subtleties appear when one applies the above formal construction to concrete examples (see [263] and references therein). In the second part of this review we will illustrate in complete detail all the features of the path integral approach for generally covariant systems, formally described here, in the 2+1 pure gravity solvable model. In four dimension the spinfoam approach is a program in progress where various issues still remain open. We will describe the various models in the first part of this article.

2.3 A brief history of spin foams in four dimensions

In this section, we briefly describe the various spin foam models for quantum gravity in the literature (for previous reviews on spin foams see [287, 35, 296, 295, 242, 17]).

⁶ In order to make a Planck scale observation we need a Planck energy probe (think of a Planck energy photon). It would be absurd to suppose that one can disregard the interaction of such photon with the gravitational field treating it as test photon.

2.3.1 The Reisenberger model

According to Plebanski [301] the action of self dual Riemannian gravity can be written as a constrained $SU(2)$ BF theory

$$S(B, A) = \int \text{Tr} [B \wedge F(A)] - \psi_{ij} \left[B^i \wedge B^j - \frac{1}{3} \delta^{ij} B^k \wedge B_k \right], \quad (9)$$

where variations with respect to the symmetric (Lagrange multiplier) tensor ψ_{ij} imposes the constraints

$$\Omega^{ij} = B^i \wedge B^j - \frac{1}{3} \delta^{ij} B^k \wedge B_k = 0. \quad (10)$$

When B is non degenerate the constraints are satisfied if and only if $B^i = \pm(e^0 \wedge e^i + \frac{1}{2} \epsilon^i_{jk} e^j \wedge e^k)$ which reduces the previous action to that of self-dual general relativity. Reisenberger studied the simplicial discretization of this action in [306] as a preliminary step toward the definition of the corresponding spin foam model. The consistency of the simplicial action is argued by showing that the simplicial theory converges to the continuum formulation when the triangulation is refined: both the action and its variations (equations of motion) converge to those of the continuum theory.

In reference [305], Reisenberger constructs a spin foam model for this simplicial theory by imposing the constraints Ω^{ij} directly on the $SU(2)$ BF amplitudes. The spin foam path integral for BF theory is obtained as in Section 14. The constraints are imposed by promoting the B^i to operators χ^i (combinations of left/right invariant vector fields) acting on the discrete connection⁷. The model is defined as

$$Z_{GR} = \int \underbrace{\prod_{e \in \mathcal{J}_\Delta} dg_e}_{\int \mathcal{D}[A]} \overbrace{\delta(\hat{\Omega}^{ij})}^{\int \mathcal{D}[\psi] e^{i\psi_{ij}\Omega^{ij}}} \underbrace{\sum_{\mathcal{C}:\{j\} \rightarrow \{f\}} \prod_{f \in \mathcal{J}_\Delta} \Delta_{j_f} \text{Tr} [j_f(g_e^1 \dots g_e^N)]}_{\int \mathcal{D}[B] e^{i \int \text{Tr}[B \wedge F(A)]}}, \quad (12)$$

where $\hat{\Omega} = \mathcal{J}^i \wedge \mathcal{J}^j - \frac{1}{3} \delta^{ij} \mathcal{J}^k \wedge \mathcal{J}_k$ and we have indicated the correspondence of the different terms with the continuum formulation. The preceding equation is rather formal; for the rigorous implementation see [305]. Reisenberger uses locality so that constraints are implemented on a single 4-simplex amplitude. There is however a difficulty with the this procedure: the algebra of operators $\hat{\Omega}^{ij}$ do not close so that imposing the constraints sharply becomes a too strong condition on the BF configurations⁸. In order to avoid this, Reisenberger defines a one-parameter family of models by inserting the operator

$$e^{-\frac{1}{2z^2} \hat{\Omega}^2} \quad (13)$$

instead of the delta function above. In the limit $z \rightarrow \infty$ the constraints are sharply imposed. This introduces an extra parameter to the model. The properties of the kernel of $\hat{\Omega}$ have not been studied in detail.

⁷ Notice that (for example) the right invariant vector field $\mathcal{J}^i(U) = \sigma^i_B{}^A U_C^B \partial / \partial U^A_C$ has a well defined action at the level of Equation (245) and acts as a B operator at the level of (242) since

$$-i\chi^i(U) \left[e^{i\text{Tr}[BU]} \right] |_{U \sim 1} = \text{Tr}[\sigma^i UB] e^{i\text{Tr}[BU]} |_{U \sim 1} \sim B^i e^{i\text{Tr}[BU]}, \quad (11)$$

where σ^i are Pauli matrices.

⁸ This difficulty also arises in the Barrett–Crane model as we shall see in Section 10.

2.3.2 The Freidel–Krasnov prescription

Freidel and Krasnov [175] define a general framework to construct spin foam models corresponding to theories whose action has the general form

$$S(B, A) = \int \text{Tr} [B \wedge F(A)] + \Phi(B), \quad (14)$$

where the first term is the BF action while $\Phi(B)$ is a certain polynomial function of the B field. The formulation is constructed for compact internal groups. The definition is based on the formal equation

$$\int \mathcal{D}[B]\mathcal{D}[A] e^{i \int \text{Tr}[B \wedge F(A)] + \Phi(B)} := e^{i \int \Phi(\frac{\delta}{\delta J})} Z[J] \Big|_{J=0}, \quad (15)$$

where the *generating functional* $Z[J]$ is defined as

$$Z[J] := \int \mathcal{D}[B]\mathcal{D}[A] e^{i \int \text{Tr}[B \wedge F(A)] + \text{Tr}[B \wedge J]}, \quad (16)$$

where J is an algebra valued 2-form field. They provide a rigorous definition of the generating functional by introducing a discretization of \mathcal{M} in the same spirit of the other spin foam models discussed here. Their formulation can be used to describe various theories of interest such as BF theories with cosmological terms, Yang–Mills theories (in 2 dimensions) and Riemannian self-dual gravity. In the case of self dual gravity B and A are valued in $su(2)$, while

$$\Phi(B) = \int \psi_{ij} \left[B^i \wedge B^j - \frac{1}{3} \delta^{ij} B^k \wedge B_k \right] \quad (17)$$

according to Equation (9). The model obtained in this way is very similar to Reisenberger’s one. There are however some technical differences. One of the more obvious one is that the non-commutative invariant vector fields \mathcal{J}^i representing B^i are replaced here by the commutative functional derivatives $\delta/\delta J^i$.

The idea of using such generating functional techniques have regain interest in the context of the so called McDowell–Mansouri formulation of general relativity [253]. The interest of the latter formulation is that it provides an action of gravity that is given by a BF term plus a genuine potential term instead of constraints. The implementation of the spin foam quantization of such formulation is investigated in [343, 340, 183], see also [325] for an important remark on the approach. More recently similar techniques have been used in [267].

2.3.3 The Iwasaki model

Iwasaki defines a spin foam model of self dual Riemannian gravity⁹ by a direct lattice discretization of the continuous Ashtekar formulation of general relativity. The action is

$$S(e, A) = \int dx^4 \epsilon^{\mu\nu\lambda\sigma} \left[2 e_{[\mu}^0 e_{\nu]i} + \epsilon^0_{ijk} e_{\mu}^j e_{\nu}^k \right] \left[2 \partial_{[\lambda} A_{\sigma]}^i + \epsilon^{0i}_{lm} A_{\lambda}^l A_{\sigma}^m \right], \quad (18)$$

where A_a^i is an $SU(2)$ connection. The fundamental observation of [224] is that one can write the discrete action in a very compact form if we encode part of the degrees of freedom of the tetrad in an $SU(2)$ group element. More precisely, if we take $g_{\mu\mu} = e_{\mu}^i e_{\mu}^j \delta_{ij} = 1$ we can define

⁹ Iwasaki defines another model involving multiple cellular complexes to provide a simpler representation of wedge products in the continuum action. A more detail presentation of this model would require the introduction of various technicalities at this stage so we refer the reader to [225].

$\mathbf{e}_\mu := e_\mu^0 + i\sigma_i e_\mu^i \in SU(2)$ where σ_i are the Pauli matrices. In this parameterization of the ‘angular’ components of the tetrad and using a hypercubic lattice the discrete action becomes

$$S_\Delta = -\beta \sum_{v \in \Delta} e^{\mu\nu\lambda\sigma} r_\mu r_\nu \text{Tr} [\mathbf{e}_\mu^\dagger \mathbf{e}_\nu U_{\lambda\sigma}], \quad (19)$$

where $r_\mu := (\beta^{1/2} \ell_p)^{-1} \epsilon \sqrt{g_{\mu\mu}}$, $U_{\mu\nu}$ is the holonomy around the $\mu\nu$ -plaquette, ϵ the lattice constant and β is a cutoff for r_μ used as a regulator ($r_\mu \leq \beta^{1/2} \ell_p \epsilon^{-1}$). The lattice path integral is defined by using the Haar measure both for the connection and the ‘spherical’ part of the tetrad \mathbf{e} ’s and the radial part $dr_\mu := dr_\mu r_\mu^3$. The key formula to obtain an expression involving spin foams is

$$e^{ix \text{Tr}[U]} = \sum_j (2j+1) \frac{J_{2j+1}(2x)}{x} \chi_j(U). \quad (20)$$

Iwasaki writes down an expression for the spin foam amplitudes in which the integration over the connection and the \mathbf{e} ’s can be computed explicitly. Unfortunately, the integration over the radial variables r involves products of Bessel functions and its behavior is not analyzed in detail. In 3 dimensions the radial integration can be done and the corresponding amplitudes coincide with the results of Section 14.5.

2.3.4 The Barrett–Crane model

The appealing feature of the previous models is the clear connection to loop quantum gravity, since they are defined directly using the self dual formulation of gravity (boundary states are $SU(2)$ -spin networks). The drawback is the lack of closed simple expressions for the amplitudes which complicates their analysis. There is however a simple model that can be obtained as a systematic quantization of simplicial $SO(4)$ Plebanski’s action. This model was introduced by Barrett and Crane in [53] and further motivated by Baez in [34]. The basic idea behind the definition was that of the *quantum tetrahedron* introduced by Barbieri in [52] and generalized to 4d in [36]. The beauty of the model resides in its remarkable simplicity. This has stimulated a great deal of explorations and produced many interesting results.

2.3.5 Markopoulou–Smolin causal spin networks

Using the kinematical setting of LQG with the assumption of the existence of a micro-local (in the sense of Planck scale) causal structure Markopoulou and Smolin define a general class of (causal) spin foam models for gravity [261, 258] (see also [262]). The elementary transition amplitude $A_{s_I \rightarrow s_{I+1}}$ from an initial spin network s_I to another spin network s_{I+1} is defined by a set of simple combinatorial rules based on a definition of causal propagation of the information at nodes. The rules and amplitudes have to satisfy certain causal restrictions (motivated by the standard concepts in classical Lorentzian physics). These rules generate surface-like excitations of the same kind we encounter in the more standard spin foam model but endow the foam with a notion of causality. Spin foams $\mathcal{F}_{s_i \rightarrow s_f}^N$ are labeled by the number of times these elementary transitions take place. Transition amplitudes are defined as

$$\langle s_i, s_f \rangle = \sum_N \prod_{I=0}^{N-1} A_{s_I \rightarrow s_{I+1}}. \quad (21)$$

The models are not related to any continuum action. The only guiding principles are the restrictions imposed by causality, simplicity and the requirement of the existence of a non-trivial critical behavior that would reproduce general relativity at large scales. Some indirect evidence of a possible non trivial continuum limit has been obtained in some versions of the model in 1+1 dimensions.

2.3.6 Gambini–Pullin model

Gambini and Pullin [186] introduced a very simple model obtained by modification of the BF theory skein relations. As we argued in Section 14 skein relations defining the physical Hilbert space of BF theory are implied by the spin foam transition amplitudes. These relations reduce the large kinematical Hilbert space of BF theory (analogous to that of quantum gravity) to a physical Hilbert space corresponding to the quantization of a finite number of degrees of freedom. Gambini and Pullin define a model by modifying these amplitudes so that some of the skein relations are now forbidden. This simple modification frees local excitations of a field theory. A remarkable feature is that the corresponding physical states are (in a certain sense) solutions to various regularizations of the scalar constraint for (Riemannian) LQG. The fact that physical states of BF theory solve the scalar constraint is well known [347], since roughly $F(A) = 0$ implies $EEF(A) = 0$. The situation here is of a similar nature, and – as the authors argue – one should interpret this result as an indication that some ‘degenerate’ sector of quantum gravity might be represented by this model. The definition of this spin foam model is not explicit since the theory is directly defined by the physical skein relations.

2.3.7 Capovilla–Dell–Jacobson theory on the lattice

The main technical difficulty that we gain in going from 3-dimensional general relativity to the 4-dimensional one is that the integration over the e 's becomes intricate. In the Capovilla–Dell–Jacobson [104, 103] formulation of general relativity this ‘integration’ is partially performed at the continuum level. The action is

$$S(\eta, A) = \int \eta \text{Tr} [\epsilon \cdot F(A) \wedge F(A) \epsilon \cdot F(A) \wedge F(A)], \quad (22)$$

where $\epsilon \cdot F \wedge F := \epsilon^{abcd} F_{ab} F_{cd}$. Integration over η can be formally performed in the path integral and we obtain

$$Z = \int \prod_x \delta(\text{Tr} [\epsilon \cdot F(A) \wedge F(A) \epsilon \cdot F(A) \wedge F(A)]), \quad (23)$$

One serious problem of this formulation is that it corresponds to a sector of gravity where the Weyl tensor satisfy certain algebraic requirements. In particular flat geometries are not contained in this sector.

2.3.8 The Engle–Pereira–Rovelli–Livine (EPRL)

A modification of the Barrett–Crane model was recently introduced in [162, 163] and extended for arbitrary Immirzi parameter in [158]. The basic idea was to relax the imposition of the Plebanski constraints that reduce BF theory to general relativity in the quantum theory. The anomalous commutation relations of the B^{10} field in the quantum theory imply that the commutation of the Plebanski constraints does not define a closed algebra. Imposing the constraints strongly as in the Barrett–Crane model implies the imposition of additional conditions that are not present in the classical theory. There is a natural way to relax the constraints and this leads to a simple model that has more clear relationship with the canonical picture provided by LQG. The detailed description of this model will be the main subject of the following discussion of spin foam models for general relativity in 4 dimensions.

¹⁰The six components B^{IJ} are associated to invariant vector fields in the Lorentz group as a direct consequence of the discretization procedure in spin foams. This makes them non commutative and render the simplicity constraints (functionals of the B field alone) non commutative. The origin of the non commutativity of B fields is similar to the non commutativity of fluxes in canonical LQG [26].

2.3.9 Freidel–Krasnov (FK)

A very similar set of models were independently introduced by Freidel and Krasnov in [176]. Indeed these models are arguably the same as the EPRL model for a suitable range of the Immirzi parameter (the vertex amplitudes coincide for $\gamma < 1$ as we will discuss in the sequel). However, the logic used in the derivation is different. The idea is to express the BF path integral in terms of the coherent state representation in order to impose the Plebanski constraints semiclassically in terms of expectation values. The coherent intertwiner basis relevant for the definition of spin foams and the 4d quantum gravity amplitude was also derived by Livine and Speziale in [246]. Freidel and Krasnov introduced the linear version of Plebanski constraints that were later used in order to provide a simpler derivation and generalization of the EPRL model to arbitrary Immirzi parameter.

The last two models are going to be the subject of most of our discussions in what follows. They are the most developed candidates in four dimensions and we will review their properties in detail in the following part.

Part II

Preliminaries: LQG and the canonical quantization of 4d gravity

In this part we briefly review the basic results of the loop quantum gravity approach to the canonical quantization of gravity. This part is relevant for the interpretation of the new spin foams models presented in the next part. The reader interested in the canonical formulation of general relativity in terms of connection variables is referred to the text books [315, 353, 20] and the review article [31]. For a pedagogical introduction see [296].

In the following section we review the canonical analysis of general relativity formulated as a constrained BF theory, i.e., in the so-called Plebanski formulation [301]. The study is done in terms of the variables that, on the one hand, allow for the closest comparison with the discrete variables used in the spin foam approach, while, on the other hand, allow for the introduction the basic elements of the canonical quantization program of loop quantum gravity. The latter being, in my view, the clearest possible setting in which spin foams are to be interpreted.

In Section 4 we present the basic elements of loop quantum gravity (LQG). In Section 5 we give a short description of the spin foam representation of the path integral of gravity. Concrete realizations of this will be reviewed in 4d in Part III and in 3d in Part IV.

3 Classical General Relativity in Connection Variables

The Hamiltonian analysis of general relativity is the basic starting point for canonical quantization. Loop quantum gravity and spin foams are based on the possibility of formulating Hamiltonian general relativity in terms of Yang–Mills-like connection variables. The primitive ancestor of these formulations is Ashtekar’s self-dual *complex* connection formulation of general relativity [19]. Modern, LQG and spin foams are based on a certain relative of these variables that is often referred to as *Ashtekar–Barbero* variables [50, 221]. These variables can be introduced directly by means of a canonical transformation of the phase space of the Palatini formulation of general relativity [350], or can be derived directly from the canonical analysis of the so called Holst action for general relativity [220]. More simply the new variables also follow from the addition of the Nieh–Yan topological invariant to the Palatini action [125]. The Ashtekar–Barbero connection parametrization of the phase space of general relativity also arises naturally from the consideration of the most general diffeomorphism invariant action principle that can be written for the field content of the Palatini first order formulation [312] (i.e. a Lorentz connection $\omega_a^{IJ} = -\omega_a^{JI}$ and a co-tetrad e_a^I with a spacetime indices and $I, J = 0, 1, 2, 3$ internal Lorentz indices).

The new spin foam models are based on Plebanski’s realization that one can obtain classical general relativity by suitable constraining the variations of the B field in the simple kind of topological theory called BF theory [301]. For that reason, the best suited action principle of gravity for the study of the new spin foam models corresponds to one of the Plebanski type. However, the details of such treatment are only partially presented in the literature (see for instance [198], [362]). The material of the following subsection is meant to complete this void, the study is largely inspired in the perspective exploited in references [270, 359] for the canonical formulation of constrained BF theory. As we will show below, the hamiltonian analysis of such formulation of gravity is at the heart of the replacement of the Plebanski quadratic constraints by linear ones that has been so useful in the definition of the new vertex amplitudes [176].

3.1 Gravity as constrained BF theory

In order to keep the presentation simple (and not to bother with the \pm signs appearing in dealing with raising and lowering of Lorentz indices) we present here the Hamiltonian formulation of Riemannian gravity. This is enough to illustrate the algebraic structures that are necessary to introduce in the present context¹¹.

Our starting point is Plebanski’s Riemannian action for general relativity which can be thought of as $Spin(4)$ BF theory plus constraints on the B -field. It depends on an $so(4)$ connection ω , a Lie-algebra-valued 2-form B and Lagrange multiplier fields λ and μ . Writing explicitly the Lie-algebra indexes, the action is given by

$$S[B, \omega, \lambda] = \frac{1}{\kappa} \int_{\mathcal{M}} \left[(*B^{IJ} + \frac{1}{\gamma} B^{IJ}) \wedge F_{IJ}(\omega) + \lambda_{IJKL} B^{IJ} \wedge B^{KL} \right], \quad (24)$$

where μ is a 4-form and $\lambda_{IJKL} = -\lambda_{JIKL} = -\lambda_{IJLK} = \lambda_{KLIJ}$ is a tensor in the internal space satisfying $\epsilon^{IJKL} \lambda_{IJKL} = 0$, and γ is the Immirzi parameter. The Lagrange multiplier tensor λ_{IJKL} has then 20 independent components. The previous action is closely related to the one introduced in [105, 359, 271] (there is a simple analog of the previous action in 3d [90]). Variation with respect to λ imposes 20 algebraic equations on the 36 components of B . They are

$$\epsilon^{\mu\nu\rho\sigma} B_{\mu\nu}^{IJ} B_{\rho\sigma}^{KL} = e \epsilon^{IJKL} \quad (25)$$

where $e = \frac{1}{4!} \epsilon_{OPQR} B_{\mu\nu}^{OP} B_{\rho\sigma}^{QR} \epsilon^{\mu\nu\rho\sigma}$ [126]. The solutions to these equations are

$$B = \pm^*(e \wedge e), \quad \text{and} \quad B = \pm e \wedge e, \quad (26)$$

¹¹ I am grateful to M. Montesinos and M. Velazquez for discussions and contributions to the present section.

in terms of the 16 remaining degrees of freedom of the tetrad field e_a^I . If one substitutes the first solution into the original action one obtains Holst's formulation of general relativity [220]

$$S[e, \omega] = \frac{1}{\kappa} \int_{\mathcal{M}} \text{Tr} \left[(*e \wedge e + \frac{1}{\gamma} e \wedge e) \wedge F(A) \right]. \quad (27)$$

This property is the key to the definition of the spin foam model for gravity of the next section.

3.2 Canonical analysis

Now one performs the usual 3+1 decomposition by assuming the existence of a global time function t whose level hypersurfaces Σ_t define a foliation of the spacetime manifold \mathcal{M} . The previous action takes the following form

$$S[\Pi, H, \omega, \lambda] = \int dt \int_{\Sigma_t} \text{Tr}[\Pi \wedge \dot{\omega} + \omega_0 D_\omega \wedge \Pi + H \wedge F + \lambda' (\gamma^* H - H) \wedge (\gamma^* \Pi - \Pi)], \quad (28)$$

where

$$\begin{aligned} \Pi_{ab}^{IJ} &= *B_{ab}^{IJ} + \frac{1}{\gamma} B_{ab}^{IJ} \\ H_a^{IJ} &= *B_{0a}^{IJ} + \frac{1}{\gamma} B_{0a}^{IJ}, \end{aligned} \quad (29)$$

for $a, b = 1, 2, 3$ are Σ_t -cotangent-space abstract indices, $\lambda' = \gamma^2/(1 - \gamma^2)^2 \lambda$, and the trace is the obvious contraction of internal indices. By choosing an internal direction n^I (and in the gauge where $n^I = (1, 0, 0, 0)$) we can now introduce a convenient reparametrization of the unconstrained phase space by writing the 18 canonical pairs $(\Pi_{ab}^{IJ}, \omega_c^{KL})$ by $(\mathbb{P}(\gamma; \pm)_{ab}^i, \pm \mathbb{A}_c^j)$ where

$$\mathbb{P}(\gamma; \pm)_{ab}^i \equiv \frac{1}{4} \epsilon^i{}_{jk} \Pi_{ab}^{jk} \pm \frac{1}{2\gamma} \Pi_{ab}^{0i}, \quad \pm \mathbb{A}_c^j = \frac{1}{2} \epsilon^j{}_{mn} \omega_c^{mn} \pm \gamma \omega_c^{j0}. \quad (30)$$

For notational convenience we will also introduce

$$\mathbb{H}(\gamma; \pm)_a^i \equiv \frac{1}{4} \epsilon^i{}_{jk} H_a^{jk} \pm \frac{1}{2\gamma} H_a^{0i}.$$

We can rewrite the previous action as

$$\begin{aligned} S[\mathbb{P}(\gamma; \pm), \pm \mathbb{A}, \lambda] &= \int dt \int_{\Sigma} \mathbb{P}(\gamma; +)_i \wedge \mathbb{A}^i + \mathbb{P}(\gamma; -)_i \wedge \mathbb{A}^i + N_i \mathbb{G}^i + \eta_i \mathbb{B}^i + \\ &+ H \wedge F + \lambda' (\gamma^* H - H) \wedge (\gamma^* \Pi - \Pi), \end{aligned} \quad (31)$$

where N^i , η^i , and λ are Lagrange multipliers imposing the constraints:

$$\begin{aligned} \mathbb{B}^i &= (D_{\frac{(+\mathbb{A})+(-\mathbb{A})}{2}} \wedge \mathbb{P}(\gamma; +)^i) \approx 0 \\ \mathbb{G}^i &= \frac{1}{2\gamma} \epsilon^{ijk} (+\mathbb{A} - \mathbb{A})_j \wedge \mathbb{P}(\gamma; +)_k \approx 0, \\ \left. \begin{aligned} &(\frac{\gamma}{2} \epsilon^i{}_{jk} H^{jk} - H^{0i}) \wedge (\frac{\gamma}{2} \epsilon^i{}_{jk} \Pi^{jk} - \Pi^{0i}) + (i \leftrightarrow j) \approx 0 \\ &\frac{1}{4} \epsilon^{(p}{}_{ij} (\frac{\gamma}{2} \epsilon^i{}_{k} H^{0k} - H^{ij}) \wedge \epsilon^q)_{lm} (\frac{\gamma}{2} \epsilon^s{}_{lm} \Pi^{0s} - \Pi^{lm}) \approx 0 \\ &(\frac{\gamma}{2} \epsilon^i{}_{jk} H^{jk} - H^{0i}) \wedge (\frac{\gamma}{2} \epsilon^s{}_{lm} \Pi^{0s} - \Pi^{lm}) + \\ &+ (\frac{\gamma}{2} \epsilon^l{}_{km} H^{0k} - H^{lm}) \wedge (\frac{\gamma}{2} \epsilon^i{}_{jk} \Pi^{jk} - \Pi^{0i}) - v \epsilon^{0ilm} \approx 0 \end{aligned} \right\} \epsilon^{\mu\nu\rho\sigma} B_{\mu\nu}^{IJ} B_{\rho\sigma}^{KL} - e \epsilon^{IJKL} \approx 0. \end{aligned}$$

In the previous equation we explicitly recall that the last three equations are a rewriting of the simplicity constraints (25). We can rewrite them in terms of $\mathbb{P}(\gamma; -)$ and $\mathbb{P}(\frac{1}{\gamma}; -)$ as

$$\begin{aligned}
\mathbb{B}^i &= D_{\frac{(-\mathbb{A})+ (+\mathbb{A})}{2}} \wedge \mathbb{P}(\gamma; +)^i \approx 0, \\
\mathbb{G}^i &= \frac{1}{2\gamma} \epsilon^{ijk} (+\mathbb{A} - -\mathbb{A})_j \wedge \mathbb{P}(\gamma; +)_k \approx 0, \\
\mathbb{I}^{ij} &= \mathbb{H}(\gamma; -)^{(j} \wedge \mathbb{P}(\gamma; -)^{i)} \approx 0, \\
\mathbb{II}^{ij} &= \mathbb{H}(\frac{1}{\gamma}; -)^{(i} \wedge \mathbb{P}(\frac{1}{\gamma}; -)^{j)} \approx 0, \\
\mathbb{III}^{ij} &= \mathbb{H}(\gamma; -)^i \wedge \mathbb{P}(\frac{1}{\gamma}; -)^j + \mathbb{H}(\frac{1}{\gamma}; -)^i \wedge \mathbb{P}(\gamma; -)^j \\
&\quad - \frac{1}{3} [\mathbb{H}(\gamma; -)_k \wedge \mathbb{P}(\frac{1}{\gamma}; -)^k + \mathbb{H}(\frac{1}{\gamma}; -)_k \wedge \mathbb{P}(\gamma; -)^k] \delta^{ij} \approx 0.
\end{aligned} \tag{32}$$

The 20 constraints \mathbb{I}^{ij} , \mathbb{II}^{ij} , and \mathbb{III}^{ij} are referred to as the *simplicity constraints*. The general solution of the simplicity constraints (26) requires, in the 3+1 setting, the introduction of four new fields: the lapse N and the shift vectors N^a . The solution is

$$\begin{aligned}
\mathbb{P}(\gamma; -)_{ab}^i &= 0, \\
\mathbb{P}(\frac{1}{\gamma}; -)_{ab}^i &= \frac{(1-\gamma^2)}{2} \mathbb{P}(\gamma; +)_{ab}^i, \\
\mathbb{H}(\gamma; -)_a^i &= -N \frac{(1-\gamma^2)}{2\gamma^2} e_a^i (\mathbb{P}(\gamma; +)), \\
\mathbb{H}(\frac{1}{\gamma}; -)_a^i &= \frac{(1-\gamma^2)}{2} N^c \mathbb{P}(\gamma; +)_{ca}^i, \\
&\text{with} \\
e_a^i (\mathbb{P}(\gamma; +)) &= \frac{\gamma^{1/2}}{8} \frac{\epsilon_{abc} \epsilon_{jkl}^i \epsilon^{bde} \epsilon^{bfg} \mathbb{P}(\gamma; +)_{de}^j \mathbb{P}(\gamma; +)_{fg}^k}{\sqrt{\det(\mathbb{P}(\gamma; +))}}.
\end{aligned} \tag{33}$$

This solution breaks the internal Lorentz gauge as the first condition above does not commute with the boost constraint \mathbb{B}^i : as it will become clear below it amounts to choosing the so-called *time gauge*. The above equations parametrize the solutions of the Plebanski constraints in terms of the 9 components of $\mathbb{P}(\gamma; +)_{ab}^i$ plus 4 extra parameters given by a scalar N and a space tangent vector $N^a \in T(\Sigma)$ and the 3 parameters in the choice of an internal direction n^I (here implicitly taken as $n^I = (1, 0, 0, 0)$). These are exactly the 16 parameters in the co-tetrad e_μ^I in (26).

The components of H that are necessary to write the term $H \wedge F$ in the action (40) are

$$\begin{aligned}
H_a^{0i} &= \gamma \mathbb{P}(\gamma; +)_{ca}^i N^c + \frac{N}{\gamma} e_a^i \\
\frac{1}{2} \epsilon^k_{ij} H_a^{ij} &= \mathbb{P}(\gamma; +)_{ca}^k N^c + N e_a^i.
\end{aligned}$$

The conservation in time of the set of constraints above lead to 6 secondary constraints. As shown in [312] these follow from

$$\mathbb{C}^{ij} = e^{(j} \wedge \dot{\mathbb{P}}(\gamma; -)^{i)} \propto N e^{(j} \wedge \left[de^{i)} + \frac{1}{2} \epsilon^i_{lm} (+\mathbb{A} + -\mathbb{A})^l \wedge e^m \right] \approx 0 \tag{34}$$

Notice now that the set of 9 constraints $\mathbb{B}^i \approx 0$ and $\mathbb{C}^{(ij)} \approx 0$ are indeed equivalent to the following simple condition

$$\mathbb{IV}_a^i = \frac{1}{2} (+\mathbb{A} + -\mathbb{A})_a^i - \Gamma_a^i(e) \approx 0, \tag{35}$$

where Γ_a^i is the torsion free spin connection compatible with the triad e_a^i , i.e. the unique solution of Cartan's structure equations

$$\partial_{[a} e_{b]}^i + \epsilon^i{}_{jk} \Gamma_{[a}^j e_{b]}^k = 0. \quad (36)$$

Remark: *The primary constraint $\mathbb{P}(\gamma; -) \approx 0$ (first line in Equation (33)) will have central importance in the definition of the new spin foam models. Explicitly, from (30), one has*

$$\mathbb{P}(\gamma; -)_{ab}^i \equiv \frac{1}{4} \epsilon^i{}_{jk} \Pi_{ab}^{jk} - \frac{1}{2\gamma} \Pi_{ab}^{0i} \approx 0. \quad (37)$$

This is exactly the linear simplicity constraints that we will rediscover in the simplicial setting of Sections 7 and 8, and which will be imposed in a suitable sense at all tetrahedra of the cellular decomposition in order to satisfy the Plebanski constraints and produce a state sum model for gravity out of that of BF theory. The consistency requirement (34) are expected to hold in the discrete setting from the fact that one is imposing the linear simplicity constraint for all tetrahedra, thus $\mathbb{P}(\gamma; -) \approx 0$ is valid for all times.

Now from the fact that

$$\{\mathbb{I}\mathbb{V}_a^i(x), \mathbb{P}(\gamma; -)_{bc}^j(y)\} = \frac{1}{2} \epsilon_{abc} \delta^{ij} \delta(x, y) \quad (38)$$

we conclude that the given pair are second class. We can substitute their solution in the action. In particular, from eqs. (30) and (35), $+\mathbb{A}_a^i$ becomes the Ashtekar–Barbero connection

$$+\mathbb{A}_a^i = \Gamma_a^i + \gamma K_a^i \quad (39)$$

where we have defined $K_a^i = (+\mathbb{A}_a^i - -\mathbb{A}_a^i)/2$. With all this

$$\begin{aligned} S[\mathbb{P}(\gamma; +), +\mathbb{A}, N, \vec{N}, N_i] &= \\ &= \frac{1}{\kappa} \int dt \int_{\Sigma} \mathbb{P}(\gamma; +)_i \wedge +\mathbb{A}^i + \\ &+ N_i D_{+\mathbb{A}} \wedge \mathbb{P}(\gamma; +)^i + N_{\perp} \mathbb{P}(\gamma; +)^k \wedge (\gamma F_{0i} + F^{jk} \epsilon_{ijk}) + N e^i \wedge \left(\frac{F_{0i}}{\gamma} + F^{jk} \epsilon_{ijk} \right). \end{aligned} \quad (40)$$

The previous action corresponds to the standard Hamiltonian formulation of general relativity in terms of $SU(2)$ connection variables. This becomes more transparent if we now change to a more standard notation by introducing the so-called *densitized triad*

$$E_i^a = \gamma \epsilon^{abc} \mathbb{P}(\gamma; +)_{bc}^i \quad (41)$$

in terms of which the last line of Equation (33) becomes

$$e_a^i = \frac{1}{2} \frac{\epsilon_{abc} \epsilon^{ijk} E_j^b E_k^c}{\sqrt{|\det(E)|}} \quad \text{and} \quad e_i^a = \frac{\text{sgn}(\det(E)) E_i^a}{\sqrt{|\det(E)|}}. \quad (42)$$

From now on we denote the Ashtekar–Barbero[51] connection A_a^i given by

$$A_a^i = +\mathbb{A}_a^i = \Gamma_a^i + \gamma K_a^i. \quad (43)$$

The Poisson brackets of the new variables are

$$\{E_j^a(x), A_b^i(y)\} = \kappa \gamma \delta_b^a \delta_j^i \delta(x, y), \quad \{E_j^a(x), E_i^b(y)\} = \{A_a^j(x), A_b^i(y)\} = 0. \quad (44)$$

All the previous equations follow explicitly from (40) except for $\{A_a^j(x), A_b^i(y)\} = 0$ which follows from the special property of Γ_a^i in three dimensions that

$$\Gamma_a^i = \frac{\delta W[E]}{\delta E_i^a}, \quad (45)$$

where $W[E]$ is the generating functional for the spin connection¹². The action (40) becomes

$$S[P, A, N, \vec{N}, N_i] = \frac{1}{\gamma\kappa} \int dt \int_{\Sigma} dx^3 \left[E_i^a \dot{A}_i^a - N^b V_b(E_j^a, A_j^b) - NS(E_j^a, A_j^b) - N^i G_i(E_j^a, A_j^b) \right], \quad (46)$$

where the constraints are explicitly given by:

$$V_b(E_j^a, A_j^b) = E_j^a F_{ab} - (1 + \gamma^2) K_a^i G_i \quad (47)$$

$$S(E_j^a, A_j^b) = \frac{E_i^a E_j^b}{\sqrt{\det(E)}} \left(\epsilon^{ij} F_{ab}^k - 2(1 + \gamma^2) K_{[a}^i K_{b]}^j \right) \quad (48)$$

$$G_i(E_j^a, A_j^b) = D_a E_i^a, \quad (49)$$

where $F_{ab} = \partial_a A_b^i - \partial_b A_a^i + \epsilon^i{}_{jk} A_a^j A_b^k$ is the curvature of the connection A_a^i and $D_a E_i^a = \partial_a E_i^a + \epsilon_{ij}{}^k A_a^j E_k^a$ is the covariant divergence of the densitized triad. We have seven (first class) constraints for the 18 phase space variables (A_a^i, E_j^b) . In addition to imposing conditions among the canonical variables, first class constraints are generating functionals of (infinitesimal) gauge transformations. From the 18-dimensional phase space of general relativity we end up with 11 fields necessary to coordinatize the constraint surface on which the above seven conditions hold. On that 11-dimensional constraint surface, the above constraint generate a seven-parameter-family of gauge transformations. The reduce phase space is four dimensional and therefore the resulting number of physical degrees of freedom is *two*, as expected.

The constraint (49) coincides with the standard Gauss law of Yang–Mills theory (e.g. $\vec{\nabla} \cdot \vec{E} = 0$ in electromagnetism). In fact if we ignore (47) and (48) the phase space variables (A_a^i, E_j^b) together with the Gauss law (49) characterize the physical phase space of an $SU(2)$ ¹³ Yang–Mills (YM) theory. The gauge field is given by the connection A_a^i and its conjugate momentum is the electric field E_j^b . Yang–Mills theory is a theory defined on a background spacetime geometry. Dynamics in such a theory is described by a non vanishing Hamiltonian – the Hamiltonian density of YM theory being $\mathcal{H} = E_a^i E_i^a + B_a^i B_i^a$. General relativity is a generally covariant theory and coordinate time plays no physical role. The Hamiltonian is a linear combination of constraints.¹⁴ Dynamics is encoded in the constraint equations (47), (48), and (49). In this sense we can regard general relativity in the new variables as a background independent relative of $SU(2)$ Yang–Mills theory. We will see in the sequel that the close similarity between these theories will allow for the implementation of techniques that are very natural in the context of YM theory.

¹² In fact equation (36) implies that $\Gamma_a^i[E] = \Gamma_a^i[\lambda E]$ for a constant λ . This homogeneity property plus the existence of $W[E]$ imply that $W[E] = \int E_i^a \Gamma_a^i$ as it can be verified by direct calculation.

¹³ The constraint structure does not distinguish $SO(3)$ from $SU(2)$ as both groups have the same Lie algebra. From now on we choose to work with the more fundamental (universal covering) group $SU(2)$. In fact this choice is physically motivated as $SU(2)$ is the gauge group if we want to include fermionic matter[272].

¹⁴ In the physics of the standard model we are used to identifying the coordinate t with the physical time of a suitable family of observers. In the general covariant context of gravitational physics the coordinate time t plays the role of a label with no physical relevance. One can arbitrarily change the way we coordinatize spacetime without affecting the physics. This redundancy in the description of the physics (gauge symmetry) induces the appearance of constraints in the canonical formulation. The constraints in turn are the generating functions of these gauge symmetries. The Hamiltonian generates evolution in coordinate time t but because redefinition of t is pure gauge, the Hamiltonian is a constraint itself, i.e. $\mathcal{H} = 0$ on shell[137, 217]. More on this in the next section.

To conclude this section let us point out that the real connection formulation of general relativity presented here is a peculiar property of four dimensions due to the special property (45). Nevertheless, there are means to obtaining real connection formulations for gravity and supergravity in higher dimensions as recently shown by Thiemann and collaborators [75, 76, 77, 78, 79, 81, 82, 80].

3.2.1 Constraints algebra

Here we simply present the structure of the constraint algebra of general relativity in the new variables.

$$\{G(\alpha), G(\beta)\} = G([\alpha, \beta]), \quad (50)$$

where $\alpha = \alpha^i \tau_i \in su(2)$, $\beta = \beta^i \tau_i \in su(2)$ and $[\alpha, \beta]$ is the commutator in $su(2)$.

$$\{G(\alpha), V(N^a)\} = -G(\mathcal{L}_N \alpha). \quad (51)$$

$$\{G(\alpha), S(N)\} = 0. \quad (52)$$

$$\{V(N^a), V(M^a)\} = V([N, M]^a), \quad (53)$$

where $[N, M]^a = N^b \partial_b M^a - M^b \partial_b N^a$ is the vector field commutator, and \mathcal{L}_N denotes the Lie derivative along the vector field N^a . The previous constraints define the subalgebra of spatial diffeomorphisms and $SU(2)$ internal gauge transformations. This property allows to implement them in the quantum theory separately from the scalar constraint. If we include the scalar constraint the remaining Poisson brackets are

$$\{S(N), V(N^a)\} = -S(\mathcal{L}_N N), \quad (54)$$

and finally

$$\{S(N), S(M)\} = V(S^a) + \text{terms proportional to the Gauss constraint}, \quad (55)$$

where for simplicity we are ignoring the terms proportional to the Gauss law (the complete expression can be found in [31]) and

$$S^a = \frac{E_i^a E_j^b \delta^{ij}}{|\det E|} (N \partial_b M - M \partial_b N). \quad (56)$$

Notice that instead of structure constants, the r.h.s. of (55) is written in terms of field dependent structure functions. For this reason it is said that the constraint algebra does not close in the BRS sense.

3.3 Geometric interpretation of the new variables

The geometric interpretation of the connection A_a^i , defined in (43), is standard. The connection provides a definition of *parallel transport* of $SU(2)$ spinors on the space manifold Σ . The natural object is the $SU(2)$ element defining parallel transport along a path $e \subset \Sigma$ also called *holonomy* denoted $h_e[A]$, or more explicitly

$$h_e[A] = P \exp - \int_e A, \quad (57)$$

where P denotes a path-order-exponential.

The densitized triad – or electric field – E_i^a also has a simple geometrical meaning. As it follows from (42), E_i^a encodes the full background independent Riemannian geometry of Σ . Therefore, any geometrical quantity in space can be written as a functional of E_i^a . One of the simplest is the area

$A_S[E_i^a]$ of a surface $S \subset \Sigma$ whose expression we derive in what follows. Given a two dimensional surface in $S \subset \Sigma$ – with normal

$$n_a = \frac{\partial x^b}{\partial \sigma^1} \frac{\partial x^c}{\partial \sigma^2} \epsilon_{abc} \quad (58)$$

where σ^1 and σ^2 are local coordinates on S – its area is given by

$$A_S[q^{ab}] = \int_S \sqrt{h} d\sigma^1 d\sigma^2, \quad (59)$$

where $h = \det(h_{ab})$ is the determinant of the metric $h_{ab} = q_{ab} - n^{-2}n_a n_b$ induced on S by q^{ab} . From equation (42) it follows that $qq^{ab} = E_i^a E^{bi}$ so that $\det(q^{ab}) = \det(E_i^a)$. Contracting the previous equality with $n_a n_b$, namely

$$qq^{ab}n_a n_b = E_i^a E_j^b \delta^{ij} n_a n_b. \quad (60)$$

Now observe that $q^{nn} = q^{ab}n_a n_b$ is the nn -matrix element of the inverse of q_{ab} . Through the well known formula for components of the inverse matrix we have that

$$q^{nn} = \frac{\det(q_{ab} - n^{-2}n_a n_b)}{\det(q_{ab})} = \frac{h}{q}. \quad (61)$$

But $q_{ab} - n^{-2}n_a n_b$ is precisely the induced metric h_{ab} . Replacing q^{nn} back into (60) we conclude that

$$h = E_i^a E_j^b \delta^{ij} n_a n_b. \quad (62)$$

Finally we can write the area of S as an explicit functional of E_i^a :

$$A_S[E_i^a] = \int_S \sqrt{E_i^a E_j^b \delta^{ij} n_a n_b} d\sigma^1 d\sigma^2. \quad (63)$$

This simple expression for the area of a surface will be very important in the quantum theory.

4 Loop Quantum Gravity and Quantum Geometry in a Nut-shell

Loop quantum gravity is a proposal for the implementation of the quantization program established in the 1960s by Dirac, Wheeler, and DeWitt, among others (for recent reviews see [31, 350, 317]). The technical difficulties of Wheeler’s ‘geometrodynamics’ are circumvented by the use of connection variables instead of metrics [20, 19, 50]. At the kinematical level, the formulation is similar to that of standard gauge theories. The fundamental difference is however the absence of any non-dynamical background field in the theory.

The configuration variable is an $SU(2)$ -connection A_a^i on a 3-manifold Σ representing space. The canonical momenta are given by the densitized triad E_i^a . The latter encode the (fully dynamical) Riemannian geometry of Σ and are the analog of the ‘electric fields’ of Yang–Mills theory.

In addition to diffeomorphisms there is the local $SU(2)$ gauge freedom that rotates the triad and transforms the connection in the usual way. According to Dirac, gauge freedoms result in constraints among the phase space variables which conversely are the generating functionals of infinitesimal gauge transformations. In terms of connection variables the constraints are

$$\mathcal{G}_i = \mathcal{D}_a E_i^a = 0, \quad \mathcal{C}_a = E_k^b F_{ba}^k = 0, \quad \mathcal{S} = \epsilon^{ijk} E_i^a E_j^b F_{abk} + \dots = 0, \quad (64)$$

where \mathcal{D}_a is the covariant derivative and F_{ba}^k is the curvature of A_a^i . \mathcal{G}_i is the familiar Gauss constraint – analogous to the Gauss law of electromagnetism – generating infinitesimal $SU(2)$

gauge transformations, \mathcal{C}_a is the vector constraint generating space-diffeomorphism, and \mathcal{S} is the scalar constraint generating ‘time’ reparameterization (there is an additional term that we have omitted here for simplicity – see Equations (47) to (49), and Section 3.2.1 for the precise form of the constraints and their relationship with the gauge symmetry groups).

Loop quantum gravity is defined using Dirac quantization. One first represents (64) as operators in an auxiliary Hilbert space \mathcal{H} and then solves the constraint equations

$$\hat{\mathcal{G}}_i \Psi = 0, \quad \hat{\mathcal{C}}_a \Psi = 0, \quad \hat{\mathcal{S}} \Psi = 0. \quad (65)$$

The Hilbert space of solutions is the so-called physical Hilbert space \mathcal{H}_{phys} . In a generally covariant system quantum dynamics is fully governed by constraint equations. In the case of loop quantum gravity they represent *quantum Einstein’s equations*.

States in the auxiliary Hilbert space are represented by wave functionals of the connection $\Psi(A)$ which are square integrable with respect to a natural diffeomorphism invariant measure, the Ashtekar-Lewandowski measure [28] (we denote it $\mathcal{L}^2[\mathcal{A}]$ where \mathcal{A} is the space of (generalized) connections). Roughly speaking¹⁵, this space can be decomposed into a direct sum of orthogonal subspaces $\mathcal{H} = \bigoplus_{\gamma} \mathcal{H}_{\gamma}$ labeled by a graph γ in Σ . The fundamental excitations are given by the holonomy $h_{\ell}(A) \in SU(2)$ along a path ℓ in Σ :

$$h_{\ell}(A) = \mathcal{P} \exp \int_{\ell} A. \quad (66)$$

Elements of \mathcal{H}_{γ} are given by functions

$$\Psi_{f,\gamma}(A) = f(h_{\ell_1}(A), h_{\ell_2}(A), \dots, h_{\ell_n}(A)), \quad (67)$$

where h_{ℓ} is the holonomy along the links $\ell \in \gamma$ and $f : SU(2)^n \rightarrow \mathbb{C}$ is (Haar measure) square integrable. They are called *cylindrical functions* and represent a dense set in \mathcal{H} denoted *Cyl*. The ‘momenta’ conjugate to the holonomies are given by the so-called flux operators

$$E(S, \alpha) = \int_S \alpha^i E_i \quad (68)$$

across a 2-surface $s \subset \Sigma$ and labelled by a smearing field $\alpha \in su(2)$. It has been shown that the associated (Poisson) holonomy-flux algebra admits a unique quantization in a Hilbert space with a diffeomorphism invariant states [170, 239]. The Hilbert space \mathcal{H} mentioned above is precisely that unique representation.

Gauge transformations generated by the Gauss constraint act non-trivially at the endpoints of the holonomy, i.e., at nodes of graphs. The Gauss constraint (in (64)) is solved by looking at $SU(2)$ gauge invariant functionals of the connection ($\mathcal{L}^2[\mathcal{A}]/\mathcal{G}$). The fundamental gauge invariant quantity is given by the holonomy around closed loops. An orthonormal basis of the kernel of the Gauss constraint is defined by the so called spin network states $\Psi_{\gamma, \{j_{\ell}\}, \{\iota_n\}}(A)$ [304, 323, 33]. Spin-networks¹⁶ are defined by a graph γ in Σ , a collection of spins $\{j_{\ell}\}$ – unitary irreducible representations of $SU(2)$ – associated with links $\ell \in \gamma$ and a collection of $SU(2)$ intertwiners $\{\iota_n\}$ associated to nodes $n \in \gamma$ (see Figure 3). The spin-network gauge invariant wave functional $\Psi_{\gamma, \{j_{\ell}\}, \{\iota_n\}}(A)$ is constructed by first associating an $SU(2)$ matrix in the j_{ℓ} -representation to the

¹⁵The construction is rather a projective limit [28]. This leads to non-trivial requirements (cylindrical consistency) on the structure (operators) of the theory. This point is very important for spin foams specially in considering the refining limit of amplitudes. We will revisit this issue in Section 7.5.

¹⁶Spin-networks were introduced by Penrose [291, 292, 290, 293] in an attempt to define 3-dimensional Euclidean quantum geometry from the combinatorics of angular momentum in QM. Independently they have been used in lattice gauge theory as a natural basis for gauge invariant functions on the lattice. For an account of their applications in various contexts see [338].

holonomies $h_\ell(A)$ corresponding to the link ℓ , and then contracting the representation matrices at nodes with the corresponding intertwiners ι_n , namely

$$\Psi_{\gamma, \{j_\ell\}, \{\iota_n\}}(A) = \prod_{n \in \gamma} \iota_n \prod_{\ell \in \gamma} j_\ell[h_\ell(A)], \quad (69)$$

where $j_\ell[h_\ell(A)]$ denotes the corresponding j_ℓ -representation matrix evaluated at corresponding link holonomy and the matrix index contraction is left implicit.

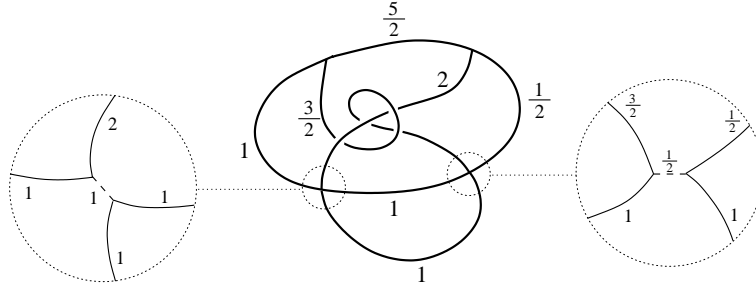

Figure 3: Spin-network state: At 3-valent nodes the intertwiner is uniquely specified by the corresponding spins. At 4 or higher valent nodes an intertwiner has to be specified. Choosing an intertwiner corresponds to decompose the n -valent node in terms of 3-valent ones adding new virtual links (dashed lines) and their corresponding spins. This is illustrated explicitly in the figure for the two 4-valent nodes.

The solution of the vector constraint is more subtle [28]. One uses group averaging techniques together with the diffeomorphism invariance of the kinematical inner product in \mathcal{H} . The diffeomorphism constraint does not exist in the quantum theory. Only finite diffeomorphisms can be defined. As a result solutions (diffeomorphism invariant states) correspond to generalized states. These are not in \mathcal{H} but are elements of the topological dual Cyl^* ¹⁷. However, the intuitive idea is quite simple: solutions to the vector constraint are given by equivalence classes of spin-network states up to diffeomorphism. Two spin-network states are considered equivalent if their underlying graphs can be deformed into each other by the action of a diffeomorphism.

This can be regarded as an indication that the smooth spin-network category could be replaced by something which is more combinatorial in nature so that diffeomorphism invariance becomes a derived property of the classical limit. LQG has been modified along these lines by replacing the smooth manifold structure of the standard theory by the weaker concept of piecewise linear manifold [364]. In this context, graphs defining spin-network states can be completely characterized using the combinatorics of cellular decompositions of space. Only a discrete analog of the diffeomorphism symmetry survives which can be dealt with in a fully combinatorial manner. We will take this point of view when we introduce the notion of spin foam in the following section.

4.1 Quantum geometry

The generalized states described above solve all of the constraints (64) but the scalar constraint. They are regarded as quantum states of the Riemannian geometry on Σ . They define the kinematical sector of the theory known as *quantum geometry*.

Geometric operators acting on spin network states can be defined in terms of the fundamental

¹⁷ According to the triple $Cyl \subset \mathcal{H} \subset Cyl^*$.

triad operators \hat{E}_i^a . The simplest of such operators is the area of a surface S classically given by

$$A_S(E) = \int_S dx^2 \sqrt{\text{Tr}[n_a n_b E^a E^b]} \quad (70)$$

where n is a co normal. The geometric operator $\hat{A}_S(E)$ can be rigorously defined by its action on spin network states [337, 322, 29]. The area operator gives a clear geometrical interpretation to spin-network states: the fundamental 1-dimensional excitations defining a spin-network state can be thought of as quantized ‘flux lines’ of area. More precisely, if the surface $S \subset \Sigma$ is punctured by a spin-network link carrying a spin j , this state is an eigenstate of $\hat{A}_S(E)$ with eigenvalue proportional to $\ell_P^2 \sqrt{j(j+1)}$. In the generic sector – where no node lies on the surface – the spectrum takes the simple form

$$a_S(\{j\}) = 8\pi\iota\ell_P^2 \sum_i \sqrt{j_i(j_i+1)}, \quad (71)$$

where i labels punctures and ι is the Immirzi parameter [221]¹⁸. $a_S(\{j\})$ is the sum of single puncture contributions. The general form of the spectrum including the cases where nodes lie on S has been computed in closed form [29].

The spectrum of the volume operator is also discrete [337, 322, 252, 30]. If we define the volume operator $\hat{V}_\sigma(E)$ of a 3-dimensional region $\sigma \subset \Sigma$ then non vanishing eigenstates are given by spin-networks containing n -valent nodes in σ for $n > 3$. Volume is concentrated in nodes. For new results on the volume see [66, 65]. Other geometric quantities have been considered in the quantization; in the particular in studies of coupling LQG to matter [348] the introduction of a metric operator is necessary. For another proposal of length operator see [64].

4.2 Quantum dynamics

In contrast to the Gauss and vector constraints, the scalar constraint does not have a simple geometrical meaning. This makes its quantization more involved. Regularization choices have to be made and the result is not unique. After Thiemann’s first rigorous quantization [346] other well defined possibilities have been found [195, 129, 130]. This ambiguity affects dynamics governed by

$$\hat{S}\Psi = 0. \quad (72)$$

The difficulty in dealing with the scalar constraint is not surprising. The vector constraint – generating space diffeomorphisms – and the scalar constraint – generating time reparameterizations – arise from the underlying 4-diffeomorphism invariance of gravity. In the canonical formulation the 3+1 splitting breaks the manifest 4-dimensional symmetry. The price paid is the complexity of the time re-parameterization constraint \mathcal{S} . The situation is somewhat reminiscent of that in standard quantum field theory where manifest Lorentz invariance is lost in the Hamiltonian formulation¹⁹.

From this perspective, there has been growing interest in approaching the problem of dynamics by defining a covariant formulation of quantum gravity. The idea is that (as in the QFT case) one can keep manifest 4-dimensional covariance in the path integral formulation. The spin foam approach is an attempt to define the path integral quantization of gravity using what we have learned from LQG.

¹⁸ The Immirzi parameter ι is a free parameter in the theory. This ambiguity is purely quantum mechanical (it disappears in the classical limit). It has to be fixed in terms of physical predictions. The computation of black hole entropy in LQG fixes the value of ι (see [22]).

¹⁹ There is however an additional complication here: the canonical constraint algebra does not reproduce the 4-diffeomorphism Lie algebra. This complicates the geometrical meaning of S .

In standard quantum mechanics path integrals provide the solution of dynamics as a device to compute the time evolution operator. Similarly, in the generally covariant context it provides a tool to find solutions to the constraint equations (this has been emphasized formally in various places: in the case of gravity see for example [206], for a detailed discussion of this in the context of quantum mechanics see [310]). Recall discussion of Section 2.2.

Let us finish by stating some properties of \hat{S} that do not depend on the ambiguities mentioned above. One is the discovery that smooth loop states naturally solve the scalar constraint operator [228, 339]. This set of states is clearly too small to represent the physical Hilbert space (e.g., they span a zero volume sector). However, this implies that \hat{S} acts only on spin network nodes. Its action modifies spin networks at nodes by creating new links according to Figure 4²⁰. This is crucial in the construction of the spin foam approach of the next section.

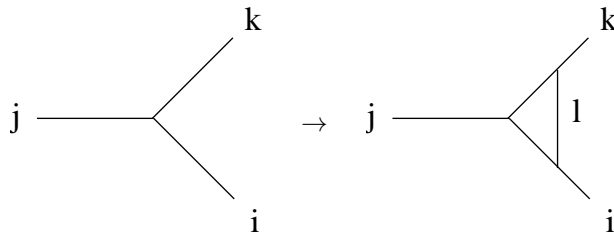

Figure 4: A typical transition generated by the action of the scalar constraint

5 Spin Foams and the Path Integral for Gravity in a Nutshell

The possibility of defining quantum gravity using Feynman's path integral approach has been considered since Misner [268]. Given a 4-manifold \mathcal{M} with boundaries Σ_1 and Σ_2 , and denoting by G the space of metrics on \mathcal{M} , the transition amplitude between $[[q_{ab}]]$ on Σ_1 and $[[q'_{ab}]]$ on Σ_2 is formally

$$\langle [[q_{ab}]] | [[q'_{ab}]] \rangle = \int_{[g]} \mathcal{D}[g] e^{iS([g])}, \quad (73)$$

where the integration on the right is performed over all space-time metrics up to 4-diffeomorphisms $[g] \in G/Diff(\mathcal{M})$ with fixed boundary values up to 3-diffeomorphisms $[q_{ab}]$, $[q'_{ab}]$, respectively.

There are various difficulties associated with (73). Technically there is the problem of defining the functional integration over $[g]$ on the RHS. This is partially because of the difficulties in defining infinite dimensional functional integration beyond the perturbative framework. In addition, there is the issue of having to deal with the space $G/Diff(\mathcal{M})$, i.e., how to characterize the diffeomorphism invariant information in the metric. This gauge problem (3-diffeomorphisms) is also present in the definition of the boundary data. There is no well defined notion of kinematical state $[[q_{ab}]]$ as the notion of kinematical Hilbert space in standard metric variables has never been defined.

The situation is different in the framework of loop quantum gravity. The notion of quantum state of 3-geometry is rigorously defined in terms of spin-network states. They carry the diffeomorphism invariant information of the Riemannian structure of Σ . In addition, and very importantly, these states are intrinsically discrete (colored graphs on Σ) suggesting a possible solution to the functional measure problem, i.e., the possibility of constructing a notion of Feynman 'path integral' in a

²⁰ This is not the case in all the available definitions of the scalar constraints as for example the one defined in [129, 130].

combinatorial manner involving sums over spin network world sheets amplitudes. Heuristically, ‘4-geometries’ are to be represented by ‘histories’ of quantum states of 3-geometries or spin network states. These ‘histories’ involve a series of transitions between spin network states (Figure 5), and define a foam-like structure (a ‘2-graph’ or 2-complex) whose components inherit the spin representations from the underlying spin networks. These spin network world sheets are the so-called *spin foams*.

The precise definition of spin foams was introduced by Baez in [34] emphasizing their role as morphisms in the category defined by spin networks²¹. A spin foam $\mathcal{F} : s \rightarrow s'$, representing a transition from the spin-network $s = (\gamma, \{j_\ell\}, \{\iota_n\})$ into $s' = (\gamma', \{j_{\ell'}\}, \{\iota_{n'}\})$, is defined by a 2-complex \mathcal{J} bordered by the graphs of γ and γ' respectively, a collection of spins $\{j_f\}$ associated with faces $f \in \mathcal{J}$ and a collection of intertwiners $\{\iota_e\}$ associated to edges $e \in \mathcal{J}$. Both spins and intertwiners of exterior faces and edges match the boundary values defined by the spin networks s and s' respectively. Spin foams $\mathcal{F} : s \rightarrow s'$ and $\mathcal{F}' : s' \rightarrow s''$ can be composed into $\mathcal{F}\mathcal{F}' : s \rightarrow s''$ by gluing together the two corresponding 2-complexes at s' . A spin foam model is an assignment of amplitudes $A[\mathcal{F}]$ which is consistent with this composition rule in the sense that

$$A[\mathcal{F}\mathcal{F}'] = A[\mathcal{F}]A[\mathcal{F}']. \quad (74)$$

Transition amplitudes between spin network states are defined by

$$\langle s, s' \rangle_{phys} = \sum_{\mathcal{F}:s \rightarrow s'} A[\mathcal{F}], \quad (75)$$

where the notation anticipates the interpretation of such amplitudes as defining the physical scalar product. The domain of the previous sum is left unspecified at this stage. We shall discuss this question further in Section V. This last equation is the spin foam counterpart of Equation (73). This definition remains formal until we specify what the set of allowed spin foams in the sum are and define the corresponding amplitudes.

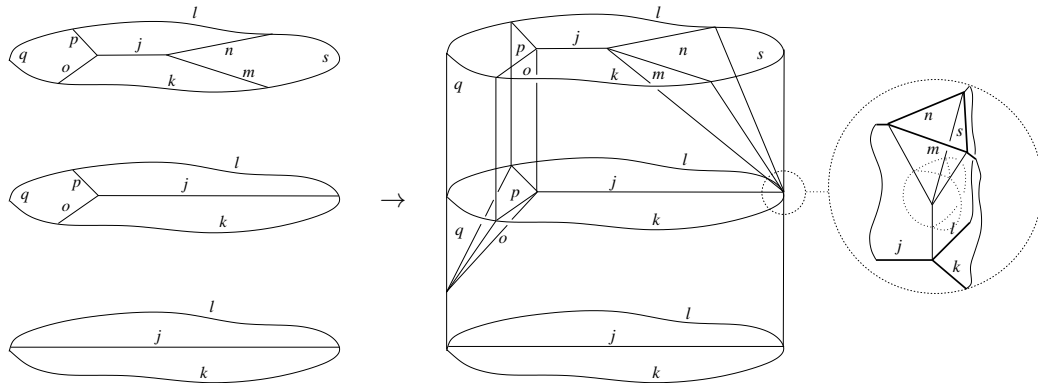

Figure 5: A typical path in a path integral version of loop quantum gravity is given by a series of transitions through different spin-network states representing a state of 3-geometries. Nodes and links in the spin network evolve into 1-dimensional edges and faces. New links are created and spins are reassigned at vertexes (emphasized on the right). The ‘topological’ structure is provided by the underlying 2-complex while the geometric degrees of freedom are encoded in the labeling of its elements with irreducible representations and intertwiners.

The background-independent character of spin foams is manifest. The 2-complex can be thought of as representing ‘space-time’ while the boundary graphs as representing ‘space’. They do

²¹ The role of category theory for quantum gravity had been emphasized by Crane in [122, 121, 124].

not carry any geometrical information in contrast with the standard concept of a lattice. Geometry is encoded in the spin labelings which represent the degrees of freedom of the gravitational field.

In standard quantum mechanics the path integral is used to compute the matrix elements of the evolution operator $U(t)$. It provides in this way the solution for dynamics since for any kinematical state Ψ the state $U(t)\Psi$ is a solution to Schrödinger's equation. Analogously, in a generally covariant theory the path integral provides a device for constructing solutions to the quantum constraints. Transition amplitudes represent the matrix elements of the so-called generalized 'projection' operator P (i.e., $\langle s, s' \rangle_{phys} = \langle sP, s' \rangle$ recall the general discussion of Sections 2.2) such that $P\Psi$ is a physical state for any kinematical state Ψ . As in the case of the vector constraint the solutions of the scalar constraint correspond to distributional states (zero is in the continuum part of its spectrum). Therefore, \mathcal{H}_{phys} is not a proper subspace of \mathcal{H} and the operator P is not a projector (P^2 is ill defined)²². In Section 14 we give an explicit example of this construction.

²² In the notation of the previous section states in \mathcal{H}_{phys} are elements of Cyl^* .

Part III

The new spin foam models for four dimensional gravity

In this part we study the non-perturbative quantization of four dimensional general relativity from the spin foam perspective. Together with Part II, this part of the article forms a self contained body, thus can be studied completely independently from the rest of the content of this review.

The new spin foam models for four dimensional quantum gravity are introduced from a perspective that, in some aspects, is independent from the one taken in the original works related to the so called EPRL model [158, 163, 162] as well as the one used in the definition of the FK models [176]. Our starting point is the quantization of BF theory in the path integral formulation, which leads to a well defined unambiguous state sum model or topological field theory (see Section 6). The space of histories of BF theory path integral will be constrained to satisfy the so-called linear simplicity constraints that reduce BF theory to gravity.

In Section 6 we review the quantization of BF theory and its spin foam representation. In Section 7 we present the Riemannian EPRL model together with various mathematical tools that will be useful in the following sections. In Section 8 the Lorentzian version of the EPRL model is reviewed. In Section 9 we present the FK model. In Section 10 we recall the definition of the Barrett–Crane model.

Finally, there are various review works in the literature [320, 319] where the new models are introduced from a rather minimalistic perspective by simply postulating the defining amplitudes and deriving their relation to gravity a posteriori. Such choice is indeed quite advantageous if the novel simplicity of the new models is to be emphasised. In this article we have chosen a complementary more constructive view. This strategy allows for a systematic presentation of the ingredients that go into the construction of the new models from the perspective of continuum general relativity and BF theory. A possible drawback of this choice is that most of the simplicial geometry intuitions used in other derivations are almost completely avoided. We hope that this loss will be compensated by the potential advantages of an alternative viewpoint.

6 Spinfoam Quantization of BF Theory

Here we follow the perspective of [35]. Let G be a compact group whose Lie algebra \mathfrak{g} has an invariant inner product here denoted $\langle \cdot, \cdot \rangle$, and \mathcal{M} a d -dimensional manifold. Classical BF theory is defined by the action

$$S[\mathbb{B}, \omega] = \int_{\mathcal{M}} \langle \mathbb{B} \wedge F(\omega) \rangle, \quad (76)$$

where \mathbb{B} is a \mathfrak{g} valued $(d-2)$ -form, ω is a connection on a G principal bundle over \mathcal{M} . The theory has no local excitations: all solutions of the equations of motion are locally related by gauge transformations. More precisely, the gauge symmetries of the action are the local G gauge transformations

$$\delta \mathbb{B} = [\mathbb{B}, \alpha], \quad \delta \omega = d_\omega \alpha, \quad (77)$$

where α is a \mathfrak{g} -valued 0-form, and the ‘topological’ gauge transformation

$$\delta \mathbb{B} = d_\omega \eta, \quad \delta \omega = 0, \quad (78)$$

where d_ω denotes the covariant exterior derivative and η is a \mathfrak{g} -valued 0-form. The first invariance is manifest from the form of the action, while the second is a consequence of the Bianchi identity, $d_\omega F(\omega) = 0$. The gauge symmetries are so vast that all the solutions to the equations of motion are locally pure gauge. The theory has only global or topological degrees of freedom.

Remark: In the special case $G = SU(2)$ and $d = 3$ BF theory is (Riemannian) general relativity where the field \mathbb{B}_a^i is given by the cotriad frames e_a^i of general relativity in the first order formalism. This simple example will be studied in more detail in Section 14. Another case of interest is $G = Spin(4)$ and $d = 4$ as it will provide the basis for the construction of the spinfoam models for four dimensional quantum (Riemannian) general relativity studied in Sections 7, 8, 9 and 10. The relationship with general relativity stems from the fact that constraining the field $\mathbb{B}_{ab}^{IJ} = \epsilon^{IJ}_{KL} e_a^K e_b^L$ in the action (76) – where e_a^I is interpreted as the tetrad co-frame – produces the action of general relativity in four dimensions. In the physically relevant cases of the above examples one needs to deal with non-compact groups – $G = SL(2, \mathbb{R})$ and $G = SL(2, \mathbb{C})$ respectively. The non-compactness of the gauge group leads to certain infrared divergencies of transition amplitudes (infinite volume factors). We avoid such complications at this stage and concentrate on the compact G case. The infinite volume divergences will be solved in the particular case of interest which is the spinfoam models for four dimensional Lorentzian gravity whose construction is reviewed in Section 8.

For the moment we assume \mathcal{M} to be a compact and orientable. The partition function, \mathcal{Z} , is formally given by

$$\mathcal{Z} = \int \mathcal{D}[\mathbb{B}] \mathcal{D}[\omega] \exp(i \int_{\mathcal{M}} \langle \mathbb{B} \wedge F(\omega) \rangle). \quad (79)$$

Formally integrating over the \mathbb{B} field in (79) we obtain

$$\mathcal{Z} = \int \mathcal{D}[\omega] \delta(F(\omega)). \quad (80)$$

The partition function \mathcal{Z} corresponds to the ‘volume’ of the space of flat connections on \mathcal{M} .

In order to give a meaning to the formal expressions above, we replace the d -dimensional manifold \mathcal{M} with an arbitrary cellular decomposition Δ . We also need the notion of the associated dual 2-complex of Δ denoted by Δ^* . The dual 2-complex Δ^* is a combinatorial object defined by a set of vertices $v \in \Delta^*$ (dual to d -cells in Δ) edges $e \in \Delta^*$ (dual to $(d-1)$ -cells in Δ) and faces $f \in \Delta^*$ (dual to $(d-2)$ -cells in Δ). In the case where Δ is a simplicial decomposition of \mathcal{M} the

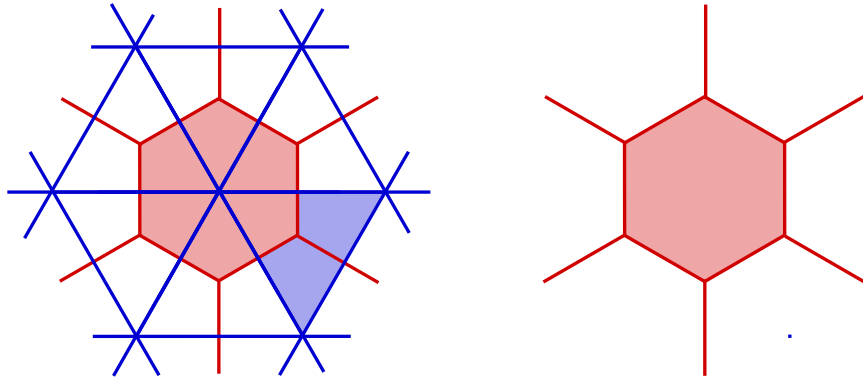

Figure 6: *Left:* a triangulation and its dual in two dimensions. *Right:* the dual two complex; faces (shaded polygon) are dual to 0-simplices in 2d.

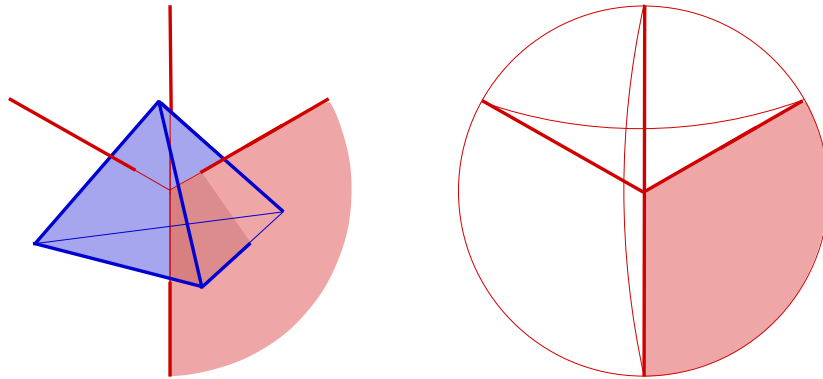

Figure 7: *Left:* a triangulation and its dual in three dimensions. *Right:* the dual two complex; faces (shaded wedge) are dual to 1-simplices in 3d.

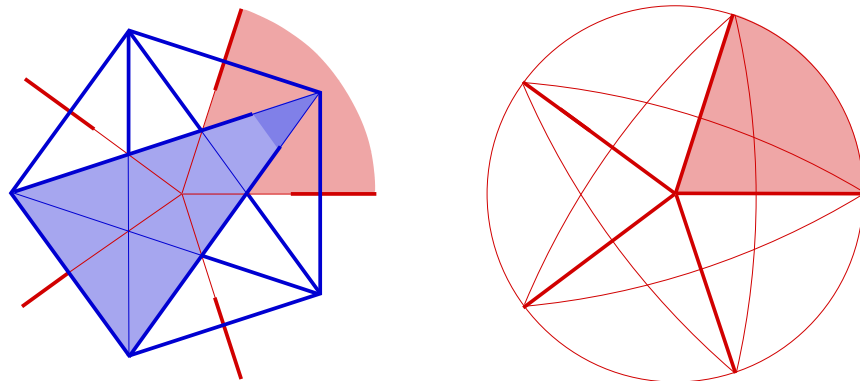

Figure 8: *Left:* a triangulation and its dual in four dimensions. *Right:* the dual two complex; faces (shaded wedge) are dual to triangles in 4d. The shaded triangle dual to the shaded face is exhibited.

structure of both Δ and Δ^* is illustrated in Figures 6, 7, and 8 in two, three, and four dimensions respectively.

For simplicity we concentrate in the case when Δ is a triangulation. The field B is associated with Lie algebra elements B_f assigned to faces $f \in \Delta^*$. We can think of it as the integral of the $(d-2)$ -form B on the $(d-2)$ -cell dual to the face $f \in \Delta^*$, namely

$$B_f = \int_{(d-2)\text{-cell}} B. \quad (81)$$

In other words B_f can be interpreted as the ‘smearing’ of the continuous $(d-2)$ -form B on the $(d-2)$ -cells in Δ . We use the one-to-one correspondence between faces $f \in \Delta^*$ and $(d-2)$ -cells in Δ to label the discretization of the B field B_f . The connection ω is discretized by the assignment of group elements $g_e \in G$ to edges $e \in \Delta^*$. One can think of the group elements g_e as the holonomy of ω along $e \in \Delta^*$, namely

$$g_e = \text{P exp}\left(-\int_e \omega\right), \quad (82)$$

where the symbol ‘‘P exp’’ denotes the path-order-exponential that reminds us of the relationship of the holonomy with the connection along the path $e \in \Delta^*$.

With all this the discretized version of the path integral (79) is

$$Z(\Delta) = \int \prod_{e \in \Delta^*} dg_e \prod_{f \in \Delta^*} dB_f e^{iB_f U_f} = \int \prod_{e \in \Delta^*} dg_e \prod_{f \in \Delta^*} \delta(g_{e_1} \cdots g_{e_n}), \quad (83)$$

where $U_f = g_{e_1} \cdots g_{e_n}$ denotes the holonomy around faces, and the second equation is the result of the B integration: it can be thus regarded as the analog of (80)²³. The integration measure dB_f is the standard Lebesgue measure while the integration in the group variables is done in terms of the invariant measure in G (which is the unique Haar measure when G is compact). For given $h \in G$ and test function $F(g)$ the invariance property reads as follows

$$\int dg F(g) = \int dg F(g^{-1}) = \int dg F(gh) = \int dg F(hg) \quad (84)$$

The Peter-Weyl’s theorem provides a useful formula for the Dirac delta distribution appearing in (83), namely

$$\delta(g) = \sum_{\rho} d_{\rho} \text{Tr}[\rho(g)], \quad (85)$$

where ρ are irreducible unitary representations of G . From the previous expression one obtains

$$Z(\Delta) = \sum_{\mathcal{C}: \{\rho\} \rightarrow \{f\}} \int \prod_{e \in \Delta^*} dg_e \prod_{f \in \Delta^*} d_{\rho_f} \text{Tr}[\rho_f(g_e^1 \cdots g_e^N)]. \quad (86)$$

Integration over the connection can be performed as follows. In a triangulation Δ , the edges $e \in \Delta^*$ bound precisely d different faces; therefore, the g_e ’s in (86) appear in d different traces. The relevant formula is

$$P_{inv}^e(\rho_1, \cdots, \rho_d) := \int dg_e \rho_1(g_e) \otimes \rho_2(g_e) \otimes \cdots \otimes \rho_d(g_e). \quad (87)$$

²³It is important to point out that the integration over the algebra valued B field does not exactly give the group delta function. For instance, in the simple case where $G = SU(2)$ with $B \in su(2)$ integration leads to the $SO(3)$ delta distribution (which only contains integer spin representations in the mode expansion (85)). Generally, one ignores this fact and uses the G -delta distribution in the models found in the literature.

For compact G it is easy to prove using the invariance (and normalization) of the the integration measure (84) that $P_{inv}^e = (P_{inv}^e)^2$ is the projector onto $\text{Inv}[\rho_1 \otimes \rho_2 \otimes \cdots \otimes \rho_d]$. In this way the spin foam amplitudes of $SO(4)$ BF theory reduce to

$$Z_{BF}(\Delta) = \sum_{\mathcal{C}_f: \{f\} \rightarrow \rho_f} \prod_{f \in \Delta^*} d_{\rho_f} \prod_{e \in \Delta^*} P_{inv}^e(\rho_1, \dots, \rho_d). \quad (88)$$

In other words, the BF amplitude associated to a two complex Δ^* is simply given by the sum over all possible assignments of irreducible representations of G to faces of the number obtained by the natural contraction of the network of projectors P_{inv}^e according to the pattern provided defined by the two-complex Δ^* .

There is a nice graphical representation of the partition function of BF theory that will be very useful for some calculations. On the one hand, using this graphical notation one can easily prove the discretization independence of the BF amplitudes. On the other hand this graphical notation will simplify the presentation of the new spin foam models of quantum gravity that will be considered in the following sections. This useful notation was introduced by Oeckl [280, 285] and used in [199] to give a general prove of the discretization independence of the BF partition function and the Turaev-Viro invariants for their definition on general cellular decompositions.

Let us try to present this notation in more detail: The idea is to represent each representation matrix appearing in (86) by a line (called a wire) labeled by an irreducible representation, and integrations on the group by a box (called a cable). The traces in equation (86) imply that there is a wire, labelled by the representation ρ_f , winding around each face $f \in \Delta^*$. In addition, there is a cable (integration on the group) associated with each edge $e \in \Delta^*$. As in (95), there is a projector P_{inv}^e is the projector into $\text{Inv}[\rho_1 \otimes \rho_2 \otimes \cdots \otimes \rho_d]$ associated to each edge. This will be represented by a cable with d wires as shown in (89). Such graphical representation allows for a simple diagrammatic expression of the BF quantum amplitudes.

$$P_{inv}^e(\rho_1, \rho_2, \rho_3, \dots, \rho_d) \equiv \begin{array}{c} \rho_1 \quad \rho_2 \quad \rho_3 \quad \dots \quad \rho_d \\ \begin{array}{c} \text{---} \\ \text{---} \\ \text{---} \\ \text{---} \\ \text{---} \\ \text{---} \\ \text{---} \\ \text{---} \\ \text{---} \\ \text{---} \end{array} \\ \text{---} \end{array} \quad (89)$$

We can now express the product of projection operators defining the BF quantum amplitudes in equation (95) in an entirely graphical way. Let us show this in 2, 3 and 4 dimensions. The generalization to arbitrary dimension is obvious.

According to Figure (6) in two dimensions edges $e \in \Delta^*$ are shared by two faces. This means that there are two representation matrices associated to the group element g_e and hence two wires labelled by two in principle different ρ_f . The endpoint of the open wires are connected to the neighbouring vertices and form close loops around each face (due to the trace in (86)). There is a cable with two wires on each $e \in \Delta^*$. The BF amplitude is obtained by plugging together all the cables in the way dictated by the dual 2-complex Δ^* . In two dimensions the result is

$$Z_{BF}(\Delta) = \sum_{\mathcal{C}_f: \{f\} \rightarrow \rho_f} \prod_{f \in \Delta^*} d_{\rho_f} \begin{array}{c} \text{---} \\ \text{---} \\ \text{---} \\ \text{---} \\ \text{---} \\ \text{---} \\ \text{---} \\ \text{---} \\ \text{---} \\ \text{---} \end{array}, \quad (90)$$

where it is understood that the open ends of the wires are connected to neighbouring vertices according to the combinatorial structure provided by the cellular 2-complex Δ^* . In other words,

the graph on the right hand side of the previous equation is just the basic building block of a closed cable-wire diagram involving the whole complex Δ .

The construction is now obvious in three dimensions. The only difference is that now three faces share each edge and hence cables have three wires labelled by three different representations. The wires are connected according to the structure provided by the dual two complex Δ^* (see now Figure 7) so that a close wire-loop is obtained for each face $f \in \Delta^*$. The result is

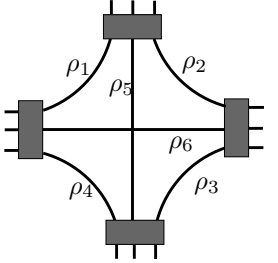
$$Z_{BF}(\Delta) = \sum_{\mathcal{C}_f: \{f\} \rightarrow \rho_f} \prod_{f \in \Delta^*} d_\rho \cdot \text{Diagram} \quad (91)$$

At each vertex we have six wires corresponding to the six faces $f \in \Delta^*$ sharing a vertex $v \in \Delta^*$. As in the 2d case, the cable-diagram diagram on the right is only a piece of a global diagram embracing the whole complex Δ .

Finally, in four dimensions the construction follows the same lines. Now edges are shared by four faces; each cable has now four wires. The cable wire diagram giving the BF amplitude is dictated by the combinatorics of the dual two complex Δ^* . From Figure 8 we get

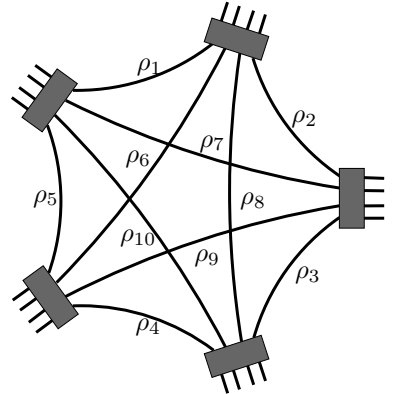
$$Z_{BF}(\Delta) = \sum_{\mathcal{C}_f: \{f\} \rightarrow \rho_f} \prod_{f \in \Delta^*} d_\rho \cdot \text{Diagram} \quad (92)$$

The 10 wires corresponding to the 10 faces $f \in \Delta^*$ sharing a vertex $v \in \Delta^*$ are connected to the neighbouring vertices through the 5 cables (representing the projectors in (95) and Figure 89) associated to the 5 edges $e \in \Delta^*$ sharing the vertex $v \in \Delta^*$.

6.1 Special Cases

We end this section with some simple examples of BF theory that will be useful in following applications.

6.1.1 $SU(2)$ BF theory in 2d: the simplest topological model

The amplitude of BF theory in two dimensions can be entirely worked out due to the simplicity of the projectors P_{inv}^e in this case. For concreteness here we take the special case $G = SU(2)$ as this structure group will play an important case in the gravity context, while the techniques used

here will provide a nice warming-up exercise for what follows. Irreducible representations of $SU(2)$ are labelled by spins (half-integers): from now on we set $\rho_f = j_f \in \mathbb{N}/2$. In two dimensions, the relevant projectors are $P_{inv}^e : j_f \otimes j_{f'} \rightarrow \text{Inv}[j_f \otimes j_{f'}]$ which in turn are non trivial if and only if $j_f = j_{f'}$. In our graphical notation the projector is

$$P_{inv}^e(j, j') = \begin{array}{c} j \quad j' \\ | \quad | \\ \blacksquare \\ | \quad | \end{array} = \frac{\delta_{j,j'}}{(2j+1)} \begin{array}{c} j \\ \cup \\ \cap \\ j \end{array}, \quad (93)$$

where the lines on the right hand side denote the identity representation matrices in the representation j . Replacing this in the expression of the BF amplitude given in equation (90) one gets

$$Z_{BF}^{2d}(\Delta) = \sum_j \prod_{f \in \Delta^*} (2j+1) \prod_{e \in \Delta^*} \frac{1}{(2j+1)} \begin{array}{c} \cup \\ j \\ \cap \end{array} \text{C}, \quad (94)$$

where the sum over j_f in (90) has collapsed to a single sum as according to (93). Spin foam amplitudes vanish unless all the spins assigned to faces are equal, i.e. $j_f = j$ for all $f \in \Delta^*$. In addition to a factor $d_j = (2j+1)$ for each face $f \in \Delta^*$ one gets a factor $1/(2j+1)$ for each edge $e \in \Delta^*$ from the projectors (see 93). Finally, for each vertex $v \in \Delta^*$ one obtains a factor $(2j+1)$ coming from the remaining closed loop that is left over once (93) is used in all the edges associated with v (see (94)). Finally, if we denote N_f , N_e , and N_v the number of faces, the number of edges, and the number of vertices in Δ^* respectively; then it follows that the BF partition function becomes

$$Z_{BF}^{2d}(\Delta) = \sum_j (2j+1)^{N_f - N_e + N_v} = \sum_j (2j+1)^\chi, \quad (95)$$

where χ is the Euler character of the two dimensional manifold \mathcal{M} . In this simple two dimensional example one discovers explicitly two important properties of the partition function (and quantum amplitudes) of BF theory: first, quantum amplitudes are independent of the regulating triangulation used in their definition, and second their discretization independent value depend only on global properties of the spacetime defining topological invariants of the manifold \mathcal{M} . One can genuinly write

$$Z_{BF}^{2d}(\mathcal{M}) = Z_{BF}^{2d}(\Delta). \quad (96)$$

Extra remarks on two dimensional BF theory

Two dimensional BF theory has been used as the basic theory in an attempt to define a manifold independent model of QFT in [245]. It is also related to gravity in two dimensions in two ways: on the one hand it is equivalent to the so-called Jackiw-Teitelboim model [226, 345], on the other hand it is related to usual 2d gravity via constraints in a way similar to the one exploited in four dimensions (see next section). The first relationship has been used in the canonical quantization of the Jackiw-Teitelboim model in [120]. The second relationship has been explored in [289]

6.1.2 $SU(2)$ BF theory and 3d Riemannian gravity

In three dimensions edges $e \in \Delta^*$ are shared by three faces and thus the relevant projector is represented by a cable with three wires. In the case $G = SU(2)$ the singlet component $\text{Inv}[j_1 \otimes$

$j_2 \otimes j_3]$ is one dimensional when it is non-trivial. Therefore, we can write the projector as

$$\begin{array}{c} j \quad m \quad k \\ | \quad | \quad | \\ \text{---} \\ | \quad | \quad | \end{array} = \begin{array}{c} j \quad m \quad k \\ \diagdown \quad \diagup \\ \diagup \quad \diagdown \\ \diagdown \quad \diagup \end{array}, \quad (97)$$

where the three valent open graphs on the right hand side represent the unique normalized invariant vector in $j \otimes m \otimes k$. Now we can play the same game as in the previous example. Replacing the expression of the projectors in equation (91) we get

$$Z_{BF}(\Delta) = \sum_{c_f: \{f\} \rightarrow \rho_f} \prod_{f \in \Delta^*} d_\rho \quad \begin{array}{c} \diagdown \quad \diagup \\ \diagup \quad \diagdown \\ \diagdown \quad \diagup \\ \diagup \quad \diagdown \end{array} \cdot \quad (98)$$

Hence, the amplitude can be written as a sum over spins j_f associated to vertices of a product of face and vertex amplitudes, namely

$$Z_{BF}(\Delta) = \sum_{c_f: \{f\} \rightarrow \rho_f} \prod_{f \in \Delta^*} d_\rho \prod_{v \in \Delta^*} \begin{array}{c} j_1 \quad j_2 \\ \diagdown \quad \diagup \\ \diagup \quad \diagdown \\ \diagdown \quad \diagup \\ j_4 \quad j_3 \end{array} \cdot \quad (99)$$

The vertex amplitude is a $6j$ -symbol and depends on six spins labelling the corresponding faces associated with a vertex.

Extra remarks on three dimensional BF theory

Three dimensional BF theory and the spin foam quantization presented above is intimately related to classical and quantum gravity in three dimensions (for a classic reference see [106]). We will discuss this relationship in detail in Part IV. The state sum as presented above matches the quantum amplitudes first proposed by Ponzano and Regge in the 1960s based on their discovery of the asymptotic expressions of the $6j$ symbols [303] and is often referred to as the Ponzano-Regge model. Divergences in the above formal expression require regularization. We will see in Part IV that natural regularizations are available and that the model is well defined [61, 275, 180]. For a detailed study of the divergence structure of the model see [94, 95, 96, 97]. The quantum deformed version of the above amplitudes lead to the so called Turaev-Viro model [358] which is expected to correspond to the quantization of three dimensional Riemannian gravity in the presence of a non vanishing positive cosmological constant. For the definition of observables in the latter context as well as in the analog four dimensional analog see [60].

The topological character of BF theory can be preserved by the coupling of the theory with topological defects that play the role of point particles. In the spin foam literature this has

been considered from the canonical perspective in [273, 274] and from the covariant perspective extensively by Freidel and Louapre [182]. These theories have been shown by Freidel and Livine to be dual, in a suitable sense, to certain non-commutative fields theories in three dimensions [179, 178].

Concerning coupling BF theory with non topological matter see [166, 149] for the case of fermionic matter, and [341] for gauge fields. A more radical perspective for the definition of matter in 3d gravity is taken in [167]. For three dimensional supersymmetric BF theory models see [243, 32]

Recursion relations for the 6j vertex amplitudes have been investigated in [92, 151]. They provide a tool for studying dynamics in spin foams of 3d gravity and might be useful in higher dimensions [93].

6.1.3 $SU(2)$ BF theory: The Ooguri model

In four dimensions the structure is essentially the same. Now edges are shared by four representations. In the case of $G = SU(2)$ the vector space $\text{Inv}[j_1 \otimes j_2 \otimes j_3 \otimes j_4]$ has a dimension that is generically greater than one. Consequently, if one wants to write the BF quantum partition function as a sum over representations of products of faces and vertex amplitudes (the spin foam representation) one has to express the projectors in terms of a basis of invariant vectors in $j_1 \otimes j_2 \otimes j_3 \otimes j_4$. Graphically, this can be done as follows

$$\begin{array}{c} j_1 \quad j_2 \quad j_3 \quad j_4 \\ | \quad | \quad | \quad | \\ \text{---} \text{---} \text{---} \text{---} \\ | \quad | \quad | \quad | \\ j_1 \quad j_2 \quad j_3 \quad j_4 \end{array} = \sum_{\iota} \begin{array}{c} j_1 \quad j_2 \quad j_3 \quad j_4 \\ \diagdown \quad \diagup \quad \diagdown \quad \diagup \\ \text{---} \text{---} \text{---} \text{---} \\ \diagup \quad \diagdown \quad \diagup \quad \diagdown \\ j_1 \quad j_2 \quad j_3 \quad j_4 \end{array} \quad , \quad (100)$$

where the four-valent diagrams on the right hand side represent elements of an orthonormal basis of invariant vectors in $j_1 \otimes j_2 \otimes j_3 \otimes j_4$ and its dual, which are labelled by a half integer ι . As in the previous lower dimensional cases we replace the previous equation in the expression (92) to obtain

$$Z_{BF}(\Delta) = \sum_{\mathcal{C}_f: \{f\} \rightarrow j_f} \prod_{f \in \Delta^*} d_{j_f} \sum_{\mathcal{C}_e: \{e\} \rightarrow \iota_e} \begin{array}{c} \text{---} \text{---} \text{---} \text{---} \\ \diagdown \quad \diagup \quad \diagdown \quad \diagup \\ \text{---} \text{---} \text{---} \text{---} \\ \diagup \quad \diagdown \quad \diagup \quad \diagdown \\ \text{---} \text{---} \text{---} \text{---} \end{array} \quad , \quad (101)$$

which can be re-written in the spinfoam representation as

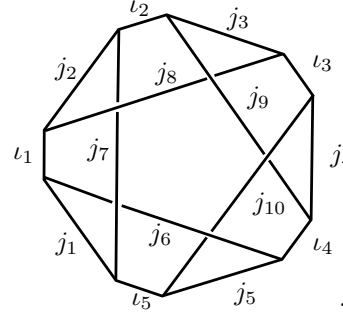
$$Z_{BF}(\Delta) = \sum_{\mathcal{C}_f: \{f\} \rightarrow j_f} \prod_{f \in \Delta^*} d_{j_f} \sum_{\mathcal{C}_e: \{e\} \rightarrow \iota_e} \prod_{v \in \Delta^*} \iota_v \quad (102)$$

The vertex amplitude in the previous expression is often called a 15j-symbol.

6.1.4 $SU(2) \times SU(2)$ BF theory: a starting point for 4d Riemannian gravity

For completeness we now present the BF quantum amplitudes in the case $G = SU(2) \times SU(2)$. This special case is of fundamental importance in the construction of the gravity models presented in the following sections. The construction mimics that of the previous section in all details. In fact the product form of the structure group implies the simple relationship $Z_{BF}(SU(2) \times SU(2)) = Z_{BF}(SU(2))^2$. Nevertheless, it is important for us to present this example in explicit form as it will provide the graphical notation that is needed to introduce the gravity models in a simple manner. As in the previous cases the spin foam representation of the BF partition function follows from expressing the projectors in (92) in the an orthonormal basis of intertwiners. From the previous example and the product form of the structure group we have

$$\begin{array}{c} \rho_1 \ \rho_3 \ \rho_2 \ \rho_4 \\ \text{---} \end{array} = \begin{array}{c} j_1^- \ j_2^- \ j_3^- \ j_4^- \\ \text{---} \end{array} \begin{array}{c} j_1^+ \ j_2^+ \ j_3^+ \ j_4^+ \\ \text{---} \end{array} = \sum_{\iota^- \iota^+} \begin{array}{c} j_1^- \ j_2^- \ j_3^- \ j_4^- \\ \text{---} \\ \iota^- \\ \text{---} \\ j_1^- \ j_2^- \ j_3^- \ j_4^- \\ \text{---} \end{array} \begin{array}{c} j_1^+ \ j_2^+ \ j_3^+ \ j_4^+ \\ \text{---} \\ \iota^+ \\ \text{---} \\ j_1^+ \ j_2^+ \ j_3^+ \ j_4^+ \\ \text{---} \end{array}, \quad (103)$$

where $\rho_f = j_f^- \otimes j_f^+$, and j_f^\pm and ι^\pm are half integers labelling left and right representations of $SU(2)$ that defined the irreducible unitary representations of $G = SU(2) \times SU(2)$. Accordingly, when replacing the previous expression in (92) one gets

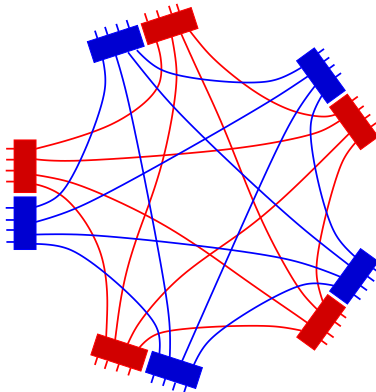
$$Z_{BF}(\Delta) = \sum_{\mathcal{C}_f: \{f\} \rightarrow \rho_f} \prod_{f \in \Delta^*} d_{j_f^-} d_{j_f^+} \quad , \quad (104)$$

and equivalently

$$Z_{BF}(\Delta) = \sum_{\mathcal{C}_f: \{f\} \rightarrow \rho_f} \prod_{f \in \Delta^*} d_{j_f^-} d_{j_f^+} \sum_{\mathcal{C}_e: \{e\} \rightarrow \iota_e} \quad (105)$$

from which we obtain finally the spin foam representation of the $SU(2) \times SU(2)$ partition function as a product of two $SU(2)$ amplitudes, namely

$$Z_{BF}(\Delta) = \sum_{\mathcal{C}_f: \{f\} \rightarrow \rho_f} \prod_{f \in \Delta^*} d_{j_f^-} d_{j_f^+} \sum_{\mathcal{C}_e: \{e\} \rightarrow \iota_e} \prod_{v \in \Delta^*} \quad (106)$$

Extra remarks on four dimensional BF theory

The state sum (86) is generically divergent (due to the gauge freedom analogous to (78)). A regularized version defined in terms of $SU_q(2) \times SU_q(2)$ was introduced by Crane and Yetter [124, 123]. As in three dimensions, if an appropriate regularization of bubble divergences is provided, (86) is topologically invariant and the spin foam path integral is discretization independent.

As in the three dimensional case BF theory in any dimensions can be coupled to topological defects [37]. In the four dimensional case defects are string-like [169] and can carry extra degrees of freedom such as topological Yang-Mills fields [269]. The possibility that quantum gravity could be defined directly from these simple kind of topological theories has also been considered outside spin foams [344] (for which the UV problem described in the introduction is absent) is attractive and should, in my view, be considered further.

It is also possible to introduce one dimensional particles in four dimensional BF theory and gravity as shown in [174].

6.2 The coherent states representation

In this section we introduce the coherent state representation of the $SU(2)$ and $Spin(4)$ path integral of BF theory. This will be particularly important for the definition of the models defined by Freidel and Krasnov in [176] that we will address in Section 9 as well as in the semiclassical analysis of the new models reported in Section 13. The relevance of such representation for spin foams was first emphasized by Livine and Speziale in [246].

6.2.1 Coherent states

Coherent states associated to the representation theory of a compact group have been studied by Thiemann and collaborators [351, 349, 335, 349, 354, 355, 356, 352, 46, 47, 171] see also [70]. Their importance for the new spin foam models was put forward by Livine and Speziale in [246] where the emphasis is put on coherent states of intertwiners or the so-called quantum tetrahedron (see also [117]). Here we follow the presentation of [176].

In order to built coherent states for $\text{Spin}(4)$ we start by introducing them in the case of $SU(2)$. Starting from the representation space \mathcal{H}_j of dimension $d_j \equiv 2j + 1$ one can write the resolution of the identity in terms of the canonical orthonormal basis $|j, m\rangle$ as

$$1_j = \sum_m |j, m\rangle\langle j, m|, \quad (107)$$

where $-j \leq m \leq j$. There exists an over complete basis $|j, g\rangle \in \mathcal{H}_j$ labelled by $g \in SU(2)$ such that

$$1_j = d_j \int_{SU(2)} dg |j, g\rangle\langle j, g|, \quad (108)$$

The states $|j, g\rangle \in \mathcal{H}_j$ are $SU(2)$ coherent states defined by the action of the group on maximum weight states $|j, j\rangle$ (themselves coherent), namely

$$|j, g\rangle \equiv g|j, j\rangle = \sum_m |j, m\rangle D_{mj}^j(g), \quad (109)$$

where $D_{mj}^j(g)$ are the matrix elements of the unitary representations in the $|j, m\rangle$ (Wigner matrices). Equation (108) follows from the orthonormality of unitary representation matrix elements, namely

$$d_j \int_{SU(2)} dg |j, g\rangle\langle j, g| = d_j \sum_{mm'} |j, m\rangle\langle j, m'| \int_{SU(2)} dg D_{mj}^j(g) \overline{D_{m'j}^j(g)} = \sum_m |j, m\rangle\langle j, m|, \quad (110)$$

where in the last equality we have used the orthonormality of the matrix elements graphically represented in (93). The decomposition of the identity (108) can be expressed as an integral on the two-sphere of directions $S^2 = SU(2)/U(1)$ by noticing that $D_{mj}^j(g)$ and $D_{mj}^j(gh)$ differ only by a phase for any group element h from a suitable $U(1) \subset SU(2)$. Thus one has

$$1_j = d_j \int_{S^2} dn |j, n\rangle\langle j, n|, \quad (111)$$

where $n \in S^2$ is integrated with the invariant measure of the sphere. The states $|j, n\rangle$ form (an over-complete) basis in \mathcal{H}_j . $SU(2)$ coherent states have the usual semiclassical properties. Indeed if one considers the operators J^i generators of $su(2)$ one has

$$\langle j, n | \hat{J}^i | j, n \rangle = j n^i, \quad (112)$$

where n^i is the corresponding three dimensional unit vector for $n \in S^2$. The fluctuations of \hat{J}^2 are also minimal with $\Delta J^2 = \hbar^2 j$, where we have restored \hbar for clarity. The fluctuations go to zero in the limit $\hbar \rightarrow 0$ and $j \rightarrow \infty$ while $\hbar j$ is kept constant. This kind of limit will be used often as a notion of semiclassical limit in spin foams. The state $|j, n\rangle$ is a semiclassical state describing a vector in \mathbb{R}^3 of length j and of direction n . It will convenient to introduce the following graphical

notation for equation (111)

$$j \left| \right. = d_j \int_{S^2} dn \left| \begin{array}{c} j \\ \circ \\ n \\ \circ \end{array} \right. \quad (113)$$

Finally, an important property of $SU(2)$ coherent states stemming from the fact that

$$|j, j\rangle = |\frac{1}{2}, \frac{1}{2}\rangle |\frac{1}{2}, \frac{1}{2}\rangle \cdots |\frac{1}{2}, \frac{1}{2}\rangle \equiv |\frac{1}{2}, \frac{1}{2}\rangle^{\otimes 2j}$$

is that

$$|j, n\rangle = |\frac{1}{2}, n\rangle^{\otimes 2j}. \quad (114)$$

The above property will be of key importance in constructing effective discrete actions for spin foam models. In particular, it will play a central role in the study of the semiclassical limit of the EPRLand FK models studied in Sections 7, 8, and 9. In the following subsection we provide an example for $Spin(4)$ BF theory.

6.2.2 $Spin(4)$ BF theory: amplitudes in the coherent state basis

Here we study the coherent states representation of the path integral for $Spin(4)$ BF theory. The construction presented here can be extended to more general cases. The present case is however of particular importance for the study of gravity models presented in Sections 7, 8, and 9. With the introductions of coherent states one achieved the most difficult part of the work. In order to express the $Spin(4)$ BF amplitude in the coherent state representation one simply inserts a resolution of the identity in the form (111) on each and every wire connecting neighbouring vertices in the expression (104) for the BF amplitudes. The result is

$$Z_{BF}(\Delta) = \sum_{\mathcal{C}_f: \{f\} \rightarrow \rho_f} \prod_{f \in \Delta^*} d_{j_f^-} d_{j_f^+}$$

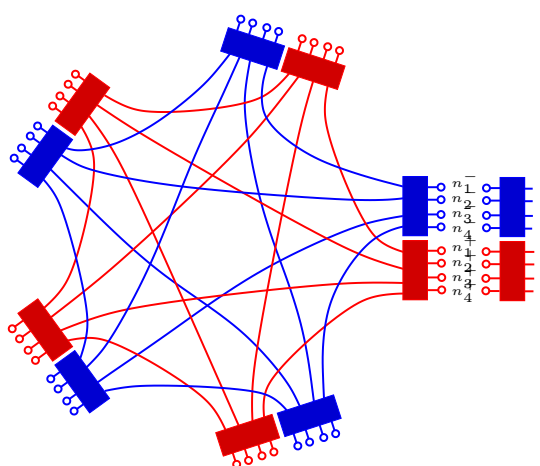
$$\int \prod_{e \in \Delta^*} d_{j_{ef}^-} d_{j_{ef}^+} dn_{ef}^- dn_{ef}^+ \quad (115)$$

where we have explicitly written the $n_{\pm} \in S^2$ integration variables only on a single cable. One observes that there is one $n_{\pm} \in S^2$ per each wire coming out at an edge $e \in \Delta^*$; as wires are in one-to-one correspondence with faces $f \in \Delta^*$ the integration variables $n_{ef}^{\pm} \in S^2$ are labelled by an edge and face subindex. In order to get an expression of the BF path integral in terms of an

affective action we restore at this stage the explicit group integrations represented by the boxes in the previous equation. One gets,

$$Z_{BF}(\Delta) = \sum_{\mathcal{C}_f: \{f\} \rightarrow \rho_f} \prod_{f \in \Delta^*} d_{j_f^-} d_{j_f^+} \int \prod_{e \in \Delta^*} d_{j_{ef}^-} d_{j_{ef}^+} dn_{ef}^- dn_{ef}^+ \prod_{v \in \Delta^*} \prod_{e, e' \in v} dg_{ev}^- dg_{ev}^+ (\langle n_{ef}^- | (g^-)_{ev}^{-1} g_{e'v}^- | n_{e'f}^- \rangle)^{2j_f^-} (\langle n_{ef}^+ | (g^+)_{ev}^{-1} g_{e'v}^+ | n_{e'f}^+ \rangle)^{2j_f^+}, \quad (116)$$

where we have used the coherent states property (114), and $|n^\pm\rangle$ is a simplified notation for $|\frac{1}{2}, n^\pm\rangle$. Also we denote by g_{ev}^\pm the group elements associated to the five boxes for each given vertex (see eq. (115)). The previous equation can be finally written as

$$Z_{BF}(\Delta) = \sum_{\mathcal{C}_f: \{f\} \rightarrow \rho_f} \prod_{f \in \Delta^*} d_{j_f^-} d_{j_f^+} \int \prod_{e \in \Delta^*} d_{j_{ef}^-} d_{j_{ef}^+} dn_{ef}^- dn_{ef}^+ dg_{ev}^- dg_{ev}^+ \exp(S_{j^\pm, \mathbf{n}^\pm}^d[g^\pm]), \quad (117)$$

where the discrete action

$$S_{j^\pm, \mathbf{n}^\pm}^d[g^\pm] = \sum_{v \in \Delta^*} S_{j_v, \mathbf{n}_v}^v[g^\pm] \quad (118)$$

with

$$S_{j, \mathbf{n}}^v[g] = \sum_{a < b = 1}^5 2j_{ab} \ln \langle n_{ab} | g_a^{-1} g_b | n_{ba} \rangle, \quad (119)$$

and the indices a, b label the five edges of a given vertex. The previous expression is exactly equal to the form (86) of the BF amplitude. In the case of the gravity models studied in what follows, the coherent state path integral representation will be the basic tool for the study of the semiclassical limit of the models and the relationship with Regge discrete formulation of general relativity.

7 The Riemannian EPRL model

In this section we introduce the Riemannian version of the Engle–Pereira–Rovelli–Livine (EPRL) [162, 158]. The section is organized as follows. The relevant $Spin(4)$ representation theory is introduced in Section 7.1. In Section 7.2 we present and discuss the linear simplicity constraints – classically equivalent to the Plebanski constraints – and discuss their implementation in the quantum theory. In Section 7.3 we introduce the EPRL model of Riemannian gravity. In Section 7.4 we prove the validity of the quadratic Plebanski constraints – reducing BF theory to general relativity – directly in the spin foam representation. In Section 7.5 we discuss a certain modification of the EPRL model. In Section 7.6 we present the coherent state representation of the EPRL model which is essential for the semiclassical analysis of Section 13. The material of this section will also allow us to describe the construction of the closely related (although derived from a different logic) Riemannian FK constructed in [176]. The idea that linear simplicity constraints are more convenient for dealing with the constraints that reduce BF theory to gravity was pointed out by Freidel and Krasnov in this last reference. We have shown in Part II that they arise directly from the canonical analysis of the Plebanski formulation of gravity.

7.1 Representation theory of $Spin(4)$ and the canonical basis

In order to introduce the definition of the EPRL model we need to briefly review the representation theory of $Spin(4)$. The group $Spin(4) = SU(2) \times SU(2)$ with Lie algebra $spin(4) = su(2) \oplus su(2)$ can explicitly be described in terms of generators J_\pm^i such that

$$[J_\pm^i, J_\pm^j] = \epsilon^{ij}_k J_\pm^k. \quad (120)$$

Unitary irreducible representations \mathcal{H}_{j^+, j^-} of $Spin(4)$ are given by the product of unitary irreducible representations of $SU(2)$, i.e., they are labelled by two half-integers j^\pm . A standard basis in \mathcal{H}_{j^+, j^-} is given by vectors $|j^+, j^-, m^+, m^-\rangle$ of eigenstates of the Casimirs $C_1 = J_+^2 + J_-^2$ and $C_2 = J_+^2 - J_-^2$ and the components J_\pm^3 and J_\pm^3 , explicitly

$$\begin{aligned} C_1 |j^+, j^-, m^+, m^-\rangle &= (j_+(j_+ + 1) + j_-(j_- + 1)) |j^+, j^-, m^+, m^-\rangle \\ C_2 |j^+, j^-, m^+, m^-\rangle &= (j_+(j_+ + 1) - j_-(j_- + 1)) |j^+, j^-, m^+, m^-\rangle \\ J_\pm^3 |j^+, j^-, m^+, m^-\rangle &= m^\pm |j^+, j^-, m^+, m^-\rangle. \end{aligned} \quad (121)$$

The definition of the EPRL model requires the introduction of an (arbitrary) subgroup $SU(2) \subset Spin(4)$. This subgroup will be shown, *a posteriori*, to be the internal gauge group of the gravitational phase space in connection variables (appearing in the classical canonical study of Section 3.2 and leading to the quantization of Section 4). In the quantum theory, the representation theory of this $SU(2)$ subgroup will be hence important. This importance will soon emerge as apparent from the imposition of the constraints that define the EPRL as well as the FK model of Section 9.

The link between the unitary representations of $spin(4)$ and those of $su(2)$ comes from the fact that the former can be expressed as a direct sum of the latter according to

$$\mathcal{H}_{j^+, j^-} = \bigoplus_{j=|j^+ - j^-|}^{j^+ + j^-} \mathcal{H}_j. \quad (122)$$

As the unitary irreducible representations of the subgroup $SU(2) \in Spin(4)$ are essential in understanding the link of the EPRL model and the operator canonical formulation of LQG it will be convenient to express the action of the generators of the Lie algebra $spin(4)$ in a basis adapted to the above equation. In order to do this we first notice that the Lie algebra (120) can be equivalently characterized in terms of the generators of a rotation subgroup L^i and the remaining “boost” generators K^i as follows

$$\begin{aligned} [L_3, L_\pm] &= \pm L_\pm & [L_+, L_-] &= 2 L_3 \\ [L_+, K_+] &= [L_-, K_-] = [L_3, K_3] & &= 0 \\ [K_3, L_\pm] &= \pm K_\pm & [L_\pm, K_\mp] &= \pm 2 K_3 & [L_3, K_\pm] &= \pm K_\pm \\ [K_3, K_\pm] &= \pm L_\pm & [K_+, K_-] &= 2 L_3, \end{aligned} \quad (123)$$

where $K_\pm = K^1 \pm iK^2$ and $L_\pm = L^1 \pm iL^2$ respectively. The action of the previous generators in the basis $|j^+, j^-, j, m\rangle$ can be shown to be

$$\begin{aligned} L^3 |j^+, j^-, j, m\rangle &= m |j^+, j^-, j, m\rangle, \\ L^+ |j^+, j^-, j, m\rangle &= \sqrt{(j+m+1)(j-m)} |j^+, j^-, j, m+1\rangle, \\ L^- |j^+, j^-, j, m\rangle &= \sqrt{(j+m)(j-m+1)} |j^+, j^-, j, m-1\rangle, \\ K^3 |j^+, j^-, j, m\rangle &= \\ \alpha_j \sqrt{j^2 - m^2} |j^+, j^-, j-1, m\rangle &+ \gamma_j m |j^+, j^-, j, m\rangle - \alpha_{j+1} \sqrt{(j+1)^2 - m^2} |j^+, j^-, j+1, m\rangle, \\ K^+ |j^+, j^-, j, m\rangle &= \alpha_j \sqrt{(j-m)(j-m-1)} |j^+, j^-, j-1, m+1\rangle \\ &+ \gamma_j \sqrt{(j-m)(j+m+1)} |j^+, j^-, j, m+1\rangle \\ &+ \alpha_{j+1} \sqrt{(j+m+1)(j+m+2)} |j^+, j^-, j+1, m+1\rangle, \\ K^- |j^+, j^-, j, m\rangle &= -\alpha_j \sqrt{(j+m)(j+m-1)} |j^+, j^-, j-1, m-1\rangle \\ &+ \gamma_j \sqrt{(j+m)(j-m+1)} |j^+, j^-, j, m-1\rangle \\ &- \alpha_{j+1} \sqrt{(j-m+1)(j-m+2)} |j^+, j^-, j+1, m-1\rangle, \end{aligned} \quad (124)$$

where

$$\gamma_j = \frac{j^+(j^+ + 1) - j^-(j^- + 1)}{j(j + 1)} \quad \alpha_j = \sqrt{\frac{(j^2 - (j^+ + j^- + 1)^2)(j^2 - (j^+ - j^-)^2)}{j^2(4j^2 - 1)}}. \quad (125)$$

The previous equations will be important in what follows: they will allow for the characterisation of the solutions of the quantum simplicity constraints in a direct manner. This concludes the review of the representation theory that is necessary for the definition of the EPRL model.

7.2 The linear simplicity constraints

As first shown in [176], the quadratic simplicity constraints (25) – and more precisely in their dual version presented below (154) – are equivalent in the discrete setting to the linear constraint on each face of a given tetrahedron

$$D_f^i = L_f^i - \frac{1}{\gamma} K_f^i \approx 0, \quad (126)$$

where the label f makes reference to a face $f \in \Delta^*$, and where (very importantly) the subgroup $SU(2) \subset Spin(4)$ that is necessary for the definition of the above constraints is chosen arbitrarily at each tetrahedron, equivalent on each edge $e \in \Delta^*$. Such choice of the rotation subgroup is the precise analog of the time gauge in the canonical analysis of Section 3. Moreover, the linear simplicity constraint above is the simplicial version of the canonical primary constraint (37). The EPRL model is defined by imposing the previous constraints as operator equations on the Hilbert spaces defined by the unitary irreducible representations of $Spin(4)$ that take part in the state-sum of BF theory. We will show in Section 7.4 that the models constructed on the requirement of a suitable imposition of the linear constraints (126) satisfy the usual quadratic Plebanski constraints in the path integral formulation (up to quantum corrections which are neglected in the usual semiclassical limit).

It will be useful in what follows to write the above constraint in its equivalent form

$$D_f^i = (1 - \gamma)J_f^{+i} - (1 + \gamma)J_f^{-i} \approx 0, \quad (127)$$

From the commutation relations (120) of previous section we can easily compute the commutator of the previous tetrahedron constraints and conclude that in fact it does not close, namely

$$\begin{aligned} [D_f^i, D_{f'}^j] &= \delta_{ff'} \epsilon^{ij}_k \left[\left(1 + \frac{1}{\gamma^2}\right) L_f^k - \frac{2}{\gamma} K_e^k \right] = \\ &= 2\delta_{ee'} \epsilon^{ij}_k D^k + \delta_{ee'} \frac{1 - \gamma^2}{\gamma^2} \epsilon^{ij}_k L_f^k. \end{aligned} \quad (128)$$

The previous commutation relations imply that the constraint algebra is not closed and cannot therefore be imposed as operator equations on the states summed over in the BF partition function in general. There are two interesting exceptions to the previous statement:

1. The first one is to take $\gamma = \pm 1$ in which case the constraint (187) can be imposed strongly. More precisely, for the plus sign it reduces to the condition $J_{f^+}^i = 0$ (or equivalently for the other sign $J_{f^-}^i = 0$) which amounts to setting all the left quantum numbers in the BF state-sum for the group $Spin(4)$ to zero. It is immediate to see that if we impose such restriction on the $Spin(4)$ BF amplitude (106) it simply reduces to the amplitude (102) defining $SU(2)$ BF theory. Thus, this possibility does not lead to an acceptable model for quantum gravity in 4d.

2. The second possibility is to work in the sector where $L_f^i = 0$. We will show later that this corresponds to the famous Barret-Crane model [53] with the various limitations discussed in Section 10.

The EPRL model is obtained by restricting the representations appearing in the expression of the BF partition function so that at each tetrahedron the linear constraints (187) the strongest possible way that is compatible with the uncertainties relations stemming from (188). In addition one would add the requirement that the state-space of tetrahedra is compatible with the state-space of the analogous excitation in the canonical context of LQG so that arbitrary states in the kinematical state of LQG have non trivial amplitudes in the model.

On the weak imposition of the linear simplicity constraints

We now discuss the weak imposition of the linear simplicity constraints in the quantum framework. There are essentially three views in the literature: two of them, discussed below, concerns directly the way the EPRL model has been usually introduced. The third possibility is the semiclassical view based on the coherent state representation leading to the FK model (see Section 9).

7.2.1 Riemannian model: The Gupta–Bleuler criterion

Due to the fact that the constraints D_f^i do not form a closed (first class) algebra in the generic case one needs to devise a weaker sense in which they are to be imposed. One possibility is to consider the Gupta–Bleuler criterion consisting in selecting a suitable class of states for which the matrix elements on D_f^i vanish. In this respect one notices that if we chose the subspace $\mathcal{H}_j \subset \mathcal{H}_{j^+, j^-}$ one has

$$\begin{aligned} \langle j^+, j^-, j, q | D_f^3 | j^+, j^-, j, m \rangle &= \delta_{q,m} m \left(1 - \frac{\gamma_j}{\gamma}\right) \\ \langle j^+, j^-, j, q | D_f^\pm | j^+, j^-, j, m \rangle &= \delta_{q \pm 1, m} \sqrt{(j \pm m + 1)(j \mp m)} \left(1 - \frac{\gamma_j}{\gamma}\right). \end{aligned}$$

One immediately observes that matrix elements of the linear constraints vanish in this subclass if one can chose

$$\gamma_j = \frac{j^+(j^+ + 1) - j^-(j^- + 1)}{j(j + 1)} = \gamma \quad (129)$$

There are two cases:

1. **Case $\gamma < 1$:** Following [136], in this case one restricts the $Spin(4)$ representations to

$$j^\pm = (1 \pm \gamma) \frac{j}{2}, \quad (130)$$

which amounts to choosing the *maximum weight* component $j = j^+ + j^-$ in the expansion (183). Simple algebra shows that condition (189) is met. There are indeed other solutions [134] of the Gupta–Bleuler criterion in this case.

2. **Case $\gamma > 1$:** In this case [13] one restricts the $Spin(4)$ representations to

$$j^\pm = (\gamma \pm 1) \frac{j}{2} + \frac{\gamma - 1}{2}, \quad (131)$$

which amounts to choosing the *minimum weight* component $j = j^+ - j^-$ in the expansion (183). This choice of j^\pm is the solution to condition (189).

7.2.2 Riemannian model: The Master constraint criterion

Another criterion for weak imposition can be developed by studying the spectrum of the Master constraint $M_f = D_f \cdot D_f$. Strong imposition of the constraints D_f^i would amount to looking for the kernel of the master constraint M_f . However, generically the positive operator associated with the master constraint does not contain the zero eigenvalue in the spectrum due to the open nature of the constraint algebra (188). The proposal of [160], that we follow here, is to look for the minimum eigenvalue among spaces $\mathcal{H}_j \in \mathcal{H}_{j^+, j^-}$. Explicitly

$$M_f |\psi\rangle = m_{j^\pm, j} |\psi\rangle, \quad (132)$$

where

$$m_{j^\pm, j} = (1 - \gamma)^2 j_+(j_+ + 1) + (1 + \gamma^2) j_-(j_- + 1) - (1 - \gamma^2) [j(j + 1) - j_+(j_+ + 1) - j_-(j_- + 1)]$$

There are two cases:

1. **Case $\gamma < 1$:** In this case the minimum eigenvalue is obtained for

$$j^\pm = (1 \pm \gamma)j/2, \quad (133)$$

i.e., one has

$$m_{j^\pm, j} \geq m_j$$

where $m_j = \hbar^2(1 - \gamma^2)j$ where we have restored the explicit dependence on \hbar so that it is apparent that the selected eigenvalue vanishes in the the semiclassical limit $\hbar \rightarrow 0$ and $k \rightarrow \infty$ with $\hbar k = \text{constant}$.

2. **Case $\gamma > 1$:** In this case the minimum eigenvalue is obtained for

$$j^\pm = (\gamma \pm 1)j/2, \quad (134)$$

for which $m_j = \hbar^2(\gamma^2 - 1)j$ and thus vanishes in the the semiclassical limit $\hbar \rightarrow 0$ and $k \rightarrow \infty$ with $\hbar k = \text{constant}$.

The master constraint criterion will be used here as the basic justification for the definition of the EPRL model. Notice however, that the master constraint is only invariant under the subgroup $SU(2) \subset Spin(4)$ chosen at each tetrahedron. Its lack of Lorentz invariance is clear from the fact that its validity is justified from the canonical analysis in the time gauge. Nevertheless, as shown in [326], one can also write down a criterion (equivalent to the master constraint one) in a manifestly $Spin(4)$ invariant way. This reflects the arbitrariness in the choice of the internal subgroup $SU(2) \subset Spin(4)$ and implies the consistency of the time gauge. In order to get a gauge invariant constraint one starts from the master constraint and uses the $D_f^i = 0$ classically to rewrite it entirely in terms of the $Spin(4)$ Casimirs, namely

$$\begin{aligned} M_f &= (1 - \gamma)^2 J_+^2 + (1 + \gamma)^2 J_-^2 - 2(1 - \gamma^2) J_+ \cdot J_- \\ &\approx (1 + \gamma^2) C_2 - 2C_1 \gamma, \end{aligned} \quad (135)$$

where C_1 and C_2 are the two $spin(4)$ Casimirs given in equation (121). The Lorentz invariant version of the master constraint is hence

$$M_f^{Lorentz} = (1 + \gamma^2) C_2 - 2C_1 \gamma = 0 \quad (136)$$

One can verify for the cases $\gamma < 1$ and $\gamma > 1$ the Lorentz invariant criterion is just equivalent to the master constraint analysis above.

7.2.3 Riemannian model: Restrictions on the Immirzi parameter

We have just shown how the states in \mathcal{H}_{j^+,j^-} can be restricted in order to satisfy the linear simplicity constraints according to different criteria. From all these the EPRL model is defined most simply using the Master constraint criterion. In all cases the restriction takes the form of the selection of a subspace $\mathcal{H}_j \subset \mathcal{H}_{j^+,j^-}$ given by unitary irreducible representations of a subgroup $SU(2) \in Spin(4)$. As we will show in what follows this implies that the boundary states of the spin foam models defined by the EPRL construction are in correspondence to $SU(2)$ spin network states: the states of the kinematical Hilbert space of LQG reviewed in Part II. This is very nice as it suggests that the spin foam amplitudes can be interpreted as dynamical transition amplitudes of the canonical quantum theory. Now in order for this to be so, one would like arbitrary spins $j \in \mathbb{N}/2$ to be admissible in the state sum. We shall see now that this imposes restrictions on the possible values of the Immirzi parameter. However, these restrictions seem so far of little physical importance as they are a special feature of the Riemannian model that is absent in its Lorentzian relative. As above there are two distinct cases:

1. **Case $\gamma < 1$:** If one wants the spin $j \in \mathbb{N}/2$ to be arbitrary then the only possibilities are $\gamma = 0$ or $\gamma = 1$. Rational γ values would restrict the spins j to a subclass in $\mathbb{N}/2$. This restriction is not natural from the viewpoint of LQG. Its relevance if any remains mysterious at this stage.
2. **Case $\gamma > 1$:** In this case $\gamma \in \mathbb{N}$ would allow any $j \in \mathbb{N}/2$. Rational choices of γ have the same effect as in the previous case.

7.2.4 Riemannian model: Overview of the solutions of the linear simplicity constraints

We have reviewed different criteria given in the literature for the definition of the subset of quantum states that are selected in the construction of the EPRL model. From all the criteria the Master constraint one is the most direct and clear-cut. For the Riemannian model the result is:

1. **Case $\gamma < 1$:**

$$j^\pm = (1 \pm \gamma)j/2, \quad (137)$$

2. **Case $\gamma > 1$:**

$$j^\pm = (\gamma \pm 1)j/2, \quad (138)$$

where $j \in \mathbb{N}/2$ is arbitrary – except from the requirement that $j^\pm \in \mathbb{N}/2$ which depends of the value of the Immirzi parameter according to the previous section. From now on we denote the subset of admissible representation of $Spin(4)$ as

$$\mathcal{K}_\gamma \subset \text{Irrep}(Spin(4)). \quad (139)$$

It follows from the discussion in the previous sections that for states $\Psi \in \mathcal{K}_\gamma$ satisfy the constraints (187) in the following semiclassical sense:

$$(K_f^i - \gamma L_f^i)\Psi = \mathcal{O}_{sc}, \quad (140)$$

where the symbol \mathcal{O}_{sc} (order semiclassical) denotes a quantity that vanishes in limit $\hbar \rightarrow 0$, $j \rightarrow \infty$ with $\hbar j = \text{constant}$. Equivalently one has

$$[(1 - \gamma)J_+^i - (1 + \gamma)J_-^i]\Psi = \mathcal{O}_{sc}. \quad (141)$$

This last equation can be written graphically as:

$$-(1+\gamma) \quad \quad \quad +(1-\gamma) \quad \quad \quad = \mathcal{O}_{sc} \quad (142)$$

The previous equation will be of great importance in the graphical calculus that will allow us to show that the linear constraint imposed here at the level of states imply the vanishing of the quadratic Plebanski constraints (25) and their fluctuations, computed in the path integral sense, in the appropriate large spin semiclassical limit.

7.3 Presentation of the EPRL amplitude

Here we complete the definition of the EPRL models by imposing the linear constraints on the BF amplitudes constructed in Section 6. We will also show that the path-integral expectation value of the Plebanski constraints (25), as well as their fluctuations, vanish in a suitable semiclassical sense. This shows that the EPRL model can be considered as a lattice definition of the a quantum gravity theory.

We start with the Riemannian model for which a straightforward graphical notation is available. The first step is the translation of Equation (122) in terms of the graphical notation introduced in Section 6. Concretely, for $\gamma < 1$ one has $j^\pm = (1 \pm \gamma)j/2 \in \mathcal{K}_\gamma$ —as defined in (139)—becomes

$$(1-\gamma)\frac{j}{2} \quad \quad \quad (1+\gamma)\frac{j}{2} \quad \quad \quad = \bigoplus_{\alpha=\gamma j}^j \quad \quad \quad (143)$$

For $\gamma > 1$ we have

$$(\gamma-1)\frac{j}{2} \quad \quad \quad (1+\gamma)\frac{j}{2} \quad \quad \quad = \bigoplus_{\alpha=j}^{\gamma j} \quad \quad \quad (144)$$

The implementation of the linear constraints of Section (7.2) consist in restricting the representations ρ_f of $Spin(4)$ appearing in the state sum amplitudes of BF theory as written in Equation (104) to the subclass $\rho_f \in \mathcal{K}_\gamma \subset \text{Irrep}(Spin(4))$, defined above, while projecting to the highest weight term in (143) for $\gamma < 1$. For $\gamma > 1$ one must take the minimum weight term in (144). The

action of this projection will be denoted $\mathcal{Y}_j : \mathcal{H}_{(1+\gamma)j/2, |(1-\gamma)j/2} \rightarrow \mathcal{H}_j$, graphically

$$\mathcal{Y}_j \left[\begin{array}{c} \left| \begin{array}{l} |\gamma - 1| \frac{j}{2} \\ (1 + \gamma) \frac{j}{2} \end{array} \right. \right] = \begin{array}{c} \text{diagram of a vertex with four edges} \\ \text{green edge labeled } j \\ \text{blue and red edges} \end{array} \quad . \quad (145)$$

Explicitly, one takes the expression of the BF partition function (95) and modifies it by replacing the projector $P_{inv}^e(\rho_1, \dots, \rho_4)$ with $\rho_1, \dots, \rho_4 \in \mathcal{H}_\gamma$ by a new object

$$P_{eprl}^e(j_1, \dots, j_4) \equiv P_{inv}^e(\rho_1 \dots \rho_4)(\mathcal{Y}_{j_1} \otimes \dots \otimes \mathcal{Y}_{j_4})P_{inv}^e(\rho_1 \dots \rho_4) \quad (146)$$

with $j_1, \dots, j_4 \in \mathbb{N}/2$ implementing the linear constraints described in the previous section. Graphically the modification of BF theory that produces the EPRL model corresponds to the replacement

$$P_{inv}^e(\rho_1 \dots \rho_4) = \begin{array}{c} \text{diagram of two boxes with four wires each} \end{array} \longrightarrow \begin{array}{c} \text{diagram of a central vertex with four wires} \\ \text{green wires labeled } j_1, \dots, j_4 \\ \text{blue and red wires} \end{array} \quad (147)$$

on the expression (104), where we have dropped the representation labels from the figure for simplicity. We have done the operation (145) on each an every of the four pairs of representations. The $Spin(4)$ integrations represented by the two boxes at the top and bottom of the previous graphical expression restore the full $Spin(4)$ invariance as the projection (145) breaks this latter symmetry for being based on the selection of a special subgroup $SU(2) \subset Spin(4)$ in its definition (see section 7.5 for an important implication). One should simply keep in mind that green wires in the previous two equations and in what follows are labeled by arbitrary spins j (which are being summed over in the expression of the amplitude (148)), while red and blue wires are labelled by $j^+ = (1 + \gamma)j/2$ and $j^- = |1 - \gamma|j/2$ respectively. With this (104) is modified to

$$\begin{aligned} Z_{eprl}^E(\Delta) &= \sum_{\rho_f \in \mathcal{H}} \prod_{f \in \Delta^*} d_{|1-\gamma|\frac{j}{2}} d_{(1+\gamma)\frac{j}{2}} \prod_e P_{eprl}^e(j_1, \dots, j_4) = \\ &= \sum_{\rho_f \in \mathcal{H}} \prod_{f \in \Delta^*} d_{|1-\gamma|\frac{j}{2}} d_{(1+\gamma)\frac{j}{2}} \begin{array}{c} \text{diagram of a complex network of wires} \\ \text{blue, red, and green wires connecting vertices} \end{array} \quad , \quad (148) \end{aligned}$$

The previous expression is defines the EPRL model amplitude.

7.3.1 The spin foam representation of the EPRL amplitude

Now we will work out the spin foam representation of the EPRL amplitude which at this stage will take no much more effort than the derivation of the spin foam representation for $Spin(4)$ BF

theory as we went from equation (104) to (106) in Section 6. The first step is given in the following equation

$$= \sum_l \text{ (diagram with green box } l \text{ and red box } \bar{l} \text{) } \quad (149)$$

which follows basically from the invariance of the Haar measure (84)(in the last line we have used (100)). More precisely, the integration of the subgroup $SU(2) \in Spin(4)$, represented by the green box on the right, can be absorbed by suitable redefinition of the integration of the integration of the red and blue boxes respectively. With this we can already write the spin foam representation of the EPRL model, namely

$$Z_{eprl}^E(\Delta) = \sum_{j_f} \sum_{\iota_e} \prod_{f \in \Delta^*} d_{|1-\gamma| \frac{j}{2}} d_{(1+\gamma) \frac{j}{2}} \prod_{v \in \Delta^*} \text{ (diagram with 5 green boxes } \iota_1, \dots, \iota_5 \text{) } \quad (150)$$

where the vertex amplitude (graphically represented) depends on the 10 spins j associated to the face-wires and the 5 intertwiners associated to the five edges (tetrahedra). As in previous equations we have left the spin labels of wires implicit for notational simplicity. We can write the previous spin foam amplitude in another form by integrating out all the projectors (boxes) explicitly. Using, (100) we get

$$= \sum_{\iota_+ + \iota_- = \iota} \dots \quad (151)$$

thus replacing this in (148) we get

$$Z_{epri}^E(\Delta) = \sum_{j_f} \prod_{f \in \Delta^*} d_{|\gamma-1| \frac{j_f}{2}} d_{(\gamma+1) \frac{j_f}{2}} \sum_{\iota_e} \prod_{v \in \Delta^*} \dots \quad (152)$$

$$\sum_{\iota_1^- \dots \iota_5^-} \sum_{\iota_1^+ \dots \iota_5^+} \prod_{a=1}^5 f_{\iota_a^-, \iota_a^+}^{\iota_a} \dots \quad (152)$$

where the coefficients $f_{\iota_+ \iota_-}^\iota$ are the so-called fusion coefficients which appear in their graphical form already in (151), more explicitly

$$f_{\iota_+ \iota_-}^\iota(j_1, \dots, j_4) = \dots \quad (153)$$

The previous is the form of the EPRL model as derived in [158].

7.4 Proof of validity of the Plebanski constraints

In this section we prove that the quadratic constraints are satisfied in the sense that their path integral expectation value and fluctuation vanish in the appropriate semiclassical limit.

7.4.1 The dual version of the constraints

In this section we rewrite the Plebanski constraints (25) in an equivalent version where spacetime indices are traded with internal Lorentz indices, namely

$$\epsilon_{IJKL} B_{\mu\nu}^{IJ} B_{\rho\sigma}^{KL} - e \epsilon_{\mu\nu\rho\sigma} \approx 0. \quad (154)$$

The constraints in this form are more suitable for the translation into the discrete formulation. More precisely, according to (81), the smooth fields $B_{\mu\nu}^{IJ}$ is now associated with the discrete quantities $B_{\text{triangles}}^{IJ}$, or equivalently B_f^{IJ} as, we recall, faces $f \in \Delta^*$ are in one-to-one correspondence to triangles in four dimensions. The constraints (154) are local constraints valid at every spacetime point. In the discrete setting, spacetime points are represented by four-simplexes or (more adapted to our discussion) vertices $v \in \Delta^*$. With all this the constraints (154) are discretized as follows:

$$\textbf{Triangle (or diagonal) constraints:} \quad \epsilon_{IJKL} B_f^{IJ} B_f^{KL} = 0, \quad (155)$$

for all $f \in v$, i.e., for each and every face of the 10 possible faces touching the vertex v .

$$\textbf{Tetrahedron constraints:} \quad \epsilon_{IJKL} B_f^{IJ} B_{f'}^{KL} = 0, \quad (156)$$

for all $f, f' \in v$ such that they are dual to triangles sharing a one-simplex, i.e., belonging to the same tetrahedron out of the five possible ones.

$$\textbf{4-simplex constraints:} \quad \epsilon_{IJKL} B_f^{IJ} B_{\bar{f}}^{KL} = e_v, \quad (157)$$

for any pair of faces $f, \bar{f} \in v$ that are dual to triangles sharing a single point. The last constraint will require a more detailed discussion. At this point let us point out that the constraint (157) is interpreted as a definition of the four volume e_v of the four-simplex. The constraint requires that such definition be consistent, i.e., the true condition is

$$\epsilon_{IJKL} B_f^{IJ} B_{\bar{f}}^{KL} = \epsilon_{IJKL} B_{f'}^{IJ} B_{\bar{f}'}^{KL} = \epsilon_{IJKL} B_{f''}^{IJ} B_{\bar{f}''}^{KL} = \dots = e_v \quad (158)$$

for all five different possible pairs of f and \bar{f} in a four simplex, and where we assume the pairs f - \bar{f} are ordered in agreement with the orientation of the complex Δ^* .

7.4.2 The path integral expectation value of the Plebanski constraints

Here we prove that the Plebanski constraint are satisfied by the EPRL amplitudes in the path integral expectation value sense.

The triangle constraints:

We start from the simplest case: the triangle (or diagonal) constraints (155). We choose a face $f \in v$ (dual to a triangle) in the cable-wire-diagram of Equation (148). This amounts to choosing a pair of wires (right and left representations) connecting two nodes in the vertex cable wire diagram. The two nodes are dual to the two tetrahedra – in the four simplex dual to the vertex – sharing the chosen triangle. From (29) one can show that

$$\epsilon_{IJKL} B_f^{IJ} B_f^{KL} \propto (1 + \gamma)^2 J_f^- \cdot J_f^- - (1 - \gamma)^2 J_f^+ \cdot J_f^+, \quad (159)$$

where J_f^\pm denotes the self-dual and anti-self-dual parts of $\Pi_f^I J$. The path integral expectation value of the triangle constraint is then

$$\langle (1 + \gamma)^2 J_f^- \cdot J_f^- - (1 - \gamma)^2 J_f^+ \cdot J_f^+ \rangle \propto \quad (160)$$

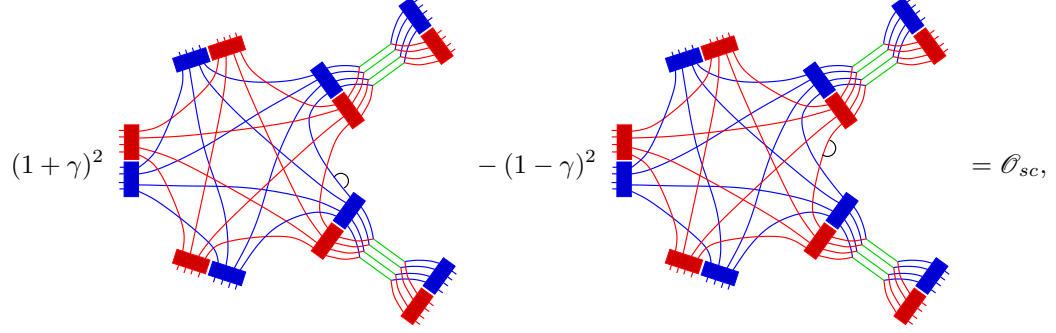

where the double grasplings on the anti-self-dual (blue) wire and the self-dual (red) wire represent the action of the Casimirs $J_f^- \cdot J_f^-$ and $J_f^+ \cdot J_f^+$ on the cable-wire diagram of the corresponding vertex. Direct evaluation shows that the previous diagram is proportional to $\hbar^2 j_f$ which vanishes in the semiclassical limit $\hbar \rightarrow 0, j \rightarrow \infty$ with $\hbar j = \text{constant}$. We use the notation already adopted in (140) and call such quantity \mathcal{O}_{sc} . This concludes the proof that the triangle Plebanski constraints are satisfied in the semiclassical sense.

The tetrahedra constraints:

The proof of the validity of the tetrahedra constraints (156). In this case we also have

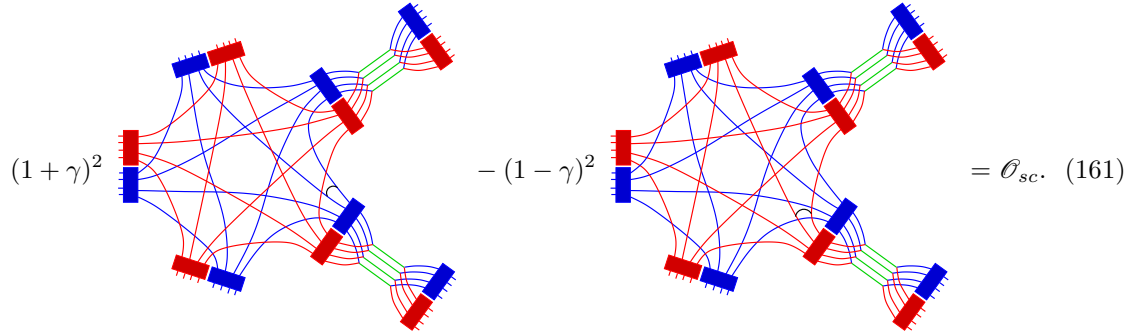

where we have chosen an arbitrary pair of faces. In order to prove this let us develop the term on the right. The result follows from

$$\begin{aligned}
& \text{Diagram 1} = \text{Diagram 2} = \\
& = \frac{(1+\gamma)}{|1-\gamma|} \text{Diagram 3} + \mathcal{O}_{sc} = \frac{(1+\gamma)^2}{(1-\gamma)^2} \text{Diagram 4} + \mathcal{O}_{sc} = \\
& = \frac{(1+\gamma)^2}{(1-\gamma)^2} \text{Diagram 5} + \mathcal{O}_{sc}, \tag{162}
\end{aligned}$$

where in the first line we have used the fact that the double grasping can be shifted through the group integration (due to gauge invariance (84)), and in the first and second terms on the second line we have used Equation (142) to move the grasplings on self-dual wires to the corresponding anti-self-dual wires. Equation (161) follows immediately from the previous one; the argument works in the same way for any other pair of faces. Notice that the first equality in Equation (162) implies that we can view the Plebanski constraint as applied in the frame of the tetrahedron as well as in a Lorentz invariant framework (the double grasping defines an intertwiner operator commuting with the projection P_{inv}^e represented by the box). An analogous statement also holds for the triangle constraints (14.1).

The 4-simplex constraints

Now we show the validity of the four simplex constraints in their form (158). As we show below, this last set of constraints follow from the $Spin(4)$ gauge invariance of the EPRL node (i.e., the validity of the Gauss law) plus the validity of the tetrahedra constraints (156). Gauge invariance of the node takes the following form in graphical notation

$$\text{Diagram 1} + \text{Diagram 2} + \text{Diagram 3} + \text{Diagram 4} = 0, \tag{163}$$

where the above equation represents the gauge invariance under infinitesimal left $SU(2)$ rotations. An analogous equation with insertions on the right is also valid. The validity of the previous equation can again be related to the invariance of the Haar measure used in the integration on the gauge group that defines the boxes (84).

Now we chose an arbitrary pair f and \bar{f} (where, recall, \bar{f} is one of the three possible faces whose dual triangle only shares a point with the corresponding to f) and will show how the four volumen e_v defined by it equals the one defined by any other admissible pair. The first step is to show that we get the same result using the pair $f-\bar{f}$ and $f-\bar{f}$, where \bar{f} is another of the three admissible faces opposite to f . The full result follows from applying the same procedure iteratively to reach any admissible pair. It will be obvious from the treatment given below that this is possible. Thus, for

a given pair of admissible faces we have

$$\begin{aligned}
 & e_v = (1 + \gamma)^2 \text{ [Diagram 1]} - (1 - \gamma)^2 \text{ [Diagram 2]} = \\
 & - (1 + \gamma)^2 \left[\text{[Diagram 3]} + \text{[Diagram 4]} + \text{[Diagram 5]} \right] + \\
 & + (1 - \gamma)^2 \left[\text{[Diagram 6]} + \text{[Diagram 7]} + \text{[Diagram 8]} \right] = \\
 & - (1 + \gamma)^2 \text{ [Diagram 9]} + (1 - \gamma)^2 \text{ [Diagram 10]} + \mathcal{O}_{sc}, \tag{164}
 \end{aligned}$$

where going from the first line to the second and third lines we have simply used (163) on the bottom graspings on the right and left wires. The last line results from the validity of (156): notice that the second terms in the second and third lines add up to \mathcal{O}_{sc} as well as the third terms in the second and third line. There is an overall minus sign which amounts for an orientation factor. It should be clear that we can apply the same procedure to arrive at any admissible pair.

7.5 Modifications of the EPRL model

7.5.1 P_{eprl} is not a projector

Let us study in a bit more detail the object $P_{eprl}^e(j_1, \dots, j_4)$. We see that it is made of two ingredients. The first one is the projection to the maximum weight subspace \mathcal{H}_j for $\gamma > 1$ in the decomposition of \mathcal{H}_{j^+, j^-} for $j^\pm = (1 \pm \gamma)j/2$ ($j^\pm = (\gamma \pm 1)j/2$ for $\gamma > 1$) in terms of irreducible representations of an arbitrarily chosen $SU(2)$ subgroup of $Spin(4)$. The second ingredient is to eliminate the dependence on the choice of subgroup by group averaging with respect to the full gauge group $Spin(4)$. This is diagrammatically represented in (147). However $P_{eprl}^e(j_1, \dots, j_4)$ is not a projector, namely

$$P_{eprl}^e(j_1, \dots, j_4)^2 \neq P_{eprl}^e(j_1, \dots, j_4). \quad (165)$$

Technically this follows from (146) and the fact that

$$[P_{inv}^e(\rho_1 \cdots \rho_4), (\mathcal{Y}_{j_1} \otimes \cdots \otimes \mathcal{Y}_{j_4})] \neq 0 \quad (166)$$

i.e., the projection imposing the linear constraints (defined on the frame of a tetrahedron or edge) and the $Spin(4)$ (or Lorentz) group averaging – rendering the result gauge invariant – do not commute. The fact the $P_{eprl}^e(j_1, \dots, j_4)$ is not a projection operator has important consequences in the mathematical structure of the model:

1. From (148) one can immediately obtain the following expression for the EPRL amplitude

$$Z_{eprl}(\Delta) = \sum_{\rho_f \in \mathcal{K}} \prod_{f \in \Delta^*} d_{|1-\gamma|\frac{j}{2}} d_{(1+\gamma)\frac{j}{2}} \prod_e P_{eprl}^e(j_1, \dots, j_4). \quad (167)$$

This expression has the formal structure of expression (95) for BF theory. The formal similarity however is broken by the fact that $P_{eprl}^e(j_1, \dots, j_4)$ is not a projection operator. From the formal perspective is the possibility that the amplitudes be defined in term of a network of projectors (as in BF theory) might provide an interesting structure that might be of relevance in the definition of a discretization independent model (see discussion in Part V). On the contrary, the failure of $P_{eprl}^e(j_1, \dots, j_4)$ to be a projector may lead, in my opinion, to difficulties in the limit where the complex Δ is refined: the increasing of the number of edges might produce either trivial or divergent amplitudes ²⁴.

2. Another difficulty associated with $P_{eprl}^e(j_1, \dots, j_4)^2 \neq P_{eprl}^e(j_1, \dots, j_4)$ is the failure of the amplitudes of the EPRL model, as defined here, to be consistent with the abstract notion of spin foams as defined in [34]. This is a point of crucial importance under current discussion in the community. The point is that the cellular decomposition Δ has no physical meaning and is to be interpreted as a subsidiary regulating structure to be removed when computing physical quantities. Spin foams (as defined in Section 5) can fit in different ways on a given Δ , yet any of these different embeddings represent the same physical process (like the same gravitational field in different coordinates). Consistency requires the spin foam amplitudes to be independent of the embedding, i.e., well defined on the equivalence classes of spin foams as defined by Baez in [34] (the importance of these consistency requirements was emphasized in [84]). The amplitude (167) fails this requirement due to $P_{eprl}^e(j_1, \dots, j_4)^2 \neq P_{eprl}^e(j_1, \dots, j_4)$.

²⁴This is obviously not clear from the form of (167). We are extrapolating the properties of $(P_{eprl}^e)^N$ for large N to those of the amplitude (167) in the large number of edges limit implied by the continuum limit.

7.5.2 The Warsaw proposal

The above difficulties have a simple solution in the Riemannian case. As proposed in [45, 229] one can obtain a consistent modification of the EPRL model by replacing P_{eprl}^e in (167) by a genuine projector P_w^e , graphically

$$\begin{aligned}
 P_{eprl}^e(j_1 \cdots j_4) &= \text{Diagram 1} = \sum_{\alpha} \text{Diagram 2} \\
 &\longrightarrow P_w^e(j_1 \cdots j_4) = \sum_{\alpha\beta} g_{\alpha\beta}^e \text{Diagram 3}, \tag{168}
 \end{aligned}$$

where

$$g_{\alpha\beta}^e = \left(\sum_{\iota^+ \iota^-} f_{\iota^+ \iota^-}^{\alpha} f_{\iota^+ \iota^-}^{\beta} \right)^{-1} = \text{Inverse} \left(\alpha \text{ Diagram } \beta \right).$$

It is easy to check that by construction

$$(P_w^e(j_1 \cdots j_4))^2 = P_w^e(j_1 \cdots j_4). \tag{169}$$

The variant of the EPRL model proposed in [45, 229] takes then the form

$$Z_{eprl}(\Delta) = \sum_{j_f} \prod_{f \in \Delta^*} d_{|1-\gamma| \frac{i}{2}} d_{(1+\gamma) \frac{i}{2}} \prod_e P_w^e(j_1, \cdots, j_4) \tag{170}$$

$$= \sum_{j_f} \sum_{\iota_{ev}} \prod_{f \in \Delta^*} d_{|1-\gamma| \frac{i}{2}} d_{(1+\gamma) \frac{i}{2}} \prod_{e \in \Delta^*} g_{\iota_{v_s}^e \iota_{v_t}^e}^e \prod_{v \in \Delta^*} \text{Diagram}$$

Thus in the modified EPRL model edges $e \in \Delta^*$ are assigned pairs of intertwiner quantum numbers $\iota_{v_s}^e$ and $\iota_{v_t}^e$ and an edge amplitude given by the matrix elements $g_{\iota_{v_s}^e \iota_{v_t}^e}^e$ (where v_s and v_t stand for the source and target vertices of the given oriented edge). The fact that edges are not assigned a

single quantum number is not really significant; one could go to a basis of normalized eigenstates of P_w^e and rewrite the modified model above as a spin foam model where edges are assigned a single (basis element) quantum number. As the nature of such basis and the quantum geometric interpretation of its elements is not clear at this stage, it seems simpler to represent the amplitudes of the modified model in the above form.

The advantages of the modified model are important,; however, a generalization of the above modification of the EPRL model in the Lorentzian case is still lacking. Notice that this modification does not interfere with the results on the semiclassical limit (to leading order) as reviewed in Section 13. The reason is that the matrix elements $g_{\alpha\beta}^e \rightarrow \delta_{\alpha\beta}$ in that limit [1].

7.6 The coherent states representation

We have written the amplitude defining the EPRL model by constraining the state sum of BF theory. For semiclassical studies that we will review in Section 13 it is convenient to express the EPRL amplitude in terms of the coherent states basis. The importance of coherent states in spin foam models was put forward in [246] and explicitly used to re-derive the EPRL model in [247]. The coherent state technology was used by Freidel and Krasnov in [176] to introduce a new kind of spin foam models for gravity: the FK models. In some cases the FK model is equivalent to the EPRL model; we will review this in detail in Section 9.

The coherent state representation of the EPRL model is obtained by replacing (113) in each of the intermediate $SU(2)$ (green) wires in the expression (148) of the EPRL amplitudes, namely

$$= \int_{[S^2]^4} \prod_{I=1}^4 d_{j_I} dn_I \quad (171)$$

The case $\gamma < 1$

In this case the coherent state property (114) implies

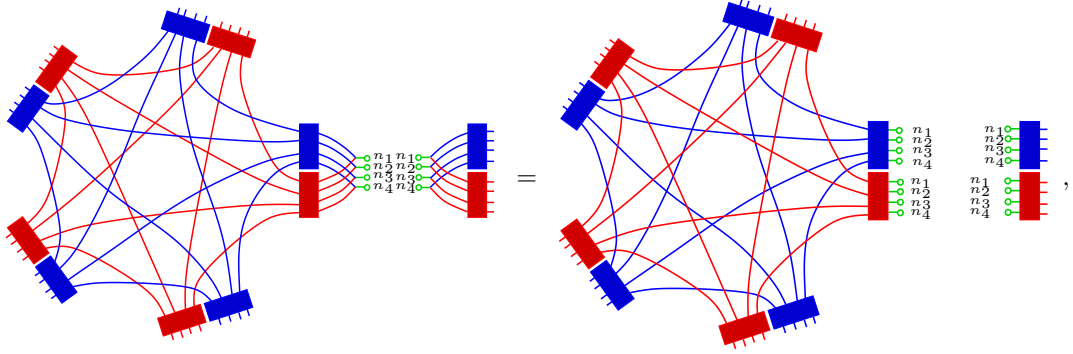

(172)

where we used in the last line the fact that for $\gamma < 1$ the representations j of the subgroup $SU(2) \in Spin(4)$ are maximum weight, i.e., $j = j^+ + j^-$. Doing this at each edge we get

$$Z_{epri}^E(\Delta) = \sum_{j_f} \prod_{f \in \Delta^*} d_{j_f^-} d_{j_f^+}$$

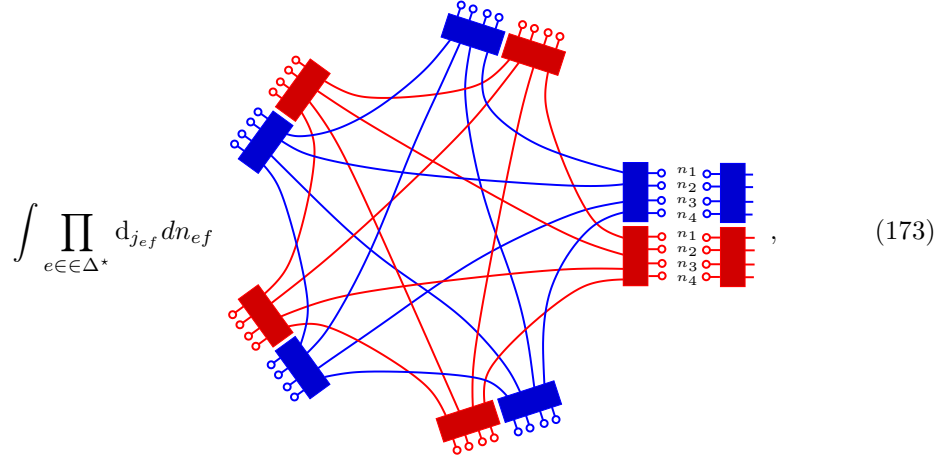

(173)

where we have explicitly written the $n \in S^2$ integration variables on a single cable. The expression above is very similar to the coherent states representation of $Spin(4)$ BF theory given in Equation (115). In fact one would get the above expression if one would start from the expression (115) and would set $n_{ef}^+ = n_{ef}^- = n_{ef}$ while dropping for example all the sphere integrations corresponding to the n_{ef}^+ (or equivalently n_{ef}^-). Moreover, by construction the coherent states participating in the previous amplitude satisfy the linear constraints (127) in expectation values, namely

$$\begin{aligned} \langle j, n_{ef} | D_f^i | j, n_{ef} \rangle &= \\ &= \langle j, n_{ef} | (1 - \gamma) J_f^{+i} + (1 + \gamma) J_f^{-i} | j, n_{ef} \rangle = 0. \end{aligned} \quad (174)$$

Thus the coherent states participating in the above representation of the EPRL amplitudes solve the linear simplicity constraints in the usual semiclassical sense. The same manipulations leading to (176) in Section 6 lead to a discrete effective action for the EPRL model, namely

$$Z_{epri}^{\gamma < 1} = \sum_{j_f} \prod_{f \in \Delta^*} d_{(1-\gamma)\frac{j_f}{2}} d_{(1+\gamma)\frac{j_f}{2}} \int \prod_{e \in \Delta^*} d_{j_{ef}} dn_{ef} dg_{ev}^- dg_{ev}^+ \exp(S_{j_{\pm}, \mathbf{n}}^{\gamma < 1}[g^{\pm}]), \quad (175)$$

where the discrete action

$$S_{j^\pm, \mathbf{n}}^{\gamma < 1}[g^\pm] = \sum_{v \in \Delta^*} (S_{(1-\gamma)\frac{j_f}{2}, \mathbf{n}}^v[g^-] + S_{(1+\gamma)\frac{j_f}{2}, \mathbf{n}}^v[g^+]) \quad (176)$$

with

$$S_{j, \mathbf{n}}^v[g] = \sum_{a < b=1}^5 2j_{ab} \ln \langle n_{ab} | g_a^{-1} g_b | n_{ba} \rangle, \quad (177)$$

and the indices a, b label the five edges of a given vertex. The previous expression is exactly equal to the form (86) of the BF amplitude. In the case of the gravity models presented here, the coherent state path integral representation (analogous to (117)) will be the basic tool for the study of the semiclassical limit of the models and the relationship with Regge discrete formulation of general relativity.

The case $\gamma > 1$

The case $\gamma > 1$ is more complicated [55]. The reason is that the step (172) directly leading to the discrete action in the previous case is no longer valid as the representations of the subgroup $SU(2) \in Spin(4)$ are now minimum instead of maximum weight. However, the representations $j^+ = j^- + j$ are maximum weight. We can therefore insert coherent states resolution of the identity on the right representations and get:

$$= \int_{[S^3]^4} \prod_{I=1}^4 d_{(1+\gamma)\frac{j_I}{2}} dm_I \quad (178)$$

where we are representing the relevant part of the diagram appearing in equation (171). In the last line we have used that $j^+ = j + j^-$ (i.e. maximum weight), and the graphical notation $m \text{---} \text{---} n \equiv \langle m|n \rangle$ as it follows from our previous conventions. With all this, one gets

$$Z_{eprl}^{\gamma > 1} = \sum_{j_f} \prod_{f \in \Delta^*} d_{(1-\gamma)\frac{j_f}{2}} d_{(1+\gamma)\frac{j_f}{2}} \int \prod_{e \in \Delta^*} d_{j_{ef}} d_{(1+\gamma)\frac{j_{ef}}{2}} dn_{ef} dm_{ef} dg_{ev}^- dg_{ev}^+ \exp(S_{j^\pm, \mathbf{n}, \mathbf{m}}^{\gamma > 1}[g^\pm]), \quad (179)$$

where the discrete action

$$S_{j^\pm, \mathbf{n}, \mathbf{m}}^{\gamma > 1}[g^\pm] = \sum_{v \in \Delta^*} S_{j^\pm, \mathbf{n}, \mathbf{m}}^v[g^\pm] \quad (180)$$

with

$$S_{j^\pm, \mathbf{n}, \mathbf{m}}^v[g^\pm] = \sum_{1 \leq a < b \leq 5} j_{ab}(1 + \gamma) \log(\langle m_{ab} | g_{ab}^+ | m_{ba} \rangle) + j_{ab}(\gamma - 1) \log(\langle m_{ab} | g_{ab}^- | m_{ba} \rangle) + 2j_{ab}(\log(\langle n_{ab} | m_{ab} \rangle) + \log(\langle m_{ba} | n_{ba} \rangle)). \quad (181)$$

7.7 Some additional remarks

It is important to point out that the commutation relations of basic fields—reflecting the simple algebraic structure of $spin(4)$ —used here is the one induced by the canonical analysis of BF theory presented previously. The presence of constraints generally modifies canonical commutation relations in particular in the presence of second class constraints. For some investigation of the issue in the context of the EPRL and FK models see [13]. In [11] it is pointed out that the presence of secondary constraints in the canonical analysis of Plebanski action should translated in additional constraints in the holonomies of the spin foam models here considered (see also [12]). A possible view is that the simplicity constraints are here imposed *for all times* and thus secondary constraints should be imposed automatically.

There are alternative derivations of the models presented in the previous sections. In particular one can derive them from a strict Lagrangean approach of Plebanski's action. Such viewpoint is taken in [86, 85, 91]. The path integral formulation of Plebanski theory using commuting B -fields was studied in [212], where it is shown that only in the appropriate semiclassical limit the amplitudes coincide with the ones presented in the previous sections (this is just another indication that the construction of the models have a certain semiclassical input; see below). The spin foam quantization of the Holst formulation of gravity via cubulations was investigated in [48]. The simplicity constraints can also be studied from the perspective of the $U(N)$ formulation of quantum geometry [153, 155, 154] which also has been explored in the Lorentzian sector [150]. Such $U(N)$ treatment is related to previous work which has been extended to a completely new perspective on quantum geometry with possible advantageous features [98, 249]. For additional discussion on the simplicity constraints see [143].

8 The Lorentzian EPRL Model: Representation Theory and Simplicity Constraints

In this section we introduce some elements of $SL(2, \mathbb{C})$ representation theory and show how the so called linear simplicity constraints are solved in the Lorentzian EPRL model [294, 161, 158].

8.1 Representation theory of $SL(2, \mathbb{C})$ and the canonical basis

Unitary irreducible representations $\mathcal{H}_{p,k}$ of $SL(2, \mathbb{C})$ are infinite dimensional and are labelled by a positive real number $p \in \mathbb{R}^+$ and a half-integer $k \in \mathbb{N}/2$. The two Casimirs are $C_1 = \frac{1}{2} J_{IJ} J^{IJ} = L^2 - K^2$ and $C_2 = \frac{1}{2} \star J_{IJ} J^{IJ} = K \cdot L$ where L^i are the generators of an arbitrary rotation subgroup and K^i are the generators of the corresponding boosts. The Casimirs act on $|p, k\rangle \in \mathcal{H}_{p,k}$ as follows

$$\begin{aligned} C_1 |p, k\rangle &= (k^2 - p^2 - 1) |p, k\rangle \\ C_2 |p, k\rangle &= 2pk |p, k\rangle. \end{aligned} \quad (182)$$

For detail on the representation theory of $SL(2, \mathbb{C})$ see [331, 196, 197]. As in the Riemannian case, the definition of the EPRL model requires the introduction of an (arbitrary) subgroup $SU(2) \subset SL(2, \mathbb{C})$. This subgroup correspond to the internal gauge group of the gravitational phase space

in connection variables in the time gauge. In the quantum theory, the representation theory of this $SU(2)$ subgroup will be hence important. This importance will soon emerge as apparent from the imposition of the constraints that define the EPRL. The link between the unitary representations of $SL(2, \mathbb{C})$ and those of $SU(2)$ is given by the decomposition

$$\mathcal{H}_{p,k} = \bigoplus_{j=k}^{\infty} \mathcal{H}_j. \quad (183)$$

As the unitary irreducible representations of the subgroup $SU(2) \in SL(2, \mathbb{C})$ are essential in understanding the link of the EPRL model and the operator canonical formulation of LQG it will be convenient to express the action of the generators of the Lie algebra $sl(2, \mathbb{C})$ in a basis adapted to the above equation. In order to do this we first notice that the Lie algebra (120) can be equivalently characterized in terms of the generators of the rotation subgroup L^i and the remaining *boost* generators K^i as follows

$$\begin{aligned} [L_3, L_{\pm}] &= \pm L_{\pm} & [L_+, L_-] &= 2 L_3 \\ [L_+, K_+] &= [L_-, K_-] = [L_3, K_3] & &= 0 \\ [K_3, L_{\pm}] &= \pm K_{\pm} & [L_{\pm}, K_{\mp}] &= \pm 2 K_3 & [L_3, K_{\pm}] &= \pm K_{\pm} \\ [K_3, K_{\pm}] &= \mp L_{\pm} & [K_+, K_-] &= -2 L_3, \end{aligned} \quad (184)$$

where $K_{\pm} = K^1 \pm iK^2$ and $L_{\pm} = L^1 \pm iL^2$ respectively. The action of the previous generators in the basis $|p, k, j, m\rangle$ can be shown to be [197]

$$\begin{aligned} L^3 |p, k, j, m\rangle &= m |p, k, j, m\rangle, \\ L^+ |p, k, j, m\rangle &= \sqrt{(j+m+1)(j-m)} |p, k, j, m+1\rangle, \\ L^- |p, k, j, m\rangle &= \sqrt{(j+m)(j-m-1)} |p, k, j, m-1\rangle, \\ K^3 |p, k, j, m\rangle &= \alpha_j \sqrt{j^2 - m^2} |p, k, j-1, m\rangle + \gamma_j m |p, k, j, m\rangle - \alpha_{j+1} \sqrt{(j+1)^2 - m^2} |p, k, j+1, m\rangle, \\ K^+ |p, k, j, m\rangle &= \alpha_j \sqrt{(j-m)(j-m-1)} |p, k, j-1, m+1\rangle \\ &+ \gamma_j \sqrt{(j-m)(j+m+1)} |p, k, j, m+1\rangle \\ &+ \alpha_{j+1} \sqrt{(j+m+1)(j+m+2)} |p, k, j+1, m+1\rangle, \\ K^- |p, k, j, m\rangle &= -\alpha_j \sqrt{(j+m)(j+m-1)} |p, k, j-1, m-1\rangle \\ &+ \gamma_j \sqrt{(j+m)(j-m+1)} |p, k, j, m-1\rangle \\ &- \alpha_{j+1} \sqrt{(j-m+1)(j-m+2)} |p, k, j+1, m-1\rangle, \end{aligned} \quad (185)$$

where

$$\gamma_j = \frac{kp}{j(j+1)} \quad \alpha_j = i \sqrt{\frac{(j^2 - k^2)(j^2 + p^2)}{j^2(4j^2 - 1)}} \quad (186)$$

This concludes the review of the representation theory that is necessary for the definition of the EPRL model.

8.2 Lorentzian model: the linear simplicity constraints

As in the Riemannian case it can be shown as in Section (7.4) that the quadratic simplicity constraints (154) are implied, in the discrete setting, by the linear constraint on each face

$$D_f^i = L_f^i - \frac{1}{\gamma} K_f^i \approx 0, \quad (187)$$

where the label f makes reference to a face $f \in \Delta^*$, and where (very importantly) the subgroup $SU(2) \subset SL(2, \mathbb{C})$ that is necessary for the definition of the above constraints is chosen arbitrarily at each tetrahedron, equivalent on each edge $e \in \Delta^*$. The commutation relations of the previous tetrahedron constraint are

$$\begin{aligned} [D_f^i, D_{f'}^j] &= \delta_{ff'} \epsilon_k^{ij} \left[\left(1 - \frac{1}{\gamma^2}\right) L_f^k - \frac{2}{\gamma} K_e^k \right] = \\ &= 2\delta_{ee'} \epsilon_k^{ij} D^k - \delta_{ee'} \frac{\gamma^2 + 1}{\gamma^2} \epsilon_k^{ij} L_f^k. \end{aligned} \quad (188)$$

The previous commutation relation implies that the constraint algebra is not closed and cannot therefore be imposed as operator equations of the states summed over in the BF partition function in general. There are two interesting exceptions:

1. The first one is to take $\gamma = \pm i$ in which case the constraint (187) could in principle be imposed strongly. The self-dual sector is however not present in $\mathcal{H}_{p,k}$.
2. The second possibility is to work in the sector where $L_e^i = 0$. Which, as in the Riemannian case, it corresponds to the Barret-Crane model [54] with the various limitations discussed in Section 10.

The EPRL model is obtained by restricting the representations appearing in the expression of the BF partition function so that at each tetrahedron the linear constraints (187) the strongest possible way that is compatible with the uncertainties relations stemming from (188). In addition one would add the requirement that the state-space of tetrahedra is compatible with the state-space of the analogous excitation in the canonical context of LQG so that arbitrary states in the kinematical state of LQG have non trivial amplitudes in the model.

On the weak imposition of the linear simplicity constraints

We now discuss the weak imposition of the linear simplicity constraints in the quantum framework. There are essentially three views in the literature: two of them, discussed below, concerns directly the way the EPRL model has been usually introduced. The third possibility is the semiclassical view based on the coherent state representation leading to the FK model (see section 9).

8.2.1 Lorentzian model: The Gupta-Bleuler criterion

As in the Riemannian case, the fact that the constraints D_f^i do not form a closed (first class) algebra in the generic case requires a weaker sense in which the constraints are imposed. One possibility is to consider the Gupta-Bleuler criterion consisting in selecting a suitable class of states for which the matrix elements on D_f^i vanish. In this respect one notices that if we chose the subspace $\mathcal{H}_j \subset \mathcal{H}_{p,k}$ one has

$$\begin{aligned} \langle p, k, j, q | D_f^3 | p, k, j, m \rangle &= \delta_{q,m} m \left(1 - \frac{\gamma_j}{\gamma}\right) \\ \langle p, k, j, q | D_f^\pm | p, k, j, m \rangle &= \delta_{q \pm 1, m} \sqrt{(j \pm m + 1)(j \mp m)} \left(1 - \frac{\gamma_j}{\gamma}\right). \end{aligned}$$

One immediately observes that matrix elements of the linear constraints vanish in this subclass if one can choose

$$\gamma_j = \frac{kp}{j(j+1)} = \gamma \quad (189)$$

Now the situation simplifies with respect to the Riemannian case as there is only one single case. The linear simplicity constraint is satisfied as long as $p = \gamma j(j+1)/k$. Therefore, one has an

integer worth of possibilities. In particular, given j one has $k = j - r$ for all possible half-integers such that $k > 0$ [134]. As we will see in what follows the best choice from the point of view of the Master constraint criterion is $k = j$ from which it follows

$$p = \gamma(j + 1). \quad (190)$$

8.2.2 Lorentzian model: The Master constraint criterion

Another criterion for weak imposition can be developed by studying the spectrum of the Master constraint

$$\begin{aligned} M_f = D_f \cdot D_f &= L^2 - \frac{1}{\gamma} 2L \cdot K + \frac{1}{\gamma^2} K^2 \\ &= \frac{1}{\gamma^2} [(1 + \gamma^2)L^2 - 2\gamma C_2 - C_1]. \end{aligned} \quad (191)$$

Strong imposition of the constraints D_f^i would amount to looking for the kernel of the master constraint M_f . However, generically the positive operator associated with the master constraint does not have the zero eigenvalue in the spectrum due to the open nature of the constraint algebra (188). The proposal of [160] is to look for the minimum eigenvalue among spaces $\mathcal{H}_j \in \mathcal{H}_{p,k}$. Explicitly

$$M_f |\psi\rangle = m_{p,k,j} |\psi\rangle, \quad (192)$$

where

$$m_{p,k,j} = \frac{1}{\gamma^2} [p^2 + 1 - k^2 + (1 + \gamma^2)j(j + 1) - 2\gamma kp].$$

For given j the minimum eigenvalue is obtained when $k = j$ and $p = \gamma j$ in which case one gets $m_{p,k,j} \geq m_j$ for $m_j = \hbar^2(1 + \gamma^2)j + 1$. Again we see that the important condition

$$M_f |\gamma j, j, j, m\rangle = \mathcal{O}_{sc} \quad (193)$$

holds (recall the notion \mathcal{O}_{sc} from Section 7.2.4). Interestingly, the states that satisfy the previous semiclassical criterion satisfy the Gupta-Bleuler criterion not exactly and only in the large spin sense. However, the advantage of the master constraint criterion is clear from the point of view of cylindrical consistency as the choice $p = \gamma(j + 1)$ obtained in the previous subsection would imply that $j = 0$ spin network links would have a non trivial amplitude in the path integral defined in Section 7.3. Such thing would be in sharp conflict with diffeomorphism invariance in the model.

Therefore, as in the Riemannian case we will use the master constraint criterion as the basic ingredient in the definition of the EPRL model. One can write a Lorentz invariant constraint [326] from the master constraint and using the $D_f^i = 0$ classically. This leads to the following Lorentz invariant condition in terms of the $SL(2, \mathbb{C})$ Casimirs

$$M_f^{L^I} = (1 - \gamma^2)C_2 - 2C_1\gamma, \quad (194)$$

where C_1 and C_2 are the two $sl(2, \mathbb{C})$ Casimirs given in equation (182). Surprisingly, the conditions $p = \gamma j$ and $k = j$ minimizing the master constraint solve its Lorentz invariant version strongly! This resolves the cylindrical consistency issue pointed out above. More recently, it has been shown that the constraint solution $p = \gamma j$ and $k = j$ also follows naturally from a spinor formulation of the simplicity constraints [363, 150, 248].

8.2.3 Lorentzian model: Restrictions on the Immirzi parameter

Unlike the Riemannian model, all values of spin j are allowed, and no restrictions on the Immirzi parameter arise.

where the boxes now represent $SL(2, \mathbb{C})$ integrations with the invariant measure. The previous amplitude is equivalent to the its spin foam representation

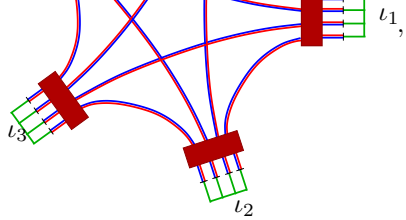
$$Z_{epri}^L(\Delta) = \sum_{j_f} \sum_{l_e} \prod_{f \in \Delta^*} (1 + \gamma^2) j_f^2 \prod_{v \in \Delta^*}$$

The vertex amplitude is divergent due to the presence of a redundant integration over $SL(2, \mathbb{C})$, it becomes finite by dropping an arbitrary integration, i.e. removing any of the 5 boxes in the vertex expression [161].

8.4 The coherent state representation

It is immediate to obtain the coherent states representation of the Lorentzian models. As in the Riemannian case, one simply inserts resolution of the identities (108) on the intermediate $SU(2)$ (green) wires in (200) from where it results

$$Z_{epri}^L(\Delta) = \sum_{j_f} \prod_{f \in \Delta^*} (1 + \gamma^2) j_f^2$$

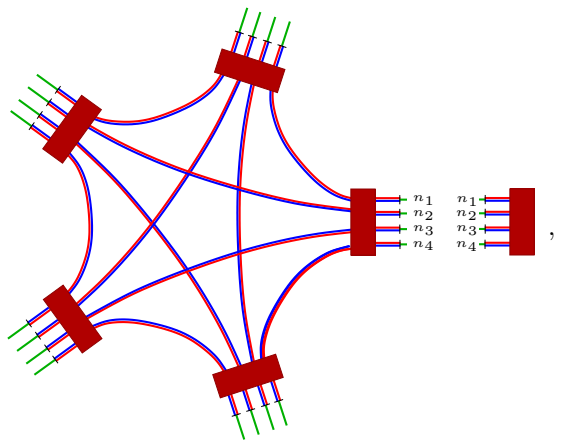
$$\int \prod_{e \in \Delta^*} d_{j_{ef}} dn_{ef}$$

(200)

9 The Freidel–Krasnov Model

Shortly after the appearance of the paper [162], Freidel and Krasnov [176] introduced a set of new spin foam models for four dimensional gravity using the coherent state basis of the quantum tetrahedron of Livine and Speziale [246]. The idea is to impose the linearized simplicity constraints (126) directly as a semiclassical condition on the coherent state basis. As we have seen above, coherent states are quantum states of the right and left tetrahedra in BF theory which have a

clear-cut semiclassical interpretation through their property (112). We have also seen that the imposition of the linear constraints (126) *a la* EPRL is in essence semiclassical as they are strictly valid only in the large spin limit. In the FK approach one simply accept from the starting point that, due to their property of not defining set that is closed under commutation relations, the Plebansky are to be imposed semiclassically. One defines new models by restricting the set of coherent states entering in the coherent state representation of $Spin(4)$ BF theory (115) to those that satisfy condition (126) in expectation values. They also emphasize how the model [162] corresponds indeed to the sector $\gamma = \infty$ which has been shown to be topological [240].

The case $\gamma < 1$

For $\gamma < 1$ the vertex amplitude is identical to the EPRL model. This is apparent in the coherent state expression of the EPRL model (175). Thus we have

$$Z_{fk}^{\gamma < 1}(\Delta) = \sum_{j_f} \prod_{f \in \Delta^*} d_{|1-\gamma|\frac{j}{2}} d_{(1+\gamma)\frac{j}{2}}$$

$$\prod_{e \in \Delta^*} \int d_{(1+\gamma)\frac{j}{2}} d_{(\gamma-1)\frac{j_{ef}}{2}} dn_{ef}$$

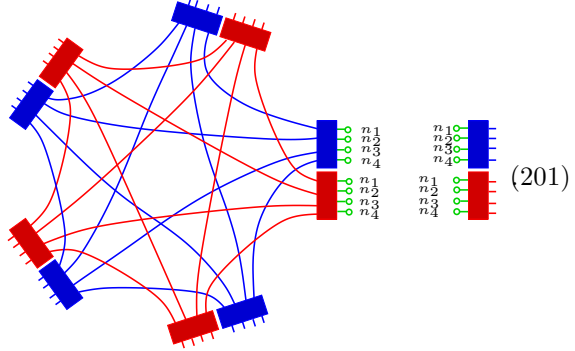

From the previous expression we conclude that the vertex amplitudes of the FK and EPRL model coincide for $\gamma < 1$

$$A_{v\ fk}^{\gamma < 1} = A_{v\ ep\rl}^{\gamma < 1}. \tag{202}$$

Notice however that different weights are assigned to edges in the FK model. This is due to the fact that one is restricting the $Spin(4)$ resolution of identity in the coherent basis in the previous expression, while in the EPRL model the coherent state resolution of the identity is used for $SU(2)$ representations. This difference is important and has to do with the still unsettled discussion concerning the measure in the path integral representation (see Section 12.1 and references therein).

The case $\gamma > 1$

For the case $\gamma > 1$ the FK amplitude is given by

$$Z_{fk}^{\gamma > 1}(\Delta) = \sum_{j_f} \prod_{f \in \Delta^*} d_{|1-\gamma|\frac{j}{2}} d_{(1+\gamma)\frac{j}{2}}$$

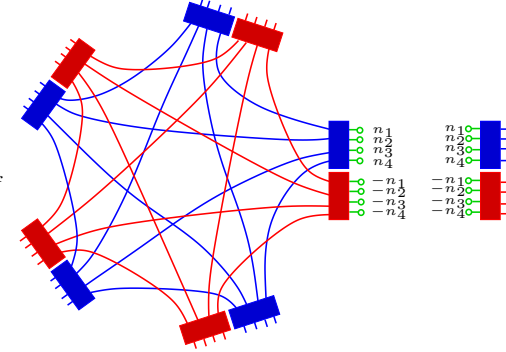
$$\prod_{e \in \Delta^*} \int d_{(1+\gamma)\frac{j}{2}} d_{(\gamma-1)\frac{j_{ef}}{2}} dn_{ef}$$

The study of the coherent state representation of the FK model for $\gamma > 1$, and comparison with equation (178) for the EPRL model, clearly shows the difference between the two models in this regime.

$$Z_{fk}^{\gamma} = \sum_{j_f} \prod_{f \in \Delta^*} d_{(1-\gamma)\frac{j_f}{2}} d_{(1+\gamma)\frac{j_f}{2}} \int \prod_{e \in \Delta^*} d_{|1-\gamma|\frac{j_{ef}}{2}} d_{(1+\gamma)\frac{j_{ef}}{2}} dn_{ef} dg_{ev}^- dg_{ev}^+ \exp(S_{j^{\pm}, \mathbf{n}}^{fk, \gamma}[g^{\pm}]), \quad (204)$$

where the discrete action

$$S_{j^{\pm}, \mathbf{n}}^{fk, \gamma}[g^{\pm}] = \sum_{v \in \Delta^*} (S_{(1-\gamma)\frac{j_f}{2}, \mathbf{n}}^v[g^-] + S_{(1+\gamma)\frac{j_f}{2}, s(\gamma)\mathbf{n}}^v[g^+]), \quad (205)$$

where $s(\gamma) = \text{sign}(1 - \gamma)$ and

$$S_{j, \mathbf{n}}^v[g] = \sum_{a < b = 1}^5 2j_{ab} \ln \langle n_{ab} | g_a^{-1} g_b | n_{ba} \rangle, \quad (206)$$

with the indices a, b labelling the five edges of a given vertex.

10 The Barrett–Crane Model

The Barrett–Crane models [54, 53] can be easily obtained in the present framework as a suitable limiting case $\gamma \rightarrow \infty$ of the previous constructions. One way to get it is to take the limit $\gamma \rightarrow \infty$ of the linear simplicity constraint (126) at the classical level. In this way the constraint becomes

$$D^i = L_f^i \approx 0 \quad (207)$$

with which the constraint algebra closes. One can impose the constraints strongly in this case. The solution is obtained by setting $j_f = 0$ in all faces at the level of the amplitude (148). An immediate consequence of this is that $j_f^+ = j_f^-$ and all tetrahedra are assigned a unique intertwiner: the so-called Barrett–Crane intertwiner. Explicitly, setting $j_f = 0$ in (148) we get

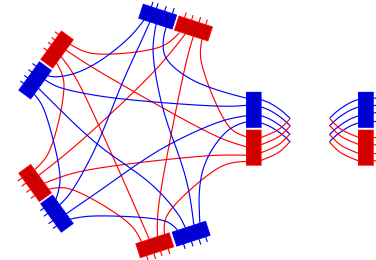
$$Z_{BC}(\Delta) = \sum_{j_f^+} \prod_{f \in \Delta^*} d_{j_f^+}^2$$

where since $j_f^+ = j_f^-$ we are arbitrarily choosing j_f^+ as the spins summed over in the state sum. Eliminating redundant group integrations we get the previous amplitude in the spin foam representation, namely

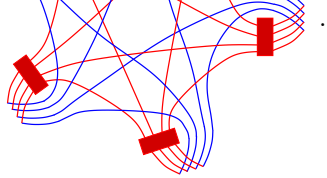
$$Z_{BC}(\Delta) = \sum_{j_f^+} \prod_{f \in \Delta^*} d_{j_f^+}^2 \prod_{v \in \Delta^*} \text{[Diagram]} \quad (209)$$

Observe that the vertex amplitude depend only on the 10 corresponding j_f^+ , this is the Riemannian Barrett-Crane vertex. It is interesting to write the analog of equation (147). The Barrett-Crane model is obtained by the modification of the BF projectors in (95) so that

$$Z_{BC}(\Delta) = \sum_{j_f^+} \prod_{f \in \Delta^*} d_{j_f^+}^2 \prod_e P_{BC}^e(j_1^+, \dots, j_4^+) \quad (210)$$

with

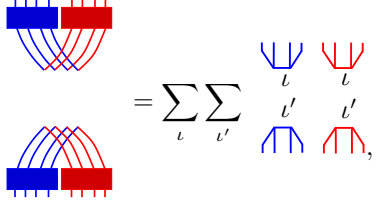
$$P_{BC}^e(j_1 \dots j_4) = |BC\rangle\langle BC| = \text{[Diagram]} = \sum_{\iota} \sum_{\iota'} \text{[Diagram]} \quad (211)$$

where $|BC\rangle$ is the Barrett-Crane intertwiner. The tetrahedra state space is one-dimensional once the four quantum numbers j_f^+ has been fixed. Indeed, it has been shown that the state space of strong solutions of the the quadratic quantum Plebanski constraints is one dimensional and it is given by the BC intertwiner $|BC\rangle$ [307].

10.1 The coherent states representation of the BC amplitude

One can insert coherent states resolution of the identity (111) in the 10 wires obtaining the following coherent state representation of the Barrett-Crane amplitude

$$Z_{BC} = \sum_{j_f^+} \prod_{f \in \Delta^*} d_{j_f^+}^2 \int \prod_{e \in \Delta^*} d_{j_{ef}} dn_{ef} dg_{ev}^+ \exp(S_{j^+, \mathbf{n}}^{BC}[g^+]), \quad (212)$$

where the discrete action

$$S_{j^+, \mathbf{n}}^{BC}[g^+] = \sum_{v \in \Delta^*} \sum_{a < b=1}^5 2j_{ab}^+ \ln \langle n_{ab} | (g_a^+)^{-1} g_b^+ | n_{ab} \rangle. \quad (213)$$

Notice that there are only 10 normals n_{ab} as in this case $n_{ab} = n_{ba}$. The large spin asymptotics of the Barrett-Crane vertex has been investigated in [63].

11 Boundary Data for the New Models and Relationship with the Canonical Theory

So far we have considered cellular complexes with no boundary. Transition amplitudes are expected to be related to the definition of the physical scalar product as discussed in Section 2.2. In order to define them one needs to consider complexes with boundaries. Boundary states are defined on the boundary of the dual two-complex Δ^* that we denote $\partial\Delta^*$. The object $\partial\Delta^*$ is a one-complex (a graph). According to the construction of the model (Section 7 and 8) boundary states are in one-to-one correspondence with $SU(2)$ spin networks. This comes simply from the fact that links (one-cells) $\ell \in \partial\Delta^*$ inherit the spins labels (unitary irreducible representations of the subgroup $SU(2)$) of the boundary faces while nodes (zero-cells) $n \in \partial\Delta^*$ inherit the intertwiner levels of boundary edges.

At this stage one can associate the boundary data with elements of a Hilbert space. Being in one-to-one correspondence with $SU(2)$ spin networks, a natural possibility is to associate to them an element of the kinematical Hilbert space of LQG. More precisely, with a given coloured boundary graph γ with links labelled by spins j_ℓ and nodes labelled by intertwiners t_n we associate a cylindrical function $\Psi_{\gamma, \{j_\ell\}, \{t_n\}} \in \mathcal{L}^2(SU(2)^{N_\ell})$, where here N_ℓ denotes number of links in the graph γ (see Equation 69). In this way, the boundary Hilbert space associated with $\partial\Delta^*$ is isomorphic (if one used the natural AL measure) with the Hilbert space of LQG truncated to that fixed graph. Moreover, geometric operators such as volume and area defined in the covariant context are shown to coincide with the corresponding operators defined in the canonical formulation [135, 136]. Now, if cellular complexes are dual to triangulations then the boundary spin networks can have at most four valent nodes. This limitation can be easily overcome: as in BF theory the EPRL amplitudes can be generalized to arbitrary complexes with boundaries given by graphs with nodes of arbitrary valence. The extension of the model to arbitrary complexes has been first studied in [231, 230], it has also been revisited in [134].

Alternatively, one can associate the boundary states with elements of $\mathcal{L}^2(Spin(4)^{N_\ell})$ (in the Riemannian models) – or carefully define the analog of spin network states as distributions in the Lorentzian case²⁵. In this case one gets special kind of spin network states that are a subclass of the so-called projected spin networks introduced in [16, 241] in order to define an heuristic quantization of the (non-commutative and very complicated) Dirac algebra of a Lorentz connection formulation of the phase space of gravity [14, 10, 16, 9, 8, 7, 15]. The fact that these special subclass of projected spin networks appear naturally as boundary states of the new spin foams is shown in [152].

Due to their similarity for $\gamma < 1$ the same relationship between boundary data and elements of the kinematical Hilbert space hold for the FK model. However, the such simple relationship does not hold for the model in the case $\gamma > 1$.

The role of knotting in the Hilbert space of the EPRL model is studied in [38].

²⁵ The definition of a polymer-like gauge invariant states as elements of a Hilbert space of a gauge theory with non compact group is an open issue. The naive attempts fail, the basic problem is that gauge invariant states are not square integrable functions with respect to the obvious generalization of the AL measure for fixed graph: this is due to the infinite volume of the gauge group (the invariant measure is not normalizable). For that reason the discussion of the Lorentzian sector with $G = SL(2, \mathbb{C})$ is usually formal. See [177] for some insights on the problem of defining a gauge invariant Hilbert space of graphs for non compact gauge groups.

12 Further developments and related models

12.1 The measure

The spin foam amplitudes discussed in the previous sections have been introduced by constraining the BF histories through the simplicity constraints. However, in the path integral formulation, the presence of constraints has the additional effect of modifying the weights with which those histories are to be summed: second class constraints modify the path integral measure (in the spin foam context this issue was raised in [84]). As pointed out before, this question has not been completely settled yet in the spin foam community. The explicit modification of the formal measure in terms of continuous variables for the Plebansky action was presented in [100]. A systematic investigation of the measure in the spin foam context was attempted in [157] and [208]. As pointed out in [84], there are restrictions in the manifold of possibilities coming from the requirement of background independence. The simple BF measure chosen in the presentation of the amplitudes in the previous sections satisfy these requirements. There are other consistent possibilities; see for instance [72] for a modified measure which remains extremely simple and is suggested from the structure of LQG.

12.2 Relation with the canonical formulation: the scalar constraint

An important question is the relationship between the spin foam amplitudes and the canonical operator formulation. The question of whether one can reconstruct the Hamiltonian constraints out of spin foam amplitudes has been analysed in detail in three dimensions. For the study of quantum three dimensional gravity from the BF perspective see [275], we will in fact present this perspective in detail in the three dimensional part of this article. For the relationship with the canonical theory using variables that are natural from the Regge gravity perspective see [88, 87]. In four dimensions the question has been investigated in [3] in the context of the new spin foam models. In the context of group field theories this issue is explored in [244]. Finally, spin foams can in principle be obtained directly from the implementation of the Dirac program using path integral methods this avenue has been explored in [213, 214] from which a discrete path integral formulation followed [209]. The question of the relationship between covariant and canonical formulations in the discrete setting has been analyzed also in [142].

12.3 Spin foam models with timelike faces

By construction all tetrahedra in the FK and EPRL models are embedded in a spacelike hypersurface and hence have only spacelike triangles. It seems natural to ask the question of whether a more general construction allowing for timelike faces is possible. The models described in previous sections have been generalized in order to include timelike faces in the work of Conrady [119, 114, 118]. An earlier attempt to define such models in the context of the Barrett–Crane model can be found in [299].

12.4 Coupling to matter

The issue of the coupling of the new spin foam models to matter remains to a large extent un-explored territory. Nevertheless some results can be found in the literature. The coupling of the Barrett–Crane model (the $\gamma \rightarrow \infty$ limit of the EPRL model) to Yang–Mills fields was studied in [288]. More recently the coupling of the EPRL model to fermions has been investigated in [211, 67]. A novel possibility of unification of the gravitational and gauge fields was recently proposed in [6].

12.5 Cosmological constant

The introduction of a cosmological constant in the construction of four dimensional spin foam models has a long history. Barrett and Crane introduced a vertex amplitude [54] in terms of the Crane and Yetter model [124] for BF theory with cosmological constant. The Lorentzian quantum deformed version of the previous model was studied in [277]. For the new models the coupling with a cosmological constant is explored in terms of the quantum deformation of the internal gauge symmetry in [133, 207, 210] as well as (independently) in [168].

12.6 Spin foam cosmology

The spin foam approach applied to quantum cosmology has been explored in [68, 360, 216, 73, 328, 327]. The spin foam formulation can also be obtained from the canonical picture provided by loop quantum cosmology (see [83] and references therein). This has been explored systematically in [25, 24, 23, 102]. Very recent results are [250]

12.7 Constraints are imposed semiclassically

As we have discussed in the introduction of the new models, Heisenberg uncertainty principle precludes the strong imposition of the Plebanski constraints that reduce BF theory to general relativity. The results on the semiclassical limit of these models seem to indicate that metric gravity should be recovered in the low energy limit. However, it seems likely that the semiclassical limit could be related to certain modifications of Plebanski's formulation of gravity [234, 235, 237, 236, 238]. A simple interpretation of the new models in the context of the bi-gravity paradigm proposed in [342] could be of interest.

12.8 Group field theories associated to the new spin foams

As already pointed out in [34] spin foams can be interpreted in close analogy to Feynman diagrams. Standard Feynman graphs are generalized to 2-complexes and the labeling of propagators by momenta to the assignment of spins to faces. Finally, momentum conservation at vertices in standard feynmanology is now represented by spin-conservation at edges, ensured by the assignment of the corresponding intertwiners. In spin foam models the non-trivial content of amplitudes is contained in the vertex amplitude which in the language of Feynman diagrams can be interpreted as an interaction. This analogy is indeed realized in the formulation of spin foam models in terms of a group field theory (GFT) [309, 308].

The GFT formulation resolves by definition the two fundamental conceptual problems of the spin foam approach: diffeomorphism gauge symmetry and discretization dependence. The difficulties are shifted to the question of the physical role of λ and the convergence of the corresponding perturbative series.

In three dimensions this idea has been studied in more detail. In [256] scaling properties of the modification of the Boulatov group field theory introduced in [181] was studied in detail. In a further modification of the previous model (known as coloured tensor models [202]) new techniques based on a suitable $1/N$ expansion imply that amplitudes are dominated by spherical topology [201]; moreover, it seem possible that the continuum limit might be critical as in certain matrix models [204, 89, 203, 205, 332]. However, it is not yet clear if there is a sense in which these models correspond to a physical theory. The naive interpretation of the models is that they correspond to a formulation of 3d quantum gravity including a dynamical topology.

12.9 Results on the semiclassical limit of EPRL-FK models

13 The semiclassical limit

Having introduced the relevant spin foam models in the previous sections we now present the results on the large spin asymptotics of the spin foam amplitudes suggesting that on a fixed discretization the semiclassical limit of the EPRL-FK models is given by Regge's discrete formulation of general relativity [55, 58].

The semiclassical limit of spin foams is based on the study of the the large spin limit asymptotic behaviour of coherent state spin foam amplitudes. The notion of large spin can be defined by the rescaling of quantum numbers and Planck constant according to $j \rightarrow \lambda j$ and $\hbar \rightarrow \hbar/\lambda$ and taking $\lambda \gg 1$. In this limit the quantum geometry approximates the classical one when tested with suitable states (e.g. coherent states). However, the geometry remains discrete during this limiting process as the limit is taken on a fixed regulating cellular structure. That is why one usually makes a clear distinction between semiclassical limit and the continuum limit. In the semiclassical analysis presented here one can only hope to make contact with discrete formulations of classical gravity; hence the importance of Regge calculus in the discussion of this section.

The key technical ingredient in this analysis is the representation of spin foam amplitudes in terms of the coherent state basis introduced in Section 6.2. Here we follow [55, 58, 56, 59, 57]. The idea of using coherent states and discrete effective actions for the study of the large spin asymptotics of spin foam amplitudes was put forward in [115, 116]. The study of the large spin asymptotics has a long tradition in the context of quantum gravity dating back to the studied of Ponzano–Regge [303]. More directly related to our discussion here are the early works [62, 63]. The key idea is to use asymptotic stationary phase methods for the amplitudes written in terms of the discrete actions presented in the previous section.

13.1 Vertex amplitudes asymptotics

In this section we review the results of the analysis of the large spin asymptotics of the EPRL vertex amplitude for both the Riemannian and Lorentzian models. We follow the notation and terminology of [55] and related papers.

13.1.1 $SU(2)$ 15j-symbol asymptotics

As $SU(2)$ BF theory is quite relevant for the construction of the EPRL-FK models, the study of the large spin asymptotics of the $SU(2)$ vertex amplitude is a key ingredient in the analysis of [55]. The coherent state vertex amplitude is

$$15j(j, \mathbf{n}) = \int \prod_{a=1}^5 dg_a \prod_{1 \leq a < b \leq 5} \langle n_{ab} | g_a^{-1} g_b | n_{ba} \rangle^{2j_{ab}}, \quad (214)$$

which depends on 10 spins j_{ab} and 20 normals $n_{ab} \neq n_{ba}$. The previous amplitude can be expressed as

$$15j(j, \mathbf{n}) = \int \prod_{a=1}^5 dg_a \prod_{1 \leq a < b \leq 5} \exp S_{j, \mathbf{n}}[g], \quad (215)$$

$$S_{j, \mathbf{n}}[g] = \sum_{a < b=1}^5 2j_{ab} \ln \langle n_{ab} | g_a^{-1} g_b | n_{ba} \rangle, \quad (216)$$

and the indices a, b label the five edges of a given vertex. The previous expression is exactly equal to the form (86) of the BF amplitude. In the case of the EPRL model studied in Sections 7 and 8, the coherent state representation – see equations 175, 179, and 200 – is the basic tool for the study of the semiclassical limit of the models and the relationship with Regge discrete formulation of general relativity.

In order to study the asymptotics of (215) one needs to use extended stationary phase methods due to the fact that the action (216) is complex (see [115, 116]). The basic idea is that in addition to stationarity one requires real part of the action to be maximal. Points satisfying these two conditions are called *critical points*. As the real part of the action is negative definite, the action at critical points is purely imaginary.

Notice that the action (216) depends parametrically on 10 spins j and 20 normals \mathbf{n} . These parameters define the so-called boundary data for the four simplex $v \in \Delta^*$. Thus, there is an action principle for every given boundary data. The number of critical points and their properties depend on these boundary data, hence the asymptotics of the vertex amplitude is a function of the boundary data. Different cases are studied in detail in [55], here we present their results in the special case where the boundary data describe a non-degenerate Regge geometry for the boundary of a four simplex, these data are referred to as Regge-like, and satisfy the gluing constraints. For such boundary data the action (216) has exactly two critical points leading to the asymptotic formula

$$15j(\lambda j, \mathbf{n}) \sim \frac{1}{\lambda^{12}} \left[N_+ \exp\left(i \sum_{a<b} \lambda j_{ab} \Theta_{ab}^E\right) + N_- \exp\left(-i \sum_{a<b} \lambda j_{ab} \Theta_{ab}^E\right) \right], \quad (217)$$

where Θ_{ab} the appropriate dihedral angles defined by the four simplex geometry; finally the N_{\pm} are constants that do not scale with λ .

13.1.2 The Riemannian EPRL vertex asymptotics

The previous result together with the fact that the EPRL amplitude for $\gamma < 1$ is a product of $SU(2)$ amplitudes with the same \mathbf{n} in the coherent state representation (175) implies the asymptotic formula for the vertex amplitude to be given by the unbalanced square of the above formula [56], namely

$$A_v^{eprl} \sim \frac{1}{\lambda^{12}} \left[N_+ e^{i \frac{(1-\gamma)}{2} \sum_{a<b} \lambda j_{ab} \Theta_{ab}^E} + N_- e^{-i \frac{(1-\gamma)}{2} \sum_{a<b} \lambda j_{ab} \Theta_{ab}^E} \right] \times \left[N_+ e^{i \frac{(1+\gamma)}{2} \sum_{a<b} \lambda j_{ab} \Theta_{ab}^E} + N_- e^{-i \frac{(1+\gamma)}{2} \sum_{a<b} \lambda j_{ab} \Theta_{ab}^E} \right].$$

One can write the previous expression as

$$A_v^{eprl} \sim \frac{1}{\lambda^{12}} \left[2N_+ N_- \cos(S_{Regge}^E) + N_+^2 e^{i \frac{1}{\gamma} S_{Regge}^E} + N_-^2 e^{-i \frac{1}{\gamma} S_{Regge}^E} \right]. \quad (218)$$

where

$$S_{Regge}^E = \sum_{a<b} \lambda \gamma j_{ab} \Theta_{ab}^E \quad (219)$$

is the Regge like action for $\lambda \gamma j_{ab} = A_{ab}$ the ten triangle areas (according to the LQG area spectrum (71)). Remarkably, the above asymptotic formula is also valid for the case $\gamma > 1$ [55]. The first term in the vertex asymptotics is in essence the expected one: it is the analog of the $6j$ symbol asymptotics in three dimensional spin foams. Due to their explicit dependence on the Immirzi parameter, the last two terms are somewhat strange from the point of view of the continuum field

theoretical view point. However, this seems to be a peculiarity of the Riemannian theory alone as the results of [58] for the Lorentzian models show. Non geometric configurations are exponentially suppressed. Finally, recently it has been shown that it is possible to restrict the state sum in order to obtain complex amplitudes [156] and [265, 266].

13.1.3 Lorentzian EPRL model

To each solution one can associate a second solution corresponding to a parity related 4-simplex and, consequently, the asymptotic formula has two terms. It is given, up to a global sign, by the expression

$$A_v^{eprl} \sim \frac{1}{\lambda^{12}} \left[N_+ \exp \left(i\lambda\gamma \sum_{a<b} j_{ab} \Theta_{ab}^L \right) + N_- \exp \left(-i\lambda\gamma \sum_{a<b} j_{ab} \Theta_{ab}^L \right) \right], \quad (220)$$

where N_{\pm} are constants that do not scale. Non geometric configurations are exponentially suppressed. By taking into account discrete symmetries it might be possible to further improve the asymptotics of the model [329].

13.2 Full spin foam amplitudes asymptotics

In [116] Freidel and Conrady gave a detailed description of the coherent state representation of the various spin foam models described so far. In particular they provided the definition of the effective discrete actions associated to each case which we presented in (204). This provides the basic elements for setting up the asymptotic analysis presented in [115] (the first results on the semiclassical limit of the new spin foam models) which is similar to the studies of the asymptotic of the vertex amplitude reviewed above but more general in the sense that the semiclassical limit of a full spin foam configuration (involving many vertices) is studied. The result is technically more complex as one studies now critical points of the action associated to a coloured complex which in addition of depending on group variables g it depends on the coherent state parameters \mathbf{n} . The authors of [115] write Equation (204) in the following way

$$Z_{fk}^{\gamma} = \sum_{j_f} \prod_{f \in \Delta^*} d_{(1-\gamma)\frac{j_f}{2}} d_{(1+\gamma)\frac{j_f}{2}} W_{\Delta^*}^{\gamma}(j_f), \quad (221)$$

where

$$W_{\Delta^*}^{\gamma}(j_f) = \int \prod_{e \in \Delta^*} d_{|1-\gamma|\frac{j_{ef}}{2}} d_{(1+\gamma)\frac{j_{ef}}{2}} dn_{ef} dg_{ef}^- dg_{ef}^+ \exp(S_{j_{\pm}, \mathbf{n}}^{fk, \gamma}[g^{\pm}]). \quad (222)$$

They show that those solutions of the equations of motion of the effective discrete action that are non geometric (i.e. the contrary of Regge like) are not critical and hence exponentially suppressed in the scaling $j_f \rightarrow \lambda j_f$ with $\lambda \gg 1$. If configurations are geometric (i.e. Regge like) one has two kind of contributions to the amplitude asymptotics: those coming from degenerate and non-degenerate configurations. If one (by hand) restricts to the non-degenerate configurations then one has

$$W_{\Delta^*}^{\gamma}(j_f) \sim \frac{c}{\lambda^{(33n_e - 6n_v - 4n_f)}} \exp(i\lambda S_{Regge}^E(\Delta^*, j_f)), \quad (223)$$

where n_e , n_v , and n_f denote the number of edges, vertices, and faces in the two complex Δ^* respectively. For more recent results on asymptotics of spin foam amplitudes of arbitrary simplicial complexes see [215].

13.3 Fluctuations: two point functions.

The problem of computing the two point function and higher correlation functions in the context of spin foam has received lots of attention recently. The framework for the definition of the correlation functions in the background independent setting has been generally discussed by Rovelli in [316] and corresponds to a special application of a more general proposal investigated by Oeckl [283, 284, 282, 113, 112, 111, 110, 281]. It was then applied to the Barrett-Crane model in [5, 4, 71], where it was discovered that certain components of the two point function could not yield the expected result compatible with Regge gravity in the semiclassical limit. This was used as the main motivation of the weakening of the imposition of the Plebanski constraints leading to the new models. Soon thereafter it was argued that the difficulties of the Barrett-Crane model were indeed absent in the EPRL model [2]. The two point function for the EPRL model was calculated in [69] and it was shown to produce a result in agreement with that of Regge calculus [74, 254] in the limit $\gamma \rightarrow 0$.

The fact that, for the new model, the double scaling limit $\gamma \rightarrow 0$ and $j \rightarrow \infty$ with $\gamma j = \text{constant}$ defines the appropriate regime where the fluctuation behave as in Regge gravity (in the leading order) has been further clarified in [255]. This indicates that the quantum fluctuations in the new models are more general than simply metric fluctuations. The fact that the new models are not metric at all scales should not be surprising as we know that the Plebanski constraints that produce metric general relativity out of BF theory has been implemented only semiclassically (in the large spin limit). At the deep Planckian regime fluctuations are more general than metric. However, it is not clear at this stage why this is controlled by the Immirzi parameter.

All the previous calculations involve a complex with a single four-simplex. The first computation involving more than one simplex was performed in [257, 71] for the case of the Barrett-Crane model. Certain peculiar properties were found and it is not clear at this stage whether these issues remain in the EPRL model. Higher order correlation functions have been computed in [330], the results are in agreement with Regge gravity in the $\gamma \rightarrow 0$ limit.

Part IV

Three dimensional gravity

In this part we shall review the quantization of three dimensional gravity introducing in this simpler context what in this case can be called the *spin foam representation* of the quantum dynamics. We present this case in great detail as it is completely solvable. More precisely, it allows for an explicit realization of the path integral quantization for a generally covariant system as generally discussed in Section 2.2. Moreover, the path integral takes the form of a sum of spin foam amplitudes which share all the *kinematical* quantum geometric properties with their four dimensional relatives.

The simplicity of this theory allows for the clear-cut illustration of some central conceptual difficulties associated with the quantization of a generally covariant system. We will use the insights provided by 3d gravity to support the discussion of certain difficult conceptual issues for the spin foam approach in Section V.

14 Spin Foams for 3-Dimensional Gravity

Three dimensional gravity is an example of BF theory for which the spin foam approach can be implemented in a rather simple way. Despite its simplicity the theory allows for the study of many of the conceptual issues to be addressed in four dimensions. In addition spin foams for BF theory are the basic building block of 4-dimensional gravity models. For a beautiful presentation of BF theory and its relation to spin foams see [35]. For simplicity we study the Riemannian theory; the Lorentzian generalization of the results of this section have been studied in [172].

14.1 *Spin foams* in 3d quantum gravity

Here we derive the *spin foam representation* of LQG in a simple solvable example: 2+1 gravity. For the definition other approaches to 3d quantum gravity see Carlip's book [106].

14.2 The classical theory

Riemannian gravity in 3 dimensions is a theory with no local degrees of freedom, i.e., a topological theory. Its action (in the first order formalism) is given by

$$S[e, \omega] = \int_M \text{Tr}(e \wedge F(\omega)), \quad (224)$$

where $M = \Sigma \times \mathbb{R}$ (for Σ an arbitrary Riemann surface), ω is an $SU(2)$ -connection and the triad e is an $su(2)$ -valued 1-form. The gauge symmetries of the action are the local $SU(2)$ gauge transformations

$$\delta e = [e, \alpha], \quad \delta \omega = d_\omega \alpha, \quad (225)$$

where α is a $su(2)$ -valued 0-form, and the 'topological' gauge transformation

$$\delta e = d_\omega \eta, \quad \delta \omega = 0, \quad (226)$$

where d_ω denotes the covariant exterior derivative and η is a $\mathfrak{su}(2)$ -valued 0-form. The first invariance is manifest from the form of the action, while the second is a consequence of the Bianchi identity, $d_\omega F(\omega) = 0$. The gauge symmetries are so large that all the solutions to the equations of motion are locally pure gauge. The theory has only global or topological degrees of freedom.

Upon the standard 2+1 decomposition, the phase space in these variables is parametrized by the pull back to Σ of ω and e . In local coordinates one can express them in terms of the 2-dimensional connection A_a^i and the triad field $E_j^b = \epsilon^{bc} e_c^k \delta_{jk}$ where $a = 1, 2$ are space coordinate indices and $i, j = 1, 2, 3$ are $su(2)$ indices. The Poisson bracket is given by

$$\{A_a^i(x), E_j^b(y)\} = \delta_a^b \delta_j^i \delta^{(2)}(x, y). \quad (227)$$

Local symmetries of the theory are generated by the first class constraints

$$D_b E_j^b = 0, \quad F_{ab}^i(A) = 0, \quad (228)$$

which are referred to as the Gauss law and the curvature constraint respectively. This simple theory has been quantized in various ways in the literature [106], here we will use it to introduce the *spin foam representation*.

14.3 Spin foams from the Hamiltonian formulation

The physical Hilbert space, \mathcal{H}_{phys} , is defined by those ‘states in \mathcal{H}_{kin} ’ that are annihilated by the constraints. As discussed in [315, 353], spin network states solve the Gauss constraint – $\widehat{D}_a E_i^a |s\rangle = 0$ – as they are manifestly $SU(2)$ gauge invariant. To complete the quantization one needs to characterize the space of solutions of the quantum curvature constraints \widehat{F}_{ab}^i , and to provide it with the physical inner product. As discussed in Section 2.2, we can achieve this if we can make sense of the following formal expression for the generalized projection operator P :

$$P = \int D[N] \exp(i \int_{\Sigma} \text{Tr}[N \widehat{F}(A)]) = \prod_{x \subset \Sigma} \delta[\widehat{F}(A)], \quad (229)$$

where $N(x) \in \mathfrak{su}(2)$. Notice that this is just the field theoretical analog of equation (8). P will be defined below by its action on a dense subset of test-states called the cylindrical functions $\text{Cyl} \subset \mathcal{H}_{kin}$. If P exists then we have

$$\langle sPU[N], s' \rangle = \langle sP, s' \rangle \quad \forall \quad s, s' \in \text{Cyl}, \quad N(x) \in \mathfrak{su}(2) \quad (230)$$

where $U[N] = \exp(i \int \text{Tr}[iN \widehat{F}(A)])$. P can be viewed as a map $P : \text{Cyl} \rightarrow K_F \subset \text{Cyl}^*$ (the space of linear functionals of Cyl) where K_F denotes the kernel of the curvature constraint. The physical inner product is defined as

$$\langle s', s \rangle_p := \langle s'P, s \rangle, \quad (231)$$

where \langle, \rangle is the inner product in \mathcal{H}_{kin} , and the physical Hilbert space as

$$\mathcal{H}_{phys} := \overline{\text{Cyl}/J} \quad \text{for} \quad J := \{s \in \text{Cyl} \text{ s.t. } \langle s, s \rangle_p = 0\}, \quad (232)$$

where the bar denotes the standard Cauchy completion of the quotient space in the physical norm.

One can make (229) a rigorous definition if one introduces a regularization. A regularization is necessary to avoid the naive UV divergences that appear in QFT when one quantizes non-linear expressions of the canonical fields such as $F(A)$ in this case (or those representing interactions in standard particle physics). A rigorous quantization is achieved if the regulator can be removed without the appearance of infinities, and if the number of ambiguities appearing in this process is under control. We shall see that all this can be done in the simple toy example of this section.

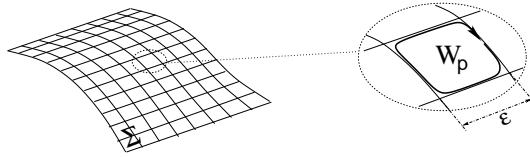

Figure 9: Cellular decomposition of the space manifold Σ (a square lattice of size ϵ in this example), and the infinitesimal plaquette holonomy $W_p[A]$.

We now introduce the regularization. Given a partition of Σ in terms of 2-dimensional plaquettes of coordinate area ϵ^2 (Figure 9) one can write the integral

$$F[N] := \int_{\Sigma} \text{Tr}[NF(A)] = \lim_{\epsilon \rightarrow 0} \sum_p \epsilon^2 \text{Tr}[N_p F_p] \quad (233)$$

as a limit of a Riemann sum, where N_p and F_p are values of the smearing field N and the curvature $\epsilon^{ab} F_{ab}^i[A]$ at some interior point of the plaquette p and ϵ^{ab} is the Levi-Civita tensor. Similarly the holonomy $W_p[A]$ around the boundary of the plaquette p (see Figure 9) is given by

$$W_p[A] = \mathbb{1} + \epsilon^2 F_p(A) + \mathcal{O}(\epsilon^2). \quad (234)$$

The previous two equations imply that $F[N] = \lim_{\epsilon \rightarrow 0} \sum_p \text{Tr}[N_p W_p]$, and lead to the following definition: given $s, s' \in \text{Cyl}$ (think of *spin network* states) the physical inner product (231) is given by

$$\langle s' P, s \rangle := \lim_{\epsilon \rightarrow 0} \langle s \prod_p \int dN_p \exp(i\text{Tr}[N_p W_p]), s \rangle. \quad (235)$$

The partition is chosen so that the links of the underlying spin network graphs border the plaquettes. One can easily perform the integration over the N_p using the identity (Peter–Weyl theorem)

$$\int dN \exp(i\text{Tr}[NW]) = \sum_j (2j + 1) \text{Tr}[\overset{j}{\Pi}(W)], \quad (236)$$

where $\overset{j}{\Pi}(W)$ is the spin j unitary irreducible representation of $SU(2)$. Using the previous equation

$$\langle s' P, s \rangle := \lim_{\epsilon \rightarrow 0} \prod_p^{n_p(\epsilon)} \sum_{j_p} (2j_p + 1) \langle s' \text{Tr}[\overset{j_p}{\Pi}(W_p)], s \rangle, \quad (237)$$

where the spin j_p is associated to the p -th plaquette, and $n_p(\epsilon)$ is the number of plaquettes. Since the elements of the set of Wilson loop operators $\{W_p\}$ commute, the ordering of plaquette-operators in the previous product does not matter. The limit $\epsilon \rightarrow 0$ exists and one can give a closed expression for the physical inner product. That the regulator can be removed follows from the orthonormality of $SU(2)$ irreducible representations which implies that the two spin sums associated to the action of two neighboring plaquettes collapses into a single sum over the action of the *fusion* of the corresponding plaquettes (see Figure 10). One can also show that it is finite²⁶, and satisfies all the properties of an inner product [101].

Figure 10: In two dimensions the action of two neighboring plaquette-sums on the vacuum is equivalent to the action of a single larger plaquette action obtained from the fusion of the original ones. This implies the trivial *scaling* of the physical inner product under refinement of the regulator and the existence of a well defined limit $\epsilon \rightarrow 0$.

14.4 The spin foam representation

Each $\text{Tr}[\overset{j_p}{\Pi}(W_p)]$ in (237) acts in \mathcal{H}_{kin} by creating a closed loop in the j_p representation at the boundary of the corresponding plaquette (Figure 11 and 13).

Now, in order to obtain the *spin foam representation* we introduce a non-physical (*coordinate time*) as follows: Instead of working with one copy of the space manifold Σ we consider $n_p(\epsilon)$

²⁶ The physical inner product between spin network states satisfies the following inequality

$$|\langle s, s' \rangle_p| \leq C \sum_j (2j + 1)^{2-2g},$$

for some positive constant C . The convergence of the sum for genus $g \geq 2$ follows directly. The case of the sphere $g = 0$ and the torus $g = 1$ can be treated individually[101].

Figure 11: Graphical notation representing the action of one plaquette holonomy on a *spin network* state. On the right is the result written in terms of the *spin network* basis. The amplitude $N_{j,m,k}$ can be expressed in terms of Clebsch-Gordan coefficients.

copies as a discrete foliation $\{\Sigma_p\}_{p=1}^{n_p(\epsilon)}$. Next we represent each of the $\text{Tr}[\Pi^{j_p}(W_p)]$ in (237) on the corresponding Σ_p . If one inserts the partition of unity between in \mathcal{H}_{kin} between the slices, graphically

$$\mathbb{1} = \sum_{\gamma \subset \Sigma, \{j\}_\gamma} |\gamma, \{j\}\rangle \langle \gamma, \{j\}| \quad (238)$$

where the sum is over the complete basis of *spin network* states $\{|\gamma, \{j\}\rangle\}$ – based on all graphs $\gamma \subset \Sigma$ and with all possible spin labelling – one arrives at a sum over spin-network histories representation of $\langle s, s' \rangle_p$. More precisely, $\langle s', s \rangle_p$ can be expressed as a sum over amplitudes corresponding to a series of transitions that can be viewed as the ‘time evolution’ between the ‘initial’ *spin network* s' and the ‘final’ *spin network* s . This is illustrated in the two simple examples of Figure 12 and 14); on the r.h.s. we illustrate the continuum spin foam picture obtained when the regulator is removed in the limit $\epsilon \rightarrow 0$.

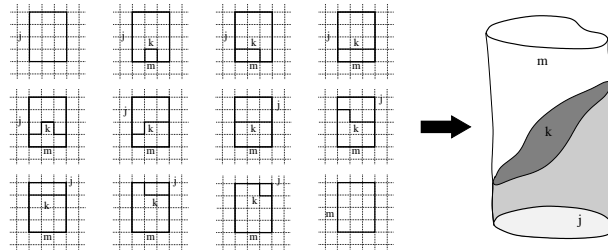

Figure 12: A set of discrete transitions in the loop-to-loop physical inner product obtained by a series of transitions as in Figure 11. On the right, the continuous *spin foam representation* in the limit $\epsilon \rightarrow 0$.

Spin network nodes evolve into edges while *spin network* links evolve into 2-dimensional faces. Edges inherit the intertwiners associated to the nodes and faces inherit the spins associated to links. Therefore, the series of transitions can be represented by a 2-complex whose 1-cells are labelled by intertwiners and whose 2-cells are labelled by spins. The places where the action of the

$$\text{Tr}[\Pi^n(W_p)] \triangleright \begin{array}{c} j \\ \diagdown \\ \text{---} \\ \diagup \\ k \\ | \\ m \end{array} = \sum_{o,p} \frac{1}{\Delta_n \Delta_j \Delta_k \Delta_m} \left\{ \begin{array}{ccc} j & k & m \\ n & o & p \end{array} \right\} \begin{array}{c} j \\ \diagdown \\ \text{---} \\ \diagup \\ k \\ | \\ m \end{array}$$

Figure 13: Graphical notation representing the action of one plaquette holonomy on a *spin network* vertex. The object in brackets ($\{\}$) is a $6j$ -symbol and $\Delta_j := 2j + 1$.

plaquette loop operators create new links (Figure 13 and 14) define 0-cells or vertices. These foam-like structures are the so-called *spin foams*. The *spin foam* amplitudes are purely combinatorial and can be explicitly computed from the simple action of the loop operator in \mathcal{H}_{kin} .

The physical inner product takes the standard Ponzano–Regge form when the *spin network* states s and s' have only 3-valent nodes. Explicitly,

$$\langle s, s' \rangle_p = \sum_{F_{s \rightarrow s'}} \prod_{f \subset F_{s \rightarrow s'}} (2j_f + 1)^{\frac{\nu_f}{2}} \prod_{v \subset F_{s \rightarrow s'}} \begin{array}{c} j_4 \quad j_5 \\ \diagdown \quad \diagup \\ j_3 \\ \diagup \quad \diagdown \\ j_1 \quad j_2 \quad j_6 \end{array}, \quad (239)$$

where the sum is over all the spin foams interpolating between s and s' (denoted $F_{s \rightarrow s'}$, see Figure 18), $f \subset F_{s \rightarrow s'}$ denotes the faces of the spin foam (labeled by the spins j_f), $v \subset F_{s \rightarrow s'}$ denotes vertices, and $\nu_f = 0$ if $f \cap s \neq 0 \wedge f \cap s' \neq 0$, $\nu_f = 1$ if $f \cap s \neq 0 \vee f \cap s' \neq 0$, and $\nu_f = 2$ if $f \cap s = 0 \wedge f \cap s' = 0$. The tetrahedral diagram denotes a $6j$ -symbol: the amplitude obtained by means of the natural contraction of the four intertwiners corresponding to the 1-cells converging at a vertex. More generally, for arbitrary *spin networks*, the vertex amplitude corresponds to $3nj$ -symbols, and $\langle s, s' \rangle_p$ takes the same general form.

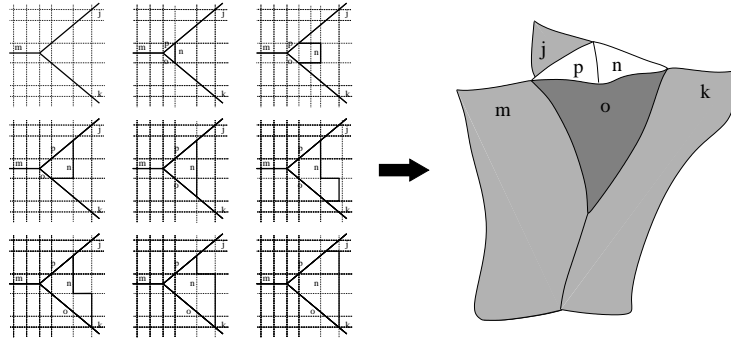

Figure 14: A set of discrete transitions representing one of the contributing histories at a fixed value of the regulator. On the right, the continuous *spin foam representation* when the regulator is removed.

Even though the ordering of the plaquette actions does not affect the amplitudes, the *spin foam representation* of the terms in the sum (239) is highly dependent on that ordering. This is represented in Figure 15 where a spin foam equivalent to that of Figure 12 is obtained by choosing an ordering of plaquettes where those of the central region act first. One can see this freedom of

representation as an analogy of the gauge freedom in the spacetime representation in the classical theory.

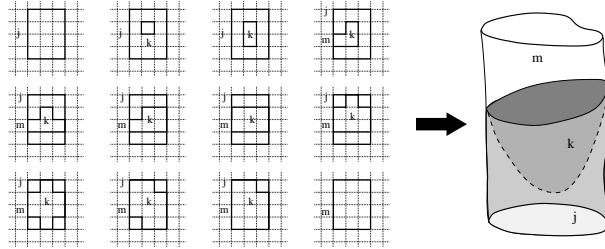

Figure 15: A different representation of the transition of Figure 12. This spin-foam is obtained by a different ordering choice in (237).

One can in fact explicitly construct a basis of \mathcal{H}_{phys} by choosing a linearly independent set of representatives of the equivalence classes defined in (232). One of such basis is illustrated in Figure 16. The number of quantum numbers necessary to label the basis element is $6g - 6$ corresponding to the dimension of the moduli space of $SU(2)$ flat connections on a Riemann surface of genus g . This is the number of degrees of freedom of the classical theory. In this way we arrive at a fully combinatorial definition of the standard \mathcal{H}_{phys} by reducing the infinite degrees of freedom of the kinematical phase space to finitely many by the action of the generalized projection operator P .

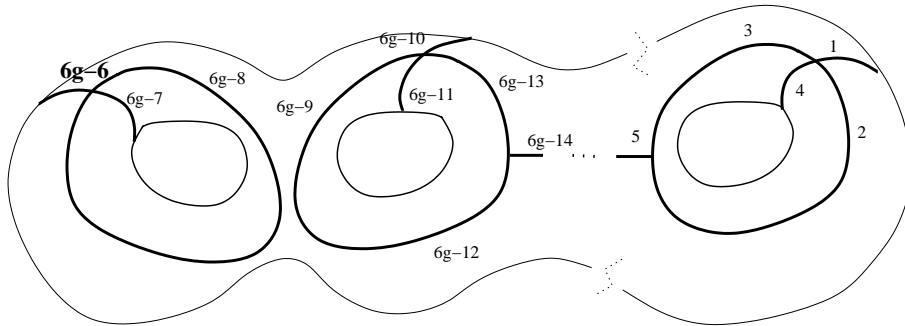

Figure 16: A spin-network basis of physical states for an arbitrary genus g Riemann surface. There are $6g - 6$ spins labels (recall that 4-valent nodes carry an intertwiner quantum number).

14.5 Spin foam quantization of 3d gravity

Here we apply the general framework of Sections 6 and 6.1.2. This has been first studied by Iwasaki (in the spin foam framework) in [223, 222]. The partition function, \mathcal{Z} , is formally given by²⁷

$$\mathcal{Z} = \int \mathcal{D}[e] \mathcal{D}[A] e^{i \int_{\mathcal{M}} \text{Tr}[e \wedge F(A)]}, \quad (240)$$

²⁷ We are dealing with Riemannian 3-dimensional gravity. This should not be confused with the approach of Euclidean quantum gravity formally obtained by a Wick rotation of Lorentzian gravity. Notice the imaginary unit in front of the action. The theory of Riemannian quantum gravity should be regarded as a toy model with no obvious connection to the Lorentzian sector.

where for the moment we assume \mathcal{M} to be a compact and orientable. Integrating over the e field in (240) we obtain

$$\mathcal{Z} = \int \mathcal{D}[A] \delta(F(A)). \quad (241)$$

The partition function \mathcal{Z} corresponds to the ‘volume’ of the space of flat connections on \mathcal{M} .

In order to give a meaning to the formal expressions above, we replace the 3-dimensional manifold \mathcal{M} with an arbitrary cellular decomposition Δ . We also need the notion of the associated dual 2-complex of Δ denoted by Δ^* . The dual 2-complex Δ^* is a combinatorial object defined by a set of vertices $v \in \Delta^*$ (dual to 3-cells in Δ) edges $e \in \Delta^*$ (dual to 2-cells in Δ) and faces $f \in \Delta^*$ (dual to 1-cells in Δ). The fields e and A have support on these discrete structures. The $su(2)$ -valued 1-form field e is represented by the assignment of an $e \in su(2)$ to each 1-cell in Δ . The connection field A is represented by the assignment of group elements $g_e \in SU(2)$ to each edge in Δ^* .

The partition function is defined by

$$\mathcal{Z}(\Delta) = \int \prod_{f \in \Delta^*} de_f \prod_{e \in \Delta^*} dg_e e^{i\text{Tr}[e_f U_f]}, \quad (242)$$

where de_f is the regular Lebesgue measure on \mathbb{R}^3 , dg_e is the Haar measure on $SU(2)$, and U_f denotes the holonomy around faces, i.e., $U_f = g_e^1 \dots g_e^N$ for N being the number of edges bounding the corresponding face. Since $U_f \in SU(2)$ we can write it as $U_f = u_f^0 \mathbb{1} + F_f$ where $u_f^0 \in \mathbb{C}$ and $F_f \in su(2)$. F_f is interpreted as the discrete curvature around the face f . Clearly $\text{Tr}[e_f U_f] = \text{Tr}[e_f F_f]$. An arbitrary orientation is assigned to faces when computing U_f . We use the fact that faces in Δ^* are in one-to-one correspondence with 1-cells in Δ and label e_f with a face subindex.

Integrating over e_f , we obtain

$$\mathcal{Z}(\Delta) = \int \prod_{e \in \Delta^*} dg_e \prod_{f \in \Delta^*} \delta(g_e^1 \dots g_e^N), \quad (243)$$

where δ corresponds to the delta distribution defined on $\mathcal{L}^2(SU(2))$. Notice that the previous equation corresponds to the discrete version of equation (241).

The integration over the discrete connection ($\prod_e dg_e$) can be performed expanding first the delta function in the previous equation using the Peter-Weyl decomposition

$$\delta(g) = \sum_{j \in \text{irrep}(SU(2))} \Delta_j \text{Tr}[j(g)], \quad (244)$$

where $\Delta_j = 2j + 1$ denotes the dimension of the unitary representation j , and $j(g)$ is the corresponding representation matrix. Using equation (244), the partition function (243) becomes

$$\mathcal{Z}(\Delta) = \sum_{\mathcal{C}: \{j\} \rightarrow \{f\}} \int \prod_{e \in \Delta^*} dg_e \prod_{f \in \Delta^*} \Delta_{j_f} \text{Tr}[j_f(g_e^1 \dots g_e^N)], \quad (245)$$

where the sum is over coloring of faces in the notation of (??).

Going from equation (242) to (245) we have replaced the continuous integration over the e 's by the sum over representations of $SU(2)$. Roughly speaking, the degrees of freedom of e are now encoded in the representation being summed over in (245).

Now it remains to integrate over the lattice connection $\{g_e\}$. If an edge $e \in \Delta^*$ bounds n faces there are n traces of the form $\text{Tr}[j_f(\dots g_e \dots)]$ in (245) containing g_e in the argument. The relevant formula is

$$P_{inv}^n := \int dg j_1(g) \otimes j_2(g) \otimes \dots \otimes j_n(g) = \sum_{\iota} C_{j_1 j_2 \dots j_n}^{\iota} C_{j_1 j_2 \dots j_n}^{*\iota}, \quad (246)$$

where P_{inv}^n is the projector onto $\text{Inv}[j_1 \otimes j_2 \otimes \cdots \otimes j_n]$. On the RHS we have chosen an orthonormal basis of invariant vectors (intertwiners) to express the projector. Notice that the assignment of intertwiners to edges is a consequence of the integration over the connection. This is not a particularity of this example but rather a general property of local spin foams. Finally, (243) can be written as a sum over spin foam amplitudes

$$\mathcal{Z}(\Delta) = \sum_{\mathcal{C}:\{j\}\rightarrow\{f\}} \sum_{\mathcal{C}:\{\iota\}\rightarrow\{e\}} \prod_{f \in \Delta^*} \Delta_{j_f} \prod_{v \in \mathcal{J}_\Delta} A_v(\iota_v, j_v), \quad (247)$$

where $A_v(\iota_v, j_v)$ is given by the appropriate trace of the intertwiners ι_v corresponding to the edges bounded by the vertex and j_v are the corresponding representations. This amplitude is given in general by an $SU(2)$ $3Nj$ -symbol corresponding to the flat evaluation of the spin network defined by the intersection of the corresponding vertex with a 2-sphere. When Δ is a simplicial complex all the edges in \mathcal{J}_Δ are 3-valent and vertices are 4-valent (one such vertex is emphasized in Figure 5, the intersection with the surrounding S^2 is shown in dotted lines). Consequently, the vertex amplitude is given by the contraction of the corresponding four 3-valent intertwiners, i.e., a $6j$ -symbol. In that case the partition function takes the familiar Ponzano–Regge [303] form

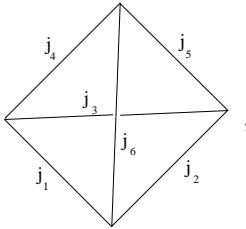
$$\mathcal{Z}(\Delta) = \sum_{\mathcal{C}:\{j\}\rightarrow\{f\}} \prod_{f \in \Delta^*} \Delta_{j_f} \prod_{v \in \Delta^*} \text{Diagram}, \quad (248)$$

were the sum over intertwiners disappears since $\dim(\text{Inv}[j_1 \otimes j_2 \otimes j_3]) = 1$ for $SU(2)$ and there is only one term in (246). Ponzano and Regge originally defined the amplitude (248) from the study of the asymptotic properties of the $6j$ -symbol.

14.5.1 Discretization independence

A crucial property of the partition function (and transition amplitudes in general) is that it does not depend on the discretization Δ . Given two different cellular decompositions Δ and Δ' (not necessarily simplicial)

$$\tau^{-n_0} Z(\Delta) = \tau^{-n'_0} Z(\Delta'), \quad (249)$$

where n_0 is the number of 0-simplexes in Δ (hence the number of bubbles in \mathcal{J}_Δ), and $\tau = \sum_j (2j+1)$ is clearly divergent which makes discretization independence a formal statement without a suitable regularization.

The sum over spins in (248) is typically divergent, as indicated by the previous equation. Divergences occur due to infinite volume factors corresponding to the topological gauge freedom (226)(see [180])²⁸. The factor τ in (249) represents such volume factor. It can also be interpreted

²⁸ For simplicity we concentrate on the Abelian case $G = U(1)$. The analysis can be extended to the non-Abelian case. Writing $g \in U(1)$ as $g = e^{i\theta}$ the analog of the gravity simplicial action is

$$S(\Delta, \{e_f\}, \{\theta_e\}) = \sum_{f \in \Delta^*} e_f F_f(\{\theta_e\}), \quad (250)$$

where $F_f(\{\theta_e\}) = \sum_{e \in f} \theta_e$. Gauge transformations corresponding to (225) act at the end points of edges $e \in \mathcal{J}_\Delta$ by the action of group elements $\{\beta\}$ in the following way

$$\begin{aligned} B_f &\rightarrow B_f, \\ \theta_e &\rightarrow \theta_e + \beta_s - \beta_t, \end{aligned} \quad (251)$$

as a $\delta(0)$ coming from the existence of a redundant delta function in (243). One can partially gauge fix this freedom at the level of the discretization. This has the effect of eliminating bubbles from the 2-complex.

In the case of simply connected Σ the gauge fixing is complete. One can eliminate bubbles and compute finite transition amplitudes. The result is equivalent to the physical scalar product defined in the canonical picture in terms of the delta measure²⁹.

In the case of gravity with cosmological constant the state-sum generalizes to the Turaev–Viro model [358] defined in terms of $SU_q(2)$ with $q^n = 1$ where the representations are finitely many. Heuristically, the presence of the cosmological constant introduces a physical infrared cutoff. Equation (249) has been proved in this case for the case of simplicial decompositions in [358], see also [357, 232]. The generalization for arbitrary cellular decomposition was obtained in [200].

14.5.2 Transition amplitudes

Transition amplitudes can be defined along similar lines using a manifold with boundaries. Given Δ , \mathcal{J}_Δ then defines graphs on the boundaries. Consequently, spin foams induce spin networks on the boundaries. The amplitudes have to be modified concerning the boundaries to have the correct composition property (74). This is achieved by changing the face amplitude from (Δ_{j_f}) to $(\Delta_{j_\ell})^{1/2}$ on external faces.

The crucial property of this spin foam model is that the amplitudes are independent of the chosen cellular decomposition [357, 200]. This allows for computing transition amplitudes between any spin network states $s = (\gamma, \{j\}, \{\iota\})$ and $s' = (\gamma', \{j'\}, \{\iota'\})$ according to the following rules³⁰:

- Given $\mathcal{M} = \Sigma \times [0, 1]$ (piecewise linear) and spin network states $s = (\gamma, \{j\}, \{\iota\})$ and $s' = (\gamma', \{j'\}, \{\iota'\})$ on the boundaries – for γ and γ' piecewise linear graphs in Σ – choose any cellular decomposition Δ such that the dual 2-complex \mathcal{J}_Δ is bordered by the corresponding graphs γ and γ' respectively (existence can be shown easily).
- Compute the transition amplitude between s and s' by summing over all spin foam amplitudes (rescaled as in (249)) for the spin foams $F : s \rightarrow s'$ defined on the 2-complex \mathcal{J}_Δ .

14.5.3 The generalized projector

We can compute the transition amplitudes between any element of the kinematical Hilbert space \mathcal{H}^{31} . Transition amplitudes define the physical scalar product by reproducing the skein relations

where the sub-index s (respectively t) labels the source vertex (respectively target vertex) according to the orientation of the edge. The gauge invariance of the simplicial action is manifest. The gauge transformation corresponding to (226) acts on vertices of the triangulation Δ and is given by

$$\begin{aligned} B_f &\rightarrow B_f + \eta_s - \eta_t, \\ \theta_e &\rightarrow \theta_e. \end{aligned} \tag{252}$$

According to the discrete analog of Stokes theorem

$$\sum_{f \in \text{Bubble}} F_f(\{\theta_e\}) = 0,$$

which implies the invariance of the action under the transformation above. The divergence of the corresponding spin foam amplitudes is due to this last freedom. Alternatively, one can understand it from the fact that Stokes theorem implies a redundant delta function in (243) per bubble in \mathcal{J}_Δ .

²⁹ If $\mathcal{M} = S^2 \times [0, 1]$ one can construct a cellular decomposition interpolating any two graphs on the boundaries without having internal bubbles and hence no divergences.

³⁰ Here we are ignoring various technical issues in order to emphasize the relevant ideas. The most delicate is that of the divergences due to gauge factors mentioned above. For a more rigorous treatment see [365, 366].

³¹ The sense in which this is achieved should be apparent from our previous definition of transition amplitudes. For a rigorous statement see [365, 366].

of the canonical analysis. We can construct the physical Hilbert space by considering equivalence classes under states with zero transition amplitude with all the elements of \mathcal{H} , i.e., null states.

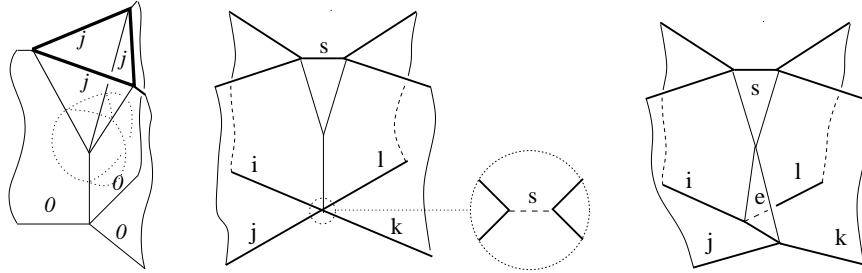

Figure 17: Elementary spin foams used to prove skein relations.

Here we explicitly construct a few examples of null states. For any contractible Wilson loop in the j representation the state

$$\psi = (2j + 1) s - \bigcirc_j \otimes_{phys} s \stackrel{=}{=} 0, \quad (253)$$

for any spin network state s , has vanishing transition amplitude with any element of \mathcal{H} . This can be easily checked by using the rules stated above and the portion of spin foam illustrated in Figure 17 to show that the two terms in the previous equation have the same transition amplitude (with opposite sign) for any spin-network state in \mathcal{H} . Using the second elementary spin foam in Figure 17 one can similarly show that

$$\begin{array}{c} i & l \\ \diagdown & / \\ & s \\ / & \diagdown \\ j & k \end{array} - \begin{array}{c} i & l \\ / & \diagdown \\ & s \\ \diagdown & / \\ j & k \end{array} \stackrel{=}{=}_{phys} 0, \quad (254)$$

or the re-coupling identity using the elementary spin foam on the right of Figure 17

$$\begin{array}{c} i & l \\ \diagdown & / \\ & s \\ / & \diagdown \\ j & k \end{array} - \sum_e \sqrt{2s+1} \sqrt{2e+1} \left\{ \begin{array}{ccc} i & j & s \\ & k & l & e \end{array} \right\} \begin{array}{c} i & l \\ / & \diagdown \\ & e \\ \diagdown & / \\ j & k \end{array} \stackrel{=}{=}_{phys} 0, \quad (255)$$

where the quantity in brackets represents an $SU(2)$ $6j$ -symbol. All skein relations can be found in this way. The transition amplitudes imply the skein relations that define the physical Hilbert space! The spin foam quantization is equivalent to the canonical one.

14.5.4 The continuum limit

Recently, Zapata [365, 366] formalized the idea of a continuum spin foam description of 3-dimensional gravity using projective techniques inspired by those utilized in the canonical picture [28]. The heuristic idea is that due to the discretization invariance one can define the model in an ‘infinitely’ refined cellular decomposition that contains any possible spin network state on the boundary (this intuition is implicit in our rules for computing transition amplitudes above). Zapata concentrates on the case with non-vanishing cosmological constant and constructs the continuum extension of the Turaev–Viro model.

14.6 Conclusion

We have illustrated the general notion of the spin foam quantization in the simple case of 3 dimensional Riemannian gravity (for the generalization to the Lorentzian case see [172]). The main goal of the approach is to provide a definition of the physical Hilbert space. The example of this section sets the guiding principles of what one would like to realize in four dimensions. However, as should be expected, there are various new issues that make the task by far more involved.

14.7 Further results in 3d quantum gravity

In this part of the article we have reviewed $SU(2)$ BF theory as from the perspective of classical and quantum gravity in three dimensions (for a classic reference see [106]). The state sum as presented above matches the quantum amplitudes first proposed by Ponzano and Regge in the 1960s based on their discovery of the asymptotic expressions of the $6j$ -symbols [303] and is often referred to as the Ponzano–Regge model. Divergences in the above formal expression require regularization. We have seen in Section 14.3 that transition amplitudes are indeed finite in the canonical framework where $M = \Sigma \times R$. Natural regularizations are available in more general cases [61, 275, 180]. For a detailed study of the divergence structure of the model see [94, 95, 96]. The quantum deformed version of the above amplitudes lead to the so called Turaev–Viro model [358] which is expected to correspond to the quantization of three dimensional Riemannian gravity in the presence of a non vanishing positive cosmological constant.

The topological character of BF theory can be preserved by the coupling of the theory with topological defects playing the role of point particles. In the spin foam literature this has been considered from the canonical perspective in [273, 274] and from the covariant perspective extensively by Freidel and Louapre [182]. These theories have been shown by Freidel and Livine to be dual, in a suitable sense, to certain non-commutative fields theories in three dimensions [179, 178].

Concerning coupling BF theory with non topological matter see [166, 149] for the case of fermionic matter, and [341] for gauge fields. A more radical perspective for the definition of matter in 3d gravity is taken in [167]. For three dimensional supersymmetric BF theory models see [243, 32].

Recursion relations for the $6j$ vertex amplitudes have been investigated in [92, 151]. They provide a tool for studying dynamics in spin foams of 3d gravity and might be useful in higher dimensions [93].

Part V

Conceptual issues and open problems

In this last part of this review we discuss some important conceptual issues that remain open questions to a large degree in the formulation. The description of the completely solvable model of the previous section will serve as the main example to illustrate some of these issues.

14.8 Quantum spacetime and gauge-histories

What is the geometric meaning of the spin foam configurations? Can we identify the spin foams with “*quantum spacetime configurations*”? The answer to the above questions is, strictly speaking, in the negative in agreement with our discussion at the end of Section 2.2. Physical degrees of freedom are extracted from the huge set of kinematical ones by the sum over gauge-histories that is realized in the spin foam representation.

This conclusion is illustrated in an exact way the simple example in 2+1 gravity where $M = S^2 \times \mathbb{R}$ ($g = 0$) described in detail in previous sections. In this case the spin foam configurations appearing in the transition amplitudes look locally the same to those appearing in the representation of P for any other topology. However, a close look at the physical inner product defined by P permits to conclude that the physical Hilbert space is one dimensional – the classical theory has zero degree of freedom and so there is no non-trivial Dirac observable in the quantum theory. This means that the sum over spin foams in Eq. (239) is nothing else but a sum over *pure gauge degrees of freedom* and hence no physical interpretation can be associated to it. The spins labelling the intermediate spin foams do not correspond to any measurable quantity. For any other topology this still holds true, the true degrees of freedom being of a global topological character. This means that in general (even when local excitations are present as in 4d) the spacetime geometric interpretation of the spin foam configurations is subtle. This is an important point that is often overlooked in the literature: one cannot interpret the spin foam sum of Eq. (239) as a sum over geometries in any obvious way. Its true meaning instead comes from the averaging over the gauge orbits generated by the quantum constraints that defines P – recall the classical picture Figure 2, the discussion around Eq. (8), and the concrete implementation in 2+1 where $U(N)$ in (230) is the unitary transformation representing the orbits generated by F . Spin foams represent a *gauge history* of a kinematical state. A sum over gauge histories is what defines P as a means for extracting the true degrees of freedom from those which are encoded in the kinematical boundary states.

Here we are discussing the interpretation of the *spin foam representation* in the precise context of our solvable 3d example; however, the validity of the conclusion is of general character and holds true in the case of physical interest: four dimensional LQG. Although, the quantum numbers labelling the spin foam configurations correspond to eigenvalues of *kinematical* geometric quantities such as length (in 2+1) or area (in 3+1) LQG, their physical meaning and *measurability* depend on dynamical considerations (for instance the naive interpretation of the spins in 2+1 gravity as quanta of physical length is shown here to be of no physical relevance). Quantitative notions such as time, or distance as well as qualitative statements about causal structure or time ordering are misleading (at best) if they are naively constructed in terms of notions arising from an interpretation of *spin foams* as quantum spacetime configurations.

Now this does not mean that kinematical features (that usually admit simpler geometric interpretation) is completely meaningless. It may be that such kinematical quantum geometric considerations might reflect true physical features when Dirac observables are considered. For instance, the simplicial geometry interpretation of spin foam histories (e.g., the total area of a polyhedron associated to a spin network vertex) is the analog of the computation of some classical geometric quantity in general relativity (e.g. the area of some closed surface embedded in spacetime). Both the former and the latter have no intrinsic physical meaning: in the first case as argued above in the second case because of the absent diffeomorphism invariant characterization of the surface. However, in classical general relativity, the ability of computing area of surfaces is useful to construct a physical meaningful quantity such as the area of the event horizon in Schwarzschild spacetime which is a fully diffeomorphism invariant property of the BH spacetime. Similarly, all the machinery of quantum geometry (and its simplicial geometric interpretation in suitable cases) might play an important role in the construction of the physically meaningful objects (Dirac observables) of

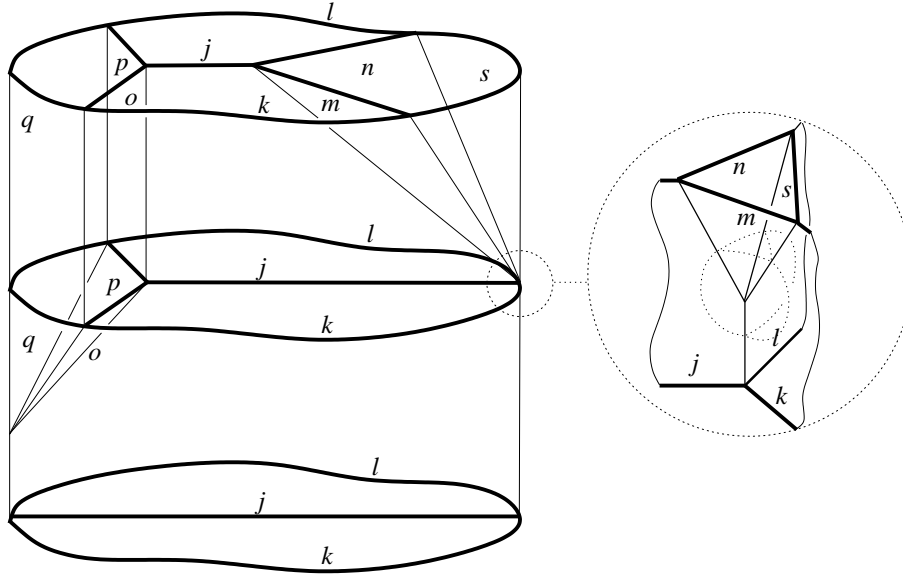

Figure 18: A *spin foam* as the ‘colored’ 2-complex representing the transition between three different *spin network* states: it represents a pure gauge-history interpolating between kinematical boundary quantum geometry states. The sum over such histories in the spin foam representation of the path integral is meant to project out gauge degrees of freedom in order to extract the true physical information out of the kinematical Hilbert space.

quantum gravity ³².

It is well known (and can be illustrated by many simple examples) that gauge invariant properties can often be obtained by the suitable combination of gauge covariant quantities. For example, in Yang–Mills theory the holonomy $h(\gamma_{AB}) \in G$ from a point A to a point B along a path γ_{AB} connecting the two points is not physically meaningful. Nor is the value of some field multiplets $\Psi(A)$ and $\Psi(B)$ at points A and B respectively. A physically meaningful quantity arises from the gauge invariant combination of the above quantities, namely $\langle \Psi(A)h(\gamma_{AB})\Psi(B) \rangle$. The pure gauge character of the quantum geometric interpretation pointed out above in the simple 3d context corresponds to the holonomy $h(\gamma_{AB}) \in G$ in the above analogy. As soon as we couple 2+1 gravity with matter fields (corresponding to the Ψ in the above analogy) non-trivial Dirac observables become available (in fact such theory would have local degrees of freedom). These will have to encode the *relationship* between the gauge dependent geometry and the gauge dependent field content in a gauge invariant fashion.

In four dimensions we do not need to add anything as gravity has already its local degrees of freedom yet physically meaningful questions are still *relational* (for more discussion see [] and). Unfortunately, no background independent quantum theory with local degrees of freedom is sufficiently simple to illustrate this with an example. There is no lucky example as what are *free quantum field theories* for standard QFT (non linearity and background independence may go hand-in-hand). In four dimensions, and in particular, in the case of the spin foam models described in this review, the difficult question of extracting physics from the models is very important and

³² An interesting example where this is strictly realized is the midi-superspace formulation of black holes in the context of loop quantum gravity known as the *isolated horizon* formulation (see [27] for a review). In this framework the area of what represents the black hole horizon is a Dirac observable and has a discrete spectrum inherited from the area spectrum of the kinematical area in the full theory [22]. Such discreteness is crucial in recovering the Bekenstein–Hawking area law for the black hole entropy in LQG [164, 21].

presents a major challenge for the future. The references discussed in Section 13.3 are important encouraging steps into this direction.

14.9 Anomalies and gauge fixing

As we mentioned before and illustrated with the example of three dimensional gravity (see discussion in Section 14.8) the spin foam path integral is meant to provide a definition of the physical Hilbert space. Spin foam transition amplitudes are not interpreted as defining propagation in time but rather as defining the physical scalar product. This interpretation of spin foam models is the one consistent with general covariance. However, in the path integral formulation, this property relies on the gauge invariance of the path integral measure. If the measure meets this property we say it is *anomaly free*. It is well known that in addition to the invariance of the measure, one must provide appropriate gauge fixing conditions for the amplitudes to be well defined. In this section we analyze these issues in the context of the spin foam approach.

Since we are interested in gravity in the first order formalism, in addition to diffeomorphism invariance one has to deal with the gauge transformations in the internal space. Let us first describe the situation for the latter. If this gauge group is compact then anomaly free measures are defined using appropriate variables and invariant measures. In this case gauge fixing is not necessary for the amplitudes to be well defined. Examples where this happens are: the models of Riemannian gravity considered in this paper (the internal gauge group being $SO(4)$ or $SU(2)$), and standard lattice gauge theory. In these cases, one represents the connection in terms of group elements (holonomies) and uses the (normalized) Haar measure in the integration. In the Lorentzian sector (internal gauge group $SL(2, \mathbb{C})$) the internal gauge orbits have infinite volume and the lattice path integral would diverge without an appropriate gauge fixing condition. These conditions generally exist in spin foam models and are used to regularize the vertex amplitudes of the Lorentzian models (we have illustrated this at the end of Section 8.3; for a general treatment see [180]).

The remaining gauge freedom is diffeomorphism invariance. To illustrate this issue we concentrate on the case of a model defined on a fixed discretization Δ as it is the usual setting for calculations dealing with the models in four dimensions.

Let us start by considering the spin network states, at $\partial\Delta^*$: boundary of Δ^* , for which we want to define the transition amplitudes. According to what we have learned from the canonical approach, 3-diffeomorphism invariance is implemented by considering (diffeomorphism) equivalence classes of spin-network states. In the context of spin foams, the underlying discretization Δ restricts the graphs on the boundary to be contained on the dual 1-skeleton of the boundary complex $\partial\Delta^*$. These states are regarded as representative elements of the corresponding 3-diffeomorphism equivalence class. The discretization can be interpreted, in this way, as a gauge fixing of 3-diffeomorphisms on the boundary. This gauge fixing is partial in the sense that, generically, there will remain a discrete symmetry remnant given by the discrete symmetries of the spin network. This remaining symmetry has to be factored out when computing transition amplitudes (in fact this also plays a role in the definition of the kinematical Hilbert space of LQG).

A natural view point (consistent with LQG and quantum geometry) is that this should naturally generalize to 4-diffeomorphisms for spin foams. The underlying 2-complex \mathcal{J}_Δ on which spin foams are defined represents a partial gauge fixing for the configurations (spin foams) entering in the path integral. The remaining symmetry, to be factored out in the computation of transition amplitudes, corresponds simply to the finite group of discrete symmetries of the corresponding spin foams³³. This factorization is well defined since the number of equivalent spin foams can be characterized in a fully combinatorial manner, and is finite for any spin foam defined on a finite discretization. In addition, a spin foam model is anomaly free if the amplitudes are invariant under this discrete

³³ Baez [34] points out this equivalence relation between spin foams as a necessary condition for the definition of the *category of spin foams*.

symmetry. We have seen that this requirement (advocated in [84]) can be met by suitable definitions of the transition amplitudes [45, 229] (see Section 7.5).

However, it is expected – from the experience in lower dimensional background independent models (recall the discussion of the previous section) – that there will be remnants of the gauge symmetries acting non trivially on spin foams histories by doing more than simply changing the embedding in the discrete regulating structure Δ as described above. After all, in gravity the Hamiltonian constraint generates gauge transformations that hide in themselves the non trivial dynamics of the theory. This is illustrated precisely in the simplest scenario of 3d gravity where it is well known that bubble divergencies are directly linked to the infinite volume of the gauge orbits generated by the curvature constraint [180]. The action of such gauge symmetry related spin foams that do not differ only by their embedding (see Section 14).

It is also important to point out that the view that spin foams represent diffeomorphism equivalence classes of geometries, which sometimes can be loosely stated in the community, is incompatible with the idea that spin foams should act as a projector onto the solutions of constraints. A path integral would only act as a projector if it includes gauge symmetries in the sense of group averaging. This related to the fact that physical states (those left invariant by the projector) are outside the kinematical Hilbert space, i.e. non-normalizable.

The discretization of the manifold Δ is seen as a regulator introduced to define the spin foam model. Even when the regulator (or the discretization dependence) eventually has to be removed (see next subsection), the theory is presumed to remain discrete at the fundamental level. The smooth manifold diffeomorphism invariant description is expected to emerge in the (low energy) continuum limit. Fundamental excitations are intrinsically discrete. From this viewpoint, the precise meaning of the gauge symmetries of such a theory would have to be formulated directly at the discrete level. We have seen that this can be achieved in the case of 3-dimensional gravity (recall Section 14.5.1).

The previous paragraph raises the question of whether the discretization procedures used in the derivation of the spin foams are compatible with the expectation that one is approximating a diffeomorphism invariant fundamental theory. More precisely, can one tell whether the diffeomorphism invariance is broken or not by our regularization procedure. This question is a quite important one and has been one of the central concerns of the work led by B. Dittrich and collaborators for the last few years [145, 141, 144, 138, 39]. There exist indeed possible discretizations of a field theory which maintain the full symmetry content of their continuum relatives. These regularizations are called *perfect actions* and even when they are difficult to construct explicitly in general cases there are in principle methods (based on renormalization group ideas) to approach them [138, 40] (see also [44] and [42] for more recent discussion and explicit calculations in the perturbative context).

There are however indications that the discretization procedures used generically do break the general covariance of gravity. In the simple case of 3d gravity with cosmological constant this can be shown explicitly at the classical level [41] as well as at the quantum level [298]. In the first reference it is shown nonetheless that there exist a well defined perfect action in this case. At the quantum level the results of [276] indicate a possible resolution of the anomaly issue. In four dimensions, this was first validated by the results obtained by Gambini and Pullin et al. in the so-called *consistent discretization* approach [184, 192, 193, 191, 190, 131, 132, 189, 185, 188]. They study the canonical formulation of theories defined on a lattice from the onset. The consistent discretization approach provides a way to analyzing the meaning of gauge symmetries directly à la Dirac. Their results indicate that diff-invariance is indeed broken by the discretization in the sense that there is no infinitesimal generator of diffeomorphism. This is consistent with the covariant picture of discrete symmetries above. In their formulation the canonical equations of motion fix the value of what were Lagrange multipliers in the continuum (e.g., lapse and shift). This is interpreted as a breaking of diffeomorphism invariance; however, the solutions of the multiplier equations are highly non unique. The ambiguity in selecting a particular solution corresponds

to the remnant diffeomorphism invariance of the discrete theory. More recently, the issue of the breaking of the diffeomorphism symmetry by the regularizations used in spin foams has been studied by the Dittrich group (see references above). A possibility of using very simple models to study these questions has been open in [43].

An important question is whether the possible breaking of the diffeomorphisms gauge symmetry by the regularization can be made to disappear in the continuum limit. The breaking of a gauge symmetry implies the existence of a new host of degrees of freedom that might be in conflict with the low energy interaction one is trying to recover in that limit³⁴. In addition the breaking of non-compact symmetries by a regulating structure poses serious difficulties for the low energy regime even in the case of global symmetries [109] (see [194, ?] and [302] for a recent discussion). We mention this point here because it is in our opinion of a major importance. Even though the question seems quite difficult to address in the context of the present models at this stage it must be kept in mind in search of opportunities of further insights.

However, the notion of anomaly freeness evoked at the beginning of this section should be strengthened. In fact according to our tentative definition, an anomaly free measure can be multiplied by any gauge invariant function and yield a new anomaly free measure. This kind of ambiguity is not wanted; however, it is in fact present in most of the spin foam models defined so far: In standard QFT theory, the formal (phase space) path integral measure in the continuum has a unique meaning (up to a constant normalization) emerging from the canonical formulation. Provided an appropriate gauge fixing, the corresponding Dirac bracket determines the formal measure on the gauge fixed constraint surface. In the discussion in Section 12.1 we have provided references where this issue is analyzed.

14.10 Discretization dependence

The spin foam models we have introduced so far are defined on a fixed cellular decomposition of \mathcal{M} . This is to be interpreted as an intermediate step toward the definition of the theory. The discretization reduces the infinite dimensional functional integral to a multiple integration over a finite number of variables. This cutoff is reflected by the fact that only a restrictive set of spin foams (spin network histories) is allowed in the path integral: those that can be obtained by all possible coloring of the underlying 2-complex. In addition it restricts the number of possible 3-geometry states (spin network states) on the boundary by fixing a finite underlying boundary graph. This represents a truncation in the allowed fluctuations and the set of states of the theory playing the role of a regulator. However, the nature of this regulator is fundamentally different from the standard concept in the background independent framework: since geometry is encoded in the coloring (that can take any spin values) the configurations involve fluctuations all the way to Plank scale³⁵. This scenario is different in lattice gauge theories where the lattice introduces an effective UV cutoff given by the lattice spacing. Transition amplitudes are however discretization dependent now. A consistent definition of the path integral using spin foams should include a prescription to eliminate this discretization dependence.

A special case is that of topological theories such as gravity in 3 dimensions. In this case, one can define the sum over spin foams with the aid of a fixed cellular decomposition Δ of the manifold. Since the theory has no local excitations (no gravitons), the result is independent of the chosen cellular decomposition. A single discretization suffices to capture the degrees of freedom of the topological theory.

³⁴ Breaking gauge symmetries comes hand-in-hand with introducing (unwanted) new degrees of freedom. For example, longitudinal photon modes would appear if $U(1)$ gauge symmetry is violated in electromagnetism; similar spurious modes come to life if diffeomorphism invariance is broken in gravity theories.

³⁵ Changing the label of a face from j to $j + 1$ amounts to changing an area eigenvalue by an amount of the order of Planck length squared according to (71).

In lattice gauge theory the solution to the problem is implemented through the so-called continuum limit. In this case the existence of a background geometry is crucial, since it allows one to define the limit when the lattice constant (length of links) goes to zero. In addition the possibility of working in the Euclidean regime allows the implementation of statistical mechanical methods.

None of these structures are available in the background independent context. The lattice (triangulation) contains only topological information and there is no geometrical meaning associated to its components. As we mentioned above this has the novel consequence that the truncation cannot be regarded as an UV cutoff as in the background dependent context. This in turn represents a conceptual obstacle to the implementation of standard techniques. Moreover, no Euclidean formulation seems meaningful in a background independent scenario. New means to eliminate the truncation introduced by the lattice need to be developed. For a recent analysis where the difference between lattice regularization of background dependent versus background independent theories is carefully considered see [320]. For a more general discussion see [318].

This is a major issue where concrete results have not been obtained so far beyond the topological case. Here we explain the two main approaches to recover general covariance corresponding to the realization of the notion of ‘summing over discretizations’ of [314].

- *Refinement of the discretization:*

According to this idea topology is fixed by the simplicial decomposition. The truncation in the number of degrees of freedom should be removed by considering triangulations of increasing number of simplexes for that fixed topology. The flow in the space of possible triangulations is controlled by the Pachner moves. The idea is to take a limit in which the number of four simplexes goes to infinity together with the number of tetrahedra on the boundary. Given a 2-complex \mathcal{J}_2 which is a refinement of a 2-complex \mathcal{J}_1 then the set of all possible spin foams defined on \mathcal{J}_1 is naturally contained in those defined on \mathcal{J}_2 (taking into account the equivalence relations for spin foams mentioned in the previous section). The refinement process should also enlarge the space of possible 3-geometry states (spin networks) on the boundary recovering the full kinematical sector in the limit of infinite refinements. An example where this procedure is well defined is Zapata’s treatment of the Turaev–Viro model [365]. The key point in this case is that amplitudes are independent of the discretization (due to the topological character of the theory) so that the refinement limit is trivial. In the general case the definition of the refinement limit has been recently studied and formalized in [321]. There is no evidence as to whether the amplitudes of any of the present models for 4d converges in such limit.

It has been often emphasized that such refinement limit may be studied from the Wilsonian renormalization view point. In the past a renormalization approach for spin foams have been proposed by Markopoulou [260, 259]. Also Oeckl [279] has studied the issue of renormalization in the context of spin foam models containing a coupling parameter. These models include generalized covariant gauge theories [278, 300, 285], the Reisenberger model, and the so called *interpolating model* (defined by Oeckl). The latter is given by a one-parameter family of models that interpolate between the trivial BF topological model and the Barrett–Crane model according to the value of a ‘coupling constant’. Qualitative aspects of the renormalization groupoid flow of the couplings are studied in the various models.

- *Spin foams as Feynman diagrams:*

This idea has been motivated by the generalized matrix models of Boulatov and Ooguri [99, 286]. The fundamental observation is that spin foams admit a dual formulation in terms of a field theory over a group manifold [127, 309, 308]. The duality holds in the sense that spin foam amplitudes correspond to Feynman diagram amplitudes of the GFT. The perturbative Feynman expansion of the GFT (expansion in a fiducial coupling constant λ) provides a

definition of *sum over* discretizations which is fully combinatorial and hence independent of any manifold structure³⁶. The latter is most appealing feature of this approach. For a recent reference proposing a GFT for the EPRL type of models see [49].

However, the convergence issues clearly become more involved. The perturbative series are generically divergent. This is not necessarily a definite obstruction as divergent series can often be given an asymptotic meaning and provide physical information. Moreover, there are standard techniques that can allow to ‘re-sum’ a divergent series in order to obtain non perturbative information [313]. Freidel and Louapre [181] have shown that this is indeed possible for certain GFT’s in three dimensions. Other possibilities have been proposed in [309].

Diffeomorphism equivalent configurations (in the discrete sense described above) appear at all orders in the perturbation series³⁷. From this perspective (and leaving aside the issue of convergence) the sum of different order amplitudes corresponding to equivalent spin foams should be interpreted as the definition of the physical amplitude of that particular spin foam. The discussion of the previous section does not apply in the GFT formulation, i.e., there is no need for gauge fixing.

The GFT formulation could resolve by definition the two fundamental conceptual problems of the spin foam approach: diffeomorphism gauge symmetry and discretization dependence. The difficulties are shifted to the question of the physical role of λ and the convergence of the corresponding perturbative series. A prescription that avoids this last issue is the radical proposal of Freidel [173] where the tree-level GFT amplitudes are used to define the physical inner product of quantum gravity.

In three dimensions this idea has been studied in more detail. In [256] scaling properties of the modification of the Boulatov group field theory introduced in [181] was studied in detail. In a further modification of the previous model (known as coloured tensor models [202]) new techniques based on a suitable $1/N$ expansion imply that amplitudes are dominated by spherical topology [201]; moreover, it seems possible that the continuum limit might be critical as in certain matrix models [204, 89, 203, 205, 332]. However, it is not yet clear if there is a sense in which these models correspond to a physical theory. The appealing possible interpretation of the models is that they correspond to a formulation of 3d quantum gravity including a dynamical topology. No much is known about gravity models in four dimensions at this stage.

Finally, discretization independence is not only a problem of spin foams but also of Regge gravity. Even linearized classical Regge calculus is not discretization independent in 4d as shown in [146] where a general discussion of the issues raised in this section are considered. It is also natural to expect the issue of discretization independence to be connected to the issue of diffeomorphism symmetry discussed in the previous section. There is evidence [42, 140, 139] that implementation of diffeomorphism symmetry into the models will lead to discretization independence.

14.11 Lorentz invariance in the effective low energy regime

Finally a very important question for loop quantum gravity and spin foams (closely related to the consistency of their low energy limit) is that of the fate of Lorentz symmetry in the low energy regime. This question has received lots of attention in recent years as it seems to provide an open

³⁶This is more than a ‘sum over topologies’ as many of the 2-complex appearing in the perturbative expansion cannot be associated to any manifold [128].

³⁷The GFT formulation is clearly non trivial already in the case of topological theories. There has been attempts to make sense of the GFT formulation dual to BF theories in lower dimensions [251].

window of opportunity for observations of quantum gravity effects (see [264, 227] and references therein). In the context of loop quantum gravity a systematic first-principles analysis of such properties of the low energy regime remains open. This is mainly due to the presently unsolved difficulties associated with a quantitative dynamical description of physical states. The spin foam approach discussed in this review is meant to address the dynamical question and the definition of the new models may provide the necessary insights to tackle the relevant aspects for the question of Lorentz invariance at low energies. This question is perhaps within reach at the present stage of development of the theory, so it deserves all the attention in future investigations.

In the absence of detailed formulations, certain early pioneering model calculations [187] (see also general treatment [333, 334]) indicated the possibility for certain Lorentz invariance violating (LIV) effects associated to a quantum gravity granularity of spacetime measured at rest by a preferred frame of observers. The effects take the form of corrections to the effective Lagrangian with LIV terms of dimension 5 or higher that are suppressed by negative powers of the Planck mass. This makes them in principle negligible at low energies so that the potential quantum gravity effects would be observed as corrections to the standard QFT well tested physics. However, it was soon realised [109] that the framework of effective field theories severely restricts the possibility that LIV remains small when interactions in QFT are taken into account. In fact dimension 5 or higher LIV terms will generically (in the absence of some fundamental protecting mechanism) generate dimension 4 and lower LIV terms (with factors in front that are at best quadratic in standard model coupling constants). Such unsuppressed contributions are in flagrant conflict with the observed Lorentz invariance of particle physics at low energies.

Therefore, the early calculations in LQG cited above need to be revised under the light of the strong constraints on the way LIV can arise in quantum gravity. A logical possibility is that these LIV terms are there thanks to the protecting effect of some custodial mechanism restricting the LIV to dimension 5 and higher operators³⁸. For example such possibility has been considered in [194] where it is shown that the large LIV effects can be avoided in the context of Euclidean field theory (the protecting mechanism being here the trading of the non-compact Poincare group by the Euclidean group). This example is interesting but unfortunately does not provide an answer to the question for the physical Lorentzian theory (see discussion in [108] and more recently [302]).

There is thus a challenge for LQG and spin foams consisting of showing that the low energy limit of the theory is compatible with the observed low energy LI. This can be put in the form of two conservative possibilities. The description of the low energy physics in terms of

1. an effective action with no LIV terms, or
2. an effective action where LIV terms appear starting from dimension 5 operators on due to some fundamental protecting mechanism in LQG for such structure to be stable under radiative corrections.

My view, based on the ignorance of a suitable protecting mechanism in LQG, is that only the first possibility is sensible. This would mean that the way the fundamental Planckian discreteness of LQG must enter physics is through reference frame independent phenomena (as mass enters a Klein–Gordon theory). In my opinion the main ingredient that must be taken into account in considering this issue is the construction of the low energy limit of quantum gravity in terms of physical or gauge invariant notions (see discussion in Section 14.8). The LIV effects obtained in LQG so far promote by assumption the kinematical discreteness of quantum geometry to discreteness of the physical background in a literal fashion (on the one hand discreteness of geometric can coexist with Lorentz invariance [324], on the other hand, at the level of gauge invariant observables

³⁸For an example of protecting symmetry see [107]; however, notice that the non-compact nature of the protecting symmetry in this case makes it seemingly unsuitable for a sensible possibility in LQG.

some discrete aspect could disappear [148]). The limitations of such naive view point on kinematical discreteness versus physical properties in the theory is, in my view, best manifested in the the setting of pure 3d gravity as discussed above.

For completeness we add that in addition to the above (conservative) possibilities, some less standard scenario could be realized. This has been the view point of some part of the quantum gravity community. For a recent proposal of a completely new theoretical framework see [18] and references therein.

15 Acknowledgements

I would like to thank the help of many people in the field that have helped me in various ways. I am grateful to Benjamin Bahr, Eugenio Bianchi, Bianca Dittrich, Carlo Rovelli and Simone Speziale for the many discussions on aspects and details of the recent literature. Many detailed calculations that contributed to the presentation of the new models in this review were done in collaboration with Mercedes Velázquez to whom I would like to express my gratitude. I would also like to thank You Ding, Florian Conrady, Laurent Freidel, Muxin Han, Merced Montesinos, Jose Antonio Zapata for help and valuable interaction.

References

- [1] Alesci, E., Bianchi, E., Magliaro, E. and Perini, C., “Asymptotics of LQG fusion coefficients”, *Class. Quantum Grav.*, **27**, 095016, (2010). [DOI], [arXiv:0809.3718 [gr-qc]].
- [2] Alesci, E., Bianchi, E. and Rovelli, C., “LQG propagator: III. The New vertex”, *Class. Quantum Grav.*, **26**, 215001, (2009). [DOI], [arXiv:0812.5018 [gr-qc]].
- [3] Alesci, E., Noui, K. and Sardelli, F., “Spin-Foam Models and the Physical Scalar Product”, *Phys. Rev. D*, **78**, 104009, (2008). [DOI], [arXiv:0807.3561].
- [4] Alesci, E. and Rovelli, C., “The Complete LQG propagator. I. Difficulties with the Barrett-Crane vertex”, *Phys. Rev. D*, **76**, 104012, (2007). [DOI], [arXiv:0708.0883 [gr-qc]].
- [5] Alesci, E. and Rovelli, C., “The Complete LQG propagator. II. Asymptotic behavior of the vertex”, *Phys. Rev. D*, **77**, 044024, (2008). [DOI], [arXiv:0711.1284 [gr-qc]].
- [6] Alexander, S., Marciano, A. and Tacchi, R.A., “Towards a Spin-foam unification of gravity, Yang-Mills interactions and matter fields”, *arXiv*, e-print, (2011). [arXiv:1105.3480 [gr-qc]].
- [7] Alexandrov, S., “SO(4,C)-covariant Ashtekar-Barbero gravity and the Immirzi parameter”, *Class. Quantum Grav.*, **17**, 4255–4268, (2000). [DOI], [arXiv:gr-qc/0005085].
- [8] Alexandrov, S., “Choice of connection in loop quantum gravity”, *Phys. Rev. D*, **65**, 024011, (2002). [DOI], [arXiv:gr-qc/0107071].
- [9] Alexandrov, S., “Hilbert space structure of covariant loop quantum gravity”, *Phys. Rev. D*, **66**, 024028, (2002). [DOI], [arXiv:gr-qc/0201087].
- [10] Alexandrov, S., “Reality conditions for Ashtekar gravity from Lorentz- covariant formulation”, *Class. Quantum Grav.*, **23**, 1837–1850, (2006). [DOI], [arXiv:gr-qc/0510050].
- [11] Alexandrov, S., “Simplicity and closure constraints in spin foam models of gravity”, *Phys. Rev. D*, **78**, 044033, (2008). [DOI], [arXiv:0802.3389 [gr-qc]].
- [12] Alexandrov, S., “Spin foam model from canonical quantization”, *Phys. Rev. D*, **77**, 024009, (2008). [DOI], [arXiv:0705.3892 [gr-qc]].
- [13] Alexandrov, S., “The new vertices and canonical quantization”, *Phys. Rev. D*, **82**, 024024, (2010). [DOI], [arXiv:1004.2260 [gr-qc]].
- [14] Alexandrov, S., Buffenoi, E. and Roche, P., “Plebanski theory and covariant canonical formulation”, *Class. Quantum Grav.*, **24**, 2809–2824, (2007). [DOI], [arXiv:gr-qc/0612071].
- [15] Alexandrov, S., Grigentch, I. and Vassilevich, D., “SU(2)-invariant reduction of the 3+1 dimensional Ashtekar’s gravity”, *Class. Quantum Grav.*, **15**, 573–580, (1998). [DOI], [arXiv:gr-qc/9705080].
- [16] Alexandrov, S. and Livine, E.R., “SU(2) loop quantum gravity seen from covariant theory”, *Phys. Rev. D*, **67**, 044009, (2003). [DOI], [arXiv:gr-qc/0209105].
- [17] Alexandrov, S. and Roche, P., “Critical Overview of Loops and Foams”, *Phys. Rept.*, **506**, 41–86, (2011). [DOI], [arXiv:1009.4475 [gr-qc]].
- [18] Amelino-Camelia, G., Freidel, L., Kowalski-Glikman, J. and Smolin, L., “The principle of relative locality”, *arXiv*, e-print, (2011). [arXiv:1101.0931 [hep-th]].

- [19] Ashtekar, A., “New variables for classical and quantum gravity”, *Phys. Rev. Lett.*, **57**, 2244, (1986).
- [20] Ashtekar, A., *Lectures on Non-Perturbative Canonical Gravity*, Advanced Series in Astrophysics and Cosmology, 6, (World Scientific, Singapore, 1991). [Google Books].
- [21] Ashtekar, A., Baez, J.C., Corichi, A. and Krasnov, K., “Quantum geometry and black hole entropy”, *Phys. Rev. Lett.*, **80**, 904–907, (1998). [DOI], [arXiv:gr-qc/9710007].
- [22] Ashtekar, A., Baez, J.C. and Krasnov, K., “Quantum geometry of isolated horizons and black hole entropy”, *Adv. Theor. Math. Phys.*, **4**, 1–94, (2000). [arXiv:gr-qc/0005126].
- [23] Ashtekar, A., Campiglia, M. and Henderson, A., “Loop Quantum Cosmology and Spin Foams”, *Phys. Lett. B*, **681**, 347–352, (2009). [DOI], [arXiv:0909.4221].
- [24] Ashtekar, A., Campiglia, M. and Henderson, A., “Casting Loop Quantum Cosmology in the Spin Foam Paradigm”, *Class. Quantum Grav.*, **27**, 135020, (2010). [DOI], [arXiv:1001.5147].
- [25] Ashtekar, A., Campiglia, M. and Henderson, A., “Path Integrals and the WKB approximation in Loop Quantum Cosmology”, *Phys. Rev. D*, **82**, 124043, (2010). [DOI], [arXiv:1011.1024].
- [26] Ashtekar, Abhay, Corichi, Alejandro and Zapata, Jose A., “Quantum theory of geometry III: Noncommutativity of Riemannian structures”, *Class. Quant. Grav.*, **15**, 2955–2972, (1998). [DOI], [arXiv:gr-qc/9806041 [gr-qc]].
- [27] Ashtekar, A. and Krishnan, B., “Isolated and Dynamical Horizons and Their Applications”, *Living Rev. Relativity*, **7**, lrr-2004-10, (2004). [arXiv:gr-qc/0407042]. URL (accessed 12 September 2011): <http://www.livingreviews.org/lrr-2004-10>.
- [28] Ashtekar, A. and Lewandowski, J., “Projective techniques and functional integration”, *J. Math. Phys.*, **36**, 2170, (1995).
- [29] Ashtekar, A. and Lewandowski, J., “Quantum Theory of Gravity I: Area Operators”, *Class. Quantum Grav.*, **14**, A55–A81, (1997).
- [30] Ashtekar, A. and Lewandowski, J., “Quantum Theory of Gravity II: Volume Operators”, (1997).
- [31] Ashtekar, A. and Lewandowski, J., “Background independent quantum gravity: A status report”, *Class. Quantum Grav.*, **21**, R53, (2004). [gr-qc/0404018].
- [32] Baccetti, V., Livine, E.R. and Ryan, J.P., “The particle interpretation of $N = 1$ supersymmetric spin foams”, *Class. Quantum Grav.*, **27**, 225022, (2010). [DOI], [arXiv:1004.0672 [gr-qc]].
- [33] Baez, J.C., “Spin Network States in Gauge Theory”, *Adv. Math.*, **117**, 253–272, (1996).
- [34] Baez, J.C., “Spin Foam Models”, *Class. Quantum Grav.*, **15**, 1827–1858, (1998).
- [35] Baez, J.C., “An Introduction to Spin Foam Models of Quantum Gravity and BF Theory”, in Gausterer, H., Grosse, H. and Pittner, L., eds., *Geometry and Quantum Physics*, Proceedings of the 38. Internationale Universitätswochen für Kern- und Teilchenphysik, Schladming, Austria, January 9–16, 1999, Lecture Notes in Physics, pp. 25–94, (Springer, Berlin; New York, 2000). [gr-qc/9905087].

- [36] Baez, J.C. and Barrett, J.W., “The Quantum Tetrahedron in 3 and 4 Dimensions”, *Adv. Theor. Math. Phys.*, **3**, 815–850, (1999).
- [37] Baez, J.C. and Perez, A., “Quantization of strings and branes coupled to BF theory”, *Adv. Theor. Math. Phys.*, **11**, 3, (2007). [arXiv:gr-qc/0605087].
- [38] Bahr, Benjamin, “On knottings in the physical Hilbert space of LQG as given by the EPRL model”, *Class. Quant. Grav.*, **28**, 045002, (2011). [DOI], [arXiv:1006.0700 [gr-qc]].
- [39] Bahr, B. and Dittrich, B., “Breaking and restoring of diffeomorphism symmetry in discrete gravity”, *arXiv*, e-print, (2009). [arXiv:0909.5688 [gr-qc]].
- [40] Bahr, B. and Dittrich, B., “(Broken) Gauge Symmetries and Constraints in Regge Calculus”, *Class. Quantum Grav.*, **26**, 225011, (2009). [DOI], [arXiv:0905.1670 [gr-qc]].
- [41] Bahr, B. and Dittrich, B., “Improved and Perfect Actions in Discrete Gravity”, *Phys. Rev. D*, **80**, 124030, (2009). [DOI], [arXiv:0907.4323 [gr-qc]].
- [42] Bahr, B., Dittrich, B. and He, S., “Coarse graining free theories with gauge symmetries: the linearized case”, *New J. Phys.*, **13**, 045009, (2011). [DOI], [arXiv:1011.3667 [gr-qc]].
- [43] Bahr, B., Dittrich, B. and Ryan, J.P., “Spin foam models with finite groups”, *arXiv*, e-print, (2011). [arXiv:1103.6264 [gr-qc]].
- [44] Bahr, B., Dittrich, B. and Steinhaus, S., “Perfect discretization of reparametrization invariant path integrals”, *Phys. Rev. D*, **83**, 105026, (2011). [DOI], [arXiv:1101.4775 [gr-qc]].
- [45] Bahr, B., Hellmann, F., Kaminski, W., Kisielowski, M. and Lewandowski, J., “Operator Spin Foam Models”, *Class. Quantum Grav.*, **28**, 105003, (2011). [DOI], [arXiv:1010.4787 [gr-qc]].
- [46] Bahr, B. and Thiemann, T., “Gauge-invariant coherent states for Loop Quantum Gravity. I. Abelian gauge groups”, *Class. Quantum Grav.*, **26**, 045011, (2009). [DOI], [arXiv:0709.4619 [gr-qc]].
- [47] Bahr, B. and Thiemann, T., “Gauge-invariant coherent states for loop quantum gravity. II. Non-Abelian gauge groups”, *Class. Quantum Grav.*, **26**, 045012, (2009). [DOI], [arXiv:0709.4636 [gr-qc]].
- [48] Baratin, A., Flori, C. and Thiemann, T., “The Holst Spin Foam Model via Cubulations”, *arXiv*, e-print, (2008). [arXiv:0812.4055 [gr-qc]].
- [49] Baratin, Aristide and Oriti, Daniele, “Group field theory and simplicial gravity path integrals: A model for Holst-Plebanski gravity”, *Phys.Rev.*, **D85**, 044003, (2012). [DOI], [arXiv:1111.5842 [hep-th]]. 26 pages, 1 figure.
- [50] Barbero G, J.F., “Real Ashtekar variables for Lorentzian signature space times”, *Phys. Rev. D*, **51**, 5507–5510, (1995).
- [51] Barbero G, J.F., “From Euclidean to Lorentzian general relativity: The Real way”, *Phys. Rev. D*, **54**, 1492–1499, (1996). [gr-qc/9605066].
- [52] Barbieri, A., “Quantum tetrahedra and simplicial spin networks”, *Nucl. Phys. B*, **518**, 714–728, (1998). [DOI], [arXiv:gr-qc/9707010].
- [53] Barrett, J.W. and Crane, L., “Relativistic spin networks and quantum gravity”, *J.Math. Phys.*, **39**, 3296–3302, (1998).

- [54] Barrett, J.W. and Crane, L., “A Lorentzian Signature Model for Quantum General Relativity”, *Class. Quantum Grav.*, **17**, 3101–3118, (2000).
- [55] Barrett, J.W., Dowdall, R.J., Fairbairn, W.J., Gomes, H. and Hellmann, F., “Asymptotic analysis of the EPRL four-simplex amplitude”, *J. Math. Phys.*, **50**, 112504, (2009). [DOI], [arXiv:0902.1170 [gr-qc]].
- [56] Barrett, J.W., Dowdall, R.J., Fairbairn, W.J., Gomes, H. and Hellmann, F., “A Summary of the asymptotic analysis for the EPRL amplitude”, *arXiv*, e-print, (2009). [arXiv:0909.1882 [gr-qc]].
- [57] Barrett, J.W., Dowdall, R.J., Fairbairn, W.J., Hellmann, F. and Pereira, R., “Asymptotics of 4d spin foam models”, *Gen. Relativ. Gravit.*, **43**, 2421–2436, (2010). [DOI], [arXiv:1003.1886 [gr-qc]].
- [58] Barrett, J.W., Dowdall, R.J., Fairbairn, W.J., Hellmann, F. and Pereira, R., “Lorentzian spin foam amplitudes: graphical calculus and asymptotics”, *Class. Quantum Grav.*, **27**, 165009, (2010). [DOI], [arXiv:0907.2440 [gr-qc]].
- [59] Barrett, J.W., Fairbairn, W.J. and Hellmann, F., “Quantum gravity asymptotics from the SU(2) 15j symbol”, *Int. J. Mod. Phys.*, **A25**, 2897–2916, (2010). [DOI], [arXiv:0912.4907 [gr-qc]].
- [60] Barrett, J.W., Garcia-Islas, J.M. and Martins, J.F., “Observables in the Turaev-Viro and Crane-Yetter models”, *J. Math. Phys.*, **48**, 093508, (2007). [DOI], [arXiv:math/0411281].
- [61] Barrett, J.W. and Naish-Guzman, I., “The Ponzano-Regge model”, *Class. Quantum Grav.*, **26**, 155014, (2009). [DOI], [arXiv:0803.3319 [gr-qc]].
- [62] Barrett, J.W. and Steele, C.M., “Asymptotics of relativistic spin networks”, *Class. Quantum Grav.*, **20**, 1341–1362, (2003). [DOI], [arXiv:gr-qc/0209023].
- [63] Barrett, J.W. and Williams, R.M., “The asymptotics of an amplitude for the 4-simplex”, *Adv. Theor. Math. Phys.*, **3**, 209–215, (1999). [arXiv:gr-qc/9809032].
- [64] Bianchi, E., “The length operator in Loop Quantum Gravity”, *Nucl. Phys.*, **B807**, 591–624, (2009). [DOI], [arXiv:0806.4710 [gr-qc]].
- [65] Bianchi, E., Dona, P. and Speziale, S., “Polyhedra in loop quantum gravity”, *Phys. Rev. D*, **83**, 044035, (2011). [DOI], [arXiv:1009.3402].
- [66] Bianchi, E. and Haggard, H.M., “Discreteness of the Volume of Space from Bohr-Sommerfeld Quantization”, *Phys.Rev.Lett.*, **107**, 011301, (2011). [DOI], [arXiv:1102.5439].
- [67] Bianchi, E., Han, M., Magliaro, E., Perini, C., Rovelli, C. and Wieland, W.M., “Spinfoam fermions”, *arXiv*, e-print, (2010). [arXiv:1012.4719].
- [68] Bianchi, E., Krajewski, T., Rovelli, C. and Vidotto, F., “Cosmological constant in spinfoam cosmology”, *Phys. Rev. D*, **83**, 104015, (2011). [DOI], [arXiv:1101.4049].
- [69] Bianchi, E., Magliaro, E. and Perini, C., “LQG propagator from the new spin foams”, *Nucl. Phys. B*, **822**, 245–269, (2009). [DOI], [arXiv:0905.4082 [gr-qc]].
- [70] Bianchi, E., Magliaro, E. and Perini, C., “Coherent spin-networks”, *Phys. Rev. D*, **82**, 024012, (2010). [DOI], [arXiv:0912.4054 [gr-qc]].

- [71] Bianchi, E., Modesto, L., Rovelli, C. and Speziale, S., “Graviton propagator in loop quantum gravity”, *Class. Quantum Grav.*, **23**, 6989–7028, (2006). [DOI], [arXiv:gr-qc/0604044 [gr-qc]].
- [72] Bianchi, E., Regoli, D. and Rovelli, C., “Face amplitude of spinfoam quantum gravity”, *Class. Quantum Grav.*, **27**, 185009, (2010). [DOI], [arXiv:1005.0764 [gr-qc]].
- [73] Bianchi, E., Rovelli, C. and Vidotto, F., “Towards Spinfoam Cosmology”, *Phys. Rev. D*, **82**, 084035, (2010). [DOI], [arXiv:1003.3483].
- [74] Bianchi, E. and Satz, A., “Semiclassical regime of Regge calculus and spin foams”, *Nucl. Phys.*, **B808**, 546–568, (2009). [DOI], [arXiv:0808.1107 [gr-qc]].
- [75] Bodendorfer, N., Thiemann, T. and Thurn, A., “New Variables for Classical and Quantum Gravity in all Dimensions I. Hamiltonian Analysis”, *arXiv*, e-print, (2011). [arXiv:1105.3703 [gr-qc]].
- [76] Bodendorfer, N., Thiemann, T. and Thurn, A., “New Variables for Classical and Quantum Gravity in all Dimensions II. Lagrangian Analysis”, *arXiv*, e-print, (2011). [arXiv:1105.3704 [gr-qc]].
- [77] Bodendorfer, N., Thiemann, T. and Thurn, A., “New Variables for Classical and Quantum Gravity in all Dimensions III. Quantum Theory”, *arXiv*, e-print, (2011). [arXiv:1105.3705 [gr-qc]].
- [78] Bodendorfer, N., Thiemann, T. and Thurn, A., “New Variables for Classical and Quantum Gravity in all Dimensions IV. Matter Coupling”, *arXiv*, e-print, (2011). [arXiv:1105.3706 [gr-qc]].
- [79] Bodendorfer, N., Thiemann, T. and Thurn, A., “On the Implementation of the Canonical Quantum Simplicity Constraint”, *arXiv*, e-print, (2011). [arXiv:1105.3708 [gr-qc]].
- [80] Bodendorfer, N., Thiemann, T. and Thurn, A., “Towards Loop Quantum Supergravity (LQSG)”, *arXiv*, e-print, (2011). [arXiv:1106.1103 [gr-qc]].
- [81] Bodendorfer, N., Thiemann, T. and Thurn, A., “Towards Loop Quantum Supergravity (LQSG) I. Rarita- Schwinger Sector”, *arXiv*, e-print, (2011). [arXiv:1105.3709 [gr-qc]].
- [82] Bodendorfer, N., Thiemann, T. and Thurn, A., “Towards Loop Quantum Supergravity (LQSG) II. p-Form Sector”, *arXiv*, e-print, (2011). [arXiv:1105.3710 [gr-qc]].
- [83] Bojowald, M., “Loop Quantum Cosmology”, *Living Rev. Relativity*, **8**, lrr-2005-11, (2005). [arXiv:gr-qc/0601085]. URL (accessed 12 September 2011): <http://www.livingreviews.org/lrr-2005-11>.
- [84] Bojowald, M. and Perez, A., “Spin foam quantization and anomalies”, *Gen. Rel. Grav.*, **42**, 877–907, (2010). [DOI], [arXiv:gr-qc/0303026].
- [85] Bonzom, V., “From lattice BF gauge theory to area-angle Regge calculus”, *Class. Quantum Grav.*, **26**, 155020, (2009). [DOI], [arXiv:0903.0267].
- [86] Bonzom, V., “Spin foam models for quantum gravity from lattice path integrals”, *Phys. Rev. D*, **80**, 064028, (2009). [DOI], [arXiv:0905.1501].
- [87] Bonzom, V., “A taste of Hamiltonian constraint in spin foam models”, *Phys. Rev. D*, **84**, 024009, (2011). [DOI], [arXiv:1101.1615].

- [88] Bonzom, V. and Freidel, L., “The Hamiltonian constraint in 3d Riemannian loop quantum gravity”, *Class. Quantum Gravity*, **28**, 195006, (2011). [DOI], [arXiv:1101.3524].
- [89] Bonzom, V., Gurau, R., Riello, A. and Rivasseau, V., “Critical behavior of colored tensor models in the large N limit”, (2011).
- [90] Bonzom, V. and Livine, E.R., “A Immirzi-like parameter for 3d quantum gravity”, *Class. Quantum Grav.*, **25**, 195024, (2008). [DOI], [arXiv:0801.4241 [gr-qc]].
- [91] Bonzom, V. and Livine, E.R., “A Lagrangian approach to the Barrett-Crane spin foam model”, *Phys. Rev. D*, **79**, 064034, (2009). [DOI], [arXiv:0812.3456].
- [92] Bonzom, V. and Livine, E.R., “Yet Another Recursion Relation for the 6j-Symbol”, *arXiv*, e-print, (2011). [arXiv:1103.3415].
- [93] Bonzom, V., Livine, E.R. and Speziale, S., “Recurrence relations for spin foam vertices”, *Class. Quantum Grav.*, **27**, 125002, (2010). [DOI], [arXiv:0911.2204].
- [94] Bonzom, V. and Smerlak, M., “Bubble divergences from cellular cohomology”, *Lett. Math. Phys.*, **93**, 295–305, (2010). [DOI], [arXiv:1004.5196 [gr-qc]].
- [95] Bonzom, V. and Smerlak, M., “Bubble divergences from twisted cohomology”, (2010). [arXiv:1008.1476 [math-ph]].
- [96] Bonzom, V. and Smerlak, M., “Bubble divergences: sorting out topology from cell structure”, (2011). [arXiv:1103.3961 [gr-qc]].
- [97] Bonzom, Valentin and Smerlak, Matteo, “Gauge symmetries in spinfoam gravity: the case for ‘cellular quantization’”, (2012). [arXiv:1201.4996 [gr-qc]]. 6 pages.
- [98] Borja, E.F., Freidel, L., Garay, I. and Livine, E.R., “U(N) tools for Loop Quantum Gravity: The Return of the Spinor”, *Class. Quantum Grav.*, **28**, 055005, (2011). [DOI], [arXiv:1010.5451 [gr-qc]].
- [99] Boulatov, D., “A Model of Three-Dimensional Lattice Gravity”, *Mod. Phys. Lett. A*, **7**, 1629–1646, (1992).
- [100] Buffenoir, E., Henneaux, M., Noui, K. and Roche, P., “Hamiltonian analysis of Plebanski theory”, *Class. Quantum Grav.*, **21**, 5203–5220, (2004). [DOI], [arXiv:gr-qc/0404041].
- [101] Buffenoir, E. and Noui, K., “Unfashionable observations about three dimensional gravity”, *arXiv*, e-print, (2003). [arXiv:gr-qc/0305079].
- [102] Campiglia, M., Henderson, A. and Nelson, W., “Vertex Expansion for the Bianchi I model”, *Phys. Rev. D*, **82**, 064036, (2010). [DOI], [arXiv:1007.3723].
- [103] Capovilla, R., Jacobson, T. and Dell, J., “General relativity without the metric”, *Phys. Rev. Lett.*, **63**, 2325, (1989).
- [104] Capovilla, R., Jacobson, T. and Dell, J., “A Pure spin connection formulation of gravity”, *Class. Quantum Grav.*, **8**, 59–73, (1991).
- [105] Capovilla, R., Montesinos, M., Prieto, V.A. and Rojas, E., “BF gravity and the Immirzi parameter”, *Class. Quantum Grav.*, **18**, L49, (2001).
- [106] Carlip, S., *Quantum Gravity in 2+1 Dimensions*, Cambridge Monographs on Mathematical Physics, (Cambridge University Press, Cambridge; New York, 1998). [Google Books].

- [107] Cohen, A.G. and Glashow, S.L., “Very special relativity”, *Phys. Rev. Lett.*, **97**, 021601, (2006). [DOI], [arXiv:hep-ph/0601236 [hep-ph]].
- [108] Collins, J., Perez, A. and Sudarsky, D., “Lorentz invariance violation and its role in quantum gravity phenomenology”, *arXiv*, e-print, (2006). [arXiv:hep-th/0603002].
- [109] Collins, J., Perez, A., Sudarsky, D., Urrutia, L. and Vucetich, H., “Lorentz invariance and quantum gravity: an additional fine-tuning problem?”, *Phys. Rev. Lett.*, **93**, 191301, (2004). [DOI], [arXiv:gr-qc/0403053].
- [110] Colosi, D. and Oeckl, R., “S-matrix at spatial infinity”, *Phys. Lett.*, **B665**, 310–313, (2008). [DOI], [arXiv:0710.5203 [hep-th]].
- [111] Colosi, D. and Oeckl, R., “Spatially asymptotic S-matrix from general boundary formulation”, *Phys. Rev. D*, **78**, 025020, (2008). [DOI], [arXiv:0802.2274 [hep-th]].
- [112] Colosi, D. and Oeckl, R., “States and amplitudes for finite regions in a two-dimensional Euclidean quantum field theory”, *J. Geom. Phys.*, **59**, 764–780, (2009). [DOI], [arXiv:0811.4166 [hep-th]].
- [113] Colosi, D. and Oeckl, R., “On Unitary Evolution in Quantum Field Theory in Curved Spacetime”, *The Open Nuclear and Particle Physics Journal*, **4**, 13–20, (2011). [DOI], [arXiv:0912.0556 [hep-th]].
- [114] Conrady, F., “Spin foams with timelike surfaces”, *Class. Quantum Grav.*, **27**, 155014, (2010). [DOI], [arXiv:1003.5652].
- [115] Conrady, F. and Freidel, L., “On the semiclassical limit of 4d spin foam models”, *Phys. Rev. D*, **78**, 104023, (2008). [DOI], [arXiv:0809.2280 [gr-qc]].
- [116] Conrady, F. and Freidel, L., “Path integral representation of spin foam models of 4d gravity”, *Class. Quantum Grav.*, **25**, 245010, (2008). [DOI], [arXiv:0806.4640 [gr-qc]].
- [117] Conrady, F. and Freidel, L., “Quantum geometry from phase space reduction”, *J. Math. Phys.*, **50**, 123510, (2009). [DOI], [arXiv:0902.0351 [gr-qc]].
- [118] Conrady, F. and Hnybida, J., “A spin foam model for general Lorentzian 4-geometries”, *Class. Quantum Grav.*, **27**, 185011, (2010). [DOI], [arXiv:1002.1959].
- [119] Conrady, F. and Hnybida, J., “Unitary irreducible representations of $SL(2, \mathbb{C})$ in discrete and continuous $SU(1,1)$ bases”, *J. Math. Phys.*, **52**, 012501, (2011). [DOI], [arXiv:1007.0937].
- [120] Constantinidis, C.P., Piguët, O. and Perez, A., “Quantization of the Jackiw-Teitelboim model”, *Phys. Rev. D*, **79**, 084007, (2009). [DOI], [arXiv:0812.0577 [gr-qc]].
- [121] Crane, L., “Categorical physics”, *arXiv*, e-print, (1993). [arXiv:hep-th/9301061].
- [122] Crane, L., “Topological field theory as the key to quantum gravity”, *arXiv*, e-print, (1993). [arXiv:hep-th/9308126].
- [123] Crane, L., Kauffman, L. and Yetter, D.N., “State-Sum Invariants of 4-Manifolds”, *J. Knot Theor Ramifications*, **6**, 177–234, (1997).
- [124] Crane, L. and Yetter, D.N., “A Categorical Construction of 4D Topological Quantum Field Theories”, in Baadhio, R.A. and Kauffman, L.H., eds., *Quantum Topology*, Series on Knots and Everything, **3**, (World Scientific, Singapore; River Edge, NJ, 1993). [Google Books].

- [125] Date, G., Kaul, R.K. and Sengupta, S., “Topological Interpretation of Barbero-Immirzi Parameter”, *Phys. Rev. D*, **79**, 044008, (2009). [DOI], [arXiv:0811.4496].
- [126] De Pietri, R. and Freidel, L., “ $so(4)$ Plebanski Action and Relativistic Spin Foam Model”, *Class. Quantum Grav.*, **16**, 2187–2196, (1999). [DOI].
- [127] De Pietri, R., Freidel, L., Krasnov, K. and Rovelli, C., “Barrett-Crane model from a Boulatov-Ooguri field theory over a homogeneous space”, *Nucl. Phys. B*, **574**, 785–806, (2000).
- [128] DePietri, R. and Petronio, C., “Feynman diagrams of generalized matrix models and the associated manifolds in dimension 4”, *J. Math. Phys.*, **41**, 6671–6688, (2000).
- [129] Di Bartolo, C., Gambini, R., Griego, J. and Pullin, J., “Canonical quantum gravity in the Vassiliev invariants arena: II. Constraints, habitats and consistency of the constraint algebra”, *Class. Quantum Grav.*, **17**, 3239–3264, (2000).
- [130] Di Bartolo, C., Gambini, R., Griego, J. and Pullin, J., “Consistent canonical quantization of general relativity in the space of Vassiliev knot invariants”, *Phys. Rev. Lett.*, **84**, 2314–2317, (2000).
- [131] Di Bartolo, C., Gambini, R., Porto, R.A. and Pullin, J., “Dirac-like approach for consistent discretizations of classical constrained theories”, *J. Math. Phys.*, **46**, 012901, (2005). [DOI], [arXiv:gr-qc/0405131].
- [132] Di Bartolo, C., Gambini, R. and Pullin, J., “Consistent and mimetic discretizations in general relativity”, *J. Math. Phys.*, **46**, 032501, (2005). [DOI], [arXiv:gr-qc/0404052].
- [133] Ding, Y. and Han, M., “On the Asymptotics of Quantum Group Spinfoam Model”, *arXiv*, e-print, (2011). [arXiv:1103.1597].
- [134] Ding, Y., Han, M. and Rovelli, C., “Generalized Spinfoams”, *Phys. Rev. D*, **83**, 124020, (2011). [DOI], [arXiv:1011.2149].
- [135] Ding, Y. and Rovelli, C., “Physical boundary Hilbert space and volume operator in the Lorentzian new spin-foam theory”, *Class. Quantum Grav.*, **27**, 205003, (2010). [DOI], [arXiv:1006.1294 [gr-qc]].
- [136] Ding, Y. and Rovelli, C., “The volume operator in covariant quantum gravity”, *Class. Quantum Grav.*, **27**, 165003, (2010). [DOI], [arXiv:0911.0543 [gr-qc]].
- [137] Dirac, P.A.M., *Lectures on Quantum Mechanics*, Belfer Graduate School of Science. Monographs Series, (Yeshiva Press, New York, 1964). [Google Books].
- [138] Dittrich, B., “Diffeomorphism symmetry in quantum gravity models”, *arXiv*, e-print, (2008). [arXiv:0810.3594 [gr-qc]].
- [139] Dittrich, Bianca, “How to construct diffeomorphism symmetry on the lattice”, (2012). [arXiv:1201.3840 [gr-qc]]. 21 pages, to appear in the Proceedings of the 3rd Quantum Gravity and Quantum Geometry School 2011, Zakopane, Poland.
- [140] Dittrich, Bianca, Eckert, Frank C. and Martin-Benito, Mercedes, “Coarse graining methods for spin net and spin foam models”, (2011). [arXiv:1109.4927 [gr-qc]]. * Temporary entry *.
- [141] Dittrich, B., Freidel, L. and Speziale, S., “Linearized dynamics from the 4-simplex Regge action”, *Phys. Rev. D*, **76**, 104020, (2007). [DOI], [arXiv:0707.4513 [gr-qc]].

- [142] Dittrich, B. and Hohn, P.A., “From covariant to canonical formulations of discrete gravity”, *Class. Quantum Grav.*, **27**, 155001, (2010). [DOI], [arXiv:0912.1817 [gr-qc]].
- [143] Dittrich, B. and Ryan, J.P., “Simplicity in simplicial phase space”, *Phys. Rev. D*, **82**, 064026, (2010). [DOI], [arXiv:1006.4295 [gr-qc]].
- [144] Dittrich, B. and Ryan, J.P., “Phase space descriptions for simplicial 4d geometries”, *Class. Quantum Grav.*, **28**, 065006, (2011). [DOI], [arXiv:0807.2806 [gr-qc]].
- [145] Dittrich, Bianca and Speziale, Simone, “Area-angle variables for general relativity”, *New J.Phys.*, **10**, 083006, (2008). [DOI], [arXiv:0802.0864 [gr-qc]].
- [146] Dittrich, Bianca and Steinhaus, Sebastian, “Path integral measure and triangulation independence in discrete gravity”, *Phys.Rev.*, **D85**, 044032, (2012). [DOI], [arXiv:1110.6866 [gr-qc]]. 36 pages, 7 figures, references updated, some typos and mistakes corrected.
- [147] Dittrich, Bianca and Tambornino, Johannes, “A Perturbative approach to Dirac observables and their space-time algebra”, *Class.Quant.Grav.*, **24**, 757–784, (2007). [DOI], [arXiv:gr-qc/0610060 [gr-qc]].
- [148] Dittrich, B. and Thiemann, T., “Are the spectra of geometrical operators in Loop Quantum Gravity really discrete?”, *J. Math. Phys.*, **50**, 012503, (2009). [DOI], [arXiv:0708.1721 [gr-qc]].
- [149] Dowdall, R.J. and Fairbairn, W.J., “Observables in 3d spinfoam quantum gravity with fermions”, *Gen. Rel. Grav.*, **43**, 1263–1307, (2011). [DOI], [arXiv:1003.1847 [gr-qc]].
- [150] Dupuis, Maite, Freidel, Laurent, Livine, Etera R. and Speziale, Simone, “Holomorphic Lorentzian Simplicity Constraints”, *J.Math.Phys.*, **53**, 032502, (2012). [arXiv:1107.5274 [gr-qc]].
- [151] Dupuis, M. and Livine, E.R., “The 6j-symbol: Recursion, C. and Asymptotics”, *Class. Quantum Grav.*, **27**, 135003, (2010). [DOI], [arXiv:0910.2425].
- [152] Dupuis, M. and Livine, E.R., “Lifting SU(2) Spin Networks to Projected Spin Networks”, *Phys. Rev. D*, **82**, 064044, (2010). [DOI], [arXiv:1008.4093].
- [153] Dupuis, M. and Livine, E.R., “Revisiting the Simplicity Constraints and Coherent Intertwiners”, *Class. Quantum Grav.*, **28**, 085001, (2011). [DOI], [arXiv:1006.5666].
- [154] Dupuis, Maite and Livine, Etera R., “Holomorphic Simplicity Constraints for 4d Riemannian Spinfoam Models”, (2011). [arXiv:1111.1125 [gr-qc]].
- [155] Dupuis, Maite and Livine, Etera R., “Holomorphic Simplicity Constraints for 4d Spinfoam Models”, *Class.Quant.Grav.*, **28**, 215022, (2011). [DOI], [arXiv:1104.3683 [gr-qc]].
- [156] Engle, Jonathan, “A spin-foam vertex amplitude with the correct semiclassical limit”, (2012). [arXiv:1201.2187 [gr-qc]]. 4 pages.
- [157] Engle, J., Han, M. and Thiemann, T., “Canonical path integral measures for Holst and Plebanski gravity. I. Reduced Phase Space Derivation”, *Class. Quantum Grav.*, **27**, 245014, (2010). [DOI], [arXiv:0911.3433 [gr-qc]].
- [158] Engle, J., Livine, E., Pereira, R. and Rovelli, C., “LQG vertex with finite Immirzi parameter”, *Nucl. Phys.*, **B799**, 136–149, (2008). [DOI], [arXiv:0711.0146 [gr-qc]].

- [159] Engle, Jonathan, Noui, Karim, Perez, Alejandro and Pranzetti, Daniele, “Black hole entropy from an SU(2)-invariant formulation of Type I isolated horizons”, *Phys.Rev.*, **D82**, 044050, (2010). [DOI], [arXiv:1006.0634 [gr-qc]].
- [160] Engle, J. and Pereira, R., “Coherent states, constraint classes, and area operators in the new spin-foam models”, *Class. Quantum Grav.*, **25**, 105010, (2008). [DOI], [arXiv:0710.5017].
- [161] Engle, J. and Pereira, R., “Regularization and finiteness of the Lorentzian LQG vertices”, *Phys. Rev. D*, **79**, 084034, (2009). [DOI], [arXiv:0805.4696].
- [162] Engle, J., Pereira, R. and Rovelli, C., “The loop-quantum-gravity vertex-amplitude”, *Phys. Rev. Lett.*, **99**, 161301, (2007). [DOI], [arXiv:0705.2388 [gr-qc]].
- [163] Engle, J., Pereira, R. and Rovelli, C., “Flipped spinfoam vertex and loop gravity”, *Nucl. Phys. B*, **798**, 251–290, (2008). [DOI], [arXiv:0708.1236 [gr-qc]].
- [164] Engle, J., Perez, A. and Noui, K., “Black hole entropy and SU(2) Chern-Simons theory”, *Phys. Rev. Lett.*, **105**, 031302, (2010). [DOI], [arXiv:0905.3168 [gr-qc]].
- [165] Epstein, H. and Glaser, V., “The role of locality in perturbation theory”, *Annales Poincare Phys. Theor.*, **A19**, 211–295, (1973).
- [166] Fairbairn, W.J., “Fermions in three-dimensional spinfoam quantum gravity”, *Gen. Rel. Grav.*, **39**, 427–476, (2007). [DOI], [arXiv:gr-qc/0609040].
- [167] Fairbairn, W.J. and Livine, E.R., “3d spinfoam quantum gravity: Matter as a phase of the group field theory”, *Class. Quantum Grav.*, **24**, 5277–5297, (2007). [DOI], [arXiv:gr-qc/0702125].
- [168] Fairbairn, W.J. and Meusburger, C., “Quantum deformation of two four-dimensional spin foam models”, *arXiv*, e-print, (2010). [arXiv:1012.4784].
- [169] Fairbairn, W.J. and Perez, A., “Extended matter coupled to BF theory”, *Phys. Rev. D*, **78**, 024013, (2008). [DOI], [arXiv:0709.4235 [gr-qc]].
- [170] Fleischhack, C., “Representations of the Weyl Algebra in Quantum Geometry”, *Commun. Math. Phys.*, **285**, 67–140, (2009). [DOI], [arXiv:math-ph/0407006].
- [171] Flori, C. and Thiemann, T., “Semiclassical analysis of the Loop Quantum Gravity volume operator. I. Flux Coherent States”, *arXiv*, e-print, (2008). [arXiv:0812.1537 [gr-qc]].
- [172] Freidel, L., “A Ponzano-Regge model of Lorentzian 3-Dimensional gravity”, *Nucl. Phys. Proc. Suppl.*, **88**, 237–240, (2000).
- [173] Freidel, L., “Group field theory: An overview”, *Int. J. Theor. Phys.*, **44**, 1769–1783, (2005). [DOI], [arXiv:hep-th/0505016].
- [174] Freidel, L., Kowalski-Glikman, J. and Starodubtsev, A., “Particles as Wilson lines of gravitational field”, *Phys. Rev. D*, **74**, 084002, (2006). [DOI], [arXiv:gr-qc/0607014].
- [175] Freidel, L. and Krasnov, K., “Spin Foam Models and the Classical Action Principle”, *Adv. Theor. Math. Phys.*, **2**, 1183–1247, (1999).
- [176] Freidel, L. and Krasnov, K., “A New Spin Foam Model for 4d Gravity”, *Class. Quantum Grav.*, **25**, 125018, (2008). [DOI], [arXiv:0708.1595 [gr-qc]].

- [177] Freidel, L. and Livine, E.R., “Spin networks for non-compact groups”, *J. Math. Phys.*, **44**, 1322–1356, (2003). [DOI], [arXiv:hep-th/0205268].
- [178] Freidel, L. and Livine, E.R., “Effective 3d quantum gravity and non-commutative quantum field theory”, *Phys. Rev. Lett.*, **96**, 221301, (2006). [DOI], [arXiv:hep-th/0512113].
- [179] Freidel, L. and Livine, E.R., “Ponzano-Regge model revisited. III: Feynman diagrams and effective field theory”, *Class. Quantum Grav.*, **23**, 2021–2062, (2006). [DOI], [arXiv:hep-th/0502106].
- [180] Freidel, L. and Louapre, D., “Diffeomorphisms and spin foam models”, *Nucl. Phys. B*, **662**, 279–298, (2003). [DOI], [arXiv:gr-qc/0212001].
- [181] Freidel, L. and Louapre, D., “Non-perturbative summation over 3D discrete topologies”, *Phys. Rev. D*, **68**, 104004, (2003). [DOI], [arXiv:hep-th/0211026].
- [182] Freidel, L. and Louapre, D., “Ponzano-Regge model revisited. I: Gauge fixing, observables and interacting spinning particles”, *Class. Quantum Grav.*, **21**, 5685–5726, (2004). [DOI], [arXiv:hep-th/0401076].
- [183] Freidel, L. and Starodubtsev, A., “Quantum gravity in terms of topological observables”, *arXiv*, e-print, (2005). [arXiv:hep-th/0501191].
- [184] Gambini, R., Ponce, M. and Pullin, J., “Consistent discretizations: the Gowdy spacetimes”, *Phys. Rev. D*, **72**, 024031, (2005). [DOI], [arXiv:gr-qc/0505043].
- [185] Gambini, R., Porto, R.A. and Pullin, J., “Consistent discrete gravity solution of the problem of time: A model”, *arXiv*, e-print, (2003). [arXiv:gr-qc/0302064].
- [186] Gambini, R. and Pullin, J., “A finite spin-foam-based theory of three and four dimensional quantum gravity”. [gr-qc/0111089].
- [187] Gambini, R. and Pullin, J., “Nonstandard optics from quantum space-time”, *Phys. Rev. D*, **59**, 124021, (1999). [DOI], [arXiv:gr-qc/9809038 [gr-qc]].
- [188] Gambini, R. and Pullin, J., “Consistent discretizations for classical and quantum general relativity”, *arXiv*, e-print, (2001). [arXiv:gr-qc/0108062].
- [189] Gambini, R. and Pullin, J., “Canonical quantum gravity and consistent discretizations”, *Pramana*, **63**, 755–764, (2004). [DOI], [arXiv:gr-qc/0402062].
- [190] Gambini, R. and Pullin, J., “Canonical quantum gravity consistent discretizations”, *arXiv*, e-print, (2004). [arXiv:gr-qc/0408025].
- [191] Gambini, R. and Pullin, J., “Consistent discretization and loop quantum geometry”, *Phys. Rev. Lett.*, **94**, 101302, (2005). [DOI], [arXiv:gr-qc/0409057].
- [192] Gambini, R. and Pullin, J., “Consistent discretizations as a road to quantum gravity”, *arXiv*, e-print, (2005). [arXiv:gr-qc/0512065].
- [193] Gambini, R. and Pullin, J., “Consistent discretization and canonical classical and quantum Regge calculus”, *Int. J. Mod. Phys.*, **D15**, 1699–1706, (2006). [DOI], [arXiv:gr-qc/0511096].
- [194] Gambini, R., Rastgoo, S. and Pullin, J., “Small Lorentz violations in quantum gravity: do they lead to unacceptably large effects?”, *Class. Quantum Grav.*, **28**, 155005, (2011). [DOI], [arXiv:1106.1417 [gr-qc]].

- [195] Gaul, M. and Rovelli, C., “A generalized Hamiltonian Constraint Operator in Loop Quantum Gravity and its simplest Euclidean Matrix Elements”, *Class. Quantum Grav.*, **18**, 1593–1624, (2001).
- [196] Gel’fand, I.M., Graev, M.I. and Vilenkin, N.Y., *Generalized Functions, Vol. 5: Integral geometry and representation theory*, (Academic Press, New York; London, 1966).
- [197] Gel’fand, I.M., Minlos, R.A. and Shapiro, Z.Y., *Representations of the rotation and Lorentz groups and their applications*, (Pergamon Press, London; MacMillan, New York, New York, 1963). CW: not sure where page numbers come from.
- [198] Gielen, S. and Oriti, D., “Classical general relativity as BF-Plebanski theory with linear constraints”, *Class. Quantum Grav.*, **27**, 185017, (2010). [DOI], [arXiv:1004.5371].
- [199] Girelli, F., Oeckl, R. and Perez, A., “Spin foam diagrammatics and topological invariance”, *Class. Quantum Grav.*, **19**, 1093–1108, (2002). [DOI], [arXiv:gr-qc/0111022].
- [200] Girelli, F., Oeckl, R. and Perez, A., “Spin Foam Diagrammatics and Topological Invariance”, *Class. Quantum Grav.*, **19**, 1093–1108, (2002).
- [201] Gurau, R., “The 1/N expansion of colored tensor models”, *Annales Henri Poincare*, **12**, 829–847, (2011). [DOI], [arXiv:1011.2726 [gr-qc]].
- [202] Gurau, R., “Colored Group Field Theory”, *Commun. Math. Phys.*, **304**, 69–93, (2011). [DOI], [arXiv:0907.2582 [hep-th]].
- [203] Gurau, R., “The complete 1/N expansion of colored tensor models in arbitrary dimension”, *arXiv*, e-print, (2011). [arXiv:1102.5759 [gr-qc]].
- [204] Gurau, R., “A generalization of the Virasoro algebra to arbitrary dimensions”, (2011). [arXiv:1105.6072 [hep-th]].
- [205] Gurau, R. and Rivasseau, V., “The 1/N expansion of colored tensor models in arbitrary dimension”, *Europhys. Lett.*, **95**, 50004, (2011). [DOI], [arXiv:1101.4182 [gr-qc]].
- [206] Halliwell, J. and Hartle, J.B., “Wave functions constructed from an invariant sum over histories satisfy constraints”, *Phys. Rev. D*, **43**, 1170–1194, (1991).
- [207] Han, M., “4-dimensional Spin-foam Model with Quantum Lorentz Group”, *arXiv*, e-print, (2010). [arXiv:1012.4216].
- [208] Han, M., “Canonical Path-Integral Measures for Holst and Plebanski Gravity. II. Gauge Invariance and Physical Inner Product”, *Class. Quantum Grav.*, **27**, 245015, (2010). [DOI], [arXiv:0911.3436 [gr-qc]].
- [209] Han, M., “A Path-integral for the Master Constraint of Loop Quantum Gravity”, *Class. Quantum Grav.*, **27**, 215009, (2010). [DOI], [arXiv:0911.3432 [gr-qc]].
- [210] Han, Muxin, “Cosmological Constant in LQG Vertex Amplitude”, (2011). [arXiv:1105.2212 [gr-qc]]. * Temporary entry *.
- [211] Han, M. and Rovelli, C., “Spinfoam Fermions: PCT Symmetry, Dirac Determinant, and Correlation Functions”, *arXiv*, e-print, (2011). [arXiv:1101.3264].
- [212] Han, M. and Thiemann, T., “Commuting Simplicity and Closure Constraints for 4D Spin Foam Models”, *arXiv*, e-print, (2010). [arXiv:1010.5444 [gr-qc]].

- [213] Han, M. and Thiemann, T., “On the Relation between Operator Constraint –, Master Constraint –, Reduced Phase Space –, and Path Integral Quantisation”, *Class. Quantum Grav.*, **27**, 225019, (2010). [DOI], [arXiv:0911.3428 [gr-qc]].
- [214] Han, M. and Thiemann, T., “On the Relation between Rigging Inner Product and Master Constraint Direct Integral Decomposition”, *J. Math. Phys.*, **51**, 092501, (2010). [DOI], [arXiv:0911.3431 [gr-qc]].
- [215] Han, Muxin and Zhang, Mingyi, “Asymptotics of Spinfoam Amplitude on Simplicial Manifold: Euclidean Theory”, (2011). [arXiv:1109.0500 [gr-qc]]. * Temporary entry *.
- [216] Henderson, A., Rovelli, C., Vidotto, F. and Wilson-Ewing, E., “Local spinfoam expansion in loop quantum cosmology”, *Class. Quantum Grav.*, **28**, 025003, (2011). [DOI], [arXiv:1010.0502].
- [217] Henneaux, M. and Teitelboim, C., *Quantization of gauge systems*, (Princeton University Press, Princeton, NJ, 1992). [Google Books].
- [218] Hollands, S. and Wald, R.M., “Existence of local covariant time ordered products of quantum fields in curved space-time”, *Commun. Math. Phys.*, **231**, 309–345, (2002). [DOI], [arXiv:gr-qc/0111108 [gr-qc]].
- [219] Hollands, S. and Wald, R.M., “On the renormalization group in curved space-time”, *Commun. Math. Phys.*, **237**, 123–160, (2003). [arXiv:gr-qc/0209029 [gr-qc]].
- [220] Holst, S., “Barbero’s Hamiltonian derived from a generalized Hilbert- Palatini action”, *Phys. Rev. D*, **53**, 5966–5969, (1996). [DOI], [arXiv:gr-qc/9511026].
- [221] Immirzi, G., “Real and complex connections for canonical gravity”, *Class. Quantum Grav.*, **14**, L177–L181, (1997).
- [222] Iwasaki, J., “A Reformulation of the Ponzano-Regge quantum gravity model in terms of surfaces”, *arXiv*, e-print, (1994). [arXiv:gr-qc/9410010].
- [223] Iwasaki, J., “A Definition of the Ponzano-Regge quantum gravity model in terms of surfaces”, *J. Math. Phys.*, **36**, 6288–6298, (1995).
- [224] Iwasaki, J., “A lattice quantum gravity model with surface-like excitations in 4-dimensional spacetime”, *arXiv*, e-print, (2000). [arXiv:gr-qc/0006088].
- [225] Iwasaki, J., “A surface theoretic model of quantum gravity”, *arXiv*, e-print, (2000). [arXiv:gr-qc/9903112].
- [226] Jackiw, R., “Liouville field theory: a two-dimensional model for gravity?”, in Christensen, S.M., ed., *Quantum Theory of Gravity: Essays in Honor of the 60th Birthday of Bryce S. DeWitt*, pp. 403–420, (Adam Hilger, Bristol, 1984).
- [227] Jacobson, T., Liberati, S. and Mattingly, D., “Lorentz violation at high energy: Concepts, phenomena and astrophysical constraints”, *Annals Phys.*, **321**, 150–196, (2006). [DOI], [arXiv:astro-ph/0505267 [astro-ph]].
- [228] Jacobson, T. and Smolin, L., “Nonperturbative quantum geometries”, *Nucl. Phys. B*, **299**, 295, (1988).
- [229] Kaminski, W., Kieselowski, M. and Lewandowski, J., “The EPRL intertwiners and corrected partition function”, *Class. Quantum Grav.*, **27**, 165020, (2010). [DOI], [arXiv:0912.0540 [gr-qc]].

- [230] Kaminski, W., Kisielowski, M. and Lewandowski, J., “Spin-Foams for All Loop Quantum Gravity”, *Class. Quantum Grav.*, **27**, 095006, (2010). [DOI], [arXiv:0909.0939 [gr-qc]].
- [231] Kaminski, W., Lewandowski, J. and Pawłowski, T., “Quantum constraints, Dirac observables and evolution: group averaging versus Schroedinger picture in LQC”, *Class. Quantum Grav.*, **26**, 245016, (2009). [DOI], [arXiv:0907.4322].
- [232] Kauffman, L.H. and Lins, S.L., *Temperley-Lieb Recoupling Theory and Invariants of 3-Manifolds*, Annals of Mathematics Studies, (Princeton University Press, Princeton, NJ, 1994). [Google Books].
- [233] Khavkine, Igor, “Quantum astrometric observables I: time delay in classical and quantum gravity”, (2011). [arXiv:1111.7127 [gr-qc]].
- [234] Krasnov, K., “Renormalizable Non-Metric Quantum Gravity?”, (2006). [arXiv:hep-th/0611182].
- [235] Krasnov, K., “On deformations of Ashtekar’s constraint algebra”, *Phys. Rev. Lett.*, **100**, 081102, (2008). [DOI], [arXiv:0711.0090].
- [236] Krasnov, K., “Gravity as BF theory plus potential”, *Int. J. Mod. Phys. A*, **24**, 2776–2782, (2009). [DOI], [arXiv:0907.4064].
- [237] Krasnov, K., “Plebanski gravity without the simplicity constraints”, *Class. Quantum Grav.*, **26**, 055002, (2009). [DOI], [arXiv:0811.3147].
- [238] Krasnov, K., “Metric Lagrangians with two propagating degrees of freedom”, *Europhys. Lett.*, **89**, 30002, (2010). [DOI], [arXiv:0910.4028].
- [239] Lewandowski, J., Okolow, A., Sahlmann, H. and Thiemann, T., “Uniqueness of diffeomorphism invariant states on holonomy- flux algebras”, *Commun. Math. Phys.*, **267**, 703–733, (2006). [DOI], [arXiv:gr-qc/0504147].
- [240] Liu, L., Montesinos, M. and Perez, A., “A topological limit of gravity admitting an SU(2) connection formulation”, *Phys. Rev. D*, **81**, 064033, (2010). [DOI], [arXiv:0906.4524 [gr-qc]].
- [241] Livine, E.R., “Projected spin networks for Lorentz connection: Linking spin foams and loop gravity”, *Class. Quantum Grav.*, **19**, 5525–5542, (2002). [DOI], [arXiv:gr-qc/0207084].
- [242] Livine, E.R., “A Short and Subjective Introduction to the Spinfoam Framework for Quantum Gravity”, *arXiv*, e-print, (2010). [arXiv:1101.5061 [gr-qc]].
- [243] Livine, E.R. and Oeckl, R., “Three-dimensional quantum supergravity and supersymmetric spin foam models”, *Adv. Theor. Math. Phys.*, **7**, 951–1001, (2004). [hep-th/0307251].
- [244] Livine, E.R., Oriti, D. and Ryan, J.P., “Effective Hamiltonian Constraint from Group Field Theory”, *arXiv*, e-print, (2011). [arXiv:1104.5509].
- [245] Livine, E.R., Perez, A. and Rovelli, C., “2D manifold-independent spinfoam theory”, *Class. Quantum Grav.*, **20**, 4425–4445, (2003). [DOI].
- [246] Livine, E.R. and Speziale, S., “A new spinfoam vertex for quantum gravity”, *Phys. Rev. D*, **76**, 084028, (2007). [DOI], [arXiv:0705.0674 [gr-qc]].
- [247] Livine, E.R. and Speziale, S., “Consistently Solving the Simplicity Constraints for Spinfoam Quantum Gravity”, *Europhys. Lett.*, **81**, 50004, (2008). [DOI], [arXiv:0708.1915].

- [248] Livine, E.R., Speziale, S. and Tambornino, J., “Twistor Networks and Covariant Twisted Geometries”, *arXiv*, e-print, (2011). [arXiv:1108.0369 [gr-qc]].
- [249] Livine, E.R. and Tambornino, J., “Spinor Representation for Loop Quantum Gravity”, (2011). [arXiv:1105.3385 [gr-qc]].
- [250] Livine, Etera R. and Martin-Benito, Mercedes, “Classical Setting and Effective Dynamics for Spinfoam Cosmology”, (2011). [arXiv:1111.2867 [gr-qc]].
- [251] Livine, R., Perez, A. and Rovelli, C., “2d manifold-independent spinfoam theory”, *Class. Quantum Grav.*, **20**, (2003). [DOI], [gr-qc/0102051].
- [252] Loll, R., “Simplifying the spectral analysis of the volume operator”, *Nucl. Phys. B*, **500**, 405–420, (1997).
- [253] MacDowell, S.W. and Mansouri, F., “Unified Geometric Theory of Gravity and Supergravity”, *Phys. Rev. Lett.*, **38**, 739, (1977). [DOI]. [Erratum-ibid.38:1376,1977].
- [254] Magliaro, E. and Perini, C., “Comparing LQG with the linearized theory”, *Int. J. Mod. Phys. A*, **23**, 1200–1208, (2008). [DOI].
- [255] Magliaro, E. and Perini, C., “Regge gravity from spinfoams”, *arXiv*, e-print, (2011). [arXiv:1105.0216].
- [256] Magnen, J., Noui, K., Rivasseau, V. and Smerlak, M., “Scaling behaviour of three-dimensional group field theory”, *Class. Quantum Grav.*, **26**, 185012, (2009). [DOI], [arXiv:0906.5477 [hep-th]].
- [257] Mamone, D. and Rovelli, C., “Second-order amplitudes in loop quantum gravity”, *Class. Quantum Grav.*, **26**, 245013, (2009). [DOI], [arXiv:0904.3730 [gr-qc]].
- [258] Markopoulou, F., “Dual formulation of spin network evolution”, *arXiv*, e-print, (1997). [arXiv:gr-qc/9704013].
- [259] Markopoulou, F., “An algebraic approach to coarse graining”, *arXiv*, e-print, (2000). [arXiv:hep-th/0006199].
- [260] Markopoulou, F., “Coarse graining in spin foam models”, *Class. Quantum Grav.*, **20**, 777–800, (2003). [DOI], [arXiv:gr-qc/0203036].
- [261] Markopoulou, F. and Smolin, L., “Causal evolution of spin networks”, *Nucl. Phys. B*, **508**, 409–430, (1997).
- [262] Markopoulou, F. and Smolin, L., “Quantum geometry with intrinsic local causality”, *Phys. Rev. D*, **58**, 084032, (1998).
- [263] Marolf, D., “Group averaging and refined algebraic quantization: Where are we now?”, *arXiv*, e-print, (2000). [arXiv:gr-qc/0011112].
- [264] Mattingly, D., “Modern Tests of Lorentz Invariance”, *Living Rev. Relativity*, **8**, lrr-2005-5, (2005). [arXiv:gr-qc/0502097]. URL (accessed 12 September 2011): <http://www.livingreviews.org/lrr-2005-5>.
- [265] Mikovic, A. and Vojinovic, M., “Effective action and semiclassical limit of spin foam models”, *Class. Quant. Grav.*, **28**, 225004, (2011). [DOI], [arXiv:1104.1384 [gr-qc]].

- [266] Mikovic, Aleksandar and Vojinovic, Marko, “Effective action for EPRL/FK spin foam models”, (2011). [arXiv:1110.6114 [gr-qc]].
- [267] Mikovic, A. and Vojinovic, M., “Graviton propagator asymptotics and the classical limit of ELPR/FK spin foam models”, (2011). [arXiv:1103.1428 [gr-qc]].
- [268] Misner, C.W., “Feynman quantization of general relativity”, *Rev. Mod. Phys.*, **29**, 497–509, (1957). [DOI].
- [269] Montesinos, M. and Perez, A., “Two-dimensional topological field theories coupled to four-dimensional BF theory”, *Phys. Rev. D*, **77**, 104020, (2008). [DOI], [arXiv:0711.2875 [gr-qc]].
- [270] Montesinos, Merced and Velázquez, Mercedes, “Husain-Kuchar model as a constrained BF theory”, in kowalski Glikman, J, Durka, R. and Szczachor, M., eds., *The Planck Scale. Proceedings of the XXV Max Born Symposium*, AIP Conference Proceedings, 1196, pp. 201–208, (American Institute of Physics, New York, 2009), Quantum Gravity Research Networking Programme of the European Science Foundation. [arXiv:0812.2825 [gr-qc]].
- [271] Montesinos, Merced and Velázquez, Mercedes, “Equivalent and alternative forms for BF gravity with Immirzi parameter”, *SIGMA*, (2011). In refereeing process.
- [272] Morales-Tecotl, H.A. and Rovelli, C., “Loop space representation of quantum fermions and gravity”, *Nucl. Phys. B*, **451**, 325–361, (1995).
- [273] Noui, K. and Perez, A., “Observability and geometry in three dimensional quantum gravity”, (2004). [arXiv:gr-qc/0402113].
- [274] Noui, K. and Perez, A., “Three dimensional loop quantum gravity: Coupling to point particles”, *Class. Quantum Grav.*, **22**, 4489–4514, (2005). [DOI], [arXiv:gr-qc/0402111].
- [275] Noui, K. and Perez, A., “Three dimensional loop quantum gravity: Physical scalar product and spin foam models”, *Class. Quantum Grav.*, **22**, 1739–1762, (2005). [DOI], [arXiv:gr-qc/0402110].
- [276] Noui, K., Perez, A. and Pranzetti, D., “Canonical quantization of non-commutative holonomies in 2+1 loop quantum gravity”, *arXiv*, e-print, (2011). [arXiv:1105.0439 [gr-qc]].
- [277] Noui, K. and Roche, P., “Cosmological deformation of Lorentzian spin foam models”, *Class. Quantum Grav.*, **20**, 3175–3214, (2003). [DOI], [arXiv:gr-qc/0211109].
- [278] Oeckl, R., “Generalized lattice gauge theory, spin foams and state sum invariants”, *J. Geom. Phys.*, **46**, 308–354, (2003). [DOI], [arXiv:hep-th/0110259].
- [279] Oeckl, R., “Renormalization of discrete models without background”, *Nucl. Phys. B*, **657**, 107–138, (2003). [DOI], [arXiv:gr-qc/0212047].
- [280] Oeckl, R., *Discrete gauge theory: From lattices to TQFT*, (Imperial College Press, London, UK, 2005). [Google Books].
- [281] Oeckl, R., “Probabilites in the general boundary formulation”, *J. Phys.: Conf. Ser.*, **67**, 012049, (2007). [DOI], [arXiv:hep-th/0612076 [hep-th]].
- [282] Oeckl, R., “Holomorphic quantization of linear field theory in the general boundary formulation”, *arXiv*, e-print, (2010). [arXiv:1009.5615 [hep-th]].
- [283] Oeckl, R., “Affine holomorphic quantization”, *arXiv*, e-print, (2011). [arXiv:1104.5527 [hep-th]].

- [284] Oeckl, R., “Observables in the General Boundary Formulation”, *arXiv*, e-print, (2011). [arXiv:1101.0367 [hep-th]].
- [285] Oeckl, R. and Pfeiffer, H., “The dual of pure non-Abelian lattice gauge theory as a spin foam model”, *Nucl. Phys.*, **B598**, 400–426, (2001). [DOI], [arXiv:hep-th/0008095].
- [286] Ooguri, H., “Topological Lattice Models in Four Dimensions”, *Mod. Phys. Lett. A*, **7**, 2799–2810, (1992).
- [287] Oriti, D., “Spacetime geometry from algebra: Spin foam models for non-perturbative quantum gravity”, *Rept. Prog. Phys.*, **64**, 1489–1544, (2001).
- [288] Oriti, D. and Pfeiffer, H., “A spin foam model for pure gauge theory coupled to quantum gravity”, *Phys. Rev. D*, **66**, 124010, (2002). [DOI], [arXiv:gr-qc/0207041].
- [289] Oriti, D., Rovelli, C. and Speziale, S., “Spinfoam 2d quantum gravity and discrete bundles”, *Class. Quantum Grav.*, **22**, 85–108, (2005). [DOI], [arXiv:gr-qc/0406063].
- [290] Penrose, R., “Combinatorial quantum theory and quantized directions”, in Hughston, L.P. and Ward, R.S., eds., *Advances in Twistor Theory*, Research Notes in Mathematics, **37**, pp. 301–317, (Pitman, San Francisco).
- [291] Penrose, R., “Theory of quantized directions”, unpublished manuscript, (1967).
- [292] Penrose, R., “Angular momentum: an approach to combinatorial space-time”, in Bastin, T., ed., *Quantum Theory and Beyond*, Essays and Discussions Arising from a Colloquium, pp. 151–180, (Cambridge University Press, Cambridge; New York, 1971).
- [293] Penrose, R., “Applications of negative dimensional tensors”, in Welsh, D.J.A., ed., *Combinatorial Mathematics and its Application*, Proceedings of a conference held at the Mathematical Institute, Oxford, from 7–10 July, 1969, pp. 221–243, (Academic Press, London; New York, 1971).
- [294] Pereira, R., “Lorentzian LQG vertex amplitude”, *Class. Quantum Grav.*, **25**, 085013, (2008). [DOI], [arXiv:0710.5043 [gr-qc]].
- [295] Perez, A., “Spin foam models for quantum gravity”, *Class. Quantum Grav.*, **20**, R43, (2003). [arXiv:gr-qc/0301113].
- [296] Perez, A., “Introduction to loop quantum gravity and spin foams”, e-print, (2004). [gr-qc/0409061].
- [297] Perez, A., “On the regularization ambiguities in loop quantum gravity”, *Phys. Rev. D*, **73**, 044007, (2006). [DOI], [arXiv:gr-qc/0509118].
- [298] Perez, A. and Pranzetti, D., “On the regularization of the constraints algebra of Quantum Gravity in 2+1 dimensions with non-vanishing cosmological constant”, *Class. Quantum Grav.*, **27**, 145009, (2010). [DOI], [arXiv:1001.3292 [gr-qc]].
- [299] Perez, A. and Rovelli, C., “3+1 spinfoam model of quantum gravity with spacelike and timelike components”, *Phys. Rev. D*, **64**, 064002, (2001).
- [300] Pfeiffer, H. and Oeckl, R., “The dual of non-Abelian Lattice Gauge Theory”, *Nucl. Phys. Proc. Suppl.*, **106**, 1010–1012, (2002). [DOI], [arXiv:hep-lat/0110034].
- [301] Plebanski, J.F., “On the Separation of Einsteinian Substructures”, *J. Math. Phys.*, **18**, 2511, (1977).

- [302] Polchinski, J., “Comment on [arXiv:1106.1417] ‘Small Lorentz violations in quantum gravity: do they lead to unacceptably large effects?’”, *arXiv*, e-print, (2011). [arXiv:1106.6346 [gr-qc]].
- [303] Ponzano, G. and Regge, T., “Semiclassical limit of Racah Coefficients”, in Bloch, F., Cohen, S. G., de Shalit, A., Sambursky, S. and Talmi, I., eds., *Spectroscopy and Group Theoretical Methods in Physics: Racah Memorial Volume*, pp. 1–58, (North-Holland, Amsterdam, 1968).
- [304] Reisenberger, M.P., “World sheet formulations of gauge theories and gravity”, *arXiv*, e-print, (1994). [arXiv:gr-qc/9412035].
- [305] Reisenberger, M.P., “A lattice worldsheet sum for 4-d Euclidean general relativity”, *arXiv*, e-print, (1997). [arXiv:gr-qc/9711052].
- [306] Reisenberger, M.P., “A left-handed simplicial action for euclidean general relativity”, *Class. Quantum Grav.*, **14**, 1753–1770, (1997).
- [307] Reisenberger, M.P., “On relativistic spin network vertices”, *J.Math. Phys.*, **40**, 2046–2054, (1999).
- [308] Reisenberger, M.P. and Rovelli, C., “Spin foams as Feynman diagrams”, *gr-qc/0002083*.
- [309] Reisenberger, M.P. and Rovelli, C., “Spacetime as a Feynman diagram: the connection formulation”, *Class. Quantum Grav.*, **18**, 121–140, (2001).
- [310] Reisenberger, M.P. and Rovelli, C., “Spacetime states and covariant quantum theory”, *Phys. Rev. D*, **65**, 125016, (2002).
- [311] Reuter, M. and Saueressig, F., “Functional Renormalization Group Equations, Asymptotic Safety, and Quantum Einstein Gravity”, *arXiv*, e-print, (2007). [arXiv:0708.1317 [hep-th]].
- [312] Rezende, D.J. and Perez, A., “4d Lorentzian Holst action with topological terms”, *Phys. Rev. D*, **79**, 064026, (2009). [DOI], [arXiv:0902.3416 [gr-qc]].
- [313] Rivasseau, V., *From Perturbative to Constructive Renormalization*, Princeton Series in Physics, (Princeton University Press, Princeton, NJ, 1991).
- [314] Rovelli, C., “The projector on physical states in loop quantum gravity”, *Phys. Rev. D*, **59**, 104015, (1999).
- [315] Rovelli, C., *Quantum Gravity*, Cambridge Monographs on Mathematical Physics, (Cambridge University Press, Cambridge; New York, 2004). [Google Books].
- [316] Rovelli, C., “Graviton propagator from background-independent quantum gravity”, *Phys. Rev. Lett.*, **97**, 151301, (2006). [DOI], [arXiv:gr-qc/0508124 [gr-qc]].
- [317] Rovelli, C., “Loop Quantum Gravity”, *Living Rev. Relativity*, **11**, lrr-2008-5, (2008). URL (accessed 12 September 2011): <http://www.livingreviews.org/lrr-2008-5>.
- [318] Rovelli, C., “Discretizing parametrized systems: the magic of Ditt-invariance”, *arXiv*, e-print, (2011). [arXiv:1107.2310 [hep-lat]].
- [319] Rovelli, C., “Loop quantum gravity: the first twenty five years”, *Class. Quantum Grav.*, **28**, 153002, (2011). [DOI], [arXiv:1012.4707 [gr-qc]].
- [320] Rovelli, C., “Zakopane lectures on loop gravity”, *arXiv*, e-print, (2011). [arXiv:1102.3660 [gr-qc]].

- [321] Rovelli, C. and Smerlak, M., “In quantum gravity, summing is refining”, *arXiv*, e-print, (2010). [arXiv:1010.5437 [gr-qc]].
- [322] Rovelli, C. and Smolin, L., “Discreteness of the area and volume in quantum gravity”, *Nucl. Phys. B*, **442**, 593–619. [DOI], [gr-qc/9411005]. Erratum: *ibid.* 456 (1995) 753.
- [323] Rovelli, C. and Smolin, L., “Spin Networks and Quantum Gravity”, *Phys. Rev. D*, **53**, 5743, (1995).
- [324] Rovelli, C. and Speziale, S., “Reconcile Planck-scale discreteness and the Lorentz-Fitzgerald contraction”, *Phys. Rev. D*, **67**, 064019, (2003). [DOI], [arXiv:gr-qc/0205108].
- [325] Rovelli, C. and Speziale, S., “On the perturbative expansion of a quantum field theory around a topological sector”, *Gen. Rel. Grav.*, **39**, 167–178, (2007). [DOI], [arXiv:gr-qc/0508106].
- [326] Rovelli, C. and Speziale, S., “Lorentz covariance of loop quantum gravity”, *Phys. Rev. D*, **83**, 104029, (2011). [DOI], [arXiv:1012.1739 [gr-qc]].
- [327] Rovelli, C. and Vidotto, F., “Stepping out of Homogeneity in Loop Quantum Cosmology”, *Class. Quantum Grav.*, **25**, 225024, (2008). [DOI], [arXiv:0805.4585].
- [328] Rovelli, C. and Vidotto, F., “On the spinfoam expansion in cosmology”, *Class. Quantum Grav.*, **27**, 145005, (2010). [DOI], [arXiv:0911.3097].
- [329] Rovelli, Carlo and Wilson-Ewing, Edward, “Discrete Symmetries in Covariant LQG”, (2012). [arXiv:1205.0733 [gr-qc]].
- [330] Rovelli, C. and Zhang, M., “Euclidean three-point function in loop and perturbative gravity”, *arXiv*, e-print, (2011). [arXiv:1105.0566].
- [331] Ruhl, W., *The Lorentz Group and Harmonic Analysis*, (W.A. Benjamin, New York, 1970).
- [332] Ryan, J.P., “Tensor models and embedded Riemann surfaces”, *arXiv*, e-print, (2011). [arXiv:1104.5471 [gr-qc]].
- [333] Sahlmann, H. and Thiemann, T., “Towards the QFT on curved space-time limit of QGR. 1. A General scheme”, *Class. Quantum Grav.*, **23**, 867–908, (2006). [DOI], [arXiv:gr-qc/0207030 [gr-qc]].
- [334] Sahlmann, H. and Thiemann, T., “Towards the QFT on curved space-time limit of QGR. 2. A Concrete implementation”, *Class. Quantum Grav.*, **23**, 909–954, (2006). [DOI], [arXiv:gr-qc/0207031 [gr-qc]].
- [335] Sahlmann, H., Thiemann, T. and Winkler, O., “Coherent states for canonical quantum general relativity and the infinite tensor product extension”, *Nucl. Phys. B*, **606**, 401–440, (2001). [DOI], [arXiv:gr-qc/0102038 [gr-qc]].
- [336] Scharf, G., *Finite Quantum Electrodynamics: The Causal Approach*, (Springer, Berlin; New York, 1995), 2nd edition.
- [337] Smolin, L., “Recent developments in nonperturbative quantum gravity”, in Pérez-Mercader, J., Sola, J. and Verdaguer, E., eds., *Quantum Gravity and Cosmology*, Proceedings of the XXII GIFT International Seminar on Theoretical Physics, Sant Feliu de Guíxols, Catalonia, Spain, 3–8 June 1991, (World Scientific, Singapore, 1992). [hep-th/9202022].
- [338] Smolin, L., “The future of spin networks”, *arXiv*, e-print, (1997). [arXiv:gr-qc/9702030].

- [339] Smolin, L. and Rovelli, C., “Loop space representation of quantum general relativity”, *Nucl. Phys. B*, **331**, 80, (1990).
- [340] Smolin, L. and Starodubtsev, A., “General relativity with a topological phase: An action principle”, (2003). [arXiv:hep-th/0311163].
- [341] Speziale, S., “Coupling gauge theory to spinfoam 3d quantum gravity”, *Class. Quantum Grav.*, **24**, 5139–5160, (2007). [DOI], [arXiv:0706.1534 [gr-qc]].
- [342] Speziale, S., “Bi-metric theory of gravity from the non-chiral Plebanski action”, *Phys. Rev. D*, **82**, 064003, (2010). [DOI], [arXiv:1003.4701].
- [343] Starodubtsev, A., “Topological methods in quantum gravity”. UMI-NR12161.
- [344] ’t Hooft, G., “A locally finite model for gravity”, *Found. Phys.*, **38**, 733–757, (2008). [DOI], [arXiv:0804.0328 [gr-qc]].
- [345] Teitelboim, C., “The Hamiltonian structure of two-dimensional space-time and its relation with the conformal anomaly”, in Christensen, S.M., ed., *Quantum Theory of Gravity: Essays in Honor of the 60th Birthday of Bryce S. DeWitt*, pp. 327–344, (Adam Hilger, Bristol, 1984).
- [346] Thiemann, T., “Anomaly-free formulation of non-perturbative, four-dimensional Lorentzian quantum gravity”, *Phys. Lett. B*, **380**, 257, (1996).
- [347] Thiemann, T., “QSD IV: 2+1 Euclidean quantum gravity as a model to test 3+1 Lorentzian quantum gravity”, *Class. Quantum Grav.*, **15**, 1249–1280, (1998).
- [348] Thiemann, T., “QSD V: Quantum gravity as the natural regulator of matter quantum field theories”, *Class. Quantum Grav.*, **15**, 1281–1314, (1998). [DOI], [arXiv:gr-qc/9705019].
- [349] Thiemann, T., “Gauge field theory coherent states (GCS). I: General properties”, *Class. Quantum Grav.*, **18**, 2025–2064, (2001). [hep-th/0005233].
- [350] Thiemann, T., “Introduction to Modern Canonical Quantum General Relativity”, *arXiv*, e-print, (2001). [arXiv:gr-qc/0110034].
- [351] Thiemann, T., “Coherent states on graphs”, in Gurzadyan, V.G., Jantzen, R.T. and Ruffini, R., eds., *The Ninth Marcel Grossmann Meeting : On recent developments in theoretical and experimental general relativity, gravitation, and relativistic field theories*, Proceedings of the MGIX MM meeting held at the University of Rome ‘La Sapienza’, 2–8 July 2000, (World Scientific, Singapore; River Edge, NJ, 2002). [DOI].
- [352] Thiemann, T., “Complexifier coherent states for quantum general relativity”, *Class. Quantum Grav.*, **23**, 2063–2118, (2006). [DOI], [arXiv:gr-qc/0206037 [gr-qc]].
- [353] Thiemann, T., *Modern Canonical Quantum General Relativity*, Cambridge Monographs on Mathematical Physics, (Cambridge University Press, Cambridge; New York, 2007). [Google Books].
- [354] Thiemann, T. and Winkler, O., “Gauge field theory coherent states (GCS). 2. Peakedness properties”, *Class. Quantum Grav.*, **18**, 2561–2636, (2001). [DOI], [arXiv:hep-th/0005237 [hep-th]].
- [355] Thiemann, T. and Winkler, O., “Gauge field theory coherent states (GCS): 3. Ehrenfest theorems”, *Class. Quantum Grav.*, **18**, 4629–4682, (2001). [DOI], [arXiv:hep-th/0005234 [hep-th]].

- [356] Thiemann, T. and Winkler, O., “Gauge field theory coherent states (GCS) 4: Infinite tensor product and thermodynamical limit”, *Class. Quantum Grav.*, **18**, 4997–5054, (2001). [DOI], [arXiv:hep-th/0005235 [hep-th]].
- [357] Turaev, V.G., *Quantum Invariants of Knots and 3-Manifolds*, (Walter de Gruyter, Berlin; New York, 1994). [Google Books].
- [358] Turaev, V.G. and Viro, O.Y., “Statesum Invariants of 3-manifolds and Quantum 6j-symbols”, *Topology*, **31**, 865–902, (1992).
- [359] Velázquez, M., *BF gravity, matter couplings, and related theories*, Ph.D. thesis, (Cinvestav, Mexico City, 2011).
- [360] Vidotto, F., “Spinfoam Cosmology: quantum cosmology from the full theory”, in Aldaya, V., Barceló, C. and Jaramillo, J.L., eds., *Spanish Relativity Meeting (ERE 2010): Gravity as a Crossroad in Physics*, Proceedings of the Spanish Relativity Meeting, 6–10 September 2010, Granada, Spain, *J. Phys.: Conf. Ser.*, 314, (IOP, Bristol, 2010). [DOI], [arXiv:1011.4705].
- [361] Wald, R.M., *General Relativity*, (University of Chicago Press, Chicago, 1984). [Google Books].
- [362] Wieland, W.M., “Complex Ashtekar variables and reality conditions for Holst’s action”, *arXiv*, e-print, (2010). [arXiv:1012.1738].
- [363] Wieland, W.M., “Twistorial phase space for complex Ashtekar variables”, *arXiv*, e-print, (2011). [arXiv:1107.5002 [gr-qc]].
- [364] Zapata, J.A., *A Combinatorial approach to quantum gauge theories and quantum gravity*, Ph.D. thesis. Online version (accessed 10 October 2011): <http://igpg.gravity.psu.edu/archives/thesis/>.
- [365] Zapata, J.A., “Spin foam model for 3d gravity in the continuum”, Prepared for Conference on Topics in Mathematical Physics, General Relativity, and Cosmology on the Occasion of the 75th Birthday of Jerzy F. Plebanski, Mexico City, Mexico, 17–20 Sep 2002, conference paper.
- [366] Zapata, J.A., “Continuum spin foam model for 3d gravity”, *J. Math. Phys.*, **43**, 5612–5623, (2002). [DOI], [arXiv:gr-qc/0205037].