

FRACTIONAL CALCULUS :
Some Basic Problems in Continuum and Statistical Mechanics

Francesco MAINARDI
Department of Physics, University of Bologna
Via Irnerio 46, I-40126 Bologna, Italy
e-mail: mainardi@bo.infn.it

T_EX PRE-PRINT 58 pages : pp. 291-348

ABSTRACT	p. 291
1. LINEAR VISCOELASTICITY AND FRACTIONAL CALCULUS	p. 292
2. THE BASSET PROBLEM VIA FRACTIONAL CALCULUS	p. 303
3. BROWNIAN MOTION AND FRACTIONAL CALCULUS	p. 311
4. THE FRACTIONAL DIFFUSION-WAVE EQUATION	p. 321
APPENDIX: THE WRIGHT FUNCTION	p. 333
REFERENCES	p. 340

The paper is based on the lectures delivered by the author at the CISM Course *Scaling Laws and Fractality in Continuum Mechanics: A Survey of the Methods based on Renormalization Group and Fractional Calculus*, held at the seat of CISM, Udine, from 23 to 27 September 1996, under the direction of Professors A. Carpinteri and F. Mainardi.

This T_EX pre-print is a revised version (November 2001) of the chapter published in **A. Carpinteri and F. Mainardi (Editors): Fractals and Fractional Calculus in Continuum Mechanics, Springer Verlag, Wien and New York 1997, pp. 291-348.**

Such book is the volume No. 378 of the series CISM COURSES AND LECTURES [ISBN 3-211-82913-X]

PREFACE to the REVISED VERSION

In this revised version a number of misprints have been corrected and several improvements have been introduced. All the plots have been re-drawn by using the MATLAB system; for this the Author is grateful to his students: D. Moretti, G. Pagnini, P. Paradisi, D. Piazza and D. Turrini. Up to some extent the references have been up-dated to the year 2000. For further information about the applications of fractional calculus we recommend the recent treatises

- R. Hilfer (Editor): *Applications of Fractional Calculus in Physics*, World Scientific, Singapore, 2000.
- I. Podlubny: *Fractional Differential Equations*, Academic Press, San Diego, 1999.

To be informed on the developing subject of the applications of fractional calculus in modelling various phenomena, we suggest the interested readers to visit the WEB site <http://www.fracalmo.org> devoted to the fractional calculus modelling.

This 2012 E-print version for arXiv reproduces the 2001 Version. Since that time several papers of the author were published on related topics, see the home page <http://www.fracalmo.org/mainardi>. In particular we point out the book F. Mainardi: *Fractional Calculus and Waves in Linear Viscoelasticity*, Imperial College Press, London (2010), pp. 340, ISBN 978-1-84816-329-4, see: <http://www.icpress.co.uk/mathematics/p614.html>

© 1997, 2001, 2012 Prof. Francesco Mainardi - Bologna - Italy

fmcism20.tex (old version), fmnew20.tex (revised version) in plain T_EX, 58 pages.

FRACTIONAL CALCULUS :
Some Basic Problems in Continuum and Statistical Mechanics

Francesco MAINARDI

Department of Physics, University of Bologna

Via Irnerio 46, I-40126 Bologna, Italy

E-mail: mainardi@bo.infn.it URL: www.fracalmo.org

ABSTRACT

We review some applications of fractional calculus developed by the author (partly in collaboration with others) to treat some basic problems in continuum and statistical mechanics. The problems in continuum mechanics concern mathematical modelling of viscoelastic bodies (§1), and unsteady motion of a particle in a viscous fluid, *i.e.* the Basset problem (§2). In the former analysis fractional calculus leads us to introduce intermediate models of viscoelasticity which generalize the classical spring-dashpot models. The latter analysis induces us to introduce a hydrodynamic model suitable to revisit in §3 the classical theory of the Brownian motion, which is a relevant topic in statistical mechanics. By the tools of fractional calculus we explain the long tails in the velocity correlation and in the displacement variance. In §4 we consider the fractional diffusion-wave equation, which is obtained from the classical diffusion equation by replacing the first-order time derivative by a fractional derivative of order β with $0 < \beta < 2$. Led by our analysis we express the fundamental solutions (the Green functions) in terms of two interrelated auxiliary functions in the similarity variable, which turn out to be of Wright type (see Appendix), and to distinguish slow-diffusion processes ($0 < \beta < 1$) from intermediate processes ($1 < \beta < 2$).

2000 Mathematics Subject Classification: 26A33, 33E12, 44A20, 45J05, 45K05, 60E07, 60G18, 60J60, 60J65, 74D05, 76Dxx.

This research was partially supported by the Ministry of University and by the National Research Council (CNR-GNFM). The author is grateful to Professor Rudolf Gorenflo for fruitful discussions and comments.

1. LINEAR VISCOELASTICITY AND FRACTIONAL CALCULUS

1.1 *Fundamentals of Linear Viscoelasticity*

Viscoelasticity is a property possessed by bodies which, when deformed, exhibit both viscous and elastic behaviour through simultaneous dissipation and storage of mechanical energy. Here, for simplicity, we are restricting the discussion only to the scalar case, *i.e.* to one-dimensional problems. We denote the stress by $\sigma = \sigma(x, t)$ and the strain by $\epsilon = \epsilon(x, t)$ where x and t are the space and time variables, respectively.

According to the *linear* theory of viscoelasticity, at a fixed position, the body may be considered a linear system with the stress (or strain) as the excitation function (input) and the strain (or stress) as the response function (output). Consequently, the response functions to an excitation expressed by the Heaviside step function $\Theta(t)$ are known to play a fundamental role both from a mathematical and physical point of view, see *e.g.* Gross [1], Bland [2], Caputo & Mainardi [3], Christensen [4] and Pipkin [5].

We denote by $J(t)$ the strain response to the unit step of stress (*creep test*), and by $G(t)$ the stress response to a unit step of strain (*relaxation test*). These functions $J(t)$, $G(t)$ are usually referred to as the *creep compliance* and *relaxation modulus* respectively, or, simply, the *material functions* of the viscoelastic body. In view of the causality requirement, both the functions are causal (*i.e.* vanishing for $t < 0$). The limiting values of the material functions for $t \rightarrow 0^+$ and $t \rightarrow +\infty$ are related to the instantaneous (or glass) and equilibrium behaviours of the viscoelastic body, respectively. As a consequence, it is usual to denote $J_g := J(0^+)$ the *glass compliance*, $J_e := J(+\infty)$ the *equilibrium compliance*, and $G_g := G(0^+)$ the *glass modulus*, $G_e := G(+\infty)$ the *equilibrium modulus*. As a matter of fact, both the material functions are non-negative. Furthermore, for $0 < t < +\infty$, $J(t)$ is a differentiable *increasing* function of time, *i.e.*

$$t \in \mathbb{R}^+, \quad \frac{dJ}{dt} > 0 \implies 0 \leq J(0^+) < J(t) < J(+\infty) \leq +\infty,$$

while $G(t)$ is a differentiable *decreasing* function of time, *i.e.*

$$t \in \mathbb{R}^+, \quad \frac{dG}{dt} < 0 \implies +\infty \geq G(0^+) > G(t) > G(+\infty) \geq 0.$$

The above characteristics of monotonicity of $J(t)$ and $G(t)$ are related respectively to the physical phenomena of strain *creep* and stress *relaxation*, which are experimentally observed. Later on, we shall outline more restrictive mathematical conditions that the material functions must usually satisfy to agree with the most common experimental observations.

By using the Boltzmann superposition principle, the general stress–strain relation can be expressed in terms of one material function [$J(t)$ or $G(t)$] through a linear hereditary integral of Stieltjes type, namely

$$\epsilon(t) = \int_{-\infty}^t J(t - \tau) d\sigma(\tau), \quad \text{or} \quad \sigma(t) = \int_{-\infty}^t G(t - \tau) d\epsilon(\tau). \quad (1.1)$$

Usually, the viscoelastic body is quiescent for all times prior to some starting instant that we assume as $t = 0$. Thus, under the assumption of causal histories, differentiable for $t \in \mathbb{R}^+$, the representations (1.1) reduce to

$$\epsilon(t) = \int_{0^-}^t J(t - \tau) d\sigma(\tau) = \sigma(0^+) J(t) + \int_0^t J(t - \tau) \dot{\sigma}(\tau) d\tau, \quad (1.2a)$$

$$\sigma(t) = \int_{0^-}^t G(t - \tau) d\epsilon(\tau) = \epsilon(0^+) G(t) + \int_0^t G(t - \tau) \dot{\epsilon}(\tau) d\tau, \quad (1.2b)$$

where the superposed dot denotes time-differentiation. The lower limits of integration in Eqs (1.2) are written as 0^- to account for the possibility that $\sigma(t)$ and/or $\epsilon(t)$ exhibit jump discontinuities at $t = 0$, and therefore their derivatives $\dot{\sigma}(t)$ and $\dot{\epsilon}(t)$ involve a delta function $\delta(t)$. Another form of the constitutive equations can be obtained from Eqs (1.2) integrating by parts:

$$\epsilon(t) = J_g \sigma(t) + \int_0^t \dot{J}(t - \tau) \sigma(\tau) d\tau, \quad (1.3a)$$

$$\sigma(t) = G_g \epsilon(t) + \int_0^t \dot{G}(t - \tau) \epsilon(\tau) d\tau. \quad (1.3b)$$

Here we have assumed $J_g > 0$ and $J_g < \infty$, see (1.7). The causal functions $\dot{J}(t)$ and $\dot{G}(t)$ are referred to as the *rate of creep (compliance)* and the *rate of relaxation (modulus)*, respectively; they play the role of memory functions in the constitutive equations (1.3). Being of convolution type, equations (1.2) and (1.3) can be conveniently treated by the technique of Laplace transforms to yield

$$\tilde{\epsilon}(s) = s \tilde{J}(s) \tilde{\sigma}(s), \quad \tilde{\sigma}(s) = s \tilde{G}(s) \tilde{\epsilon}(s). \quad (1.4)$$

Since the creep and relaxation integral formulations must agree with one another, there must be a one-to-one correspondence between the relaxation modulus and the creep compliance. The basic relation between $J(t)$ and $G(t)$ is found noticing the following *reciprocity relation* in the Laplace domain, deduced from Eqs (1.4),

$$s \tilde{J}(s) = \frac{1}{s \tilde{G}(s)} \iff \tilde{J}(s) \tilde{G}(s) = \frac{1}{s^2}. \quad (1.5)$$

Then, inverting the R.H.S. of (1.5), we obtain

$$J(t) * G(t) := \int_0^t J(t - \tau) G(\tau) d\tau = t. \quad (1.6)$$

Furthermore, in view of the limiting theorems for the Laplace transform we can deduce from the L.H.S of (1.5) that

$$J_g = \frac{1}{G_g}, \quad J_e = \frac{1}{G_e}, \tag{1.7}$$

with the convention that 0 and $+\infty$ are reciprocal to each other. These remarkable relations allow us to classify the viscoelastic bodies according to their instantaneous and equilibrium responses. In fact, we easily recognize four possibilities for the limiting values of the creep compliance and relaxation modulus, as listed in Table I.

<i>Type</i>	J_g	J_e	G_g	G_e
<i>I</i>	> 0	$< \infty$	$< \infty$	> 0
<i>II</i>	> 0	$= \infty$	$< \infty$	$= 0$
<i>III</i>	$= 0$	$< \infty$	$= \infty$	> 0
<i>IV</i>	$= 0$	$= \infty$	$= \infty$	$= 0$

Table I: The four types of viscoelasticity

From a mathematical point of view the material functions turn out to be of the following form [1]

$$\begin{cases} J(t) = J_g + \chi_+ \int_0^\infty R_\epsilon(\tau) \left(1 - e^{-t/\tau}\right) d\tau + J_+ t, \\ G(t) = G_e + \chi_- \int_0^\infty R_\sigma(\tau) e^{-t/\tau} d\tau + G_- \delta(t). \end{cases} \tag{1.8}$$

where all the coefficients and functions are non negative. The function $R_\epsilon(\tau)$ is referred to as the *retardation spectrum* while $R_\sigma(\tau)$ as the *relaxation spectrum*. For the sake of convenience we shall denote by $R_*(\tau)$ anyone of the two spectra. The spectra must necessarily be locally summable in \mathbb{R}^+ ; if they are summable, the supplementary normalization condition $\int_0^\infty R_*(\tau) d\tau = 1$ is required for the sake of convenience. We devote particular attention to the integral contributions to the material functions (1.8), *i.e.*

$$\begin{cases} \Psi(t) := \chi_+ \int_0^\infty R_\epsilon(\tau) \left(1 - e^{-t/\tau}\right) d\tau \implies (-1)^n \frac{d^n \Psi}{dt^n} < 0, \quad n \in \mathbb{N}, \\ \Phi(t) := \chi_- \int_0^\infty R_\sigma(\tau) e^{-t/\tau} d\tau \implies (-1)^n \frac{d^n \Phi}{dt^n} > 0, \quad n \in \mathbb{N}. \end{cases} \tag{1.9}$$

The positive functions $\Psi(t)$ and $\Phi(t)$ are simply referred to as the *creep* and *relaxation* functions, respectively. According to standard definitions, see *e.g.* [6], the alternating sign properties outlined in the R.H.S. of (1.9) imply that the creep function is of *Bernstein type*, and the relaxation function is *completely monotone*. In particular, we recognize that $\Psi(t)$ is an increasing function with $\Psi(0) = 0$ and $\Psi(+\infty) = \chi_+$ or $+\infty$, while $\Phi(t)$ is a decreasing function with $\Phi(0) = \chi_-$ or $+\infty$ and $\Phi(+\infty) = 0$.

1.2 The Mechanical Models

To get some feeling for linear viscoelastic behaviour, it is useful to consider the simpler behaviour of analog *mechanical models*. They are constructed from linear springs and dashpots, disposed singly and in branches of two (in series or in parallel), as it is indicated in Fig. 1-1.

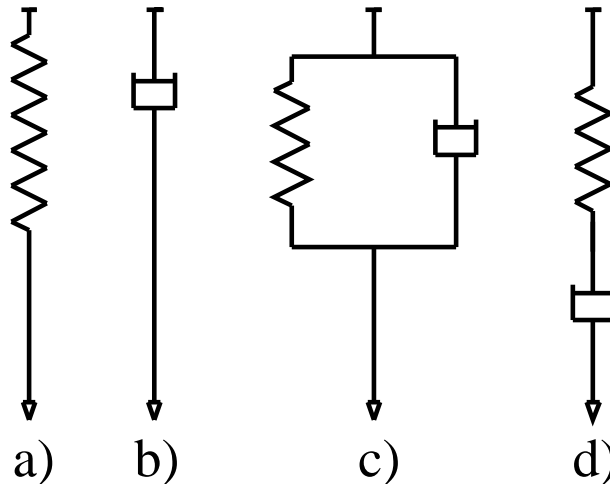

Fig. 1-1

The elements of the mechanical models: a) Hooke, b) Newton, c) Voigt, d) Maxwell

As analog of stress and strain, we use the total extending force and the total extension. We note that when two elements are combined in series [in parallel], their compliances [moduli] are additive. This can be stated as a combination rule: *creep compliances add in series, while relaxation moduli add in parallel*.

The mechanical models play an important role in the literature which is justified by the historical development. In fact, the early theories were established with the aid of these models, which are still helpful to visualise properties and laws of the general theory, using the combination rule.

Now, it is worthwhile to consider the simplest mechanical models and provide their governing stress-strain relations along with the related material functions. We point out that the technique of Laplace transform allows one to easily obtain the requested material functions from the governing equations.

The spring, see Fig. 1-1a), is the elastic (or storage) element, as for it the force is proportional to the extension; it represents a perfect elastic body obeying the Hooke law (ideal solid). This model is thus referred to as the *Hooke* model. We have

$$\sigma(t) = m \epsilon(t) \quad \text{Hooke} \quad \begin{cases} J(t) = 1/m \\ G(t) = m \end{cases} \quad (1.10)$$

The dashpot, see Fig. 1-1b), is the viscous (or dissipative) element, the force being proportional to the rate of extension; it represents a perfectly viscous body obeying the Newton law (perfect liquid). This model is thus referred to as the *Newton* model. We have

$$\sigma(t) = b \frac{d\epsilon}{dt} \quad \text{Newton} \quad \begin{cases} J(t) = t/b \\ G(t) = b \delta(t) \end{cases} \quad (1.11)$$

We note that the *Hooke* and *Newton* models represent the limiting cases of viscoelastic bodies of type *I* and *IV*, respectively.

A branch constituted by a spring in parallel with a dashpot is known as the *Voigt* model, see Fig. 1-1c). We have

$$\sigma(t) = m \epsilon(t) + b \frac{d\epsilon}{dt} \quad \text{Voigt} \quad \begin{cases} J(t) = \frac{1}{m} [1 - e^{-t/\tau_\epsilon}] \\ G(t) = m + b \delta(t) \end{cases} \quad (1.12)$$

where $\tau_\epsilon = b/m$ is referred to as the *retardation time*.

A branch constituted by a spring in series with a dashpot is known as the *Maxwell* model, see Fig. 1-1d). We have

$$\sigma(t) + a \frac{d\sigma}{dt} = b \frac{d\epsilon}{dt} \quad \text{Maxwell} \quad \begin{cases} J(t) = \frac{a}{b} + \frac{t}{b} \\ G(t) = \frac{b}{a} e^{-t/\tau_\sigma} \end{cases} \quad (1.13)$$

where $\tau_\sigma = a$ is referred to as the *relaxation time*.

The *Voigt* and the *Maxwell* models are thus the simplest viscoelastic bodies of type *III* and *II*, respectively. The *Voigt* model exhibits an exponential (reversible) strain creep but no stress relaxation; it is also referred to as the retardation element. The *Maxwell* model exhibits an exponential (reversible) stress relaxation and a linear (non reversible) strain creep; it is also referred to as the relaxation element.

Adding a spring either in series to a Voigt model, see Fig. 1-2a), or in parallel to a Maxwell model, see Fig. 1-2b), means, according to the combination rule, to add a positive constant both to the Voigt-like creep compliance and to the Maxwell-like relaxation modulus so that we obtain $J_g > 0$ and $G_e > 0$. Such a model was introduced by Zener [7] with the denomination of *Standard Linear Solid (S.L.S.)*. We have

$$\left[1 + a \frac{d}{dt}\right] \sigma(t) = \left[m + b \frac{d}{dt}\right] \epsilon(t) \quad \text{SLS} \quad \begin{cases} J(t) = J_g + \chi_+ [1 - e^{-t/\tau_\epsilon}] \\ G(t) = G_e + \chi_- e^{-t/\tau_\sigma} \end{cases} \quad (1.14)$$

$$\begin{cases} J_g = \frac{a}{b}, & \chi_+ = \frac{1}{m} - \frac{a}{b}, & \tau_\epsilon = \frac{b}{m}, \\ G_e = m, & \chi_- = \frac{b}{a} - m, & \tau_\sigma = a. \end{cases} \quad (1.15)$$

We point out that the condition $0 < m < b/a$ ensures that χ_+, χ_- are positive and hence $0 < J_g < J_e < \infty, 0 < G_e < G_g < \infty$ and $0 < \tau_\sigma < \tau_\epsilon < \infty$. The *S.L.S.* is the simplest (3-parameter) viscoelastic body of type *I*. On the other hand, adding a dashpot either in series to a Voigt model, see Fig. 1-2c), or in parallel to a Maxwell model, see Fig. 1-2d), we obtain the simplest (3-parameter) viscoelastic body of type *IV*.

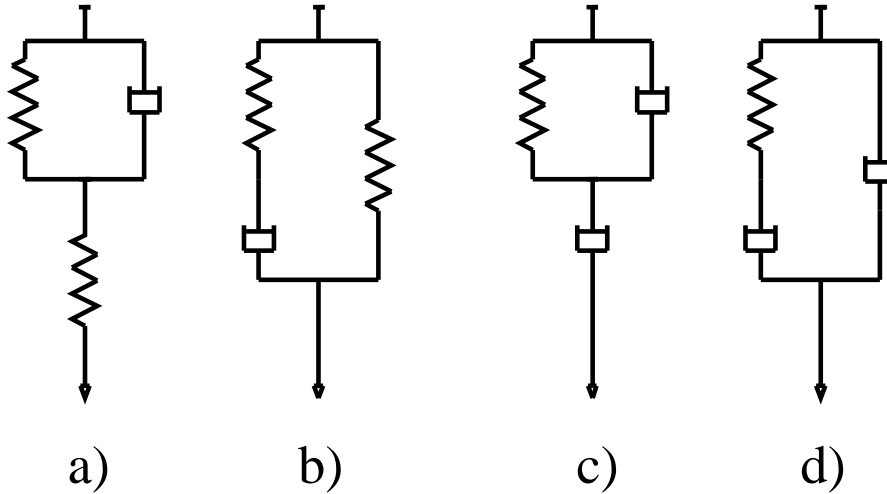

Fig. 1-2

- a) spring in series with Voigt, b) spring in parallel with Maxwell;
- c) dashpot in series with Voigt, d) dashpot in parallel with Maxwell.

Based on the combination rule, we can construct models whose material functions are of the following type

$$\begin{cases} J(t) = J_g + \sum_n J_n [1 - e^{-t/\tau_{\epsilon,n}}] + J_+ t, \\ G(t) = G_e + \sum_n G_n e^{-t/\tau_{\sigma,n}} + G_- \delta(t), \end{cases} \quad (1.16)$$

where all the coefficient are non-negative. These functions must be interrelated because of the *reciprocity relation* (1.5) in the Laplace domain. Appealing to the theory of Laplace transforms [2], it turns out that stress-strain relation must be a linear differential equation with constant (positive) coefficients of the following form

$$\left[1 + \sum_{k=1}^p a_k \frac{d^k}{dt^k} \right] \sigma(t) = \left[m + \sum_{k=1}^q b_k \frac{d^k}{dt^k} \right] \epsilon(t), \quad p = q \quad \text{or} \quad p = q + 1. \quad (1.17)$$

Eq. (1.17) is referred to as the *operator equation* for the mechanical models.

1.3 *The Fractional Viscoelastic Models*

Let us now consider a *creep compliance* of the form

$$J(t) = \Psi(t) = a \frac{t^\alpha}{\Gamma(1 + \alpha)}, \quad a > 0, \quad 0 < \alpha < 1, \quad (1.18)$$

where Γ denotes the Gamma function. Such behaviour is found to be of some interest in creep experiments; usually it is referred to as *power-law* creep. This law appears compatible with the mathematical theory presented in the previous sub-section, in that there exists a corresponding *retardation spectrum*, locally summable, which reads

$$R_\epsilon(\tau) = \frac{\sin \pi \alpha}{\pi} \frac{1}{\tau^{1-\alpha}}. \quad (1.19)$$

For such a model the *relaxation modulus* can be derived from the reciprocity relation (1.5) and reads

$$G(t) = \Phi(t) = b \frac{t^{-\alpha}}{\Gamma(1 - \alpha)}, \quad b = 1/a > 0. \quad (1.20)$$

However, the corresponding *relaxation spectrum* does not exist in the ordinary sense, in that it would be

$$R_\sigma(\tau) = \frac{\sin \pi \alpha}{\pi} \frac{1}{\tau^{1+\alpha}}, \quad (1.21)$$

and thus not locally summable. The stress-strain relation in the *creep representation*, obtained from (1.1) and (1.18) is therefore

$$\epsilon(t) = \frac{a}{\Gamma(1 + \alpha)} \int_{-\infty}^t (t - \tau)^\alpha d\sigma. \quad (1.22)$$

Writing $d\sigma = \dot{\sigma}(\tau) d\tau$ and integrating by parts, we finally obtain

$$\epsilon(t) = \frac{a}{\Gamma(\alpha)} \int_{-\infty}^t (t - \tau)^{\alpha-1} \sigma(\tau) d\tau = a J_{-\infty}^\alpha [\sigma(t)], \quad (1.23)$$

where $J_{-\infty}^\alpha$ denotes the *fractional integral* of order α with starting point $-\infty$, see Gorenflo & Mainardi [8].

In the *relaxation representation* the stress-strain relation can be obtained from (1.1) and (1.20). Writing $d\epsilon = \dot{\epsilon}(\tau) d\tau$, we obtain

$$\sigma(t) = \frac{b}{\Gamma(1 - \alpha)} \int_{-\infty}^t (t - \tau)^{-\alpha} \left[\frac{d\epsilon(\tau)}{d\tau} \right] d\tau = b \frac{d^\alpha \epsilon(t)}{dt^\alpha}, \quad (1.24)$$

where

$$\frac{d^\alpha}{dt^\alpha} = D_{*-\infty}^\alpha = J_{-\infty}^{1-\alpha} \frac{d}{dt} \quad (1.25)$$

denotes the *Caputo fractional derivative* of order α with starting point $-\infty$, see Gorenflo and Mainardi [8].

Of course, for causal histories, the starting point of the integrals in (1.22-25) is 0, so that we must consider the operators J^α and D_*^α . Since in the limit as $\alpha \rightarrow 1$ the fractional integral and derivative tend to the ordinary integral and derivative, respectively, we note that the classical Newton model can be recovered from (1.23) and (1.24) by setting $\alpha = 1$.

In textbooks on rheology the relation (1.24), when expressed with the fractional derivative, is usually referred to as the *Scott-Blair stress-strain law* from the name of the scientist [9], who in earlier times proposed such a constitutive equation to introduce a material property that is intermediate between the elastic modulus (Hooke solid) and the coefficient of viscosity (Newton fluid).

The use of *fractional calculus* in linear viscoelasticity leads to a generalization of the classical mechanical models in that the basic Newton element (dashpot) is substituted by the more general Scott-Blair element. In fact, we can construct the class of these generalized models from Hooke and Scott-Blair elements, disposed singly and in branches of two (in series or in parallel). The material functions are obtained using the combination rule; their determination is made easy if we take into account the following *correspondence principle* between the classical and fractional mechanical models, as stated by Caputo & Mainardi [3],

$$(0 < \alpha < 1) \quad \begin{cases} t \rightarrow \frac{t^\alpha}{\Gamma(1 + \alpha)}, \\ \delta(t) \rightarrow \frac{t^{-\alpha}}{\Gamma(1 - \alpha)}, \\ e^{-t/\tau} \rightarrow E_\alpha[-(t/\tau)^\alpha], \end{cases} \quad (1.26)$$

where E_α denotes the Mittag-Leffler function of order α , heavily used in [8].

We verify the *correspondence principle* by considering the *fractional S.L.S.*, formerly introduced by Caputo & Mainardi [10] in 1971. Such model is based on the following operator equation of fractional order, which generalises the operator equation (1.14) for the *S.L.S.*,

$$\left[1 + a \frac{d^\alpha}{dt^\alpha}\right] \sigma(t) = \left[m + b \frac{d^\alpha}{dt^\alpha}\right] \epsilon(t), \quad 0 < \alpha \leq 1. \quad (1.27)$$

This equation is better analysed in the Laplace domain where we obtain

$$(1 + a s^\alpha) \tilde{\sigma}(s) = (m + b s^\alpha) \tilde{\epsilon}(s) \iff s \tilde{J}(s) = \frac{1}{s \tilde{G}(s)} = \frac{1 + a s^\alpha}{m + b s^\alpha}. \quad (1.28)$$

From the fractional operator equation we can obtain as particular cases, besides the trivial elastic model ($a = b = 0$) and the fractional Newton or Scott-Blair model ($a = m = 0, b = \beta$) already considered, the fractional Voigt model ($a = 0$) and the fractional Maxwell model ($m = 0$).

Working in the Laplace domain and then inverting, we obtain for the fractional Voigt and Maxwell models

$$\sigma(t) = m \epsilon(t) + b \frac{d^\alpha \epsilon}{dt^\alpha} \quad \text{Fractional Voigt} \quad \begin{cases} J(t) = \frac{1}{m} \{1 - E_\alpha [-(t/\tau_\epsilon)^\alpha]\} \\ G(t) = m + b \frac{t^{-\alpha}}{\Gamma(1-\alpha)} \end{cases} \quad (1.29)$$

$$\sigma(t) + a \frac{d^\alpha \sigma}{dt^\alpha} = b \frac{d^\alpha \epsilon}{dt^\alpha} \quad \text{Fractional Maxwell} \quad \begin{cases} J(t) = \frac{a}{b} + \frac{1}{b} \frac{t^\alpha}{\Gamma(1+\alpha)} \\ G(t) = \frac{b}{a} E_\alpha [-(t/\tau_\sigma)^\alpha] \end{cases} \quad (1.30)$$

where $(\tau_\epsilon)^\alpha = b/m$ and $(\tau_\sigma)^\alpha = a$.

Having recognized with (1.29-30) the validity of the Caputo-Mainardi *correspondence principle* for the basic models, we are allowed to use this principle to obtain the material functions of higher models, including the fractional S.L.S., along with the corresponding operator equations of fractional order. Thus, by generalizing (1.16), we obtain

$$\begin{cases} J(t) = J_g + \sum_n J_n \{1 - E_\alpha [-(t/\tau_{\epsilon,n})^\alpha]\} + J_+ \frac{t^\alpha}{\Gamma(1+\alpha)}, \\ G(t) = G_e + \sum_n G_n E_\alpha [-(t/\tau_{\sigma,n})^\alpha] + G_- \frac{t^{-\alpha}}{\Gamma(1-\alpha)}, \end{cases} \quad (1.31)$$

where all the coefficients are non negative. Extending the procedures of the classical mechanical models, we will get the *fractional operator equation* in the form which properly generalises (1.17), *i.e.*

$$\left[1 + \sum_{k=1}^p a_k \frac{d^{\alpha_k}}{dt^{\alpha_k}} \right] \sigma(t) = \left[m + \sum_{k=1}^q b_k \frac{d^{\alpha_k}}{dt^{\alpha_k}} \right] \epsilon(t), \quad \alpha_k = k + \alpha - 1. \quad (1.32)$$

We conclude this section pointing out the presence of the Mittag-Leffler function in (1.31). In fact, the *creep* and *relaxation* functions for the fractional models contain contributions of type

$$\begin{cases} \Psi(t) = \chi_+ \{1 - E_\alpha [-(t/\tau_\epsilon)^\alpha]\} = \chi_+ \int_0^\infty R_\epsilon(\tau) \left(1 - e^{-t/\tau}\right) d\tau, \\ \Phi(t) = \chi_- E_\alpha [-(t/\tau_\sigma)^\alpha] = \chi_- \int_0^\infty R_\sigma(\tau) e^{-t/\tau} d\tau. \end{cases} \quad (1.33)$$

Denoting as usual by * the suffix ϵ or σ , the analytical expressions of the retardation and relaxation spectra turn out to be identical, namely

$$R_*(\tau) = \frac{1}{\pi \tau} \frac{\sin \alpha \pi}{(\tau/\tau_*)^\alpha + (\tau/\tau_*)^{-\alpha} + 2 \cos \alpha \pi}. \quad (1.34)$$

This result can be deduced from the spectral representation of the Mittag-Leffler function $E_\alpha [-(t/\tau_*)^\alpha]$, as shown by Caputo and Mainardi [3], and recently by Gorenflo & Mainardi [8] in the framework of their analysis of the fractional relaxation equation.

We can have a better insight of the spectral function $R_*(\tau)$ and of the relaxation function $E_\alpha [-(t/\tau_*)^\alpha]$ by showing the corresponding plots for a few values of α . Assuming $\tau_* = 1$, we could simply refer to the plots reported in [8] by Fig. 1a and Fig. 2a, but, for the sake of convenience, we prefer to exhibit them again in Fig. 1-3 and Fig. 1-4, hereafter.

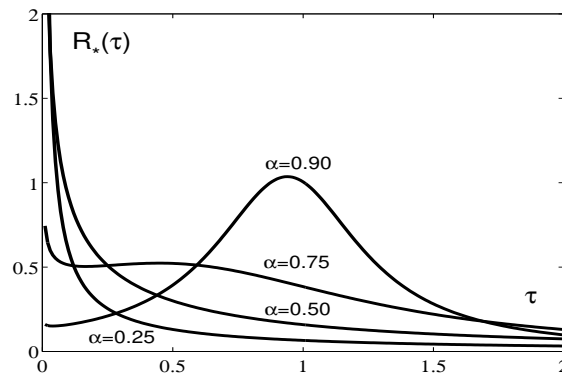

Fig. 1-3

Spectral function $R_*(\tau)$ for $\alpha = 0.25, 0.50, 0.75, 0.90$.

From the plots of $R_*(\tau)$ in Fig. 1-3 we can easily recognize the effect of the variation of α on the character of the spectral function; for $\alpha \rightarrow 1$ the spectrum becomes sharper and sharper until for $\alpha = 1$ it reduces to be discrete with a single retardation/relaxation time. We also recognize that $R_*(\tau)$ is a decreasing function of τ for $0 < \alpha < \alpha_*$ where $\alpha_* \approx 0.736$ is the solution of the equation $\alpha = \sin \alpha\pi$; subsequently, with increasing α , it first exhibits a minimum and then a maximum before tending to the impulsive function $\delta(\tau - \tau_*)$ as $\alpha \rightarrow 1$. Recalling the analysis of the fractional relaxation equation by Gorenflo and Mainardi [8], we recognize that, compared to the exponential obtained for $\alpha = 1$, the *fractional* relaxation function exhibits very different behaviours, as can be seen from the plots of $E_\alpha(-t^\alpha)$ in Fig. 1-4. In particular, we point out the leading asymptotic behaviours at small and large times,

$$E_\alpha(-t^\alpha) \sim \begin{cases} 1 - t^\alpha/\Gamma(1 + \alpha), & \text{as } t \rightarrow 0^+, \\ t^{-\alpha}/\Gamma(1 - \alpha), & \text{as } t \rightarrow +\infty. \end{cases} \quad (1.35)$$

Compared to the solution $\exp(-t)$ for the classical models ($\alpha = 1$), the solution $E_\alpha(-t^\alpha)$ for the fractional models ($0 < \alpha < 1$) exhibits initially a much faster decay (the derivative tends to $-\infty$ in comparison with -1), and for large times a much

slower decay (algebraic decay in comparison with exponential decay). In view of its final slow decay, the phenomenon of fractional relaxation is usually referred to as a *super-slow process*.

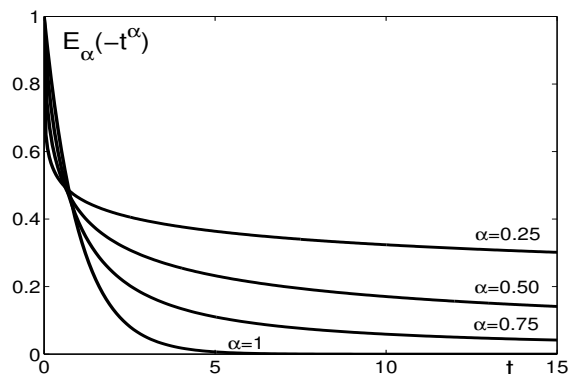

Fig. 1-4

Relaxation function $E_\alpha(-t^\alpha)$ for $\alpha = 0.25, 0.50, 0.75, 1$.

1.4 Bibliographical remarks

A number of authors have, *implicitly* or *explicitly*, used *fractional calculus* as an empirical method of describing the properties of viscoelastic materials.

In the first half of this century Gemant [11-12] and, later, Scott-Blair [9, 13] were early contributors in the use of fractional calculus to study phenomenological constitutive equations for viscoelastic media.

Independently, in the former Soviet Union, Rabotnov [14-15] introduced his theory of hereditary solid mechanics with weakly singular kernels, that *implicitly* requires fractional derivatives. This theory was developed also by other soviet scientists including Meshkov and Rossikhin, see *e.g.* [16], and Lokshin and Suvorova, see *e.g.* [17].

In 1971, extending earlier work by Caputo [18-20], Caputo and Mainardi [3,10] suggested that derivatives of fractional order could be successfully used to model the dissipation in seismology and in metallurgy. Since then up to nowadays, applications of fractional calculus in rheology have been considered by several authors. Without claim of being exhaustive, we now quote some papers of which the author became aware during the last 25 years. In addition to Caputo [21-24] and Mainardi [25-26] we like to refer to Smith and de Vries [27], Scarpi [28], Stiassnie [29], Bagley and Torvik [30-33], Rogers [34], Koeller [35-36], Koh and Kelly [37], Friedrich [38], Nonnenmacher and Glöckle [39-40], Makris and Constantinou [41], Heymans and Bauwens [42], Schiessel & al [43], Gaul & al [44], Beyer and Kempfle [45], Fenander [46], Pritz [47], Rossikhin & al [48-49], and Lion [50].

2. THE BASSET PROBLEM VIA FRACTIONAL CALCULUS

2.1 Introduction

The dynamics of a sphere immersed in an incompressible viscous fluid represents a classical problem, which has many applications in flows of geophysical and engineering interest. Usually, the low Reynolds number limit (slow motion approximation) is assumed so that the Navier-Stokes equations describing the fluid motion may be linearised.

The particular but relevant situation of a sphere subjected to gravity was first considered independently by Boussinesq [51] in 1885 and by Basset [52] in 1888, who introduced a special hydrodynamic force, related to the history of the relative acceleration of the sphere, which is nowadays referred to as *Basset force*. The relevance of these studies was in that, up to then, only steady motions or small oscillations of bodies in a viscous liquid had been considered starting from Stokes' celebrated memoir on pendulums [53], in 1851. The subject matter was considered with more details in 1907 by Picciati [54] and Boggio [55], in some notes presented by the great Italian scientist Levi-Civita. The whole was summarised by Basset himself in a later paper [56], and, in more recent times, by Hughes and Gilliland [57].

Nowadays the dynamics of impurities in unsteady flows is quite relevant as shown by several publications, whose aim is to provide more general expressions for the hydrodynamic forces, including the Basset force, in order to fit experimental data and numerical simulations, see *e.g.* [58-66].

In the next section we shall recall the general equation of motion for a spherical particle, in a viscous fluid, pointing out the different force contributions due to effects of inertia, viscous drag and buoyancy. In particular, the so-called Basset force will be interpreted in terms of a fractional derivative of order $1/2$ of the particle velocity relative to the fluid. Based on our recent works [67-68], we shall introduce the *generalized Basset force*, which is expressed in terms of a fractional derivative of any order α ranging in the interval $0 < \alpha < 1$. This generalization, suggested by a mathematical speculation, is expected to provide a phenomenological insight for the experimental data.

In section §2.3 we shall consider the simplified problem, originally investigated by Basset, where the fluid is quiescent and the particle moves under the action of gravity, starting at $t = 0$ with a certain vertical velocity. For the sake of generality, we prefer to consider the problem with the generalized Basset force and will provide the solution for the particle velocity in terms of Mittag-Leffler -type functions. The most evident effect of this generalization will be to modify the long-time behaviour of the solution, changing its algebraic decay from $t^{-1/2}$ to $t^{-\alpha}$. This effect can be of some interest for a better fit of experimental data.

2.2 The Equation of Motion

Let us consider a small rigid sphere of radius r_0 , mass m_p , density ρ_p , initially centred in $X(t)$ and moving with velocity $V(t)$ in a homogeneous fluid, of density ρ_f and kinematic viscosity ν , characterized by a flow field $u(x, t)$. In general the equation of motion is required to take into account effects due to inertia, viscous drag and buoyancy, so it can be written as

$$m_p \frac{dV}{dt} = F_i + F_d + F_g, \quad (2.1)$$

where the forces on the R.H.S. correspond in turn to the above effects. According to Maxey and Riley [60] these forces read, adopting our notation,

$$F_i = m_f \left. \frac{Du}{Dt} \right|_{X(t)} - \frac{1}{2} m_f \left(\frac{dV}{dt} - \left. \frac{Du}{Dt} \right|_{X(t)} \right), \quad (2.2)$$

$$F_d = -\frac{1}{\mu} \left\{ [V(t) - u(X(t), t)] + \sqrt{\frac{\tau_0}{\pi}} \int_{-\infty}^t \frac{d[V(\tau) - u(X(\tau), \tau)]/d\tau}{\sqrt{t - \tau}} d\tau \right\}, \quad (2.3)$$

$$F_g = (m_p - m_f) g, \quad (2.4)$$

where $m_f = (4/3)\pi r_0^3 \rho_f$ denotes the mass of the fluid displaced by the spherical particle, and

$$\tau_0 := \frac{r_0^2}{\nu}, \quad (2.5)$$

$$\frac{1}{\mu} := 6\pi r_0 \nu \rho_f = \frac{9}{2} m_f \tau_0^{-1}. \quad (2.6)$$

The time constant τ_0 represents a sort of time scale induced by viscosity, whereas the constant μ is usually referred to as the *mobility coefficient*.

In (2.2) we note two different time derivatives, D/Dt , d/dt , which represent the time derivatives following a fluid element and the moving sphere, respectively, so

$$\left. \frac{Du}{Dt} \right|_{X(t)} = \left[\frac{\partial u}{\partial t} + (u \cdot \nabla) u(x, t) \right], \quad \frac{d}{dt} u[X(t), t] = \left[\frac{\partial u}{\partial t} + (V \cdot \nabla) u(x, t) \right],$$

where the brackets are computed at $x = X(t)$.

The terms on the R.H.S. of (2.2) correspond in turn to the effects of pressure gradient of the undisturbed flow and of added mass, whereas those of (2.3) represent respectively the well-known viscous Stokes drag, that we shall denote by F_S , and to the augmented viscous Basset drag denoted by F_B . Using the characteristic time τ_0 , the Stokes and Basset forces read respectively

$$F_S = -\frac{9}{2} m_f \tau_0^{-1} [V(t) - u(X(t), t)], \quad (2.7)$$

$$F_B = -\frac{9}{2} m_f \tau_0^{-1/2} \left\{ \frac{1}{\sqrt{\pi}} \int_{-\infty}^t \frac{d[V(\tau) - u(X(\tau), \tau)]/d\tau}{\sqrt{t - \tau}} d\tau \right\}. \quad (2.8)$$

We thus recognize that the time constant τ_0 provides the natural time scale for the diffusive processes related to the fluid viscosity, and that the integral expression in brackets at the R.H.S. of (2.8) just represents the *Caputo fractional derivative* of order $1/2$, with starting point $-\infty$, of the particle velocity relative to the fluid *.

We now introduce the *generalized Basset force* by the definition

$$F_B^\alpha = -\frac{9}{2} m_f \tau_0^{\alpha-1} \frac{d^\alpha}{dt^\alpha} [V(t) - u(X(t), t)], \quad 0 < \alpha < 1, \quad (2.9)$$

where the fractional derivative of order α is in Caputo's sense, in agreement with the notation introduced in §1.3 for the fractional viscoelastic models, see (1.25).

Introducing the so-called *effective mass*

$$m_e := m_p + \frac{1}{2} m_f, \quad (2.10)$$

and allowing for the *generalized Basset force* in (2.3), we can re-write the equation of motion (2.1-4) in the more compact and significant form,

$$m_e \frac{dV}{dt} = \frac{3}{2} m_f \frac{Du}{Dt} - \frac{9}{2} m_f \left[\frac{1}{\tau_0} + \frac{1}{\tau_0^{1-\alpha}} \frac{d^\alpha}{dt^\alpha} \right] (V - u) + (m_p - m_f) g, \quad (2.11)$$

that we refer to as the *generalized equation of motion*. Of course, if in (2.11) we put $\alpha = 1/2$, we recover the *basic equation of motion* with the original Basset force.

2.3 The (Generalized) Basset Problem

Let us now assume that the fluid is quiescent, namely $u(x, t) = 0, \forall x, t$, and the particle starts to move under the action of gravity, from a given instant $t_0 = 0$ with a certain velocity $V(0^+) = V_0$, in the vertical direction. This was the problem considered by Basset [52], that was first solved by Boggio [55], in a cumbersome way, in terms of Gauss and Fresnel integrals.

Introducing the non-dimensional quantities (related to the densities ρ_f, ρ_p of the fluid and particle),

$$\chi := \frac{\rho_p}{\rho_f}, \quad \beta := \frac{9\rho_f}{2\rho_p + \rho_f} = \frac{9}{1 + 2\chi}, \quad (2.12)$$

we find it convenient to define a new characteristic time

$$\sigma_e := \mu m_e = \tau_0 / \beta, \quad (2.13)$$

see (2.5), (2.10), (2.12), and a characteristic velocity (related to the gravity),

$$V_S = (2/9) (\chi - 1) g \tau_0. \quad (2.14)$$

* Presumably, the first scientist who has pointed out the relationship between the Basset force and the fractional calculus has been Tatom [69] in 1988. However, Tatom has limited himself to note this fact, without treating any related problem by the methods of fractional calculus.

Then we can eliminate the mass factors and the gravity acceleration in (2.11) and obtain the *equation of motion* in the form

$$\frac{dV}{dt} = -\frac{1}{\sigma_e} \left[1 + \tau_0^\alpha \frac{d^\alpha}{dt^\alpha} \right] V + \frac{1}{\sigma_e} V_S. \quad (2.15)$$

If the Basset term were absent, we obtain the classical Stokes solution

$$V(t) = V_S + (V_0 - V_S) e^{-t/\sigma_e}, \quad (2.16)$$

where σ_e represents the characteristic time of the motion, and V_S the final value assumed by the velocity. Later we shall show that in the presence of the Basset term the same final value is still attained by the solution $V(t)$, but with an algebraic rate, which is much slower than the exponential one found in (2.16).

In order to investigate the effect of the (generalized) Basset term, we compare the exact solution of (2.15) with the Stokes solution (2.16); for this aim we find it convenient to scale times and velocities in (2.15) with $\{\sigma_e, V_S\}$, *i.e.* to refer to the non dimensional quantities $t' = t/\sigma_e$, $V' = V/V_S$, $V'_0 = V_0/V_S$. The resulting equation of motion reads (suppressing the apices)

$$\left[\frac{d}{dt} + a \frac{d^\alpha}{dt^\alpha} + 1 \right] V(t) = 1, \quad V(0^+) = V_0, \quad a = \beta^\alpha > 0, \quad 0 < \alpha < 1. \quad (2.17)$$

This is the *composite fractional relaxation equation* treated by Gorenflo and Mainardi [8] in §4.1 by using the Laplace transform method. Recalling that in an obvious notation we have

$$V(t) \div \tilde{V}(s), \quad \frac{d^\alpha}{dt^\alpha} V(t) \div s^\alpha \tilde{V}(s) - s^{\alpha-1} V_0, \quad 0 < \alpha \leq 1, \quad (2.18)$$

the transformed solution of (2.17) reads

$$\tilde{V}(s) = \tilde{M}(s) V_0 + \frac{1}{s} \tilde{N}(s), \quad (2.19)$$

where

$$\tilde{M}(s) = \frac{1 + a s^{\alpha-1}}{s + a s^\alpha + 1}, \quad \tilde{N}(s) = \frac{1}{s + a s^\alpha + 1}. \quad (2.20)$$

Noting that

$$\frac{1}{s} \tilde{N}(s) = \frac{1}{s} - \tilde{M}(s) \div \int_0^t N(\tau) d\tau = 1 - M(t) \iff N(t) = -M'(t), \quad (2.21)$$

the actual solution of (2.17) turns out to be

$$V(t) = 1 + (V_0 - 1) M(t), \quad (2.22)$$

which is "similar" to the Stokes solution (2.16) if we consider the substitution of e^{-t} with the function $M(t)$.

In [67-68] Mainardi, Pironi and Tampieri have used a factorisation method to invert $\widetilde{N}(s)$ and henceforth $\widetilde{M}(s)$, using a procedure indicated by Miller and Ross [69], which is valid when α is a rational number, say $\alpha = p/q$, where $p, q \in \mathbb{N}$, $p < q$. In this way the actual solution can be finally expressed as a linear combination of certain incomplete gamma functions. This algebraic method is of course convenient for the ordinary Basset problem ($\alpha = 1/2$), but becomes cumbersome for $q > 2$.

Here, following the analysis in [8], we prefer to adopt the general method of inversion based on the complex Bromwich formula. By this way we are free from the restriction of being α a rational number and, furthermore, we are able to provide an integral representation of the solution, convenient for numerical computation, which allows us to recognize the monotonicity properties of the solution without need of plotting.

We now resume the relevant results from [8] using the present notation. The integral representation for $M(t)$ turns out to be

$$M(t) = \int_0^\infty e^{-rt} K(r) dr, \tag{2.23}$$

where

$$K(r) = \frac{1}{\pi} \frac{a r^{\alpha-1} \sin(\alpha\pi)}{(1-r)^2 + a^2 r^{2\alpha} + 2(1-r) a r^\alpha \cos(\alpha\pi)} > 0. \tag{2.24}$$

Thus $M(t)$ is a *completely monotone* function [with spectrum $K(r)$], which is decreasing from 1 towards 0 as t runs from 0 to ∞ . The behaviour of $M(t)$ as $t \rightarrow 0^+$ and $t \rightarrow \infty$ can be inspected by means of a proper asymptotic analysis, as follows.

The behaviour as $t \rightarrow 0^+$ can be determined from the behaviour of the Laplace transform $\widetilde{M}(s) = s^{-1} - s^{-2} + O(s^{-3+\alpha})$, as $\text{Re}\{s\} \rightarrow +\infty$. We obtain

$$M(t) = 1 - t + O(t^{2-\alpha}), \quad \text{as } t \rightarrow 0^+. \tag{2.25}$$

The spectral representation (2.23-24) is suitable to obtain the asymptotic behaviour of $M(t)$ as $t \rightarrow +\infty$, by using the Watson lemma. In fact, expanding the spectrum $K(r)$ for small r and taking the dominant term in the corresponding asymptotic series, we obtain

$$M(t) \sim a \frac{t^{-\alpha}}{\Gamma(1-\alpha)} = a \frac{\sin(\alpha\pi)}{\pi} \int_0^\infty e^{-rt} r^{\alpha-1} dr, \quad \text{as } t \rightarrow \infty. \tag{2.26}$$

Furthermore, we recognize that $1 > M(t) > e^{-t} > 0$, $0 < t < \infty$, namely, the decreasing plot of $M(t)$ remains above that of the exponential, as t runs from 0 to ∞ . Although both the two functions tend monotonically to 0, the difference between the two plots increases with t : at the initial point $t = 0$, both the curves assume the unitary value and decrease with the same initial rate, but as $t \rightarrow \infty$ they exhibit very different decays, algebraic (slow) against exponential (fast).

For the ordinary Basset problem it is convenient to report the result obtained by the factorisation method [67-68]. In this case we must note that $a = \sqrt{\beta}$, see (2.17), ranges from 0 to 3 since from (2.12) we recognize that β runs from 0 ($\chi = \infty$, infinitely heavy particle) to 9 ($\chi = 0$, infinitely light particle).

The actual solution is obtained expanding $\widetilde{M}(s)$ into partial fractions and then inverting. Considering the two roots λ_{\pm} of the polynomial $P(z) \equiv z^2 + az + 1$, with $z = s^{1/2}$ we must treat separately the following two cases

$$i) \ 0 < a < 2, \quad \text{or} \quad 2 < a < 3, \quad \text{and} \quad ii) \ a = 2,$$

which correspond to two distinct roots ($\lambda_+ \neq \lambda_-$), or two coincident roots ($\lambda_+ \equiv \lambda_- = -1$), respectively. We obtain

$$i) \ a \neq 2 \iff \beta \neq 4, \ \chi \neq 5/8,$$

$$\widetilde{M}(s) = \frac{1 + a s^{-1/2}}{s + a s^{1/2} + 1} = \frac{A_-}{s^{1/2} (s^{1/2} - \lambda_+)} + \frac{A_+}{s^{1/2} (s^{1/2} - \lambda_-)}, \quad (2.27)$$

with

$$\lambda_{\pm} = \frac{-a \pm (a^2 - 4)^{1/2}}{2} = \frac{1}{\lambda_{\mp}}, \quad A_{\pm} = \pm \frac{\lambda_{\pm}}{\lambda_+ - \lambda_-}; \quad (2.28)$$

$$ii) \ a = 2 \iff \beta = 4, \ \chi = 5/8,$$

$$\widetilde{M}(s) = \frac{1 + 2 s^{-1/2}}{s + 2 s^{1/2} + 1} = \frac{1}{(s^{1/2} + 1)^2} + \frac{2}{s^{1/2} (s^{1/2} + 1)^2}. \quad (2.29)$$

The Laplace inversion of (2.27 - 29) can be expressed in terms of Mittag-Leffler functions of order 1/2, $E_{1/2}(\lambda\sqrt{t}) = \exp(\lambda^2 t) \operatorname{erfc}(-\lambda\sqrt{t})$, as shown in the Appendix of [8]. We obtain

$$M(t) = \begin{cases} i) \ A_- E_{1/2}(\lambda_+ \sqrt{t}) + A_+ E_{1/2}(\lambda_- \sqrt{t}), \\ ii) \ (1 - 2t) E_{1/2}(-\sqrt{t}) + 2 \sqrt{t/\pi}. \end{cases} \quad (2.30)$$

We recall that the analytical solution to the classical Basset problem was formerly provided by Boggio [55] in 1907 with a different (cumbersome) method. One can show that our solution (2.30), derived by the tools of the Laplace transform and fractional calculus, coincides with Boggio's solution. Also Boggio arrived at the analysis of the two roots λ_{\pm} but his expression of the solution in the case of two conjugate complex roots ($\chi > 5/8$) given as a sum of Fresnel integrals could induce one to forecast unphysical oscillations, in the absence of numerical tables or plots. This disturbed Basset who, when he summarised the state of art about his problem in a later paper of 1910 [56], thought there was some physical deficiency in his own theory. With our integral representation of the solution, see (2.23-24), we can prove the monotone character of the solution, even if the arguments of the exponential and error functions are complex.

In order to have some insight about the effects of the two parameters α and a on the (generalized) Basset problem we exhibit some (normalized) plots for the particle velocity $V(t)$, corresponding to the solution of Eq. (2.17), assuming for simplicity a vanishing initial velocity ($V_0 = 0$).

We consider 3 cases for α , namely $\alpha = 1/2$ (the ordinary Basset problem) and $\alpha = 1/4, 3/4$ (the generalized Basset problem), corresponding to Figs 2-1, 2-2, 2-3, respectively. For each α we consider four values of a corresponding to $\chi := \rho_p/\rho_f = 0.5, 2, 10, 100$. For each couple $\{\alpha, \chi\}$ we compare the Basset solution (in continuous line) with its asymptotic expression (in dashed-dotted line) for large times and the Stokes solution (dashed line). We remind that the Stokes solution is the solution of Eq. (2.17) with $a = 0$ and hence is independent of α .

From these figures we can recognize the retarding effect of the (generalized) Basset force, which is more relevant for lighter particles, in reaching the final value of the velocity. This effect is of course due to the algebraic decay of the function $M(t)$, see (2.26), which is much slower than the exponential decay of the Stokes solution.

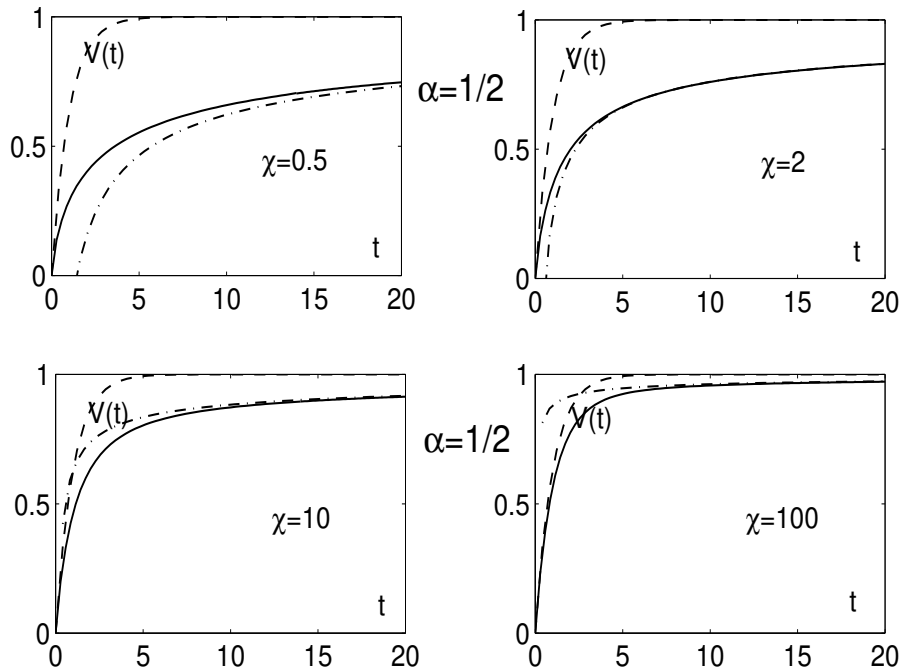

Fig. 2-1

The normalized velocity $V(t)$ for $\alpha = 1/2$ and $\chi = 0.5, 2, 10, 100$:
 Basset exact — ; Basset asymptotic - · - · - ; Stokes - - - .

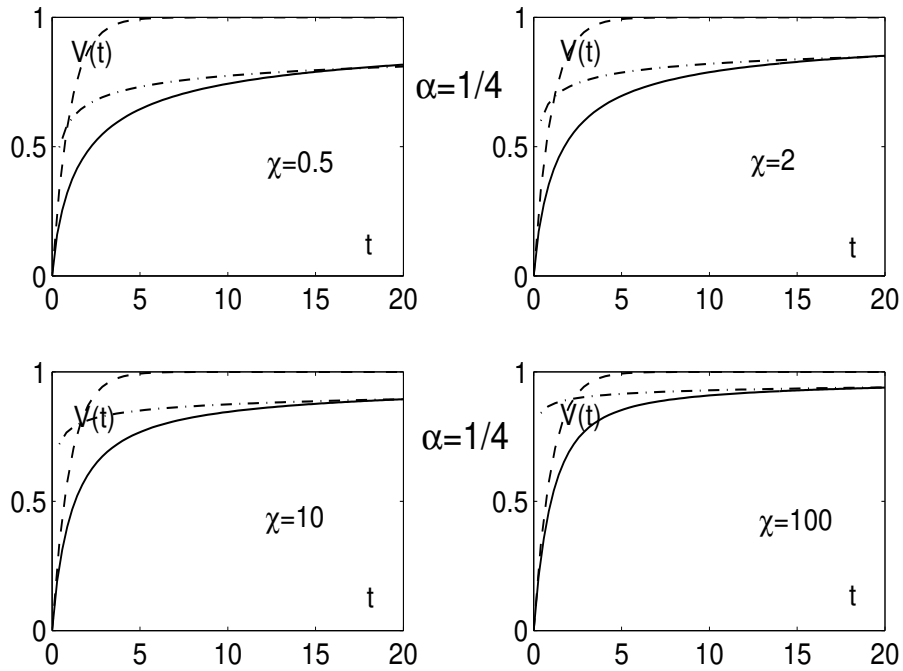

Fig. 2-2

The normalized velocity $V(t)$ for $\alpha = 1/4$ and $\chi = 0.5, 2, 10, 100$:
 Basset exact — ; Basset asymptotic - · - · - ; Stokes - - - .

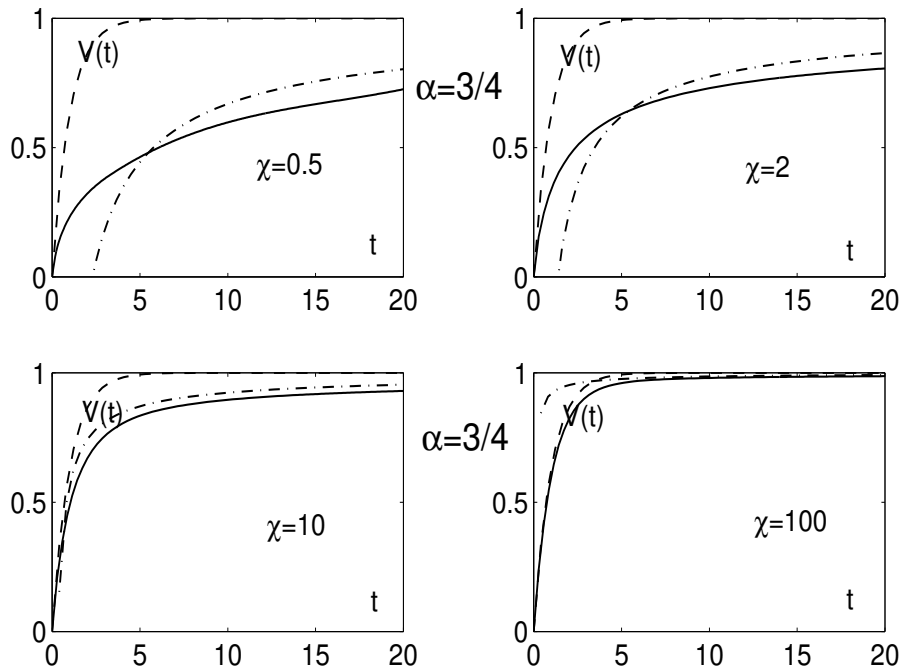

Fig. 2.3

The normalized velocity $V(t)$ for $\alpha = 3/4$ and $\chi = 0.5, 2, 10, 100$:
 Basset exact — ; Basset asymptotic - · - · - ; Stokes - - - .

3. BROWNIAN MOTION AND FRACTIONAL CALCULUS

3.1 Introduction

According to the classical approach started by Langevin normal diffusion and Brownian motion are associated with the Langevin equation. More specifically, the classical Langevin equation addresses the dynamics of a Brownian particle through Newton's law by incorporating the effect of the Stokes fluid friction and that of thermal fluctuations in the vicinity of the particle into a random force, see *e.g.* Wax [70], Fox and Uhlenbeck [71], Fox [72], Kubo *et al* [73].

Since the pioneering computer experiments by Alder and Wainwright [74] in 1970, which have shown that the velocity autocorrelation function for a Brownian particle in a dense fluid goes asymptotically as $t^{-3/2}$ instead of exponentially as predicted by stochastic theory, many attempts have been made to reproduce this result by purely theoretical arguments, see *e.g.* [75-97]; in most cases hydrodynamic models are adopted.

Recently, a great interest on the subject matter has been raised because of the possible connection among *long-time correlation* effects, *fractional Brownian motion* and *anomalous diffusion*, see *e.g.* [98-102]. We recall that *anomalous diffusion* is the phenomenon, usually met in disordered or fractal media, according to which the *displacement variance* is no longer linear in time but proportional to a power α of time with $0 < \alpha < 1$ (*slow diffusion*) or $1 < \alpha < 2$ (*fast diffusion*), see Bouchaud and Georges [99] for a review.

We also point out that, in view of the linear-response theory, Kubo in 1966 [103] stated a *fluctuation-dissipation theorem* * by introducing a *generalized Langevin equation (GLE)*, with an indefinite memory function as an integral kernel. In other words, this theorem may be represented by a stochastic equation describing the fluctuation, which is a generalization of the classical Langevin equation; in the *GLE* the friction force becomes retarded or frequency dependent and the random force is no longer a white noise. As a matter of fact, the hydrodynamic models introduced in the literature appear as particular cases of Kubo's *GLE*.

Here, after resuming in §3.2 the classical results derived from the ordinary Langevin equation, in §3.3 we shall revisit a hydrodynamic model which takes into account, in addition to the Stokes viscous drag, the inertial effect due to the added mass and the retarding effect due to the Basset memory force. So doing, we obtain a stochastic differential equation which contains a time derivative of order 1/2. This *GLE* will be referred to as the *fractional Langevin equation*.

* For a critical analysis of Kubo's fluctuation-dissipation theorem see Felderhof [104]

The present approach is based on a recent analysis carried out by the author and collaborators [105-106], in order to model the Brownian motion more realistically than in the classical approach (based on the Langevin equation).

Using Kubo's *fluctuation-dissipation theorem* and the techniques of *fractional calculus*, we shall provide the analytical expressions of the autocorrelation functions (both for the random force and the particle velocity) and of the displacement variance. Consequently, the well-known results of the classical theory of the Brownian motion will be properly generalized.

In the final section, §3.4, we shall present and discuss some numerical results implied by our analysis.

3.2 *The Classical Approach to the Brownian Motion*

We assume that the Brownian particle of mass m_p executes a random motion in one dimension with velocity $V = V(t)$ and displacement $X = X(t)$. The classical approach to the Brownian motion is based on the following stochastic differential equation (*Langevin equation*)

$$m_p \frac{dV}{dt} = F(t) + R(t), \quad (3.1)$$

where $F(t)$ denotes the *frictional force* exerted from the fluid on the particle and $R(t)$ denotes the *random force* arising from rapid thermal fluctuations, subjected to the condition $\langle R(t) \rangle = 0$. As usual, we have denoted with brackets the average taken over an ensemble in thermal equilibrium. Therefore the total force has been divided into a mean force F and a fluctuating force R . The fact that $F(t)$ is independent of the fluid variables is due to the boundary condition that the fluid velocity be equal to the particle velocity, $V(t)$, at the surface of the particle.

Assuming for the mean force the familiar Stokes approximation for a drag of spherical particle of radius r_0 , we obtain the classical formula

$$F = -\frac{1}{\mu} V(t), \quad \frac{1}{\mu} = 6\pi r_0 \rho_f \nu, \quad (3.2)$$

where μ denotes the *mobility coefficient* and ρ_f and ν are the density and the kinematic viscosity of the fluid, respectively. In this approximation the time derivative of the fluid velocity field has been neglected. If we introduce the friction characteristic time $\sigma_p := \mu m_p$, the Langevin equation (3.1) explicitly reads

$$\frac{dV}{dt} = -\frac{1}{\sigma_p} V(t) + \frac{1}{m_p} R(t). \quad (3.3)$$

The stochastic processes $V(t)$ and $R(t)$ are assumed to be *Gaussian-Markovian* and *stationary*. The stationarity implies that the *autocorrelation functions* C_V and C_R depend only on the time shift, namely

$$C_V(t_1, t) := \langle V(t_1) V(t_1 + t) \rangle = C_V(t), \quad (3.4)$$

$$C_R(t_1, t) := \langle R(t_1) R(t_1 + t) \rangle = C_R(t), \quad (3.5)$$

for any t_1 and t . Hereafter we assume $t_1 = 0$ and $t \geq 0$.

Following the classical approach to the Brownian motion, we require that the variance of the velocity at $t = 0$, $C_V(0) = \langle V^2(0) \rangle$, satisfies the *equipartition law for the energy distribution*, *i.e.*

$$m_p \langle V^2(0) \rangle = kT \iff \sigma_p \langle V^2(0) \rangle = \mu kT, \quad (3.6)$$

where k is the Boltzmann constant, as if the Brownian particle were kept for a sufficiently long time in the fluid at (absolute) temperature T , and that the random force is uncorrelated to the particle velocity at $t = 0$, *i.e.*

$$\langle V(0) R(t) \rangle = 0, \quad t \geq 0. \quad (3.7)$$

As well known, the previous assumptions lead to the relevant results,

$$C_V(t) = \langle V^2(0) \rangle e^{-t/\sigma_p}, \quad t \geq 0, \quad (3.8)$$

$$C_R(t) = \frac{m_p^2}{\sigma_p} \langle V^2(0) \rangle \delta(t), \quad t \geq 0, \quad (3.9)$$

where $\delta(t)$ denotes the Dirac distribution. The result (3.8) shows that the velocity autocorrelation function decays exponentially with characteristic time σ_p , whereas (3.9) means that $R(t)$ is a *white noise*.

It can be readily shown that the mean squared displacement of the Brownian particle (starting at the origin at $t_0 = 0$), *i.e.* the *displacement variance*, is given by

$$\langle X^2(t) \rangle = 2 \int_0^t (t - \tau) C_V(\tau) d\tau = 2 \int_0^t d\tau_1 \int_0^{\tau_1} C_V(\tau) d\tau, \quad t \geq 0. \quad (3.10)$$

For this it is sufficient to recall that $X(t) = \int_0^t V(t') dt'$, and to use the definition (3.4) of $C_V(t)$ for $t \geq t_0 = 0$. As a consequence of (3.8) and (3.10) we obtain

$$\langle X^2(t) \rangle = 2 \sigma_p \langle V^2(0) \rangle \left[t - \sigma_p \left(1 - e^{-t/\sigma_p} \right) \right], \quad t \geq 0, \quad (3.11)$$

from which we recognize that for sufficiently large times the variance increases linearly with time.

It is usual to introduce the *diffusion coefficient* as

$$\mathcal{D} := \lim_{t \rightarrow \infty} \frac{\langle X^2(t) \rangle}{2t}. \quad (3.12)$$

Then from (3.11-12) we obtain the chain of equalities

$$\mathcal{D} = \sigma_p \langle V^2(0) \rangle = \int_0^\infty C_V(t) dt, \quad (3.13)$$

and, using (3.7),

$$\mathcal{D} = \mu k T. \quad (3.14)$$

The identity (3.14) is known as *Einstein relation*. In particular, we point out the asymptotic behaviour of the variance for large times,

$$\langle X^2(t) \rangle = 2\mathcal{D}t \left[1 - (t/\sigma_p)^{-1} + EST \right], \quad \text{as } t \rightarrow \infty, \quad (3.15)$$

where *EST* denote exponentially small terms.

3.3 The Hydrodynamic Approach to the Brownian Motion

On the basis of hydrodynamics, the Langevin equation (3.3) is not completely correct, since it ignores the effects of the added mass and Basset history force, which are due to the acceleration of the particle. This was formerly pointed out in the early seventies by a number of authors, just after the cited computer experiments by Alder and Wainwright [74].

The added mass effect requires to substitute the mass of the particle with the so-called effective mass, m_e introduced in (2.10). As a consequence, in order to keep unmodified the mobility coefficient in the Stokes drag, we have to introduce a new friction characteristic time, σ_e , such that

$$\mu := \frac{\sigma_p}{m_p} = \frac{\sigma_e}{m_e} \iff \sigma_e := \sigma \left(1 + \frac{1}{2\chi} \right), \quad \text{with } \chi := \frac{\rho_p}{\rho_f}. \quad (3.16)$$

The corresponding Langevin equation is obtained from (3.3) by replacing m_p with m_e and σ_p with σ_e . With respect to the classical analysis, it turns out that the added mass effect, if it were present alone, would be only to lengthen the time scale ($\sigma_e > \sigma_p$) in the exponentials entering the basic formulas (3.8) and (3.11) and to decrease the velocity variance $\langle V^2(0) \rangle$, consistently with the energy equipartition law at the same temperature,

$$m_e \langle V^2(0) \rangle = k T \iff \sigma_e \langle V^2(0) \rangle = \mu k T. \quad (3.17)$$

Consequently, the diffusion coefficient turns out to be not altered by the added mass effect and the Einstein relation still holds.

In view of Kubo's *fluctuation-dissipation theorem*, an arbitrary retarding effect in the friction force (in particular that due to the Basset force) can be taken into account by introducing a suitable memory function $\gamma(t)$ in the Langevin equation. The consequent *GLE* reads (in our notation)

$$\frac{dV}{dt} = - \int_{0^-}^{t^+} \gamma(t - \tau) V(\tau) d\tau + \frac{1}{m_e} R(t), \quad t \geq 0, \quad (3.18)$$

where, as usual, the limits of integration are extended to account for the possibility of Dirac-type distributions. The *fluctuation-dissipation theorem* can be readily expressed by the Laplace transforms, see *e.g.* Mainardi and Pironi [105]. In our notation this theorem leads to

$$\tilde{C}_V(s) := \langle V(0) \widetilde{V}(t) \rangle = \frac{\langle V^2(0) \rangle}{s + \tilde{\gamma}(s)}, \quad (3.19)$$

and

$$\tilde{C}_R(s) := \langle R(0) \widetilde{R}(t) \rangle = m_e^2 \langle V^2(0) \rangle \tilde{\gamma}(s). \quad (3.20)$$

The classical results are easily recovered for $t \geq 0$ by noting that, in the absence of added mass and retarding effects, we get $\tilde{\gamma}(s) = 1/\sigma_p \div \gamma(t) = \delta(t)/\sigma_p$.

Taking into account both the added mass and the Basset history force (whose expression has been given in the previous section in terms of a fractional derivative) the Langevin equation (3.3) turns out to be modified into

$$\frac{dV}{dt} = -\frac{1}{\sigma_e} \left[1 + \sqrt{\tau_0} \frac{d^{1/2}}{dt^{1/2}} \right] V(t) + \frac{1}{m_e} R(t), \quad \tau_0 := \frac{r_0^2}{\nu}. \quad (3.21)$$

Here the fractional derivative is intended in the Caputo sense with starting point $t_0 = 0$, *i.e.*

$$\frac{d^{1/2}}{dt^{1/2}} V(t) = \frac{1}{\sqrt{\pi}} \int_0^t \frac{dV/d\tau}{\sqrt{t - \tau}} d\tau. \quad (3.22)$$

We agree to refer to (3.21) as the *fractional Langevin equation*.

We easily recognize that our fractional Langevin equation (3.21) can be considered a particular case of the *GLE* (3.18) by noting that

$$\tilde{\gamma}(s) = \frac{1}{\sigma_e} \left[1 + \sqrt{\tau_0} s^{1/2} \right] \div \gamma(t) = \frac{1}{\sigma_e} \left[\delta(t) - \sqrt{\tau_0} \frac{1}{2\sqrt{\pi}} t^{-3/2} \Theta(t) \right], \quad (3.23)$$

where $\Theta(t)$ is the Heaviside step function. Therefore the expression for $\gamma(t)$ turns out to be defined only in the sense of distributions. Specifically, $\delta(t)$ is the well-known Dirac delta function and $t^{-3/2} \Theta(t)$ is the linear functional over test functions, $\phi(t)$, such that

$$\langle t^{-3/2} \Theta(t), \phi(t) \rangle = \int_0^\infty \frac{[\phi(t) - \phi(0)]}{t^{3/2}} dt.$$

For more details on distributions, see *e.g.* [107] or [108].

The significant change with respect to the classical case results from the $t^{-3/2}$ term. Not only does it imply a non-instantaneous relationship between the force and the velocity, but also it is a slowly decreasing function so that the force is effectively related to the velocity over a large time interval. The representation of the force in terms of distributions, as required by the *GLE*, is not strictly necessary since we can use the equivalent fractional form.

Let us consider the autocorrelation for the random force. The inversion of the Laplace transform $\tilde{C}_R(s)$ yields, by (3.22-23),

$$C_R(t) = \frac{m_e^2}{\sigma_e} \langle V^2(0) \rangle \left[\delta(t) - \sqrt{\tau_0} \frac{1}{2\sqrt{\pi}} t^{-3/2} \right], \quad t \geq 0, \quad (3.24)$$

to be compared with the classical result (3.9). Thus, we recognize that, in the presence of the Basset history force, the random force can no longer be represented uniquely by a white noise; an additional "fractional" or "coloured" noise is present due to the term $t^{-3/2}$ which, as already noted, is to be interpreted in the sense of distributions. Since the fluctuating force is no longer uncorrelated at different times, the fractional Langevin equation does *not* represent a Markovian process. Nevertheless, it is still Gaussian (since the Gaussian nature of the driving sources for the fluid is assumed), and stationary (in view of the time-shift invariance). since

Let us now consider the autocorrelation for the velocity field. Inserting (3.23) in (3.21), it turns out as

$$\tilde{C}_V(s) = \frac{\langle V^2(0) \rangle}{s + [1 + \sqrt{\tau_0} s^{1/2}] / \sigma_e} = \frac{\langle V^2(0) \rangle}{s + \sqrt{\beta/\sigma_e} s^{1/2} + 1/\sigma_e}, \quad (3.25)$$

where $\beta := \tau_0/\sigma_e$, see (2.12-13). We first note that the effect of the Basset force is expected to be negligible for $\beta \rightarrow 0$ ($\chi := \rho_p/\rho_f \rightarrow \infty$), *i.e.* for particles which are sufficiently heavy with respect to the fluid. In this case we can assume also $\sigma_e \approx \sigma_p$ so the classical results (3.8), (3.9) and (3.11) turn out to be true.

A first result concerning the asymptotic behaviour of $C_V(t)$ as $t \rightarrow \infty$ can be easily obtained from (3.25) by applying the asymptotic theorem for the Laplace transform as $s \rightarrow 0$, see *e.g.* Doetsch [109]. In fact, from

$$\tilde{C}_V(s) \sim \sigma_e \langle V^2(0) \rangle (1 - \sqrt{\beta\sigma_e} s^{1/2}), \quad s \rightarrow 0,$$

we get

$$C_V(t) \sim \langle V^2(0) \rangle \sqrt{\beta/(4\pi)} (t/\sigma_e)^{-3/2}, \quad t \rightarrow \infty. \quad (3.26)$$

The presence of such a long-time tail is thus in agreement with that formerly observed in computer simulations by Alder and Wainwright [74].

The explicit inversion of the Laplace transform in (3.25) can be carried out in a way similar to that used in the (deterministic) ordinary Basset problem treated in the previous Section, see (2.27-30). For this purpose we need to consider the function

$$\tilde{N}(s) = \frac{1}{s + a s^{1/2} + 1}, \quad a = \sqrt{\beta}, \tag{3.27}$$

and recognize that

$$\frac{C_V(t)}{\langle V^2(0) \rangle} = N(t/\sigma_e) \div \sigma_e \tilde{N}(\sigma_e s) = \frac{1}{s + \sqrt{\beta/\sigma_e} s^{1/2} + 1/\sigma_e}. \tag{3.28}$$

Thus, the actual solution is obtained by expanding $\tilde{N}(s)$ into partial fractions and then inverting.

We first obtain

$$\tilde{N}(s) = \frac{1}{s + a s^{1/2} + 1} = \begin{cases} i) \frac{A_+}{s^{1/2}(s^{1/2} - \lambda_+)} + \frac{A_-}{s^{1/2}(s^{1/2} - \lambda_-)}, \\ ii) \frac{1}{(s^{1/2} + 1)^2}, \end{cases} \tag{3.29}$$

where λ_{\pm} and A_{\pm} are given by (2.28), and the distinction of cases *i*) and *ii*) is the same as there.

Then, the Laplace inversion of (3.29) can be expressed in terms of Mittag-Leffler functions of order 1/2, $E_{1/2}(\lambda\sqrt{t}) = \exp(\lambda^2 t) \operatorname{erfc}(-\lambda\sqrt{t})$, as shown in the Appendix of [8]. We obtain, using (3.28),

$$\frac{C_V(t)}{\langle V^2(0) \rangle} = \begin{cases} i) A_+ E_{1/2}(\lambda_+ \sqrt{t/\sigma_e}) + A_- E_{1/2}(\lambda_- \sqrt{t/\sigma_e}), \\ ii) (1 + 2t/\sigma_e) E_{1/2}(-\sqrt{t/\sigma_e}) - (2/\sqrt{\pi}) \sqrt{t/\sigma_e}. \end{cases} \tag{3.30}$$

Furthermore, it can be shown that $N(t)$ is a *completely monotone* function for $t > 0$, decreasing from 1 to 0, as t runs from 0 to ∞ .

Let us now consider the displacement variance, which is provided by the repeated integral of the velocity autocorrelation as indicated in (3.10). From the Laplace transform $\langle X^2(s) \rangle = 2\tilde{C}_V(s)/s^2$, we first derive the asymptotic behaviour of $\langle X^2(t) \rangle$ as $t \rightarrow \infty$. We easily obtain

$$\langle X^2(t) \rangle = 2Dt \left\{ 1 - 2\sqrt{\beta/\pi} (t/\sigma_e)^{-1/2} + O[(t/\sigma_e)^{-1}] \right\}, \quad t \rightarrow \infty, \tag{3.31}$$

where D is the diffusion coefficient defined in (3.12-14).

The explicit expression of the displacement variance can be obtained by expanding $\tilde{N}(s)/s^2$ into partial fractions and then inverting. In the case $i) \beta \neq 4$, we obtain

$$\langle X^2(t) \rangle = 2D \left\{ t - 2 \sqrt{\frac{\beta \sigma_e t}{\pi}} + \sigma_e \frac{\lambda_+^3 [1 - E_{1/2}(\lambda_- \sqrt{t/\sigma_e})] - \lambda_-^3 [1 - E_{1/2}(\lambda_+ \sqrt{t/\sigma_e})]}{(\lambda_+ - \lambda_-)} \right\}. \quad (3.32)$$

Thus, the displacement variance is proved to maintain, for sufficiently long times, the linear behaviour which is typical of normal diffusion (with the same diffusion coefficient as in the classical case). However, the Basset history force, which is responsible of the algebraic decay of the velocity correlation function, induces a retarding effect in the establishing of the linear behaviour of the displacement variance. As we shall see hereafter, this retarding effect is more evident when the Brownian particle is lighter, such as to give rise to regimes of effective *fast anomalous diffusion* characterized by the law

$$\langle X^2(t) \rangle \sim 2 D_a t^\alpha, \quad D_a = a D (\sigma_p)^{1-\alpha}; \quad 0 < a < 1, \quad 1 < \alpha < 2. \quad (3.33)$$

3.4 Numerical Results and Discussion

In order to get a physical insight of the effect of the Basset history force (coupled with the added mass) on the classical Brownian motion, we exhibit the results obtained recently by Mainardi and Tampieri [106] concerning plots of the velocity autocorrelation (3.30) and the displacement variance (3.32). As an example we consider relatively light Brownian particles, by assuming $\chi = 0.1$ and $\chi = 0.5$. We take non-dimensional quantities, by scaling the time with the decay constant σ_p of the classical Brownian motion and the displacement with the diffusive scale $(D \sigma_p)^{1/2}$. Please note that here we have preferred to scale the time with σ_p more than with σ_e , since in the classical approach the added mass effect is neglected! With these scales the asymptotic equation for the displacement variance reads $\langle X^2(t) \rangle \sim 2t$.

In Figs 3-1 and 3-2 we plot versus the normalized time the velocity autocorrelation normalized with its initial value $\langle V^2(0) \rangle$ and the displacement variance normalized with its asymptotic value $2t$. We compare any function, provided by our full hydrodynamic approach (added mass and Basset force), in continuous line, with the corresponding one, provided by the classical analysis, in dashed line, and by the only effect of the added mass, in dashed-dotted line. For large times we also exhibit the asymptotic estimations (3.26) and (3.31), in dotted line, in order to recognize their range of validity.

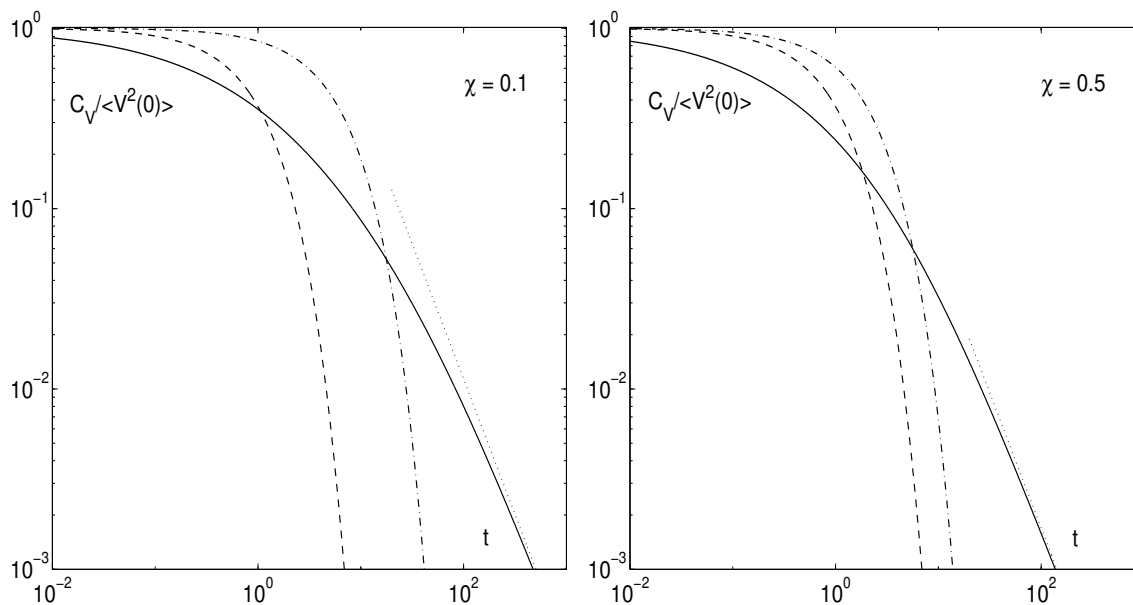

Fig. 3-1

Velocity autocorrelation versus time for $\chi = 0.1$ (left) and for $\chi = 0.5$ (right): full hydrodynamic — ; added mass - · - · - ; classical - - - .

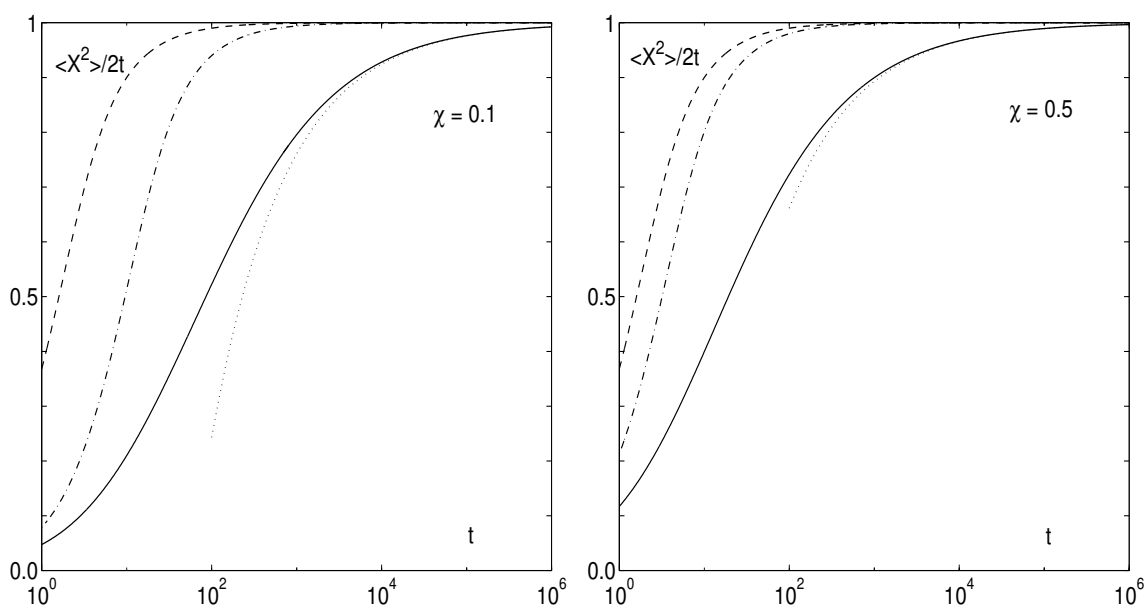

Fig. 3-2

Displacement variance versus time for $\chi = 0.1$ (left) and for $\chi = 0.5$ (right): full hydrodynamic — ; added mass - · - · - ; classical - - - .

The retarding effect of the Basset force is more evident when the Brownian particle is lighter, such as to appear a manifestation of fast anomalous diffusion. In fact, if we consider a time interval (say two decades) starting when the classical analysis foresees the establishment of the asymptotic linear behaviour for the displacement variance, a law of anomalous diffusion $\langle X^2(t) \rangle \sim 2 a t^\alpha$, $a > 0$, $\alpha \neq 1$, can well approximate the exact formula (3.32), provided by the full hydrodynamic model. By evaluating the parameters of the anomalous diffusion, a and α , with a best fit based on the least squared method, we find $0 < a < 1$ and $1 < \alpha < 2$. We recognize that the effective *anomalous diffusion* turns out to be *fast*; in particular, it is faster as χ is smaller, with parameters $a \rightarrow 0^+$ and $\alpha \rightarrow 2^-$ as $\chi \rightarrow 0^+$. Of course, the normal diffusion is recovered as $\chi \rightarrow \infty$, since $a \rightarrow 1^-$ and $\alpha \rightarrow 1^+$. In Fig. 3-4 we show the function $\langle X^2 \rangle / 2$ versus time (in the 2-decade range $10^1 \div 10^3$) corresponding either to our analysis and to the classical analysis. While the classical curve, in dashed line above, is practically coincident with the linear one (regime of normal diffusion) our curve, in continuous line below, is fitted with a power-law curve, in dashed-dotted line, with an exponent $\alpha > 1$ (regime of fast anomalous diffusion).

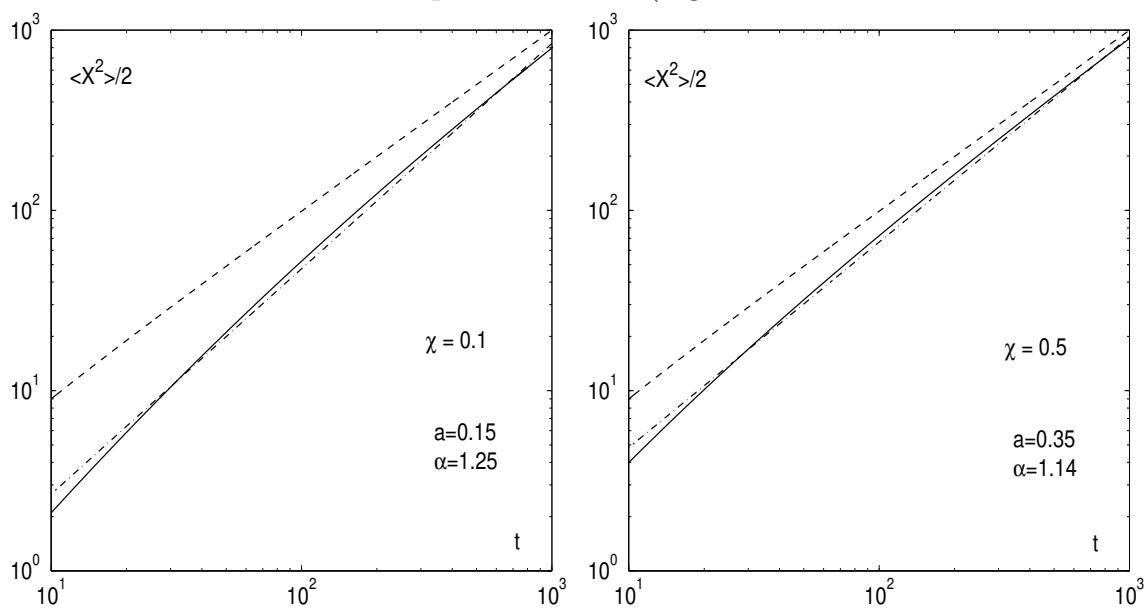

Fig. 3-3

The displacement variance at large times for $\chi = 0.1, 0.5$:
 full hydrodynamic — ; best-fit - · - · - ; classical - - - .

From the above analysis we conclude that if an observer investigates the time evolution of a cloud of sufficiently light Brownian particles, he recognises that the normal diffusion is preceded by a regime of fast anomalous diffusion, which lasts for long time. If the observation interval is not sufficiently long, he may be induced to trust in the occurring of fast anomalous diffusion.

4. THE FRACTIONAL DIFFUSION-WAVE EQUATION

4.1 Introduction

By *fractional diffusion-wave* equation we mean the linear integro partial differential equation obtained from the classical diffusion or wave equation by replacing the first- or second-order time derivative by a fractional derivative (in the Caputo sense) of order β with $0 < \beta \leq 2$. In our notation it reads

$$\frac{\partial^\beta u}{\partial t^\beta} = \mathcal{D} \frac{\partial^2 u}{\partial x^2}, \quad u = u(x, t), \quad 0 < \beta \leq 2, \quad \mathcal{D} > 0, \quad (4.1)$$

where \mathcal{D} denotes a positive constant with the dimensions $L^2 T^{-\beta}$, x and t are the space-time variables, and $u = u(x, t)$ is the field variable, which is assumed to be a *causal* function of time, *i.e.* vanishing for $t < 0$. From the Chapter of Gorenflo and Mainardi [8], see in §1.3 Eq. (1.17), we remind the definition of the Caputo fractional derivative of order $\beta > 0$ for a (sufficiently well-behaved) *causal* function $f(t)$,

$$D_*^\beta f(t) := J^{m-\beta} D^m f(t) = \begin{cases} \frac{1}{\Gamma(m-\beta)} \int_0^t \frac{f^{(m)}(\tau)}{(t-\tau)^{\beta+1-m}} d\tau, & m-1 < \beta < m, \\ \frac{d^m}{dt^m} f(t), & \beta = m. \end{cases}$$

Introducing the causal power function

$$\Phi_\lambda(t) := \frac{t_+^{\lambda-1}}{\Gamma(\lambda)}, \quad \lambda > 0,$$

where the suffix $+$ is just denoting that the function is vanishing for $t < 0$, and recalling the Laplace transform pair $\Phi_\lambda(t) \div s^{-\lambda}$, we easily recognize that

$$D_*^\beta f(t) := \Phi_{m-\beta}(t) * f^{(m)}(t) \div s^\beta \tilde{f}(s) - \sum_{k=0}^{m-1} s^{\beta-1-k} f^{(k)}(0^+), \quad m-1 < \beta \leq m.$$

We note $\Phi_\lambda(t) * \Phi_\mu(t) = \Phi_{\lambda+\mu}(t)$. In Eq. (4.1) we thus need to distinguish two cases *i)* $0 < \beta \leq 1$, and *ii)* $1 < \beta \leq 2$, for which the equation assumes the explicit forms as follows :

$$\Phi_{1-\beta}(t) * \frac{\partial u}{\partial t} = \frac{1}{\Gamma(1-\beta)} \int_0^t (t-\tau)^{-\beta} \left(\frac{\partial u}{\partial \tau} \right) d\tau = \mathcal{D} \frac{\partial^2 u}{\partial x^2}, \quad 0 < \beta \leq 1; \quad (4.2)$$

$$\Phi_{2-\beta}(t) * \frac{\partial^2 u}{\partial t^2} = \frac{1}{\Gamma(2-\beta)} \int_0^t (t-\tau)^{1-\beta} \left(\frac{\partial^2 u}{\partial \tau^2} \right) d\tau = \mathcal{D} \frac{\partial^2 u}{\partial x^2}, \quad 1 < \beta \leq 2. \quad (4.3)$$

The equations (4.2) and (4.3) can be properly referred to as the *time-fractional diffusion* and the *time-fractional wave* equation, respectively.

A *fractional diffusion* equation akin to (4.2) has been explicitly introduced in physics by Nigmatullin [110] to describe diffusion in special types of porous media, which exhibit a fractal geometry. The author [111] has shown that the *fractional wave* equation governs the propagation of mechanical diffusive waves in viscoelastic media which exhibit a simple power-law creep. This problem of dynamic viscoelasticity, formerly treated by Pipkin [5] but unaware of the interpretation by fractional calculus, thus provides an interesting example of the relevance of (4.3) in physics. Of course, anytime some hereditary mechanisms of power-law type are present in diffusion or wave phenomena, the appearance of time fractional derivatives in the evolution equations is expected.

In a series of papers [112-116] the author has pursued his analysis on the fractional diffusion-wave equation (4.1), based on Laplace transforms and special functions of Wright type. Mathematical aspects of integro differential equations akin to (4.2-3) and based on the use of integral transforms and special functions have been treated in some relevant papers by Wyss [117], Schneider and Wyss [118], Schneider [119] (Mellin transforms and Fox H functions) and by Fujita [120] (Fourier transforms and Mittag-Leffler functions). More formal approaches based on semigroup theory in Banach spaces have been given by Kochubei [121-122] and El-Sayed [123]. Recently the integro-differential equation treated by Fujita has been considered by Engler [124] in a very interesting paper in view of the connection between similarity solutions and stable probability distributions.

Hereafter we present a review on the fractional evolution equation (4.1), essentially based on our works [111-116]. In §4.2 we analyse the two basic boundary-value problems, referred to as the *Cauchy problem* and the *Signalling problem*, by the technique of the Laplace transform and we derive the transform expressions of the respective fundamental solutions (the *Green functions*).

In §4.3 we carry out the inversion of the relevant Laplace transforms and we outline a reciprocity relation between the Green functions themselves in the space-time domain. In view of this relation the Green functions can be expressed in terms of two interrelated *auxiliary functions* in the similarity variable $r = |x|/(\sqrt{D}t^{\beta/2})$. These auxiliary functions can be analytically continued in the whole complex plane as entire functions of *Wright* type.

In §4.4 we show the evolution of the fundamental solutions of both the Cauchy and Signalling problems for some (rational) values of the order of time derivation. To gain more insight into the phenomenon of fractional diffusion we also exhibit the evolution of an initial box function in the Cauchy problem. This allows us to better recognize the processes of slow diffusion ($0 < \beta < 1$) and the intermediate processes between diffusion and wave propagation ($1 < \beta < 2$).

Finally, in the Appendix, we provide the reader with a review of the main mathematical properties of our auxiliary functions in the framework of the Wright functions. The interesting connection with the stable probability distributions is not treated but deferred to recent works of ours, there quoted.

4.2 Analysis of the Cauchy and Signalling Problems with the Laplace Transform

As well known, the two basic boundary-value problems for the evolution equations of diffusion and wave type are the *Cauchy* and *Signalling problems*. In the *Cauchy problem*, which concerns the space-time domain $-\infty < x < +\infty, t \geq 0$, the data are assigned at $t = 0^+$ on the whole space axis (initial data). In the *Signalling problem*, which concerns the space-time domain $x \geq 0, t \geq 0$, the data are assigned both at $t = 0^+$ on the semi-infinite space axis $x > 0$ (initial data) and at $x = 0^+$ on the semi-infinite time axis $t > 0$ (boundary data); here, as mostly usual, the initial data are assumed to be vanishing. Extending the classical analysis to our fractional equation (4.1), and denoting by $f(x)$ and $h(t)$ two given, sufficiently well-behaved functions, the basic problems are thus formulated as following:

a) *Cauchy problem*

$$u(x, 0^+) = f(x), \quad -\infty < x < +\infty; \quad u(\mp\infty, t) = 0, \quad t > 0; \quad (4.4a)$$

b) *Signalling problem*

$$u(x, 0^+) = 0, \quad x > 0; \quad u(0^+, t) = h(t), \quad u(+\infty, t) = 0, \quad t > 0. \quad (4.4b)$$

If $1 < \beta \leq 2$, we would add in (4.4a) and (4.4b) the initial value of the first-order time derivative of the field variable, *i.e.* $\frac{\partial}{\partial t}u(x, 0^+) = g(x)$, since in this case Eq. (4.1) turns out to be of the second order in time, see the integro-differential equation (4.3), and, consequently, two linearly independent solutions are to be determined. We limit ourselves to choose $g(x) \equiv 0$. We easily recognize that the above Cauchy problem for (4.1) can be expressed through the integral equations of fractional order

$$u(x, t) = \begin{cases} f(x) + \frac{\mathcal{D}}{\Gamma(\beta)} \int_0^t \left[\frac{\partial^2 u}{\partial x^2}(x, \tau) \right] (t - \tau)^{\beta-1} d\tau, & 0 < \beta \leq 1, \\ f(x) + t g(x) + \frac{\mathcal{D}}{\Gamma(\beta)} \int_0^t \left[\frac{\partial^2 u}{\partial x^2}(x, \tau) \right] (t - \tau)^{\beta-1} d\tau, & 1 < \beta \leq 2. \end{cases} \quad (4.5)$$

We thus note that for $1 < \beta \leq 2$ the choice $g(x) = 0$ ensures the continuous dependence of the solution on the parameter β also in the transition from $\beta = 1^-$ to $\beta = 1^+$.

In view of our analysis we find it convenient to put

$$\nu = \frac{\beta}{2}, \quad 0 < \nu < 1. \quad (4.6)$$

For the *Cauchy* and *Signalling* problems we introduce the so-called Green functions $\mathcal{G}_c(x, t; \nu)$ and $\mathcal{G}_s(x, t; \nu)$, which represent the respective fundamental solutions, obtained when $g(x) = \delta(x)$ and $h(t) = \delta(t)$. As a consequence, the solutions of the two basic problems are obtained by a space or time convolution according to

$$u(x, t; \nu) = \int_{-\infty}^{+\infty} \mathcal{G}_c(x - \xi, t; \nu) f(\xi) d\xi, \quad (4.7a)$$

$$u(x, t; \nu) = \int_{0^-}^{t^+} \mathcal{G}_s(x, t - \tau; \nu) h(\tau) d\tau. \quad (4.7b)$$

It should be noted that $\mathcal{G}_c(x, t; \nu) = \mathcal{G}_c(|x|, t; \nu)$ since the Green function turns out to be an even function of x .

For the *standard diffusion* equation ($\nu = 1/2$) it is well known that

$$\mathcal{G}_c(x, t; 1/2) := \mathcal{G}_c^d(x, t) = \frac{1}{2\sqrt{\pi\mathcal{D}}} t^{-1/2} e^{-x^2/(4\mathcal{D}t)}, \quad (4.8a)$$

$$\mathcal{G}_s(x, t; 1/2) := \mathcal{G}_s^d(x, t) = \frac{x}{2\sqrt{\pi\mathcal{D}}} t^{-3/2} e^{-x^2/(4\mathcal{D}t)}. \quad (4.8b)$$

For the *standard wave* equation ($\nu = 1$) it is well known that, putting $c = \sqrt{\mathcal{D}}$,

$$\mathcal{G}_c(x, t; 1) := \mathcal{G}_c^w(x, t) = \frac{1}{2} [\delta(x - ct) + \delta(x + ct)], \quad (4.9a)$$

$$\mathcal{G}_s(x, t; 1) := \mathcal{G}_s^w(x, t) = \delta(t - x/c). \quad (4.9b)$$

In the general case $0 < \nu \leq 1$ the two Green functions will be determined by using the technique of the Laplace transform. This technique allows us to obtain the transformed functions $\widetilde{\mathcal{G}}_c(x, s; \nu)$, $\widetilde{\mathcal{G}}_s(x, s; \nu)$, by solving ordinary differential equations of the 2-nd order in x and then, by inversion, $\mathcal{G}_c(x, t; \nu)$ and $\mathcal{G}_s(x, t; \nu)$.

For the *Cauchy Problem* (4.4a) the application of the Laplace transform to (4.1) with $u(x, t) = \mathcal{G}_c(x, t; \nu)$, and $\mathcal{G}_c(x, 0^+; \nu) = f(x) = \delta(x)$, [and $\frac{\partial}{\partial t} \mathcal{G}_c(x, 0^+; \nu) = 0$ if $1/2 < \nu \leq 1$] leads to the non-homogeneous differential equation satisfied by the image of the Green function, $\widetilde{\mathcal{G}}_c(x, s; \nu)$,

$$\mathcal{D} \frac{d^2 \widetilde{\mathcal{G}}_c}{dx^2} - s^{2\nu} \widetilde{\mathcal{G}}_c = -\delta(x) s^{2\nu-1}, \quad -\infty < x < +\infty. \quad (4.10)$$

Because of the singular term $\delta(x)$ we have to consider the above equation separately in the two intervals $x < 0$ and $x > 0$, imposing the boundary conditions at $x = \mp\infty$, $\mathcal{G}_c(\mp\infty, t; \nu) = 0$, and the necessary matching conditions at $x = 0^\pm$.

We obtain

$$\widetilde{\mathcal{G}}_c(x, s; \nu) = \frac{1}{2\sqrt{\mathcal{D}}} s^{1-\nu} e^{-(|x|/\sqrt{\mathcal{D}})s^\nu}, \quad -\infty < x < +\infty. \quad (4.11)$$

In fact, from (4.10) $\widetilde{\mathcal{G}}_c$ is expected in the form

$$\widetilde{\mathcal{G}}_c(x, s; \nu) = \begin{cases} c_1(s) e^{-(x/\sqrt{\mathcal{D}})s^\nu} + c_2(s) e^{+(x/\sqrt{\mathcal{D}})s^\nu}, & \text{if } x > 0; \\ c_3(s) e^{-(x/\sqrt{\mathcal{D}})s^\nu} + c_4(s) e^{+(x/\sqrt{\mathcal{D}})s^\nu}, & \text{if } x < 0. \end{cases} \quad (4.12)$$

Clearly, we must set $c_2(s) = c_3(s) = 0$, in order to ensure that the solution vanishes as $|x| \rightarrow \infty$. We recognize from (4.10) that in $x = 0$ the function $\widetilde{\mathcal{G}}_c(x, s; \nu)$ is continuous but not its first derivative: we write

$$\widetilde{\mathcal{G}}_c(0^+, s; \nu) - \widetilde{\mathcal{G}}_c(0^-, s; \nu) = c_1(s) - c_4(s) = 0, \quad (4.13)$$

and, by integrating (4.10) with respect to x from $x = 0^-$ to $x = 0^+$,

$$\frac{d}{dx} \widetilde{\mathcal{G}}_c(0^+, s; \nu) - \frac{d}{dx} \widetilde{\mathcal{G}}_c(0^-, s; \nu) = -[c_1(s) + c_4(s)] \frac{s^\nu}{\sqrt{\mathcal{D}}} = -\frac{s^{2\nu-1}}{\mathcal{D}}. \quad (4.14)$$

Therefore, using (4.13-14) we obtain $c_1(s) = c_4(s) = 1/(2\sqrt{\mathcal{D}}s^{1-\nu})$, and consequently the expression (4.11).

For the *Signalling Problem* (4.4b) the application of the Laplace transform to (4.1) with $u(x, t) = \mathcal{G}_s(x, t; \nu)$, $\mathcal{G}_s(x, 0^+; \nu) = 0$, [and $\frac{\partial}{\partial t} \mathcal{G}_s(x, 0^+; \nu) = 0$ if $1/2 < \nu \leq 1$], leads to the homogeneous differential equation

$$\mathcal{D} \frac{d^2 \widetilde{\mathcal{G}}_s}{dx^2} - s^{2\nu} \widetilde{\mathcal{G}}_s = 0, \quad x \geq 0. \quad (4.15)$$

Imposing the boundary conditions at $x = 0$, $\mathcal{G}_s(0^+, t; \nu) = h(t) = \delta(t)$, and at $x = +\infty$, $\mathcal{G}_s(+\infty, t; \nu) = 0$, we obtain

$$\widetilde{\mathcal{G}}_s(x, s; \nu) = e^{-(x/\sqrt{\mathcal{D}})s^\nu}, \quad x \geq 0. \quad (4.16)$$

In fact, from (4.15) $\widetilde{\mathcal{G}}_s$ is expected in the form

$$\widetilde{\mathcal{G}}_s(x, s; \nu) = c_1(s) e^{-(x/\sqrt{\mathcal{D}})s^\nu} + c_2(s) e^{+(x/\sqrt{\mathcal{D}})s^\nu}, \quad x \geq 0. \quad (4.17)$$

Clearly, we must set $c_2(s) = 0$ to ensure that the solution vanishes as $x \rightarrow +\infty$, and consequently we obtain $c_1(s) = \widetilde{\mathcal{G}}_s(0, s; \nu) = \widetilde{\delta}(s) = 1$.

4.3 The Reciprocity Relation and the Auxiliary Functions

From (4.11) and (4.16) we recognize

$$\frac{d}{ds} \widetilde{\mathcal{G}}_s = -2\nu x \widetilde{\mathcal{G}}_c, \quad x > 0, \quad (4.18)$$

which implies for the original Green functions the following *reciprocity relation*

$$2\nu x \mathcal{G}_c(x, t; \nu) = t \mathcal{G}_s(x, t; \nu), \quad x > 0, \quad t > 0. \quad (4.19)$$

The above relation can be easily verified in the case of standard diffusion ($\nu = 1/2$) where the explicit expressions (4.8) of the Green functions leads to the identity (for $x > 0, t > 0$)

$$x \mathcal{G}_c^d(x, t) = t \mathcal{G}_s^d(x, t) = \frac{1}{2\sqrt{\pi}} \frac{x}{\sqrt{\mathcal{D}t}} e^{-x^2/(4\mathcal{D}t)} = F^d(r) = \frac{r}{2} M^d(r), \quad (4.20)$$

where

$$r = x/(\sqrt{\mathcal{D}t}^{1/2}) > 0, \quad (4.21)$$

is the well-known *similarity variable* and

$$M^d(r) = \frac{1}{\sqrt{\pi}} e^{-r^2/4}. \quad (4.22)$$

We can refer to $F^d(r)$ and $M^d(r)$ as to the *auxiliary functions* for the diffusion equation because each of them provides the fundamental solutions through (4.20). We note that $M^d(r)$ satisfies the normalization condition $\int_0^\infty M^d(r) dr = 1$.

Now we are going to show how, in the general case $0 < \nu < 1$, the inversion of the Laplace transform in (4.11) or (4.16) leads us to generalize the auxiliary functions $F^d(r)$ and $M^d(r)$ by introducing the proper *similarity variable* for $x > 0, t > 0$,

$$r = x/(\sqrt{\mathcal{D}t}^\nu) > 0. \quad (4.23)$$

The new *auxiliary functions*, that we denote by $F(r; \nu)$ and $M(r; \nu)$, turn out to be expressed in terms of Bromwich complex integrals as shown hereafter.

Applying in the reciprocity relation (4.19) the complex inversion formulas for the transformed Green functions (4.11) and (4.16), we obtain

$$2\nu x \mathcal{G}_c(x, t; \nu) = \frac{2\nu x}{2\sqrt{\mathcal{D}}} \frac{1}{2\pi i} \int_{Br} e^{st - (x/\sqrt{\mathcal{D}}) s^\nu} \frac{ds}{s^{1-\nu}}, \quad x > 0, \quad t > 0, \quad (4.24)$$

and

$$t \mathcal{G}_s(x, t; \nu) = t \frac{1}{2\pi i} \int_{Br} e^{st - (x/\sqrt{D}) s^\nu} ds, \quad x > 0, \quad t > 0, \quad (4.25)$$

where Br denotes the Bromwich path.

In order to express the Bromwich integrals in terms of the single *similarity variable* r defined by (4.23) let us change the integration variable in (4.24-25) setting $\sigma = st$. From (4.24) we obtain

$$2\nu x \mathcal{G}_c(x, t; \nu) = \nu r M(r; \nu), \quad (4.26)$$

with

$$M(r; \nu) := \frac{1}{2\pi i} \int_{Br} e^{\sigma - r\sigma^\nu} \frac{d\sigma}{\sigma^{1-\nu}}, \quad r > 0, \quad 0 < \nu < 1, \quad (4.27)$$

and, from (4.25),

$$t \mathcal{G}_s(x, t; \nu) = F(r; \nu), \quad (4.28)$$

with

$$F(r; \nu) := \frac{1}{2\pi i} \int_{Br} e^{\sigma - r\sigma^\nu} d\sigma, \quad r > 0, \quad 0 < \nu < 1. \quad (4.29)$$

Therefore we conclude that, for $x > 0, t > 0, r > 0$,

$$2\nu x \mathcal{G}_c(x, t; \nu) = t \mathcal{G}_s(x, t; \nu) = F(r; \nu) = \nu r M(r; \nu). \quad (4.30)$$

The above definitions of $F(r; \nu)$ and $M(r; \nu)$ by the Bromwich representation can be analytically continued from $r > 0$ to any $z \in \mathbb{C}$, by adopting suitable integral and series representations valid in all of \mathbb{C} .

For this purpose, let us deform the Bromwich path Br into the Hankel path Ha [a contour consisting of pieces of the two rays $\arg \sigma = \pm\phi$ extending to infinity, and of the circular arc $\sigma = \epsilon e^{i\theta}$, $|\theta| \leq \phi$, with $\phi \in (\pi/2, \pi)$] which is chosen to be equivalent to the original path (at least) for z real and positive. The Hankel integral representation allows us to obtain the series representation for each auxiliary function. In fact, after expanding in series of positive powers of z the exponential function, $\exp(-z \sigma^\nu)$, exchanging the order between the series and the integral and using the Hankel representation of the reciprocal of the Gamma function,

$$\frac{1}{\Gamma(\zeta)} = \frac{1}{2\pi i} \int_{Ha} e^\sigma \sigma^{-\zeta} d\sigma, \quad \zeta \in \mathbb{C},$$

we finally obtain the required power series representation. Since the radius of convergence of the power series can be proven to be infinite for $0 < \nu < 1$, our auxiliary functions turn out to be entire in z and therefore the exchange between the series and the integral is legitimate.

The integral and series representations of $F(z; \nu)$ and $M(z; \nu)$, valid on all of \mathbb{C} , with $0 < \nu < 1$ turn out to be

$$F(z; \nu) = \begin{cases} \frac{1}{2\pi i} \int_{Ha} e^{\sigma - z\sigma^\nu} d\sigma \\ \sum_{n=1}^{\infty} \frac{(-z)^n}{n! \Gamma(-\nu n)} \end{cases} \quad z \in \mathbb{C}, \quad 0 < \nu < 1, \quad (4.31)$$

and

$$M(z; \nu) = \begin{cases} \frac{1}{2\pi i} \int_{Ha} e^{\sigma - z\sigma^\nu} \frac{d\sigma}{\sigma^{1-\nu}} \\ \sum_{n=0}^{\infty} \frac{(-z)^n}{n! \Gamma[-\nu n + (1 - \nu)]} \end{cases} \quad z \in \mathbb{C}, \quad 0 < \nu < 1. \quad (4.32)$$

In Appendix we show that the two auxiliary functions turn out to be particular examples of a *special entire function* known as *Wright function*. We refer the reader to the Appendix for the main properties of the auxiliary functions including the related Laplace transform pairs.

4.4 Plots

In the following figures we exhibit the plots of the Green functions for both the Cauchy and Signalling problems, in the cases $\beta = 1/2, 1, 3/2$, ($\beta = 2\nu$) taking $\mathcal{D} = 1$.

The plots of $\mathcal{G}_c(x, t)$ versus x at fixed times ($t = 1, 2, 3$) for $\beta = 1/2, 1, 3/2$ are reported in Figs 4-1, 4-2, 4-3, respectively. The plots of $\mathcal{G}_s(x, t)$ versus t at fixed positions ($x = 0.9, 1, 1.1$) for $\beta = 1/2, 1, 3/2$ are reported in Figs 4-4, 4-5, 4-6, respectively.

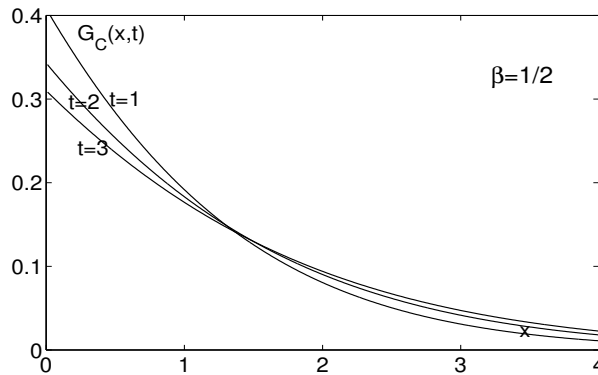

Fig. 4-1

The Green function $\mathcal{G}_c(x, t)$ for $\beta = 1/2$ versus x at fixed times. (*Cauchy problem*)

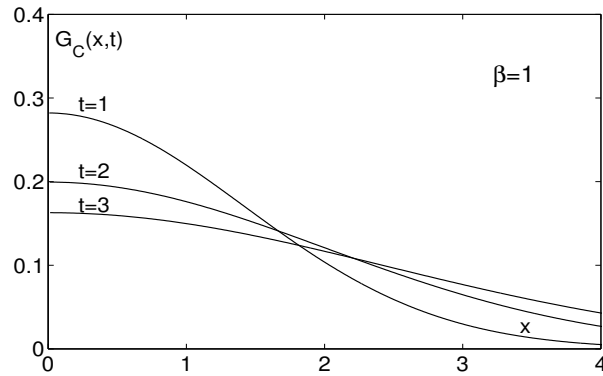

Fig. 4-2.

The Green function $\mathcal{G}_c(x, t)$ for $\beta = 1$ versus x at fixed times. (*Cauchy problem*)

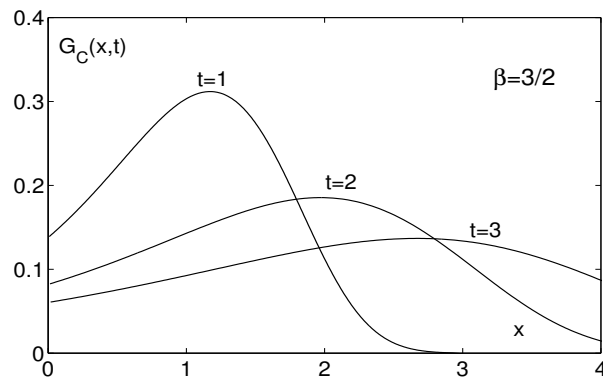

Fig. 4-3.

The Green function $\mathcal{G}_c(x, t)$ for $\beta = 3/2$ versus x at fixed times. (*Cauchy problem*)

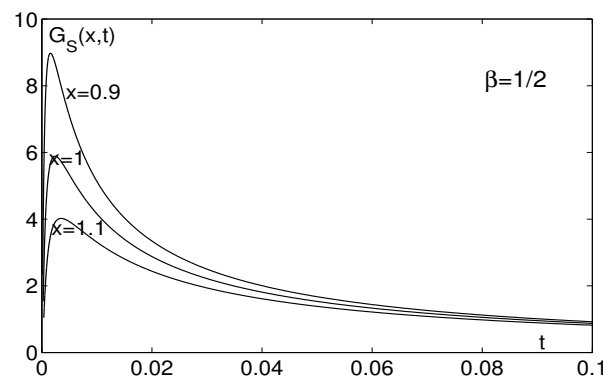

Fig. 4-4

The Green function $\mathcal{G}_s(x, t)$ for $\beta = 1/2$ versus t at fixed positions. (*Signalling problem*)

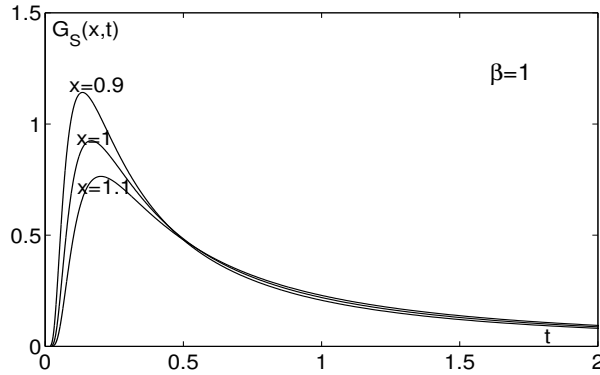

Fig. 4-5

The Green function $\mathcal{G}_s(x, t)$ for $\beta = 1$ versus t at fixed positions. (*Signalling problem*)

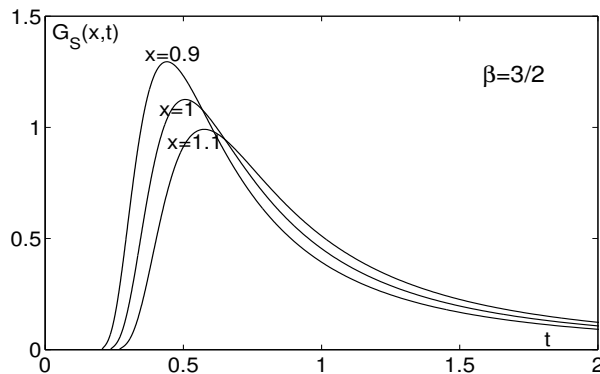

Fig. 4-6

The Green function $\mathcal{G}_s(x, t)$ for $\beta = 3/2$ versus t at fixed positions. (*Signalling problem*)

In order to gain more insight into the phenomena governed by the fractional diffusion wave equation (4.1), we consider a simple Cauchy problem where the initial data are provided by a box-type function. Precisely, taking $\mathcal{D} = 1$, we consider

$$u(x, 0^+) = \Theta(1 - |x|) \implies u(x, t) = \int_{-1}^{+1} \mathcal{G}_c(x - \xi, t; \nu) d\xi. \quad (4.33)$$

In the following we exhibit plots of the solution versus x ($0 \leq x \leq 3$), at fixed t ($t = 0, 0.5, 1$), for some fractional values of $\beta = 2\nu$. In Fig. 4-7 we compare the cases concerning the fractional diffusion equation ($0 < \beta \leq 1$), whereas in Fig. 4-8 we compare those concerning the fractional wave equation ($1 < \beta \leq 2$).

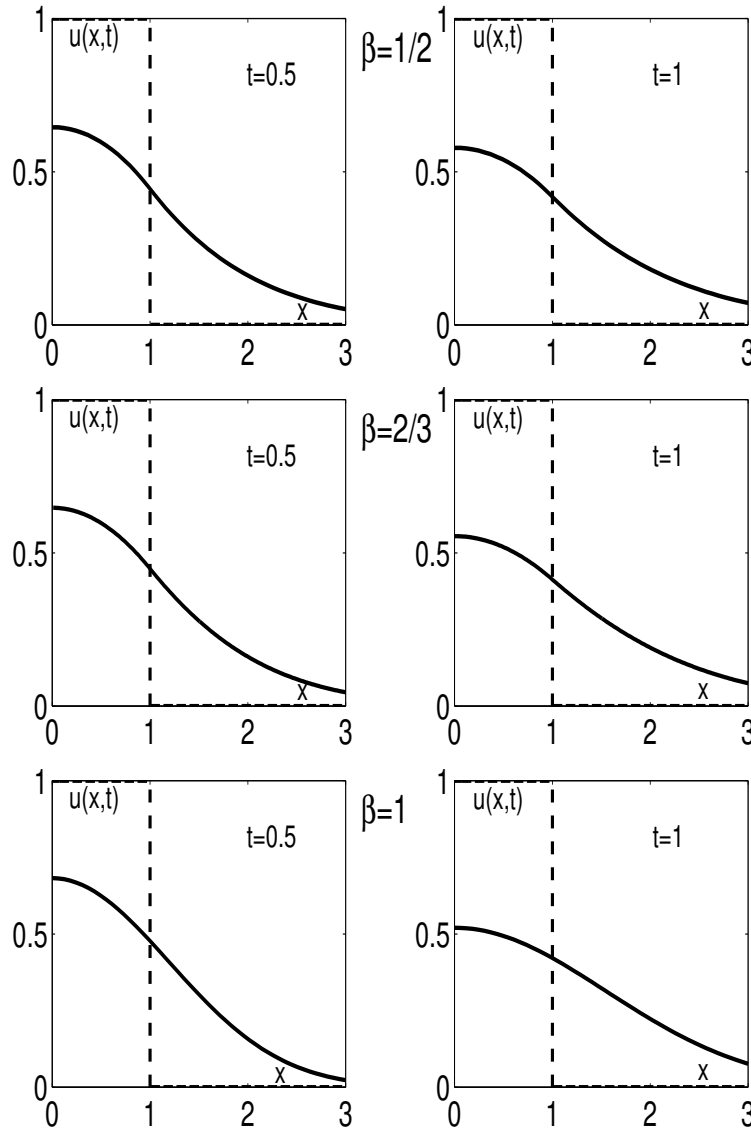
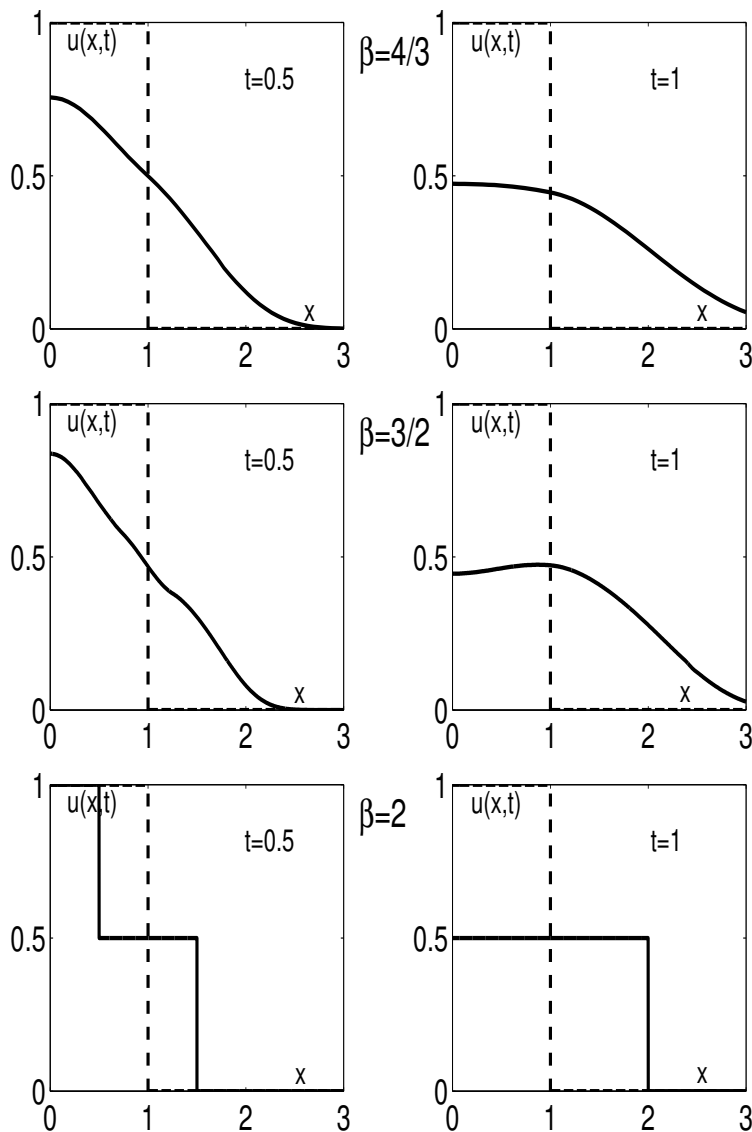

Fig. 4-7

Evolution of the initial box-signal (dashed line) at $t = 0.5$ (left) and $t = 1$ (right), versus x , for various values of $\beta : 1/2, 2/3, 1$.

In Fig. 4-7 we thus obtain some comparison between the fractional diffusion and the standard diffusion. We easily recognize for $0 < \beta < 1$ a diffusive behaviour, which is slower with respect to the case $\beta = 1$ of standard diffusion: this is consistent with a *slow diffusion process*.

**Fig. 4-8**

Evolution of the initial box-signal (dashed line) at $t = 0.5$ (left) and $t = 1$ (right), versus x , for various values of β : $4/3$, $3/2$, 2 .

In Fig. 4-8 we recognize the *intermediate process* between standard diffusion (where discontinuities are smoothed out) and wave propagation (where discontinuities can propagate with finite speed). This can be seen from the appearance of a hump, which tends to be narrower as $\beta \rightarrow 2^-$ up to reproduce the discontinuities of the signal for $\beta = 2$. For $1 < \beta < 2$ the hump travels with finite velocity (as in a wave process) but the signal diffuses instantaneously (as in a diffusion process).

APPENDIX: THE WRIGHT FUNCTION

In this Appendix we shall consider the general class of the *Wright* functions with special regard to the special functions that we have introduced for the sake of convenience in the treatment of the fractional diffusion wave equation, the so-called *auxiliary* functions. It is our purpose to provide a review of the main properties of these functions including their series and integral representations and the related Laplace transform pairs. We also mention their connection with the *Mittag-Leffler* functions, for which we refer the reader to Gorenflo and Mainardi [8].

A.1 The representations for the Wright function $W_{\lambda,\mu}(z)$

The Wright function, that we denote as $W_{\lambda,\mu}(z)$, where $\lambda > -1$ and $\mu > 0$, is so named from the British mathematician E. Maitland Wright who in 1933 introduced it in the asymptotic theory of partitions. A list of formulas concerning this function can be found in the handbook of the Bateman Project [125]. We note that originally Wright considered $\lambda \geq 0$ [126] and only later, in 1940, he extended to $-1 < \lambda < 0$ [127]. Relevant investigations on this functions have been carried out by Stankovic [128-129], by other authors quoted by Kiryakova [130], and more recently by Gorenflo, Luchko and Mainardi [142-143] and by Wong and Zhao [144-145].

The Wright function is defined by the *series representation*, valid in all of \mathbb{C} ,

$$W_{\lambda,\mu}(z) := \sum_{n=0}^{\infty} \frac{z^n}{n! \Gamma(\lambda n + \mu)}, \quad z \in \mathbb{C}, \quad \lambda > -1, \quad \mu > 0, \quad (A.1)$$

so that it turns out to be an *entire* function. This property remains valid even if μ is an arbitrary complex number. The *integral representation* reads

$$W_{\lambda,\mu}(z) = \frac{1}{2\pi i} \int_{Ha} e^{\sigma + z\sigma^{-\lambda}} \frac{d\sigma}{\sigma^{\mu}}, \quad z \in \mathbb{C}, \quad \lambda > -1, \quad \mu > 0, \quad (A.2)$$

where Ha denotes the Hankel path. The formal equivalence between the two representations is easily proved using the Hankel formula for the Gamma function

$$\frac{1}{\Gamma(\zeta)} = \int_{Ha} e^u u^{-\zeta} du, \quad \zeta \in \mathbb{C},$$

and performing a term-by-term integration. In fact,

$$\begin{aligned} W_{\lambda,\mu}(z) &= \frac{1}{2\pi i} \int_{Ha} e^{\sigma + z\sigma^{-\lambda}} \frac{d\sigma}{\sigma^{\mu}} = \frac{1}{2\pi i} \int_{Ha} e^{\sigma} \left[\sum_{n=0}^{\infty} \frac{z^n}{n!} \sigma^{-\lambda n} \right] \frac{d\sigma}{\sigma^{\mu}} \\ &= \sum_{n=0}^{\infty} \frac{z^n}{n!} \left[\frac{1}{2\pi i} \int_{Ha} e^{\sigma} \sigma^{-\lambda n - \mu} d\sigma \right] = \sum_{n=0}^{\infty} \frac{z^n}{n! \Gamma[\lambda n + \mu]}. \end{aligned}$$

It is possible to prove that the Wright function is entire of order $1/(1 + \lambda)$, hence of exponential type if $\lambda \geq 0$. The case $\lambda = 0$ is trivial since $W_{0,\mu}(z) = e^z/\Gamma(\mu)$.

Wright showed in particular that in the case $\lambda = -\nu \in (-1, 0)$ there is the following asymptotic expansion, valid in a suitable sector about the negative real axis

$$W_{-\nu,\mu}(z) = Y^{1/2-\mu} e^{-Y} \left(\sum_{m=0}^{M-1} A_m Y^{-m} + O(|Y|^{-M}) \right) \quad \text{as } z \rightarrow -\infty, \quad (A.3)$$

with $Y = Y(z) = (1 - \nu)(-\nu^\nu z)^{1/(1-\nu)}$, where the A_m are certain real numbers.

A.2 The Wright functions as generalization of the Bessel functions

For $\lambda = 1$ and $\mu = \nu + 1$ the Wright function turns out to be related to the well known Bessel functions J_ν and I_ν by the following identity

$$(z/2)^\nu W_{1,\nu+1}(\mp z^2/4) = \begin{cases} J_\nu(z) \\ I_\nu(z) \end{cases}. \quad (A.4)$$

In view of this property some authors refer to the Wright function as the *Wright generalized Bessel function* (misnamed also as the *Bessel-Maitland function*) and introduce the notation

$$J_\nu^{(\lambda)}(z) := \left(\frac{z}{2}\right)^\nu \sum_{n=0}^{\infty} \frac{(-1)^n (z/2)^{2n}}{n! \Gamma(\lambda n + \nu + 1)}; \quad J_\nu^{(1)}(z) := J_\nu(z). \quad (A.5)$$

As a matter of fact, the Wright function appears as the natural generalization of the entire function known as *Bessel - Clifford function*, see e.g. [130], and referred by Tricomi [131-132] as the *uniform Bessel function**,

$$T(z; \nu) := z^{-\nu/2} J_\nu(2\sqrt{z}) = \sum_{n=0}^{\infty} \frac{(-1)^n z^n}{n! \Gamma(n + \nu + 1)} = W_{1,\nu+1}(-z). \quad (A.6)$$

Some of the properties which the Wright functions share with the most popular Bessel functions were enumerated by Wright himself. Hereafter, we quote some relevant relations from the Bateman Project [125], which can easily be derived from (A.1):

$$\lambda z W_{\lambda,\lambda+\mu}(z) = W_{\lambda,\mu-1}(z) + (1 - \mu) W_{\lambda,\mu}(z), \quad (A.7)$$

$$\frac{d}{dz} W_{\lambda,\mu}(z) = W_{\lambda,\lambda+\mu}(z). \quad (A.8)$$

* The great Italian mathematician denoted this function by $E_\nu(z)$. Here we write $T(z; \nu)$ to remain in accordance with the standard notation used for the Mittag-Leffler function [8].

A.3 The Auxiliary Functions $F(z; \nu)$ and $M(z; \nu)$

In our treatment of the time fractional diffusion wave equation we have found it convenient to introduce two *auxiliary functions* $F(z; \nu)$ and $M(z; \nu)$, where z is a complex variable and ν a real parameter $0 < \nu < 1$. Both functions turn out to be analytic in the whole complex plane, *i.e.* they are entire functions. Their respective *integral representations* read, see (4.31-32),

$$F(z; \nu) := \frac{1}{2\pi i} \int_{Ha} e^{\sigma - z\sigma^\nu} d\sigma, \quad z \in \mathbb{C}, \quad 0 < \nu < 1, \tag{A.9}$$

$$M(z; \nu) := \frac{1}{2\pi i} \int_{Ha} e^{\sigma - z\sigma^\nu} \frac{d\sigma}{\sigma^{1-\nu}}, \quad z \in \mathbb{C}, \quad 0 < \nu < 1. \tag{A.10}$$

From a comparison of (A.9-10) with (A.2) we easily recognize that these functions are special cases of the Wright function according to

$$F(z; \nu) = W_{-\nu,0}(-z), \tag{A.11}$$

and

$$M(z; \nu) = W_{-\nu,1-\nu}(-z). \tag{A.12}$$

From (A.7) and (A.11-12) we find the relation

$$F(z; \nu) = \nu z M(z; \nu). \tag{A.13}$$

This relation can be obtained directly from (A.9-10) with an integration by parts, *i.e.*

$$\int_{Ha} e^{\sigma - z\sigma^\nu} \frac{d\sigma}{\sigma^{1-\nu}} = \int_{Ha} e^{\sigma} \left(-\frac{1}{\nu z} \frac{d}{d\sigma} e^{-z\sigma^\nu} \right) d\sigma = \frac{1}{\nu z} \int_{Ha} e^{\sigma - z\sigma^\nu} d\sigma.$$

The *series representations* for our auxiliary functions turn out to be respectively, see (4.31-32),

$$F(z; \nu) := \sum_{n=1}^{\infty} \frac{(-z)^n}{n! \Gamma(-\nu n)} = -\frac{1}{\pi} \sum_{n=1}^{\infty} \frac{(-z)^n}{n!} \Gamma(\nu n + 1) \sin(\pi \nu n), \tag{A.14}$$

and

$$M(z; \nu) := \sum_{n=0}^{\infty} \frac{(-z)^n}{n! \Gamma[-\nu n + (1 - \nu)]} = \frac{1}{\pi} \sum_{n=1}^{\infty} \frac{(-z)^{n-1}}{(n-1)!} \Gamma(\nu n) \sin(\pi \nu n). \tag{A.15}$$

The series at the R.H.S. have been obtained by using the well-known reflection formula for the Gamma function $\Gamma(\zeta) \Gamma(1 - \zeta) = \pi / \sin \pi \zeta$. Furthermore we note that $F(0; \nu) = 0$, $M(0, \nu) = 1/\Gamma(1 - \nu)$ and that the relation (A.13) can be derived also from (A.14-15).

Explicit expressions of $F(z; \nu)$ and $M(z; \nu)$ in terms of known functions are expected for some particular values of ν . Mainardi & Tomirotti [114] have shown that for $\nu = 1/q$, where $q \geq 2$ is a positive integer, the auxiliary functions can be expressed as a sum of $(q - 1)$ simpler entire functions. In the particular cases $q = 2$ and $q = 3$ we find

$$M(z; 1/2) = \frac{1}{\sqrt{\pi}} \sum_{m=0}^{\infty} (-1)^m \left(\frac{1}{2}\right)_m \frac{z^{2m}}{(2m)!} = \frac{1}{\sqrt{\pi}} \exp(-z^2/4), \quad (\text{A.16})$$

and

$$\begin{aligned} M(z; 1/3) &= \frac{1}{\Gamma(2/3)} \sum_{m=0}^{\infty} \left(\frac{1}{3}\right)_m \frac{z^{3m}}{(3m)!} - \frac{1}{\Gamma(1/3)} \sum_{m=0}^{\infty} \left(\frac{2}{3}\right)_m \frac{z^{3m+1}}{(3m+1)!} \\ &= 3^{2/3} \text{Ai}\left(z/3^{1/3}\right), \end{aligned} \quad (\text{A.17})$$

where Ai denotes the *Airy function*.

Furthermore it can be proved [114] that $M(z; 1/q)$ satisfies the differential equation of order $q - 1$

$$\frac{d^{q-1}}{dz^{q-1}} M(z; 1/q) + \frac{(-1)^q}{q} z M(z; 1/q) = 0, \quad (\text{A.18})$$

subjected to the $q - 1$ initial conditions at $z = 0$, derived from (A.15),

$$M^{(h)}(0; 1/q) = \frac{(-1)^h}{\pi} \Gamma[(h + 1)/q] \sin[\pi(h + 1)/q], \quad h = 0, 1, \dots, q - 2. \quad (\text{A.19})$$

We note that, for $q \geq 4$, Eq. (A.18) is akin to the *hyper-Airy* differential equation of order $q - 1$, see *e.g.* [133]. Consequently, in view of the above considerations, the auxiliary function $M(z; \nu)$ can be referred to as the *generalized hyper-Airy function*.

Let us now consider the problem of the asymptotic evaluation of the function $M(z; \nu)$ as $|z| \rightarrow \infty$ in the complex plane. Referring to a preliminary report of ours [134] for the detailed asymptotic analysis in the whole complex plane, which includes the phenomenon of Stokes lines, here we limit ourselves to provide the asymptotic representation as $z = r$ is real and positive by using the ordinary saddle-point method. Choosing as a variable r/ν rather than r the computation is easier and yields, see [114],

$$M(r/\nu; \nu) \sim a(\nu) r^{(\nu - 1/2)/(1 - \nu)} \exp\left[-b(\nu) r^{1/(1 - \nu)}\right], \quad r \rightarrow +\infty, \quad (\text{A.20})$$

where

$$a(\nu) = \frac{1}{\sqrt{2\pi(1 - \nu)}} > 0, \quad b(\nu) = \frac{1 - \nu}{\nu} > 0. \quad (\text{A.21})$$

The above evaluation is consistent with the first term in Wright's asymptotic expansion (A.3) after having used (A.12).

The exponential decay for $r \rightarrow +\infty$ ensures that $M(r; \nu)$ is absolutely integrable in \mathbb{R}^+ . We can easily prove the normalization property in \mathbb{R}^+

$$\int_0^{+\infty} M(r; \nu) dr = 1, \tag{A.22}$$

and more generally we can compute all the moments in \mathbb{R}^+

$$\int_0^{+\infty} r^n M(r; \nu) dr = \frac{\Gamma(n+1)}{\Gamma(\nu n+1)}, \quad n \in \mathbb{N}. \tag{A.23}$$

The results (A.22-23) can be formally derived by using the Laplace transform of $M(r; \nu)$, as shown later. Analogously we can compute all the moments in \mathbb{R}^+ for $F(r; \nu)$.

A.4 The Laplace transform pairs related to the Wright function

Let us consider the Laplace transform of the Wright function using the following notation

$$W_{\lambda, \mu}(\pm r) \div \mathcal{L} [W_{\lambda, \mu}(\pm r)] := \int_0^{\infty} e^{-s r} W_{\lambda, \mu}(\pm r) dr,$$

where r denotes a non negative real variable, *i.e.* $0 \leq r < +\infty$, and s is the Laplace complex parameter.

When $\lambda > 0$ the series representation of Wright function can be transformed term-by-term. In fact, for a known theorem of the theory of the Laplace transforms, see *e.g.* Doetsch [109], the Laplace transform of an entire function of exponential type can be obtained by transforming term-by-term the Taylor expansion of the original function around the origin. In this case the resulting Laplace transform turns out to be analytic and vanishing at infinity. As a consequence we obtain the Laplace transform pair

$$W_{\lambda, \mu}(\pm r) \div \frac{1}{s} E_{\lambda, \mu} \left(\pm \frac{1}{s} \right), \quad \lambda > 0, \quad |s| > \rho > 0, \tag{A.24}$$

where $E_{\lambda, \mu}$ denotes the generalized Mittag-Leffler function in two parameters, and ρ is an arbitrary positive number. The proof is straightforward noting that

$$\sum_{n=0}^{\infty} \frac{(\pm r)^n}{n! \Gamma(\lambda n + \mu)} \div \frac{1}{s} \sum_{n=0}^{\infty} \frac{(\pm 1/s)^n}{\Gamma(\lambda n + \mu)},$$

and recalling the series representation of the generalized Mittag-Leffler function,

$$E_{\alpha, \nu}(z) := \sum_{n=0}^{\infty} \frac{z^n}{\Gamma(\alpha n + \nu)}, \quad \alpha > 0, \quad \nu \in \mathbb{C}, \quad z \in \mathbb{C}.$$

For $\lambda \rightarrow 0^+$ (A.24) we obtain the Laplace transform pair

$$W_{0^+, \mu}(\pm r) = \frac{e^{\pm r}}{\Gamma(\mu)} \div \frac{1}{\Gamma(\mu)} \frac{1}{s \mp 1} = \frac{1}{s} E_{0, \mu} \left(\pm \frac{1}{s} \right), \quad |s| > 1, \quad (\text{A.25})$$

where, to remain in agreement with (A.24), we have formally put

$$E_{0, \mu}(z) := \sum_{n=0}^{\infty} \frac{z^n}{\Gamma(\mu)} := \frac{1}{\Gamma(\mu)} E_0(z) := \frac{1}{\Gamma(\mu)} \frac{1}{1-z}, \quad |z| < 1.$$

We recognize that in this special case the Laplace transform exhibits a simple pole at $s = \pm 1$ while for $\lambda > 0$ it exhibits an essential singularity at $s = 0$.

For $-1 < \lambda < 0$ the Wright function turns out to be an entire function of order greater than 1, so that care is required in establishing the existence of its Laplace transform, which necessarily must tend to zero as $s \rightarrow \infty$ in its half-plane of convergence. For the sake of convenience we limit ourselves to derive the Laplace transform for the special case of $M(r; \nu)$; the exponential decay as $r \rightarrow \infty$ of the *original* function provided by (A.20) ensures the existence of the *image* function. From the integral representation (A.10) we obtain

$$\begin{aligned} M(r; \nu) &\div \frac{1}{2\pi i} \int_0^{\infty} e^{-sr} \left[\int_{Ha} e^{\sigma - r\sigma^{\nu}} \frac{d\sigma}{\sigma^{1-\nu}} \right] dr \\ &= \frac{1}{2\pi i} \int_{Ha} e^{\sigma} \sigma^{\nu-1} \left[\int_0^{\infty} e^{-r(s + \sigma^{\nu})} dr \right] d\sigma = \frac{1}{2\pi i} \int_{Ha} \frac{e^{\sigma} \sigma^{\nu-1}}{\sigma^{\nu} + s} d\sigma. \end{aligned}$$

Then, by recalling the integral representation of the Mittag-Leffler function,

$$E_{\alpha}(z) = \frac{1}{2\pi i} \int_{Ha} \frac{\zeta^{\alpha-1} e^{\zeta}}{\zeta^{\alpha} - z} d\zeta, \quad \alpha > 0, \quad z \in \mathbb{C},$$

we obtain the Laplace transform pair

$$M(r; \nu) \div E_{\nu}(-s), \quad 0 < \nu < 1. \quad (\text{A.26})$$

In this case, transforming term-by-term the Taylor series of $M(r; \nu)$ yields a series of negative powers of s , which represents the asymptotic expansion of $E_{\nu}(-s)$ as $s \rightarrow \infty$ in a sector around the positive real axis. We note that (A.26) contains the well-known Laplace transform pair, see *e.g.* [109],

$$M(r; 1/2) := \frac{1}{\sqrt{\pi}} \exp(-r^2/4) \div E_{1/2}(-s) := \exp(s^2) \operatorname{erfc}(s), \quad s \in \mathbb{C}.$$

We also note that (A.26) allows us to derive (A.22-23) by accounting for the property

$$\int_0^{+\infty} r^n M(r; \nu) dr = \lim_{s \rightarrow 0} (-1)^n \frac{d^n}{ds^n} E_{\nu}(-s).$$

Analogously, because of (A.3), we can prove that in the case $\lambda = -\nu \in (-1, 0)$ we get

$$W_{-\nu, \mu}(-r) \div E_{\nu, \mu + \nu}(-s), \quad 0 < \nu < 1. \tag{A.27}$$

In the limit as $\lambda \rightarrow 0^-$ we formally obtain the Laplace transform pair

$$W_{0^-, \mu}(-r) := \frac{e^{-r}}{\Gamma(\mu)} \div \frac{1}{\Gamma(\mu)} \frac{1}{s+1} := E_{0, \mu}(-s). \tag{A.28}$$

Therefore, as $\lambda \rightarrow 0^\pm$, we note a sort of continuity in the formal results (A.25) and (A.28) since

$$\frac{1}{(s+1)} = \begin{cases} (1/s) E_0(-1/s), & |s| > 1; \\ E_0(-s), & |s| < 1. \end{cases} \tag{A.29}$$

A quite relevant Laplace transform pair related to the *auxiliary* functions of argument $r^{-\nu}$ is

$$\frac{1}{r} F(1/r^\nu; \nu) = \frac{\nu}{r^{\nu+1}} M(1/r^\nu; \nu) \div \exp(-s^\nu), \quad 0 < \nu < 1. \tag{A.30}$$

We recall that a rigorous proof of (A.30) was formerly given by Pollard [135], based on a formal result by Humbert [136]. The Laplace transform pair was also obtained by Mikusiński [137] and, albeit unaware of the previous results by Buchen & Mainardi [138] in a formal way.

After noting that the pair (A.30) can be easily deduced (with $r = t$) from (4.16) and (4.30), hereafter we like to provide two independent proofs carrying out the inversion of $\exp(-s^\nu)$, either by the complex integral formula or by the formal series method. We obtain

$$\begin{aligned} \mathcal{L}^{-1} [\exp(-s^\nu)] &= \frac{1}{2\pi i} \int_{Ha} e^{sr - s^\nu} ds = \frac{1}{2\pi i r} \int_{Ha} e^{\sigma - (\sigma/r)^\nu} d\sigma \\ &= \frac{1}{r} F(1/r^\nu; \nu) = \frac{\nu}{r^{\nu+1}} M(1/r^\nu; \nu), \end{aligned}$$

and

$$\begin{aligned} \mathcal{L}^{-1} [\exp(-s^\nu)] &= \sum_{n=0}^{\infty} \frac{(-1)^n}{n!} \mathcal{L}^{-1} [s^{\nu n}] = \sum_{n=1}^{\infty} \frac{(-1)^n}{n!} \frac{r^{-\nu n - 1}}{\Gamma(-\nu n)} \\ &= \frac{1}{r} F(1/r^\nu; \nu) = \frac{\nu}{r^{\nu+1}} M(1/r^\nu; \nu). \end{aligned}$$

Last, but not the least, we would like to mention the relevance of our auxiliary functions in probability theory. In fact, as shown by Engler [124], they turn out to be related with the probability density functions of the so-called stable distributions. For this interesting topic we refer the reader to our recent works [139-141].

REFERENCES

1. Gross, B.: *Mathematical Structure of the Theories of Viscoelasticity*, Hermann, Paris, 1953.
2. Bland, D.R.: *The Theory of Linear Viscoelasticity*, Pergamon, Oxford 1960.
3. Caputo, M. and F. Mainardi: Linear models of dissipation in anelastic solids, *Riv. Nuovo Cimento* (Ser. II), **1** (1971), 161-198.
4. Christensen, R.M.: *Theory of Viscoelasticity*, Academic Press, New York 1982.
5. Pipkin, A.C.: *Lectures on Viscoelastic Theory*, Springer Verlag, New York 1986.
6. Berg, C. and G. Forst: *Potential Theory on Locally Compact Abelian Groups*, Springer Verlag, Berlin 1975, §9., pp. 61-72.
7. Zener, C.M.: *Elasticity and Anelasticity of Metals*, Chicago University Press, Chicago 1948.
8. Gorenflo, R. and F. Mainardi: Fractional calculus: integral and differential equations of fractional order, in this book, *Fractals and Fractional Calculus in Continuum Mechanics* (Ed. A. Carpinteri and F. Mainardi), Springer Verlag, Wien 1997, 223-276. [Reprinted in NEWS 010101, <http://www.fracalmo.org>].
9. Scott-Blair, G.W.: *Survey of General and Applied Rheology*, Pitman, London 1949.
10. Caputo, M. and F. Mainardi: A new dissipation model based on memory mechanism, *Pure and Appl. Geophys.*, **91** (1971), 134-147.
11. Gemant, A.: On fractional differentials, *Phil. Mag.* [Ser. 7], **25** (1938), 540-549.
12. Gemant, A.: *Frictional Phenomena*, Chemical Publ. Co, Brooklyn N.Y. 1950.
13. Scott-Blair, G.W. and J.E. Caffy: An application of the theory of quasi-properties to the treatment of anomalous stress-strain relations, *Phil. Mag.* [Ser. 7], **40** (1949), 80-94.
14. Rabotnov, Yu.N.: Equilibrium of an elastic medium with after effect, *Prikl. Matem. i Mekh.*, **12** (1948), 81-91. [in Russian]
15. Rabotnov, Yu.N.: *Elements of Hereditary Solid Mechanics*, MIR, Moscow 1980.
16. Meshkov, S.I. and Yu.A. Rossikhin: Sound wave propagation in a viscoelastic medium whose hereditary properties are determined by weakly singular kernels, in *Waves in Inelastic Media* (Ed. Yu.N. Rabotnov), Kishinev 1970, 162-172. [in Russian]
17. Lokshin, A.A. and Yu.V. Suvorova: *Mathematical Theory of Wave Propagation in Media with Memory*, Moscow University Press, Moscow 1982. [in Russian]
18. Caputo, M.: Linear models of dissipation whose Q is almost frequency independent, *Annali di Geofisica*, **19** (1966), 383-393.

19. Caputo, M.: Linear models of dissipation whose Q is almost frequency independent, Part II., *Geophys. J. R. Astr. Soc.*, **13** (1967), 529-539.
20. Caputo, M.: *Elasticità e Dissipazione*, Zanichelli, Bologna 1969.
21. Caputo, M.: Vibrations of an infinite viscoelastic layer with a dissipative memory, *J. Acoust. Soc. Am.*, **56** (1974), 897-904.
22. Caputo, M.: A model for the fatigue in elastic materials with frequency independent Q , *J. Acoust. Soc. Am.*, **66** (1979), 176-179.
23. Caputo, M.: Generalized rheology and geophysical consequences, *Tectonophysics*, **116** (1985), 163-172.
24. Caputo, M.: Modern rheology and electric induction: multivalued index of refraction, splitting of eigenvalues and fatigues, *Annali di Geofisica*, **39** (1996), 941-966.
25. Mainardi, F. and E. Bonetti: The application of real-order derivatives in linear viscoelasticity, *Rheol. Acta*, **26** Suppl. (1988), 64-67.
26. Mainardi, F.: Fractional relaxation in anelastic solids, *J. Alloys and Compounds*, **211/212** (1994), 534-538.
27. Smith, W. and H. de Vries: Rheological models containing fractional derivatives, *Rheol. Acta*, **9** (1970), 525-534.
28. Scarpi, G.B.: Sui modelli reologici intermedi per liquidi viscoelastici, *Atti Accademia Scienze Torino, Classe Sci. fis. mat. nat.*, **107** (1973), 239-243.
29. Stiassnie, M.: On the application of fractional calculus for the formulation of viscoelastic models, *Appl. Math. Modelling*, **3** (1979), 300-302.
30. Bagley, R.L. and P.J. Torvik: A generalized derivative model for an elastomer damper, *Shock Vib. Bull.*, **49** (1979), 135-143.
31. Bagley, R.L. and P.J. Torvik: A theoretical basis for the application of fractional calculus, *J. Rheology*, **27** (1983), 201-210.
32. Torvik, P.J. and R.L. Bagley: On the appearance of the fractional derivatives in the behavior of real materials, *J. Appl. Mech.*, **51** (1984), 294-298.
33. Bagley R.L. and P.J. Torvik: On the fractional calculus model of viscoelastic behavior, *J. Rheology*, **30** (1986), 133-155.
34. Rogers, L.: Operator and fractional derivatives for viscoelastic constitutive equations, *J. Rheology*, **27** (1983), 351-372.
35. Koeller, R.C.: Applications of fractional calculus to the theory of viscoelasticity, *J. Appl. Mech.*, **51** (1984), 299-307.
36. Koeller, R.C.: Polynomial operators, Stieltjes convolution and fractional calculus in hereditary mechanics, *Acta Mech.*, **58** (1986), 251-264.

37. Koh, C.G. and J.M. Kelly: Application of fractional derivatives to seismic analysis of base-isolated models, *Earthquake Engineering and Structural Dynamics*, **19** (1990), 229-241.
38. Friedrich, C.: Mechanical stress relaxation in polymers: fractional integral model versus fractional differential model, *J. Non-Newtonian Fluid Mechanics*, **46** (1993), 307-314.
39. Nonnenmacher, T.F. and W.G. Glöckle: A fractional model for mechanical stress relaxation, *Phil. Mag. Lett.*, **64** (1991), 89-93.
40. Glöckle, W.G. and T.F. Nonnenmacher: Fractional relaxation and the time-temperature superposition principle, *Rheologica Acta*, **33** (1994), 337-343.
41. Makris, N. and M.C. Constantinou: Models of viscoelasticity with complex-order derivatives, *J. Eng. Mech.*, **119** (1993), 1453-1464.
42. Heymans, N. and J.-C. Bauwens: Fractal rheological models and fractional differential equations for viscoelastic behavior, *Rheologica Acta*, **33** (1994), 219-219.
43. Schiessel, H., Metzler, R., Blumen, A. and T.F. Nonnenmacher: Generalized viscoelastic models: their fractional equations with solutions, *J. Physics A: Math. Gen.*, **28** (1995), 6567-6584.
44. Gaul, L., Klein, P. and S. Kempfle: Damping description involving fractional operators, *Mechanical Systems and Signal Processing*, **5** (1989), 81-88.
45. Beyer, H. and S. Kempfle: Definition of physically consistent damping laws with fractional derivatives, *ZAMM*, **75** (1995), 623-635.
46. Fenander, Å.: Modal synthesis when modelling damping by use of fractional derivatives, *AIAA Journal*, **34** (1996), 1051-1058.
47. Pritz, T.: Analysis of four-parameter fractional derivative model of real solid materials, *J. Sounds Vibr.*, **195** (1996), 103-115.
48. Rossikhin, Yu.A. and M.V. Shitikova: Applications of fractional calculus to dynamic problems of linear and non linear hereditary mechanics of solids, *Appl. Mech. Rev.*, **50** (1997), 16-67.
49. Rossikhin Yu.A. and Shitikova, M.V.: Application of fractional operators to the analysis of damped vibrations of viscoelastic single-mass systems, *Journal of Sound and Vibration*, **199** No 4 (1997), 567-586.
50. Lion, A.: On the thermodynamics of fractional damping elements within the framework of rheological models, *Continuum Mechanics and Thermodynamics*, **9** (1997), 83-96.

51. Boussinesq, J.: Sur la résistance qu'oppose un liquid indéfini en repos, san pesanteur, au mouvement varié d'une sphère solide qu'il mouille sur toute sa surface, quand les vitesses restent bien continues et assez faibles pour que leurs carrés et produits soient négligeables, *C.R. Acad. Paris*, **100** (1885), 935-937.
52. Basset, A. B.: *A Treatise on Hydrodynamics*, Vol.2, Deighton Bell, Cambridge 1888, Chap. 22.
53. Stokes, G.G.: On the effect of the internal friction of fluids on the motion of pendulums, *Cambridge Phil. Trans. (Ser. VIII)*, **9** (1851), ???-???, reprinted in *Mathematical and Physical Papers*, Vol. III, pp. 1-141, Cambridge Univ. Press, 1922.
54. Picciati, G.: Sul moto di una sfera in un liquido viscoso, *Rend. R. Acc. Naz. Lincei* (ser. 5), **16** (1907), 943-951. [1-st sem.]
55. Boggio, T.: Integrazione dell'equazione funzionale che regge la caduta di una sfera in un liquido viscoso, *Rend. R. Acc. Naz. Lincei* (ser. 5), **16** (1907), 613-620, 730-737. [2-nd sem.]
56. Basset, A.B.: On the descent of a sphere in a viscous liquid, *Quart. J. Math*, **41** (1910), 369-381.
57. Hughes, R.R. and E.R. Gilliland: The mechanics of drops, *Chem. Engng. Progress*, **48** (1952), 497-504.
58. Odar, F. and W.S. Hamilton: Forces on a sphere accelerating in a viscous fluid, *J. Fluid Mech.*, **18** (1964), 302-314.
59. Odar, F.: Verification of the proposed equation for calculation of forces on a sphere accelerating in a viscous fluid, *J. Fluid Mech.*, **25** (1966), 591-592.
60. Maxey, M.R. and J.J. Riley: Equation of motion for a small rigid sphere in a nonuniform flow, *Phys. Fluids*, **26** (1983), 883-889.
61. McKee, S. and A. Stokes: Product integration methods for the nonlinear Basset equation, *SIAM J. Numer. Anal.*, **20** (1983), 143-160.
62. Reeks, M.V. and S. McKee: The dispersive effects of Basset history forces on particle motion in a turbulent flow, *Phys. Fluids*, **27** (1984), 1573-1582.
63. Lovalenti, P.M. and J.F. Brady: The hydrodynamic force on a rigid particle undergoing arbitrary time-dependent motion at small Reynolds number, *J. Fluid Mech.*, **256** (1993), 561-605.
64. Mei, R.: History forces on a sphere due to a step change in the free-stream velocity, *Int. J. Multiphase Flow*, **19** (1993), 509-525.
65. Lawrence, C.J. and R. Mei: Long-time behaviour of the drag on a body in impulsive motion, *J. Fluid. Mech.*, **283** (1995), 307-327.

66. Lovalenti, P.M. and J.F. Brady: The temporal behaviour of the hydrodynamic force on a body in response to an abrupt change in velocity at small but finite Reynolds number, *J. Fluid Mech.*, **293** (1995), 35-46.
67. Mainardi, F., Pironi, P. and F. Tampieri: On a generalization of the Basset problem via fractional calculus, in *Proceedings CANCAM 95* (Eds. Tabarrok, B and S. Dost), Vol. II (1995), 836-837. [15-th Canadian Congress of Applied Mechanics, Victoria, British Columbia, Canada, 28 May - 2 June 1995].
68. Mainardi, F., Pironi, P. and F. Tampieri: A numerical approach to the generalized Basset problem for a sphere accelerating in a viscous fluid, in *Proceedings CFD 95* (Eds. Thibault, P. A. and D.M. Bergeron), Vol. II (1995), 105-112. [3-rd Annual Conference of the Computational Fluid Dynamics Society of Canada, Banff, Alberta, Canada, 25-27 June 1995].
69. Tatom, F.B.: The Basset term as a semiderivative, *Appl. Sci. Res.*, **45** (1988), 283-285.
70. Wax, N. (Ed.): *Selected Papers on Noise and Stochastic Processes*, Dover, New-York 1954.
71. Fox, R.F. and G.E. Uhlenbeck: Contributions to non-equilibrium thermodynamics. I. Theory of hydro dynamical fluctuations, *Phys. Fluids*, **13** (1970), 1893-1902.
72. Fox, R.F.: Gaussian Stochastic Processes in Physics, *Physics Reports*, **48** (1978), 179-283.
73. Kubo, R., Toda, M., and N. Hashitsume: *Statistical Physics II, Nonequilibrium Statistical Mechanics*, Springer Verlag, Berlin 1991.
74. Alder, B.J. and T.E. Wainwright: Decay of velocity autocorrelation function, *Phys. Rev. A*, **1** (1970), 18-21.
75. Ernst, M.H., Hauge, E.H. and J.M.J. Leenwen: Asymptotic time behavior of correlation functions, *Phys. Rev. Lett.*, **25** (1970), 1254-1256
76. Dorfman, J.R. and E.G. Cohen: Velocity correlation functions in two and three dimensions, *Phys. Rev. Lett.*, **25** (1970), 1257-1260
77. Zwanzig, R. and M. Bixon: Hydrodynamic theory of the velocity correlation function, *Phys. Rev. A*, **2** (1970), 2005-2012.
78. Kawasaki, K.: Long time behavior of the velocity autocorrelation function *Phys. Lett.*, **32A** (1971), 379-380.
79. Widom, A.: Velocity fluctuations of a hard-core Brownian particle, *Phys. Rev. A*, **3** (1971), 1394-1396.
80. Case, K.M.: Velocity fluctuations of a body in a fluid, *Phys. Fluids*, **14** (1971), 2091-2095.

81. Mazo, R.M.: Theory of Brownian motion IV; a hydrodynamic model for the friction factor, *J. Chem. Phys.*, **54** (1971), 3712-3713.
82. Nelkin, M.: Inertial effects in motion driven by hydrodynamic fluctuations, *Phys. Fluids*, **15** (1972), 1685-1690.
83. Chow, Y.S. and J.J. Hermans: Effect of inertia on the Brownian motion of rigid particles in a viscous fluid, *J. Chem. Phys.*, **56** (1972), 3150-3154.
84. Hynes, J.T.: On hydrodynamic models for Brownian motion, *J. Chem. Phys.*, **57** (1972), 5612-5613.
85. Pomeau, Y.: Low-frequency behavior of transport coefficients in fluids, *Phys. Rev. A*, **5** (1972), 2569-2587.
86. Keizer, J.: Comment on effect of inertia on Brownian motion, *J. Chem. Phys.*, **58** (1973), 824-825.
87. Davis, H.T. and G. Subramian: Velocity fluctuation of a Brownian particle: Widom's model *J. Chem. Phys.*, **58** (1973), 5167-5168.
88. Hauge, E.H. and A. Martin-Löf: Fluctuating hydrodynamics and Brownian motion, *J. Stat. Phys.*, **7** (1973), 259-281.
89. Dufty, J.W.: Gaussian model for fluctuation of a Brownian particle, *Phys. Fluids*, **17** (1974), 328-333.
90. Szu H.H., Szu, S.C. and J.J. Hermans: Fluctuation-dissipation theorems on the basis of hydrodynamic propagators, *Phys. Fluids*, **17** (1974), 903-907.
91. Bedeaux, D. and P. Mazur: Brownian motion and fluctuating hydrodynamics, *Physica*, **76** (1974) 247-258.
92. Hinch, E.J.: Applications of the Langevin equation to fluid suspension, *J. Fluid. Mech.*, **72** (1975), 499-511.
93. Y. Pomeau and P. Résibois: Time dependent correlation functions and mode-mode coupling theories, *Physics Reports*, **19** (1975), 63-139.
94. Warner, M.: The long-time fluctuations of a Brownian sphere, *J. Phys. A: Math. Gen.*, **12** (1979), 1511-1519.
95. Paul, G.L. and P.N. Pusey: Observation of a long-time tail in Brownian motion, *J. Phys. A: Math. Gen.*, **14** (1981), 3301-3327.
96. Reichl, L.E.: Translation Brownian motion in a fluid with internal degrees of freedom, *Phys. Rev.*, **24** (1981), 1609-1616.
97. Clercx, H.J.H. and P.P.J.M. Schram: Brownian particles in shear flow and harmonic potentials: a study of long-time tails, *Phys. Rev. A*, **46** (1992), 1942-1950.
98. Muralidhar, R., Ramkrishna, D., Nakanishi, H., and D.J. Jacobs: Anomalous diffusion: a dynamic perspective, *Physica A*, **167** (1990), 539-559.

99. Bouchaud, J.-P. and A. Georges: Anomalous diffusion in disordered media: statistical mechanisms, models and physical applications, *Physics Reports*, **195** (1990), 127-293.
100. Wang, K.C.: Long-time correlation effects and biased anomalous diffusion, *Phys. Rev. A*, **45** (1992), 833-837.
101. Giona, M. and H.E. Roman: Fractional diffusion equation for transport phenomena in random media, *Physica A*, **185** (1992), 82-97.
102. Metzler, R., Glöckle, W.G. and T.F. Nonnenmacher: Fractional model equation for anomalous diffusion, *Physica A*, **211** (1994), 13-24.
103. Kubo, R.: The fluctuation-dissipation theorem, *Rep. on Progress in Physics*, **29** (1966), 255-284.
104. Felderhof, B.U.: On the derivation of the fluctuation-dissipation theorem, *J. Phys. A: Math. Gen.*, **11** (1978), 921-927.
105. Mainardi, F. and P. Pironi: The fractional Langevin equation: the Brownian motion revisited, *Extracta Mathematicae*, **11** (1996), 140-154.
106. Mainardi, F. and F. Tampieri: Diffusion regimes in Brownian induced by the Basset history force, *Technical Report No 1, ISAO-TR1/99* ISAO-CNR, Bologna (Italy), March 1999, pp. 25. [Reprinted as FRACALMO PRE-PRINT 0102, see <http://www.fracalmo.org>]
107. Gel'fand, I.M. and G.E. Shilov: *Generalized Functions*, Vol. 1, Academic Press, New York 1964.
108. Zemanian, A.H.: *Distribution Theory and Transform Analysis*, McGraw-Hill, New York 1965.
109. Doetsch, G.: *Introduction to the Theory and Application of the Laplace Transformation*, Springer Verlag, Berlin 1974.
110. Nigmatullin, R.R.: The realization of the generalized transfer equation in a medium with fractal geometry, *Phys. Stat. Sol. B*, **133** (1986), 425-430. [English transl. from Russian]
111. Mainardi, F.: Fractional diffusive waves in viscoelastic solids in *IUTAM Symposium - Nonlinear Waves in Solids* (Ed. J. L. Wegner and F. R. Norwood), ASME/AMR, Fairfield NJ 1995, 93-97. [Abstract in *Appl. Mech. Rev.*, **46** (1993), 549]
112. Mainardi, F.: On the initial value problem for the fractional diffusion-wave equation, in *Waves and Stability in Continuous Media* (Ed. S. Rionero and T. Ruggeri), World Scientific, Singapore 1994, 246-251.
113. Mainardi, F.: The time fractional diffusion-wave equation, *Radiophysika*, **38** (1995), 20-36. [English Translation: Radiophysics and Quantum Electronics]

114. Mainardi, F. and M. Tomirotti: On a special function arising in the time fractional diffusion-wave equation, in *Transform Methods and Special Functions, Sofia 1994* (Ed. P. Rusev, I. Dimovski and V. Kiryakova), Science Culture Technology, Singapore 1995, 171-183.
115. Mainardi, F.: Fractional relaxation-oscillation and fractional diffusion-wave phenomena, *Chaos, Solitons and Fractals*, **7** (1996), 1461-1477.
116. Mainardi, F. : The fundamental solutions for the fractional diffusion-wave equation, *Applied Mathematics Letters*, **9**, No 6 (1996), 23-28.
117. Wyss, W.: Fractional diffusion equation, *J. Math. Phys.*, **27** (1986), 2782-2785.
118. Schneider, W.R. and W. Wyss: Fractional diffusion and wave equations, *J. Math. Phys.*, **30** (1989), 134-144.
119. Schneider, W.R: Fractional diffusion, in: *Dynamics and Stochastic Processes, Theory and Applications* (Eds. R. Lima, L. Streit and D. Vilela Mendes), Lecture Notes in Physics # 355, Springer Verlag, Heidelberg 1990, 276-286.
120. Fujita, Y.: Integrodifferential equation which interpolates the heat equation and the wave equation, *Osaka J. Math.*, **27** (1990), 309-321, 797-804.
121. Kochubei, A.N.: A Cauchy problem for evolution equations of fractional order, *J. Diff. Eqns*, **25** (1989), 967-974. [English transl. from Russian]
122. Kochubei, A.N.: Fractional order diffusion, *J. Diff. Eqns*, **26** (1990), 485-492. [English transl. from Russian]
123. El-Sayed, A.M.A.: Fractional-order diffusion-wave equation, *Int. J. Theor. Phys.*, **35** (1996), 311-322.
124. Engler, H.: Similarity solutions for a class of hyperbolic integrodifferential equations, *Differential Integral Eqns*, **10** (1997), 815-840.
125. Erdélyi, A., Magnus, W., Oberhettinger and F.G. Tricomi: *Higher Transcendental Functions*, Bateman Project, Vol. 3, McGraw-Hill, New York 1955, Ch. 18.
126. Wright, E.M.: On the coefficients of power series having exponential singularities, *J. London Math. Soc.* **8** (1933), 71-79.
127. Wright, E.M.: The generalized Bessel function of order greater than one, *Quart. J. Math.* (Oxford ser.) **11** (1940), 36-48.
128. Stanković, B.: On the function of E.M. Wright, *Publ. Institute Math. Beograd* (Nouv. serie) **10**, No 24 (1970), 113-124.
129. Gajić, Lj. and B. Stanković, Some properties of Wright's function, *Publ. Institute Math. Beograd* (Nouv. serie) **20**, No 34 (1976), 91-98.
130. Kiryakova, V.: *Generalized Fractional Calculus and Applications*, Pitman Research Notes in Mathematics # 301, Longman, Harlow 1994.

131. Tricomi, F.G.: *Fonctions Hypergéométriques Confluentes*, Mém. Sci. Math. # 140, Gauthier-Villars, Paris 1960.
132. Gatteschi, L.: *Funzioni Speciali*, UTET, Torino 1973, pp. 196-197.
133. Bender, C.M. and S.A. Orszag: *Advanced Mathematical Methods for Scientists and Engineers*, McGraw-Hill, Singapore 1987, Ch 3.
134. Mainardi, F. and M. Tomirotti: The asymptotic representation of the generalized hyper-Airy function in the complex plane, *PRE-PRINT*, Dept. of Physics, University of Bologna, 1996.
135. Pollard, H.: The representation of $\exp(-x^\lambda)$ as a Laplace integral, *Bull. Amer. Math. Soc.*, **52** (1946), 908-910.
136. Humbert, P.: Nouvelles correspondances symboliques, *Bull. Sci. Mathém.* (Paris, II ser.), **69** (1945), 121-129.
137. Mikusiński, J.: On the function whose Laplace transform is $\exp(-s^\alpha \lambda)$, *Studia Math.*, **18** (1959), 191-198.
138. Buchen, P.W. and F. Mainardi: Asymptotic expansions for transient viscoelastic waves, *Journal de Mécanique*, **14** (1975), 597-608.
139. Mainardi, F. and M. Tomirotti: Seismic pulse propagation with constant Q and stable probability distributions, *Annali di Geofisica*, **40** (1997), 1311-1328.
140. Mainardi, F., Paradisi, P and R. Gorenflo: Probability distributions generated by fractional diffusion equations, in *Econophysics: an Emerging Science* (Eds. Kertesz, J. and I. Kondor), Kluwer, Dordrecht ????, pp. 39, to appear. [Pre-print available at <http://www.fracalmo.org>].
141. Gorenflo, R. and F. Mainardi: Fractional calculus and stable probability distributions, *Archives of Mechanics*, **50** (1998), 377-388.
142. Gorenflo, R., Luchko, Yu. and F. Mainardi: Analytical properties and applications of the Wright function. *Fractional Calculus and Applied Analysis*, **2** (1999), 383-414.
143. Gorenflo, R., Luchko, Yu. and F. Mainardi: Wright functions as scale-invariant solutions of the diffusion-wave equation, *J. Computational and Appl. Mathematics*, **118** (2000), 175-191.
144. Wong, R. and Y.-Q. Zhao: Smoothing of Stokes' discontinuity for the generalized Bessel function, *Proc. R. Soc. London A*, **455** (1999), 1381-1400.
145. Wong, R. and Y.-Q. Zhao: Smoothing of Stokes' discontinuity for the generalized Bessel function II, *Proc. R. Soc. London A*, **455** (1999), 3065-3084.