

# Phase space analysis of quintessence fields trapped in a Randall-Sundrum Braneworld: a refined study

Dagoberto Escobar\*

*Departamento de Física Universidad de Camagüey, Cuba.*

Carlos R. Fadragas†

*Departamento de Física, Universidad Central de Las Villas, Santa Clara CP 54830, Cuba.*

Genly Leon‡

*Departamento de Matemática, Universidad Central de Las Villas, Santa Clara CP 54830, Cuba. and  
Instituto de Física, Pontificia Universidad de Católica de Valparaíso, Casilla 4950, Valparaíso, Chile.*

Yoelsy Leyva§

*División de Ciencias e Ingeniería de la Universidad de Guanajuato, A.P. 150, 37150, León, Guanajuato, México.*

(Dated: October 25, 2018)

In this paper we investigate, from the dynamical systems perspective, the evolution of an scalar field with arbitrary potential trapped in a Randall-Sundrum's Braneworld of type II. We consider an homogeneous and isotropic Friedmann-Robertson-Walker (FRW) brane filled also with a perfect fluid. Center Manifold Theory is employed to obtain sufficient conditions for the asymptotic stability of de Sitter solution. We obtain conditions on the potential for the stability of scaling solutions as well for the stability of the scalar-field dominated solution. We prove there are not late time attractors with 5D-modifications (they are saddle-like). This fact correlates with a transient primordial inflation. In the particular case of a scalar field with potential  $V = V_0 e^{-\chi\phi} + \Lambda$  we prove that for  $\chi < 0$  the de Sitter solution is asymptotically stable. However, for  $\chi > 0$  the de Sitter solution is unstable (of saddle type).

KeyWords: Cosmology, dynamical system, modified gravity, Randall-Sundrum

PACS numbers: 04.20.-q, 04.20.Cv, 04.20.Jb, 04.50.Kd, 11.25.-w, 11.25.Wx, 95.36.+x, 98.80.-k, 98.80.Bp, 98.80.Cq, 98.80.Jk

## I. INTRODUCTION

The Randall-Sundrum brane of type II model (RS2), introduced originally as an alternative mechanism to the Kaluza-Klein compactifications [1], have been intensively studied in the last years, among other reasons, because its appreciable cosmological impact in the inflationary scenario [2–4]. The setup of the model start with the particles of the standard model confined in a four dimensional hypersurface with positive tension embedded in a 5-dimensional bulk with negative cosmological constant. It is well-known that the cosmological field equations on the brane are essentially different from the standard 4-dimensional cosmology [5–7]. In fact the appearance of a quadratic term of the total energy density in the Friedmann equation is responsible for gravitational modifications at very high energy. The dynamics of the Universe during the quadratic dominant stage have been studied by several authors. In [8, 9] it is shown that the (inverse) power-law potential model allow wide conditions

for a successful quintessence scenario in contrast with exponential potential and k-essence models which do not present favorable scenarios. The stability of the scaling solutions for the case of power-law potential model in the presence of a perfect fluid with arbitrary barotropic index  $\gamma$  was developed by [10]. This study was extended by [11] to a generalized background  $H^2 \propto \rho_T^n$  for an arbitrary  $n$  (the RS2 case is recovery when  $n = 2$ ). Another interesting and recently feature of this scenario is that the fate of the cosmic expansion can be modified if the energy density of some matter component grow as the expansion proceeds [12]<sup>1</sup>

Several astrophysical observations such as Type Ia Supernovae [13–15], Large Scale Structure [16] and Cosmic Microwave Background [17–19] strongly confirm that our universe currently experiences an accelerated expansion phase. Several models, based on RS2 framework, have been proposed in order to deal with these feature of our universe. One approach for explaining the accelerated expansion is the Modified Chaplygin Gas [20]. For this

---

\*Electronic address: dagoberto.escobar@reduc.edu.cu

†Electronic address: fadragas@uclv.edu.cu

‡Electronic address: genly@uclv.edu.cu

§Electronic address: yoelsy.leyva@fisica.ugto.mx

---

<sup>1</sup> This kind of modification do not appear if the energy density of the matter content in the brane dilutes with the cosmic expansion as occurs with the common matter sources: quintessence scalar field, radiation, dust, etc.

models was showed that the Universe follows a power law-expansion around the critical points. Another important approach consist in adding a self-interacting scalar field to the matter inventory in the brane [8, 21–24]. Scalar fields arise in a natural way in particle physics and they can act as a candidate for dark energy playing the roles such that quintessence, phantom, quintom, tachyons field etc. [25]

The dynamical behavior of scalar field coupled with a barotropic fluid in a spatially flat Friedmann–Robertson Walker universe has been studied by many authors, see for instance the references [26–32]. A natural generalization of [26], is to include higher-dimensional behavior (RS2 scenario). This program was carried out in [33] where was found the corresponding scalar field potentials which lead to attractor scaling solution for several energy density modifications to the Friedmann equation; for the RS2 framework the potential  $V \propto \text{cosech}^2(A\phi)$  was found<sup>2</sup>. The dynamics of a scalar field with constant and exponential potentials was investigated in [34]. These results were extended to a wider class of self-interaction potential in [35] using a method proposed by [29] supporting the idea that this scenario modifies gravity only at very high energy/short scales (UV modifications only) having an appreciable impact on primordial inflation but does not affecting the late-time dynamics of the Universe<sup>3</sup>. In this paper we make a step forward with respect to the previous studies by exploring more deeply the dynamics in the phase space associated to this scenario around both hyperbolic an non-hyperbolic critical points. The last subject cannot be consistently studied with the help of linear analysis, but using the Center Manifold Theory. Our claim is that the more interesting solution are the non-hyperbolic critical points, in particular the de Sitter critical points.

In this paper we employ the Center Manifold Theory to obtain sufficient conditions for the asymptotic stability of de Sitter solution and for proving that here are not late time attractors with 5D-modifications. This fact correlates with a transient primordial inflation. Also we provide conditions on the potential for the stability of scaling solutions as well for the stability of the scalar-field dominated solution.

The paper is organized as follows. In Section II we give the essential details of the Randall-Sundrum Model and deals with the dynamical system analysis, these include the center manifold study. We explore the dynamics of an scalar field with exponential potential plus a Cosmological Constant trapped on the brane using the previous results in Section III. Section IV is devoted to the physi-

cal discussion of the above results, while the conclusions are given in Section IV.

## II. DYNAMICAL SYSTEMS ANALYSIS OF THE FRW BRANE

In this section we will focus our attention in a brane-world model where an scalar field, with arbitrary self-interaction potential, is trapped on a RS2 brane. In the flat FRW metric, the field equations read [36–39]:

$$H^2 = \frac{1}{3}\rho_T \left(1 + \frac{\rho_T}{2\lambda}\right) + \frac{2\mathcal{U}}{\lambda} \quad (1)$$

$$2\dot{H} = -(1 + \frac{\rho_T}{\lambda})(\dot{\phi}^2 + \gamma\rho_m) - \frac{4\mathcal{U}}{\lambda} \quad (2)$$

$$\dot{\rho}_m = -3\gamma H\rho_m \quad (3)$$

$$\ddot{\phi} + \partial_\phi V = -3H\dot{\phi} \quad (4)$$

where we have used the Randall-Sundrum fine tuning condition i.e., we neglect the cosmological constant term ( $\Lambda_4 = 0$ ).  $\rho_T = \rho_\phi + \rho_m$ ,  $\lambda$  is the brane tension,  $\gamma$  is the barotropic index of the background fluid,  $V$  is the scalar field self-interaction potential.  $\mathcal{U}(t) = \frac{C}{a(t)^4}$  is the dark radiation term which arises from a non-vanishing bulk Weyl tensor being  $C$  a constant parameter related with black hole mass in the bulk: if the bulk is AdS–Schwarzschild  $C \neq 0$  [37]. When the black hole mass vanishes, the bulk geometry reduces to AdS, and  $C = 0$  [7, 39]. In the following we will study the latter case i. e., we will not consider here the dark radiation term. Here and throughout, we use  $\partial_\phi$  to denote derivative with respect to  $\phi$ .

From the Friedmann equation (1) it is deduced how the brane effects modify the early time dynamics: at high energy ( $\rho_T \gg \lambda$ ) this equation reduces to  $H \propto \rho_T$ . A late times, due to the expansion rate, the energy density of the matter trapped in the brane dilutes ( $\rho_T \ll \lambda$ ), and the standard 4D TGR behavior is recovered, leading to  $H \propto \sqrt{\rho_T}$ .

Having presented the cosmological equations, our purpose now is to define a dynamical system from (1)-(4) in order to examine all possible cosmological behaviors. As we know dynamical systems techniques provides one of the better tools for obtaining useful information about the evolution of a wide class of cosmological models<sup>4</sup>. In order to take advantage from these tools, we introduce the Hubble-normalized variables

$$x = \frac{\dot{\phi}}{\sqrt{6}H} \quad y = \frac{V}{3H^2} \quad \Omega_\lambda = \frac{\rho_T^2}{6\lambda H^2}, \quad (5)$$

<sup>2</sup> At early times, where the quadratic energy term dominates, this potential behave as a (inverse) power-law potential being consistent with previous analysis [8, 9].

<sup>3</sup> A word of caution: this claim is not in general true, specially if the energy density of the matter trapped in the brane increase at late times [12]

<sup>4</sup> See, for instance, the seminal work [26], and [40, 41].

the new temporal variable  $\tau = \int H dt$ , and the additional dynamical (non-compact) variable,  $s$ , given by

$$s = -\partial_\phi \ln V(\phi). \quad (6)$$

which is a function of the scalar field.

For the scalar potential treatment, we proceed following the reference [29]. Let be defined the scalar function

$$f = \Gamma - 1, \quad \Gamma = \frac{V''V}{V'^2}. \quad (7)$$

Since  $\Gamma$  is a function of the scalar field  $\Gamma(\phi)$  (see definition (7)), also is the variable  $s = S(\phi)$ . Assuming that the inverse of  $S$  exists, we have  $\phi = S^{-1}(s)$ . Thus, one can obtain de relation  $\Gamma = \Gamma(S^{-1}(s))$  and finally the scalar field potential can be parameterized by a function  $f(s)$ . Thus, in general, it is possible the treatment of general classes of potentials using an “ $f$ -deviser”. In the table I are shown the functions  $f(s)$  for some usual quintessence potentials. The cases (a)-(c) have been studied in  $RS2$  branes in [35].

Bearing this in mind, and using the variables (5)-(6) we deduce the following autonomous system of ordinary differential equations (ODE)

$$x' = \sqrt{\frac{3}{2}}sy - 3x + \frac{3(\Omega_\lambda + 1)(\gamma - 2)}{2(\Omega_\lambda - 1)}x^3 + \frac{3\gamma(\Omega_\lambda + 1)(y + \Omega_\lambda - 1)}{2(\Omega_\lambda - 1)}x \quad (8)$$

$$y' = \frac{3y(\Omega_\lambda + 1)}{(\Omega_\lambda - 1)} [(\gamma - 2)x^2 + \gamma(\Omega_\lambda + y - 1)] - \sqrt{6}xys \quad (9)$$

$$\Omega'_\lambda = 3\Omega_\lambda [(\gamma - 2)x^2 + \gamma(\Omega_\lambda + y - 1)] \quad (10)$$

$$s' = -\sqrt{6}xs^2f(s), \quad (11)$$

where the comma denotes derivative with respect  $\tau$ .

From the Friedmann equation (1) follows the relation

$$\Omega_m = 1 - x^2 - y - \Omega_\lambda \quad (12)$$

Using (12), the energy condition  $0 \leq \Omega_m \leq 1$  can be written as

$$0 \leq x^2 + y + \Omega_\lambda \leq 1. \quad (13)$$

From the definition of  $\Omega_\lambda$  and the Friedmann equation we obtain the useful relation

$$\frac{\rho_T}{\lambda} = \frac{2\Omega_\lambda}{1 - \Omega_\lambda} \quad (14)$$

From (16) follows that the invariant set  $\Omega_\lambda = 1$  corresponds to cosmological solutions where  $\rho_T \gg \lambda$  (corresponding to the formal limit  $\lambda \rightarrow 0$ ). Therefore, they are associate to high energy regions, i.e., to cosmological solutions in a neighborhood of the initial singularity

<sup>5</sup>. Due to its classic nature, our model is not appropriate to describing the dynamics near the initial singularity, where quantum effects appear. However, from the mathematical viewpoint, this region ( $\Omega_\lambda = 1$ ) is reached asymptotically. In fact, as some numerical integrations corroborate, there exists an open set of orbits in the phase interior that tends to the boundary  $\Omega_\lambda = 1$  as  $\tau \rightarrow -\infty$ . Therefore, for mathematical motivations it is common to attach the boundary  $\Omega_\lambda = 1$  to the phase space. On the other hand the points with ( $\Omega_\lambda = 0$ ) are associated to the standard 4D behavior ( $\rho_T \ll \lambda$  or  $\lambda \rightarrow \infty$ ) and corresponds to the low energy regime.

From definition (5) and from the restriction (13), and taking into account the previous statements, it is enough to investigate to the flow of (8)-(11) defined in the phase space

$$\Psi = \{(x, y, \Omega_\lambda) : 0 \leq x^2 + y + \Omega_\lambda \leq 1, -1 \leq x \leq 1, 0 \leq y \leq 1, 0 \leq \Omega_\lambda \leq 1\} \times \{s \in \mathbb{R}\}. \quad (15)$$

Some cosmological parameters like the equation of state parameter of the scalar matter  $\omega_\phi = \frac{p_\phi}{\rho_\phi}$ , the deceleration parameter  $q = -\left(1 + \frac{\ddot{H}}{H^2}\right)$  can be re-expressed as functions of the new variables as follows

$$\omega_\phi = \frac{x^2 - y}{x^2 + y}, \quad \Omega_\phi = x^2 + y \quad (16)$$

$$q = \left(\frac{1 + \Omega_\lambda}{1 - \Omega_\lambda}\right) \left[3x^2 + \frac{3\gamma}{2}(1 - x^2 - y - \Omega_\lambda)\right] - 1 \quad (17)$$

## A. Critical points

The system (8)-(11), admits the curves of critical points  $P_1, P_2, P_3$ ; the critical points  $P_4^\pm$  and  $P_5$ ; and the classes of critical points  $P_6^\pm, P_7$  and  $P_8$  parameterized by  $s^*$  satisfying  $f(s^*) = 0$ . In Table II are displayed the location, existence conditions and some basic observables of these critical points <sup>6</sup>. The critical points of  $P_1$  to  $P_6^\pm$  always exist; the point  $P_7$  exists for  $s^{*2} \geq 3\gamma$ , whereas,  $P_8$  exists for  $s^{*2} \leq 6$  with  $f(s^*) = 0$ .

Now let us comment on the stability of the first order perturbations of (8)-(11) near the critical points displayed in table II. Let us comment briefly in their physical interpretation.

The line of critical points  $y = 1 - \Omega_\lambda$  called  $P_1$  represent solutions with 5D-corrections, since, in general,  $\Omega_\lambda \neq$

<sup>5</sup> See the references [30, 50] for a classical treatment of cosmological solutions near the initial singularity.

<sup>6</sup> Strictly speaking the system admits one more curve of critical point with coordinates  $x \in [-1, 1], y = -\frac{x^2(\gamma-2)}{\gamma}, \Omega_\lambda = 1, s = 0$ , but since the energy condition (13) is not satisfied, we omit it from the analysis.

TABLE I: Explicit forms of  $f(s)$  for some self-interaction potentials. To homogenize the notations we use units in which  $\kappa^2 \equiv 8\pi G = 1$ .

| Label | Potential  | $f(s)$  | Reference |
|-------|--|---|-----------|
| (a)   | $V = V_0 \sinh^{-\alpha} \chi\phi$               | $\frac{1}{\alpha} - \frac{\alpha\chi^2}{s^2}$       | [42, 43]  |
| (b)   | $V = V_0 [\cosh(\chi\phi) - 1]^\alpha$           | $-\frac{1}{2\alpha} + \frac{\alpha\chi^2}{2s^2}$    | [44]      |
| (c)   | $V = \frac{V_0}{(\eta + e^{-\alpha\phi})^\beta}$ | $\frac{1}{\beta} + \frac{\alpha}{s}$                | [45]      |
| (d)   | $V = V_0 e^{-\chi\phi} + \Lambda$                | $-1 - \frac{\chi}{s}$                               | [46]      |
| (e)   | $V = V_0 \frac{e^{\chi\phi^2}}{\phi^m}$          | $\frac{s^2 + 8m\chi + s\sqrt{s^2 + 8m\chi}}{2ms^2}$ | [47, 48]  |
| (f)   | $V = V_0 [e^{\alpha\phi} + e^{\beta\phi}]$       | $-\frac{(s+\alpha)(s+\beta)}{s^2}$                  | [49]      |

TABLE II: Location, existence conditions and some basic observables for the critical points of the system of equations (8)-(11).

| $P_i$     | $x$                                    | $y$                                   | $\Omega_\lambda$            | $s$                | Existence             | $\omega_\phi$             | $\Omega_\phi$            | $q$                     |
|-----------|--|---------------------------------------|-----------------------------|--------------------|-----------------------|---------------------------|--------------------------|-------------------------|
| $P_1$     | 0                                      | $1 - \Omega_\lambda$                  | $\Omega_\lambda \in [0, 1[$ | 0                  | Always                | -1                        | $1 - \Omega_\lambda$     | -1                      |
| $P_2$     | 0                                      | 0                                     | 0                           | $s \in \mathbb{R}$ | "                     | undefined                 | 0                        | $\frac{3\gamma}{2} - 1$ |
| $P_3$     | 0                                      | 0                                     | 1                           | $s \in \mathbb{R}$ | "                     | undefined                 | 0                        | undefined               |
| $P_4^\pm$ | $\pm 1$                                | 0                                     | 0                           | 0                  | "                     | 1                         | 1                        | 2                       |
| $P_5$     | 0                                      | 1                                     | 0                           | 0                  | "                     | -1                        | 1                        | -1                      |
| $P_6^\pm$ | $\pm 1$                                | 0                                     | 0                           | $s^*$              | "                     | 1                         | 1                        | 2                       |
| $P_7$     | $\frac{\sqrt{\frac{3}{2}}\gamma}{s^*}$ | $-\frac{3(\gamma-2)\gamma}{2(s^*)^2}$ | 0                           | $s^*$              | $s^{*2} \geq 3\gamma$ | $\gamma - 1$              | $\frac{3\gamma}{s^{*2}}$ | $\frac{3\gamma}{2} - 1$ |
| $P_8$     | $\frac{s^*}{\sqrt{6}}$                 | $1 - \frac{(s^*)^2}{6}$               | 0                           | $s^*$              | $s^{*2} \leq 6$       | $\frac{1}{3}(s^{*2} - 3)$ | 1                        | $\frac{s^{*2}}{2} - 1$  |

0. From the relationship between  $y$  and  $\Omega_\lambda$  follows that this solution is dominated by the potential energy of the scalar field  $\rho_T = V(\phi)$ ; that is, it is de Sitter-like solution ( $\omega_\phi = -1$ ). In this case the Friedmann equation can be expressed as

$$3H^2 = V \left( 1 + \frac{V}{2\lambda} \right) \quad (18)$$

In the early universe, where  $\lambda \ll V$ , the expansion rate of the universe for the RS model differs from the general relativity predictions

$$\frac{H_{RS}}{H_{GR}} = \sqrt{\frac{V}{2\lambda}} \quad (19)$$

$P_1$  admits a 2D stable manifold,  $M_2$ . Due the importance of de Sitter solutions in the cosmological context, in section II A 2 we calculate explicitly their center manifold

proving that this critical point is locally asymptotically unstable.

The point  $P_2$  represents a matter-dominated solution ( $\Omega_m = 1$ ). Although it is non-hyperbolic, it behaves like a saddle point in the space of phase of the RS model, since they have a nonempty stable and unstable manifolds (see the table III) <sup>7</sup>.

The critical point  $P_3$  is located at the boundary  $\Omega_\lambda = 1$  of the phase space region (15). From the physical viewpoint, this solution represents the Big Bang singularity ( $\rho_T \rightarrow \infty$ ). The eigenvalues for  $P_3$  are displayed in tables III. They were calculated for orbits contained completely in the invariant set  $x = y = 0$  and by taking the limit

<sup>7</sup> Strictly speaking, the concept of saddle point is not applicable to nonhyperbolic critical points.

as  $\Omega_\lambda \rightarrow 1$ . For orbits outside the above invariant set we cannot make the above limit process since the system is not of class  $C^1$  at  $\Omega_\lambda = 1$ . However, several numerical integrations suggest that this solution is, indeed, the past attractor.

The critical points  $P_4^\pm$  are solutions dominated by the kinetic energy of the scalar field and they represent solutions with a standard behavior ( $\Omega_\lambda = 0$ ). This critical points are nonhyperbolic. However, they behave as saddle-like points in the space of phase because of the instability in the eigendirection associated with a positive eigenvalue and the stability of an eigendirection associated to a negative eigenvalue.

The critical point  $P_5$  is a particular case of  $P_1$  when ( $\Omega_\lambda = 0$ ). They represent a solution dominated by the potential energy of the scalar field. Indeed, it is a late attractor of Sitter provided  $f(0) > 0$ .<sup>8</sup>

The stability analysis of the critical points  $P_6^\pm$ ,  $P_7$  and  $P_8$  is a little more complicated task since the eigenvalues of the linearization matrix do depend on the function  $f(s)$ , their zeros,  $s = s^*$ , and the value of the first derivative at  $s = s^*$ .

The critical points  $P_6^\pm$  are solutions dominated by the kinetic energy of the scalar field and represent transient states (saddle points in the phase space) in the evolution of the universe for  $\gamma < 2$ . For  $\gamma = 2$ , the point  $P_6^+$  is nonhyperbolic; the stable manifold is 3D provided

$$s^* > \sqrt{6} \quad (20)$$

and  $f'(s^*) > 0$ ; otherwise, the stable manifold it is of dimension less than 3. Similarly, for  $\gamma = 2$ , the point  $P_6^-$  is nonhyperbolic; and their stable manifold is 3D provided

$$s^* < -\sqrt{6} \quad (21)$$

and  $f'(s^*) < 0$ ; otherwise, the stable manifold is of dimension less than 3.

The critical points  $P_7$  are nonhyperbolic for  $s^* \in \{-\sqrt{3\gamma}, \sqrt{3\gamma}\}$  or  $s^*f'(s^*) = 0$  or  $\gamma = 2$ . The points  $P_8$  represent scalar-field-dominated solutions ( $\Omega_\phi = 1$ ) which are non hyperbolic provided  $s^{*2} \in \{0, 3\gamma, 6\}$  or  $f'(s^*) = 0$ .

Having presented the eigenvalues of the Jacobian matrix for the critical points  $P_7$  and  $P_8$  in table III, we straightway formulate the following results.

The sufficient conditions for the asymptotic stability of the matter-scalar-field scaling solution ( $P_7$ ) are

- i)  $0 \leq \gamma < 2$ ,  $s^* < -\sqrt{3\gamma}$  and  $f'(s^*) < 0$ , or
- ii)  $0 \leq \gamma \leq 2$ ,  $s^* > \sqrt{3\gamma}$  and  $f'(s^*) > 0$ .

The sufficient conditions for the asymptotic stability of the scalar-field-dominated solution ( $P_8$ ) are either

- iii)  $0 \leq \gamma < 2$ ,  $-\sqrt{3\gamma} < s^* < 0$  and  $f'(s^*) < 0$ , or
- iv)  $0 \leq \gamma \leq 2$ ,  $0 < s^* < \sqrt{3\gamma}$  and  $f'(s^*) > 0$ .

### 1. Dynamics of the center manifold of $P_5$

The solution  $P_5$  is a particular case of  $P_1$ , which can be a candidate to be a late-time de Sitter attractor without 5D-corrections ( $\Omega_\lambda = 0$ ). To analyze its stability we carry out a detailed stability study of their center manifold using the Center Manifold Theory [32].

Introducing the new variables

$$x_1 = s, x_2 = \Omega_\lambda, y_1 = x - \frac{s}{\sqrt{6}}, y_2 = y + \Omega_\lambda - 1, \quad (22)$$

and Taylor expanding the evolution equations for the new variables (22), we obtain the vector field

$$x'_1 = -x_1^2 \left( x_1 + \sqrt{6}y_1 \right) f(0) + \mathcal{O}(4), \quad (23)$$

$$x'_2 = \frac{1}{2}x_2 \left( x_1^2 + 2\sqrt{6}y_1x_1 + 6y_1^2 \right) (\gamma - 2) + 3x_2y_2\gamma + \mathcal{O}(4), \quad (24)$$

$$y'_1 = -3y_1 + \frac{1}{4} \left( -\sqrt{6}x_1(2x_2 + y_2(\gamma - 2)) - 6y_1y_2\gamma \right) + \frac{1}{24} \left( \sqrt{6}(-\gamma + 4f(0) + 2)x_1^3 + 6y_1(-3\gamma + 4f(0) + 6)x_1^2 + -6\sqrt{6}(3(\gamma - 2)y_1^2 + 2x_2y_2\gamma)x_1 + -36((\gamma - 2)y_1^3 + 2x_2y_2\gamma y_1)) \right) + \mathcal{O}(4), \quad (25)$$

and

$$y'_2 = -\frac{\gamma x_1^2}{2} + \left( x_2 - \frac{y_2\gamma}{2} \right) x_1^2 - \sqrt{6}y_1(\gamma - 1)x_1 + \sqrt{6}y_1(x_2 + y_2 - y_2\gamma)x_1 - 3y_2\gamma + -3y_2((\gamma - 2)y_1^2 + 2x_2y_2\gamma) + -3((\gamma - 2)y_1^2 + y_2^2\gamma) + \mathcal{O}(4), \quad (26)$$

where  $\mathcal{O}(4)$  denotes error terms of fourth order in the vector norm.

Accordingly to the Center Manifold theorem, the local center manifold of the origin for the vector field (23)-(26) is given by the graph

$$W_{loc}^c(\mathbf{0}) = \{(x_1, x_2, y_1, y_2) : y_1 = F(x_1, x_2), y_2 = G(x_1, x_2), x_1^2 + x_2^2 < \delta\} \quad (27)$$

where  $\delta > 0$  is a small enough real value.

Deriving each one of the functions in (27) with respect  $\tau$  one can obtain the system of quasi-linear partial differential equations

$$y'_1 - \frac{\partial F}{\partial x_1}x'_1 - \frac{\partial F}{\partial x_2}x'_2 = 0 \quad (28)$$

<sup>8</sup> We have arrived to this conclusion by making the stability analysis of its center manifold (see section II A 1 for an explicit computation).

TABLE III: Eigenvalues for the critical points of the equations system (8)-(11). We use the notation  $\beta_{\pm} = \frac{3}{4} \left( \gamma - 2 \pm \sqrt{(2-\gamma) \left( \frac{24\gamma^2}{(s^*)^2} - 9\gamma + 2 \right)} \right)$ .

| $P_i$       | $\lambda_1$               | $\lambda_2$        | $\lambda_3$           | $\lambda_4$                   |
|-------------|---------------------------|--------------------|-----------------------|-------------------------------|
| $P_1$       | 0                         | 0                  | -3                    | -3 $\gamma$                   |
| $P_2$       | 0                         | -3 $\gamma$        | 3 $\gamma$            | $\frac{3}{2}(\gamma - 2)$     |
| $P_3$       | 0                         | 3( $\gamma - 1$ )  | 3 $\gamma$            | 6 $\gamma$                    |
| $P_4^{\pm}$ | 0                         | -6                 | 6                     | 6 - 3 $\gamma$                |
| $P_5$       | 0                         | 0                  | -3                    | -3 $\gamma$                   |
| $P_6^{\pm}$ | -6                        | 6 - 3 $\gamma$     | 6 $\mp$ $\sqrt{6}s^*$ | $\mp \sqrt{6}(s^*)^2 f'(s^*)$ |
| $P_7$       | -3 $\gamma$               | $\beta_-$          | $\beta_+$             | -3 $\gamma s^* f'(s^*)$       |
| $P_8$       | $\frac{1}{2}(s^{*2} - 6)$ | $s^{*2} - 3\gamma$ | - $s^{*2}$            | - $s^{*3} f'(s^*)$            |

$$y_2' - \frac{\partial G}{\partial x_1} x_1' - \frac{\partial G}{\partial x_2} x_2' = 0. \quad (29)$$

Since we have used Taylor expansions up to third order for obtaining the system (23)-(26) we must seek a solution for (28)-(29) in the following form (see [32, 40, 41]):

$$F(x_1, x_2) = a_1 x_1^3 + a_2 x_1^2 + a_3 x_1^2 + a_4 x_1 x_2^2 + a_5 x_1 x_2 + a_6 x_2^3 + a_7 x_2^2 + \mathcal{O}(4) \quad (30)$$

$$G(x_1, x_2) = b_1 x_1^3 + b_2 x_1^2 + b_3 x_1^2 + b_4 x_1 x_2^2 + b_5 x_1 x_2 + b_6 x_2^3 + b_7 x_2^2 + \mathcal{O}(4), \quad (31)$$

as  $x_i \rightarrow 0$  where  $\mathcal{O}(4)$  is an error term of fourth order in the vector norm. Substituting expressions (30) and (31) in the equations (28)-(29), and comparing terms of equal powers, we obtain that the non-null coefficients in the above expressions (30) and (31) are

$$a_1 = \frac{f(0)}{3\sqrt{6}}, \quad a_5 = -\frac{1}{\sqrt{6}}, \quad b_2 = -\frac{1}{6}, \quad b_3 = \frac{1}{3}, \quad (32)$$

i.e.,

$$y_1 = F(x_1, x_2) = -\frac{x_1 x_2}{\sqrt{6}} + \frac{x_1^3 f(0)}{3\sqrt{6}} + \mathcal{O}(4),$$

$$y_2 = G(x_1, x_2) = -\frac{x_1^2}{6} + \frac{x_1^2 x_2}{3} + \mathcal{O}(4) \quad (33)$$

Thus, the dynamics on the center manifold, is given by

$$x_1' = -x_1^3 f(0) + \mathcal{O}(4) \quad (34)$$

$$x_2' = -x_1^2 x_2 + \mathcal{O}(4). \quad (35)$$

Neglecting the error terms, and introducing the coordinate transformation  $u_1 = x_1^2$ , the system (34)-(35) reduces to the simpler form

$$u_1' = -2u_1^2 f(0) \quad (36)$$

$$x_2' = -u_1 x_2, \quad (37)$$

where the region of physical interest is  $u_1 \geq 0, x_2 \geq 0$ .

Observe that the dynamics on the center manifold, governed by (36)-(37), depends on the value  $f(0)$ . If either  $f(0) = 0$  or  $f$  is singular at the origin, the system (36)-(37) does not represent correctly the dynamics of the center manifold. In such a case, we must incorporate higher order terms in the scheme, increasing the problem complexity. Thus, we assume that  $f(0)$  is a real number such that  $f(0) \neq 0$ .

According to the Center Manifold Theorem, the stability analysis of  $P_5$  is reduced to the analysis of the stability of the origin of the system (36)-(37). For this analysis we resort to numerical investigation. In figure 1 are displayed several orbits contained the physical region  $u_1 \geq 0, x_2 \geq 0$ . Observe that the axis are invariant sets. For  $f(0) > 0$  (see the panel (a) in figure 1), there is an open sets of orbits that converge to the origin as time goes forward; thus, the origin is asymptotic stable for initial conditions in a vicinity of the origin whenever  $f(0) > 0$ . From the asymptotic stability of the origin of (34)-(35) follows that, for  $f(0)$ , the center manifold of  $P_5$  is locally asymptotic stable, and hence, the solution  $P_5$  of the system(8)-(11) also is. Therefore,  $P_5$  with  $f(0) > 0$  corresponds to a late time de Sitter attractor. This result for RS2 brane cosmology is in a perfect agreement with the standard 4-dimensional TGR framework.

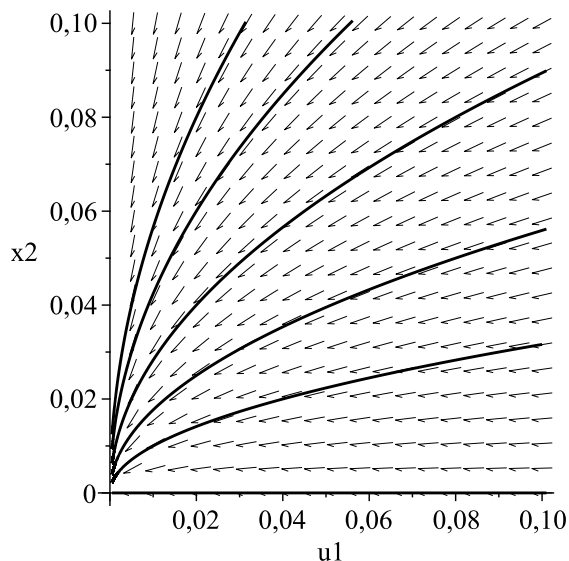

(a)

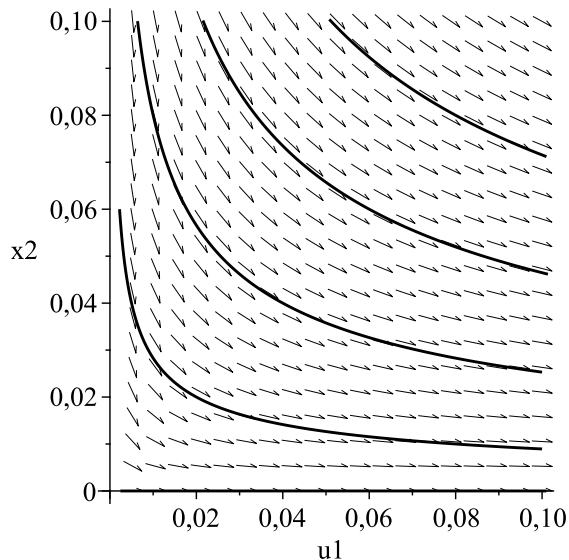

(b)

FIG. 1: Phase space of the system (36)(35) for: (a)  $f(0) = 1$  and (b)  $f(0) = -0.1$ .

## 2. Dynamics of the center manifold of $P_1$

In this section we investigate the stability of the curve of critical points  $P_1$  for  $0 < \Omega_\lambda < 1$ . This solutions correspond to a de Sitter expansion with 5D-corrections. According to the RS2 model this solution cannot behave like a late time attractor since 5D-corrections are typical of the high energy (early universe) and not for low energy (universe late) regimes. If we can prove that this solu-

tion is of saddle type, we can correlate this behavior with a transient inflationary stage for the universe. In order to verify our claim, we appeal to the Center Manifold Theory.

Let us consider an arbitrary critical point with coordinates  $(x = 0, y = 1 - u_c, \Omega_\lambda = u_c, s = 0)$  located at  $P_1$ .

In order to prepare the system (8)-(11) for the application of the Center Manifold Theorem we introduce the coordinate change

$$u_1 = -\frac{s(u_c - 1)}{\sqrt{6}}, \quad u_2 = -\Omega_\lambda - u_c(y + \Omega_\lambda - 2),$$

$$v_1 = (u_c + 1)(y + \Omega_\lambda - 1), \quad v_2 = \frac{s(u_c - 1)}{\sqrt{6}} + x. \quad (38)$$

Then, we Taylor expand the system  $u'_1, u'_2, v'_1, v'_2$  in a neighborhood of the origin with error of order  $\mathcal{O}(4)$ .

Accordingly to the Center Manifold theorem, the local center manifold of the origin for the resulting vector field is given by the graph:

$$W_{\text{loc}}^c(\mathbf{0}) = \{(u_1, u_2, v_1, v_2) : v_1 = F_1(u_1, u_2),$$

$$v_2 = G_1(u_1, u_2), u_1^2 + u_2^2 < \delta\} \quad (39)$$

for  $\delta > 0$  a small enough real value.

The functions  $F_1$  and  $G_1$  in definition (39) are a solution of a system of quasi-linear differential equations analogous to (28)-(29). This system should be solved with an error of order  $\mathcal{O}(4)$ , obtaining the functional dependence:

$$v_1 = \frac{2u_1^2 u_2 (u_c + 1)}{u_c - 1} - u_1^2 (u_c + 1),$$

$$v_2 = \frac{2(u_1^3 u_c - u_1^3 f(0))}{u_c - 1} - \frac{u_1 u_2}{u_c - 1}. \quad (40)$$

Then, the dynamics on the center manifold is given by

$$u'_1 = \frac{6u_1^3 f(0)}{u_c - 1} + \mathcal{O}(4) \quad (41)$$

$$u'_2 = 6u_c u_1^2 + \frac{6u_2(1 - 3u_c)u_1^2}{u_c - 1} + \mathcal{O}(4). \quad (42)$$

In the same way as for  $P_5$ , the dynamics of the system (41)-(42) depends on the values of  $f(0)$ . We assume that  $f(0) \in \mathbb{R} \setminus \{0\}$ . Otherwise it is required to include higher order terms in the Taylor expansion, increasing the numerical complexity.

In figure (2) are displayed some orbits in the phase space of the system (41)-(42) for the choices: (a)  $f(0) = 2$  and  $u_c = 0.5$  and (b)  $f(0) = -2$  and  $u_c = 0.5$ . The origin of coordinates is locally asymptotically unstable (of saddle type) irrespective the sign of  $f(0)$ . Henceforth, the center manifold of  $P_1$  is locally asymptotic unstable (saddle type) for  $f(0) \neq 0$ ; also is  $P_1$ .

The physical interpretation of this result is that there are not late time attractors with 5D-modifications. This type of corrections are characteristic of the early universe. In this sense the cosmological solution associated to the critical  $P_1$  correlates with the primordial inflation.

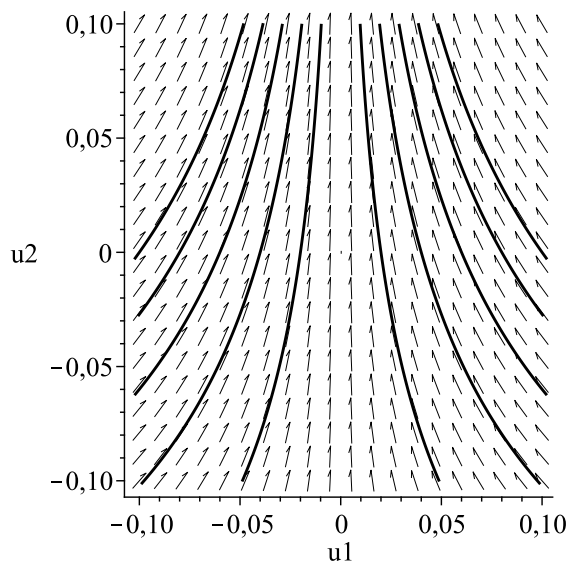

(a)

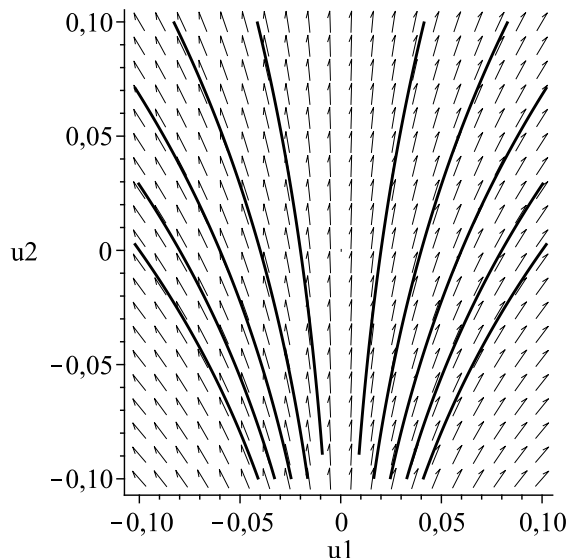

(b)

FIG. 2: Phase space of the system (41)-(42) for the choices (a)  $f(0) = 2$  and  $u_c = 0.5$  (b)  $f(0) = -2$  and  $u_c = 0.5$ . Observe that the axis  $u_1$  is a line of points of critical asymptotic unstable in both cases for initial conditions in a vicinity of the origin. The origin behaves as a saddle point.

### III. EXPONENTIAL POTENTIAL

The objective of this section is to illustrate our analytical results for the exponential potential,

$$V(\phi) = V_0 e^{-\chi\phi} + \Lambda. \quad (43)$$

This potential have been widely investigated in the literature. It was studied for quintessence models in [46] where it is considered a negative cosmological constant  $\Lambda$ . In our case of interest we assume  $\Lambda \geq 0$ , to avoid dealing with negative values of  $y$ . However we can apply our procedure by permitting negative values for  $y$  for the case  $\Lambda < 0$ . The dark energy models with exponential potential and negative cosmological constant were baptized as Quinstant Cosmologies. They were investigated in [51] using an alternative compactification scheme. The asymptotic properties of a cosmological model with a scalar field with exponential potential have been investigated in the context of the General Relativity by the authors of [26, 29], and in the context of the RS braneworlds by [34, 52]. In both cases it was studied the pure exponential potential ( $\Lambda = 0$ ). Potentials of exponential orders at infinity were studied in the context of Scalar-tensor theories and conformal  $F(R)$  theories by the authors of [30, 32].

We comment that the procedure introduced in previous sections is fairly general and can be applied to others potentials as those showed in table I. We remain in the exponential potential for simplicity. Also, we consider a pressureless (dust) background, i.e.,  $\gamma = 1$ .

The function  $f(s)$  corresponding to the potential (43) is given by

$$f(s) = -1 - \frac{\chi}{s}. \quad (44)$$

The zero of this function is

$$s^* = -\chi \quad f'(s^*) = \frac{\chi}{s^{*2}} = \frac{1}{\chi}. \quad (45)$$

Observe that for the potential (43)  $s^* f'(s^*) < 0$ . Thus, the only relevant late-time attractor should be the de Sitter solution. In fact, the critical points  $P_7$  of the table II are reduced to the single point

$$P_7 = \left( -\sqrt{\frac{3}{2}} \frac{1}{\chi}, -\frac{3}{2\chi^2}, 0, \chi \right), \quad (46)$$

which represents a saddle point in the phase space. The critical points  $P_8$  are reduced to the single one

$$P_8 = \left( -\frac{\chi}{\sqrt{6}}, 1 - \frac{\chi^2}{6}, 0, -\chi \right). \quad (47)$$

This point represents a scalar-field dominated solution ( $\Omega_\phi = 1$ ). It is a saddle point in the phase space. Observe that all the trajectories in the phase space always emerge from the point  $(x, y, \Omega_\lambda) = (0, 0, 1)$ .

In the Fig 3, we present, for different choices of the free parameters, two numerical integrations which suggest that  $P_5$  that is a de Sitter late-time attractor with an standard 4D behavior ( $\Omega_\lambda = 0$ ). However, in order to prove this claim we need to use the Center Manifold Theory. Although for the potential (43) the result in the appendix does not apply since  $f(0) = -\text{sgn}(\chi)\infty$  is not a



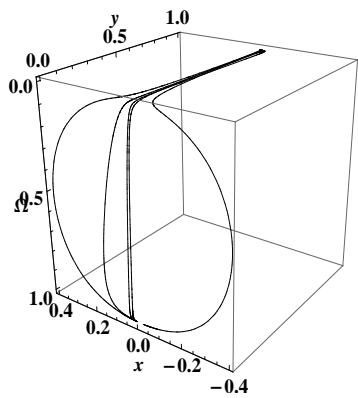

(a)

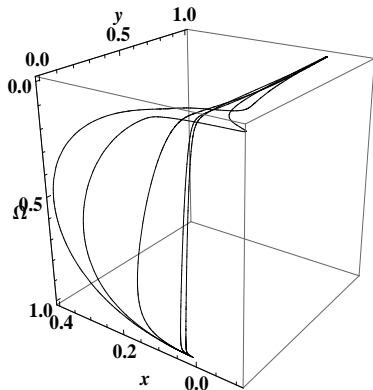

(a)

FIG. 3: Some orbits in the projection  $(x, y, \Omega_\chi)$  of the phase space for (8)-(11) and potential  $V(\phi) = V_0 e^{-\chi\phi} + \Lambda$  for the choice (a)  $(\gamma, \chi) = (1, 0.5)$ , and (b)  $(\gamma, \chi) = (1, 100)$ .

real number, we can use the same procedure as in section III to obtain the center manifold of  $P_5$  by setting from the beginning the functional form of  $f(s)$  given by (44).

For  $P_5$ , the graph of the center manifold is given, up to an error term  $\mathcal{O}(4)$ , by

$$y_1 = \frac{(\chi^2 - 1)x_1^3}{3\sqrt{6}} + \left( \frac{1}{3}\sqrt{\frac{2}{3}}x_2\chi - \frac{\chi}{3\sqrt{6}} \right) x_1^2 - \frac{x_2x_1}{\sqrt{6}},$$

$$y_2 = \frac{\chi x_1^3}{9} + \left( \frac{x_2}{3} - \frac{1}{6} \right) x_1^2 \quad (48)$$

where we have introduced the variables (22).

The dynamics on the center manifold is governed by the equations

$$x_1' = \left( 1 - \frac{\chi^2}{3} \right) x_1^3 + \chi(1 - x_2)x_1^2 + \mathcal{O}(4), \quad (49)$$

$$x_2' = -x_1^2 x_2 + \mathcal{O}(4), \quad (50)$$

defined in the phase plane  $x_1 \in \mathbb{R}, x_2 \in [0, 1]$ .

In general, the system (8)-(11) is not invariant under the change  $(s, x) \rightarrow (-s, -x)$  unless  $f(s)$  is an even function, i.e.,  $f(-s) = f(s)$ . However, in the particular case of the potential (43) we observe from (44) that the system (8)-(11) is invariant under the discrete symmetry  $(s, x, \chi) \rightarrow (-s, -x, -\chi)$ . It is easy to show that for the exponential case the symmetry  $(s, x, \chi) \rightarrow (-s, -x, -\chi)$  is induced by the discrete symmetry  $(\phi, \chi) \rightarrow (-\phi, -\chi)$ . On the other hand, for the potential (43) the function  $s(\phi)$  is given by

$$s(\phi) = \frac{V_0\chi}{V_0 + e^{\phi\chi\Lambda}}.$$

Assuming  $V_0 > 0$  and  $\Lambda > 0$  we have  $\text{sgn}(s) = \text{sgn}(\chi)$ . As we see, the function  $s(\phi)$  is not defined for all the real values, that is, the region of physical interest is restricted to one semiplane  $s \leq 0$  (or in the degenerate case  $\chi = 0$  to the hyperplane  $s = 0$ ) depending of the sign of  $\chi$ . That is,  $s$  is either positive, negative or zero, for  $\chi$  either positive, negative or zero, provided  $V_0 > 0$  and  $\Lambda > 0$ . This fact limits the application of the above discrete symmetry. In the figures (4) (a) and (4) (b) are displayed some orbits of the flow of (49)-(50) for the choice  $\chi = +0.5$ , and  $\chi = -0.5$ , respectively. In both cases, the  $x_2$ -axis is invariant so the orbits cannot cross through it, i.e., the orbits with  $s(0) \leq 0$  at the initial time, remains in the respective semiplane all the time. Also, in both figures the flow is the same, thus, the discrete symmetry  $(s, x, \chi) \rightarrow (-s, -x, -\chi)$  is preserved. However, from the physical view point, for the choice  $\chi = +0.5$  the physical region is the right semiplane ( $x_1 \equiv s > 0$ ). Thus, the physical orbits depart from the origin as the time goes forward. This means that the origin is unstable. For the choice  $\chi = -0.5$ , the physical region is the left semiplane  $x_1 \equiv s < 0$ , thus, the physical orbits approach the origin as the time goes forward.

Summarizing, for  $V_0 > 0$  and  $\Lambda > 0$  we have  $\text{sgn}(s) = \text{sgn}(\chi)$ . Thus, for the potentials (43) with  $\chi < 0$  the de Sitter solution ( $P_5$ ) is asymptotically stable. This fact is self-consistent with the condition  $f(0) = -\text{sgn}(\chi)\infty \gg 0$ ; the sufficient condition for the stability of the de Sitter solution derived in section II A 1. However, for the potentials (43) with  $\chi > 0$  the de Sitter solution is unstable (of saddle type) to perturbations in the  $s$ -direction. In this case the late-time solution is given by the asymptotic configuration  $x = 0, y = 1, \Omega_\lambda = 0, \phi \rightarrow -\infty$ .

#### IV. RESULTS AND DISCUSSION

The main results of this paper can be summarized as follows. The critical point  $P_3 = (0, 0, 1)$  represents a Big Bang singularity. According to our numerical integrations in Figs. 3, we observe that all the trajectories in the phase space, but a measure zero set, emerge from the vicinity of this point. This result agrees with the previous results obtained in [35]. In [35] the authors use another

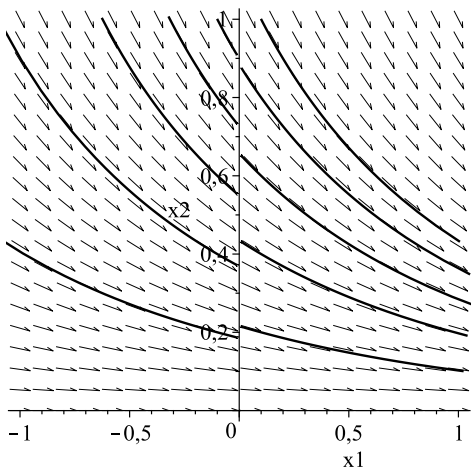

(a)

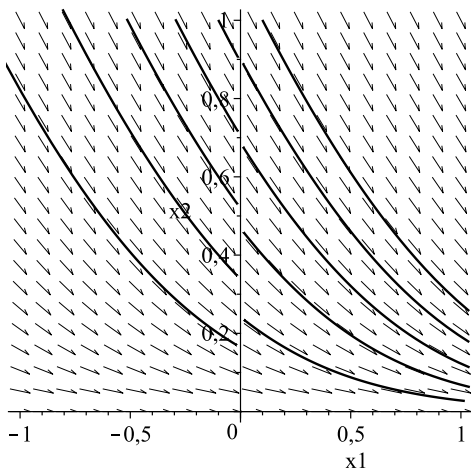

(b)

FIG. 4: Some orbits of the flow of (49)-(50) for the choices: (a)  $\chi = 0.5$ , and (b)  $\chi = -0.5$ . In both cases the  $x_2$ -axis is invariant. In (a) the physical region is the semiplane  $x_1 > 0$ ; for orbits with  $s(0) > 0$  the origin is unstable to perturbations in the  $s$ -direction. In (b) the physical region is the semiplane  $x_1 < 0$ . Thus for orbits with  $s(0) < 0$  the origin (hence  $P_5$ ) is asymptotically stable.

coordinate system, that is equivalent, except diffeomorphisms, to the system used in this paper.

In the particular case of a scalar field with potential  $V = V_0 e^{-\chi\phi} + \Lambda$  trapped in the brane, we have proved that for  $\chi < 0$  the de Sitter solution ( $P_5$ ) is asymptotically stable. However, for  $\chi > 0$  the origin, i.e.,  $P_5$  is unstable (of saddle type) and the late-time solution is given by the asymptotic configuration  $x = 0, y = 1, \Omega_\lambda = 0, \phi \rightarrow -\infty$ . This class of potentials contains the previously studied potentials in [34] with  $\Lambda = 0$ . Thus our present results generalize those in [34].

In the general case, for potentials satisfying  $f(0) \in \mathbb{R}$ ,

we have the following results. By an explicit computation of the center manifold of  $P_1$  and of  $P_5$  we prove that

- $P_1$  is locally asymptotic unstable (of saddle type) irrespectively the sign of  $f(0) \in \mathbb{R} \setminus \{0\}$ . This feature is corroborated in the Figures 2.
- $P_5$  is locally asymptotically stable for  $f(0) > 0$  and unstable (of saddle type) for  $f(0) < 0$ . This result is illustrated in the Figures 1 and 4.

The solutions dominated by the kinetic energy of the scalar field  $P_4^\pm$  and  $P_6^\pm$  behave like saddle-type solutions. This is a main difference with respect the standard 4D theory where this type of solutions are always past attractors.

In this general case, the possible late-time attractors are:

- the standard 4D de Sitter solution  $P_5$  ( $\omega_\phi = -1$ ) whenever  $f(0) > 0$ ;
- the matter-scalar-field scaling solution  $P_7$  ( $\Omega_\phi \sim \Omega_m$ ). The sufficient conditions for its asymptotic stability are  $s^* < -\sqrt{3\gamma}, f'(s^*) < 0$  or  $s^* > \sqrt{3\gamma}, f'(s^*) > 0$ ; and
- the scalar-field-dominated solution  $P_8$  ( $\Omega_\phi = 1$ ). The sufficient conditions for its asymptotic stability are  $-\sqrt{3\gamma} < s^* < 0, f'(s^*) < 0$  or  $0 < s^* < \sqrt{3\gamma}, f'(s^*) > 0$ .

## V. CONCLUSIONS

In the present paper we have investigated the phase space of the Randall-Sundrum braneworlds models with a self-interacting scalar field trapped in the brane with arbitrary potential.

From our numerical experiments we claim that  $P_3$  is associated with the Big Bang singularity type. The numerical investigation suggest that it is always the past attractor in the phase space of the Randall-Sundrum cosmological models.

Using the center manifold theory we have obtained sufficient conditions for the asymptotic stability of de Sitter solution.

We have obtained conditions on the potential for the stability of the scaling solutions as well for the stability of the scalar-field dominated solution.

We have proved, using the center manifold theory and numerical investigation, that there are not late time attractors with 5D-modifications since they are always saddle-like. This fact correlates with a transient primordial inflation.

In the particular case of a scalar field with potential  $V = V_0 e^{-\chi\phi} + \Lambda$  we have proved that for  $\chi < 0$  the de Sitter solution is asymptotically stable. However, for  $\chi > 0$  the de Sitter solution is unstable (of saddle type).

### Acknowledgments

This work was partially supported by PROMEP, DAIP, and by CONACyT, México, under grant 167335; by MECESUP FSM0806, from Ministerio de Educación de Chile; and by the National Basic Science Program (PNCB) and Territorial CITMA Project (No. 1115), Cuba. DE, CRF and GL wish to thank the MES of Cuba

for partial financial support of this investigation. YL is grateful to the Departamento de Física and the CA de Gravitación y Física Matemática for their kind hospitality and their joint support for a postdoctoral fellowship. The authors wish to thank two anonymous referees for their useful comments and for bringing our attention to several references.

- 
- [1] Lisa Randall and Raman Sundrum. An Alternative to compactification. *Phys.Rev.Lett.*, 83:4690–4693, 1999.
- [2] Rachael M. Hawkins and James E. Lidsey. Inflation on a single brane: Exact solutions. *Phys.Rev.*, D63:041301, 2001.
- [3] Greg Huey and James E. Lidsey. Inflation, brane worlds and quintessence. *Phys.Lett.*, B514:217–225, 2001.
- [4] Greg Huey and James E. Lidsey. Inflation and brane worlds: Degeneracies and consistencies. *Phys.Rev.*, D66:043514, 2002.
- [5] Pierre Binetruy, Cedric Deffayet, and David Langlois. Nonconventional cosmology from a brane universe. *Nucl.Phys.*, B565:269–287, 2000.
- [6] Pierre Binetruy, Cedric Deffayet, Ulrich Ellwanger, and David Langlois. Brane cosmological evolution in a bulk with cosmological constant. *Phys.Lett.*, B477:285–291, 2000.
- [7] Peter Bowcock, Christos Charmousis, and Ruth Gregory. General brane cosmologies and their global space-time structure. *Class.Quant.Grav.*, 17:4745–4764, 2000.
- [8] Kei-ichi Maeda. Brane quintessence. *Phys.Rev.*, D64:123525, 2001.
- [9] Shuntaro Mizuno, Kei-ichi Maeda, and Kohta Yamamoto. Dynamics of scalar field in a brane world. *Phys.Rev.*, D67:023516, 2003.
- [10] N. Yu. Savchenko and A.V. Toporensky. Scaling solutions on a brane. *Class.Quant.Grav.*, 20:2553–2562, 2003.
- [11] Shinji Tsujikawa and M. Sami. A Unified approach to scaling solutions in a general cosmological background. *Phys.Lett.*, B603:113–123, 2004.
- [12] Ricardo Garcia-Salcedo, Tame Gonzalez, Claudia Moreno, and Israel Quiros. Randall-Sundrum brane cosmology: modification of late-time cosmic dynamics by exotic matter. *Class.Quant.Grav.*, 28:105017, 2011.
- [13] Adam G. Riess, Louis-Gregory Strolger, Stefano Casertano, Henry C. Ferguson, Bahram Mobasher, et al. New Hubble Space Telescope Discoveries of Type Ia Supernovae at  $z \geq 1$ : Narrowing Constraints on the Early Behavior of Dark Energy. *Astrophys.J.*, 659:98–121, 2007.
- [14] Tamara M. Davis, E. Mortsell, J. Sollerman, A.C. Becker, S. Blondin, et al. Scrutinizing Exotic Cosmological Models Using ESSENCE Supernova Data Combined with Other Cosmological Probes. *Astrophys.J.*, 666:716–725, 2007.
- [15] W. Michael Wood-Vasey et al. Observational Constraints on the Nature of the Dark Energy: First Cosmological Results from the ESSENCE Supernova Survey. *Astrophys.J.*, 666:694–715, 2007.
- [16] Max Tegmark et al. Cosmological parameters from SDSS and WMAP. *Phys.Rev.*, D69:103501, 2004.
- [17] N. Jarosik, C.L. Bennett, J. Dunkley, B. Gold, M.R. Greason, et al. Seven-Year Wilkinson Microwave Anisotropy Probe (WMAP) Observations: Sky Maps, Systematic Errors, and Basic Results. *Astrophys.J.Suppl.*, 192:14, 2011.
- [18] D. Larson, J. Dunkley, G. Hinshaw, E. Komatsu, M.R. Nolta, et al. Seven-Year Wilkinson Microwave Anisotropy Probe (WMAP) Observations: Power Spectra and WMAP-Derived Parameters. *Astrophys.J.Suppl.*, 192:16, 2011.
- [19] E. Komatsu et al. Seven-Year Wilkinson Microwave Anisotropy Probe (WMAP) Observations: Cosmological Interpretation. *Astrophys.J.Suppl.*, 192:18, 2011.
- [20] Prabir Rudra, Ritabrata Biswas, and Ujjal Debnath. Dynamics of Modified Chaplygin Gas in Brane World Scenario: Phase Plane Analysis. *Astrophys.Space Sci.*, 339:53–64, 2012.
- [21] Pedro F. Gonzalez-Diaz. Quintessence in brane cosmology. *Phys.Lett.*, B481:353–359, 2000.
- [22] A.S. Majumdar. From brane assisted inflation to quintessence through a single scalar field. *Phys.Rev.*, D64:083503, 2001.
- [23] N.J. Nunes and Edmund J. Copeland. Tracking quintessential inflation from brane worlds. *Phys.Rev.*, D66:043524, 2002.
- [24] M. Sami and N. Dadhich. Unifying brane world inflation with quintessence. *TSPU Vestnik*, 44N7:25–36, 2004.
- [25] Edmund J. Copeland, M. Sami, and Shinji Tsujikawa. Dynamics of dark energy. *Int.J.Mod.Phys.*, D15:1753–1936, 2006.
- [26] Edmund J. Copeland, Andrew R Liddle, and David Wands. Exponential potentials and cosmological scaling solutions. *Phys.Rev.*, D57:4686–4690, 1998.
- [27] J.M. Aguirregabiria and Ruth Lazkoz. Tracking solutions in tachyon cosmology. *Phys.Rev.*, D69:123502, 2004.
- [28] Ruth Lazkoz, Genly Leon, and Israel Quiros. Quintom cosmologies with arbitrary potentials. *Phys.Lett.*, B649:103–110, 2007.
- [29] Wei Fang, Ying Li, Kai Zhang, and Hui-Qing Lu. Exact Analysis of Scaling and Dominant Attractors Beyond the Exponential Potential. *Class.Quant.Grav.*, 26:155005, 2009.
- [30] Genly Leon. On the Past Asymptotic Dynamics of Non-minimally Coupled Dark Energy. *Class.Quant.Grav.*, 26:035008, 2009.
- [31] Genly Leon, Pavel Silveira, and Carlos R. Fadrags. *Classical and Quantum Gravity: Theory, Analysis and Applications*, chapter Phase-space of flat Friedmann-Robertson-Walker models with both a scalar field coupled to matter and radiation. Nova Science Publishers,

- New York, USA, 2012. arXiv:1009.0689 [gr-qc].
- [32] Genly Leon and Carlos R. Fadrugas. *Cosmological Dynamical Systems*. LAP Lambert Academic Publishing, Saarbrücken, Germany, 2011.
- [33] Edmund J. Copeland, Seung-Joo Lee, James E. Lidsey, and Shuntaro Mizuno. Generalised cosmological scaling solutions. *Phys.Rev.*, D71:023526, 2005.
- [34] Tame Gonzalez, Tonatiuh Matos, Israel Quiros, and Alberto Vazquez-Gonzalez. Self-interacting Scalar Field Trapped in a Randall-Sundrum Braneworld: The Dynamical Systems Perspective. *Phys.Lett.*, B676:161–167, 2009.
- [35] Yoelsy Leyva, Dania Gonzalez, Tame Gonzalez, Tonatiuh Matos, and Israel Quiros. Dynamics of a self-interacting scalar field trapped in the braneworld for a wide variety of self-interaction potentials. *Phys.Rev.*, D80:044026, 2009.
- [36] David Langlois. Brane cosmology: An Introduction. *Prog.Theor.Phys.Suppl.*, 148:181–212, 2003.
- [37] Philippe Brax and Carsten van de Bruck. Cosmology and brane worlds: A Review. *Class.Quant.Grav.*, 20:R201–R232, 2003.
- [38] David Langlois. Cosmology of brane - worlds. 2004. arXiv: astro-ph/0403579
- [39] Roy Maartens. Brane world gravity. *Living Rev.Rel.*, 7:7, 2004.
- [40] Alan Coley. *Dynamical Systems and Cosmology*, volume 291 of *Astrophysics and Space Science Library*. Dordrecht-Kluwer Publishers, Dordrecht, The Netherlands, 2003.
- [41] R Tavakol. *Dynamical Systems in Cosmology*, chapter Introduction to dynamical systems, page 360. Cambridge University Press, Cambridge, UK, 2005.
- [42] Varun Sahni and Alexei A. Starobinsky. The Case for a positive cosmological Lambda term. *Int.J.Mod.Phys.*, D9:373–444, 2000.
- [43] L. Arturo Urena-Lopez and Tonatiuh Matos. A New cosmological tracker solution for quintessence. *Phys.Rev.*, D62:081302, 2000.
- [44] Varun Sahni and Li-Min Wang. A New cosmological model of quintessence and dark matter. *Phys.Rev.*, D62:103517, 2000.
- [45] Shuang-Yong Zhou. A New Approach to Quintessence and Solution of Multiple Attractors. *Phys.Lett.*, B660:7–12, 2008.
- [46] Rolando Cardenas, Tame Gonzalez, Yoelsy Leiva, Osmel Martin, and Israel Quiros. A model of the universe including dark energy accounted for by both a quintessence field and a (negative) cosmological constant. *Phys.Rev.*, D67:083501, 2003.
- [47] Philippe Brax and Jerome Martin. Quintessence and supergravity. *Phys.Lett.*, B468:40–45, 1999.
- [48] Philippe Brax and Jerome Martin. The Robustness of quintessence. *Phys.Rev.*, D61:103502, 2000.
- [49] T. Barreiro, Edmund J. Copeland, and N.J. Nunes. Quintessence arising from exponential potentials. *Phys.Rev.*, D61:127301, 2000.
- [50] Scott Foster. Scalar field cosmologies and the initial space-time singularity. *Class.Quant.Grav.*, 15:3485–3504, 1998.
- [51] Genly Leon, Yoelsy Leyva, Emmanuel N. Saridakis, Osmel Martin, and Rolando Cardenas. *Dark Energy: Theories, Developments, and Implications*, chapter Falsifying Field-based Dark Energy Models. Nova Science Publishers, New York, USA, 2010. arXiv:0912.0542 [gr-qc].
- [52] Naureen Goheer and Peter K.S. Dunsby. Exponential potentials on the brane. *Phys.Rev.*, D67:103513, 2003.