

Accelerating Radio Astronomy Cross-Correlation with Graphics Processing Units

M. A. Clark

*Harvard-Smithsonian Center for Astrophysics,
60 Garden St, Cambridge, MA 02138, USA*

P. C. La Plante

Loyola University Maryland, Baltimore, MD 21210, USA

L. J. Greenhill

*Harvard-Smithsonian Center for Astrophysics,
60 Garden St, Cambridge, MA 02138, USA*

Abstract

We present a highly parallel implementation of the cross-correlation of time-series data using graphics processing units (GPUs), which is scalable to hundreds of independent inputs and suitable for the processing of signals from “Large- N ” arrays of many radio antennas. The computational part of the algorithm, the X-engine, is implemented efficiently on Nvidia’s Fermi architecture, sustaining up to 79% of the peak single precision floating-point throughput. We compare performance obtained for hardware- and software-managed caches, observing significantly better performance for the latter. The high performance reported involves use of a multi-level data tiling strategy in memory and use of a pipelined algorithm with simultaneous computation and transfer of data from host to device memory. The speed of code development, flexibility, and low cost of the GPU implementations compared to ASIC and FPGA implementations have the potential to greatly shorten the cycle of correlator development and deployment, for cases where some power consumption penalty can be tolerated.

Keywords: Radio astronomy, Graphics Processing Units, Signal Processing, Correlation

1. Introduction

We apply graphics processing units (GPUs) to the problem of signal processing for radio astronomy. While not a classic high performance computing (HPC) application, there are now many radio astronomy applications that require in excess of $O(100)$ tera-floating-point operations per second (TFLOPS) sustained performance. The Square Kilometer Array (SKA) due to be built circa 2020, will raise the processing needs into the exascale regime [15, 4].

A typical processing pipeline consists of: digitization of the raw voltage time-series from individual antennas; cross-correlation; instrument electronics calibration and Fourier imaging reconstruction of the sky. The extreme computational cost lies predominantly in the cross-correlation stage; this requires that the signal from every antenna is correlated with every other, and scales quadratically with the number of antenna.¹ Science applications that demand high dynamic range and sensitivity in imaging drive interest in arrays of hundreds to tens of thousands of collectors (e.g., antennas). This raises the processing needs from being modest and easily manageable, into the HPC domain, e.g., the Murchison Widefield Array, currently in prototype stage in Australia will require $O(10-100)$ TFLOPS sustained for cross-correlation of configurations from 128 to 512 collectors [10].

The application of GPUs to cross-correlation is not uncharted territory: there have been several works investigating GPU use for this very purpose [7, 19, 12]. While these demonstrated that GPUs are suitable for this task, in all cases only 10–30% of the GPU’s peak performance was obtained and the problem was described as being *bandwidth bound*. This work presents an approach to cross-correlation that is catered to the deep memory hierarchy of Nvidia’s Fermi GPU. We compare the performance obtainable using both hardware- and software-managed caches, the latter of which is more familiar to GPU programmers. We find in favor of the software-managed cache, achieving up to 79% of peak performance, equating to performance in excess of 1 TFLOPS on the GeForce GTX 480. More significantly, our approach is scalable to future architectures which will likely feature a greater disparity between compute throughput and memory bandwidth.

This paper is split up as follows; in §2 we describe the cross-correlation

¹Alternative approaches that scale as $N \log N$ have been proposed [17], but cross-correlation, thus far the mainstay technique, enables greater generality in data calibration and range of scientific application.

process, specifically the FX algorithm. An overview of GPUs and previous attempts at using GPUs for this problem is given in §3. We describe our kernels in §4, where we contrast the hardware- and software-managed cache implementations. In §5 we consider performance of the integrated system where we include the overhead of PCIe transfers. We discuss the implications of our results in §7 before concluding in §8.

2. Cross-Correlation

2.1. XF and FX Correlators

The Raleigh criterion $\theta = \frac{\lambda}{d}$ states the angular resolution θ achievable through direct observation from focusing optics of diameter d observing light of wavelength λ . At the low-end, at radio frequencies, this would require optics of improbable diameter. It is thus necessary to use interferometry, in particular *synthesis imaging*, where a two-dimensional array of antennas (or *stations* of many clustered antennas) act cooperatively as a single virtual telescope, with the virtual diameter given by length of the farthest distance between the antennas (see [1] for a review of synthesis imaging). This allows an extension of the Raleigh criterion to larger physical scales.

The cross-power spectrum at frequency ν observed by the station pair i and j (known as a *baseline*) is given by

$$S_{ij}(\nu) = \int_{-\infty}^{\infty} (A_i \star A_j)(\tau) e^{-i2\pi\nu\tau} d\tau, \quad (1)$$

where A_k is the signal at station k and $(A_i \star A_j)(\tau)$ is the cross-correlation. With sufficient numbers of baselines, a detailed power spectrum representation can be obtained, from which fundamentally an image of the sky can be obtained in turn through inverse Fourier transform in the spatial domain. The above continuum formulation assumes a continuously sampled signal, whereas in reality the voltage time-series from each antenna will be digitized and sampled at a given total bandwidth B . Typical digitization precision is between two and twelve bits stored in two's complement form. The signal is then divided into F frequency channels via Fourier techniques in the time domain, where the number of channels is determined by the needs and goals of the astronomy application. The maximum total bandwidth is determined in accordance with the Nyquist-Shannon sampling theorem. The channel width $W = B/F$ is determined by the number of samples entering the time domain Fourier transform.

In radio astronomy, the processor that produces the power spectrum from an array of stations is known as the *correlator*. Historically, this would essentially compute equation 1 directly, i.e., the cross-correlation followed by the Fourier transform. Such a correlator is known as a lag correlator, or XF correlator (the X signifying cross-correlation, and the F signifying the Fourier transform). For a correlator that processes F frequency channels from N stations this scales as $O(FN^2)$.

Note, however, from the cross-correlation analogue of the convolution theorem

$$\mathcal{F}(A \star B) = (\mathcal{F}A) \times (\mathcal{F}B), \quad (2)$$

we can write the power spectrum as

$$S_{ij}(\nu) = X_i(\nu) \star X_j^\dagger(\nu), \quad (3)$$

where $X_i(\nu) = \int_{-\infty}^{\infty} A_i(\tau) e^{-i2\pi\nu\tau}$ is the Fourier transform of signal from station i . Thus, we can calculate the power spectrum from first Fourier transforming the digitized signal from each station, and then cross-multiplying the result with every other station's result at fixed frequency. Such a correlator is known as an FX correlator, where the Fourier transforming component is known as the *F-engine* and the cross-multiplying component is known as the *X-engine*. This represents a more cost efficient approach to computing the cross-power spectrum since the cost scales as $O(N \ln F)^2$ and $O(N^2)$ for the F and X components respectively. Since the number of frequency channels is essentially fixed, in the limit of large N the X-engine accounts for the bulk of the computational budget. We note an additional step between the F- and X-engines, the *corner turn* which is a reordering of data necessitated by the station independence of the F-engine, and the frequency independence of the X-engine. While this stage involves no computation, its bandwidth requirements scale as $O(BN)$ and can be a significant logistical challenge in terms of the signal routing required.

If we consider all baselines, the X-engine evaluates the sum of a series of self outer products,

$$\hat{S}(\nu) = \sum_{t=1}^I \mathbf{X}_t(\nu) \otimes \mathbf{X}_t(\nu), \quad (4)$$

²For complex-valued samples there are N (fast) Fourier transforms of length F performed, but only once every F samples, so the total cost is $O(N \ln F)$.

where $\hat{S}(\nu)$ is the correlation matrix and $\mathbf{X}_t(\nu)$ is the vector of signals from N stations signal at time t . This is evaluated independently for every frequency ν and in order to improve the signal-to-noise ratio the outer product is integrated in time over I samples.

Typically, each station records both the two orthogonal polarizations of the input signal, which thus doubles the dimension of the input vectors, hence quadrupling the cross-correlation cost. Given that the matrix \hat{S} is Hermitian, we need only calculate its lower triangular (or upper triangular) elements, corresponding to $\frac{1}{2}N(N + 1)$ correlation pairs (including the auto-correlation of self pairs along the diagonal). The rate at which this computation must take place is determined by the total signal bandwidth B , given by the product of the number of frequency channels and the channel width. Written explicitly in terms of floating point operations per second (FLOPS), the X-engine's compute requirements are

$$\text{FLOPS} = 8 \times B \times \frac{1}{2}2N(2N + 1), \quad (5)$$

where the factor 8 arises from the complex-valued multiply-accumulate operation and each of factors of 2 multiplying N arises from dual polarization. Note that at fixed total bandwidth there is no explicit dependence on the number of frequency channels.

2.2. Characterizing the X-engine

For any computational routine, the critical measure of performance obtainable is the *arithmetic intensity*, or how many floating point operations are performed per byte of information transferred. In evaluating Equation 4 we have to consider both the input and output bandwidth requirements versus the amount of computation required. To calculate each baseline, we must take the outer-product of two distinct complex-valued vectors of length two and sum the result to an accumulator. Assuming 32-bit floating point data, this requires 32 bytes of input, 32 flops (16 multiply-adds) and 64 bytes for the read and write of the accumulator. The resulting arithmetic intensity of $32/96 = 1/3$ would be disastrous for performance on current architectures, which typically have a ratio significantly greater than this to their main-memory space. This ratio will only increase with time owing to the increasing energy cost in moving data relative to operating on it [3]. Fortunately, the situation can be improved by making some simple observations:

1. If instead of considering a single baseline, we consider a “tile” of baselines of size $m \times n$,³ there is significant data reuse between the baselines and we need only load a “column” of length n and “row” of length m to satisfy all input memory requirements.
2. The output memory traffic can be suppressed by a factor of I if we do not store the accumulated result until we have completed calculations for all I samples.

This tiling strategy is illustrated in Figure 1. With these generalizations, the arithmetic intensity is given by

$$\text{Arithmetic Intensity} = \frac{32mnI}{16(m+n)I + 64mn}.$$

The value of I is determined by how long the time-series signals are integrated for; values are application dependent, but for frequency channel widths of 1 to 100 kHz and accumulation times of 1 to 10 seconds, $10^4 < I < 10^6$. At such large I we see immediately that the output memory traffic becomes negligible, and we can make the arithmetic intensity arbitrarily large through increasing the tile size. This increases the resources (e.g., registers) required as $8mn + 4(m+n)$, which imposes a practical limit upon the size of the tile.⁴ We demonstrate in §4 that this limitation can be overcome on architectures that feature a multi-level memory hierarchy, through employing a multi-level tiling strategy, where only at the smallest tile size (register level) is the matrix “filled in”, and the other levels are used to store the input vectors only, thus requiring only $4(m+n)$ storage. Obtaining high performance is thus a balancing act between maximizing arithmetic intensity and ensuring that sufficient resources are available. The computation is similar to GEMM (dense matrix multiplication) in this regard [6].

2.3. Hardware Correlators

Application Specific Integrated Circuits (ASICs) and Field Programmable Gate Arrays (FPGAs) are commonplace computing engines for large correlators. These platforms are well suited to the cross-correlation of radio astronomical time-series data because they excel at limited precision fixed-point

³Note we adopt width×height ordering notation for referring to tiles and block sizes, not the transpose (matrix notation) with the origin lying at the upper-left corner.

⁴This is actually an upper bound, since resources can be reclaimed and reused with appropriate optimization [12].

computations and (synchronous) signal routing, and because they enable fine-grained optimization of resources. Typically four to eight bits of precision is sufficient for both the Fourier transform and cross-multiplication operations, with a larger number of bits used for the accumulator to prevent overflow. ASICs offer greater power efficiency since all of the silicon is devoted specifically to the problem at hand; however, they are expensive to develop and produce. FPGAs strike a middle ground between general purpose commodity processors (e.g., Intel x86) and ASICs, being much cheaper and easier to apply in development phases than ASICs, because of their reconfigurability, while being much more power efficient than commodity processors. Almost all current radio telescopes under development plan to use FPGA correlators, e.g., [2], and it is to this platform that GPUs should be compared.

3. Graphics Processing Units

3.1. Fermi Architecture Overview

There are a multitude of overviews of the CUDA architecture and programming model, we refer the reader to the extensive literature available, e.g., [13]. Here we focus on significant changes versus previous CUDA generations and specific architecture features that are critical for our application. In the discussion that follows, we follow standard practice referring to the CPU system controlling the GPU as the *host*, and the GPU as the *device*. The program that executes on the device is the *kernel*.

Fermi provides up to 512 processing cores, arranged in units of 32, each of which is known as a streaming multiprocessor (SM). For this work we used the GeForce GTX 480, which features a Fermi GPU with 480 processing cores for a peak performance of 1345 GFLOPS (counting two floating point operations from a single fused-multiply-add operation) connected to 1.5 GiB of off-chip on-card device memory (physically located on the card containing the GPU).

The programming model is described as being SIMT – Single Instruction Multiple Threads, where each group of threads acting cooperatively is known as a *thread block*. The thread blocks have a 1-, 2- or 3-dimensional cartesian decomposition and themselves reside within a larger 1- or 2-dimensional cartesian grid. Each thread block is assigned to an SM, and depending on the resources available, multiple thread blocks can be assigned to each SM. Each thread block is then subdivided into groups of 32 threads, a *warp*, which can be treated as the SIMD (Single Instruction Multiple Data) width.

While branching can take place within a warp, such execution is serialized, and so should be avoided. The overhead for creating and destroying a thread is extremely small, with context switching being essentially free. Latency is hidden by having many more threads active than there are cores, so that any threads that are stalled waiting for instructions to complete can be replaced with threads that are ready to execute.

An overview of the Fermi memory hierarchy is provided in Figure 2. A significant change from prior generations is the addition of traditional L1 and L2 caches: the (768 KiB) L2 cache is shared by all SMs, and there is one L1 cache per SM. The shared memory, which is a software-managed cache, and L1 cache are shared from a common 64 KiB memory, and can be configured in 16/48 KiB or 48/16 KiB partitions, respectively. When a thread requests data, the request goes through L1 cache, then L2 cache, and finally off chip to the device memory. There is a pool of 32768 32-bit registers available, with a maximum of 63 registers per thread (compared to 128 on pre-Fermi CUDA GPUs). Fermi is a true load/store architecture with a unified address space, with the result that threads can no longer access shared memory operands directly, so all data must first be copied to the individual registers incurring additional instructions. Additionally, threads may load data from the texture unit cache in order to take advantage of array element interpolation or to avoid polluting the L1 cache. A feature we make use of is the free conversion (i.e., without impacting available cycles available for computation) from 8- or 16-bit integer format data to 32-bit floating point when the texture cache is used. Although not relevant for this work, there exists another small cache, local to each SM, the constant cache. This is a read-only cache, and is useful for storing read-only parameters.

Moving to off-chip device memory, while much slower than on-chip cache, its total read/write performance of 177 GB/s is much higher than current typical CPU memory. Accesses to device memory are high latency operations, and typically require a high *occupancy*, e.g., many concurrent threads, to hide this latency. Increasing the number of independent memory transactions per thread can also hide the latency through instruction level parallelism [18]. The L1 cache-line size is 128 bytes, and all memory transactions greater than this are broken down into multiple memory requests. In order to achieve close to peak performance, all memory accesses must be *coalesced*; these are obtained when either a warp, half warp or quarter warp access consecutive memory blocks of the cache line size. For sub-128 byte memory access patterns, it can be advantageous to disable the L1 cache, or to read

through the texture cache; here the L2 cache-line size of 32 bytes determines transaction granularity. For many applications the main bottleneck is the PCIe bus through which all transfers to the GPU must take place. While the PCIe 2.0 x16 specification is quoted at 8 GB/s per direction this does not account for the 8b/10b encoding used for all PCIe transfers: the actual peak data rate is 6.4 GB/s per direction. Communication over this bus can take place asynchronously, meaning that a kernel can be executing while memory transfers are taking place.

Communication between threads within a thread block takes place through the shared memory. Since the warp execution order cannot be controlled, race conditions can develop if threads simultaneously attempt to read and write to a given shared memory address. To prevent this, explicit thread synchronization is necessary, introducing additional latency which can impair performance. Shared memory addresses are divided into 32 memory banks in round-robin fashion, and to enable maximum bandwidth each thread within a warp must access a unique bank. The exception to this rule is if threads are accessing the same address, in which case a broadcast is supported. Fermi extends this to support multicast, so that multiple groups of threads can access multiple addresses simultaneously without loss of bandwidth. This functionality is critical to our kernel implementation as shall be discussed in §4.4.

3.2. Overview of Previous Work

There have been three publications of note regarding the use of GPUs for cross-correlation. The first such work [7] implemented the X-engine only, and while the performance obtained was reasonable compared to a CPU only implementation, there was little consideration for how a fully integrated correlator could be constructed, e.g., considering whether the performance could be maintained with the PCIe bus constraint. The X-engine implementation presented in [19] used similar strategies to those presented in [7] sustaining around 120 GFLOPS at $N = 32$ on an Nvidia C1060. This work additionally implemented the full FX correlator on a single GPU using the CUFFT library (which comes as part of the CUDA toolkit) for the F-engine. This approach, however, suffers from poor scalability at large N since it cannot be spread simply across multiple GPUs because of the required corner turn between the F- and X-engines. In an exhaustive comparison of X-engine performance across various multi- and many-core processors (IBM Cell, IBM BG/P, Intel Core i7, ATi Radeon 4870, Nvidia C1060) [12] found that a fully integrated

GPU X-engine solution would be bound by PCIe bus transfers, restricting performance to 243 GFLOPS (for $N = 64$) on the C1060. They found the two IBM platforms achieved a very high peak performance percentage, with the Cell the most power efficient.

All of the above implementations used memory tiling to improve arithmetic intensity. Both [7] and [19] used shared memory tiling to reduce bandwidth pressure to device memory, whereas [12] used register tiling only, reporting that shared memory tiling was detrimental to performance. In this work we show that both tiling methods are critical to achieve high performance.

4. X-engine Kernel Implementation

All performance results presented in the section and subsequently were obtained using a 64-bit Linux workstation, running Ubuntu 10.04, CUDA 3.2 and Nvidia driver version 260.19.26. The flags passed to the compiler included “-X abi=no -m32” which disables printf support in CUDA kernels and uses 32-bit pointers, respectively. We found this reduced the number of registers required, improving performance through higher occupancy .

4.1. Mapping the X-engine to the Fermi Memory Hierarchy

In Table 1 we consider the arithmetic intensity required to achieve peak performance when transferring data from each of the memory spaces available. In order to model the X-engine we assume that the accumulator operands are sourced from registers (and hence negligible), with the multiply operands sourced from the respective memory space. In this naive analysis the required intensity is given by the ratio of the peak floating point throughput (1345 GFLOPS) and the peak memory bandwidth achievable from a given memory space. This model presumes that all computation and communication can be overlapped, and neglects the overhead of actual instruction issue which cannot be overlapped, nor does it include any required pointer arithmetic, etc. As we shall see in the following results, this analysis fails to predict the required arithmetic intensity for shared memory loads; nevertheless, it serves as a guide for how to design the kernels.

If all memory traffic were to be sourced from device memory, an 8×8 register tile size would be required if a simple one-level tiling strategy is used. However, with a 63 register-per-thread limit, the maximum tile size achievable is 2×2 . Thus a multi-level tiling strategy is vital. In the second

Level	Memory space	AI	Square tile size	Resources
0	Registers	0.125	1	16 registers
1	Shared memory / L1	1	8	256 bytes
2	Device memory	7.6	210	6720 bytes
3	PCIe bus	210	-	

Table 1: The arithmetic intensity (AI) supported by a given memory space and the resulting required square tile size in a given memory space to achieve peak performance if the multiply operands are serviced from the next slowest memory space (32 bits per real word). The last column gives the amount of resources required in each of the memory spaces to achieve this tile size (assuming 32-bit floating point storage).

and third columns of Table 1 we consider the required square tile size at level i given that the memory traffic originates from level $i + 1$, and the resulting resources required to achieve this. At the registers, all data is sourced from the shared memory / L1 cache requiring a minimum thread granularity of one thread per baseline, or a register tiling of 1×1 . Since a specific thread block’s assignment is not exposed to the CUDA programmer, in moving data to shared memory / L1 cache we ignore the L2 cache, and consider next the device memory. The resulting 8×8 tile size requires 256 bytes of storage, and so is easily achievable with high occupancy since we have a 48 KiB pool of shared memory to draw upon.

To overcome the PCIe express bottleneck, the device memory tile size of 210 suggests that it will be impossible to feed the X-engine at a sustained rate for $N < 210$. However, note that for considering the full matrix, the required row is the conjugate of the column, halving the memory traffic. We delay further discussion of PCIe transfers until §5.

In terms of data ordering, we have assumed that the corner turn has been applied, i.e., the input signal “vectors” are ordered such that the station dimension runs faster than the frequency dimension, which in turn runs faster than the time dimension. Each signal consists of two complex-valued polarizations, stored as a float4 (a vector of four consecutive 32-bit floats). Thus if adjacent threads are responsible for loading signals from adjacent stations, full memory bandwidth will be obtained subject to the constraints described in §3.1.

4.2. Thread Block Mapping

Since every station must be correlated with every other, there are $\frac{1}{2}N(N+1)$ distinct baselines that must be computed (including auto-correlations). This corresponds to the lower triangular sub-matrix of $\mathbf{S}(\nu)$ and makes the mapping of thread index to global-baseline index less straightforward. Previous work deployed different strategies for dealing with this mapping: [7] allocated a full 2-dimensional grid of thread blocks, and if a thread mapped to the matrix strict upper diagonal the thread exited immediately, doing no work; [19] only allocated the correct minimum number of thread blocks, where the mapping was facilitated by a look up table stored in the GPU's constant cache. We deemed the former solution to be inelegant, since it relies on the low overhead of creating and destroying threads, and the latter approach cannot be scaled to large N because of the limited size of constant cache.

We deployed an alternative strategy where we only launch the minimum required number of thread blocks, i.e., those which lie within the lower triangular part of the matrix and calculate the global-baseline index on the fly by mapping the x -dimension of the grid index to a 2-dimensional triangular-thread-block index: the correlation matrix is tiled with squares of size $(R_x T_x \times R_y T_y)$, where $\vec{T} = (T_x, T_y)$ is the 2-dimensional thread block size, and $\vec{R} = (R_x, R_y)$ is the 2-dimensional register tiling size. We impose the constraint $R_x T_x = R_y T_y = RT$ since this simplifies the triangular packing. The grid dimensions are set to $\vec{G} = (\frac{N}{2RT}(\frac{N}{RT} + 1), F)$, where G_x is the number of required thread blocks per frequency channel and G_y is trivially mapped to the frequency dimension. The mapping from the grid index $g_x \in [0, G_x)$ to the 2-dimensional triangular block index $\vec{b} = (b_x, b_y)$ is given by

$$g_x = \frac{b_y(b_y + 1)}{2} + b_x \quad \text{with} \quad b_y \in [0, \frac{N}{RT}), \quad b_x \in [0, b_y].$$

This can be inverted by solving the quadratic equation in b_y using integer arithmetic,

$$\begin{aligned} b_y &= \lfloor -\frac{1}{2} + \sqrt{\frac{1}{4} + 2g_x} \rfloor \\ b_x &= g_x - \frac{b_y(b_y + 1)}{2}. \end{aligned}$$

This can be evaluated efficiently on the device because of the presence of the fast square-root intrinsic, and in any case need only be evaluated once

prior to the time integration. The global-baseline coordinates are given by $(i, j) = (R_x(b_x T_x + t_x), R_y(b_y T_y + t_y))$ where $\vec{t} = (t_x, t_y)$ is the 2-dimensional thread block index. The thread block division strategy is illustrated in Figure 3.

4.3. Hardware-Managed Cache Implementation

The introduction of the traditional hardware-managed L1 cache to Fermi raises the possibility of not having to use an explicit software-managed cache, which has been commonplace with CUDA applications prior to Fermi. Using a hardware-managed cache is much easier since there is no need to be concerned with explicit thread synchronization nor I/O load balancing between the threads (see §4.4). In this implementation each thread iterates through the time dimension, accumulating the result for an $R_x \times R_y$ tile of baselines in the registers, and is responsible for loading all of the data it requires. For the thread blocks which occur on the matrix diagonal, if the global thread index is located in the super-diagonal the thread exits immediately doing no work. Once the accumulation is complete the thread writes its result to device memory. In order to achieve optimum bandwidth for device-memory writes, the matrix elements are reordered into a struct of float4 arrays such that consecutive threads write 16 bytes to contiguous blocks of device memory, e.g., coalescing is achieved at the quarter-warp level. The number of float4 arrays in the struct is determined by the register tiling, e.g., for $\vec{R} = (1, 1)$ there are eight numbers thus corresponding to two float4 arrays.

To satisfy the input memory requirements each thread must perform R_x and R_y float4 (=16 bytes) loads for each row and column, respectively. Thus the size of the row read in will equal $16R_x T_x$ bytes; this will occur at maximum bandwidth when a.) the row size is a multiple of the L1 cache line size and b.) the memory transactions can be broken down into 128-byte requests at the full-, half- or quarter-warp level. All subsequent requests from this thread block for the same row will be fully cached assuming no evictions have taken place, and thus the L1 cache should automatically enable tiling in the y dimension of size T_y . When reading in the column, each warp will request $16R_y(32/T_x)$ bytes where $32/T_x$ is the number of rows that a given warp extends over. Again, these transactions will occur at full bandwidth only when this is equal to the cache-line size at the full-, half- or quarter-warp level. For almost all the tile sizes explored below the bytes requested per warp for the column load is less than the L1 cache line size, thus one would expect a drop in cache efficiency. However, other warps within the same thread block will

likely request the unused fetched components increasing the cache efficiency. Since all requests for a given column entry will originate from within the same warp, tiling occurs through an L1 broadcast to the T_x threads along the corresponding row, thus the effective tiling in the x dimension is T_x . Finally we note, that we also present results with the L1 cache disabled. We do so to quantify the improvement due to data reuse in the L1 cache. We note however, that while there is no sharing of data between warps, there is a mechanism for cooperation by memory transactions satisfied by an L2 broadcast within the warp, thus the effective bandwidth per thread can be significantly higher than the bandwidth to the L2 cache.

Kernel	$R_x \times R_y$	$T_x \times T_y$	GFLOPS		GB/s	
			L1 on	L1 off	L1 on	L1 off
1	1×1	8×8	315	322	319	328
2	1×1	16×16	411	329	423	339
3	1×1	32×32	421	337	446	358
4	1×2	16×8	600	447	458	341
5	2×1	8×16	457	201	349	154
6	2×2	8×8	559	354	288	183
7	2×2	16×16	623	384	331	204

Table 2: Performance and effective bandwidth achieved using the hardware-managed cache, both with and without the L1 cache enabled, for the range of register and thread block sizes investigated (48 KiB L1 cache mode).

In Table 2 we present the performance results for the X-engine kernel both with and without cache enabled.⁵ In generating these results we have applied rudimentary optimizations such as loop unrolling, but we note that in using the hardware-managed cache, there is little scope for optimization since we are reliant on the hardware.⁶ The results for kernels 1, 2 and 3 demonstrate performance where the register tile size is held fixed at $\vec{R} = (1, 1)$ and

⁵When designing the kernel implementation, we generally tested performance at $N = 512$, $F = 6$, and $I = 1024$. All results presented in this section correspond to these parameters, with scaling results delayed until §6.

⁶Finer grained control of the cache can be obtained at the expense of using PTX assembly, an option that has become much easier with CUDA 4.0 which allows inlined assembly instructions.

the inter-thread tile size is increased. While performance increases with increasing tile size, the improvement is very small in moving from $\vec{T} = (16, 16)$ to $\vec{T} = (32, 32)$ suggesting that the bottleneck at this point is not the device-memory bandwidth. With the cache disabled, the performance is essentially flat, showing that the improvement with increasing thread block size is due to increased data reuse. The effective memory bandwidth reported with the cache disabled is significantly higher than the L2 cache bandwidth, which we conclude is due to L2 broadcasts within a warp. In the subsequent two kernels, both rectangular register tiling and rectangular thread block sizes are used, with kernel 5 corresponding to the transpose of the kernel 4. Kernel 4 shows that increasing the register tiling improves performance to 600 GFLOPS; this shows that the L1 cache bandwidth is the limiting factor in the $\vec{R} = (1, 1)$ kernels once the device-memory bottleneck has been overcome. Its transpose, however, shows negligible improvement over the $\vec{R} = (1, 1)$ kernels; this is because in reading the row values, each thread now has to read in consecutive 32 bytes which equates to 256 bytes at the quarter-warp level. Such memory transactions are not coalesced, and incur double the number of memory transactions, vastly decreasing performance. This reduced bandwidth is most evident with the L1 cache disabled. Finally we have kernels 7 and 8, which use $\vec{R} = (2, 2)$, where it can be seen that the performance is comparable with the kernel 4 kernel. Like kernel 5, the row reads will not be coalesced since the transaction size is 256 bytes at the quarter-warp level. Thus any improvement from increasing the register tiling is offset by a reduction in device memory bandwidth.

4.4. Software-Managed Cache Implementations

We now turn our attention to using the shared memory to enable inter-thread tiling. Since all memory is explicitly managed, programming for the shared memory has the potential for much greater performance since full memory coalescing can be obtained regardless of the register tile size used. The approach can be summarized as follows: all memory load requests are undertaken cooperatively by all threads in the thread block, where some threads will load the required row, and others will load the required column. These numbers are then communicated through the shared memory before computation proceeds as before.

For a thread block of size $T_x \times T_y$ and register tiling of size $R_x \times R_y$, we require $4(R_x T_x + R_y T_y)$ real numbers. Each number should only be loaded

once, and all $T_x T_y$ threads should partake in memory transactions to maximize latency hiding. To satisfy this constraint we require that

$$\frac{4(R_x T_x + R_y T_y)}{V} = T_x T_y,$$

where V is the number of floats loaded per thread, e.g., $V = 2$ equates to each thread loading a float2. This constraint means that cannot test software-managed cache variants of kernels 2 and 3.⁷

In this approach the first $4R_x T_x / V$ threads each load the required row elements, and the remaining $4R_y T_y / V = T_x T_y - 4R_x T_x / V$ threads load in the column elements. Warp divergence does not take place because warps are never split between row and column loads. Although different warps are used to load in row and column values, warp dependent branching does not occur in the accumulation because all memory address pointers for each thread are computed prior to the accumulation loop, and are then simply iterated by a constant amount at each iteration of the loop. Full bandwidth to device memory on both row and column reads is obtained by employing a different thread ordering scheme for the memory reads from that used for the computation, this is facilitated by the shared memory to distribute the fetched data to the required threads. When the writes to and the subsequent reads from shared memory are performed, the access patterns are chosen to avoid bank conflicts, e.g., adjacent threads store 32-bit words in adjacent memory banks. When reading the required numbers back from shared memory into registers the multicast ability of the Fermi architecture is critical to ensure that full shared-memory bandwidth is achieved. As a result, the inter-thread tile size is given simply by the product $R_x T_x \times R_y T_y$.

Extra care must be taken for the thread blocks that lie on the matrix diagonal. Since all threads cooperate for the element loading, any threads that occur in the matrix super-diagonal must not exit prematurely. We simply let all threads perform all computation, but only have the threads corresponding to the diagonal and sub-diagonal actual write their result to device memory. We return to this issue of wasted computation along the matrix block diagonal in §6.1.

⁷It would be possible to admit the excluded $\vec{T} = (16, 16)$ and $\vec{T} = (32, 32)$, with $\vec{R} = (1, 1)$ parameters if we were willing to allow sub-32-bit memory transactions per thread. Another option we did not explore was to allow V to vary for the row and column loads, e.g., load in the row values using floats while loading the column values using float2s.

Kernel	$R_x \times R_y$	$T_x \times T_y$	GFLOPS			GB/s		
			Initial	Buf	Tex	Initial	Buf	Tex
8	1×1	8×8	414	562	510	53	72	65
9	1×2	16×8	771	837	818	49	54	53
10	2×1	8×16	783	852	834	50	55	54
11	2×2	8×8	801	944	1023	53	61	66
12	2×2	16×16	644	908	897	21	31	30

Table 3: Performance and bandwidth using the software-managed cache (Initial – initial implementation, Buf – double buffered shared memory, Tex – memory reads performed using texture cache, 48 KiB shared memory mode).

The performance and sustained memory bandwidth of the initial software managed cache implementations are given in Table 3 (under the heading Initial). When compared to the hardware-managed cache implementations in Table 2, we see that performance is always better using the software-managed cache for given \vec{R} and \vec{T} parameters (i.e., 1 & 8, 4 & 9, 5 & 10, 6 & 11 and 7 & 12). Note that the two rectangular tiling kernels (9 and 10) have very similar performance unlike the case for the hardware-managed cache because full memory coalescing is now obtained for both variants. Perhaps surprisingly, the performance of kernel 12 is the second slowest, despite it having the greatest inter-thread tile size and joint highest register tiling. This can be primarily attributed to the required thread synchronization between reads from and write to shared memory. Although all kernel variants require thread synchronization, because of the larger thread block size, no other thread blocks can run concurrently on the same SM, thus thread synchronization causes a large performance stall.

In looking at the achieved bandwidth by all of the software-managed kernels, we see that less than 50% of device-memory bandwidth is sustained. Since all the memory transactions should be fully coalesced, we conclude that none of the kernels are device-memory bandwidth bound at these parameters, and are either shared memory bandwidth bound, latency bound or instruction bound. Note that this measure of bandwidth measures actual bandwidth obtained into the registers and cannot be compared with that reported in Table 2 which measures the effective bandwidth due to the cache.

Each iteration of the accumulation loop requires two thread synchroniza-

tions because we must ensure that threads a.) do not write into shared memory before threads still in the previous iteration have finished reading from shared memory, and b.) do not read from shared memory until all threads have written their data into shared memory. We note that while these two conditions cannot be avoided, we can half the number of thread synchronization points by double buffering the shared memory: on even iterations of the accumulation loop we will read from buffer 0, but write to buffer 1, and vice versa for odd iterations. This double buffering combined with an additional by-hand loop unrolling by two corresponds to the performance figures presented in Table 3 entitled “Buf”. In making this change, we see a significant performance improvement for all kernels, but especially so for kernel 12, which we hypothesized previously was most bound by thread synchronization.

The final performance reported in Table 3, entitled “Tex”, is where the all memory reads are performed using the texture unit. The rationale here was not to gain benefit using the primitive cache offered through texture reads, which is generally slower than the L1 cache, but rather to use the linear interpolation unit to perform the global array indexing for free, removing the explicit pointer arithmetic from the kernel. Making this change generally proved detrimental, with the important exception of kernel 11, which increased performance to in excess of 1 TFLOPS.

In this section we have shown that using a multi-level tiling algorithm together with a software managed cache is critical for achieving maximum performance. All subsequent results will exclusively use kernel 11, since this has the best performance.

5. Bus transfers

The communication over the bus can be overlapped with kernel execution using CUDA’s asynchronous API. As long as the total time spent in communication is less than that spent in computation, the communication can in principle be hidden allowing the X-engine to operate at peak. A subtle point that has not been explicitly treated in previous work on similar applications is that the total bandwidth to device memory must be shared between the kernel and the asynchronous PCIe memory transfers [11]. This may be partly the reason that the performance reported in [12] declined when the overlapping of kernel execution and bus transfers were employed. In the present case, since the kernel is not bandwidth bound, sustaining around 37% of

peak memory bandwidth to device memory, the expectation is that there should be ample memory bandwidth to sustain both the kernel and concurrent PCIe bus transfers at maximum rate. Note this is distinct from the question as to whether the achievable PCIe bus transfer rate is fast enough to meet the data requirements of the kernel.

```

input : input_h[ $N_p$ ][ $IFN$ ] // input signal vector
output : matrix_h[ $\frac{1}{2}FN(N+1)$ ] // packed correlation matrix
allocate: buffer_d[2][ $IFN$ ] // signal vector buffers
allocate: matrix_d[ $\frac{1}{2}FN(N+1)$ ] // packed correlation matrix
// Execution pipeline
buffer_d[0] ← input_h[0];
for  $p \leftarrow 1$  to  $N_p$  do
    | matrix_d ← X-engine(matrix_d, buffer_d[( $p+1$ ) mod 2]);
    | buffer_d[ $p$  mod 2] ← input_h[ $p$ ];
    | Synchronization;
end
matrix_d ← X-engine(matrix_d, buffer_d[( $N_p+1$ ) mod 2]);
// Transfer result back to host
matrix_h ← matrix_d;

```

Algorithm 1: Integrated X-engine communications pipeline pseudocode. The suffixes `_h` and `_d` denotes memory buffers allocated on the host and device respectively. For convenience we adopt a two-dimensional array notation for the input signal vectors.

To allow overlapping of communication and computation, these operations must operate on independent data. The X-engine execution consists of a three stage pipeline: 1.) host→device transfer of data, 2.) kernel execution, and 3.) device→host transfer of the final correlation matrix. For a large enough integration length I the final transfer back to the host is a negligible contribution to the total time. Additionally we expect for many applications, it would be desirable to retain the correlation matrix on the device for further post-processing, e.g., for real-time imaging and calibration [5] or scrubbing of man-made radio interference [9]. We thus aim to overlap only the host→device transfer with the kernel execution. To this end, we break the input sample vector of length IFN into N_p sample vectors

of length $I'FN$ with $I = N_p I'$. We then loop over the N_p sample vectors, at each iteration calculating the outer-product sum and summing the result to the correlation matrix. This allows the overlap of communication and computation, since the $(p + 1)^{th}$ sample vector can be transferred to the device while the p^{th} sample vector's contribution to the correlation matrix is computed. At each iteration, explicit synchronization is enforced to prevent a race condition between the memory transfer and kernel execution. The execution pipeline is illustrated in Algorithm 1.

Figure 4 is a plot comparing the execution time of the X-engine with the host→device transfer time over the PCIe bus as a function of number of stations. (We defer the discussion of how actual performance varies as the number of stations until §6.) For a large number of stations ($N > 128$), the quadratic scaling of the X-engine ensures that the communication can be completely overlapped with computation, and the kernel can operate at peak performance. However, at small N the host→device communication time dominates the computation time resulting in severely impaired performance. This plot agrees with the prediction made in §4.1 regarding the minimum tile size $N = 105$ required to overcome the PCIe bottleneck. Without data flow reduction, the X-engine would appear to be severely bound by the PCIe bandwidth.

However, use of 32-bit floating point data is unnecessary for the X-engine. The precision of data input to the X-engine typically depends on the incidence of impulsive manmade interference. Strong interference militates for more bits (e.g., 12 bits can represent a dynamic range of $\sim 10^7$), but truncation to 8 bits is usually safe (§2.3). The kernel is easily adapted to accomodate this using the texture read mode *cudaReadModeNormalizedFloat*: 8-bit data is read through the texture cache, and is converted to the native 32-bit floating point format using the texturing hardware, i.e., without subtracting the number of cycles available for computation. Since the kernel is not device-memory bandwidth bound, this change has no effect upon the raw-kernel performance.⁸ However, it reduces by a factor of four the transfer time over the PCIe bus for the input data. The result is that communication can be hidden for $N > 16$ stations. A desirable side effect is the reduction in

⁸Such reduction in memory bandwidth requirements does potentially improve the scalability of the current algorithm (i.e., two levels of tiling) to future possible architectures where the required arithmetic intensities to achieve near peak performance would be expected to be considerably higher than current GPUs.

memory footprint allowing many more frequency channels or a longer time integration to be performed. Note the ratio of the kernel execution time to the host→device transfer time is independent of both the number of frequency channels and the integration length and so this conclusion is universal (this is only approximately true – see §6).

6. Performance Results

As stated previously all performance results utilize kernel 11, and here we additionally restrict ourselves to 8-bit input data and we shall only consider cases where the the number of stations is a power of two.

6.1. Kernel Performance

Performance versus Number of Stations. Performance increases significantly as we increase N (at fixed F), plateauing to a peak of 1058 GFLOPS, which equates to 79% of the theoretical peak performance of the GTX 480 (Figure 5). When we include the additional overhead of required auxillary instructions; e.g., load/store, thread synchronization; we find the kernel is actually operating at 91% of peak performance. To our knowledge, no other non-trivial application reaches this level of performance. At small N performance is impaired because: 1.) the correlation matrix is smaller, hence fewer threads are active; and 2.) there is a proportional increase in the amount of wasted computation performed by the thread blocks distributed along the matrix diagonal. The first of these effects can be offset by increasing the number of frequency channels to increase the number of thread blocks. This is demonstrated on Figure 5 where we see that increasing the number of frequency channels drastically improves performance at low N , while having a negligible effect at large N .

Beyond this, reduced performance at small N results from the wasted computation performed on the threads blocks which appear along the diagonal of the correlation matrix. The total or “normalized” performance is the sum of the desired and wasted computation. Here we use the largest F available at a given N to eliminate the effect of low thread occupancy. There are N/RT thread blocks along the matrix diagonal, with each thread block corresponding to $RT \times RT$ matrix elements. Thus, the additional wasted work scales as $\sim (N/RT)2RT(2RT - 1)$ (i.e., the strictly upper diagonal of the diagonal thread blocks). Since the total desired computation scales as $\sim 2N(2N + 1)$, the total computation rate including the wasted operations

is found from multiplying by $\frac{2(N+RT)}{2N+1}$.⁹ Using this normalized metric the performance is independent on the number of stations. For $N < 256$ the difference between actual and the normalized performance is appreciable, suggesting that a kernel specifically optimized for the diagonal thread blocks at small N may be worth considering.

Integration length versus Number of Frequency Channels. As described in §2.2 the effect of the integration length I upon performance is expected to become significant at small I since the output memory traffic is suppressed as I^{-1} . We illustrate this in Figure 6 where we vary F and I subject to keeping the product FI constant. This corresponds to a fixed amount of computation per input, equivalent to Equation 5 at fixed bandwidth B . The increase in F necessarily results in a shortening of the integration length, thus at some point the resulting increase in memory traffic reduces performance. Where output memory traffic is ignored we observe, owing to data parallelism, expected high performance without roll off as F is increased (I is decreased). The difference is most evident at small N since many more frequency channels are achievable.

Obtaining high performance can thus be a balancing act between increasing the concurrency for computation against the resulting increase in memory bandwidth requirements. The parameter space of our demonstration is limited by the parameters of the GTX 480. While this is not a problem for that platform at large N and supportable ranges of F , GPUs with larger memory than the GTX 480 and greater required parallelism, i.e., more cores, will exhibit pronounced roll off for larger F (smaller I) at these values of N .

Even for a fully optimized X-engine kernel, there is still further parameter tuning that must take place in order to obtain maximum performance. The locus in parameter space that results in near maximum performance would be one of many prominent factors in specification and basic system engineering of a radio telescope.

⁹This correction factor is only exact in the limit of infinite arithmetic intensity because it is only unnecessary floating point operations that are performed, no additional memory traffic is incurred. Thus at finite, but large, arithmetic intensity we expect the correction factor to be a small overcorrection.

6.2. Integrated Performance

The performance of the integrated X-engine is not affected by host→device transfer overhead for a fixed input of 1 GiB, which corresponds to around 0.2 seconds of PCIe transfer time (Figure 7). As described in Algorithm 1, the input vector of length IFN is split into N_p vectors of length $I'FN$, where we chose the kernel integration length I' to maximize performance based on the results obtained in §6.1, i.e., we chose $I' = 256, 1024, 2048, 2048$ for $N = 32, 128, 512, 2048$, respectively. In fact performance is actually higher here at $N = 32$ than in Figure 6 because the vector of data is larger, i.e., with a larger number of frequencies and a longer integration length. Only for short integration lengths, i.e., a large number of frequency channels, does the overhead of the device→host transfer become apparent. The overall shape of the curves in Figures 6 and 7 are similar because both convey the impact of bandwidth constraints (albeit from different source) for output of the correlation matrix on performance.

To interpret performance figures in the context of radio telescope system design, we have estimated the achievable correlated dual-polarization signal bandwidth as a function of the number of the stations (Figure 8). This can be used to estimate the number of GPUs required to process a total signal bandwidth given a number of stations, assuming that data for difference frequency channels can be trivially distributed among different GPUs in the context of a cluster. For example, in the case of a 128-station MWA configuration with 30.72 MHz instantaneous bandpass the X-engine processes 3.5 MHz of signal bandwidth, thus requiring 9 GPUs (GTX 480s).

7. Discussion

7.1. Comparison against other architectures

In comparison to previous GPU implementations of the cross-correlator [7, 19, 12], we have improved upon the performance by at least a factor of four. Half of this improvement can be attributed to the Fermi architecture, with the rest attributed to the multi-level tiling strategy and other fine tuned optimizations. A comparison with the wide range of platforms presented in [12], reveals that the GeForce GTX 480 running our implementation is a significant improvement over all other commodity processors, both in terms of absolute performance and performance per watt. This statement stands even in factoring improvements due to Moore’s law on other platforms since this prior work was published.

A more subtle comparison is required in consideration of FPGAs. A direct comparison against current FPGAs for cross-correlation is difficult, and one must really consider the integrated system design and engineering for a specific instrument. We take for example the correlator for a 128-station MWA, whose detailed specifications are described in [2] in the context of dual-use application to the SKAMP telescope. This uses a Virtex 4 FPGA architecture, which can process the required 30.72 MHz MWA bandwidth per signal for a power budget of 0.75 kW (X-engine only).¹⁰ In comparison, if we were to deploy a GTX 480 based X-engine, we have at a minimum $250 \text{ W} \times 9 = 2.25 \text{ kW}$ neglecting the overhead of the host system power, which further favors FPGAs. When one factors in that this FPGA correlator represents at least two-generations-old technology relative to the GTX 480,¹¹ we see that GPUs struggle to compete based on only the power metric. However, there may be longer-term factors that differ, such non-recurring costs, in development time and procurement. Radio telescope design and construction can extend over years, and engineering risk management may motivate staying at one generation behind the FPGA development curve. As well, unit costs for newly introduced FPGAs are high, and successfully developing optimized, robust bit code requires specialized engineering training and experience. In contrast, maintaining parity with the bleeding edge is more readily achievable with GPUs, where hardware unit costs are lower, hardware is intended to be commodity driven, programming leverages high-level environments (CUDA and OpenCL) that abstract much of the hardware architecture and are individually forward-backward compatible (release to release and generation to generation), and successful coding has a strong link to relatively generic parallel programming practices. Indeed, since this research was undertaken, Nvidia has launched a successor card, the GeForce GTX 580 which is 20% more power efficient in executing the X-engine. The Kepler series due at the end of 2011, and subsequent generations are expected to improve upon this metric significantly [8]. The X-engine will run efficiently on these architectures because of software compatibility, and more importantly *algorithm scalability*. Thus, an open question remains, that being whether GPUs can surpland FPGAs for cross-correlation, much as GPUs

¹⁰Here we have estimated the power consumption for a 128-station MWA by scaling the power consumption from the 512-station MWA correlator [10].

¹¹Fabrication process technology shrinks by roughly 70% every two–three years. Virtex 4 FPGAs were fabricated at 90 nm and all Fermi GPUs are fabricated at 40 nm.

have replaced GRAPE for N-body computations [16]. In this case, although the fixed-function GRAPE is more power efficient for the problem, economies of scale and high peak efficiencies obtained using GPUs essentially have made GRAPE redundant.

7.2. Future Machines

Although we have shown that current generation GPUs are extremely competitive for cross-correlation, the question that arises is whether this will hold in the future. Future GPUs will likely continue to have an exponentially increasing number of cores, with only a linear increase in memory bandwidth. The prototypical exascale machines that are currently envisaged feature a very deep memory hierarchy; obtaining high performance on such machines will require increasing the algorithmic arithmetic intensity as one moves away from the processing cores. For cross-correlation, the increased arithmetic intensity requirements can be met by employing an increased number of tiling levels. Thus, cross-correlation is likely to be one of a handful of real scientific applications of interest that will be able to harness fully at least early generation exascale machines.

8. Conclusion

We have presented an implementation of the cross-correlation algorithm using Nvidia's Fermi architecture. This application is very well matched to the architecture, and sustains in excess of 1 TFLOPS for a large number of stations (79% of theoretical peak). Key to obtaining this performance was the use of a software-managed cache and a multi-level tiling strategy. This performance can be sustained when streaming the input data over the PCIe bus. This represents a significant improvement over previous work on GPUs and comparison to other commodity platforms. While not power competitive compared to FPGA solutions, its increased flexibility and lower development costs make it an attractive solution.

With a fully optimized GPU X-engine implemented, the next step is to develop this into a full FX correlator. The design we are pursuing is a hybrid approach, utilizing an FPGA solution for the F-engine and likely a packetized switch approach for the corner turn [14].

Beyond this, future work will include increasing the efficiency of the X-engine in the small N regime. Although the work here primarily targetted the large N regime for which there are significant science drivers [10], most

current radio telescope array installations are of the small N type. By maximizing the efficiency at low N , e.g., 32 stations, this would increase the applicability of GPU computing for signal correlation today, giving a viable alternative to the usual FPGA solutions.

9. Acknowledgements

We would like to thank Nvidia for support via the Harvard CUDA Center of Excellence. This work was supported in part by the National Science Foundation grant PHY-0835713. We would like to thank D. Mitchell, S. Ord, and R. Wayth for helpful discussions. We thank Kathryn Hollar and the Harvard SEAS REU program for enabling the research that contributed to this work.

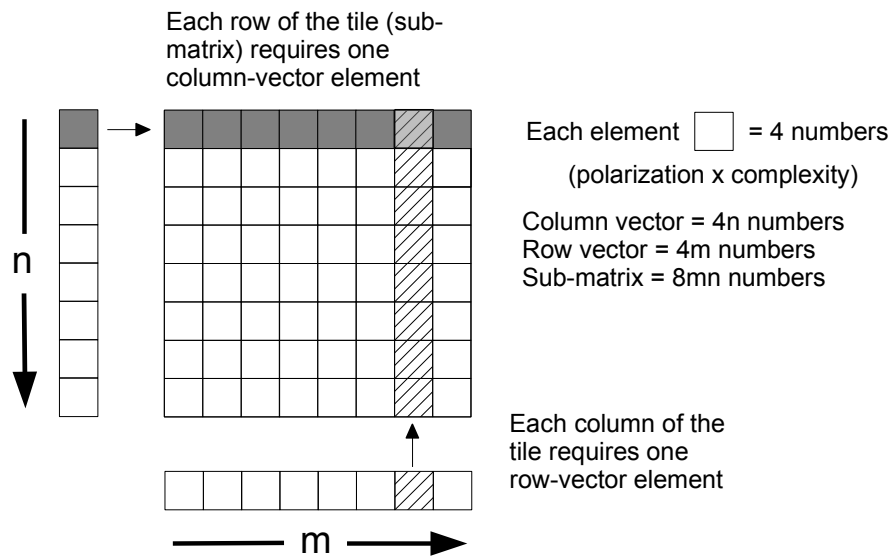

Figure 1: An illustration of the tiling strategy together with a breakdown in resources required to achieve this.

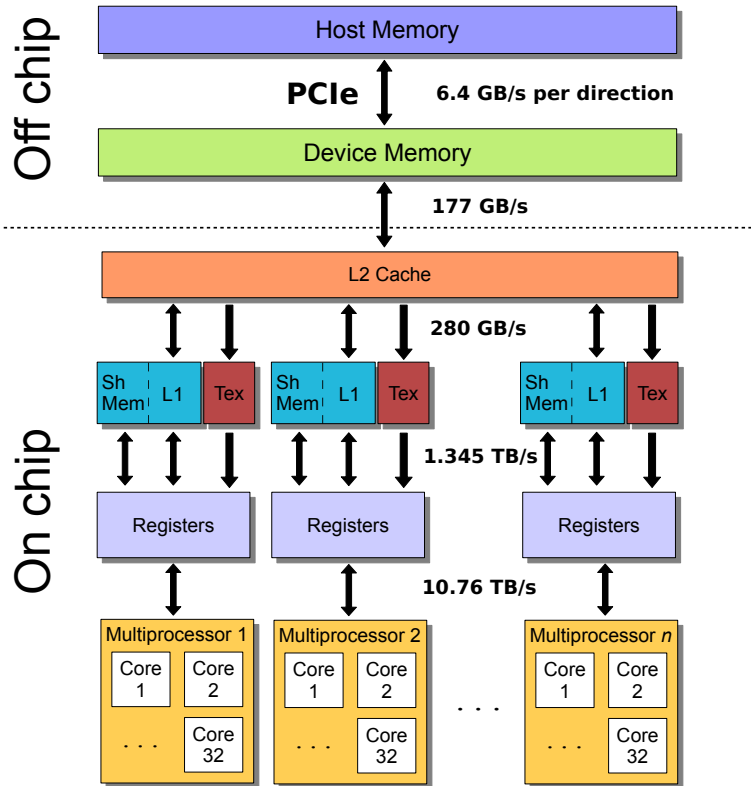

Figure 2: A schematic of the memory hierarchy of the Nvidia Fermi architecture with the peak bandwidth between each layer. All numbers quoted correspond to the aggregate bi-directional rate, with the exception of the PCIe rate which is per direction. Shared memory (Sh Mem) and L1 cache (L1) are split between a common 64 KiB cache (GeForce GTX 480, Tex = texture cache).

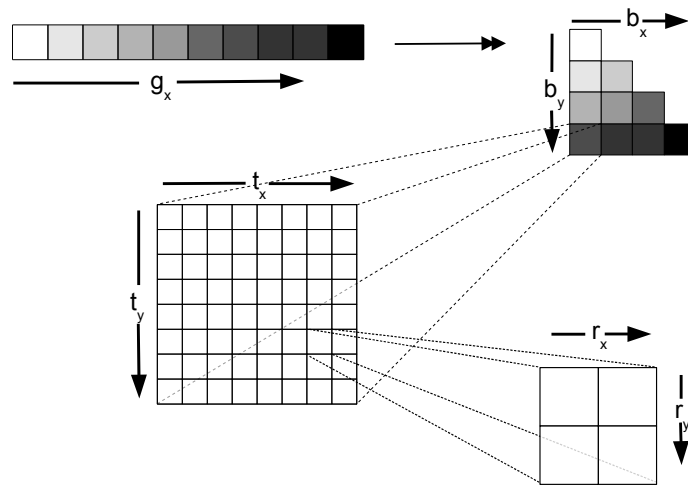

Figure 3: Schematic description of the how threads are mapped to the correlation matrix. The linear grid index g_x is mapped to the triangular block index (b_x, b_y) . Each thread (t_x, t_y) within the thread block is then responsible for calculating an $R_x \times R_y$ tile of the correlation matrix (indexed by (r_x, r_y)). The grid index g_y maps trivially to the frequency dimension (not shown).

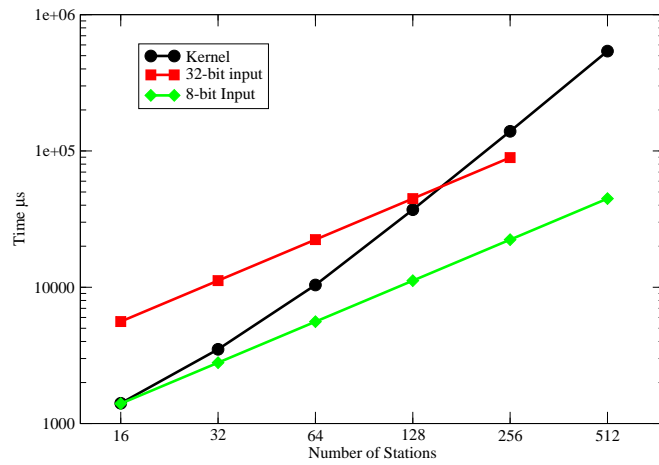

Figure 4: Kernel-only execution time, and host→device transfer time for 32-bit and 8-bit data as a function of number of stations ($F = 128, I = 1024$). With 32-bit precision, there is not enough device memory to accomodate $N = 512$ at these parameters.

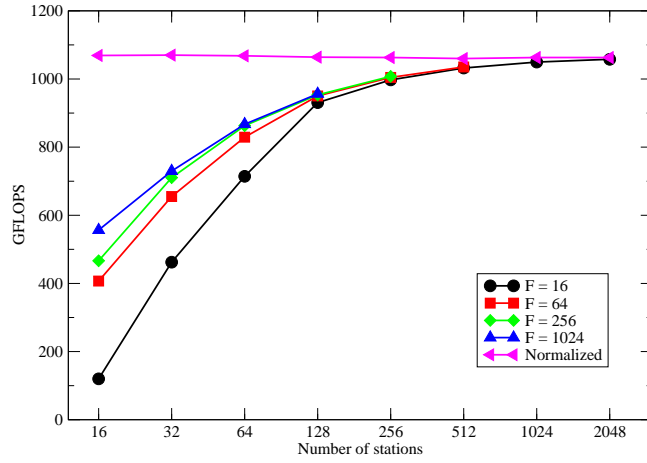

Figure 5: Performance of the X-engine as a function of the number of stations (N) and frequency channels (F) and fixed integration length $I = 1024$. Memory limitations prevent large F and N simultaneously. The magenta curve is the normalized GFLOPS including the wasted computation performed on the matrix diagonal. The slight decline in performance of the normalized values with increasing N is likely due to the quadratically increasing output memory traffic not being completely suppressed at this value of I .

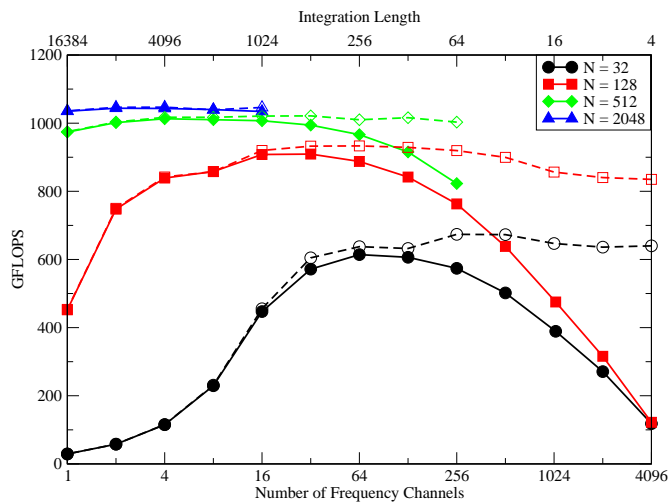

Figure 6: Performance of the X-engine kernel for a fixed volume of data (16384) per input and different numbers of stations (N). The solid curves indicate actual X-engine performance, whereas the dashed curves indicate performance with the output of the correlation matrix disabled. Memory limitations prevent the use of a shorter integration length for $N = 512$ and 2048 curves since this increases F and with it the number of correlation matrices to be output. In general as we increase the volume of data to be processed (i.e., FI), the initial increase in performance with increasing F will remain fixed, but the performance plateau and subsequent drop in performance will stretch since I^{-1} memory output suppression and F enhancement will cancel each other out.

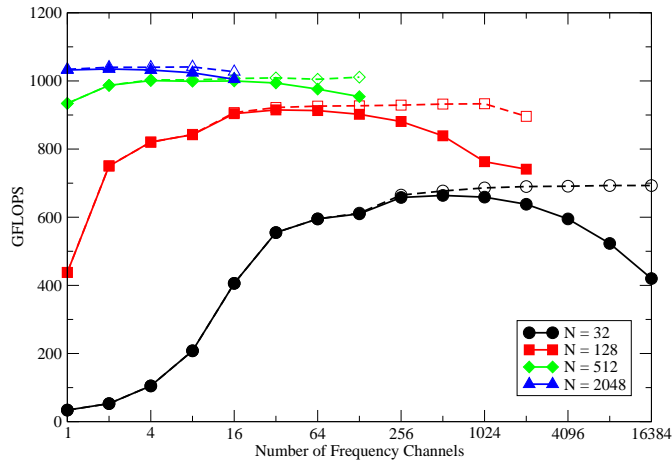

Figure 7: Performance of the integrated X-engine as a function of number of frequency channels and number of stations (N) for a fixed 1 GiB of 8-bit input data. The GPU integration length $I' = 256, 1024, 2048, 2048$ for $N = 32, 128, 512, 2048$, respectively. The solid curves indicate performance when the correlation matrix is transferred to the host, whereas the dashed curves are for when it is kept on the device.

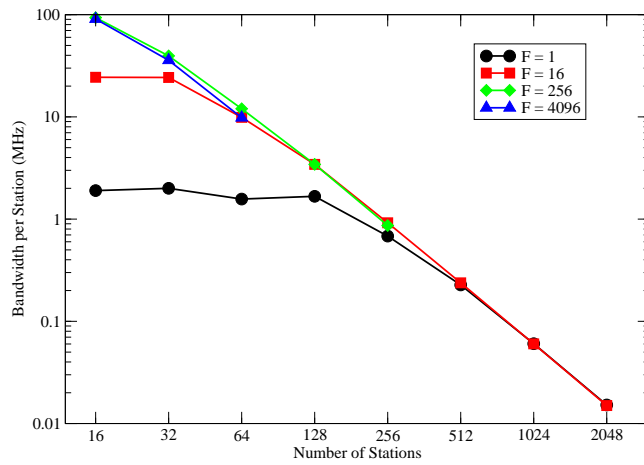

Figure 8: Bandwidth per station (assuming dual polarization) for the integrated X-engine as a function of number of stations for $F = 1, 16, 256, 4096$ with 1 GiB of 8-bit input data. The curves indicate achievable bandwidth including all PCIe bus transfers.

References

- [1] (2004). *Interferometry and Synthesis in Radio Astronomy*. Wiley-VCH.
- [2] Adams, T., J. Bunton, and M. Kesteven (2004). The square kilometre array molonglo prototype (skamp) correlator. *Experimental Astronomy 17*, 279–285. 10.1007/s10686-005-2861-y.
- [3] Bergman, K., S. Borkar, D. Campbell, W. Carlson, W. Dally, M. Denneau, P. Franzon, W. Harrod, J. Hiller, S. Karp, S. Keckler, D. Klein, R. Lucas, M. Richards, A. Scarpelli, S. Scott, A. Snavely, T. Sterling, R. S. Williams, K. Yelick, K. Bergman, S. Borkar, D. Campbell, W. Carlson, W. Dally, M. Denneau, P. Franzon, W. Harrod, J. Hiller, S. Keckler, D. Klein, P. Kogge, R. S. Williams, and K. Yelick (2008). ExaScale Computing Study: Technology Challenges in Achieving Exascale Systems Peter Kogge, Editor & Study Lead.
- [4] Cornwell, T. J. and G. van Diepen. Scaling Mount Exaflop: from the pathfinders to the Square Kilometre Array. <http://www.atnf.csiro.au/people/tim.cornwell/publications/MountExaflop.pdf>.
- [5] Edgar, R. G. et al. (2010). Enabling a High Throughput Real Time Data Pipeline for a Large Radio Telescope Array with GPUs. *Comput. Phys. Commun. 181*, 1707–1714.
- [6] Golub, G. H. and C. F. Van Loan (1996). *Matrix Computations* (third ed.), Chapter 1. John Hopkins.
- [7] Harris, C., K. Haines, and L. Staveley-Smith (2008, October). GPU accelerated radio astronomy signal convolution. *Experimental Astronomy 22*, 129–141.
- [8] Huang, J.-H. (2010, September). Keynote presentation at the GPU Technology Conference, day 1. <http://livesmooth.isteamplanet.com/nvidia100921>.
- [9] Kocz, J., F. H. Briggs, and J. Reynolds (2010, December). Radio Frequency Interference Removal through the Application of Spatial Filtering Techniques on the Parkes Multibeam Receiver. *The Astronomical Journal 140*, 2086–2094.

- [10] Lonsdale, C. J. et al. (2009). The Murchison Widefield Array: Design Overview.
- [11] Micikevicius, P. <http://forums.nvidia.com/index.php?showtopic=187442>.
- [12] Nieuwpoort, R. V. V. and J. W. Romein (2009). Using many-core hardware to correlate radio astronomy signals. In *23rd ACM International Conference on Supercomputing*.
- [13] NVIDIA (2010, 11). *NVIDIA CUDA C Programming Guide* (3.2 ed.). NVIDIA.
- [14] Parsons, A., D. Backer, A. Siemion, H. Chen, D. Werthimer, P. Droz, T. Filiba, J. Manley, P. McMahon, A. Parsa, D. MacMahon, and M. Wright (2008, November). A Scalable Correlator Architecture Based on Modular FPGA Hardware, Reuseable Gateware, and Data Packetization. *PASP 120*, 1207–1221.
- [15] Schilizzi, R. T., P. E. F. Dewdney, and T. J. W. Lazio (2008, July). The square kilometre array. In *Proceedings of SPIE*, Volume 7012.
- [16] Schive, H.-Y., C.-H. Chien, S.-K. Wong, Y.-C. Tsai, and T. Chiueh (2008). Graphic-Card Cluster for Astrophysics (GraCCA) – Performance Tests. *New Astron. 13*, 418–435.
- [17] Tegmark, M. and M. Zaldarriaga (2010, Nov). Omniscope: Large area telescope arrays with only $N \log N$ computational cost. *Phys. Rev. D 82*(10), 103501.
- [18] Volkov, V. (2010, September). Better Performance at Lower Occupancy. Presented at the GPU Technology Conference. <http://www.cs.berkeley.edu/~volkov/volkov10-GTC.pdf>.
- [19] Wayth, R. B., L. J. Greenhill, and F. H. Briggs (2009, August). A GPU-based Real-time Software Correlation System for the Murchison Widefield Array Prototype. *Publications of the Astronomical Society of the Pacific 121*, 857–865.