

SERRE PRESENTATIONS OF LIE SUPERALGEBRAS

R.B. ZHANG

ABSTRACT. An analogue of Serre's theorem is established for finite dimensional simple Lie superalgebras, which describes presentations in terms of Chevalley generators and Serre type relations relative to all possible choices of Borel subalgebras. The proof of the theorem is conceptually transparent; it also provides an alternative approach to Serre's theorem for ordinary Lie algebras.

1. INTRODUCTION

1.0.1. A well known theorem of Serre gave presentations of finite dimensional semi-simple Lie algebras in terms of Chevalley generators and Serre relations. It was generalised to Kac-Moody algebras with symmetrisable Cartan matrices by Gabber and Kac [9]. The theorem and its generalisation now provide the standard method to present simple Lie algebras and Kac-Moody algebras [14], as well as the associated quantised universal enveloping algebras [4, 12].

A natural question is how to present simple contragredient Lie superalgebras (i.e., Lie superalgebras with Cartan matrices) in a similar way. Surprisingly this was only seriously studied after quantised universal enveloping superalgebras [2] had become popular in the early 90s because of their applications in a variety of areas such as low dimensional topology [20, 29], statistical physics [2] and noncommutative geometry [22, 30, 31].

In the Lie superalgebra setting, unconventional higher order relations [19] are required beside the usual Serre relations, and their origin is somewhat mysterious. Since a Serre type presentation is always given relative to a chosen Borel subalgebra, the issue is further complicated by the fact [13, 14] that a simple contragredient Lie superalgebra admits classes of Borel subalgebras, which are not Weyl group conjugate.

1.0.2. At the present, investigation on Serre type presentations for Lie superalgebras is still rather incomplete even in the finite dimensional case. Presentations relative to many non-distinguished Borel subalgebras of such Lie superalgebras have never been constructed (see Remark 3.4). The crucial question on whether the Serre type relations obtained so far are complete (i.e., whether they are all the defining relations needed

Date: January 12, 2011.

2010 Mathematics Subject Classification. Primary 17B05; Secondary 17B20, 17B22, 17B10.

Key words and phrases. Lie superalgebras, root systems, presentations.

Supported by the Australian Research Council.

for the Lie superalgebras under consideration) has not been answered satisfactorily. Therefore, there is the need of a systematic treatment of Serre presentations for the finite dimensional simple contragredient Lie superalgebras, and this paper aims to provide such a treatment.

1.0.3. It was Leites and Serganova [19] who first obtained the higher order Serre relations for $\mathfrak{sl}_{m|n}$ relative to the so-called distinguished Borel subalgebra (for which the simple roots are the easiest to describe). The corresponding quantum relations for $U_q(\mathfrak{sl}_{m|n})$ were constructed in [24, 5]. Yamane [26] wrote down higher order quantum Serre relations for quantised universal enveloping superalgebras of finite dimensional simple Lie superalgebras for the distinguished and some (but not all) non-distinguished Borel subalgebras. In the ensuing years, much further work was done to find Serre type relations for Lie superalgebras by Leites and collaborators [6, 7, 1] and by Yamane [27].

References [6, 7] and [26, 27] represent the current state of the problem of constructing Serre type presentations for the finite dimensional simple contragredient Lie superalgebras. [Reference [27] is largely on affine superalgebras.] However, the papers [26, 27] left out presentations of exceptional simple Lie superalgebras relative to non-distinguished Borel subalgebras. Reference [6] in principle treated all the Dynkin diagrams which could potentially require higher order Serre relations, but the relations in [6] and [26, 27] look very different and it is not clear at all whether they are equivalent.

1.0.4. The problem on whether the Serre type relations constructed were complete was only investigated by computer calculations. According to [6, §1], completeness of the relations of [6] was verified by computers for finite dimensional simple contragredient Lie superalgebras, but a conceptual proof is lacking. The problem is open for the Serre type relations given in [26, 27], and so is also in the infinite dimensional case.

We comment that in the cases considered in [26], completeness of the relations can in principle be deduced from the existence of a non-degenerate invariant bilinear form between the quantised universal enveloping superalgebras of the upper and low triangular Borel subalgebras, by using Geer's result [10] that quantised universal enveloping superalgebras are trivial deformations. However, it is a highly complicated matter to establish the non-degeneracy of the bilinear form even in the case of ordinary quantised universal enveloping algebras (see, e.g., [21]). Many of the representation theoretical results required for proving the non-degeneracy are lacking for quantised universal enveloping superalgebras, rendering the super case much more difficult.

1.0.5. In this paper, we give a complete treatment of the Serre presentations of finite dimensional simple contragredient Lie superalgebras, proving an analogue of Serre's theorem relative to all possible choices of Borel subalgebras. Comparing our results with those of [26] (in the $q \rightarrow 1$ limit), we have many more higher order Serre relations which are necessary, especially in the case of exceptional Lie superalgebras relative to

non-distinguished Borel subalgebras. Our method is also different from those in the literature. It in particular automatically shows the completeness of the relations which we construct.

1.0.6. Let us now describe more precisely the results of this paper. Given a realisation of the Cartan matrix $A = (a_{ij})$ of a simple contragredient Lie superalgebra with the set of simple roots $\Pi_{\mathfrak{b}} = \{\alpha_1, \dots, \alpha_r\}$, we introduce an auxiliary Lie superalgebra $\tilde{\mathfrak{g}}$, which is generated by Chevalley generators $\{e_i, f_i, h_i \mid i = 1, 2, \dots, r\}$ subject to quadratic relations only (see Definition 3.1, where more informative notation is used). Let \mathfrak{r} be the \mathbb{Z}_2 -graded maximal ideal of $\tilde{\mathfrak{g}}$ that intersects trivially the Cartan subalgebra spanned by all h_i . Then $L := \tilde{\mathfrak{g}}/\mathfrak{r}$ is the simple Lie superalgebra which we started with in all cases except in type $A(n, n)$ where L is $\mathfrak{sl}_{n+1|n+1}$ (see Theorem 3.3).

We introduce a \mathbb{Z}_2 -graded ideal \mathfrak{s} of the auxiliary Lie superalgebra, which is generated by explicitly given generators. A main result proved in Theorem 3.10 states that $\mathfrak{s} = \mathfrak{r}$, or equivalently, $\mathfrak{g} := \tilde{\mathfrak{g}}/\mathfrak{s} \cong L$. From this result, we deduce a super analogue of Serre's theorem, Theorem 3.11, which gives presentations of the finite dimensional simple contragredient Lie superalgebras relative to all possible choices of Borel subalgebras.

The completeness of the relations in Theorem 3.11 is guaranteed by Theorem 3.10.

1.0.7. The proof of Theorem 3.10 makes use of a \mathbb{Z} -grading of $\tilde{\mathfrak{g}}$, which descends to L and \mathfrak{g} to give \mathbb{Z} -gradings to these Lie superalgebras. Write $L = \bigoplus_k L_k$ and $\mathfrak{g} = \bigoplus_k \mathfrak{g}_k$ with respect to the \mathbb{Z} -gradings. Lemma 3.8 states that $L_0 \cong \mathfrak{g}_0$ as Lie superalgebras and $L_k \cong \mathfrak{g}_k$ as \mathfrak{g}_0 -modules for all $k \neq 0$. Then Theorem 3.10 follows from this lemma.

The unconventional Serre relations can now be understood as arising from two sources: the conditions for $\mathfrak{g}_{\pm 1}$ to be irreducible \mathfrak{g}_0 -modules; and the requirement that $[\mathfrak{g}_{\pm 1}, \mathfrak{g}_{\pm 1}] = L_{\pm 2}$ and similar requirements at other degrees.

Recall that Yamane [27] used odd reflections [25] to find such relations. Leites and collaborators [19, 6] used homological algebra techniques and deduced relations from certain spectral sequences.

The approach developed here is quite different from the methods in [6, 7, 1] and in [26, 27] at both the conceptual and technical level. It has the advantage of automatically generating a complete set of relations that is minimal. Conceptually the approach is quite transparent in the sense that one can see how the defining relations arise. It also provides an alternative approach to Serre's theorem for finite dimensional semi-simple Lie algebras, see Remark 5.2.

We also note that the proof in [9] of the generalised Serre theorem for Kac-Moody algebras with symmetrisable Cartan matrices relied on structural properties of Verma modules such as their embeddings, and also made use of the quadratic Casimir operator. The authors of both [27] and [6] commented on obstacles in generalising the proof to Lie superalgebras, especially difficulties related to the quadratic Casimir operator.

We may also add that one no longer has the properties of (generalised) Verma modules required by [9] in the context of Lie superalgebras, and this appears to be a more serious difficulty.

1.0.8. The organisation of the paper is as follows. Section 2 reviews Kac's classification of finite dimensional simple classical Lie superalgebras [13], and also clarifies certain subtle points about Cartan matrices and Dynkin diagrams in this context. Section 3 contains the statements of the main results, Theorem 3.10 and Theorem 3.11, which give presentations of contragredient Lie superalgebras in arbitrary root systems. The proof of Theorem 3.10, which implies Theorem 3.11 as a corollary, is given by using the key lemma, Lemma 3.8. Sections 4 and 5 are devoted to the proof of the key lemma. An outline of the proof is given in Section 4.2 to explain its conceptual aspects. We end the paper with a discussion of possible generalisation of the method developed here to affine Kac-Moody superalgebras to construct Serre type presentations in Section 6.

Two appendices are also included. Appendix A gives the root systems and Dynkin diagrams of all simple contragredient Lie superalgebras [13, 8, 3]. The material is used throughout the paper, and is also necessary in order to make precise the description of Dynkin diagrams in non-distinguished root systems. Appendix B describes the structure of some generalised Verma modules of lowest weight type and their irreducible quotients, which enter the proof of Lemma 3.8.

Acknowledgement. I wish to thank Professor Dimitry Leites for helpful suggestions.

2. FINITE DIMENSIONAL SIMPLE LIE SUPERALGEBRAS

In this section, we present some background material, and clarify some tricky points about Cartan matrices and Dynkin diagrams of Lie superalgebras.

2.1. Finite dimensional simple Lie superalgebras. We work over the field \mathbb{C} of complex numbers throughout the paper.

2.1.1. *Classification.* A Lie superalgebra \mathfrak{g} is a \mathbb{Z}_2 -graded vector space $\mathfrak{g} = \mathfrak{g}_0 \oplus \mathfrak{g}_1$ endowed with a bilinear map $[\ , \] : \mathfrak{g} \times \mathfrak{g} \longrightarrow \mathfrak{g}$, $(X, Y) \mapsto [X, Y]$, called the Lie superbracket, which is homogeneous of degree 0, graded skew-symmetric and satisfies the super Jacobian identity. The even subspace \mathfrak{g}_0 of a Lie superalgebra $\mathfrak{g} = \mathfrak{g}_0 \oplus \mathfrak{g}_1$ is a Lie algebra in its own right, which is called the even subalgebra of \mathfrak{g} . The odd subspace \mathfrak{g}_1 forms a \mathfrak{g}_0 -module under the restriction of the adjoint action defined by the Lie superbracket. If \mathfrak{g}_0 is a reductive Lie algebra and \mathfrak{g}_1 is a semi-simple \mathfrak{g}_0 -module, \mathfrak{g} is called *classical* [13, 23].

The classification of the finite dimensional simple Lie superalgebras was completed in the late 70s. The theorem below is taken from [13], which is still the best reference on Lie superalgebras. Historical information and further references on the classification can be found in [16, 17] (also see [23]).

Theorem 2.1. *The finite dimensional simple classical Lie superalgebras comprise of the simple contragredient Lie superalgebras*

$$A(m,n), \quad B(0,n), \quad B(m,n), \quad m > 0, \quad C(n), \quad n > 2, \quad D(m,n), \quad m > 1, \\ F(4), \quad G(3), \quad D(2,1;\alpha), \quad \alpha \in \mathbb{C} \setminus \{0, -1\},$$

and simple strange Lie superalgebras $P(n)$ and $Q(n)$ ($n \geq 1$).

The simple contragredient Lie superalgebras admit non-degenerate invariant bilinear forms, while the strange Lie superalgebras $P(n)$ and $Q(n)$ do not. In the remainder of the paper, we shall consider only contragredient simple Lie superalgebras.

The A , B , C and D series are essentially the special linear and orthosymplectic Lie superalgebras, which are familiar examples of Lie superalgebras. The exceptional Lie superalgebras $F(4)$, $G(3)$ and $D(2,1;\alpha)$ are less well-known, but one can understand their structures given the description of their roots in Appendix A.1.

Let $\mathfrak{g} = \mathfrak{g}_{\bar{0}} \oplus \mathfrak{g}_{\bar{1}}$ be a simple contragredient Lie superalgebra, and choose a Cartan subalgebra \mathfrak{h} for \mathfrak{g} , which by definition is just a Cartan subalgebra of $\mathfrak{g}_{\bar{0}}$. Denote by \mathfrak{g}_{α} the root space of the root α , and call α even (resp. odd) if $\mathfrak{g}_{\alpha} \subset \mathfrak{g}_{\bar{0}}$ (resp. $\mathfrak{g}_{\alpha} \subset \mathfrak{g}_{\bar{1}}$). Denote by Δ_0 and Δ_1 the sets of the even and odd roots respectively, and set $\Delta = \Delta_0 \cup \Delta_1$. Let $(\cdot, \cdot) : \mathfrak{h}^* \times \mathfrak{h}^* \rightarrow \mathbb{C}$ denote the Weyl group invariant non-degenerate symmetric bilinear form on \mathfrak{h}^* , where the Weyl group of \mathfrak{g} is by definition the Weyl group of $\mathfrak{g}_{\bar{0}}$. A root β will be called isotropic if $(\beta, \beta) = 0$. Note that all isotropic roots are odd.

A Borel subalgebra of \mathfrak{g} is a maximal soluble Lie super subalgebra containing a Borel subalgebra of $\mathfrak{g}_{\bar{0}}$. A new feature in the present context is that Borel subalgebras are not always conjugate under the Weyl groups. All the conjugacy classes of Borel subalgebras were given in [13, pp. 51-52] [14, Proposition 1.2]. In particular, Kac described a particularly convenient Borel subalgebra, which he called distinguished, for each simple contragredient Lie superalgebra. We shall call a root system with the set of simple roots determined by this Borel subalgebra the *distinguished root system*. In this case, there exists only one odd simple root.

2.1.2. Cartan matrices and Dynkin diagrams. The precise forms of the Cartan matrices and Dynkin diagrams will be crucial in Section 3. However, there do not exist canonical definitions for them in the Lie superalgebra setting, thus we spell out the details of our definitions here.

Let $\Pi_{\mathfrak{b}} = \{\alpha_1, \alpha_2, \dots, \alpha_r\}$ be the set of simple roots of a simple contragredient Lie superalgebra \mathfrak{g} relative to a Borel subalgebra \mathfrak{b} . The Cartan matrix and Dynkin diagram provide a convenient way to describe $\Pi_{\mathfrak{b}}$. We define a Cartan matrix in the following way. Denote by $\Theta \subset \{1, 2, \dots, r\}$ the subset such that $\alpha_t \in \Delta_1$ for all $t \in \Theta$. Let l_m^2 be the minimum of $|(\beta, \beta)|$ for all non-isotropic $\beta \in \Delta$ if $\mathfrak{g} \neq D(2,1;\alpha)$. If \mathfrak{g} is $D(2,1;\alpha)$, let l_m^2 be the minimum of all $|(\beta, \beta)| > 0$ ($\beta \in \Delta$), which are independent of the arbitrary

parameter α . Let

$$\kappa = \begin{cases} 0, & \text{if } \mathfrak{g} \text{ is of type } B, \\ 1, & \text{otherwise;} \end{cases} \quad d_i = \begin{cases} \frac{(\alpha_i, \alpha_i)}{2}, & \text{if } (\alpha_i, \alpha_i) \neq 0, \\ \frac{l_m^2}{2\kappa}, & \text{if } (\alpha_i, \alpha_i) = 0. \end{cases}$$

Introduce the matrices

$$B = (b_{ij})_{i,j=1}^r, \quad b_{ij} = (\alpha_i, \alpha_j), \\ D = \text{diag}(d_1, \dots, d_r),$$

then the Cartan matrix A associated to the set of simple roots $\Pi_{\mathfrak{b}}$ is defined by

$$(2.1) \quad A = D^{-1}B.$$

When it is necessary to indicate the dependence on Θ , we write (A, Θ) for the Cartan matrix.

Note that if α_i is non-isotropic, $a_{it} = \frac{2(\alpha_i, \alpha_t)}{(\alpha_i, \alpha_i)}$ is a non-positive integer for all t . However, if α_t is isotropic, then $a_{tj} = \frac{2}{l_m}(\alpha_t, \alpha_j)$ can be an integer of any sign or zero (except in type $D(2, 1; \alpha)$). If $b_{ij} \neq 0$, we define

$$(2.2) \quad \text{sgn}_{ij} = \text{sign of } b_{ij}.$$

As we shall see in Section 2.2, these signs provide the additional information required to recover a Cartan matrix from its Dynkin diagram.

Remark 2.2. Our definition of the Cartan matrix differs from the usual one due to Kac [13]. In Kac's definition, if $b_{ss} = 0$, then $d_s = (\alpha_s, \alpha_{s+k})$ for the smallest k such that $d_s \neq 0$. Note that in our definition, none of the signs sgn_{ij} is lost.

The Dynkin diagram associated with (A, Θ) consists of r nodes, which are connected by lines. The i -th node is coloured white if $i \notin \Theta$, black if $i \in \Theta$ but α_i is not isotropic, and grey if α_i is isotropic.

If (A, Θ) is of type $D(2, 1; \alpha)$, the Dynkin diagram is obtained by simply connecting the i -th and j -th nodes by one line if $a_{ij} \neq 0$ and write b_{ij} at the line.

In all other cases, we join the i -th and j -th nodes by n_{ij} lines, where

$$n_{ij} = \max(|a_{ij}|, |a_{ji}|), \quad \text{if } a_{ii} + a_{jj} \geq 2; \\ n_{ij} = |a_{ij}|, \quad \text{if } a_{ii} = a_{jj} = 0.$$

When the i -th and j -th nodes are not both grey, say, the i -th one is not grey, and connected by more than one lines, we draw an arrow pointing to the j -th node if $-a_{ij} = 1$ and pointing to the i -th node if $-a_{ij} > 1$.

The Dynkin diagrams of the simple contragredient Lie superalgebras are given in the tables in Appendix A.2.

2.2. Comments on Dynkin diagrams. From the Cartan matrices in our definition, one can recover the corresponding root systems. Dynkin diagrams also uniquely represent Cartan matrices, except in the cases of $\mathfrak{osp}_{4|2}$ and $\mathfrak{sl}_{2|2}$. The Dynkin diagrams of these superalgebras relative to the distinguished root systems are exactly the same, but the two Lie superalgebras are non-isomorphic.

This problem can be resolved by incorporating the signs sgn_{ij} into the Dynkin diagram, e.g., by placing sgn_{ij} at the line(s) connecting two grey nodes i and j . Then the modified Dynkin diagram are respectively given by

$$(2.3) \quad \mathfrak{sl}_{2|2}: \quad \overset{-}{\circ} \text{---} \overset{+}{\bullet} \text{---} \circ, \quad \mathfrak{osp}_{4|2}: \quad \overset{-}{\circ} \text{---} \overset{-}{\bullet} \text{---} \circ.$$

As we shall see, the signs enter the construction of higher order Serre relations.

In this paper we did not include the additional information of these signs in the definition of Dynkin diagrams, as they would make the diagrams look cumbersome. Also, there is no ambiguity about the signs in all the other Dynkin diagrams.

Similar signs were also discussed in [27].

Recall that if we remove a subset of vertices (i.e., nodes) and all the edges connected to these vertices from a Dynkin diagram of a semi-simple Lie algebra, we obtain the Dynkin diagram of another semi-simple Lie algebra of a smaller rank. This corresponds to taking regular subalgebras. In the context Lie superalgebras, the notion of regular subalgebras still exists, but some explanation is required at the level of Dynkin diagrams.

Definition 2.3. Call a sub-diagram Γ' of a Dynkin diagram Γ *full* if for any two nodes i and j in Γ' , the edges between them in Γ , the arrows on the edges, and also the b_{ij} labels of the edges when Γ is of type $D(2, 1; \alpha)$, are all present in Γ' .

Consider for example the Dynkin diagram

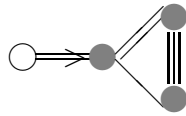

of $F(4)$, which has the following full sub-diagrams beside others:

$$(2.4) \quad \overset{\Rightarrow}{\circ} \text{---} \bullet \text{---} \bullet, \quad \bullet \text{---} \bullet \text{---} \bullet.$$

Note that none of these appears in Tables 1 and 2.

The reason is that the sub-matrices in the Cartan matrix of $F(4)$ associated with these full sub-diagrams are not Cartan matrices in the strict sense. The problem lies in the definition of a_{ij} when the node i is grey, which involves the number l_m . The l_m for $F(4)$ is not the correct ones for the full sub-diagrams. By properly renormalising the bilinear forms on the weight spaces associated with them, the full sub-diagrams can be cast into the form



which are respectively Dynkin diagrams for $\mathfrak{sl}_{3|1}$ and $\mathfrak{sl}_{2|1}$.

We call the Dynkin diagrams in Table 1 and Table 2 standard, and the ones like those in (2.4) non-standard.

We mention that if a Lie superalgebra \mathfrak{g} is contained as a regular subalgebra in another Lie superalgebra, defining relations of \mathfrak{g} can in principle be extracted from relations of the latter by considering sub-diagrams of Dynkin diagrams. However, this involves subtleties, as we have just discussed, and requires more care than hitherto exercised in the literature.

3. PRESENTATIONS OF LIE SUPERALGEBRAS

In this section, we generalise Serre's theorem for semi-simple Lie algebras to contragredient Lie superalgebras, obtaining presentations for the Lie superalgebras in terms of Chevalley generators and defining relations.

3.1. An auxiliary Lie superalgebra. We start by defining an auxiliary Lie superalgebra following the strategy of [15]. Let (A, Θ) with $A = (a_{ij})_{i,j=1}^r$ be the Cartan matrix of one of the simple contragredient Lie superalgebras relative to a given Borel subalgebra \mathfrak{b} . Let $\Pi_{\mathfrak{b}}$ be the set of simple roots relative to this Borel subalgebra.

Definition 3.1. Let $\tilde{\mathfrak{g}}(A, \Theta)$ be the Lie superalgebra generated by homogeneous generators e_i, f_i, h_i ($i = 1, 2, \dots, r$), where e_s, f_s for all $s \in \Theta$ are odd while the rest are even, subject to the following relations

$$(3.1) \quad \begin{aligned} [h_i, h_j] &= 0, \\ [h_i, e_j] &= a_{ij}e_j, \quad [h_i, f_j] = -a_{ij}f_j, \\ [e_i, f_j] &= \delta_{ij}h_i, \quad \forall i, j. \end{aligned}$$

Let $\tilde{\mathfrak{n}}^+$ (resp. $\tilde{\mathfrak{n}}^-$) be the subalgebra generated by all e_i (resp. all f_i) subject to the relevant relations, and $\mathfrak{h} = \bigoplus_{i=1}^r \mathbb{C}h_i$, the Cartan subalgebra. Then it is well known and easy to prove (following the reasoning of [15, §1]) that $\tilde{\mathfrak{g}}(A, \Theta) = \tilde{\mathfrak{n}}^+ \oplus \mathfrak{h} \oplus \tilde{\mathfrak{n}}^-$. The Lie superalgebra is graded $\tilde{\mathfrak{g}}(A, \Theta) = \bigoplus_{v \in Q} \tilde{\mathfrak{g}}_v$ by $Q = \mathbb{Z}\Pi_{\mathfrak{b}}$, with $\tilde{\mathfrak{g}}_0 = \mathfrak{h}$. Note that $\tilde{\mathfrak{n}}_v^+$ (resp. $\tilde{\mathfrak{n}}_v^-$) is zero unless $v \in Q_{\mathbb{N}}$, where $\mathbb{N} = \{1, 2, \dots\}$ and $Q_{\mathbb{N}} = \mathbb{N}\Pi_{\mathfrak{b}}$, that is,

$$(3.2) \quad \tilde{\mathfrak{n}}^+ = \bigoplus_{v \in Q_{\mathbb{N}}} \tilde{\mathfrak{n}}_v^+, \quad \tilde{\mathfrak{n}}^- = \bigoplus_{v \in Q_{\mathbb{N}}} \tilde{\mathfrak{n}}_{-v}^-.$$

Let $\mathfrak{r}(A, \Theta)$ be the maximal \mathbb{Z}_2 -graded ideal of $\tilde{\mathfrak{g}}(A, \Theta)$ that intersects \mathfrak{h} trivially. Set $\mathfrak{r}^{\pm} = \mathfrak{r}(A, \Theta) \cap \tilde{\mathfrak{n}}^{\pm}$. Then $\mathfrak{r}(A, \Theta) = \mathfrak{r}^+ \oplus \mathfrak{r}^-$. The following fact follows from the maximality of $\mathfrak{r}(A, \Theta)$.

Lemma 3.2. *Let $\Sigma = \Sigma^+ \cup \Sigma^-$ with $\Sigma^{\pm} \subset \tilde{\mathfrak{n}}^{\pm}$ be a subset of $\tilde{\mathfrak{g}}(A, \Theta)$ consisting of homogeneous elements. If $[f_i, \Sigma^+] \subset \mathbb{C}\Sigma^+$ and $[e_i, \Sigma^-] \subset \mathbb{C}\Sigma^-$ for all i , then $\Sigma \subset \mathfrak{r}(A, \Theta)$.*

Proof. The given conditions on Σ imply that the ideal generated by $\mathfrak{r}(A, \Theta) \cup \Sigma$ intersects \mathfrak{h} trivially, hence must be equal to $\mathfrak{r}(A, \Theta)$ by the maximality of the latter. \square

In particular, if $X^\pm \in \tilde{\mathfrak{n}}^\pm$ satisfy $[f_i, X^+] = 0$, and $[e_i, X^-] = 0$ for all i , then they belong to $\tilde{\mathfrak{n}}^\pm$ respectively.

Let us define the Lie superalgebra

$$L(A, \Theta) := \frac{\tilde{\mathfrak{g}}(A, \Theta)}{\mathfrak{r}(A, \Theta)}.$$

We have the following result.

Theorem 3.3. *Let \mathfrak{g} be a finite dimensional simple contragredient Lie superalgebra, and let (A, Θ) be the Cartan matrix of \mathfrak{g} relative to a given Borel subalgebra. Then $L(A, \Theta)$ is isomorphic to \mathfrak{g} unless $\mathfrak{g} = A(n, n)$, and in the latter case $L(A, \Theta) \cong \mathfrak{sl}_{n+1|n+1}$.*

Proof. This follows from Kac's classification [13] of the simple contragredient Lie superalgebras (see Theorem 2.1) except in the case of $A(n, n)$. In the latter case, we have $\det A = 0$. Therefore, $L(A, \Theta)$ contains a 1-dimensional center, and the quotient of $L(A, \Theta)$ by the center is $A(n, n)$. Hence $L(A, \Theta)$ is isomorphic to $\mathfrak{sl}_{n+1|n+1}$. \square

3.2. Main theorem.

3.2.1. *Standard and higher order Serre elements.* Let us first define some elements of $\tilde{\mathfrak{g}}(A, \Theta)$, which will play a crucial role in studying the presentation of Lie superalgebras.

Call the following elements the *standard Serre elements*:

$$\begin{aligned} & (ad_{e_i})^{1-a_{ij}}(e_j), \quad (ad_{f_i})^{1-a_{ij}}(f_j), \quad \text{for } i \neq j, \text{ with } a_{ii} \neq 0 \text{ or } a_{ij} = 0; \\ & [e_s, e_s], \quad [f_s, f_s], \quad \text{for } a_{ss} = 0. \end{aligned}$$

We also introduce *higher order Serre elements* if the Dynkin diagram of (A, Θ) contains full sub-diagrams of the following kind:

- (1) $\begin{array}{c} j \quad t \quad k \\ \times \text{---} \bullet \text{---} \times \end{array}$ with $\text{sgn}_{jt} \text{sgn}_{tk} = -1$, the associated higher order Serre elements are

$$[e_t, [e_j, [e_t, e_k]]], \quad [f_t, [f_j, [f_t, f_k]]];$$

- (2) $\begin{array}{c} j \quad t \quad k \\ \times \text{---} \bullet \text{---} \circ \end{array}$, the associated higher order Serre elements are

$$[e_t, [e_j, [e_t, e_k]]], \quad [f_t, [f_j, [f_t, f_k]]];$$

- (3) $\begin{array}{c} j \quad t \quad k \\ \times \text{---} \bullet \text{---} \bullet \end{array}$, the associated higher order Serre elements are

$$[e_t, [e_j, [e_t, e_k]]], \quad [f_t, [f_j, [f_t, f_k]]];$$

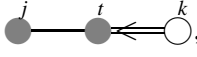
- (4) , the associated higher order Serre elements are
- $$[[e_j, e_t], [[e_j, e_t], [e_t, e_k]]],$$
- $$[[f_j, f_t], [[f_j, f_t], [f_t, f_k]]];$$

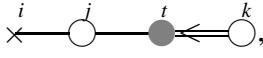
- (5) , the associated higher order Serre elements are
- $$[[e_i, [e_j, e_t]], [[e_j, e_t], [e_t, e_k]]],$$
- $$[[f_i, [f_j, f_t]], [[f_j, f_t], [f_t, f_k]]];$$

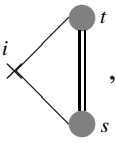
- (6) , the associated higher order Serre elements are
- $$[e_t, [e_s, e_i]] - [e_s, [e_t, e_i]],$$
- $$[f_t, [f_s, f_i]] - [f_s, [f_t, f_i]];$$

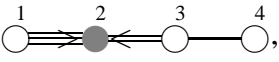
- (7) , which is a Dynkin diagram of $F(4)$, the associated higher order Serre elements are

$$[E, [E, [e_2, [e_3, e_4]]]],$$

$$[F, [F, [f_2, [f_3, f_4]]]],$$

where $E = [[e_1, e_2], [e_2, e_3]]$ and $F = [[f_1, f_2], [f_2, f_3]]$;

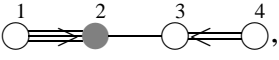
- (8) , which is a Dynkin diagram of $F(4)$, the associated higher order Serre elements are

$$[[e_1, e_2], [[e_2, e_3], [e_3, e_4]] - [[e_2, e_3], [[e_1, e_2], [e_3, e_4]]],$$

$$[[f_1, f_2], [[f_2, f_3], [f_3, f_4]] - [[f_2, f_3], [[f_1, f_2], [f_3, f_4]]];$$

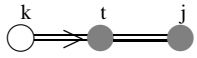
- (9) , which only appears in Dynkin diagrams of $F(4)$, the associated higher order Serre elements are

$$[e_t, [e_j, [e_t, e_k]]],$$

$$[f_t, [f_j, [f_t, f_k]]];$$

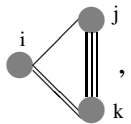
- (10) , which only appears in one of the Dynkin diagrams of $F(4)$,

the associated higher order Serre elements are

$$2[e_i, [e_k, e_j]] + 3[e_j, [e_k, e_i]],$$

$$2[f_i, [f_k, f_j]] + 3[f_j, [f_k, f_i]];$$

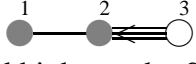
- (11)  , which is one of the Dynkin diagrams of $G(3)$, the associated higher order Serre elements are

$$\begin{aligned} & [[e_1, e_2], [[e_1, e_2], [[e_1, e_2], [e_2, e_3]]]], \\ & [[f_1, f_2], [[f_1, f_2], [[f_1, f_2], [f_2, f_3]]]]; \end{aligned}$$

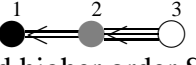
- (12)  , which is one of the Dynkin diagrams of $G(3)$, the associated higher order Serre elements are

$$\begin{aligned} & [[e_2, e_1], [e_3, [e_2, e_1]]] - [[e_2, e_3], [[e_1, e_1], e_2]], \\ & [[f_2, f_1], [f_3, [f_2, f_1]]] - [[f_2, f_3], [[f_1, f_1], f_2]]; \end{aligned}$$

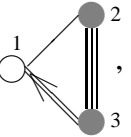
- (13)  , which is one of the Dynkin diagrams of $G(3)$, the associated higher order Serre elements are

$$\begin{aligned} & [e_2, [e_3, e_1]] - 2[e_3, [e_2, e_1]], \\ & [f_2, [f_3, f_1]] - 2[f_3, [f_2, f_1]]; \end{aligned}$$

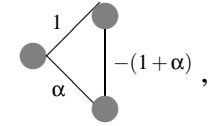
- (14)  , which is one of the Dynkin diagram for $D(2, 1; \alpha)$.

The higher order Serre elements are

$$\begin{aligned} & \alpha[e_1, [e_2, e_3]] + (1 + \alpha)[e_2, [e_1, e_3]], \\ & \alpha[f_1, [f_2, f_3]] + (1 + \alpha)[f_2, [f_1, f_3]], \end{aligned}$$

where we label the left, top and bottom nodes by 1, 2 and 3 respectively.

Remark 3.4. Cases (7) - (14) were not considered before in the literature.

Remark 3.5. The Dynkin diagrams of $D(2, 1)$ and $D(2, 1; \alpha)$ in their respective distinguished root systems are not among the full sub-diagrams listed above. Also, the diagram (9) above is a non-standard diagram of $\mathfrak{sl}_{3|1}$ (see Section 2.2).

Denote by $\mathcal{S}^+(A, \Theta)$ (resp. $\mathcal{S}^-(A, \Theta)$) the set of all the standard and higher order Serre elements (if defined) which involve generators e_k (resp. f_k) only. Set $\mathcal{S}(A, \Theta) = \mathcal{S}^+(A, \Theta) \cup \mathcal{S}^-(A, \Theta)$. We have the following result.

Lemma 3.6. *The set $\mathcal{S}(A, \Theta)$ is contained in the maximal ideal $\mathfrak{r}(A, \Theta)$ of $\tilde{\mathfrak{g}}$.*

Proof. Direct calculations show that

$$[f_i, \mathcal{S}^+(A, \Theta)] \subset \mathbb{C}\mathcal{S}^+(A, \Theta), \quad [e_i, \mathcal{S}^-(A, \Theta)] \subset \mathbb{C}\mathcal{S}^-(A, \Theta), \quad \forall i.$$

Hence $\mathcal{S}(A, \Theta) \subset \mathfrak{r}(A, \Theta)$ by Lemma 3.2. We leave out the details of the calculations. \square

Definition 3.7. Let $\mathfrak{s}(A, \Theta)$ be the \mathbb{Z}_2 -graded ideal of $\tilde{\mathfrak{g}}(A, \Theta)$ generated by the elements of $\mathcal{S}(A, \Theta)$.

Then $\mathfrak{s}(A, \Theta) \subset \mathfrak{r}(A, \Theta)$ by Lemma 3.6. Define the Lie superalgebra

$$(3.3) \quad \mathfrak{g}(A, \Theta) := \frac{\tilde{\mathfrak{g}}(A, \Theta)}{\mathfrak{s}(A, \Theta)}.$$

There exists a natural surjective Lie superalgebra map $\mathfrak{g}(A, \Theta) \longrightarrow L(A, \Theta)$. We shall show that it is in fact an isomorphism.

3.2.2. \mathbb{Z} -gradings. Let us discuss \mathbb{Z} -gradings for the Lie superalgebras $\mathfrak{g}(A, \Theta)$ and $L(A, \Theta)$. Fix a positive integer $d \leq r$, where r is the size of A . We assign degrees to the generators of $\tilde{\mathfrak{g}}(A, \Theta)$ as follows:

$$(3.4) \quad \begin{aligned} \deg(h_j) &= 0, \quad \forall j, \\ \deg(e_i) &= \deg(f_i) = 0, \quad \forall i \neq d, \\ \deg(e_d) &= -\deg(f_d) = 1. \end{aligned}$$

This introduces a \mathbb{Z} -grading to the auxiliary Lie superalgebra $\tilde{\mathfrak{g}}(A, \Theta)$, which is not required to be compatible with the \mathbb{Z}_2 -grading upon reduction modulo 2. In view of the \mathbb{Q} -grading of $\tilde{\mathfrak{g}}(A, \Theta)$ and (3.2), the maximal ideal $\mathfrak{r}(A, \Theta)$ is \mathbb{Z} -graded. Since all elements in $\mathcal{S}(A, \Theta)$ are homogeneous with the \mathbb{Z} -grading, $\mathfrak{s}(A, \Theta)$ is \mathbb{Z} -graded as well.

The Lie superalgebra $L(A, \Theta)$ inherits a \mathbb{Z} -grading from $\tilde{\mathfrak{g}}(A, \Theta)$ and $\mathfrak{r}(A, \Theta)$. Write $L(A, \Theta) = \bigoplus_{k \in \mathbb{Z}} L_k$. Since the roots of $L(A, \Theta)$ are known, we have a detailed understanding of all L_k as L_0 -modules.

The Lie superalgebra $\mathfrak{g}(A, \Theta)$ inherits a \mathbb{Z} -grading from $\tilde{\mathfrak{g}}(A, \Theta)$ and $\mathfrak{s}(A, \Theta)$. Write $\mathfrak{g}(A, \Theta) = \bigoplus_{k \in \mathbb{Z}} \mathfrak{g}_k$, where \mathfrak{g}_k is the homogeneous component of degree k . Note that \mathfrak{g}_1 (resp. \mathfrak{g}_{-1}) generates \mathfrak{g}_k (resp. \mathfrak{g}_{-k}) for all $k > 0$. Thus if $\mathfrak{g}_p = 0$ (resp. $\mathfrak{g}_{-p} = 0$) for some $p > 0$, then $\mathfrak{g}_q = 0$ (resp. $\mathfrak{g}_{-q} = 0$) for all $q > p$. Also each \mathfrak{g}_k forms a \mathfrak{g}_0 -module in the obvious way.

We have the following result.

Lemma 3.8. *There exist \mathbb{Z} -gradings for $\mathfrak{g}(A, \Theta)$ and $L(A, \Theta)$ determined by some d such that $\mathfrak{g}_0 = L_0$ as Lie superalgebras and $\mathfrak{g}_k = L_k$ as \mathfrak{g}_0 -modules for all nonzero $k \in \mathbb{Z}$.*

This is the key lemma needed for establishing Theorem 3.10 below. Its proof is elementary but very lengthy, thus we relegate it to later sections. Here we consider some general properties of the Lie superalgebras $\mathfrak{g}(A, \Theta)$ and $L(A, \Theta)$, which will significantly simplify the proof of Lemma 3.8.

Recall that an anti-involution ω of a Lie superalgebra \mathfrak{a} is a linear map on \mathfrak{a} satisfying $\omega([X, Y]) = [\omega(Y), \omega(X)]$ for all $X, Y \in \mathfrak{a}$, and $\omega^2 = \text{id}_{\mathfrak{a}}$. The Lie superalgebra $\tilde{\mathfrak{g}}(A, \Theta)$ admits an anti-involution defined by

$$\omega(e_i) = f_i, \quad \omega(f_i) = e_i, \quad \omega(h_i) = h_i, \quad \forall i.$$

Note that $\omega(\mathcal{S}^+) \subset -\mathcal{S}^- \cup \mathcal{S}^-$ and $\omega(\mathcal{S}^-) \subset -\mathcal{S}^+ \cup \mathcal{S}^+$, where $\mathcal{S}^{\pm} = \mathcal{S}^{\pm}(A, \Theta)$ and $-\mathcal{S}^{\pm}$ are respectively the sets consisting of the negatives of the elements of \mathcal{S}^{\pm} . Therefore, ω descends to an anti-involution on $\mathfrak{g}(A, \Theta)$, which sends \mathfrak{g}_k to \mathfrak{g}_{-k} for all $k \in \mathbb{Z}$ and provides a \mathfrak{g}_0 -module isomorphism between \mathfrak{g}_{-k} and the dual space of \mathfrak{g}_k .

The anti-involution of $\tilde{\mathfrak{g}}(A, \Theta)$ also descends to an anti-involution of $L(A, \Theta)$, which maps L_k to L_{-k} for all $k \in \mathbb{Z}$, and provides an isomorphism between the L_0 -module L_{-k} and the dual L_0 -module of L_k .

Therefore, if $\mathfrak{g}_0 = L_0$ and $\mathfrak{g}_k = L_k$ for all $k > 0$ as \mathfrak{g}_0 -modules, the existence of the anti-involutions immediately implies that $\mathfrak{g}_{-k} = L_{-k}$ for all $k > 0$. Hence in order to prove Lemma 3.8, we only need to show that it holds for all $k > 0$.

The arguments above may be summarised as follows.

Lemma 3.9. *If $\mathfrak{g}_0 = L_0$ as Lie superalgebras and $\mathfrak{g}_k = L_k$ for all $k > 0$ as \mathfrak{g}_0 -modules, then Lemma 3.8 holds.*

This result will play an essential role in the proof of Lemma 3.8.

3.2.3. *Main theorem.* The following theorem is the main result of this paper.

Theorem 3.10. *The Lie superalgebra $\mathfrak{g}(A, \Theta)$ coincides with $L(A, \Theta)$, or equivalently, the ideal $\mathfrak{s}(A, \Theta)$ of $\tilde{\mathfrak{g}}(A, \Theta)$ is equal to the maximal ideal $\mathfrak{r}(A, \Theta)$.*

Proof. Note that Lemma 3.8 immediately implies the claim. Indeed, we have already shown in Lemma 3.6 that $\mathfrak{s}(A, \Theta) \subset \mathfrak{r}(A, \Theta)$, and this is an inclusion of \mathbb{Z} -graded ideals of $\tilde{\mathfrak{g}}(A, \Theta)$. If $\mathfrak{s}(A, \Theta) \neq \mathfrak{r}(A, \Theta)$, there would exist a surjective Lie superalgebra homomorphism $\mathfrak{g}(A, \Theta) \rightarrow L(A, \Theta)$ with a nonzero kernel. Thus for some k , the degree- k homogeneous components of $L(A, \Theta)$ and $\mathfrak{g}(A, \Theta)$ are not equal. This contradicts Lemma 3.8. \square

3.3. Presentations of Lie superalgebras. Since the generators of $\mathfrak{s}(A, \Theta)$ are known explicitly, Theorem 3.10 provides a presentation for each simple contragredient Lie superalgebra and $\mathfrak{sl}_{n+1|n+1}$ in an arbitrary root system. We have the following result for the Lie superalgebra $L(A, \Theta)$.

Theorem 3.11. *The Lie superalgebra $L(A, \Theta)$ is generated by the generators e_i, f_i, h_i ($1 \leq i \leq r$), where e_i and f_i are odd if $i \in \Theta$, and even otherwise, subject to the quadratic relations*

$$(3.5) \quad \begin{aligned} [h_i, h_j] &= 0, \\ [h_i, e_j] &= a_{ij}e_j, \quad [h_i, f_j] = -a_{ij}f_j, \\ [e_i, f_j] &= \delta_{ij}h_i, \quad \forall i, j; \end{aligned}$$

standard Serre relations

$$(3.6) \quad \begin{aligned} & (ad_{e_i})^{1-a_{ij}}(e_j) = 0, \\ & (ad_{f_i})^{1-a_{ij}}(f_j) = 0, \quad \text{for } i \neq j, \text{ with } a_{ii} \neq 0 \text{ or } a_{ij} = 0; \\ & [e_t, e_t] = 0, \quad [f_t, f_t] = 0, \quad \text{for } a_{tt} = 0; \end{aligned}$$

and higher order Serre relations if the Dynkin diagram of (A, Θ) contains any of the following diagrams as full sub-diagrams:

- (1) $\begin{array}{c} j & & t & & k \\ \times & \xrightarrow{\quad} & \bullet & \xrightarrow{\quad} & \times \end{array}$ with $\text{sgn}_{jt}\text{sgn}_{tk} = -1$, the associated higher order Serre relations are

$$[e_t, [e_j, [e_t, e_k]]] = 0, \quad [f_t, [f_j, [f_t, f_k]]] = 0;$$

- (2) $\begin{array}{c} j & & t & & k \\ \times & \xrightarrow{\quad} & \bullet & \xrightarrow{\quad} & \circ \end{array}$, the associated higher order Serre relations are

$$[e_t, [e_j, [e_t, e_k]]] = 0, \quad [f_t, [f_j, [f_t, f_k]]] = 0;$$

- (3) $\begin{array}{c} j & & t & & k \\ \times & \xrightarrow{\quad} & \bullet & \xrightarrow{\quad} & \bullet \end{array}$, the associated higher order Serre relations are

$$[e_t, [e_j, [e_t, e_k]]] = 0, \quad [f_t, [f_j, [f_t, f_k]]] = 0;$$

- (4) $\begin{array}{c} j & & t & & k \\ \bullet & \xrightarrow{\quad} & \bullet & \xleftarrow{\quad} & \circ \end{array}$, the associated higher order Serre relations are

$$\begin{aligned} & [[e_j, e_t], [[e_j, e_t], [e_t, e_k]]] = 0, \\ & [[f_j, f_t], [[f_j, f_t], [f_t, f_k]]] = 0; \end{aligned}$$

- (5) $\begin{array}{c} i & & i & & t & & k \\ \times & \xrightarrow{\quad} & \circ & \xrightarrow{\quad} & \bullet & \xleftarrow{\quad} & \circ \end{array}$, the associated higher order Serre relations are

$$\begin{aligned} & [[e_i, [e_j, e_t]], [[e_j, e_t], [e_t, e_k]]] = 0, \\ & [[f_i, [f_j, f_t]], [[f_j, f_t], [f_t, f_k]]] = 0; \end{aligned}$$

- (6) $\begin{array}{c} & & t \\ & \diagup & \parallel \\ i & \times & \bullet \\ & \diagdown & \parallel \\ & & s \end{array}$, the associated higher order Serre relations are

$$\begin{aligned} & [e_t, [e_s, e_i]] - [e_s, [e_t, e_i]] = 0, \\ & [f_t, [f_s, f_i]] - [f_s, [f_t, f_i]] = 0; \end{aligned}$$

- (7) $\begin{array}{c} 1 & & 2 & & 3 & & 4 \\ \circ & \xrightarrow{\quad} & \bullet & \xleftarrow{\quad} & \circ & \xrightarrow{\quad} & \circ \end{array}$, the associated higher order Serre relations are

$$\begin{aligned} & [E, [E, [e_2, [e_3, e_4]]]] = 0, \\ & [F, [F, [f_2, [f_3, f_4]]]] = 0, \end{aligned}$$

where $E = [[e_1, e_2], [e_2, e_3]]$ and $F = [[f_1, f_2], [f_2, f_3]]$;

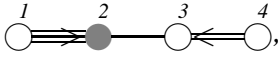
(8)  , the associated higher order Serre relations are

$$\begin{aligned} [[e_1, e_2], [e_2, e_3], [e_3, e_4]] - [[e_2, e_3], [[e_1, e_2], [e_3, e_4]]] &= 0, \\ [[f_1, f_2], [f_2, f_3], [f_3, f_4]] - [[f_2, f_3], [[f_1, f_2], [f_3, f_4]]] &= 0; \end{aligned}$$

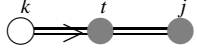
(9)  , the associated higher order Serre relations are

$$\begin{aligned} [e_t, [e_j, [e_t, e_k]]] &= 0, \\ [f_t, [f_j, [f_t, f_k]]] &= 0; \end{aligned}$$

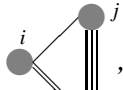
(10)  , the associated higher order Serre relations are

$$\begin{aligned} 2[e_i, [e_k, e_j]] + 3[e_j, [e_k, e_i]] &= 0, \\ 2[f_i, [f_k, f_j]] + 3[f_j, [f_k, f_i]] &= 0; \end{aligned}$$

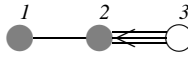
(11)  , the higher order Serre relations are

$$\begin{aligned} [[e_1, e_2], [e_1, e_2], [e_1, e_2], [e_2, e_3]]] &= 0, \\ [[f_1, f_2], [f_1, f_2], [f_1, f_2], [f_2, f_3]]] &= 0; \end{aligned}$$

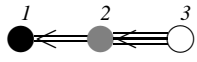
(12)  , the higher order Serre relations are

$$\begin{aligned} [[e_2, e_1], [e_3, [e_2, e_1]]] - [[e_2, e_3], [[e_1, e_1], e_2]] &= 0, \\ [[f_2, f_1], [f_3, [f_2, f_1]]] - [[f_2, f_3], [[f_1, f_1], f_2]] &= 0; \end{aligned}$$

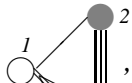
(13)  , the higher order Serre relations are

$$\begin{aligned} [e_2, [e_3, e_1]] - 2[e_3, [e_2, e_1]] &= 0, \\ [f_2, [f_3, f_1]] - 2[f_3, [f_2, f_1]] &= 0; \end{aligned}$$

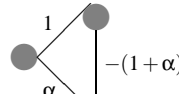
(14)  , the higher order Serre relations are

$$\begin{aligned} \alpha[e_1, [e_2, e_3]] + (1 + \alpha)[e_2, [e_1, e_3]] &= 0, \\ \alpha[f_1, [f_2, f_3]] + (1 + \alpha)[f_2, [f_1, f_3]] &= 0, \end{aligned}$$

where the left node is labeled by 1, the top node by 2 and bottom one by 3.

When (A, Θ) is given in the distinguished root system, Theorem 3.11 simplifies considerably. We have the following result.

Theorem 3.12. *Let (A, Θ) with $\Theta = \{s\}$ be the Cartan matrix of a contragredient Lie superalgebra in the distinguished root system. Then $L(A, \Theta)$ is generated by generators e_i, f_i, h_i ($i = 1, 2, \dots, r$), where e_s and f_s are odd and the rest even, subject to the quadratic relations*

$$(3.7) \quad \begin{aligned} [h_i, h_j] &= 0, \\ [h_i, e_j] &= a_{ij}e_j, \quad [h_i, f_j] = -a_{ij}f_j, \\ [e_i, f_j] &= \delta_{ij}h_i, \quad \forall i, j; \end{aligned}$$

standard Serre relations

$$(3.8) \quad \begin{aligned} (ad_{e_i})^{1-a_{ij}}(e_j) &= 0, \\ (ad_{f_i})^{1-a_{ij}}(f_j) &= 0, \quad \text{for } i \neq j, a_{ii} \neq 0; \\ [e_s, e_s] &= 0, \quad [f_s, f_s] = 0, \quad \text{for } a_{ss} = 0; \end{aligned}$$

and higher order Serre relations

$$(3.9) \quad [e_s, [e_{s-1}, [e_s, e_{s+1}]]] = 0, \quad [f_s, [f_{s-1}, [f_s, f_{s+1}]]] = 0,$$

if the Dynkin diagram of A contains a full sub-diagram of the form

$$\begin{array}{c} s-1 \quad s \quad s+1 \\ \circ \text{---} \bullet \text{---} \circ \end{array} \quad \text{with } sgn_{s-1,s}sgn_{s,s+1} = -1, \quad \text{or} \quad \begin{array}{c} s-1 \quad s \quad s+1 \\ \circ \text{---} \bullet \text{---} \circ \end{array}.$$

Remark 3.13. Note the importance of the signs sgn_{ij} in the above theorem. There are higher order Serre relations associated with the first Dynkin diagram in (2.3), but none with the second. The Dynkin diagrams in (2.3) are respectively those of $\mathfrak{sl}_{2|2}$ and $\mathfrak{osp}_{4|2}$ in their distinguished root systems. The Lie superalgebra $D(2, 1; \alpha)$ in the distinguished root system has no higher order Serre relations either.

4. PROOF OF KEY LEMMA FOR DISTINGUISHED ROOT SYSTEMS

Throughout this section, we assume that the Cartan matrix (A, Θ) is associated with the distinguished root system of a simple Lie superalgebra. Thus Θ contains only one element, which we denote by s . To simplify notation, we write $\tilde{\mathfrak{g}}(A)$ for $\tilde{\mathfrak{g}}(A, \Theta)$, $\mathfrak{g}(A)$ for $\mathfrak{g}(A, \Theta)$, and $L(A)$ for $L(A, \Theta)$

4.1. The proof. The proof of Lemma 3.8 will make essential use of Lemma 3.9. Define the \mathbb{Z} -gradings for $\mathfrak{g}(A)$ and $L(A)$ as in Section 3.2.2 by taking $d = s$.

Lemma 4.1. *As reductive Lie algebras, $\mathfrak{g}_0 = L_0$.*

Proof. In this case, both \mathfrak{g}_0 and L_0 are generated by purely even elements. Let $\mathfrak{g}'_0 = [\mathfrak{g}_0, \mathfrak{g}_0]$ and $L'_0 = [L_0, L_0]$ be the derived algebras. Then by Serre's theorem for semi-simple Lie algebras $\mathfrak{g}'_0 = L'_0$. Now the claim immediately follows. \square

We now consider the \mathfrak{g}_0 -modules \mathfrak{g}_1 and L_1 .

Remark 4.2. For convenience, we continue to use e_i, h_i and f_i to denote the images of these elements in $\mathfrak{g}(A)$.

Examine the following relations in $\mathfrak{g}(A)$:

$$(4.1) \quad [h_i, e_s] = a_{is}e_s, \quad [f_i, e_s] = 0, \quad (ad_{e_i})^{1-a_{is}}e_s = 0, \quad \forall i \neq s.$$

The first two relations imply that e_s is a lowest weight vector of the \mathfrak{g}_0 -module \mathfrak{g}_1 , with weight α_s . Since a_{is} are non-positive integers for all $i \neq s$, by [11, Theorem 21.4], the third relation implies that \mathfrak{g}_1 is an irreducible finite dimensional \mathfrak{g}_0 -module. The relations (4.1) also hold in $L(A)$. This immediately shows the following result.

Lemma 4.3. *Both \mathfrak{g}_1 and L_1 are irreducible \mathfrak{g}_0 -modules, and $\mathfrak{g}_1 = L_1$.*

Note that \mathfrak{g}_2 is generated by \mathfrak{g}_1 , that is $\mathfrak{g}_2 = [\mathfrak{g}_1, \mathfrak{g}_1]$. By induction one can show that $\mathfrak{g}_{k+1} = (ad_{\mathfrak{g}_1})^k(\mathfrak{g}_1)$ for all $k \geq 1$. If $\mathfrak{g}_i = 0$ for some $i > 1$, then $\mathfrak{g}_j = 0$ for all $j \geq i$. We have the \mathfrak{g}_0 -module decomposition $\mathfrak{g}_1 \otimes \mathfrak{g}_1 = S_s^2(\mathfrak{g}_1) \oplus \wedge_s^2(\mathfrak{g}_1)$, where $S_s^2(\mathfrak{g}_1)$ denotes the second \mathbb{Z}_2 -graded symmetric power, and $\wedge_s^2(\mathfrak{g}_1)$ the second \mathbb{Z}_2 -graded skew power, of \mathfrak{g}_1 .

Remark 4.4. Throughout the paper, we use $S_s^k(V)$ and $\wedge_s^k(V)$ to denote the \mathbb{Z}_2 -graded symmetric and skew symmetric tensors of rank k in the \mathbb{Z}_2 -graded vector space V , and $S^k(V)$ and $\wedge^k(V)$ to denote the usual symmetric and skew symmetric tensors of rank k , ignoring the \mathbb{Z}_2 -grading of V .

We have the following result:

Lemma 4.5. *The Lie superbracket defines a surjective \mathfrak{g}_0 -map $\mathfrak{g}_1 \otimes \mathfrak{g}_1 \longrightarrow \mathfrak{g}_2$, $X \otimes Y \mapsto [X, Y]$. The \mathfrak{g}_0 -submodule $S_s^2(\mathfrak{g}_1)$ is in the kernel of this map, and $\wedge_s^2(\mathfrak{g}_1)$ is mapped surjectively onto \mathfrak{g}_2 .*

Proof. For any $X, Y \in \mathfrak{g}_1$, an element $Z \in \mathfrak{g}_0$ acts on $X \otimes Y$ by

$$Z \cdot (X \otimes Y) = [Z, X] \otimes Y + X \otimes [Z, Y].$$

The Lie superbracket maps $Z \cdot (X \otimes Y)$ to $[[Z, X], Y] + [X, [Z, Y]] = [Z, [X, Y]]$. This proves the first claim. The second claim follows from the \mathbb{Z}_2 -graded skew symmetry of the Lie superbracket. \square

Therefore, the \mathfrak{g}_0 -map $\Psi : \wedge_s^2(\mathfrak{g}_1) \longrightarrow \mathfrak{g}_2$ defined by the composition

$$\wedge_s^2(\mathfrak{g}_1) \hookrightarrow \mathfrak{g}_1 \otimes \mathfrak{g}_1 \xrightarrow{[\cdot, \cdot]} \mathfrak{g}_2$$

is also surjective, where the map on the left is the natural embedding. The structure of $\wedge_s^2(\mathfrak{g}_1)$ as a \mathfrak{g}_0 -module can be understood; this enables us to understand the structure of \mathfrak{g}_2 .

Recall that in the distinguished root systems, $L_2 = 0$ if $L(A)$ is of type I, and $L_2 \neq 0$ but $L_3 = 0$ if $L(A)$ is of type II. Thus in order to show that $\mathfrak{g}_k = L_k$ for all $k > 0$, it remains to prove that $\mathfrak{g}_2 = 0$ if the Cartan matrix A is of type I, and $\mathfrak{g}_2 = L_2$ and $\mathfrak{g}_3 = 0$ if A is of type II. In view of Lemma 3.9, the proof of Lemma 3.8 is done once this is accomplished.

The rest of the proof will be based on a case by case study. Let us start with the type I Lie superalgebras.

4.1.1. *The case of $\mathfrak{sl}_{m|n}$.* If the Cartan matrix A is that of $\mathfrak{sl}_{m|n}$, the Lie superalgebra $\mathfrak{g}(A)$ has $\mathfrak{g}_0 = \mathfrak{gl}_m \oplus \mathfrak{sl}_n$, and $\mathfrak{g}_1 \cong \mathbb{C}^m \otimes \overline{\mathbb{C}}^n$ up to parity change, where \mathbb{C}^m denotes the natural module for \mathfrak{gl}_m , and $\overline{\mathbb{C}}^n$ denotes the dual of the natural module for \mathfrak{sl}_n . Assuming that both m and n are greater than 1. Then $\wedge_s^2(\mathfrak{g}_1) = S^2(\mathbb{C}^m) \otimes S^2(\overline{\mathbb{C}}^n) \oplus \wedge^2(\mathbb{C}^m) \otimes \wedge^2(\overline{\mathbb{C}}^n)$.

The lowest weight vectors of the irreducible submodules are respectively given by

$$\begin{aligned} v(2) &:= e_s \otimes e_s; \\ v(1^2) &:= e_{s-1,s+2} \otimes e_{s,s+1} + e_{s,s+1} \otimes e_{s-1,s+2} \\ &\quad - (e_{s-1,s+1} \otimes e_{s,s+2} + e_{s,s+2} \otimes e_{s-1,s+1}), \end{aligned}$$

where $s = m$, and

$$\begin{aligned} e_{s,s+1} &= e_s, & e_{s,s+2} &= [e_s, e_{s+1}], \\ e_{s-1,s+1} &= [e_{s-1}, e_s], & e_{s-1,s+2} &= [e_{s-1}, e_{s,s+2}]. \end{aligned}$$

We have $\Psi(v(2)) = [e_s, e_s] = 0$ by one of the standard Serre relations. It follows that the entire irreducible \mathfrak{g}_0 -submodule $S^2(\mathbb{C}^m) \otimes S^2(\overline{\mathbb{C}}^n)$ is mapped to zero. In particular, we have

$$(4.2) \quad [e_{s-1,s+2}, e_{s,s+1}] + [e_{s-1,s+1}, e_{s,s+2}] = 0.$$

The first term of (4.2) vanishes by the higher order Serre relation; this in turn forces the second term to vanish as well. Hence

$$\Psi(v(1^2)) = [e_{s-1,s+2}, e_{s,s+1}] - [e_{s-1,s+1}, e_{s,s+2}] = 0.$$

Therefore, $v(1^2)$ is in the kernel of Ψ , implying that the entire submodule $\wedge^2(\mathbb{C}^m) \otimes \wedge^2(\overline{\mathbb{C}}^n)$ is mapped to zero by Ψ . This shows that $\mathfrak{g}_2 = 0$, and hence $\mathfrak{g}_k = 0$ for all $k \geq 2$.

Note that if $\min(m, n) = 1$, say, $n = 1$, $\wedge_s^2(\mathfrak{g}_1)$ is irreducible as \mathfrak{g}_0 -module and is equal to $S^2(\mathbb{C}^m) \otimes \mathbb{C}$. The above proof obviously goes through but in a much simplified fashion.

Therefore, we have proved that $\mathfrak{g}_k = L_k$ for all $k \geq 2$ in the case $L(A) = \mathfrak{sl}_{m|n}$.

4.1.2. *The case of $C(n+1)$ with $n > 1$.* In this case, $\mathfrak{g}_0 = \mathfrak{sp}_{2n} \oplus \mathbb{C}$ and $\mathfrak{g}_1 = \mathbb{C}^{2n}$. The \mathbb{Z}_2 -graded skew symmetric tensor $\wedge_s^2(\mathfrak{g}_1)$ is an irreducible \mathfrak{g}_0 -module with the lowest weight vector $e_1 \otimes e_1$. Since $\Psi(e_1 \otimes e_1) = [e_1, e_1] = 0$ by the standard Serre relation, it immediately follows that $\mathfrak{g}_k = 0$ for all $k \geq 2$.

4.1.3. *The case of $D(m, n)$ with $m > 2$.* In this case, $\mathfrak{g}_0 = \mathfrak{gl}_n \oplus \mathfrak{so}_{2m}$, and \mathfrak{g}_1 is isomorphic to $\mathbb{C}^n \otimes \mathbb{C}^{2m}$ as \mathfrak{g}_0 -module (up to parity) with e_n being the lowest weight vector. Let us first assume that $n > 1$. Then we have

$$\wedge_s^2(\mathfrak{g}_1) = S^2(\mathbb{C}^n) \otimes \frac{S^2(\mathbb{C}^{2m})}{\mathbb{C}} \oplus \wedge^2(\mathbb{C}^n) \otimes \wedge^2(\mathbb{C}^{2m}) \oplus S^2(\mathbb{C}^n) \otimes \mathbb{C}.$$

Lowest weight vectors of the first two irreducible submodules can be explicitly constructed in exactly the same way as in the case of $\mathfrak{sl}_{m|n}$. The same arguments used there also show that the Lie superbracket maps both submodules to zero. Hence $\mathfrak{g}_2 \cong S^2(\mathbb{C}^n) \otimes \mathbb{C}$. Inspecting the roots of $D(m, n)$ given in Appendix A.1, we can see that $\mathfrak{g}_2 = L_2$.

Let us examine \mathfrak{g}_2 in more detail. We use notation from Appendix A.1 for roots of the Lie superalgebra $D(m, n)$. Let $X_{\delta_i \pm \varepsilon_p}$, where $1 \leq i \leq n$ and $1 \leq p \leq m$, be a weight basis of \mathfrak{g}_1 . Then in \mathfrak{g}_2 , we have

$$(4.3) \quad \begin{aligned} [X_{\delta_i - \varepsilon_p}, X_{\delta_j - \varepsilon_q}] &= [X_{\delta_i + \varepsilon_p}, X_{\delta_j + \varepsilon_q}] = 0, \quad \forall i, j, p, q, \\ [X_{\delta_i + \varepsilon_p}, X_{\delta_j - \varepsilon_q}] &= 0, \quad \forall i, j, p \neq q, \end{aligned}$$

and there exist scalars $c_{ij, pq}$ such that

$$[X_{\delta_i - \varepsilon_p}, X_{\delta_j + \varepsilon_p}] = c_{ij, pq} [X_{\delta_i + \varepsilon_p}, X_{\delta_j - \varepsilon_p}] \neq 0, \quad \forall i, j, p, q.$$

By multiplying the elements $X_{\delta_i \pm \varepsilon_p}$ by appropriate scalars if necessary, we may assume

$$[X_{\delta_i - \varepsilon_p}, X_{\delta_j + \varepsilon_p}] = [X_{\delta_i - \varepsilon_q}, X_{\delta_j + \varepsilon_q}], \quad \forall i, j, p, q,$$

which we denote by $X_{\delta_i + \delta_j}$. Then the subset of $X_{\delta_i + \delta_j}$ with $1 \leq i \leq j \leq n$ forms a basis of \mathfrak{g}_2 .

Now we consider \mathfrak{g}_3 . It immediately follows from (4.3) that $[X_{\delta_i + \delta_j}, X_{\delta_k \pm \varepsilon_p}] = 0$ for all k, p and $i \leq j$, that is,

$$(4.4) \quad \mathfrak{g}_3 = [\mathfrak{g}_1, \mathfrak{g}_2] = 0.$$

Hence $\mathfrak{g}_k = 0$ for all $k \geq 3$.

When $n = 1$, the proof goes through much more simply. This completes the proof of Lemma 3.8 for the case of $D(m, n)$ with $m > 2$.

In contrast to the type I case, the complication here is that \mathfrak{g}_3 needs to be analysed separately as $\mathfrak{g}_2 \neq 0$.

4.1.4. *The case of $D(2, n)$.* In this case, $\mathfrak{g}_0 = \mathfrak{gl}_n \oplus \mathfrak{sl}_2 \oplus \mathfrak{sl}_2$, and $\mathfrak{g}_1 = \mathbb{C}^n \otimes \mathbb{C}^2 \otimes \mathbb{C}^2$. The \mathbb{Z}_2 -graded skew symmetric rank two tensor $\wedge_s^2(\mathfrak{g}_1)$ decomposes into the direct sum of four irreducible \mathfrak{g}_0 -modules if $n > 1$:

$$\begin{aligned} \wedge_s^2(\mathfrak{g}_1) &= L_{(2)}^n \otimes L_{(2)}^2 \otimes L_{(2)}^2 \oplus L_{(1,1)}^n \otimes L_{(2)}^2 \otimes L_{(0)}^2 \\ &\quad \oplus L_{(1,1)}^n \otimes L_{(0)}^2 \otimes L_{(2)}^2 \oplus L_{(2)}^n \otimes L_{(0)}^2 \otimes L_{(0)}^2. \end{aligned}$$

If $n = 1$, then $L_{(1,1)}^n = 0$, the two modules in the middle are absent.

The lowest weight vectors of the first three submodules can be easily worked out. Below we give the explicit formulae for their images under the Lie superbracket. Let

$$\begin{aligned} e_{s;s+1} &= [e_s, e_{s+1}], & e_{s;s+2} &= [e_s, e_{s+2}], & e_{s-1;s} &= [e_{s-1}, e_s], \\ e_{s-1;s+1} &= [e_{s-1}, e_{s;s+1}], & e_{s-1;s+2} &= [e_{s-1}, e_{s;s+2}]. \end{aligned}$$

Then the images of the lowest weight vectors are given by

$$(4.5) \quad [e_s, e_s], \quad [e_{s-1;s+1}, e_s] - [e_{s-1;s}, e_{s;s+1}], \quad [e_{s-1;s+2}, e_s] - [e_{s-1;s}, e_{s;s+2}].$$

We have the Serre relation $[e_s, e_s] = 0$. This implies that the entire irreducible submodule $L_{(2)}^n \otimes L_{(2)}^2 \otimes L_{(2)}^2$ is mapped to zero by the Lie superbracket.

In the case $n > 1$, this in particular implies

$$[e_{s-1;s+1}, e_s] + [e_{s-1;s}, e_{s;s+1}] = 0, \quad [e_{s-1;s+2}, e_s] + [e_{s-1;s}, e_{s;s+2}] = 0.$$

Note that $[e_{s-1;s+1}, e_s] = 0$ and $[e_{s-1;s+2}, e_s] = 0$ are the two higher order Serre relations involving e_s . Thus all the four terms on the left hand sides of the above equations should vanish separately. It then follows that the second and third elements in (4.5) are zero, that is, the lowest weight vectors of the irreducible submodules $L_{(1,1)}^n \otimes L_{(2)}^2 \otimes L_{(0)}^2$ and $L_{(1,1)}^n \otimes L_{(0)}^2 \otimes L_{(2)}^2$ are in the kernel of the Lie superbracket. Thus both irreducible submodules are mapped to zero by the Lie superbracket. The above analysis in vacuous if $n = 1$.

Therefore, $\mathfrak{g}_2 \cong L_{(2)}^n \otimes L_{(0)}^2 \otimes L_{(0)}^2$, and this shows that $\mathfrak{g}_2 \cong L_2$.

To analyse \mathfrak{g}_3 , we note that equation (4.4) still holds here as can be shown by adapting the arguments in the $m > 2$ case. This completes the proof in this case.

4.1.5. *The case of $B(m, n)$.* When $m \geq 1$, the proof is much the same as in the case of $D(m, n)$ with $m > 2$. We omit the details.

If $m = 0$, then $\mathfrak{g}_0 = \mathfrak{gl}_n$, $\mathfrak{g}_1 = \mathbb{C}^n$ and $\mathfrak{g}_2 \cong \wedge_s^2(\mathfrak{g}_1) \cong L_2$. Every root vector in \mathfrak{g}_1 is of the form $[X, e_s]$ for some positive root vector $X \in \mathfrak{g}_0$, where $s = n$. Thus it follows from the relation $(ad_{e_s})^3(e_{s-1}) = 0$ that $[\mathfrak{g}_1, [e_s, e_s]] = 0$. Since $[e_s, e_s]$ is a \mathfrak{g}_0 lowest weight vector of \mathfrak{g}_2 , this implies $\mathfrak{g}_3 = 0$.

Remark 4.6. The Lie superalgebra $B(0, n)$ is essentially the same as the ordinary Lie algebra B_n . As a matter of fact, the corresponding quantum supergroup is isomorphic to the smash product of $U_q(B_n)$ with the group algebra of \mathbb{Z}_2^n [28, 18]. The usual proof of Serre presentations for semi-simple Lie algebras (see, e.g., [11]) works for $B(0, n)$. We gave the alternative proof here for the sake of uniformity.

4.1.6. *The case of $F(4)$.* Let us order the nodes in the Dynkin diagram from the right to left:

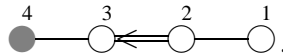

We may express the simple roots as $\alpha_1 = \varepsilon_1 - \varepsilon_2$, $\alpha_2 = \varepsilon_2 - \varepsilon_3$, $\alpha_3 = \varepsilon_3$ and $\alpha_4 = \frac{1}{2}(\delta - \varepsilon_1 - \varepsilon_2 - \varepsilon_3)$. The symmetric bilinear form on the weight space is defined in Appendix A.1, where further details about roots of $F(4)$ are given.

The first three simple roots are the standard simple roots of \mathfrak{so}_7 , thus $\mathfrak{g}_0 = \mathfrak{so}_7 \oplus \mathfrak{gl}_1$. The subspace \mathfrak{g}_1 is an irreducible \mathfrak{g}_0 -module, which has e_4 as a lowest weight vector, and restricts to the spinor module for \mathfrak{so}_7 . Now $\wedge_s^2(\mathfrak{g}_1)$ decomposes into the direct sum of two irreducibles \mathfrak{g}_0 -submodules, one of which is 1-dimensional, the other is 35-dimensional with lowest weight vector $e_4 \otimes e_4$.

The Serre relation $[e_4, e_4] = 0$ implies that the 35-dimensional submodule is in the kernel of the Lie superbracket, and hence \mathfrak{g}_2 is 1-dimensional. A basis element for \mathfrak{g}_2 is $E = [e_4, e_{\alpha_4 + \varepsilon_1 + \varepsilon_2 + \varepsilon_3}]$.

For any weight β of \mathfrak{g}_1 , we use $e_\beta \in \mathfrak{g}_1$ to denote a basis vector of the associated weight space, and set $e_{\alpha_4} = e_4$. Then we have

$$(4.6) \quad [e_\beta, E] = 0, \quad \text{for all odd positive root } \beta.$$

This is trivially true for $\beta = \alpha_4$ or $\alpha_4 + \varepsilon_1 + \varepsilon_2 + \varepsilon_3$. For $\beta = \alpha_4 + \varepsilon_i$ or $\alpha_4 + \varepsilon_i + \varepsilon_j$ ($i \neq j$), we have $[e_\beta, E] = [[e_\beta, e_{\alpha_4}], e_{\alpha_4 + \varepsilon_1 + \varepsilon_2 + \varepsilon_3}] - [e_{\alpha_4}, [e_\beta, e_{\alpha_4 + \varepsilon_1 + \varepsilon_2 + \varepsilon_3}]]$, where both terms vanish as they involve images in \mathfrak{g}_2 of elements in the 35-dimensional submodule of $\wedge_s^2(\mathfrak{g}_1)$. Therefore, $\mathfrak{g}_k = \{0\}$ for all $k \geq 3$.

4.1.7. *The case of $G(3)$.* In this case, \mathfrak{g}_0 is isomorphic to the reductive Lie algebra $G_2 \oplus \mathfrak{gl}_1$, and \mathfrak{g}_1 is an irreducible \mathfrak{g}_0 -module which restricts to the 7-dimensional irreducible G_2 -module. The \mathbb{Z}_2 -graded skew symmetric tensor $\wedge_s^2(\mathfrak{g}_1)$ decomposes into the direct sum $L(2\alpha_1) \oplus L(0)$ of two irreducible \mathfrak{g}_0 -submodules. The submodule $L(2\alpha_1)$ has $e_1 \otimes e_1$ as lowest weight vector, thus its image under the Lie superbracket is zero by the Serre relation $[e_1, e_1] = 0$. The submodule $L(0)$ is 1-dimensional. Since the Lie superbracket maps $\wedge_s^2(\mathfrak{g}_1)$ surjectively to \mathfrak{g}_2 , we immediately conclude that $\dim \mathfrak{g}_2 = 1$.

Let $X = e_{2\alpha_2 + \alpha_3}$ be the root vector of $G_2 \subset \mathfrak{g}$ associated with the positive root $2\alpha_2 + \alpha_3$. Then $e^+ := [X, [X, e_1]]$ is the highest weight vector of \mathfrak{g}_1 as a \mathfrak{g}_0 -module. Since \mathfrak{g}_2 is one-dimensional, it must be spanned by $E = [e_1, e^+]$.

If $e_\beta \in \mathfrak{g}_1$ is a weigh vector not proportional to e_1 or e^+ , both $[e_\beta, e_1]$ and $[e_\beta, e^+]$ vanish since they lie in the image of $L(2\alpha_1) \subset \wedge_s^2(\mathfrak{g}_1)$ under the Lie superbracket. Hence $[e_\beta, E] = 0$. We also have $[e^+, e^+] = 0$, and the Serre relation $[e_1, e_1] = 0$. Thus $[e_1, E] = [e^+, E] = 0$. Therefore, $[\mathfrak{g}_1, E] = 0$, which implies $\mathfrak{g}_k = \{0\}$, for all $k \geq 3$.

4.1.8. *The case of $D(2, 1; \alpha)$.* We have $\mathfrak{g}_0 = \mathfrak{sl}_2 \oplus \mathfrak{sl}_2 \oplus \mathfrak{gl}_1$, and $\mathfrak{g}_1 \cong \mathbb{C}^2 \otimes \mathbb{C}^2$. The tensor $\wedge_s^2(\mathfrak{g}_1)$ decomposes into the direct sum of two irreducible \mathfrak{g}_0 -submodules,

$$\wedge_s^2(\mathfrak{g}_1) = L_{(2;2)} \oplus L_{(1^2;1^2)}, \quad L_{(2;2)} = L_{(2)} \otimes L_{(2)}, \quad L_{(1^2;1^2)} = L_{(1^2)} \otimes L_{(1^2)}.$$

The notation here only reflects the $\mathfrak{sl}_2 \oplus \mathfrak{sl}_2$ -module structure, as there is no need to specify the \mathfrak{gl}_1 -action explicitly (see Remark 4.7 below).

We have $\dim L_{(2;2)} = 9$ and $\dim L_{(1^2;1^2)} = 1$. The lowest weight vector for $L_{(2;2)}$ is $v(2) = e_1 \otimes e_1$. Let

$$\begin{aligned} e_{--} &= e_1, & e_{+-} &= [e_1, e_2], & e_{-+} &= [e_1, e_3], & e_{++} &= [e_{+-}, e_3], \\ v(1^2) &= e_{--} \otimes e_{++} + e_{++} \otimes e_{--} - e_{+-} \otimes e_{-+} - e_{-+} \otimes e_{+-}. \end{aligned}$$

Then the vector $v(1^2)$ spans $L_{(1^2;1^2)}$.

The Lie superbracket maps $L_{(2;2)}$ to zero because $[e_1, e_1] = 0$. Note that $[e_{--}, e_{++}] + [e_{+-}, e_{-+}]$ belongs to the image of $L_{(2;2)}$, thus is zero. Hence \mathfrak{g}_2 is spanned by $E = [e_{--}, e_{++}]$. Now it is easy to show that $[E, \mathfrak{g}_1] = 0$.

Remark 4.7. This proof is essentially the same as that in the case of $D(2, 1)$, except for that the \mathfrak{gl}_1 subalgebra of \mathfrak{g}_0 acts on \mathfrak{g}_1 by different scalars in the two cases. However, this scalar is not important in the proof of Lemma 3.8, and that is the reason why we did not specify it explicitly.

4.2. Comments on the proof. Let us recapitulate the proof of Lemma 3.8 in the distinguished root systems.

- (1) By Lemma 3.9, the proof of Lemma 3.8 is reduced to showing that the parabolic subalgebras $\mathfrak{g}(A)_{\geq 0}$ and $L(A)_{\geq 0}$ are the same.
- (2) The elements $\{h_s\} \cup \{h_i, e_i, f_i \mid i \neq s\}$ and those defining relations of $\mathfrak{g}(A)$ obeyed by them give a Serre presentation for the reductive Lie algebra \mathfrak{g}_0 . Then it essentially follows from Serre's theorem that $\mathfrak{g}_0 = L_0$, see Lemma 4.1.
- (3) Given item (2), it suffices to show that $\mathfrak{g}(A)_{>0} = \bigoplus_{k>0} \mathfrak{g}_k$ and $L(A)_{>0} = \bigoplus_{k>0} L_k$ are isomorphic as \mathfrak{g}_0 -modules.
- (4) Equation (4.1) gives the necessary and sufficient conditions for \mathfrak{g}_1 to be a finite dimensional irreducible \mathfrak{g}_0 -module with lowest weight α_s , hence $\mathfrak{g}_1 = L_1$ as \mathfrak{g}_0 -modules.
- (5) The standard and higher order Serre relations involving e_s are conditions imposed on \mathfrak{g}_0 -lowest weight vectors of $[\mathfrak{g}_1, \mathfrak{g}_1]$, which are the necessary and sufficient to guarantee that $\mathfrak{g}_2 = L_2$.
- (6) The fact that $\mathfrak{g}_3 = 0$ follows (trivially in the type I case) from the result on \mathfrak{g}_2 and graded skew symmetry of the Lie superbracket, thus no additional relations are required. The vanishing of \mathfrak{g}_3 implies that for all $k \geq 3$, $\mathfrak{g}_k = 0$, and hence $\mathfrak{g}_k = L_k$.

In non-distinguished root systems, one can still prove Lemma 3.8 by following a similar strategy, as we shall see in the next section. However, there are important differences in several aspects.

There are many such \mathbb{Z} -gradings as defined in Section 3.2.2 for the Lie superalgebras $\mathfrak{g}(A, \Theta)$ and $L(A, \Theta)$. This works to our advantage.

Given any such \mathbb{Z} -grading $\mathfrak{g}(A, \Theta) = \bigoplus_{k \in \mathbb{Z}} \mathfrak{g}_k$, the degree zero subspace \mathfrak{g}_0 forms a Lie superalgebra, which is not an ordinary Lie in general. Thus the requirement that

\mathfrak{g}_1 be an irreducible \mathfrak{g}_0 -module is much more difficult to implement, and usually leads to unfamiliar higher order Serre relations.

In general $\mathfrak{g}_3 \neq 0$. In order for \mathfrak{g}_k to be equal to L_k for $k \geq 3$, higher order Serre relations are needed at degree $k \geq 3$.

5. PROOF OF KEY LEMMA FOR NON-DISTINGUISHED ROOT SYSTEMS

In this section we prove Lemma 3.8 in non-distinguished root systems by following a similar strategy as that in Section 4. In particular, Lemma 3.9 will be used in an essential way.

Assume that the Cartan matrix A is of size $r \times r$. Fix a positive integer $d \leq r$, we consider the corresponding \mathbb{Z} -gradings for $\mathfrak{g}(A, \Theta)$ and $L(A, \Theta)$ defined in Section 3.2.2. We shall first establish that $\mathfrak{g}_0 = L_0$. Since the roots of $L(A, \Theta)$ are known explicitly (see Appendix A.1), we have a complete understanding of the \mathfrak{g}_0 -module structure of every L_k . Thus once we have a description of the weight spaces of each \mathfrak{g}_k as \mathfrak{g}_0 -module for all $k > 0$, an easy comparison with the root spaces of L_k will enable us to prove the key lemma.

Remark 5.1. In the proof of Lemma 3.8 given below, we shall only describe the weight spaces of \mathfrak{g}_k ($k > 0$), and leave out the easy step of comparing them with those of L_k in most cases.

For convenience, we introduce the parity map $p : \{1, 2, \dots, r\} \longrightarrow \{0, 1\}$ such that $p(i) = 1$ if $i \in \Theta$ and $p(i) = 0$ otherwise. Then e_i and f_i are odd if $p(i) = 1$, and even if $p(i) = 0$.

5.1. Proof in type A. We use induction on the rank r together with the help of Lemma 3.9 to prove Lemma 3.8 and Theorem 3.11.

If $r = 2$, the Dynkin diagram in the non-distinguished root system has two grey nodes. In this case, there exists no relation between e_1 and e_2 , and $[e_1, e_2]$ is another positive root vector. Note that $[e_1, [e_1, e_2]] = 0$ and $[e_2, [e_1, e_2]] = 0$ by the graded skew symmetry of the Lie superbracket. Thus Lemma 3.8 is valid and $\mathfrak{g}(A, \Theta) = L(A, \Theta)$.

When $r > 2$, we take $d = r$. Then $\mathfrak{g}'_0 = [\mathfrak{g}_0, \mathfrak{g}_0]$ is a special linear superalgebra of rank $r - 1$ by the induction hypothesis, and thus \mathfrak{g}_0 is a general linear superalgebra.

Define the following elements of \mathfrak{g}_0 :

$$(5.1) \quad X_{ij} = ad_{e_i} \cdots ad_{e_{j-2}}(e_{j-1}), \quad i < j \leq r,$$

where $X_{j,j+1} = e_j$. In view of the general linear superalgebra structure of \mathfrak{g}_0 , we conclude that \mathfrak{g}_1 is isomorphic to the irreducible \mathfrak{g}_0 -module with lowest weight α_r (which is in fact the natural module possibly upon a parity change) if and only if

$$[X_{ik}, [X_{jr}, e_r]] = 0, \quad j \neq k.$$

By using the \mathfrak{g}_0 -action, we can show that these conditions are equivalent to the relation

$$(5.2) \quad [e_{r-1}, [[e_{r-2}, e_{r-1}], e_r]] = 0$$

and the relevant relations in (3.1). For $p(r-1) = 1$, (5.2) is a higher order Serre relation associated with the sub-diagram $\times \xrightarrow{r-2} \bullet \xrightarrow{r-1} \times \xrightarrow{r} \times$ with $\text{sgn}_{r-2,r-1} = -\text{sgn}_{r-1,r}$. If $p(r-1) = 0$, it can be derived from

$$(5.3) \quad [e_{r-1}, [e_{r-1}, e_r]] = 0,$$

which is a standard Serre relation.

Consider $\wedge_{\mathfrak{s}}^2 \mathfrak{g}_1$, which is an irreducible \mathfrak{g}_0 -module. The lowest weight vector is

$$\begin{aligned} e_r \otimes e_r, & \quad \text{if } p(r) = 1, \quad \text{or} \\ e_r \otimes [e_{r-1}, e_r] - [e_{r-1}, e_r] \otimes e_r, & \quad \text{if } p(r) = 0. \end{aligned}$$

Thus $\mathfrak{g}_2 = 0$ if and only if

$$(5.4) \quad \begin{aligned} [e_r, e_r] = 0, & \quad \text{if } p(r) = 1, \quad \text{or} \\ [e_r, [e_r, e_{r-1}]] = 0, & \quad \text{if } p(r) = 0, \end{aligned}$$

both of which are standard Serre relations. This proves that Lemma 3.8, and hence Theorem 3.10, are valid at rank r .

Remark 5.2. The proof presented here includes an alternative proof for Serre's theorem in the case of \mathfrak{sl}_n . This can be generalised to all finite dimensional simple Lie algebras. In particular, the proof for the other classical Lie algebras can be extracted from the next two sections.

5.2. Proof in type B. Consider the first Dynkin diagram of type B in Table 2, where the last (that is, r -th) node is white, and take $d = r$. In this case, \mathfrak{g}_0 is a general linear superalgebra, and we have already obtained a Serre presentation for it in Section 5.1.

We require \mathfrak{g}_1 be isomorphic to the irreducible \mathfrak{g}_0 -module with lowest weight α_r , which is in fact the natural module for \mathfrak{g}_0 . This is achieved by relations formally the same as (5.2) or (5.3).

As \mathfrak{g}_0 -module, \mathfrak{g}_2 is isomorphic to $\wedge_{\mathfrak{s}}^2 \mathfrak{g}_1$, which is irreducible with the lowest weight vector $E := [e_r, [e_r, e_{r-1}]]$. Now $\mathfrak{g}_3 = 0$ if and only if $[E, \mathfrak{g}_1] = 0$. This in particular requires that

$$(5.5) \quad (\text{ad}_{e_r})^3(e_{r-1}) = 0.$$

We shall show that this in fact is the necessary and sufficient condition.

If $p(r-1) = 1$, then $[E, [e_{r-1}, e_r]] = 0$ trivially since $[e_{r-1}, e_{r-1}] = 0$ in \mathfrak{g}_0 . For $K = [e_{r-2}, [e_{r-1}, e_r]]$, we also have $[K, E] = 0$. This follows from $[K, e_{r-1}] = 0$, which is one of the higher order Serre relations associated with a sub-diagram of type A . Applying ad_{e_r} to it twice and using (5.5), we obtain the desired relation. These relations imply that $[X, E] = 0$ for all $X \in \mathfrak{g}_1$ in this case. If $p(r-1) = 0$, the fact that $[X, E] = 0$, for all $X \in \mathfrak{g}_1$, follows from

$$[[e_{r-1}, e_r], [[e_{r-1}, e_r], e_r]] = 0,$$

which can be derived from (5.5).

The other Dynkin diagram (where the last node is black) can be treated in essentially the same way. We omit the details.

5.3. Proof in types C and D. The Dynkin diagrams of type C formally have the same forms as two of the Dynkin diagrams of D. The only difference is in the numbers of grey nodes, see Remark A.1. This enables us to treat both types of Lie superalgebras simultaneously.

5.3.1. *Case 1.* Consider the Dynkin diagram

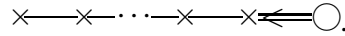

We label the nodes from left to right, thus r -the node is the one at the right end. Set $d = r$, then \mathfrak{g}_0 is a general linear superalgebra.

As a \mathfrak{g}_0 -module, \mathfrak{g}_1 is generated by e_r . We require it be isomorphic to the irreducible module \bar{L}_{α_r} with lowest weight α_r . Appendix B.2 describes the structure of the generalised Verma module \bar{V}_{α_r} with lowest weight α_r and the irreducible quotient \bar{L}_{α_r} . We immediately see that the relevant relations in (3.1) and the relations

$$(5.6) \quad [X_{ir}, [X_{jr}, [X_{kr}, e_r]]] = 0, \quad \forall i \leq j \leq k \leq r - 1,$$

are necessary and sufficient conditions to guarantee that $\mathfrak{g}_1 \cong \bar{L}_{\alpha_r}$. Here X_{ir} are elements of \mathfrak{g}_0 defined by (5.1). The conditions (5.6) are equivalent to

$$(5.7) \quad \begin{aligned} [e_{r-1}, [e_{r-1}, [e_{r-1}, e_r]]] &= 0, && \text{if } e_{r-1} \text{ is even,} \\ [X_{r-2,r}, [X_{r-2,r}, [e_{r-1}, e_r]]] &= 0, && \text{if } e_{r-1}, e_{r-2} \text{ are both odd,} \\ [X_{r-3,r}, [X_{r-2,r}, [e_{r-1}, e_r]]] &= 0, && \text{if } e_{r-1} \text{ is odd, } e_{r-2} \text{ is even} \end{aligned}$$

because of the \mathfrak{g}_0 -action. Here Remark B.1 is also in force.

Note that the different situations where the relations apply are mutually exclusive. The first relation is a standard Serre relation. The second and third are higher order Serre relations respectively associated with the sub-diagrams

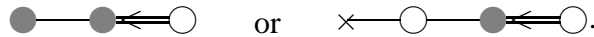

Recall that \mathfrak{g}_2 is the image of $\wedge_s^2 \mathfrak{g}_1$ under the Lie superbracket. As \mathfrak{g}_0 -module, $\wedge_s^2 \mathfrak{g}_1$ is irreducible with the lowest weight vector $e_r \otimes [e_{r-1}, e_r] - [e_{r-1}, e_r] \otimes e_r$. Thus $\mathfrak{g}_2 = 0$ if and only if

$$(5.8) \quad [e_r, [e_r, e_{r-1}]] = 0.$$

This is again a standard Serre relation.

5.3.2. *Case 2.* Now we consider the case with the Dynkin diagram

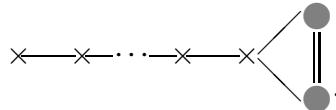

Let us first assume that $r = 3$. We have the Dynkin diagram of $\mathfrak{osp}_{2|4}$ (resp. $\mathfrak{osp}_{4|2}$) if $p(1) = 0$ (resp. $p(1) = 1$). Label by 1 the node marked by \times , and take $d = 1$. The diagram obtained by deleting this node is

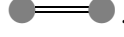

This is a non-standard diagram of $\mathfrak{osp}_{2|2} \cong \mathfrak{sl}_{2|1}$. Equation (3.1) by itself suffices to define this Lie superalgebra.

Now $\mathfrak{g}_0 = \mathfrak{osp}_{2|2} \oplus \mathfrak{gl}_1$ (isomorphic to $\mathfrak{gl}_{2|1}$). Let $\bar{\mathfrak{b}}_0$ be the Borel subalgebra of \mathfrak{g}_0 generated by f_2, f_3 and all h_i , and define the lowest weight Verma module $\bar{V}_{\alpha_1} := U(\mathfrak{g}_0) \otimes_{U(\bar{\mathfrak{b}}_0)} \mathbb{C}_{\alpha_1}$ for \mathfrak{g}_0 , where \mathbb{C}_{α_1} is the irreducible $\bar{\mathfrak{b}}_0$ -module with lowest weight α_1 . Direct computations show that the maximal submodule M_{α_1} is generated by the vector $(e_2 e_3 - e_3 e_2) \otimes 1$. The irreducible quotient \bar{L}_{α_1} is four dimensional, with a basis consisting of the images of $1 \otimes 1, e_2 \otimes 1, e_3 \otimes 1$, and $[e_2, e_3] \otimes 1$. Its restriction to $\mathfrak{osp}_{2|2}$ is the natural module.

We need $\mathfrak{g}_1 \cong \bar{L}_{\alpha_1}$, possibly up to a parity change depending on the parity of e_1 . From the description of \bar{V}_{α_1} and M_{α_1} above, we see that the necessary and sufficient conditions are the relevant quadratic relations involving e_1 in (3.1), and

$$(5.9) \quad [e_2, [e_3, e_1]] - [e_3, [e_2, e_1]] = 0.$$

Note that this is a higher order Serre relation associated with the sub-diagram (6) given in Theorem 3.11.

To proceed further, we need to specify the parity of e_1 .

If e_1 is even, the Lie superalgebra $L(A, \Theta)$ is $\mathfrak{osp}_{2|4}$. Now $\wedge_s^2 \mathfrak{g}_1$ is the direct sum of a seven dimensional indecomposable \mathfrak{g}_0 -submodule and a one dimensional \mathfrak{g}_0 -submodule. The seven dimensional submodule is generated by the two lowest weight vectors

$$e_1 \otimes [e_2, e_1] - [e_2, e_1] \otimes e_1, \quad e_1 \otimes [e_3, e_1] - [e_3, e_1] \otimes e_1,$$

and the one dimensional submodule by

$$[e_2, e_1] \otimes [e_3, e_1] + [e_3, e_1] \otimes [e_2, e_1] + e_1 \otimes [[e_2, e_3], e_1] - [[e_2, e_3], e_1] \otimes e_1.$$

In this case, we need \mathfrak{g}_2 to be isomorphic to a one dimensional \mathfrak{g}_0 -module with weight $2\alpha_1 + \alpha_2 + \alpha_3$. Thus the seven dimensional indecomposable submodule of $\wedge_s^2 \mathfrak{g}_1$ is sent to zero by the Lie superbracket, or equivalently,

$$(5.10) \quad [e_1, [e_1, e_2]] = 0, \quad [e_1, [e_1, e_3]] = 0,$$

which are standard Serre relations. The image of the one dimensional submodule is \mathfrak{g}_2 , which is spanned by

$$[[e_1, e_2], [e_1, e_3]] - [e_1, [e_1, [e_2, e_3]]] = -[[e_1, e_2], [e_1, e_3]],$$

where (5.10) is used to obtain the identity. By using (5.9) and (5.10), one can easily show that $[\mathfrak{g}_2, \mathfrak{g}_1] = 0$, and hence $\mathfrak{g}_3 = 0$.

If e_1 is odd, the Lie superalgebra $L(A, \Theta)$ is $\mathfrak{osp}_{4|2}$. By dimension counting, we need $\mathfrak{g}_2 = 0$. Now $\wedge_s^2 \mathfrak{g}_1$ is also a direct sum of a seven dimensional indecomposable \mathfrak{g}_0 -submodule and a one dimensional submodule. Given the condition $[e_1, e_1] = 0$, the seven dimensional submodule vanishes automatically under the Lie superbracket, and the image of the one dimensional submodule is spanned by $[[e_1, e_2], [e_1, e_3]]$. Taking the Lie superbracket of e_1 with both sides of (5.9), we obtain $[[e_1, e_2], [e_1, e_3]] = 0$. Hence $\mathfrak{g}_2 = 0$.

Now assume $r \geq 4$. We take $d = r - 3$, then \mathfrak{g}_0 is the direct sum of a general linear superalgebra and $\mathfrak{osp}_{4|2}$ or $\mathfrak{osp}_{2|4}$.

If e_{r-2} is even, the condition that \mathfrak{g}_1 is an irreducible \mathfrak{g}_0 -module of lowest weight α_{r-3} is given by the relevant relations in (3.1),

$$[e_{r-2}, [e_{r-2}, e_{r-3}]] = 0,$$

and also

$$(5.11) \quad \begin{aligned} [e_{r-4}, [e_{r-4}, e_{r-3}]] &= 0, & \text{if } p(r-4) = 0, \\ [e_{r-4}, [e_{r-5}, [e_{r-4}, e_{r-3}]]] &= 0, & \text{if } p(r-4) = 1. \end{aligned}$$

As \mathfrak{g}_0 -module, $\wedge_s^2 \mathfrak{g}_1$ is the direct sum of three irreducibles. The $\mathfrak{osp}_{2|4}$ subalgebra of \mathfrak{g}_1 acts trivially on one of the irreducible submodules, and \mathfrak{g}_2 is isomorphic to it. The necessary and sufficient condition for the Lie superbracket to annihilate the other two irreducible submodules is

$$(5.12) \quad \begin{aligned} [e_{r-3}, [e_{r-3}, e_{r-2}]] &= 0, & [e_{r-3}, [e_{r-3}, e_{r-4}]] &= 0, & \text{if } p(r-3) = 0, \\ [e_{r-3}, e_{r-3}] &= 0, & [e_{r-3}, [e_{r-4}, [e_{r-3}, e_{r-2}]]] &= 0, & \text{if } p(r-3) = 1, \end{aligned}$$

as can be shown by examining lowest weight vectors of the submodules.

Remark 5.3. Let $E = [[e_{r-3}, e_{r-2}], e_{r-1}]$ and $E' = [[e_{r-3}, e_{r-2}], e_r]$. Then at least one of the vectors $[X, E]$ and $[X, E']$ vanishes for any $X \in \mathfrak{g}_1$.

Let v denote a lowest weight vector of \mathfrak{g}_2 . We can take $v = [E, E']$ if e_{r-3} is even, and $v = [[e_{r-4}, E], E']$ if e_{r-3} is odd. Then by Remark 5.3, we have $[v, X] = 0$ for any $X \in \mathfrak{g}_1$. Hence $\mathfrak{g}_3 = 0$.

If e_{r-2} is odd, the condition that \mathfrak{g}_1 is an irreducible \mathfrak{g}_0 -module of lowest weight α_{r-3} translates into the relations (5.11),

$$\begin{aligned} [e_{r-2}, [[e_{r-2}, e_{r-1}], e_{r-3}]] &= 0, \\ [e_{r-2}, [[e_{r-2}, e_r], e_{r-3}]] &= 0, \end{aligned}$$

plus the relevant relations in (3.1). Here we have used some facts about generalised Verma modules for $\mathfrak{osp}_{4|2}$.

As \mathfrak{g}_0 -module, $\wedge_s^2 \mathfrak{g}_1$ is again a direct sum of three irreducibles. One of them restricts to a direct sum of one dimensional $\mathfrak{osp}_{4|2}$ -modules, and \mathfrak{g}_2 is isomorphic to it. The other two irreducibles are both mapped to zero by the Lie superbracket. The necessary and sufficient condition for this to happen is still (5.12).

Note that Remark 5.3 remains valid in the present case if we define E and E' in the same way. Let $v = [E, E']$ if e_{r-3} is odd, and $v = [[e_{r-4}, E], E']$ if e_{r-3} is even. Then v is a nonzero lowest weight vector of \mathfrak{g}_2 . It follows from Remark 5.3 that $[v, X] = 0$ for any $X \in \mathfrak{g}_1$. Hence $\mathfrak{g}_3 = 0$.

5.3.3. *Case 3.* Finally we consider the Dynkin diagram

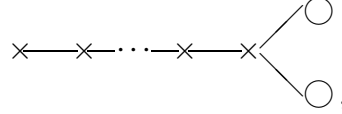

assuming that there are at least two grey nodes (as otherwise this would correspond to the distinguished root system of type D). This forces $r \geq 4$.

This case is quite easy, thus we shall be brief. We choose d to be the largest integer such that $p(d) = 1$. Then \mathfrak{g}_0 is the direct sum of a general linear superalgebra and an even dimensional orthogonal Lie algebra.

From Section 5.1, we see that the necessary and sufficient conditions for e_d (which must be odd) to generate an irreducible \mathfrak{g}_0 -module are the relevant relations in (3.1) and the higher order Serre relation involving e_d associated with the following sub-diagram

$\times \xrightarrow{d-1} \bullet \xrightarrow{d} \bullet$ of the Dynkin diagram if $p(d-1) = 1$. Note that if $d = 2$, this becomes vacuous.

As \mathfrak{g}_0 -module, \mathfrak{g}_1 is the tensor product of the natural modules V_A and V_D respectively for the general linear superalgebra and orthogonal algebra contained in \mathfrak{g}_0 . Here V_D is purely even, and the grading of V_A gives rise to the grading of \mathfrak{g}_1 .

Now $\wedge_s^2 \mathfrak{g}_1 \cong \wedge_s^2(V_A) \otimes (S^2(V_D)/\mathbb{C}) \oplus S_s^2(V_A) \otimes \wedge^2(V_D) \oplus \wedge_s^2(V_A) \otimes \mathbb{C}$ as \mathfrak{g}_0 -module. The images of the first two irreducibles under the Lie superbracket are set to zero by the relation $[e_d, e_d] = 0$ and the higher order Serre relation(s) associated with the sub-diagram(s) of the form $\times \xrightarrow{d-1} \bullet \xrightarrow{d} \circ$. Note that if $d < r - 2$, there is only one such diagram, but there are two if $d = r - 2$, as the last node can be $(r - 1)$ or r . We have $\mathfrak{g}_2 \cong \wedge_s^2(V_A) \otimes \mathbb{C}$.

One can show that $[\mathfrak{g}_2, \mathfrak{g}_1] = 0$ by using the same arguments as those in Section 4.1.3 and Section 4.1.4, thus $\mathfrak{g}_3 = 0$.

5.4. **Proof in type $F(4)$.** Now we turn to $F(4)$, which is considerably more complicated than the other type of Lie superalgebras.

5.4.1. *Case 1.* Consider first the root system corresponding to the Dynkin diagram

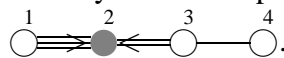

We take $d = 2$. Then $\mathfrak{g}_0 = \mathfrak{sl}_2 \oplus \mathfrak{gl}_3$. The standard Serre relations plus the relevant relations in (3.1) are the necessary and sufficient conditions rendering the \mathfrak{g}_0 -module \mathfrak{g}_1 irreducible. We have $\mathfrak{g}_1 \cong \mathbb{C}^2 \otimes \mathbb{C}^3$ up to a parity change.

As \mathfrak{g}_0 -module, $\wedge_s^2 \mathfrak{g}_1$ is a direct sum of two irreducibles. The condition $[e_2, e_2] = 0$ forces one of the irreducibles to be in the kernel of the map $\wedge_s^2 \mathfrak{g}_1 \rightarrow \mathfrak{g}_2$. Thus \mathfrak{g}_2 is an irreducible \mathfrak{g}_0 -module generated by the lowest weight vector $E = [[e_1, e_2], [e_2, e_3]]$. We have $\mathfrak{g}_2 = \mathbb{C} \otimes \wedge^2(\mathbb{C}^3)$.

Now $\mathfrak{g}_3 = [\mathfrak{g}_2, \mathfrak{g}_1] \cong \mathbb{C}^2 \otimes \mathbb{C}$ with a basis consisting of vectors $[E, [e_2, [e_3, e_4]]]$ and $[E, [E', e_4]]$, where $E' = [e_1, [e_2, e_3]]$. One immediately sees that

$$[\mathfrak{g}_3, e_2] = \mathbb{C}[E, [E, e_4]],$$

which generates $\mathfrak{g}_4 = \mathbb{C} \otimes \mathbb{C}^3$.

To consider \mathfrak{g}_5 , we only need to look at $[\mathfrak{g}_4, \mathfrak{g}_1]$. If $X \in \mathfrak{g}_1$ is any lowest weight vector for $\mathfrak{sl}_2 \subset \mathfrak{g}_0$, the higher order Serre relation associated with the Dynkin diagram (see diagram (7) in Theorem 3.11) renders $[\mathfrak{g}_4, X] = 0$. Since the \mathfrak{sl}_2 subalgebra of \mathfrak{g}_0 acts trivially on \mathfrak{g}_4 , it follows that $[\mathfrak{g}_4, \mathfrak{g}_1] = 0$, that is, $\mathfrak{g}_5 = 0$.

5.4.2. *Case 2.* For the Dynkin diagram

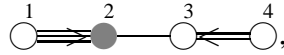

we also take $d = 2$ as in the previous case. Then $\mathfrak{g}_0 = \mathfrak{gl}_2 \oplus \mathfrak{sp}_4$. The relevant relations in (3.1) and standard Serre relations guarantee that e_2 generates an irreducible \mathfrak{g}_0 -module, which is isomorphic to the tensor product $\mathbb{C}^2 \otimes \mathbb{C}^4$ of the natural modules for \mathfrak{gl}_2 and \mathfrak{sp}_4 up to a parity change.

Now $\wedge_s^2 \mathfrak{g}_1$ decomposes into the direct sum of three irreducible \mathfrak{g}_0 -modules, which are respectively isomorphic to $S^2(\mathbb{C}^2) \otimes S^2(\mathbb{C}^4)$, $\wedge^2(\mathbb{C}^2) \otimes (\wedge^2(\mathbb{C}^2)/\mathbb{C})$ and $\wedge^2(\mathbb{C}^2) \otimes \mathbb{C}$. The necessary and sufficient conditions for the Lie superbracket to map the first and the third submodules to zero are $[e_2, e_2] = 0$ and the higher order Serre relation

$$(5.13) \quad [[e_1, e_2], [[e_2, e_3], [e_3, e_4]]] - [[e_2, e_3], [[e_1, e_2], [e_3, e_4]]] = 0$$

associated with the Dynkin diagram (see diagram (8) in Theorem 3.11). Now \mathfrak{g}_2 is isomorphic to $\wedge^2(\mathbb{C}^2) \otimes \frac{\wedge^2(\mathbb{C}^2)}{\mathbb{C}}$ with lowest weight vector

$$E = [[e_1, e_2], [e_2, e_3]].$$

Formally $[\mathfrak{g}_2, \mathfrak{g}_1]$ decomposes into the direct sum of two irreducibles, respectively having lowest weight vectors

$$[E, e_2], \quad [e_2, [E, [e_3, e_4]]].$$

The first vector vanishes by $[e_2, e_2] = 0$. The second vector is the supercommutator of e_2 with the left hand side of (5.13), thus is also zero. This shows that $\mathfrak{g}_3 = 0$.

5.4.3. *Case 3.* Consider the Dynkin diagram

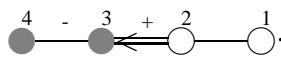

We take $d = 4$, and delete the 4-th node from the diagram to obtain

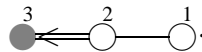

This is a non-standard diagram for $\mathfrak{sl}_{1|3}$, where the double edges can be got rid of by a normalisation of the bilinear form on the weight space thus are immaterial. The presentation for $\mathfrak{sl}_{1|3}$ involves no higher order Serre relation. We have $\mathfrak{g}_0 = \mathfrak{gl}_{1|3}$.

Let $\bar{\mathfrak{p}}$ be the lower triangular maximal parabolic subalgebra of \mathfrak{g}_0 with Levi subalgebra $\mathfrak{l} := \mathfrak{gl}_3 \oplus \mathfrak{gl}_1$. Let $\bar{L}_{\alpha_4}^0 = \mathbb{C}v_0$ be the 1-dimensional $\bar{\mathfrak{p}}$ -module with lowest weight α_4 , which is assume to be a purely odd superspace. Since α_4 is a typical \mathfrak{g}_0 weight, the generalised Verma module $\bar{V}_{\alpha_4} = U(\mathfrak{g}_0) \otimes_{U(\bar{\mathfrak{p}})} \bar{L}_{\alpha_4}^0$ is irreducible, i.e., $\bar{L}_{\alpha_4} = \bar{V}_{\alpha_4}$. It is multiplicity free, and the set of weights is given by

$$(5.14) \quad \Delta^+ \setminus \{ \Delta^+(\mathfrak{g}_0) \cup \Delta_2^+ \},$$

where Δ^+ is the set of the positive roots of $F(4)$ relative to the Borel subalgebra under consideration, $\Delta^+(\mathfrak{g}_0)$ is the set of the positive roots of the subalgebra \mathfrak{g}_0 , and

$$(5.15) \quad \Delta_2^+ = \left\{ \frac{1}{2}(\delta + \varepsilon_1 + \varepsilon_2 + \varepsilon_3), \varepsilon_i + \varepsilon_j, i \neq j \right\}.$$

The \mathfrak{g}_0 -module $\wedge_s^2 \bar{L}_{\alpha_4}$ is not semi-simple. To avoid the laborious task of determining the indecomposable submodules, we simply examine the \mathfrak{l} lowest weight vectors in $\wedge_s^2 \bar{L}_{\alpha_4}$. Of particular importance to us are the vectors

$$\begin{aligned} z_1 &:= v_0 \otimes v_0; \\ z_2 &:= e_3 v_0 \otimes [e_2, e_3] e_3 v_0 - [e_2, e_3] e_3 v_0 \otimes e_3 v_0; \\ z_3 &:= v_0 \otimes e_3 v_0 - e_3 v_0 \otimes v_0; \\ w_1 &:= v_0 \otimes [e_2, e_3] e_3 v_0 + [e_2, e_3] e_3 v_0 \otimes v_0; \\ w_2 &:= v_0 \otimes [e_1, [e_2, e_3]] [e_2, e_3] e_3 v_0 - [e_1, [e_2, e_3]] [e_2, e_3] e_3 v_0 \otimes v_0. \end{aligned}$$

The space of \mathfrak{l} -lowest weight vectors of $\wedge_s^2 \bar{L}_{\alpha_4}$ is spanned by w_1 , w_2 and the \mathfrak{l} -lowest weight vectors in the \mathfrak{g}_0 -submodule M generated by z_1 and z_2 . It is important to observe that w_1 and w_2 are not in M , but $w_1 \in U(\mathfrak{g}_0)w_2$. Furthermore, one can verify that $\wedge_s^2 \bar{L}_{\alpha_4}/M$ is multiplicity free with the set of weights Δ_2^+ .

Now we take $v_0 = e_4$ and require $\bar{\mathfrak{p}}$ act on it by the adjoint action. Then $\mathfrak{g}_1 = \bar{L}_{\alpha_4}$. We require that the Lie superbracket maps z_1 and z_2 to zero. This leads to the following relations:

$$(5.16) \quad \begin{aligned} [e_4, e_4] &= 0; \\ [[e_3, e_4], [[e_3, e_4], [e_2, e_3]]] &= 0. \end{aligned}$$

Under the first condition, the Lie superbracket automatically maps z_3 to zero. Note that the second relation in equation (5.16) is the desired higher order Serre relation associated with the sub-diagram

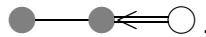

The vectors w_1 and w_2 have non-zero images under the Lie superbracket, and we have $\mathfrak{g}_2 \cong \wedge_s^2 \bar{L}_{\alpha_4}/M$. By considering the possible l -lowest weight vectors, we can show that $[\mathfrak{g}_1, \mathfrak{g}_2] = 0$, thus $\mathfrak{g}_3 = 0$.

Now the proof of Lemma 3.8 in this case is completed by comparing the weights in (5.14) and (5.15) with the roots in L_1 and L_2 .

5.4.4. *Case 4.* Consider the Dynkin diagram

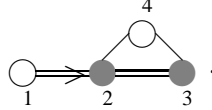

Take $d = 1$, then $\mathfrak{g}_0 = \mathfrak{osp}_{2|4} \oplus \mathfrak{gl}_1$. The presentation of $\mathfrak{osp}_{2|4}$ relative to the Dynkin diagram

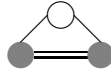

has been constructed, thus the defining relations among e_i, f_i, h_i for $i > 1$ are all known. The parabolic subalgebra of $\mathfrak{osp}_{2|4}$ defined in Appendix B.1 together with the ideal \mathfrak{gl}_1 form a parabolic of \mathfrak{g}_0 . Then e_1 spans a 1-dimensional module for this parabolic, which induces a generalised Verma module \bar{V}_{α_1} of lowest weight type for \mathfrak{g}_0 . The structure of \bar{V}_{α_1} can be understood by using results of Section B.1. In particular, imposing the condition (B.1), which in the present case reads

$$(5.17) \quad [e_2, [[e_2, e_3], e_1]] = 0,$$

sends \bar{V}_{α_1} to the irreducible quotient, which is \mathfrak{g}_1 . Note that (5.17) is a higher order Serre relation associated with diagram (9) in Theorem 3.11. It is a non-standard diagram of $\mathfrak{sl}_{1|3}$.

Now \mathfrak{g}_1 forms a 10-dimensional. A basis for it can be deduced from Section B.1. For every vector b in this basis, we have $[b, e_1] = 0$. This holds trivially for most basis vectors, but for $b = [e_2, [[[e_1, e_2], e_3], e_4]]$, we have

$$\begin{aligned} [e_1, b] &= [[[[e_1, e_2], e_3], [e_1, e_2], e_4]] \\ &= \frac{1}{2} (ad_{e_1})^2 [[e_2, e_3], [e_2, e_4]]. \end{aligned}$$

One can deduce from the defining relations for $\mathfrak{osp}_{2|4}$ that $[[e_2, e_3], [e_2, e_4]] = 0$, hence $[b, e_1] = 0$. This implies that the commutator of e_1 with all the remaining basis vectors are all zero. Therefore, $\mathfrak{g}_2 = [\mathfrak{g}_1, \mathfrak{g}_1] = 0$.

5.4.5. *Case 5.* In the case of the Dynkin diagram

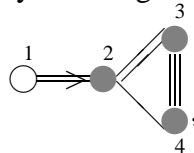

we take $d = 4$ and delete the 4-th node to obtain the diagram

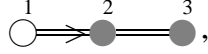

which is a non-standard diagram of $\mathfrak{sl}_{1|3}$. Thus we have a relation formally the same as (5.17).

Now $\mathfrak{g}_0 = \mathfrak{gl}_{1|3}$. The Verma module of lowest weight type for \mathfrak{g}_0 generated by e_4 contains the primitive vector $2[e_2, [e_3, e_4]] - 3[[e_2, e_3], e_4]$, which generates the maximal submodule. Thus the higher order Serre relation

$$(5.18) \quad 2[e_2, [e_3, e_4]] - 3[[e_3, e_2], e_4] = 0,$$

associated with diagram (10) in Theorem 3.11, is all that is needed to guarantee that \mathfrak{g}_1 is an irreducible \mathfrak{g}_0 -module. This module is typical relative to the distinguished Borel subalgebra, and has dimension 8.

Restricted to a module for $\mathfrak{gl}_3 \subset \mathfrak{g}_0$, the even subspace of \mathfrak{g}_1 is the direct sum of the natural \mathfrak{gl}_3 -module and a 1-dimensional module, while the odd subspace is the direct sum of the dual natural module (twisted by a scalar) and a 1-dimensional module.

Now consider $[\mathfrak{g}_1, \mathfrak{g}_1]$. We can easily work out its decomposition into irreducible \mathfrak{gl}_3 -submodules. The corresponding \mathfrak{gl}_3 lowest weight vectors can be worked out, which include the following vectors:

$$[e_2, e_2], \quad (ad_{[e_2, e_4]})^2 [e_2, e_1], \quad [[e_2, e_4], [e_3, e_4]].$$

It follows from the higher order Serre relation (5.18) that

$$[[e_2, e_4], [e_3, e_4]] = 0.$$

Now we impose the relations

$$[e_2, e_2] = 0, \quad (ad_{[e_2, e_4]})^2 [e_2, e_1] = 0,$$

where the first is a standard Serre relation, and the second is a higher order Serre relations associated with

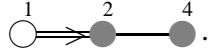

Under these conditions, all other \mathfrak{gl}_3 lowest vectors in $[\mathfrak{g}_1, \mathfrak{g}_1]$ vanish, except

$$(ad_{[e_2, e_4]})^2 e_1, \quad [[e_3, e_4], [[e_1, e_2], [e_2, e_4]]],$$

where the first one is actually a \mathfrak{g}_0 lowest weight vector. It generates an 4-dimensional irreducible \mathfrak{g}_0 -module containing the second vector. This module is isomorphic to the dual of the natural \mathfrak{g}_0 -module twisted by a scalar. This gives us $\mathfrak{g}_2 = [\mathfrak{g}_1, \mathfrak{g}_1]$. We can further show that $[\mathfrak{g}_2, e_4] = 0$, hence $\mathfrak{g}_3 = 0$.

5.5. Proof in type $G(3)$.

5.5.1. *Case 1.* Consider the Dynkin diagram

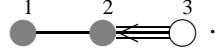

We take $d = 3$, then $\mathfrak{g}_0 = \mathfrak{gl}_{2|1}$. Let \bar{V}_{α_3} be the lowest weight Verma module for $\mathfrak{g}_0 = \mathfrak{gl}_{2|1}$ with lowest weight α_3 . Denote by v_0 the lowest weight vector, which is assumed to be even. Then the maximal submodule of \bar{V}_{α_3} is generated by $e_1 v_0$ and $e_2 [e_1, e_2]^3 v_0$. The irreducible quotient \bar{L}_{α_3} is multiplicity free and has weights

$$\begin{aligned} \alpha_3 + k(\alpha_1 + \alpha_2), & \quad k = 0, 1, 2, 3, \\ \alpha_3 + p(\alpha_1 + \alpha_2) + \alpha_2, & \quad p = 0, 1, 2. \end{aligned}$$

In fact \bar{L}_{α_3} is isomorphic to the third \mathbb{Z}_2 -graded symmetric power of the natural module for \mathfrak{g}_0 tensored with a 1-dimensional module. Thus $\wedge_s^2 \bar{L}_{\alpha_3}$ is completely reducible; it is the direct sum of two irreducibles.

Now we take v_0 to be e_3 , and let \mathfrak{g}_0 act on it by the adjoint action. Then the generators of the maximal submodule of \bar{V}_{α_3} in this case are $(ad_{[e_1, e_2]})^3 [e_2, e_3]$ and $[e_1, e_3]$. Thus $[e_1, e_3] = 0$ and the higher order Serre relation

$$(5.19) \quad (ad_{[e_1, e_2]})^3 [e_2, e_3] = 0$$

(associated with diagram (11) in Theorem 3.11) render $\mathfrak{g}_1 = \bar{L}_{\alpha_3}$.

One of the irreducible submodules of $\wedge_s^2 \mathfrak{g}_1$ has a lowest weight vector of the form $e_3 \otimes [e_2, e_3] - [e_2, e_3] \otimes e_2$. We require that this submodule be in the kernel of the Lie superbracket. This leads to the standard Serre relation $[e_3, [e_3, e_2]] = 0$.

The other irreducible submodule of $\wedge_s^2 \mathfrak{g}_1$ is mapped surjectively onto \mathfrak{g}_2 . A lowest weight vector of \mathfrak{g}_2 is given by $\bar{X} := ad_{e_3} (ad_{[e_1, e_2]})^2 [e_2, e_3]$. This irreducible module is 4-dimensional and has weights

$$-(2\varepsilon_3 - \varepsilon_1 - \varepsilon_2), \quad \delta + \varepsilon_2 - \varepsilon_3, \quad \delta + \varepsilon_1 - \varepsilon_3, \quad 2\delta,$$

in the notation explained in Appendix A.1. It is easy to see that $[X, \bar{X}] = 0$ for all $X \in \mathfrak{g}_1$. Thus $\mathfrak{g}_3 = 0$.

By examining the weights of \mathfrak{g}_1 and \mathfrak{g}_2 , we see that Lemma 3.8 holds.

5.5.2. *Case 2.* Consider the Dynkin diagram

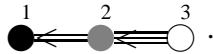

We take $d = 1$, and delete the first node from the Dynkin diagram to obtain

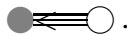

This is a nonstandard diagram for $\mathfrak{sl}_{1|2}$, which can be cast into the usual Dynkin diagram of $\mathfrak{sl}_{1|2}$ in the distinguished root system by normalising the bilinear form on the weight space. Note that no higher order Serre relations are required to present this Lie superalgebra. We have $\mathfrak{g}_0 = \mathfrak{gl}_{1|2}$.

Now the \mathfrak{g}_0 Kac module of lowest weight type generated by e_1 is typical thus irreducible, hence $\mathfrak{g}_1 \cong \overline{L}_{\alpha_1}$ with basis

$$e_1, [e_2, e_1], [[e_2, e_3], e_1], [[e_2, e_3], [e_2, e_1]].$$

As \mathfrak{g}_0 -module $\wedge_s^2 \mathfrak{g}_1$ is the direct sum of two irreducible typical submodules, respectively generated by the lowest weight vectors $e_1 \otimes e_1$ and $v - \frac{1}{2}v'$, where

$$\begin{aligned} v &= e_1 \otimes [[e_2, e_3], [e_2, e_1]] + [[e_2, e_3], [e_2, e_1]] \otimes e_1, \\ v' &= [e_2, e_1] \otimes [e_3, [e_2, e_1]] - [e_3, [e_2, e_1]] \otimes [e_2, e_1]. \end{aligned}$$

We require that $v - \frac{1}{2}v'$ and thus the \mathfrak{g}_0 -submodule generated by it be mapped to zero by the Lie superbracket. This leads to

$$[[e_2, e_1], [e_3, [e_2, e_1]]] - [[e_2, e_3], [[e_1, e_1], e_2]] = 0,$$

which is one of the higher order Serre relations associated with the Dynkin diagram (see diagram (12) in Theorem 3.11). Therefore, $\mathfrak{g}_2 \cong \overline{L}_{2\alpha_1}$ and has a basis

$$[e_1, e_1], [[e_1, e_1], e_2], [e_3, [[e_1, e_1], e_2]], [[e_2, e_3], [[e_1, e_1], e_2]].$$

Now we consider $[\mathfrak{g}_2, \mathfrak{g}_1]$. One can easily see that $(ad_{e_1})^3 e_2$ is a \mathfrak{g}_0 lowest weight vector. We require that the \mathfrak{g}_0 -submodule generated by it be zero, hence we have the standard Serre relation

$$(ad_{e_1})^3 e_2 = 0.$$

This leaves $\mathfrak{g}_3 = [\mathfrak{g}_2, \mathfrak{g}_1]$ to be an indecomposable \mathfrak{g}_0 -module cyclically generated by the lowest weight vector $[[e_1, [e_2, e_3]], [[e_1, e_1], e_2]]$, which is 7-dimensional and multiplicity free. One can easily write down a basis for this module. We should remark that no \mathfrak{g}_0 lowest weight vector in \mathfrak{g}_3 is annihilated by all f_i for $i = 1, 2, 3$.

One can show by direct computations that $[e_1, \mathfrak{g}_3] = 0$ and $[[e_1, e_1], \mathfrak{g}_2] = 0$. Hence $\mathfrak{g}_4 = 0$.

An inspection of the weight spaces of \mathfrak{g}_i for $1 \leq i \leq 3$ shows that they agree with those of L_i for $1 \leq i \leq 3$. This completes the proof in this case.

5.5.3. *Case 3.* The final case of $G(3)$ is the diagram

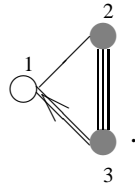

We take $d = 3$, then $\mathfrak{g}_0 = \mathfrak{gl}_{2|1}$. The \mathfrak{g}_0 Kac module of lowest weight generated by e_3 is atypical. We set the primitive vector to zero to obtain

$$2[[e_1, e_2], e_3] - [e_2, [e_1, e_3]] = 0,$$

which is a higher order Serre relation in the present case. Then \mathfrak{g}_1 is an irreducible \mathfrak{g}_0 -module with lowest weight α_3 , which is isomorphic to the third \mathbb{Z}_2 -graded symmetric power of the natural module for \mathfrak{g}_0 twisted by a scalar. It has 3 odd and 4 even dimensions. A basis for \mathfrak{g}_1 is given by

$$\begin{aligned} e_3, \quad [e_1, e_3], \quad [e_1, [e_1, e_3]], \quad [e_2, e_3], \\ [[e_1, e_2], e_3], \quad [[e_1, e_2], [e_1, e_3]], \quad [[e_1, e_2], [e_1, [e_1, e_3]]]. \end{aligned}$$

The rest of the analysis is similar to Section 5.5.1. Now $\wedge_s^2 \mathfrak{g}_1$ is the direct sum of two irreducible \mathfrak{g}_0 -submodules. The images of their lowest weight vectors in $[\mathfrak{g}_1, \mathfrak{g}_1]$ are respectively $[e_3, e_3]$ and $E = [[e_1, e_3], [e_1, e_3]]$. Both generate typical \mathfrak{g}_0 -submodules, which respectively have dimensions 20 and 4. The standard Serre relation $[e_3, e_3] = 0$ removes the 20-dimensional submodule, thus \mathfrak{g}_2 is the 4-dimensional irreducible \mathfrak{g}_0 -module generated by E .

We can also show that $\mathfrak{g}_3 = 0$ without imposing further relations. Inspecting the weights of \mathfrak{g}_1 and \mathfrak{g}_2 , we see that the claim of Lemma 3.8 indeed holds.

5.6. Proof in type $D(2, 1; \alpha)$. The Dynkin diagrams having only one grey node can be treated in exactly the same way as for the distinguished root system, thus we shall consider only the diagram with three gray nodes here. Set $d = 3$, then $\mathfrak{g}_0 = \mathfrak{gl}_{2|1}$. The \mathfrak{g}_0 Verma module of lowest weight type generated by e_3 contains the primitive vector

$$\alpha[e_1, [e_2, e_3]] + (1 + \alpha)[e_2, [e_1, e_3]],$$

which in fact generates the maximal submodule. The higher order Serre relation requires this vector to be zero. This is equivalent to taking the irreducible quotient of the Verma module, and we obtain \mathfrak{g}_1 . A basis for \mathfrak{g}_1 is

$$e_3, \quad [e_1, e_3], \quad [e_2, e_3], \quad [e_1, [e_2, e_3]].$$

An easy computation using the higher order Serre relation shows that $[\mathfrak{g}_1, e_3] = 0$. Hence $\mathfrak{g}_2 = 0$. A quick inspection on the weights of \mathfrak{g}_1 shows that Lemma 3.8 indeed holds in this case.

6. REMARKS ON AFFINE LIE SUPERALGEBRAS

We wish to mention that the generalisation of the method to affine Lie superalgebras is in principle straightforward conceptually. Consider, for example, the untwisted affine superalgebra $\hat{\mathfrak{g}}$ of a contragredient Lie superalgebra \mathfrak{g} . We want to present $\hat{\mathfrak{g}}$ with the standard generators e_i, f_i, h_i with $0 \leq i \leq r$ and relations. Here the generators e_i, f_i, h_i with $1 \leq i \leq r$ are those for \mathfrak{g} . By results of earlier sections, we may assume that all the Serre relations and higher order ones obeyed by e_i and f_i with $1 \leq i \leq r$ are given.

We introduce the standard \mathbb{Z} -grading of $\hat{\mathfrak{g}}$ by decreeing that all h_j and e_i, f_i with $1 \leq i \leq r$ have degree 0, but e_0 and f_0 have degrees 1 and -1 respectively. Then $\hat{\mathfrak{g}} = \bigoplus_{k \in \mathbb{Z}} \hat{\mathfrak{g}}_k$, with $\hat{\mathfrak{g}}_0 = \mathfrak{g} \oplus \mathfrak{gl}_1$. Now we require that as $\hat{\mathfrak{g}}_0$ -modules, all $\hat{\mathfrak{g}}_k$ are isomorphic

to \mathfrak{g} . The (necessary and sufficient) conditions meeting this requirement give rise to the defining relations of $\hat{\mathfrak{g}}$.

To illustrate how this may work, we consider the untwisted affine algebra $\hat{\mathfrak{g}} = \hat{\mathfrak{sl}}_{r+1}$. The relations

$$[e_1, [e_1, e_0]] = 0, \quad [e_r, [e_r, e_0]] = 0, \quad [e_i, e_0] = 0, \quad i \neq 1, r$$

arise from the requirement that $\hat{\mathfrak{g}}_1$ be an irreducible $\hat{\mathfrak{g}}_0$ -module. In $[\hat{\mathfrak{g}}_1, \hat{\mathfrak{g}}_1]$, there are $\hat{\mathfrak{g}}_0$ lowest weight vectors $[[e_1, e_0], e_0]$ and $[[e_r, e_0], e_0]$, which have weights different from any roots of $\mathfrak{g} = \mathfrak{sl}_{r+1}$. Thus the condition that $\hat{\mathfrak{g}}_2$ is isomorphic to \mathfrak{g} as \mathfrak{g}_0 -module requires

$$[[e_1, e_0], e_0] = 0, \quad [[e_r, e_0], e_0] = 0.$$

Now we have derived at all the Serre relations needed for e_0 , and those for f_0 can be similarly obtained. Together with relations defining \mathfrak{g} , these relations define $\hat{\mathfrak{g}}$.

We hope to treat the affine superalgebras on another occasion.

APPENDIX A. DYNKIN DIAGRAMS

We describe the Dynkin diagrams for both the distinguished and non-distinguished root systems in this Appendix. The roots of all the simple contragredient Lie superalgebras will also be listed [13, 14].

A.1. Roots. Let ε_i ($i = 1, 2, \dots, k$) and δ_j ($j = 1, 2, \dots, l$) be a basis of a real vector space $E(k, l)$ equipped with a non-degenerate symmetric bilinear form. Then for each simple contragredient Lie superalgebra \mathfrak{g} , the dual space \mathfrak{h}^* of the cartan subalgebra is either $\mathbb{C} \otimes_{\mathbb{R}} E(k, l)$ for appropriate k, l or a subspace thereof, which inherits a non-degenerate bilinear form that is Weyl group invariant.

For the series A, B, C or D , the bilinear form is defined by

$$(\varepsilon_i, \varepsilon_{i'}) = \delta_{ii'}, \quad (\delta_j, \delta_{j'}) = -\delta_{jj'}, \quad (\varepsilon_i, \delta_j) = 0, \quad \forall i, i', j, j'.$$

The roots of the simple contragredient Lie superalgebras can be described as follows.

$A(m|n)$:

$$\Delta_0 = \{\varepsilon_i - \varepsilon_{i'} \mid i, i' \in [1, m+1], i \neq i'\} \cup \{\delta_j - \delta_{j'} \mid j, j' \in [1, n+1], j \neq j'\},$$

$$\Delta_1 = \{\pm(\varepsilon_i - \delta_j) \mid i \in [1, m+1], j \in [1, n+1]\},$$

where $[1, N]$ denotes $\{1, \dots, N\}$ for any positive integer N .

$B(0, n)$:

$$\Delta_0 = \{\pm\delta_j \pm \delta_{j'}, \pm 2\delta_j \mid j, j' \in [1, n], j \neq j'\},$$

$$\Delta_1 = \{\pm\delta_j \mid j \in [1, n]\}.$$

$B(m, n), m > 1$:

$$\begin{aligned}\Delta_0 &= \{\pm\varepsilon_i \pm \varepsilon_{i'}, \pm\varepsilon_i \mid i, i' \in [1, m], i \neq i'\} \\ &\quad \cup \{\pm\delta_j \pm \delta_{j'}, \pm 2\delta_j \mid j, j' \in [1, n], j \neq j'\}, \\ \Delta_1 &= \{\pm\varepsilon_i \pm \delta_j, \pm\delta_j \mid i \in [1, m], j \in [1, n]\},\end{aligned}$$

$C(n+1)$:

$$\begin{aligned}\Delta_0 &= \{\pm\delta_j \pm \delta_{j'}, \pm 2\delta_j \mid j, j' \in [1, n], j \neq j'\}, \\ \Delta_1 &= \{\pm\varepsilon_1 \pm \delta_j \mid j \in [1, n]\}.\end{aligned}$$

$D(m, n), m > 1$:

$$\begin{aligned}\Delta_0 &= \{\pm\varepsilon_i \pm \varepsilon_{i'} \mid i, i' \in [1, m], i \neq i'\} \\ &\quad \cup \{\pm\delta_j \pm \delta_{j'}, \pm 2\delta_j \mid j, j' \in [1, n], j \neq j'\}, \\ \Delta_1 &= \{\pm\varepsilon_i \pm \delta_j \mid i \in [1, m], j \in [1, n]\}.\end{aligned}$$

$F(4)$:

$$\begin{aligned}\Delta_0 &= \{\pm\varepsilon_i \pm \varepsilon_j, \pm\varepsilon_i \mid i, j = 1, 2, 3, i \neq j\} \cup \{\pm\delta\}, \\ \Delta_1 &= \left\{ \frac{1}{2}(\pm\varepsilon_1 \pm \varepsilon_2 \pm \varepsilon_3 \pm \delta) \right\}, \\ (\delta, \delta) &= -6, \quad (\varepsilon_i, \varepsilon_j) = 2\delta_{ij}, \quad (\varepsilon_i, \delta) = 0, \quad \forall i, j = 1, 2, 3.\end{aligned}$$

$G(3)$:

$$\begin{aligned}\Delta_0 &= \{\varepsilon_i - \varepsilon_j, \pm(2\varepsilon_k - \varepsilon_i - \varepsilon_j) \mid 1 \leq i, j, k \leq 3, \text{pairwise distinct}\} \\ &\quad \cup \{\pm 2\delta\}, \\ \Delta_1 &= \{\pm\delta + (\varepsilon_i - \varepsilon_j), \pm\delta \mid i \neq j\}, \\ (\delta, \delta) &= -2, \quad (\varepsilon_i, \varepsilon_j) = \delta_{ij}, \quad (\varepsilon_i, \delta) = 0, \quad \forall i, j = 1, 2, 3.\end{aligned}$$

$D(2, 1; \alpha), \alpha \in \mathbb{C} \setminus \{0, -1\}$:

$$\begin{aligned}\Delta_0 &= \{\pm 2\varepsilon_i \mid i = 1, 2\} \cup \{\pm 2\delta\}, \\ \Delta_1 &= \{\pm\delta \pm \varepsilon_1 \pm \varepsilon_2\}, \\ (\varepsilon_1, \varepsilon_1) &= 1, \quad (\varepsilon_2, \varepsilon_2) = \alpha, \quad (\delta, \delta) = -(1 + \alpha), \quad (\varepsilon_i, \delta) = 0, \quad \forall i.\end{aligned}$$

Denote by $\Pi = \{\alpha_1, \dots, \alpha_r\}$ the set of simple roots of \mathfrak{g} relative to the distinguished Borel subalgebra. We have

$$A(m|n): \quad \Pi = \{\varepsilon_1 - \varepsilon_2, \dots, \varepsilon_m - \varepsilon_{m+1}, \varepsilon_{m+1} - \delta_1, \delta_1 - \delta_2, \dots, \delta_n - \delta_{n+1}\};$$

$$B(0, n): \quad \Pi = \{\delta_1 - \delta_2, \dots, \delta_{n-1} - \delta_n, \delta_n\};$$

$$B(m, n), m > 1:$$

$$\Pi = \{\delta_1 - \delta_2, \dots, \delta_{n-1} - \delta_n, \delta_n - \varepsilon_1, \varepsilon_1 - \varepsilon_2, \dots, \varepsilon_{m-1} - \varepsilon_m, \varepsilon_m\};$$

$$C(n+1): \quad \Pi = \{\varepsilon_1 - \delta_1, \delta_1 - \delta_2, \dots, \delta_{n-1} - \delta_n, 2\delta_n\};$$

$$D(m, n), m > 1:$$

$$\Pi = \{\delta_1 - \delta_2, \dots, \delta_{n-1} - \delta_n, \delta_n - \varepsilon_1, \varepsilon_1 - \varepsilon_2, \varepsilon_2 - \varepsilon_3, \dots, \varepsilon_{m-1} - \varepsilon_m, \varepsilon_{m-1} + \varepsilon_m\};$$

$$F(4): \quad \Pi = \left\{ \frac{1}{2}(\varepsilon_1 + \varepsilon_2 + \varepsilon_3 + \delta), -\varepsilon_1, \varepsilon_1 - \varepsilon_2, \varepsilon_2 - \varepsilon_3 \right\};$$

$$G(3): \quad \Pi = \{\delta - \varepsilon_1 + \varepsilon_3, \varepsilon_1 - \varepsilon_2, 2\varepsilon_2 - \varepsilon_1 - \varepsilon_3\};$$

$$D(2, 1; \alpha), \alpha \in \mathbb{C} \setminus \{0, -1\}: \quad \Pi = \{\delta - \varepsilon_1 - \varepsilon_2, 2\varepsilon_1, 2\varepsilon_2\}.$$

Note that there is a unique simple root, which we denote by α_s , in each Π . Thus $\Theta = \{s\}$.

The simple roots relative to other Borel subalgebras can be obtained by using odd reflections [25]. Let $\Pi_{\mathfrak{b}} = \{\alpha_1, \dots, \alpha_r\}$ be the set of simple roots relative to a given Borel subalgebra $\mathfrak{b} \subset \mathfrak{g}$. Take any isotropic odd simple root $\alpha_t \in \Pi_{\mathfrak{b}}$, and define the odd reflection s_t by

$$\begin{aligned} s_t(\alpha_t) &= -\alpha_t, \\ s_t(\alpha_i) &= \alpha_i + \alpha_t, & \text{if } i \neq t \text{ and } a_{it} \neq 0, \\ s_t(\alpha_i) &= \alpha_i, & \text{if } i \neq t \text{ and } a_{it} = 0. \end{aligned}$$

Then $s_t(\Pi_{\mathfrak{b}}) = \{s_t(\alpha_1), \dots, s_t(\alpha_r)\}$ is the set of simple roots relative to another Borel subalgebra, which is not Weyl group conjugate to \mathfrak{b} . Further odd reflections can be defined with respect to isotropic roots in $s_t(\Pi_{\mathfrak{b}})$, which turn $s_t(\Pi_{\mathfrak{b}})$ into sets of simple roots relative to other Borel subalgebras. All the distinct sets obtained this way correspond bijectively to the conjugacy classes of Borel subalgebras.

A.2. Dynkin diagrams.

A.2.1. *Dynkin diagrams in distinguished root systems.* The Dynkin diagrams in the distinguished root systems are listed in Table 1 below, where r is the number of nodes and s is the element of Θ . Note that the form of Dynkin diagrams in the distinguished root systems is quite uniform in the literature. Table 1 is essentially the corresponding table in [13] with a slight modification in the Dynkin diagram for $D(2, 1; \alpha)$.

Table 1. Dynkin diagrams in distinguished root systems

Lie superalgebra	Dynkin Diagram	r	s
$A(m, n)$		$m+n+1$	$m+1$
$B(m, n), m>0$		$m+n$	n
$B(0, n)$		n	n
$C(n), n>2$		n	1
$D(m, n), m>1$		$m+n$	n
$F(4)$		4	1
$G(3)$		3	1
$D(2, 1; \alpha)$		3	1

A.2.2. *Dynkin diagrams in non-distinguished root systems.* Table 2 gives the Dynkin diagrams of the non-distinguished root systems. A nice graphical explanation can be found in [3, §4] (see also [8]) on how to obtain the Dynkin diagrams in Table 2 by applying odd reflections to those in Table 1.

Table 2. Dynkin diagrams in non-distinguished root systems

Lie superalgebra	Dynkin Diagram
$A(m, n)$	$\times \text{---} \times \text{---} \cdots \text{---} \times \text{---} \times$
$B(m, n), m > 0$	$\times \text{---} \times \text{---} \cdots \text{---} \times \text{---} \times \Rightarrow \circ$ $\times \text{---} \times \text{---} \cdots \text{---} \times \text{---} \times \Rightarrow \bullet$
$C(n)$	$\circ \text{---} \cdots \text{---} \circ \text{---} \bullet \text{---} \bullet \text{---} \cdots \text{---} \circ \text{---} \circ \Leftarrow \circ$

$D(m, n), m > 1$

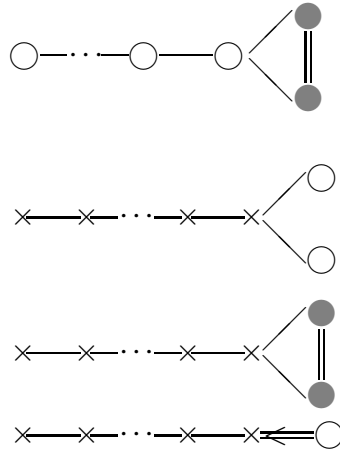

$F(4)$

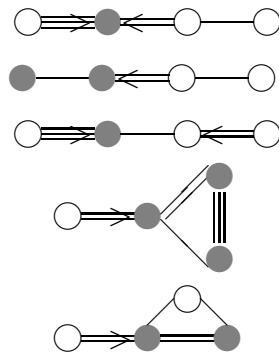

$G(3)$

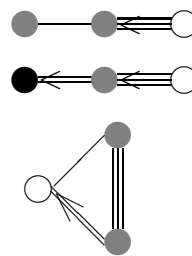

$D(2, 1; \alpha)$

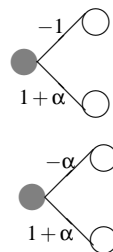

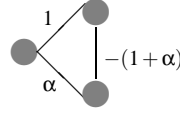

In the diagrams in Table 2, a node marked with \times can be white or grey. However, the precise rule for assigning colours requires the knowledge of the simple roots, which are described below.

$A(m, n)$. An ordering $(\mathcal{E}_1, \mathcal{E}_2, \dots, \mathcal{E}_{m+n+2})$ of ε_i and δ_j is called admissible if ε_i appears before ε_{i+1} for all i and δ_j before δ_{j+1} for all j . Each admissible ordering corresponds to one Weyl group conjugate class of Borel subalgebras, with the associated simple roots given by $\mathcal{E}_a - \mathcal{E}_{a+1}$ ($1 \leq a \leq m+n+1$). In particular, the distinguished Borel corresponds to the admissible ordering such that all the ε_i appear before the δ_j . Let us define $[\mathcal{E}_a]$ ($a = 1, 2, \dots, m+n+2$) by $[\mathcal{E}_a] = 0$ (resp. $[\mathcal{E}_a] = 1$) if \mathcal{E}_a is some ε_i (resp. δ_j). The a -th node from the left in the Dynkin diagram is associated with the simple root $\mathcal{E}_a - \mathcal{E}_{a+1}$, which is white if $[\mathcal{E}_a] = [\mathcal{E}_{a+1}]$ and grey otherwise.

$B(m, n)$, $m > 0$. Let $(\mathcal{E}_1, \mathcal{E}_2, \dots, \mathcal{E}_{m+n})$ be an admissible ordering of ε_i ($i = 1, \dots, m$) and δ_j ($j = 1, \dots, n$). Then the corresponding simple roots are

$$\mathcal{E}_1 - \mathcal{E}_2, \dots, \mathcal{E}_{m+n-1} - \mathcal{E}_{m+n}, \mathcal{E}_{m+n}.$$

The first Dynkin diagram corresponds to the case $\mathcal{E}_{m+n} = \varepsilon_m$. The a -th node ($a < m+n$) from the left is associated with the simple root $\mathcal{E}_a - \mathcal{E}_{a+1}$, which is white if $[\mathcal{E}_a] = [\mathcal{E}_{a+1}]$ and grey otherwise. The second Dynkin diagram corresponds to the case $\mathcal{E}_{m+n} = \delta_n$. The colours of the nodes marked \times are assigned in the same way as in type A.

$C(n)$. We have already specified the colours of the nodes in the Dynkin diagrams, but it is still useful to have an explicit description of the simple roots. Let $(\mathcal{E}_1, \mathcal{E}_2, \dots, \mathcal{E}_n)$ be an admissible ordering of δ_j ($j = 1, \dots, n-1$) and ε_1 . The first Dynkin diagram corresponds to the case with $\mathcal{E}_n = \delta_{n-1}$, where simple roots are given by

$$\mathcal{E}_1 - \mathcal{E}_2, \dots, \mathcal{E}_{n-1} - \mathcal{E}_n, 2\mathcal{E}_n.$$

The second Dynkin diagram corresponds to the case with $\mathcal{E}_n = \varepsilon_1$, where the simple roots are given by

$$\mathcal{E}_1 - \mathcal{E}_2, \dots, \mathcal{E}_{n-1} - \mathcal{E}_n, \mathcal{E}_{n-1} + \mathcal{E}_n.$$

The colours of the nodes marked with \times 's are assigned in the same way as in type A and type B.

$D(m, n)$. Let $(\mathcal{E}_1, \mathcal{E}_2, \dots, \mathcal{E}_{m+n})$ be an admissible ordering of ε_i ($i = 1, \dots, m$) and δ_j ($j = 1, \dots, n$). If $\mathcal{E}_{m+n-1} = \varepsilon_{m-1}$ and $\mathcal{E}_{m+n} = \varepsilon_m$, or $\mathcal{E}_{m+n-1} = \delta_n$ and $\mathcal{E}_{m+n} = \varepsilon_m$, the simple roots are given by

$$\mathcal{E}_1 - \mathcal{E}_2, \dots, \mathcal{E}_{m+n-1} - \mathcal{E}_{m+n}, \mathcal{E}_{m+n-1} + \mathcal{E}_{m+n}.$$

The first Dynkin diagram corresponds to the former case, while the second Dynkin diagram corresponds to the latter. If $\mathcal{E}_{m+n-1} = \delta_{n-1}$ and $\mathcal{E}_{m+n} = \delta_n$, the simple roots are given by

$$\mathcal{E}_1 - \mathcal{E}_2, \dots, \mathcal{E}_{m+n-1} - \mathcal{E}_{m+n}, 2\mathcal{E}_{m+n}.$$

The third Dynkin diagram corresponds to this case.

We assign colours to the nodes marked with \times in the same way as in the other cases.

Remark A.1. There are at least three grey nodes in the Dynkin diagrams of type $D(m, n)$ in Table 2, but in each of the Dynkin diagrams of type $C(n)$, there are only two grey nodes which are always next to each other.

APPENDIX B. PRESENTATIONS OF IRREDUCIBLE MODULES

In general it is hard to give an explicit description of a finite dimensional irreducible module for a Lie superalgebra as the quotient of a (generalised) Verma module in a form similar to [11, Theorem 21.4] in the context of ordinary semi-simple Lie algebras. However, this is possible in some special cases, e.g., the natural module for $\mathfrak{gl}_{m|n}$ in arbitrary root systems as discussed in Section 5.1. Here are two further cases, which are used in the proof of Lemma 3.8.

B.1. An irreducible $\mathfrak{osp}_{2|4}$ -module. Let \mathfrak{g} be the Lie superalgebra $\mathfrak{osp}_{2|4}$ with the choice of Borel subalgebra corresponding to the Dynkin diagram

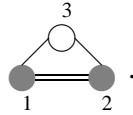

We present \mathfrak{g} in the standard fashion using Chevalley generators e_i, f_i, h_i ($i = 1, 2, 3$) and relations with the higher order Serre relations being those associated with diagram (6) in Theorem 3.11. To be specific, we denote by α_i the simple roots and take

$$(\alpha_1, \alpha_3) = (\alpha_2, \alpha_3) = -1, \quad (\alpha_1, \alpha_2) = 2, \quad (\alpha_3, \alpha_3) = 2.$$

Let $\bar{\mathfrak{p}}$ be the parabolic subalgebra generated by all the generators but e_1 . Then $\bar{\mathfrak{p}} = \mathfrak{l} \oplus \bar{\mathfrak{u}}$ with $\mathfrak{l} = \mathfrak{gl}_{2|1}$ and $\bar{\mathfrak{u}}$ spanned by

$$\begin{aligned} \zeta_1 &:= e_1, & \zeta_2 &:= [e_1, e_3], \\ X_1 &:= [e_1, e_2], & X_2 &:= [[e_1, e_2], e_3], & X_3 &:= [[[e_1, e_2], e_3], e_3]. \end{aligned}$$

Given the irreducible $\bar{\mathfrak{p}}$ -module $\bar{L}_\lambda^0 = \mathbb{C}v_0$ with lowest weight λ such that

$$(\lambda, \alpha_2) = 0, \quad (\lambda, \alpha_3) = 0, \quad (\lambda, \alpha_1) = -2,$$

we construct the generalised Verma module $\bar{V}_\lambda = U(\mathfrak{g}) \otimes_{U(\bar{\mathfrak{p}})} \bar{L}_\lambda^0$. Then the maximal submodule M_λ of \bar{V}_λ is given by

$$(B.1) \quad M_\lambda = U(\mathfrak{g})\zeta_1 X_1 v_0.$$

The irreducible quotient $\bar{L}_\lambda = \bar{V}_\lambda/M_\lambda$ is 10-dimensional with a basis

$$\begin{array}{ccccc} v_0, & X_1 v_0, & X_2 v_0, & X_3 v_0, & X_1 X_3 v_0, \\ \zeta_1 v_0, & \zeta_1 X_2 v_0, & \zeta_1 X_3 v_0, & \zeta_1 X_1 X_3 v_0, & \zeta_1 \zeta_2 v_0. \end{array}$$

B.2. Graded symmetric tensor for $\mathfrak{gl}_{m|n}$. Let $\mathfrak{g} = \mathfrak{gl}_{m|n}$ and set $r = m + n - 1$. Choose an arbitrary homogeneous basis for the natural module $\mathbb{C}^{m|n}$ with the last element being odd. We regard \mathfrak{g} as consisting of matrices relative to this basis. Take the subalgebra consisting of the upper triangular matrices as the Borel subalgebra, which corresponds to an admissible ordering $(\mathcal{E}_1, \mathcal{E}_2, \dots, \mathcal{E}_{m+n})$ of ε_i ($1 \leq i \leq m$) and δ_j ($1 \leq j \leq n$) with $\mathcal{E}_{m+n} = \delta_n$. See Appendix A.2 for more details.

Let \mathfrak{l} , \mathfrak{u} and $\bar{\mathfrak{u}}$ be subalgebras respectively spanned by matrix units $e_{r+1, r+1}$ and e_{ij} with $1 \leq i, j \leq r$, by $e_{i, r+1}$ with $1 \leq i \leq r$, and by $e_{r+1, i}$ with $1 \leq i \leq r$. Set $\bar{\mathfrak{p}} = \mathfrak{l} \oplus \bar{\mathfrak{u}}$, which is a parabolic subalgebra, and $\mathfrak{g} = \bar{\mathfrak{p}} \oplus \mathfrak{u}$.

For $\lambda = 2\delta_n$, we consider the generalised Verma module $\bar{V}_\lambda := U(\mathfrak{g}) \otimes_{U(\bar{\mathfrak{p}})} \mathbb{C}_\lambda$ of lowest weight type, where \mathbb{C}_λ denotes the irreducible $\bar{\mathfrak{p}}$ -module with lowest weight λ . Let v_0 denote a generator of \mathbb{C}_λ , then

$$(B.2) \quad \begin{array}{l} f_r v_0 = 0, \\ e_i v_0 = 0, \quad f_i v_0 = 0, \quad 1 \leq i \leq r-1, \\ e_{jj} v_0 = 2\delta_{j, r+1} v_0, \quad 1 \leq j \leq r+1, \end{array}$$

where $e_i = e_{i, i+1}$ and $f_i = e_{i+1, i}$.

Now $\bar{V}_\lambda \cong U(\mathfrak{u}) \otimes \mathbb{C}_\lambda$ as \mathfrak{l} -module, where $U(\mathfrak{u}) = S_s(\mathfrak{u})$, the \mathbb{Z}_2 -graded symmetric algebra of \mathfrak{u} . This superalgebra has a \mathbb{Z} -grading with \mathfrak{u} having degree 1. It induces a natural \mathbb{Z} -grading on \bar{V}_λ . The unique maximal submodule M_λ of \bar{V}_λ is the direct sum of the homogeneous subspaces of degrees greater than or equal to 3, which is generated by $U(\mathfrak{u})_3 \otimes \mathbb{C}_\lambda$, the homogeneous subspace of degree 3. The irreducible quotient \bar{L}_λ of \bar{V}_λ is isomorphic to the \mathbb{Z}_2 -graded symmetric tensor of the natural \mathfrak{g} -module at rank 2.

The natural \mathfrak{l} action on $U(\mathfrak{u})$ (obtained by generalising the adjoint action) respects the \mathbb{Z} -grading. In the present case, each homogeneous component is in fact an irreducible submodule. We are interested in $U(\mathfrak{u})_3$. If u_3 is a nonzero lowest weight vector of $U(\mathfrak{u})_3$, then M_λ is generated over \mathfrak{g} by $u_3 \otimes \mathbb{C}_\lambda$. The form of u_3 depends on the ordering of the basis for $\mathbb{C}^{m|n}$. Denote by $E_{ij} \in U(\mathfrak{g})$ the image of $e_{ij} \in \mathfrak{g}$ under the natural embedding. The u_3 can be expressed as follows:

$$(B.3) \quad \begin{array}{ll} u_3 = E_{r, r+1}^3, & \text{if } E_{r, r+1} \text{ is even;} \\ u_3 = E_{r-1, r+1}^2 E_{r, r+1}, & \text{if both } E_{r, r+1} \text{ and } E_{r-1, r} \text{ are odd;} \\ u_3 = E_{r-2, r+1} E_{r-1, r+1} E_{r, r+1}, & \text{if } E_{r, r+1} \text{ is odd but } E_{r-1, r} \text{ is even.} \end{array}$$

Remark B.1. The third case becomes vacuous if $r = 2$; and both the second and third cases are vacuous if $r = 1$.

The irreducible quotient $\bar{L}_\lambda = \bar{V}_\lambda/M_\lambda$ is isomorphic to the graded skew symmetric rank two tensor $\wedge_s^2(\mathbb{C}^{m|n})$ of the natural \mathfrak{g} -module.

REFERENCES

- [1] S. Bouarroudj, P. Grozman, A. Lebedev, D. Leites, Divided power (co)homology. Presentations of simple finite dimensional modular Lie superalgebras with Cartan matrix. *Homology, Homotopy Appl.* **12** (2010), no. 1, 237 – 278.
- [2] Bracken, A. J.; Gould, M. D.; Zhang, R. B. Quantum supergroups and solutions of the Yang-Baxter equation. *Modern Phys. Lett. A* **5** (1990), no. 11, 831–840.
- [3] D. Chapovalov, M. Chapovalov, A. Lebedev, D. Leites, The classification of almost affine (hyperbolic) Lie superalgebras. *Journal of Nonlinear Mathematical Physics*, **1**, No. 1 (2009) 1 – 55.
- [4] Drinfeld, V. G. Quantum groups. Proceedings of the International Congress of Mathematicians, Vol. 1, 2 (Berkeley, Calif., 1986), 798–820, Amer. Math. Soc., Providence, RI, 1987.
- [5] R. Floreanini, D. A. Leites, L. Vinet, On the defining relations of quantum superalgebras. *Lett. Math. Phys.* **23** (1991), no. 2, 127 – 131.
- [6] P. Grozman, D. Leites, Defining relations for Lie superalgebras with Cartan matrix. *Czechoslovak J. Phys.* **51** (2001), no. 1, 1 – 21.
- [7] Grozman, P.; Leites, D.; Poletaeva, E. Defining relations for classical Lie superalgebras without Cartan matrices. The Roos Festschrift volume, 2. *Homology Homotopy Appl.* **4** (2002), no. 2, part 2, 259 – 275.
- [8] L. Frappat, A. Sciarrino, P. Sorba, Structure of basic Lie superalgebras and of their affine extensions. *Comm. Math. Phys.* **121** (1989), no. 3, 457 – 500.
- [9] O. Gabber and V. G. Kac, On defining relations of certain infinite-dimensional Lie algebras. *Bull. Amer. Math. Soc. (N.S.)* **5** (1981), no. 2, 185 – 189.
- [10] N. Geer, Etingof-Kazhdan quantization of Lie superbialgebras. *Adv. Math.* **207** (2006), no. 1, 1 – 38.
- [11] J. E. Humphreys, Introduction to Lie algebras and representation theory. Graduate Texts in Mathematics, **9**. Springer-Verlag, New York-Berlin, 1972.
- [12] M. Jimbo, A q -difference analogue of $U_q(\mathfrak{g})$ and the Yang-Baxter equation. *Lett. Math. Phys.* **10** (1985), no. 1, 63 – 69.
- [13] V. G. Kac, Lie superalgebra. *Advances in Math.* **26** (1977), no. 1, 8 – 96.
- [14] V. G. Kac, Representations of classical Lie superalgebras. Differential geometrical methods in mathematical physics, II (Proc. Conf., Univ. Bonn, Bonn, 1977), pp. 597 – 626, *Lecture Notes in Math.*, **676**, Springer, Berlin, 1978.
- [15] V. G. Kac, Infinite-dimensional Lie algebras. Third edition. Cambridge University Press, Cambridge, 1990.
- [16] I. Kaplansky, Superalgebras. *Pacific J. Math.* **86** (1980), no. 1, 93 – 98.
- [17] I. Kaplansky, Afterthought: superalgebras, in Selected papers and other writings. With an introduction by Hyman Bass. Springer-Verlag, New York, 1995. p225.
- [18] E. Lanzmann, The Zhang transformation and $U_q(\mathfrak{osp}(1,2|1))$ -Verma modules annihilators. *Algebr. Represent. Theory* **5** (2002), no. 3, 235 – 258.

- [19] D. Leites and V. Serganova, Defining relations for classical Lie superalgebras. I. Superalgebras with Cartan matrix or Dynkin-type diagram. *Topological and geometrical methods in field theory (Turku, 1991)*, 194 - 201, World Sci. Publ., River Edge, NJ, 1992.
- [20] Links, J. R.; Gould, M. D.; Zhang, R. B. Quantum supergroups, link polynomials and representation of the braid generator. *Rev. Math. Phys.* **5** (1993), no. 2, 345 – 361.
- [21] G. Lusztig, Introduction to quantum groups. *Progress in Mathematics*, **110**. Birkhuser Boston, Inc., Boston, MA, 1993.
- [22] Manin, Yu. I. Quantum groups and noncommutative geometry. Universit de Montral, Centre de Recherches Mathematiques, Montreal, QC, 1988.
- [23] M. Scheunert, The theory of Lie superalgebras. An introduction. *Lecture Notes in Mathematics*, **716**. Springer, Berlin, 1979.
- [24] Scheunert, M. The presentation and q deformation of special linear Lie superalgebras. *J. Math. Phys.* **34** (1993), no. 8, 3780 – 3808.
- [25] Serganova V., Automorphisms of simple Lie superalgebras. *Izv. Akad. Nauk SSSR Ser. Mat.* **48** (1984), no. 3, 585598; (Russian) English translation: *Math. USSR-Izv.* **24** (1985), no. 3, 539 – 551
- [26] H. Yamane, Quantized enveloping algebras associated with simple Lie superalgebras and their universal R -matrices. *Publ. Res. Inst. Math. Sci.* **30**(1994), no. 1, 15 – 87.
- [27] H. Yamane, On defining relations of affine Lie superalgebras and affine quantized universal enveloping superalgebras. *Publ. Res. Inst. Math. Sci.* **35** (1999), no. 3, 321 – 390.
- [28] Zhang, R. B. Finite-dimensional representations of $U_q(\mathfrak{osp}(1/2n))$ and its connection with quantum $\mathfrak{so}(2n+1)$. *Lett. Math. Phys.* **25** (1992), no. 4, 317 – 325.
- [29] Zhang, R. B. Quantum supergroups and topological invariants of three-manifolds. *Rev. Math. Phys.* **7** (1995), no. 5, 809 – 831.
- [30] Zhang, R. B. Structure and representations of the quantum general linear supergroup. *Comm. Math. Phys.* **195** (1998), no. 3, 525 – 547.
- [31] Zhang, R. B. Quantum superalgebra representations on cohomology groups of non-commutative bundles. *J. Pure Appl. Algebra* **191** (2004), no. 3, 285 – 314.

SCHOOL OF MATHEMATICS AND STATISTICS, UNIVERSITY OF SYDNEY, SYDNEY, AUSTRALIA
E-mail address: ruibin.zhang@sydney.edu.au