

Conformal loop ensembles: The Markovian characterization

SCOTT SHEFFIELD* and WENDELIN WERNER†

Abstract

For random collections of self-avoiding loops in two-dimensional domains, we define a simple and natural property that is conjecturally satisfied by the scaling limits of interfaces in models from statistical physics. This property is basically the combination of conformal invariance and the locality of the interaction in the model. Unlike the Markov property that Schramm used to characterize SLE curves (which involves conditioning on partially generated interfaces up to arbitrary stopping times), this property only involves conditioning on entire loops and thus appears at first glance to be weaker. Our main result is that there exists at most a one-dimensional family of random loop collections with this property—one for each $\kappa \in (8/3, 4]$ —and that the loops are necessarily forms of SLE_κ . In a second paper, we will show (using loop-soups) that these random loop collections actually exist for all $\kappa \in (8/3, 4]$.

arXiv:1006.2374v1 [math.PR] 11 Jun 2010

*Massachusetts Institute of Technology. Partially supported by NSF grants DMS 0403182 and DMS 0645585 and OISE 0730136.

†Université Paris-Sud 11 and Ecole Normale Supérieure. Research supported in part by ANR-06-BLAN-00058

Contents

1	Introduction	3
1.1	General introduction	3
1.2	Main statements and outline	5
1.3	Further background	7
2	The CLE property	8
2.1	Definitions	8
2.2	Simple properties of CLEs	10
3	Explorations	11
3.1	Exploring CLEs – heuristics	11
3.2	Discovering the loops that intersect a given set	13
3.3	Discovering random configurations along some given line	16
4	The one-point pinned loop measure	19
4.1	The pinned loop surrounding the origin in \mathbb{U}	19
4.2	The infinite measure on pinned loops in \mathbb{H}	21
4.3	Discrete radial/chordal explorations, heuristics, background	24
4.4	A priori estimates for the pinned measure	26
5	The two-point pinned probability measure	29
5.1	Restriction property of the pinned measure	29
5.2	Chordal explorations	32
5.3	Definition of the two-point pinned measure	34
5.4	Independence-property of two-point pinned loops	37
6	Pinned loops and SLE excursions	40
6.1	Two-point pinned measure and SLE paths	40
6.2	Pinned measure and SLE excursion measure	45
7	Reconstructing a CLE from the pinned measure	47
7.1	The law of $\gamma(i)$	47
7.2	Several points	50
7.3	Background about SLE $(\kappa, \kappa - 6)$	53
7.4	SLE $(\kappa, \kappa - 6)$ and Poisson point process of pinned loops	55
7.5	CLE and the SLE $(\kappa, \kappa - 6)$ exploration tree	56
8	An open problem	57

1 Introduction

1.1 General introduction

SLE and its conformal Markov property. Oded Schramm’s SLE processes introduced in [24] have deeply changed the way mathematicians and physicists understand critical phenomena in two dimensions. Recall that a chordal SLE is a random non-self-traversing curve in a simply connected domain, joining two prescribed boundary points of the domain. Modulo conformal invariance hypotheses that have been proved to hold in several cases, the scaling limit of an interface that appears in various two-dimensional models from statistical physics, when boundary conditions are chosen in a particular way, is one of these SLE curves. For instance, in the Ising model on a triangular lattice, if one connected arc d_+ of the boundary of a simply connected region D is forced to contain only $+$ spins whereas the complementary arc d_- contains only $-$ spins, then there is a random interface that separates the cluster of $+$ spins attached to d_+ from the cluster of $-$ spins attached to d_- ; this random curve has recently been proved by Chelkak and Smirnov to converge in distribution to an SLE curve (the SLE_3) when one lets the mesh of the lattice go to zero (and chooses the critical temperature of the Ising model) [35, 4].

Note that SLE describes the law of one particular interface, not the joint law of all interfaces (we will come back to this issue later). On the other hand, for a given model, one expects all macroscopic interfaces to have similar geometric properties, i.e., to locally look like an SLE.

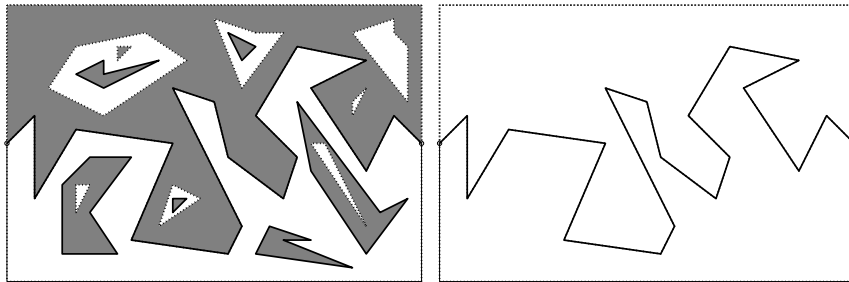

Figure 1: A coloring with good boundary conditions (black on one boundary arc, white on the complementary boundary arc) and the chordal interface (sketch)

The construction of SLE curves can be summarized as follows: The first observation, contained in Schramm’s original paper [24], is the “analysis” of the problem: Assuming that the two-dimensional models of statistical physics have a conformally invariant scaling limit, what can be said about the scaling limit of the interfaces? If one chooses the boundary conditions in a suitable way, one can identify a special interface that joins two boundary points (as in the Ising model mentioned above). Schramm argues that if this curve has a scaling limit, and if its law is conformally invariant, then it should satisfy an “exploration” property in the scaling limit. This property, combined with conformal invariance, implies that it can be defined via iterations of independent random conformal maps. With the help of Loewner’s theory for slit mappings, this leads naturally to the definition of the (one

parameter) family of SLE processes, which are random increasing families of compact sets (called Loewner chains), see [24] for more details. Recall that Loewner chains are constructed via continuous iterations of infinitesimal conformal perturbations of the identity, and they do not a priori necessarily correspond to actual planar curves.

A second step, essentially completed in [23], is to start from the definition of these SLE processes as random Loewner chains, and to prove that they indeed correspond to random two-dimensional curves. This constructs a one-parameter family of SLE random curves joining two boundary points of a domain, and the previous steps shows that if a random curve is conformally invariant (in distribution) and satisfies the exploration property and, then it is necessarily one of these SLE curves.

One can study various properties of these random Loewner chains. For instance, one can compute critical exponents such as in [13, 14], determine their fractal dimension as in [23, 1], derive special properties of certain SLE's – locality, restriction – as in [13, 16], relate them to discrete lattice models such as uniform spanning trees, percolation, the discrete Gaussian Free Field or the Ising model as in [15, 34, 35, 3, 27], or to the Gaussian Free Field and its variants as in [27, 7, 19, 20] etc. Indeed, at this point the literature is far too large for us to properly survey here. For conditions that ensure that discrete interfaces converge to SLE paths, see the recent contributions [9, 31].

Conformal Markov property for collections of loops. A natural question is how to describe the “entire” scaling limit of the lattice-based model, and not only that of one particular interface. In the present paper, we will answer the following question: Supposing that a discrete random system gives rise in its scaling limit to a conformally invariant collection of loops (i.e., interfaces) that remain disjoint (note that this is not always the case; we will comment on this later), what can these random conformally invariant collections of loops be?

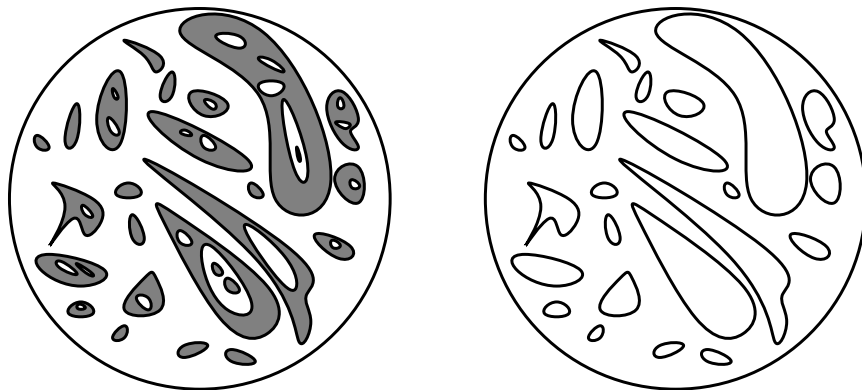

Figure 2: A coloring and the corresponding outermost loops (sketch)

More precisely, we will define and study random collections of loops that combine conformal invariance and a natural restriction property (motivated by the fact that the discrete analog of this property trivially holds for the discrete models we have in mind). We call such collections of loops Conformal Loop Ensembles (CLE). The two main results of the present paper can be described as follows:

- For each CLE, there exists a value $\kappa \in (8/3, 4]$ such that with probability one, all loops of the CLE are SLE_κ -type loops.
- Conversely, for each $\kappa \in (8/3, 4]$, there exists at most one CLE with SLE_κ type loops.

These results will be complemented by our subsequent paper [33], where we will prove that for each $\kappa \in (8/3, 4]$, the CLE corresponding to parameter κ indeed exists. Hence, the family of possible CLEs is one-dimensional, parametrized by the same κ as the family of SLEs.

1.2 Main statements and outline

Let us now describe in more detail the results of the present paper. We are going to study random families $\Gamma = (\gamma_j, j \in J)$ of non-nested simple disjoint loops in simply connected domains. For each simply connected D , we let P_D denote the law of this loop-ensemble in D . We say that this family is **conformally invariant** if for any two simply connected domains D and D' (that are not equal to the entire plane) and conformal transformation $\psi : D \rightarrow D'$, the image of P_D under ψ is $P_{D'}$.

We also make the following “local finiteness” assumption: if D is equal to the unit disc \mathbb{U} , then for any $\varepsilon > 0$, there are $P_{\mathbb{U}}$ almost surely only finitely many loops of radius larger than ε in Γ .

Consider two simply connected domains $D_1 \subset D_2$, and sample a family $(\gamma_j, j \in J)$ according to the law P_{D_2} in the larger domain D_2 . Then, we can subdivide the family $\Gamma = (\gamma_j, j \in J)$ into two parts: Those that do not stay in D_1 , and those that stay in D_1 (we call the latter $(\gamma_j, j \in J_1)$). Let us now define D_1^* to be the random set obtained when removing from the set D_1 all the loops of Γ that do not fully stay in D_1 , together with their interiors. We say that the family P_D **satisfies restriction** if, for any such D_1 and D_2 , the conditional law of $(\gamma_j, j \in J_1)$ given D_1^* is $P_{D_1^*}$ (or more precisely, it is the product of P_D for each connected component D of D_1^*): When a family is conformally invariant and satisfies restriction, we say that it is a Conformal Loop Ensemble (CLE). The goal of the paper is to characterize all possible CLEs.

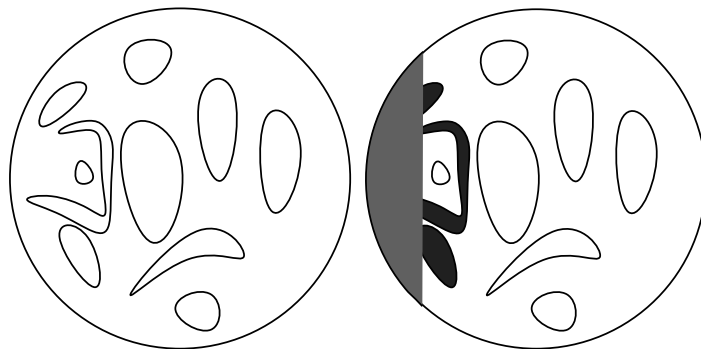

Figure 3: Restriction property (sketch): given the set of loops intersecting $D_2 \setminus D_1$ (the grey wedge on the left of the right figure) the conditional law of the remaining loops is an independent CLE in each component of the (interior of the) complement of this set.

By conformal invariance, it is sufficient to describe P_D for one given simply connected domain. Let us for instance consider D to be the upper half-plane \mathbb{H} . A first step in our analysis will be to prove that for all $z \in \mathbb{H}$, if Γ is a CLE, then the conditional law of the unique loop $\gamma(z) \in \Gamma$ that surrounds z , conditionally on the fact that $\gamma(z)$ intersects the ε -neighborhood of the origin, converges as $\varepsilon \rightarrow 0$ to a probability measure P^z on “pinned loops”, i.e., loops in \mathbb{H} that touch the real line only at the origin. We will derive various properties of P^z , which will eventually enable us to relate it to SLE. One simple way to describe this relation is as follows:

Theorem 1.1. *If Γ is a CLE, then the measure P^z exists for all $z \in \mathbb{H}$, and it is equal to the limit when $\varepsilon \rightarrow 0$ of the law of an SLE_κ from ε to 0 in \mathbb{H} conditioned to disconnect z from infinity in \mathbb{H} , for some $\kappa \in (8/3, 4]$ (we call this limit the SLE_κ bubble measure).*

This shows that all the loops of a CLE are indeed in some sense “ SLE_κ loops” for some κ . In fact, the way in which P^z will be described (and this theorem will actually be proved) can be understood as follows (this will be the content of Proposition 4.1) in the case where $z = i$: Consider A the lowest point on $[0, i] \cap \gamma(i)$, and H the unbounded connected component of the domain obtained by removing from $\mathbb{H} \setminus [0, A]$ all the loops of the CLE that intersect $[0, A]$. Consider the conformal map Φ from H onto \mathbb{H} with $\Phi(i) = i$ and $\Phi(A) = 0$. Then, the law of $\Phi(\gamma(i))$ is exactly P^i .

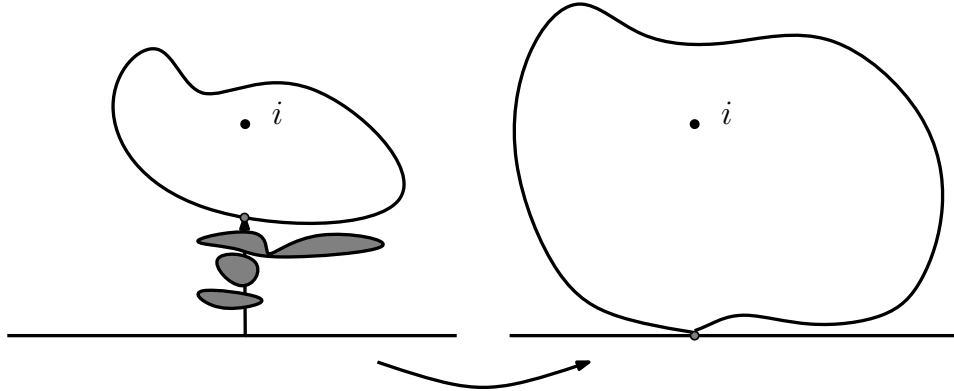

Figure 4: Description of P^i (sketch).

Theorem 1.1 raises the question of whether two different CLE distributions can correspond to the same measure P^z . We will prove that it is not possible, i.e., we will describe a way to reconstruct the law of the CLE out of the knowledge of P^z only, using a construction based on a Poisson point process of pinned loops:

Theorem 1.2. *For each $\kappa \in (8/3, 4]$, there exists at most one CLE such that P^z is the SLE_κ bubble measure.*

In a way, this reconstruction procedure can be interpreted as an “excursion theory” for CLEs. It will be very closely related to the decomposition of a Bessel process via its Poisson point process of excursions. In fact, this will enable us to relate our CLEs to the random loop ensembles defined in [31] using branching SLE processes, and that we now briefly describe.

Recall that when $\kappa \leq 4$, SLE_κ is a random simple curve from one marked boundary point a of a simply connected domain D to another boundary point b . If we now compare the law of an SLE from a to b in D with that of an SLE from a to b' in D when $b \neq b'$, then they clearly differ, and it is also immediate to check that the laws of their initial parts (i.e., the laws of the paths up to the first time they exit some fixed small neighborhood of a) are also not identical. We say that SLE_κ is not target-independent. However, a variant of $SLE(\kappa)$ called $SLE(\kappa, \kappa - 6)$ has been shown by Schramm and Wilson [33] (see also [31]) to be target-independent. This makes it possible to couple such processes starting at a and aiming at two different points b and b' in such a way that they coincide until the first disconnection point. This in turn makes it possible to canonically define a conformally invariant “exploration tree” of $SLE(\kappa, \kappa - 6)$ processes rooted at a , and a collection of loops called Conformal Loop Ensembles in [31]. It is conjectured in [31] that this one-parameter collection of loops indeed corresponds to the scaling limit of a wide class of discrete lattice-based models, and that for each κ , the law of the constructed family of loops is independent of the starting point a .

The branching $SLE(\kappa, \kappa - 6)$ procedure works for any $\kappa \in (8/3, 8]$, but the obtained loops are simple and disjoint loops only when $\kappa \leq 4$. In this paper, we use the term CLE to refer to any collection of loops satisfying conformal invariance and restriction, while using the term CLE_κ to refer to the random collections of loops constructed in [31]. We shall prove the following:

Theorem 1.3. *Every CLE is in fact a CLE_κ for some $\kappa \in (8/3, 4]$.*

Let us stress that we have not yet proved that the CLE_κ are themselves CLEs (and this was also not established in [31]) – it is not even clear that the law of CLE_κ is root-independent. In fact, it is not proved here that CLEs exist at all. However, in a subsequent paper [33], we will prove using a completely different construction involving Poissonian families of Brownian loops that for each $\kappa \in (8/3, 4]$ there exists a CLE such that P^z is an SLE_κ bubble measure. Combining this with the results of the present paper will therefore show a one-to-one correspondence between the set of CLEs and the CLE_κ 's for $\kappa \in (8/3, 4]$ (and prove the fact that the law of CLE_κ is root-independent).

1.3 Further background

In order to put our results in perspective, we briefly recall some closely related work on conformally invariant structures.

Other conformally invariant structures giving rise to loops. There exist several natural ways to construct conformally invariant structures in a domain D . We have already mentioned the Brownian loop-soup that will be instrumental in [33] when constructing explicitly CLEs. Another natural conformally invariant structure is the Gaussian Free Field. This is a classical basic object in Field Theory. It has been shown (see [27, 7]) that it is very closely related to SLE processes, and that one can detect all kinds of SLEs within the Gaussian Free Field. In particular, this indicates that CLEs (at least when $\kappa = 4$) can in fact also be defined and found as “geometric” lines in a Gaussian Free Field.

Discrete models. A number of discrete lattice-based models have been conjectured to give rise to conformally invariant structures in the fine-mesh limit. For some of these models,

these structures can be described by random collections of loops. We have already mentioned that Smirnov [34, 35, 36] has proved this conjecture for some important models (percolation, Ising model — see also [15, 26, 27] for some other cases). Those models that will be directly relevant to the present paper (i.e., with disjoint simple loops) include the Ising model and the Gaussian Free Field level lines ([36, 4, 27, 7]). The scaling limits of percolation and of the FK-model related to the Ising model, give rise to interfaces that are not disjoint. These are of course also very interesting objects (see [29, 3, 38] for the description of the percolation scaling limit), but they are not the subject of the present paper. Conjecturally, each of the CLEs that we will be describing corresponds to the scaling limit of one of the so-called $O(N)$ models, see e.g. [21, 10], which are one simple way to define discrete random collections of non-overlapping loops.

In fact, if one starts from a lattice-based model for which one controls the (conformally invariant) scaling limit of an observable (loosely speaking, the scaling limit of the probability of some event), it seems possible (see Smirnov [35]) to use this to actually prove the convergence of the entire discrete “branching” exploration procedure to the corresponding branching $SLE(\kappa, \kappa - 6)$ exploration tree. It is likely that it is not so much harder to derive the “full” scaling limit of all interfaces than to show the convergence of one particular interface to SLE.

Another quite different family of discrete models that is conjecturally directly related to the CLEs that we are studying here, are the “planar maps”, where one chooses at random a planar graph, defined modulo homeomorphisms, and that are conjecturally closely related to the above (for instance via their conjectured relation with the Gaussian Free Field). It is likely that CLEs should be very rather directly related to random planar maps, chosen in a way to contain “large holes”, such as the ones that are studied in [18]. In fact, CLEs, planar maps and the Gaussian Free Field should all be closely related to each other via Liouville quantum gravity, as described in [8].

Conformal Field Theory. Note finally that Conformal Field Theory, as developed in the theoretical physics community since the early eighties [2], is also a setup to describe the scaling limits of all correlation functions of these critical 2D lattice models. This indicates that a description of the entire scaling limit of the lattice models in geometric SLE-type terms could be useful in order to construct such fields. CLE-based constructions of Conformal Field Theoretical objects “in the bulk” can be found in Benjamin Doyon’s papers [5, 6]. It may also be mentioned that aspects of the present paper (infinite measures on “pinned configurations”) can be interpreted naturally in terms of insertions of boundary operators.

2 The CLE property

2.1 Definitions

A **simple loop** in the complex plane will be the image of the unit circle in the plane under a continuous injective map (in other words we will identify two loops if one of them is obtained by a bijective reparametrization of the other one). Note that a simple loop γ separates the plane into two connected components that we call its interior $\text{int}(\gamma)$ (the bounded one) and its exterior (the unbounded one) and that each one of these two sets characterizes the loop.

There are various natural distances and σ -fields that one can use for the space \mathcal{L} of loops. We will use the σ -field Σ generated by all the events of the type $\{O \subset \text{int}(\gamma)\}$ when O spans the set of open sets in the unit plane. Note that this σ -field is also generated by the events of the type $\{x \in \text{int}(\gamma)\}$ where x spans a countable dense subset Q of the plane (recall that we are considering simple loops so that $O \subset \text{int}(\gamma)$ as soon as $O \cap Q \subset \text{int}(\gamma)$).

In the present paper, we will consider (at most countable) collections $\Gamma = (\gamma_j, j \in J)$ of simple loops. One way to properly define such a collection is to identify it with the point-measure

$$\mu_\Gamma = \sum_{j \in J} \delta_{\gamma_j}.$$

Note that this space of collections of loops is naturally equipped with the σ -field generated by the sets $\{\Gamma : \#(\Gamma \cap A) = k\} = \{\Gamma : \mu_\Gamma(A) = k\}$, where $A \in \Sigma$ and $k \geq 0$.

We will say that $(\gamma_j, j \in J)$ is a **simple loop configuration** in the bounded simply connected domain D if the following conditions hold:

- For each $j \in J$, the loop γ_j is a simple loop in D .
- For each $j \neq j' \in J$, the loops γ_j and $\gamma_{j'}$ are disjoint.
- For each $j \neq j' \in J$, γ_j is not in the interior of $\gamma_{j'}$: The loops are not nested.
- For each $\varepsilon > 0$, only finitely many loops γ_j have a diameter greater than ε . We call this the **local finiteness** condition.

All these conditions are clearly measurable with respect to the σ -field discussed above.

We are going to study random simple loop configurations with some special properties. More precisely, we will say that the random simple loop configuration $\Gamma = (\gamma_j, j \in J)$ in the unit disc \mathbb{U} is a **Conformal Loop Ensemble** (CLE) if it satisfies the following properties:

- Non-triviality: The probability that $J \neq \emptyset$ is positive.
- Conformal invariance: The law of Γ is invariant under any conformal transformation from \mathbb{U} onto itself. This invariance makes it in fact possible to define the law of the loop-ensemble Γ_D in any simply connected domain $D \neq \mathbb{C}$ as the law of the image of Γ under any given conformal map Φ from \mathbb{U} onto D (this is because the law of this image does not depend on the actual choice of Φ). We can also define the law of a loop-ensemble in any open domain $D \neq \mathbb{C}$ that is the union of disjoint open simply connected sets by taking independent loop-ensembles in each of the connected components of D . We call this law P_D .
- Restriction: To state this important property, we need to introduce some notation. Suppose that U is a simply connected subset of the unit disc. Define

$$I = I(\Gamma, U) = \{j \in J : \gamma_j \not\subset U\}$$

and $J^* = J^*(\Gamma, U) = J \setminus I = \{j \in J : \gamma_j \subset U\}$. Define the (random) set

$$U^* = U^*(U, \Gamma) = U \setminus \bigcup_{j \in I} \overline{\text{int}(\gamma_j)}.$$

This set U^* is a (not necessarily simply connected) open subset of \mathbb{U} (because of the local finiteness condition). The restriction property is that (for all U), the conditional law of $(\gamma_j, j \in J^*)$ given U^* (or alternatively given the family $(\gamma_j, j \in I)$) is P_{U^*} .

This definition is motivated by the fact that for many discrete loop-models that are conjectured to be conformally invariant in the scaling limit, the discrete analog of this restriction property holds. Examples include the $O(N)$ models (and in particular the critical Ising model on the triangular grid). The goal of the paper is to classify all possible CLEs, and therefore the possible conformally invariant scaling limits of such loop-models.

The non-nesting property can seem surprising since the discrete models allow nested loops. The CLE in fact describes (when the domain D is fixed) the conjectural scaling limit of the law of the “outermost loops” (those that are not surrounded by any other one). In the discrete models, one can discover them “from the outside” in such a way that the conditional law of the remaining loops given the outermost loops is just made of independent copies of the model in the interior of each of the discovered loops. Hence, the conjectural scaling limit of the full family of loops is obtained by iteratively defining CLEs inside each loop.

At first sight, the restriction property does not look that restrictive. In particular, as it involves only interaction between entire loops, it may seem weaker than the conformal exploration property of SLE (or of branching SLE($\kappa, \kappa - 6$)), that describes the way in which the path is progressively constructed. However (and this is the content of Theorems 1.1 and 1.2), the family of such CLEs is one-dimensional too, parameterized by $\kappa \in (8/3, 4]$.

2.2 Simple properties of CLEs

We now list some simple consequences of the CLE definition. Suppose that $\Gamma = (\gamma_j, j \in J)$ is a CLE in \mathbb{U} .

1. Then, for any given $z \in \mathbb{U}$, there almost surely exists a loop γ_j in Γ such that $z \in \text{int}(\gamma_j)$. Here is a short proof of this fact: Define $u = u(z)$ to be the probability that z is in the interior of some loop in Γ . By Moebius invariance, this quantity u does not depend on z . Furthermore, since $P(J \neq \emptyset) > 0$, it follows that $u > 0$ (otherwise the expected area of the union of all interiors of loops would be zero). Hence, there exists $r \in (0, 1)$ such that with a positive probability p , the origin is in the interior of some loop in Γ that intersects the slit $[r, 1]$ (we call A this event). We now define $U = \mathbb{U} \setminus [r, 1]$ and apply the restriction property. If A holds, then the origin is in the interior of some loop of Γ . If A does not hold, then the origin is in one of the connected components of \tilde{U} and the conditional probability that it is surrounded by a loop in this domain is therefore still u . Hence, $u = p + (1 - p)u$ so that $u = 1$.
2. The previous observation implies immediately that J is almost surely infinite. Indeed, almost surely, all the points $1 - 1/n, n \geq 1$ are surrounded by a loop, and any given loop can only surround finitely many of these points (because it is at positive distance from $\partial\mathbb{U}$).
3. Let $M(\theta)$ denote the set of configurations $\Gamma = (\gamma_j, j \in J)$ such that for all $j \in J$, the radius $[0, e^{i\theta}]$ is never locally “touched without crossing” by γ_j (in other words, θ is a

local extremum of none of the $\arg(\gamma_j)$'s). Then, for each given θ , Γ is almost surely in $M(\theta)$. Indeed, the argument of a given loop that does not pass through the origin can anyway at most have countably many “local maxima”, and there are also countably many loops. Hence, the set of θ 's such that $\Gamma \notin M(\theta)$ is at most countable. But the law of the CLE is invariant under rotations, so that $P(\Gamma \in M(\theta))$ does not depend on θ . Since its mean value (for $\theta \in [0, 2\pi]$) is 1, it is always equal to 1.

If we now define, for all $r > 0$, the Moebius transformation of the unit disc such that $\psi(1) = 1$, $\psi(-1) = -1$ and $\psi'(1) = r$, the invariance of the CLE law under ψ shows that for each given r , almost surely, no loop of the CLE locally touches $\psi([-i, i])$ without crossing it.

4. For any $r < 1$, the probability that $r\mathbb{U}$ is entirely contained in the interior of one single loop is positive: This is because each simple loop γ that surrounds the origin can be approximated “from the outside” by a loop η on a grid of rational meshsize with as much precision as one wants. This implies in particular that one can find one such loop η in such a way that the image of one loop γ in the CLE under a conformal map from $\text{int}(\eta)$ onto \mathbb{U} that preserves the origin has an interior containing $r\mathbb{U}$. Hence, if we apply the exploration property to $U = \text{int}(\eta)$, we get readily that with positive probability, the interior of some loop in the CLE contains $r\mathbb{U}$. Since this property will not be directly used nor needed later in the paper, we leave the details of the proof to the reader.
5. The restriction property continues to hold if we replace the simply connected domain $U \subset \mathbb{U}$ with the union U of countably many disjoint simply connected domains $U_i \subset \mathbb{U}$. That is, we still have that the conditional law of $(\gamma_j, j \in J^*)$ given U^* (or alternatively given the family $(\gamma_j, j \in I)$) is P_{U^*} . To see this, note first that applying the property separately for each U_i gives us the marginal conditional laws for the set of loops within each of the U_i . Then, observe that the conditional law of the set of loops in U_i is unchanged when one further conditions on the set of loops in $\cup_{i' \neq i} U_{i'}$. Hence, the sets of loops in the domains $U_1^*, \dots, U_i^*, \dots$ are in fact independent (conditionally on $(\gamma_j, j \in I)$).

3 Explorations

3.1 Exploring CLEs – heuristics

Suppose that $\Gamma = (\gamma_j, j \in J)$ is a CLE in the unit disc \mathbb{U} . Suppose that $\varepsilon > 0$ is given. Cut out from the disc a little given shape $S = S(\varepsilon) \subset \mathbb{U}$ of radius ε around 1. If y is a point on the unit circle, then we may write yS for y times the set S — i.e., S rotated around the circle via multiplication by y . The precise shape of S will not be so important; for concreteness, we may at this point think of S as being equal to the ε -neighborhood of 1 in the unit disc. Let U_1 denote the connected component that contains the origin of the set obtained when removing from $U'_1 := \mathbb{U} \setminus S$ all the loops that do not stay in U'_1 . If the loop γ_0 in the CLE that surrounds the origin did not go out of $\mathbb{U} \setminus S$, then the (conditional) law of the CLE restricted to U_1 (given the knowledge of U_1) is again a CLE in this domain (this is just

the CLE restriction property). We then define the conformal map Φ_1 from U_1 onto \mathbb{U} with $\Phi_1(0) = 0$ and $\Phi_1'(0) > 0$.

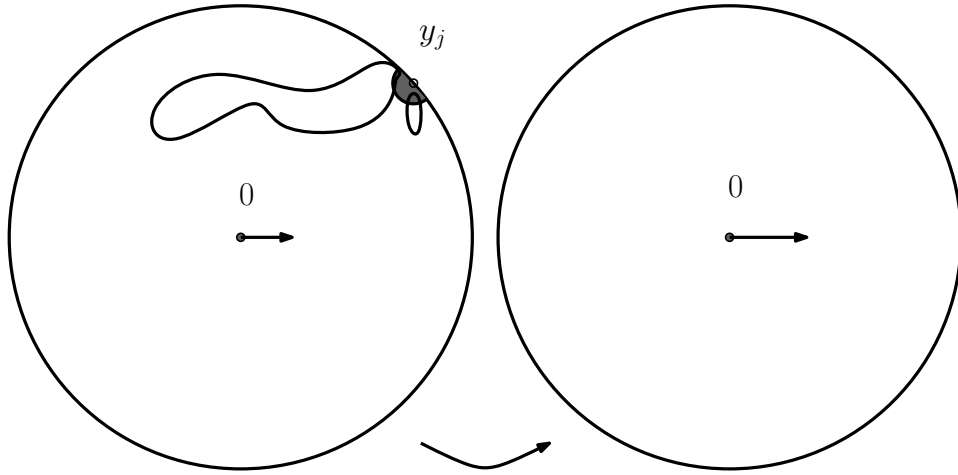

Figure 5: The first exploration step (sketch)

Now we again explore a little piece of U_1 : we choose some point y_1 on the unit circle and define U'_2 to be the domain obtained when removing from U_1 the preimage (under Φ_1) of the shape S centered around y_1 (i.e., $U'_2 = \Phi_1^{-1}(\mathbb{U} \setminus y_1 S)$). Again, we define the connected component U_2 that contains the origin of the domain obtained when removing from U'_2 the loops that do not stay in U'_2 and the conformal map Φ_2 from U_2 onto \mathbb{U} normalized at the origin.

We then explore in U_2 if $\gamma_0 \subset U_2$, and so on. One can iterate this procedure until we finally “discover” the loop γ_0 that surrounds the origin. Clearly, this will happen after finitely many steps with probability one, because at each step the derivative $\Phi'_n(0)$ is multiplied by a quantity that is bounded from below by a constant $v > 1$ (this is because at each step, one composes Φ_n with a conformal map corresponding to the removal of at least a shape $y_n S$ in order to define Φ_{n+1}). Hence, if we never discovered γ_0 , it would follow from Koebe’s 1/4-Theorem that $d(\partial U_n, 0) \rightarrow 0$ as $n \rightarrow \infty$, and this would contradict the fact that γ_0 is almost surely at positive distance from 0.

We call N the random finite step after which the loop γ_0 is discovered i.e., such that $\gamma_0 \subset U_N$ but $\gamma_0 \not\subset U'_{N+1}$. It is important to notice that at each step until N , one is in fact repeating the same experiment (up to a conformal transformation), namely cutting out the shape S from \mathbb{U} and then cutting out all loops that intersect S . Because of the CLE’s conformal restriction property, this procedure defines an i.i.d. sequence of steps, stopped at the geometric random variable N , which is the first step at which one discovers a loop surrounding the origin that intersects $\mathbb{U} \setminus y_N S$. This shows also that the conditional law of the CLE in \mathbb{U} given the fact that $\gamma_0 \cap S \neq \emptyset$ is in fact identical to the image under $y_N^{-1} \Phi_N$ of the CLE in U_N .

In the coming sections, we will use various sequences $y_n = y_n(\varepsilon)$. One natural possibility is to simply always choose $y_n = 0$. This will give rise to the ε radial-explorations that will be discussed in Section 4. However, we first need another procedure to choose $y_n(\varepsilon)$ that will

enable to control the behavior of $\Phi_{N(\varepsilon)}$, of $U_{N(\varepsilon)}$ and of $y_{N(\varepsilon)}$ as ε tends to 0. This will then allow us show that the conditional law of the CLE in \mathbb{U} given the fact that $\gamma_0 \cap S(\varepsilon) \neq \emptyset$ has a limit when $\varepsilon \rightarrow 0$.

3.2 Discovering the loops that intersect a given set

The precise shape of the sets S that we will use will in fact not be really important, as long as they are close to small semi-discs. It will be convenient to define, for each y on the unit circle, the set $D(y, \varepsilon)$ to be the image of the set $\{z \in \mathbb{H} : |z| \leq \varepsilon\}$, under the conformal map $\Psi : z \mapsto y(i - z)/(i + z)$ from the upper half-plane \mathbb{H} onto the unit disc such that $\Psi(i) = 0$ and $\Psi(0) = y$. Note that $|\Psi'(0)| = 2$, so that when ε is very small, the set $D(y, \varepsilon)$ is close to the intersection of a small disc of radius 2ε around y with the unit disc. This set $D(1, \varepsilon)$ will play the role of our set $S(\varepsilon)$.

Suppose that $\Gamma = (\gamma_j, j \in J)$ is a given (deterministic) simple loop-configuration in \mathbb{U} . (In this section, we will derive deterministic statements that we will apply to CLEs in the next section.) We suppose that:

1. In Γ , one loop (that we call γ_0) has 0 in its interior.
2. $A \subset \overline{\mathbb{U}}$ is a given closed simply connected set such that $\mathbb{U} \setminus A$ is simply connected, A is the closure of the interior of A , and the length of $\partial A \cap \partial \mathbb{U}$ is positive.
3. The loop γ_0 does not intersect A .
4. All γ_j 's in Γ that intersect ∂A also intersect the interior of A .

Our goal will be to explore almost all (when ε is small) large loops of Γ that intersect A by iterating explorations of ε -discs.

When $\varepsilon > 0$ is given, it will be useful to have general criteria that imply that a subset V of the unit disc contains $D(y, \varepsilon)$ for at least one $y \in \mathbb{U}$: Consider two independent Brownian motions, B^1 and B^2 started from the origin, and stopped at their first hitting times T_1 and T_2 of the unit circle. Consider U^a and U^b the two connected components of $\mathbb{U} \setminus (B^1[0, T_1] \cup B^2[0, T_2])$ that have an arc of $\partial \mathbb{U}$ on their boundary. Note that for small enough ε , the probability $p(\varepsilon)$ that both U^a and U^b contain some $D(y, \varepsilon)$ is clearly close to 1.

Suppose now that V is a closed subset of \mathbb{U} such that $\mathbb{U} \setminus V$ is simply connected, and let $u(V)$ be the probability that one of the two random sets U^a or U^b is a subset of V . Then:

Lemma 3.1. *For all $u > 0$, there exists a positive $\varepsilon_0 = \varepsilon_0(u)$ such that there exists $y \in \partial \mathbb{U}$ with $D(y, \varepsilon) \subset V$ as soon as $u(V) \geq u$.*

Proof. The definition of $p(\varepsilon)$ and of $u(V)$ shows that V contains some $D(y, \varepsilon)$ with a probability at least $u - (1 - p(\varepsilon))$. Since this is a deterministic fact about V , we conclude that the set V does indeed contain some set $D(y, \varepsilon)$ for some $y \in \partial \mathbb{U}$ as soon as $p(\varepsilon) \geq 1 - u/2$. It therefore suffices to choose ε_0 in such a way that $u_0 = 2(1 - p(\varepsilon_0))$. \square

Define now a particular class of iterative exploration procedures as follows: Let $U_0 = \mathbb{U}$ and $\Phi_0(z) = z$. For $j \geq 0$:

- Choose some y_j on $\partial\mathbb{U}$ in such a way that $\Phi_j^{-1}(D(y_j, \varepsilon)) \subset A$.
- Define U_{j+1} as the connected component that contains the origin of the set obtained by removing from $U'_{j+1} := U_j \setminus \Phi_j^{-1}(D(y_j, \varepsilon))$ all the loops in Γ that do not stay in U'_{j+1} .
- Let Φ_{j+1} be the conformal map from U_{j+1} onto \mathbb{U} such that $\Phi_{j+1}(0) = 0$ and $\Phi'_{j+1}(0) > 0$.

There is only one way in which such an iterative definition can be brought to an end, namely if at some step N_0 , it is not possible anymore to find a point y on $\partial\mathbb{U}$ such that $\Phi_{N_0}^{-1}(D(y, \varepsilon)) \subset A$ (otherwise it means that at some step N , one actually has discovered the loop γ_0 , so that U_{N+1} is not well-defined but we know that this cannot be the case because we have assumed that $\gamma_0 \cap A = \emptyset$). Such explorations $(\Phi_n, n \leq N_0)$ will be called ε -admissible explorations of the pair (Γ, A) .

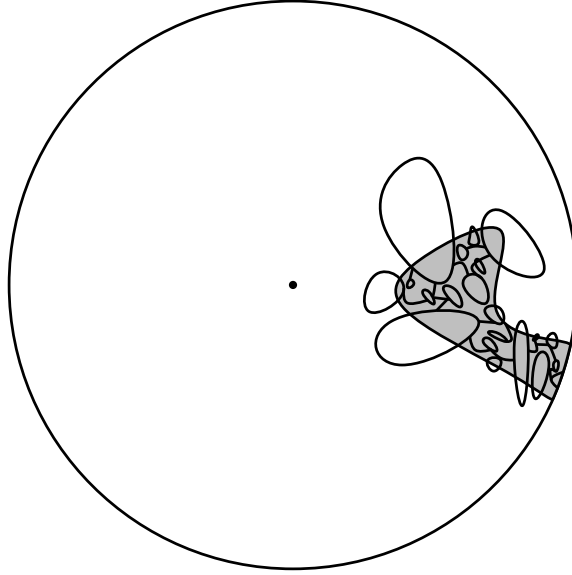

Figure 6: A completed ε -admissible exploration of (Γ, A) (sketch)

Our goal is to show that when ε gets smaller, the set U_{N_0} is close to \tilde{U} , where \tilde{U} is the connected component containing the origin of $U \setminus \cup_{i \in I(U)} \gamma_i$ (here $U = \mathbb{U} \setminus A$).

The local finiteness condition implies that the boundary of \tilde{U} consists of points that are either on ∂U or on some loop γ_j (in this case, we say that this loop γ_j contributes to this boundary).

Lemma 3.2. *For every $\alpha > 0$, there exists $\varepsilon'_0 = \varepsilon'_0(\Gamma, \alpha, A)$ such that for all $\varepsilon \leq \varepsilon'_0$, every loop of diameter greater than α that contributes to $\partial\tilde{U}$ is discovered by any ε -admissible exploration of (Γ, A) .*

Proof. Suppose now that γ_j is a loop in Γ that contributes to the boundary of \tilde{U} . Our assumptions on Γ and A ensure that γ_j therefore intersects both the interior of A and $\mathbb{U} \setminus A$.

This implies that we can define three discs d_1 , d_2 and d_3 in the interior of γ_j such that $d_1 \subset \mathbb{U} \setminus A$, and $\overline{d_2} \subset d_3 \subset A$.

Suppose that for some $n \leq N_0$, this loop γ_j has not yet been discovered at step n . Since $\gamma_j \cap \partial\tilde{U} \neq \emptyset$ and $\tilde{U} \subset U_n$, we see that $\gamma_j \subset U_n$. Since this loop has a positive diameter, and since Γ is locally finite, we can conclude that with a positive probability u that depends on $(\Gamma, A, \gamma_j, d_1, d_2, d_3)$, two Brownian motions B^1 and B^2 started from the origin behave as follows:

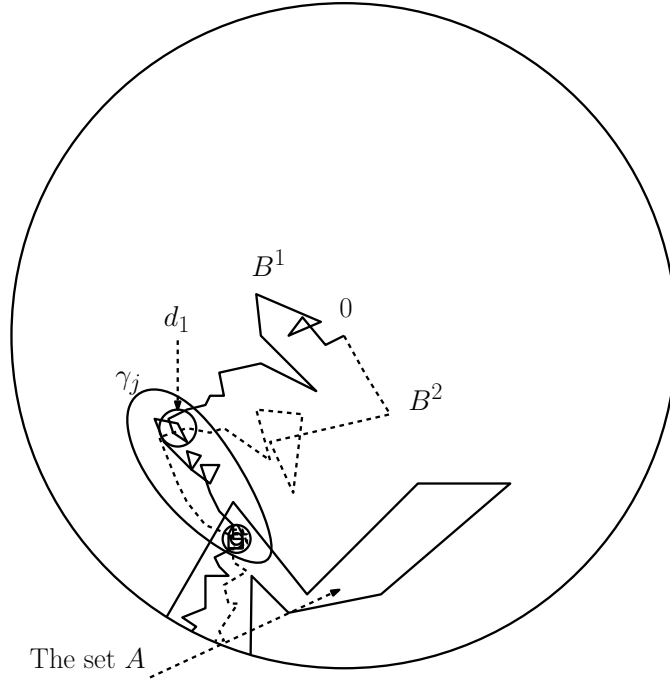

Figure 7: The loop γ_j , the three discs and the Brownian motions (sketch)

- They both enter d_1 without hitting A or ∂U or any of the other loops γ_i for $i \in I(U)$.
- They both subsequently enter d_2 without going out of $\text{int}(\gamma_j)$.
- They both subsequently disconnect d_2 from the boundary of d_3 before hitting it. (This in particular guarantees that the curves hit one another within the annulus $d_3 \setminus d_2$.)
- They both subsequently hit $\partial\mathbb{U}$ without going out of A .

This shows that one of the sets U^a and U^b as defined before Lemma 3.1 is contained in A with probability at least u . In fact, if we stop the two Brownian motions at their first exit of U_n instead on the hitting time of $\partial\mathbb{U}$, the same phenomenon will hold: One of the two sets U_n^a and U_n^b (with obvious notation) will be contained in $U_n \cap A$ with probability at least u . By conformal invariance of planar Brownian motion, if we apply Lemma 3.1 to the conformal images of these two Brownian motions under Φ_n , we get that if ε is chosen to be sufficiently small, then it is always possible to find an ε -admissible point y_{n+1} . Hence, $N_0 > n$, i.e. n is not the final step of the exploration.

As a consequence, we see that the loop γ_j is certainly discovered before N_0 , i.e., that $\gamma_j \subset \mathbb{U} \setminus U_{N_0}$, for all $\varepsilon \leq \varepsilon'_0(\gamma_j, \Gamma, A)$. The lemma follows because for each positive α , there are only finitely many loops of diameter greater than α in Γ . \square

Loosely speaking, this lemma tells us that indeed, U_{N_0} converges to \tilde{U} as $\varepsilon \rightarrow 0$. We now make this statement more precise, in terms of the conformal maps Φ_{N_0} and $\tilde{\Phi}$, where $\tilde{\Phi}$ denotes the conformal map from \tilde{U} onto \mathbb{U} with $\tilde{\Phi}(0) = 0$ and $\tilde{\Phi}'(0) > 0$. Let us first note that $\tilde{U} \subset U_{N_0}$ because the construction of U_{N_0} implies that before N_0 one can only discover loops that intersect A .

Let us now consider a two-dimensional Brownian motion B started from the origin, and define T (respectively \tilde{T}) the first time at which it exits U (resp. \tilde{U}). Let us make a fifth assumption on A and Γ :

- 5. Almost surely, $B_T \in \partial\mathbb{U} \cup (\cup_j \text{int}(\gamma_j))$.

Note that this is indeed almost surely the case for a CLE (because Γ is then independent of B_T so that B_T is a.s. in the interior of some loop if it is not on $\partial\mathbb{U}$). This assumption implies that almost surely, either $\tilde{T} < T$ (and $B_{\tilde{T}}$ is on the boundary of some loop of positive diameter) or $B_T = B_{\tilde{T}} \in \partial\mathbb{U}$. The previous result shows that if \hat{T} denotes the exit time of U_{N_0} (for some given ε -admissible exploration), then $\hat{T} = \tilde{T}$ for all small enough ε .

It therefore follows that Φ_{N_0} converges to $\tilde{\Phi}$ in the sense that for all proper compact subsets K of \mathbb{U} , the functions $\Phi_{N_0}^{-1}$ converge uniformly to $\tilde{\Phi}^{-1}$ in K as $\varepsilon \rightarrow 0$. We shall use this notion of convergence on various occasions throughout the paper. Note that this it corresponds to the convergence with respect to a distance d , for instance

$$d(\varphi_1, \varphi_2) = \sum_{n \geq 1} 2^{-n} \max_{|z| \leq 1-1/n} \|\varphi_1^{-1}(z) - \varphi_2^{-1}(z)\|.$$

We have therefore shown that:

Lemma 3.3. *For each given loop configuration and A (satisfying conditions 1-5), $d(\Phi_{N_0}, \tilde{\Phi})$ tends to 0 as $\varepsilon \rightarrow 0$, uniformly with respect to all ε -admissible explorations of (Γ, A) .*

Suppose now that γ_0 intersects the interior of A . Exactly the same arguments show that there exists $\varepsilon_1 = \varepsilon(\Gamma, A)$ such that for all “ ε -admissible choices” of the y_j ’s for $\varepsilon \leq \varepsilon_1$, one discovers γ_0 during the exploration (and this exploration is then stopped in this way).

3.3 Discovering random configurations along some given line

For each small δ , we define the wedge $W_\delta = \{ue^{i\theta} : u \in (0, 1) \text{ and } |\theta| \leq \delta\}$. For each positive r , let \tilde{W}_r denote the image of the positive half disc $\{z \in \mathbb{U} : \Re(z) > 0\}$ under the Moebius transformation of the unit disc with $\psi(1) = 1$, $\psi(-1) = -1$ and $\psi'(1) = r$. Note that $r \mapsto \tilde{W}_r$ is continuously increasing on $(0, 1]$ from $\tilde{W}_{0+} = \{1\}$ to the positive half-disc \tilde{W}_1 . For all non-negative integer $k \leq 1/\delta$, we then define

$$A^{\delta, k} = W_\delta \cap \tilde{W}_{k\delta}.$$

Suppose that δ is fixed, and that Γ is a loop-configuration satisfying conditions 1-5 for all set $A^{\delta,k}$ for $k \leq K$, where

$$K = K(\Gamma, \delta) = \max\{k : \gamma_0 \cap A_k^\delta = \emptyset\}.$$

We are going to define the conformal maps $\tilde{\Phi}^{\delta,1}, \dots, \tilde{\Phi}^{\delta,K}$ corresponding to the conformal map $\tilde{\Phi}$ when A is respectively equal to $A^{\delta,1}, \dots, A^{\delta,K}$.

For each given δ and ε , it is possible to define an ε -admissible chain of explorations of Γ and $A^{\delta,1}, A^{\delta,2}, \dots$ as follows: Let us first start with an ε -admissible exploration of $(\Gamma, A^{\delta,1})$. If $K \geq 1$, then such an exploration does not encounter γ_0 , and we then continue to explore until we get an ε -admissible exploration of $(\Gamma, A^{\delta,2})$, and so on, until the last value K' of k for which the exploration of $(\Gamma, A^{\delta,k})$ fails to discover γ_0 . In this way, we define conformal maps

$$\tilde{\Phi}_\varepsilon^{\delta,1}, \dots, \tilde{\Phi}_\varepsilon^{\delta,K'}$$

corresponding to the sets discovered at each of these K' explorations. Note that $K' \geq K$. One can then also start to explore the set $A^{\delta,K'+1}$ until one actually discovers the loop γ_0 .

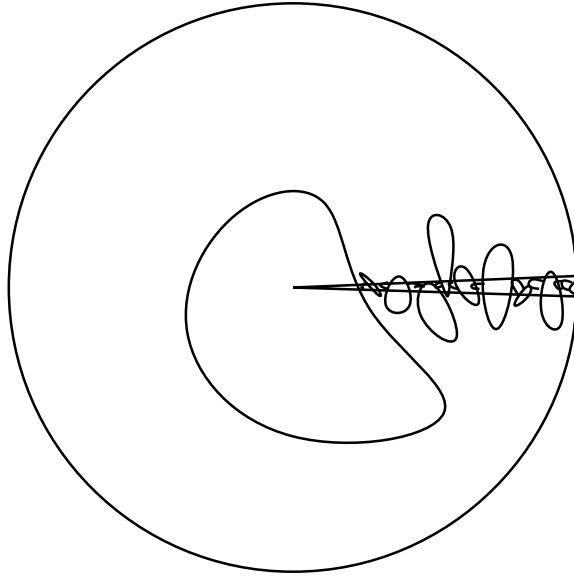

Figure 8: An exploration-chain and γ_0 (sketch)

This procedure therefore defines a single ε -admissible exploration (via some sequence (Φ_n, y_n)), that explores the sets $A^{\delta,j}$'s in an ordered way, and finally stops at some step N , i.e., the last step before one actually discovers γ_0 . We call this an ε -admissible exploration chain of $A^{\delta,1}, A^{\delta,2}, \dots$. Our previous results show that uniformly over all such ε -admissible exploration-chains (for each given Γ and δ):

- $K' = K$ for all sufficiently small ε .
- $\lim_{\varepsilon \rightarrow 0} (\tilde{\Phi}_\varepsilon^{\delta,1}, \dots, \tilde{\Phi}_\varepsilon^{\delta,K'}) = (\tilde{\Phi}^{\delta,1}, \dots, \tilde{\Phi}^{\delta,K})$.

We now suppose that Γ is a *random* loop-configuration. Then, for each δ , $K = K(\Gamma, \delta)$ is random. We assume that for each given δ , the conditions 1-5 hold almost surely for each of the K sets $A_1^\delta, \dots, A_K^\delta$. The previous results therefore hold almost surely; this implies for instance that for each $\eta > 0$, there exists $\varepsilon_2(\delta)$ such that for all such ε -admissible exploration-chain of $(\Gamma, A_1^\delta, A_2^\delta, \dots)$ with $\varepsilon \leq \varepsilon_2(\delta)$,

$$P(K' = K \text{ and } d(\tilde{\Phi}_\varepsilon^{\delta, K}, \tilde{\Phi}^{\delta, K}) < \eta) \geq 1 - \eta.$$

We will now wish to let δ go to 0 (simultaneously with ε , taking $\varepsilon(\delta)$ sufficiently small) so that we will (up to small errors that disappear as ε and δ vanish) just explore the loops that intersect the segment $[0, 1]$ “from 1 to 0” up to the first point at which it meets γ_0 . We therefore define

$$R = \max\{r \in [0, 1], r \in \gamma_0\}.$$

We define the open set \hat{U} as the connected component containing the origin of the set obtained by removing from $\mathbb{U} \setminus [R, 1]$ all the loops that intersect $(R, 1]$. Note that $\gamma_0 \subset \hat{U} \cup \{R\}$. We let $\hat{\Phi}$ denote the conformal map from \hat{U} onto \mathbb{U} such that $\hat{\Phi}(0) = 0$ and $\hat{\Phi}'(0) > 0$. We also define $\hat{y} = \hat{\Phi}(R)$.

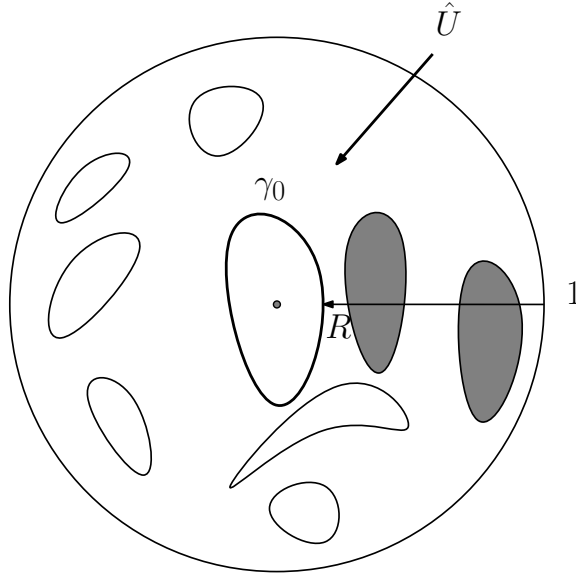

Figure 9: Exploring up to γ_0 (sketch)

Proposition 3.4. *For a well-chosen function $\varepsilon_3 = \varepsilon_3(\delta)$ (that depends on the law of Γ only), for any choice of $\varepsilon(\delta)$ -admissible exploration-chain of the random loop-configuration Γ and $A^{\delta, 1}, \dots$ with $\varepsilon(\delta) \leq \varepsilon_3(\delta)$, the random pair (Φ_N, y_N) converges almost surely to the pair $(\hat{\Phi}, \hat{y})$ as $\delta \rightarrow 0$.*

Proof. Note first that our assumptions on Γ imply that almost surely $\Phi^{\delta, K} \rightarrow \hat{\Phi}$ as $\delta \rightarrow 0$ (this is a statement about Γ that does not involve explorations).

We know that γ_0 intersects $A^{\delta, K+1} \setminus A^{\delta, K}$. The local finiteness of Γ and the fact that any two loops are disjoint therefore implies that the diameter of the second largest loop (after

γ_0) of Γ that intersects this set almost surely tends to 0 as $\delta \rightarrow 0$. This in particular implies that almost surely, the distance between Φ_N and $\tilde{\Phi}_\varepsilon^{\delta, K}$ tends to 0 as $\delta \rightarrow 0$ (uniformly with respect to the choice of the exploration, as long as $\varepsilon(\delta)$ tends to 0 sufficiently fast).

Recall finally that for each given δ , $\tilde{\Phi}_\varepsilon^{\delta, K} \rightarrow \Phi^{\delta, K}$ as $\varepsilon \rightarrow 0$. Hence, if $\varepsilon(\delta)$ is chosen small enough, the map Φ_N indeed converges almost surely to $\hat{\Phi}$ as $\delta \rightarrow 0$.

It now remains to show that $y_N \rightarrow \hat{y}$. Note that $R \in U_N$ (because at that step, γ_0 has not yet been discovered), that $R \in A^{\delta, K'+1} \setminus A^{\delta, K'}$ (with high probability, if $\varepsilon(\delta)$ is chosen to be small enough). On the other hand, the definition of the exploration procedure and of K' shows that

$$\Phi_N^{-1}(D(y_N, \varepsilon)) \cap (A^{\delta, K'+1} \setminus A^{\delta, K'}) \neq \emptyset$$

so that if we choose $\varepsilon(\delta)$ small enough, then the Euclidean distance between $\Phi_N^{-1}(D(y_N, \varepsilon))$ and R tends to 0 almost surely.

Let us look at the situation at step N : The loop $\Phi_N(\gamma_0)$ in the unit disc is intersecting $D(y_N, \varepsilon)$ (by definition of N), and it contains also the point $\Phi_N(R)$ (because $R \in \gamma_0$). Suppose that $|\Phi_N(R) - y_N|$ does not almost surely tend to 0 (when $\delta \rightarrow 0$); then, with positive probability, we could find a sequence $\delta_j \rightarrow 0$ such that $\Phi_N(R)$ and y_N converge to different points on the unit circle along this subsequence. In particular, the harmonic measure at the origin of any of the two parts of the loop between the moment it visits $\Phi_N(R)$ and the ε -neighborhood of y_N in \mathbb{U} is bounded away from 0. Hence, this is also true for the preimage γ_0 under Φ_N : γ_0 contains two disjoint paths from R to $\Phi_N^{-1}(D(y_N, \varepsilon))$ such that their harmonic measure at 0 in \mathbb{U} is bounded away from 0. Recall that $\Phi_N^{-1}(D(y_N, \varepsilon)) \subset A^{\delta, K'+1}$. In the limit when $\delta \rightarrow 0$, we therefore end up with a contradiction, as we have two parts of γ_0 with positive harmonic measure from the origin, that join R to some point of $[R, 1]$, which is not possible because $\gamma_0 \cap (R, 1] \neq \emptyset$ and γ_0 is a simple loop. Hence, we can conclude that $|\Phi_N(R) - y_N| \rightarrow 0$ almost surely.

Finally, let us observe that $\Phi_N(R) \rightarrow \hat{\Phi}(R)$ almost surely (this follows for instance from the fact that a continuous path that stays inside γ_0 and joins the origin to R stays both in all U_N 's and in \hat{U}). It follows that y_N converges almost surely to \hat{y} . \square

4 The one-point pinned loop measure

4.1 The pinned loop surrounding the origin in \mathbb{U}

We will use the previous exploration mechanisms in the context of CLEs. It is natural to define the notion of Markovian explorations of a CLE. Suppose now that Γ is a CLE in the unit disc and that ε is fixed. When $\gamma_0 \cap D(1, \varepsilon) = \emptyset$, define just as before the set U_1 and the conformal map Φ_1 obtained by discovering the set of loops Γ_1 of Γ that intersect $D(y_0, \varepsilon)$. Then we choose y_1 and proceed as before, until we discover (at step $N + 1$) the loop γ_0 that surrounds the origin. We say that the exploration is Markovian if for each n , the choice of y_n is measurable with respect to the σ -field generated by $\Gamma_1, \dots, \Gamma_n$, i.e., the set of all already discovered loops.

A straightforward consequence of the CLE's restriction property is that for each n , conditionally on $\Gamma_1, y_1, \dots, \Gamma_n, y_n$ (and $n \leq N$), the law of the set of loops of Γ that stay in U_n is that of a CLE in U_n . In other words, the image of this set of loops under Φ_n is independent

of $\Gamma_1, y_1, \dots, \Gamma_n, y_n$ (on the event $\{n \leq N\}$). In fact, we could have used this independence property as a definition of Markovian explorations (it would allow extra randomness in the choice of the sequence y_n).

In other words, an exploration is Markovian if we can choose y_n as we wish using the information about the loops that have already been discovered, but we are not allowed to use any information about the yet-to-be-discovered loops. This ensures that one obtains an iteration of i.i.d. explorations as argued in subsection 3.1. In particular, if an exploration is Markovian, the random variable N is geometric

$$P(N \geq n) = P(\gamma_0 \cap D(1, \varepsilon) = \emptyset)^n,$$

and $y_N^{-1}\Phi_N^{-1}(\gamma_0)$ is distributed according to the conditional law of γ_0 given $\{\gamma \cap D(1, \varepsilon) \neq \emptyset\}$.

Recall that a CLE is a random loop configuration such that for any given δ and $k \leq 1/\delta$, almost surely, all loops that intersect $A^{\delta, k}$ also intersect its interior. We can therefore apply Proposition 3.4, and use Markovian $\varepsilon(\delta)$ -admissible successive explorations of $A^{\delta, 1}, \dots$. Combining this with our description of the conditional law of γ_0 given $\{\gamma \cap D(1, \varepsilon) \neq \emptyset\}$, we get the following result:

Proposition 4.1. *When $\varepsilon \rightarrow 0$, the law of γ_0 conditioned on the event $\{\gamma_0 \cap D(1, \varepsilon) \neq \emptyset\}$ converges to the law of $\hat{y}^{-1}\hat{\Phi}(\gamma_0)$ (using for instance the weak convergence with respect to the Hausdorff topology on compact sets).*

Note that local finiteness of the CLE ensures that $\hat{\Phi}(\gamma_0)$ is a simple loop in $\overline{\mathbb{U}}$ that intersects $\partial\mathbb{U}$ only at \hat{y} , so that $\hat{y}^{-1}\hat{\Phi}(\gamma_0)$ is indeed a loop in $\overline{\mathbb{U}}$ that touches $\partial\mathbb{U}$ only at 1.

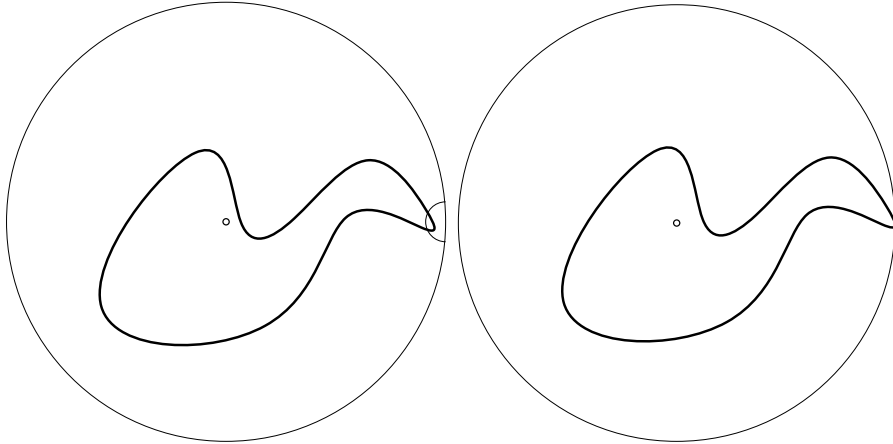

Figure 10: The law of γ_0 conditioned on the event $\{\gamma_0 \cap D(1, \varepsilon) \neq \emptyset\}$ converges (sketch)

This limiting law will inherit from the CLE various interesting properties. The loop γ_0 in the CLE can be discovered along the ray $[1, 0]$ in the unit disc as in this proposition, but one could also have chosen any other smooth continuous simple curve from $\partial\mathbb{U}$ to 0 instead of that ray and discovered it that way. This fact should correspond to some property of the law of this pinned loop. Conformal invariance of the CLE will also imply some conformal invariance properties of this pinned loop. The goal of the coming sections is to derive and exploit some of these features.

4.2 The infinite measure on pinned loops in \mathbb{H}

We are now going to associate to each CLE a natural measure on loops that can loosely be described as the law of a loop “conditioned to touch a given boundary point”. In the previous subsection, we have constructed a probability measure on loops in the unit disc that was roughly the law of γ_0 (the loop in the CLE that surrounds the origin) “conditioned to touch the boundary point 1”. We will extend this to an infinite measure on loops that touch the boundary at one point; the measure will be infinite because we will not prescribe the “size” of the boundary-touching loop; it can be viewed as a CLE “excursion measure” (“bubble measure” would also be a possible description). We find it more convenient at this



Figure 11: The construction of μ^i (sketch)

stage to work in the upper half-plane rather than the unit disc because scaling arguments will be easier to describe in this setting. We therefore first define the probability measure μ^i as the image of the law of $\hat{\Phi}(\gamma_0)$ under the conformal map from \mathbb{U} onto the half-plane that maps 0 to i , and \hat{y} to 0 (we use the notation μ^i instead of P^i as in the introduction, because we will very soon be handling measures that are not probability measures). In other words, the probability measure μ^i is the limit as $\varepsilon \rightarrow 0$ of the law of the loop $\gamma(i)$ that surrounds i in a CLE in the upper half-plane, conditioned by the fact that it intersects the set C_ε defined by

$$C_\varepsilon = \{z \in \mathbb{H} : |z| = \varepsilon\}.$$

For a loop-configuration Γ in the upper half-plane and $z \in \mathbb{H}$, we denote by $\gamma(z)$ the loop of Γ that surrounds z (if this loop exists).

When $z = i\lambda$ for $\lambda > 0$, scale invariance of the CLE shows that the limit as $\varepsilon \rightarrow 0$ of the conditional law of $\gamma(i\lambda)$ given that it intersects the disc of radius $\lambda\varepsilon$ exists, and that it is just the image of μ^i under scaling.

Let us denote by $u(\varepsilon)$ the probability that the loop $\gamma(i)$ intersects the disc of radius ε around the origin in a CLE. The description of the measure μ^i (in terms of $\hat{\Phi}$) derived in the previous section shows that at least for almost all λ sufficiently close to one, the loop that surrounds i also surrounds $i\lambda$ and i/λ with probability at least $1/2$ under μ^i , and that $i\lambda$ as well as λi are a.s. not on $\gamma(i)$ (when λ is fixed).

Let O_i denote the interior of the loop $\gamma(i)$. We know that

$$\lim_{\varepsilon \rightarrow 0} \frac{P(\lambda i \in O_i \text{ and } \gamma(i) \cap C_{\lambda\varepsilon} \neq \emptyset)}{u(\lambda\varepsilon)} = \mu^i(\lambda i \in O_i).$$

On the other hand, the scaling property of the CLE shows that when $\varepsilon \rightarrow 0$,

$$\begin{aligned}
& \frac{P(\lambda i \in O_i \text{ and } \gamma(i) \cap C_{\lambda\varepsilon} \neq \emptyset)}{u(\lambda\varepsilon)} \\
&= \frac{P(i \in O_{\lambda i} \text{ and } \gamma(\lambda i) \cap C_{\lambda\varepsilon} \neq \emptyset)}{u(\lambda\varepsilon)} \\
&= \frac{P(i/\lambda \in O_i \text{ and } \gamma(i) \cap C_\varepsilon \neq \emptyset)}{u(\varepsilon)} \times \frac{u(\varepsilon)}{u(\lambda\varepsilon)} \\
&\sim \mu^i(i/\lambda \in O_i) \times \frac{u(\varepsilon)}{u(\lambda\varepsilon)}.
\end{aligned}$$

Hence, for all λ sufficiently close to 1, we conclude that

$$\lim_{\varepsilon \rightarrow 0} \frac{u(\lambda\varepsilon)}{u(\varepsilon)} = \frac{\mu^i(i/\lambda \in O_i)}{\mu^i(\lambda i \in O_i)}.$$

If we call $f(\lambda)$ this last quantity, this identity clearly implies that this convergence in fact holds for all positive λ , and that $f(\lambda\lambda') = f(\lambda)f(\lambda')$. Furthermore, we see that $f(\lambda) \rightarrow 1$ as $\lambda \rightarrow 1$. Hence:

Proposition 4.2. *There exists a $\beta \geq 0$ (β cannot be negative since $\varepsilon \mapsto u(\varepsilon)$ is non-decreasing) such that for all positive λ ,*

$$f(\lambda) = \lim_{\varepsilon \rightarrow 0} \frac{u(\lambda\varepsilon)}{u(\varepsilon)} = \lambda^\beta.$$

This has the following consequence:

Corollary 4.3. $u(\varepsilon) = \varepsilon^{\beta+o(1)}$ as $\varepsilon \rightarrow 0+$.

Proof. Note that for any $\beta' < \beta < \beta''$, there exists $\varepsilon_0 = 2^{-n_0}$ such that for all $\varepsilon \leq \varepsilon_0$,

$$2^{\beta'} < u(2\varepsilon)/u(\varepsilon) < 2^{\beta''}.$$

Hence, for all $n \geq 0$ it follows that

$$u(\varepsilon_0)2^{-n\beta''} < u(\varepsilon_0 2^{-n}) < u(\varepsilon_0)2^{-n\beta'}.$$

It follows that $u(\varepsilon_0 2^{-n}) = 2^{-n\beta+o(n)}$ when $n \rightarrow \infty$. Since $\varepsilon \mapsto u(\varepsilon)$ is a non-decreasing function of ε , the corollary follows. \square

Because of scaling, we can now define for all $z = i\lambda$, a measure μ^z on loops $\gamma(z)$ that surround z and touch the real line at the origin as follows:

$$\mu^z(\gamma(z) \in \mathcal{A}) = \lambda^{-\beta} \mu^i(\lambda\gamma(i) \in \mathcal{A})$$

for any measurable set \mathcal{A} of loops. This is also the limit of $u(\varepsilon)^{-1}$ times the law of $\gamma(z)$ in an CLE, restricted to the event $\{\gamma(z) \cap C_\varepsilon \neq \emptyset\}$.

Let us now choose any z in the upper half-plane. Let $\psi = \psi_z$ now denote the Moebius transformation from the upper half-plane onto itself with $\psi(z) = i$ and $\psi(0) = 0$. Let $\lambda = 1/\psi'(0)$. Clearly, for any given $a > 1$, for any small enough ε , the image of C_ε under ψ is “squeezed” between the circles $C_{\varepsilon/a\lambda}$ and $C_{a\varepsilon/\lambda}$. It follows readily (using the fact that $f(a) \rightarrow 1$ as $a \rightarrow 1$) that the measure μ^z defined for all measurable \mathcal{A} by

$$\mu^z(\gamma(z) \in \mathcal{A}) = \lambda^{-\beta} \mu^i(\psi^{-1}(\gamma(i)) \in \mathcal{A})$$

can again be viewed as the limit when $\varepsilon \rightarrow 0$ of $u(\varepsilon)^{-1}$ times the distribution of $\gamma(z)$ restricted to $\{\gamma(z) \cap C_\varepsilon \neq \emptyset\}$.

Finally, we can now define our measure μ on pinned loops. It is the measure on simple loops that touch the real line at the origin and otherwise stay in the upper half-plane (this is what we call a pinned loop) such that for all $z \in \mathbb{H}$, it coincides with μ^z on the set of loops that surround z . Indeed, the previous limiting procedure shows immediately that for any two points z and z' , the two measures μ^z and $\mu^{z'}$ coincide on the set of loops that surround both z and z' . On the other hand, we know that a pinned loop necessarily surrounds a small disc: thus, the requirement that μ coincides with the μ^z 's (as described above) fully determines μ .

Let us sum up the properties of the pinned measure μ that we will use in what follows:

- For any conformal transformation ψ from the upper half-plane onto itself with $\psi(0) = 0$, we have

$$\psi \circ \mu = |\psi'(0)|^{-\beta} \mu.$$

This is the *conformal covariance property* of μ . Note that the maps $z \mapsto -za/(z-a)$ for real $a \neq 0$ satisfy $\psi'(0) = 1$ so that μ is invariant under these transformations.

- For each z in the upper half-plane, the mass $\mu(\{\gamma : z \in \text{int}(\gamma)\})$ is finite and equal to $\psi'(0)^\beta$, where ψ is the conformal map from \mathbb{H} onto itself with $\psi(0) = 0$ and $\psi(z) = i$.
- For each z in the upper half-plane, the measure μ restricted to the set of loops that surround z is the limit as $\varepsilon \rightarrow 0+$ of $u(\varepsilon)^{-1}$ times the law of $\gamma(z)$ in a CLE restricted to the event $\{\gamma(z) \cap C_\varepsilon \neq \emptyset\}$. In other words, for any bounded continuous (with respect to the Hausdorff topology, say) function F on the set of loops,

$$\mu(1_{\{z \text{ is surrounded by } \gamma\}} F(\gamma)) = \lim_{\varepsilon \rightarrow 0} \frac{1}{u(\varepsilon)} E(1_{\{\gamma(z) \cap C_\varepsilon \neq \emptyset\}} F(\gamma(z))).$$

Since this pinned measure is defined in a domain with one marked point, it is also quite natural to consider it in the upper half-plane \mathbb{H} , but to take the marked point at infinity. In other words, one takes the image of μ under the mapping $z \mapsto -1/z$ from \mathbb{H} onto itself. This is then a measure μ' on loops “pinned at infinity, i.e. on double-ended infinite simple curves in the upper-half plane that go from and to infinity. It clearly also has the scaling property with exponent β , and the invariance under the conformal maps that preserve infinity and the derivative at infinity is just the invariance under horizontal translations.

4.3 Discrete radial/chordal explorations, heuristics, background

We will now (and also later in the paper) use the exploration mechanism corresponding to the case where all points y_n are chosen to be equal to 1, instead of being tailored in order for the exploration to stay in some a priori chosen set A as in Section 3. Let us describe this discrete radial exploration (this is how we shall refer to it) in the setting of the upper half-plane \mathbb{H} : We fix $\varepsilon > 0$, and we wish to explore the CLE in the upper half-plane by repeatedly cutting out origin-centered semi-circles C_ε of radius ε (and the loops they intersect) and applying conformal maps. The first step is to consider the set of loops that intersect C_ε . Either we have discovered the loop $\gamma(i)$ (i.e., the loop that surrounds i), in which case we stop, or we haven't, in which case we define the connected component of the complement of these loops in $\mathbb{H} \setminus C_\varepsilon$ that contains i , and map it back onto the upper half-plane by the conformal map φ_1^ε such that $\varphi_1^\varepsilon(i) = i$ and $(\varphi_1^\varepsilon)'(i) > 0$. We then start again, and this defines an independent copy φ_2^ε of φ_1^ε . In this way, we define a random geometric number $N = N(\varepsilon)$ of such conformal maps $\varphi_1^\varepsilon, \dots, \varphi_N^\varepsilon$. The $N + 1$ -th map can not be defined because one then discovers the loop that surrounds i . The probability that $N \geq n$ is equal to $(1 - u(\varepsilon))^n$. The difference with the exploration procedure of Section 3 is that we do not try to explore “along some prescribed curve”, but we just iterate i.i.d. conformal maps in such a way that the derivative at i remains a positive real, i.e. we consistently target the inner point i .

Another natural exploration procedure uses a discrete chordal exploration that targets a boundary point: We first consider the set of loops in a CLE in \mathbb{H} that intersect C_ε . Now, we consider the unbounded connected component H_1 of the complement in $\mathbb{H} \setminus C_\varepsilon$ that intersect C_ε . We map it back onto the upper half-plane using the conformal map φ_1^ε normalized at infinity, i.e. $\varphi_1^\varepsilon(z) \sim z + o(1)$ as $z \in \mathbb{H}$. Then we iterate the procedure, defining an infinite i.i.d. sequence $\varphi_1^\varepsilon, \varphi_2^\varepsilon, \dots$ of conformal maps, and a decreasing family of domains $H_n = (\varphi_n^\varepsilon \circ \dots \circ \varphi_1^\varepsilon)^{-1}(\mathbb{H})$ (unlike the radial exploration, this chordal exploration never stops).

Let us make a little heuristic discussion in order to prepare what follows. When ε is very small, the law of the sets that one removes at each step in these two exploration mechanisms can be rather well approximated thanks to the measure μ . Let us for instance consider the chordal exploration. Because of μ 's scaling property, the μ -mass of the set of loops of half-plane capacity (which scales like the square of the radius) larger than η should decay as $\eta^{-\beta/2}$. In particular, in the discrete exploration, the average number of exploration steps where one removes a set $\varphi_n^\varepsilon(H_n \setminus H_{n+1})$ with half-plane capacity larger than x is equal (in the $\varepsilon \rightarrow 0$ limit) to $x^{-\beta/2}$ times the average number of exploration steps where one removes a set with half-plane capacity larger than one.

Readers familiar with Lévy processes will probably have recognized that in the $\varepsilon \rightarrow 0$ limits, the capacity jumps of the chordal exploration process will be distributed like the jumps of a $(\beta/2)$ -stable subordinator. It is important to stress that we know a priori that the limiting process has to possess macroscopic capacity jumps (corresponding to the discovered macroscopic loops). Since α -stable subordinators exist only for $\alpha \in (0, 1)$, we expect that $\beta < 2$. Proving this last fact will be the main goal of this section.

In fact, we shall see that the entire discrete explorations (and not only the process of accumulated half-plane capacities) converge to a continuous “Lévy-exploration” defined using a Poisson point process of pinned loops with intensity μ . We however defer the more precise

description of these Lévy explorations to Section 7, where we will also make the connection with branching $\text{SLE}_{\kappa, \kappa-6}$ processes and show how to reconstruct the law of a CLE using the measure μ only, i.e., that the measure μ characterizes the law of the CLE.

In fact, the rest of the paper has two main goals: The first one is to show that the CLE definition yields a description of the pinned measure μ in terms of SLE_κ for some $\kappa \in (8/3, 4]$. The second one is to prove that the pinned measure μ characterizes the law of the entire CLE and also to make the connection with $\text{SLE}(\kappa, \kappa - 6)$. We choose to start with the SLE-description of μ ; in the next subsection, we will therefore only derive those two results that will be needed for this purpose, leaving the more detailed discussion of continuous chordal explorations for later sections.

For readers who are not so familiar with Lévy processes or Loewner chains, let us now briefly recall some basic features of Poisson point processes and the stability of Loewner chains that will hopefully help making the coming proofs more transparent.

Stability of Loewner chains: Let \mathcal{S} denote the class of conformal maps $\varphi = \varphi_H$ from a subset H of the complex upper half-plane back onto the upper half-plane \mathbb{H} such that $i \in H$, $\varphi(i) = i$ and $\varphi'(i)$ is a positive real. Note that (because $H \subset \mathbb{H}$), $\varphi'(i) \geq 1$. Let us then define $a(\varphi) = \log \varphi'(i)$. This is a decreasing function of the domain H (the smaller H , the larger a), which is closely related to the conformal radius of the domain (one can for instance conjugate with $z \mapsto (i - z)/(i + z)$ in order to be in the usual setting of the disc). It is immediate to check that for some universal constant C , for all $r < 1/2$ and for all φ such that the diameter of $\mathbb{H} \setminus H$ is smaller than r ,

$$a(\varphi) \leq Cr^2.$$

On the other hand, for some other universal constant C' , for all $r < 1/2$ and for all H such that $ir \notin H$,

$$a(\varphi) \geq C'r^2.$$

Suppose now that $\varphi_1, \dots, \varphi_N$ are N given conformal maps in \mathcal{S} . Define $\Phi = \varphi_N \circ \dots \circ \varphi_1$ to be the composition of these conformal maps. It is also a standard and easy fact (that can be readily deduced from simple distortion estimates, or via Loewner's theory to approximate these maps via Loewner chains for instance) that for any family $(\psi_0^\delta, \dots, \psi_N^\delta)_{\delta > 0}$ of conformal maps in \mathcal{S} such that

$$\lim_{\delta \rightarrow 0} a(\psi_0^\delta) + \dots + a(\psi_N^\delta) = 0,$$

the conformal maps

$$\Phi^\delta = \psi_N^\delta \circ \varphi_N \circ \psi_{N-1}^\delta \circ \varphi_{N-1} \circ \dots \circ \varphi_1 \circ \psi_0^\delta$$

converge in Carathéodory topology (viewed from i) to Φ as $\delta \rightarrow 0$. In other words, putting some perturbations of the identity between the iterations of φ 's does not change things a lot, as long as the accumulated "size" (measured by a) of the perturbations is small.

Poisson point processes discrete random sequences: We will approximate Poisson point processes via discrete sequences of random variables. We will at some point need some rather trivial facts concerning Poisson random variables, that we know briefly derive. Suppose that we have a sequence of i.i.d. random variables $(X_n, n \geq 1)$ that take their values in some finite set $\{0, 1, \dots, k\}$ with $P(X_1 = 0) > 0$. Let N denote the smallest n value at

which $X_n = 0$. For each $j \in \{1, \dots, k\}$, let N_j denote the cardinality of $\{n \in \{1, \dots, N-1\} : X_n = j\}$. We want to control the joint law of (N_1, \dots, N_k) .

One convenient way to represent this joint law is to consider a Poisson point process $(X_j, t_j)_{j \in J}$ on $\mathcal{A} \times [0, \infty)$ with intensity $\mathcal{M} \times dt$, where \mathcal{M} is some σ -finite measure on a space \mathcal{A} . Consider disjoint measurable sets A, A_1, \dots, A_k in \mathcal{A} with $\mathcal{M}(A) = 1$, $\mathcal{M}(A_1) = a_1 < \infty$, \dots , $\mathcal{M}(A_k) = a_k < \infty$. We define

$$T = \inf\{t > 0 : \exists j \in J \text{ such that } T_j \leq t \text{ and } X_j \in A\},$$

i.e., loosely speaking, if we interpret t as a time-variable, T is the first time at which one observes an X in A . Since $\mathcal{M}(A) = 1$, the law of T is exponential with parameter 1. In particular, $P(T > 1) = 1/e$. We now define, for $j = 1, \dots, k$,

$$N_j = \#\{j : T_j \leq T \text{ and } X_j \in A_j\},$$

i.e., the number of times one has observed an X in A_j before the first time at which one observes an X in A . Then the law of N_1, \dots, N_k is the same as before, where $P(X_1 = j) = a_j / (1 + a_1 + \dots + a_j)$.

Because of the independence properties of Poisson point processes, the conditional law of (N_1, \dots, N_k) given T is that of independent Poisson random variables of respective means $TM(A_1), \dots, TM(A_k)$. Hence, $E(N_j) = E(T)M(A_j) = M(A_j)$. Furthermore, if we condition on the event $\{T > 1\}$, the (joint) conditional distribution of N_1, \dots, N_k “dominates” that of k independent Poisson random variables of parameter a_1, \dots, a_k .

4.4 A priori estimates for the pinned measure

Let us denote the “radius” of a loop γ in the upper half-plane by

$$R(\gamma) = \max\{|z| : z \in \gamma\}.$$

Lemma 4.4. *The μ -measure of the set of loops with radius greater than 1 is finite.*

Proof. Let us use the radial exploration mechanism. The idea of the proof is to see that if the μ -mass of the set of loops of radius greater than 1 is infinite, then one “collects” too many macroscopic loops before finding $\gamma(i)$ in the exploration mechanism, which will contradict the local finiteness of the CLE.

Recall that, at this moment, we know that for any given point $z \in \mathbb{H}$, the measure μ^z is the limit when $\varepsilon \rightarrow 0$ of $u(\varepsilon)^{-1}$ times the law of $\gamma(z)$ restricted to the event that $\gamma(z)$ intersects the ε -neighborhood of the origin. Furthermore, for any given point $z \in \mathbb{H}$, the distance between z and γ is μ -almost always positive. This implies that for any given finite family of points z_1, \dots, z_n in \mathbb{H} , the measure μ restricted to the set $\mathcal{A} = \mathcal{A}(z_1, \dots, z_n)$ of loops that surrounds at least one of these points is the limit when $\varepsilon \rightarrow 0$ of $u(\varepsilon)^{-1}$ times the (sum of) of the laws of loops in \mathcal{A} that intersect the ε -neighborhood of the origin.

Suppose now that $\mu(\{\gamma : R(\gamma) \geq 1\}) = \infty$. This implies clearly that for each $M > 1$, one can find a finite set of points z_1, \dots, z_n at distance greater than one of the origin such that $\mu(\mathcal{A}(z_1, \dots, z_n)) > M$. Hence, it follows that when ε is small enough, at each exploration step, the probability to discover a loop in \mathcal{A} is at least M times bigger than $u(\varepsilon)$. The

number of exploration steps before N at which this happens is therefore geometric with a mean at least equal to M . It follows readily that with probability at least c_0 (for some universal positive c_0 that does not depend on ε), this happens at least $M/4$ times.

Note that the harmonic measure in \mathbb{H} at i of a loop of radius at least 1 that intersects also $C_{1/2}$ is bounded from below by some universal positive constant c_1 . If at some step $j \leq N$, the radius of $\mathbb{H} \setminus (\varphi_j^\varepsilon)^{-1}(\mathbb{H})$ is greater than 1, then it means that there is a loop in the CLE in \mathbb{H} that one explores at the j -th step that has a radius at least 1 and that intersects $C_{1/2}$. Its preimage under $\varphi_{j-1}^\varepsilon \circ \dots \circ \varphi_1^\varepsilon$ (which is a loop of the original CLE that one is discovering) has therefore also has a harmonic measure (in \mathbb{H} and at i) that is bounded from below by c_1 . Hence, we conclude that with probability at least c_0 , the original CLE has at least $M/4$ different loops such that their harmonic measure seen from i in \mathbb{H} is bounded from below by some universal constant c_1 .

This statement holds for all M , so that with probability at least c_0 , there are infinitely many loops in the CLE such that their harmonic measure seen from i in \mathbb{H} is bounded from below by c_1 .

On the other hand, we know that $\gamma(i)$ is almost surely at positive distance from i , and this implies that for some positive α , the probability that some loop in the CLE is a distance less than α of i is smaller than $c_0/2$. Hence, with probability at least $c_0/2$, the CLE contains infinitely many loops that are all at distance at least α from i and all have harmonic measure at least c_1 . A similar statement is therefore true for the CLE in the unit disc if one maps i onto the origin. It is then easy to check that the previous statement contradicts the local finiteness (because the diameter of the conformal image of all these loops is bounded from below). Hence, the μ -mass of the set of pinned loops that reach the unit circle is indeed finite. \square

Let us now list various consequences of Lemma 4.4:

- For all $r > 0$, let us define $\mathcal{A}_r := \{\gamma : R(\gamma) > r\}$. Because of scaling, we know that for all $r > 0$, $\mu(\mathcal{A}_r) = r^{-\beta} \mu(\mathcal{A}_1)$. Clearly, this cannot be a constant finite function of r ; this implies that $\beta > 0$. Also, we get that for each fixed r , $\mu(R(\gamma) = r) = 0$.
- We can now define the function $v(\varepsilon)$ as the probability that in the CLE, there exists a loop that intersects C_ε and C_1 . We know that

$$\lim_{\varepsilon \rightarrow 0^+} \frac{v(\varepsilon)}{u(\varepsilon)} = \mu(R(\gamma) \geq 1) \quad (1)$$

(because $\mu(R(\gamma) = 1) = 0$). Hence, it follows that for any $\delta < 1$, $v(\delta\varepsilon)/v(\varepsilon) \rightarrow \delta^\beta$ as $\varepsilon \rightarrow 0$. This will be useful later on.

- We can rephrase in a slightly more general way our description of μ in terms of limits of CLE loops. Note that $\mathcal{A}_r = \cup_n \mathcal{A}(z_1, \dots, z_n)$, where $(z_n, n \geq 1)$ is some given dense sequence on $\{z : |z| = r\}$.

For each simple loop configuration Γ , and for each ε , let us define $\tilde{\gamma}(\varepsilon)$ to be the loop in the configuration Γ that intersects the disc of radius ε and with largest radius (in case there are ties, take any deterministic definition to choose one). We know from (1)

that the probability that $R(\tilde{\gamma}(\varepsilon)) > r$ decays like $u(\varepsilon) \times r^{-\beta} \mu(\mathcal{A}_1)$ as $\varepsilon \rightarrow 0$ (for each fixed $r > 0$). Furthermore, recall that the probability that there exist two different loops of radius greater than r that intersect the circle C_ε decays like $o(u(\varepsilon))$ as $\varepsilon \rightarrow 0$. Hence, for each n , the measure μ restricted to $\mathcal{A}(z_1, \dots, z_n)$ is the limit when $\varepsilon \rightarrow 0$ of $u(\varepsilon)^{-1}$ times the law of $\tilde{\gamma}(\varepsilon)$, restricted to the event that it surrounds at least one of the points z_1, \dots, z_n .

We conclude that the measure μ restricted to \mathcal{A}_r can be viewed as the weak limit when $\varepsilon \rightarrow 0$ of $u(\varepsilon)^{-1}$ times the law of $\tilde{\gamma}(\varepsilon)$ restricted to \mathcal{A}_r . In other words, if we consider the set of pinned loops of strictly positive size (i.e., the loop of zero length is not in this set) endowed with the Hausdorff metric, we can say that μ is the vague limit of $u(\varepsilon)^{-1}$ times the law of $\tilde{\gamma}(\varepsilon)$.

Let us finally state another consequence of this result, that will turn out to be useful in [33]: Consider a CLE in \mathbb{H} and let us consider the set of loops that intersect the unit circle. Define \mathcal{R} to be the radius of the smallest disc centered at the origin that contains all these loops. Note that scaling shows that $P(\mathcal{R} > x) = v(1/x)$ for $x \geq 1$.

Corollary 4.5 (to be used in [33]). *If $\beta > 1$, then $E(\mathcal{R}^{(1+\beta)/2}) < \infty$.*

Proof. Just note that

$$\begin{aligned} E(\mathcal{R}^{(1+\beta)/2}) &= \int_0^\infty dr P(\mathcal{R}^{(1+\beta)/2} \geq r) \\ &\leq 1 + \int_1^\infty dr v(r^{-2/(1+\beta)}) \\ &\leq 1 + \int_1^\infty \frac{dr}{r^{2\beta/(1+\beta)+o(1)}} < \infty \end{aligned}$$

because $2\beta > 1 + \beta$. □

With the $8/\kappa = 1 + \beta$ identification that we will derive later, $\beta > 1$ corresponds to $\kappa < 4$ and then $(1 + \beta)/2 = 4/\kappa$.

The next proposition corresponds to the fact that α -stable subordinators exist only for $\alpha \in (0, 1)$.

Proposition 4.6. *The scaling exponent β described above lies in $(0, 2)$.*

Proof. We use the radial exploration mechanism again. Let us now assume that $\beta \geq 2$ and focus on the contribution of the “small” loops that one discovers before actually discovering $\gamma(i)$.

Let $\mathcal{A}_1, \dots, \mathcal{A}_k$ be k fixed disjoint (measurable) sets of loops that do not surround i , with $a_l = \mu(\mathcal{A}_l) < \infty$. We suppose that all \mathcal{A}_l 's for $l \leq k$ belong to the algebra of events generated by the events of the type $\{\gamma : \gamma \text{ surrounds } z\}$. We let $N_\varepsilon(\mathcal{A}_l)$ denote the number of loops in \mathcal{A}_l that one has discovered in this way before one actually discovers the loop that surrounds i . Our previous results show that when $\varepsilon \rightarrow 0$, the joint law of $N_\varepsilon(\mathcal{A}_1), \dots, N_\varepsilon(\mathcal{A}_k)$ converges to that of the N_1, \dots, N_k that we described at the end of the previous subsection.

For each integer j , we define \mathcal{A}_j to be the set of loops that surround $2^{-j}i$ but that do not surround any point $2^k i$ for $k > -j$. The scaling property of μ implies that for all j , $\mu(\mathcal{A}_j) = 2^{j\beta} \mu(\mathcal{A}_0)$ and it is easy to check that $\mu(\mathcal{A}_0) > 0$ (because the loops that surround i have a finite radius so that $\sum_{j \leq 0} \mu(\mathcal{A}_j) \geq 1 > 0$). Hence, for all positive j ,

$$\mu(\mathcal{A}_j) \geq 4^j \mu(\mathcal{A}_0).$$

Recall that if ψ is a conformal map in \mathcal{S} from a simply connected subset H of \mathbb{H} that does contain i but not $2^{-j_0}i$ for some $j_0 \geq 1$, then

$$a(\psi) \geq C' 4^{-j_0}.$$

Furthermore, for each fixed j_0 , when ε is small enough, we can compare the number of loops in $\mathcal{A}_1, \dots, \mathcal{A}_{j_0}$ that have been discovered before $\gamma(i)$ via the chordal exploration mechanism with i.i.d. Poisson random variables N_1, \dots, N_{j_0} . Note also that when one composes conformal maps in \mathcal{S} , the derivatives at i get multiplied and the a 's therefore add up.

Hence, it follows immediately that if $\beta \geq 2$, then for each j_0 , with a probability that is bounded from below independently of j_0 , when ε is small enough,

$$a(\varphi_1 \circ \dots \circ \varphi_N) \geq \frac{C'}{2} \sum_{j=1}^{j_0} N_j 4^j.$$

Hence, we conclude that there exists $c_2 > 0$ such that for each $M > 0$, if one chooses ε small enough, the probability that $a(\varphi_1 \circ \dots \circ \varphi_N) \geq M$ is at least c_2 . But this contradicts that fact that $\gamma(i)$ is at positive distance from i (for instance using Koebe's 1/4 Theorem). Hence, we conclude that β is indeed smaller than 2. \square

5 The two-point pinned probability measure

5.1 Restriction property of the pinned measure

We now investigate what sort of “restriction-type” property the pinned measure μ inherits from the CLE. Note that μ is an infinite measure on single pinned loops (rather than a probability measure on loop configurations), so the statement will necessarily be a bit different from the restriction property of CLE.

Suppose now that A is a closed bounded set such that $\mathbb{H} \setminus A$ is simply connected, and that $d(0, A) > 0$. Our goal is to find an alternative description of the infinite measure μ restricted to the set of loops γ that do not intersect A .

Suppose that a deterministic pinned (at zero) loop γ (in the upper half-plane) is given. Sample a CLE $\Gamma^\#$ in the upper half-plane. This defines a random $H^\#$ which is the connected component that has the origin on its boundary of the set obtained by removing from $\mathbb{H} \setminus A$ all loops of $\Gamma^\#$ that intersect A . Then, we define a conformal map $\psi^\#$ from \mathbb{H} onto $H^\#$ such that

$$\psi^\#(0) = 0 \text{ and } (\psi^\#)'(0) = 1.$$

In order to fix $\psi^\#$, another normalization is needed. We can for instance take $\psi^\#(\infty) = \infty$, but all of what follows would still hold if one replaced $\psi^\#$ by the map $G^\#$ such that $G^\#(z) =$

$z + o(z^2)$ as $z \rightarrow 0$ (we will in fact also use this map in the coming sections). Finally, we define $\gamma^\# = \psi^\#(\gamma)$. Clearly, this is a pinned loop that stays in $H^\#$ and therefore avoids A almost surely.

Suppose now that we use the product measure $\mu \otimes P$ on pairs $(\gamma, \Gamma^\#)$ (where P is the law of the same CLE that was used to define the pinned measure μ). For each pair $(\gamma, \Gamma^\#)$ we define the loop $\gamma^\# = \gamma^\#(\gamma, \Gamma^\#) = \psi^\#(\gamma)$ as before, and we define μ_A to be the image measure of $\mu \otimes P$ via this map. This μ_A is an infinite measure on the set of loops that do not intersect A .

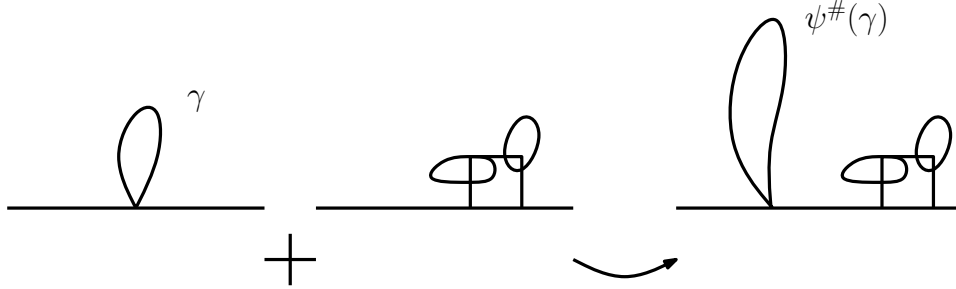

Figure 12: Construction of μ_A (sketch)

We are now ready to state the pinned measure’s restriction property:

Proposition 5.1 (Restriction property of μ). *The measure μ restricted to the set $\{\gamma \cap A = \emptyset\}$ is equal to μ_A .*

Recall that we constructed the pinned measure by “exploring” a CLE until we hit γ_0 . If we started with a pinned measure — together with a CLE in the complement of the pinned loop — we might wish to “explore” until we hit the pinned loop as a way of constructing a natural measure on loops pinned at two points. We will essentially carry out such a procedure later on, and the above proposition will be relevant.

Proof. Let us now consider the set A and a CLE $\Gamma^\#$, and define $H^\#$ and the map $\psi^\#$ as before. For each ε , the event that no loop in $\Gamma^\#$ intersects both C_ε and A is identical to the event that $C_\varepsilon \subset H^\#$. Let us now condition on the set $H^\#$ (for a configuration where $C_\varepsilon \subset H^\#$); the restriction property of the CLE tells us that the conditional law of the CLE-loops that stay in $H^\#$ is exactly that of an “independent CLE” defined in this random set $H^\#$. Hence, we get an identity between the following two measures:

- The law of $\tilde{\gamma}(\varepsilon)$ in the CLE (the loop with largest radius that intersects C_ε), restricted to the event that no loop in the CLE intersects both C_ε and A .
- Sample first a CLE $\Gamma^\#$, define $H^\#$, restrict ourselves to the event where $C_\varepsilon \subset H^\#$, define $\psi^\#$, consider an independent CLE $\tilde{\Gamma}$ in the upper half-plane and its image $\psi^\#(\tilde{\Gamma})$, and look at the law of the loop with largest radius in this family that intersects C_ε .

Note that the total mass of these two measures is the probability that no loop in the CLE intersects both C_ε and A .

Now, we consider the vague limits when $\varepsilon \rightarrow 0$ of $1/u(\varepsilon)$ times these two measures. It follows readily from our previous considerations that:

- For the first construction, the limit is just μ restricted to the set of pinned loops that do not hit A .
- For the second construction, the limit is just μ_A (recall that $\psi^\#$ has been chosen in such a way that $(\psi^\#)'(0) = 1$, so that when ε is small $\psi^\#(C_\varepsilon)$ is very close to C_ε).

□

In fact, it will be useful to upgrade the previous result to the space of “pinned configurations”: We say that $(\bar{\gamma}, \bar{\Gamma})$ is a *pinned configuration* if $\bar{\gamma}$ is a pinned loop in the upper half-plane and if $\bar{\Gamma}$ is a loop-configuration in the unbounded connected component of $\mathbb{H} \setminus \bar{\gamma}$.

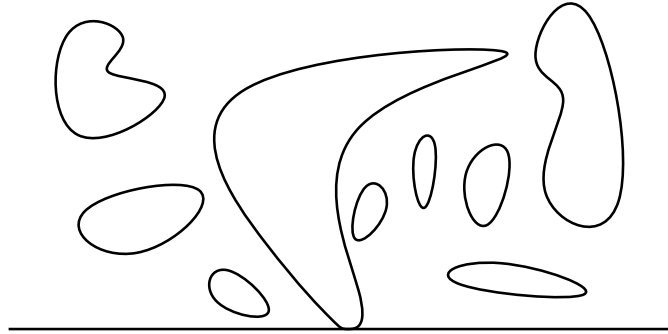

Figure 13: A pinned configuration (sketch)

Let us define a first natural measure on the space of pinned configurations. Suppose that one is given a pinned loop γ and a loop-configuration Γ (that is not necessarily disjoint from γ). Define H_γ the unbounded connected component of the complement of γ , and ϕ_γ the conformal map from \mathbb{H} onto H_γ that is normalized at infinity ($\phi_\gamma(z) = z + o(1)$). Then $(\bar{\gamma}, \bar{\Gamma}) = (\gamma, \phi_\gamma(\Gamma))$ is clearly a pinned loop configuration. We now let $\bar{\mu}$ denote the image of the product measure $\mu \otimes P$ under this map $(\gamma, \Gamma) \mapsto (\bar{\gamma}, \bar{\Gamma})$. We call it the pinned CLE configuration measure. Clearly, the marginal measure of $\bar{\gamma}$ (under $\bar{\mu}$) is μ (because P is a probability measure and $\bar{\gamma} = \gamma$).

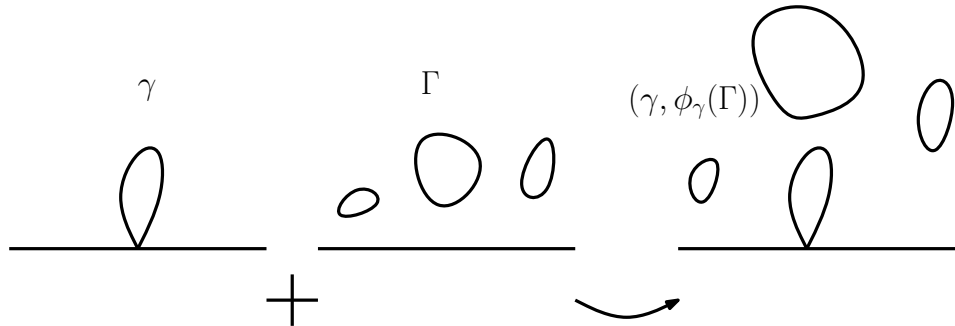

Figure 14: Construction of $(\bar{\gamma}, \bar{\Gamma})$ (sketch)

Suppose now that A is a set as before. If $(\bar{\gamma}, \bar{\Gamma})$ is a pinned configuration, then we define:

- $\tilde{\Gamma}_A$ to be the set of loops of $\bar{\Gamma}$ that intersect A .
- \bar{H}_A to be the unbounded connected component of $\mathbb{H} \setminus (\tilde{\Gamma}_A \cup A)$
- $\bar{\Gamma}_A$ to be the set of loops of $\bar{\Gamma}$ that stay in \bar{H}_A .

Hence, when $\bar{\gamma} \cap A = \emptyset$, we define a triplet $(\bar{\gamma}, \bar{\Gamma}_A, \tilde{\Gamma}_A)$. Let $\bar{\mu}_A$ denote the image of $\bar{\mu}$ (restricted to the set $\bar{\gamma} \cap A = \emptyset$) under this transformation.

We now construct another measure that will turn out to be identical to $\bar{\mu}_A$: Start on the one hand with a pinned measure configuration $(\bar{\gamma}, \bar{\Gamma})$ and on the other hand with a loop-configuration in \mathbb{H} that we denote by $\Gamma^\#$. We define $\psi^\#$ as before (using A and $\Gamma^\#$). We also let $\Gamma_A^\#$ denote the loops in $\Gamma^\#$ that intersect A . Then we consider the triplet $(\psi^\#(\bar{\gamma}), \psi^\#(\bar{\Gamma}), \Gamma_A^\#)$. This triplet is a function of $((\bar{\gamma}, \bar{\Gamma}), \Gamma^\#)$. We now define $\mu_A^\#$ to be the image of the product measure $\bar{\mu} \otimes P$ under this mapping.

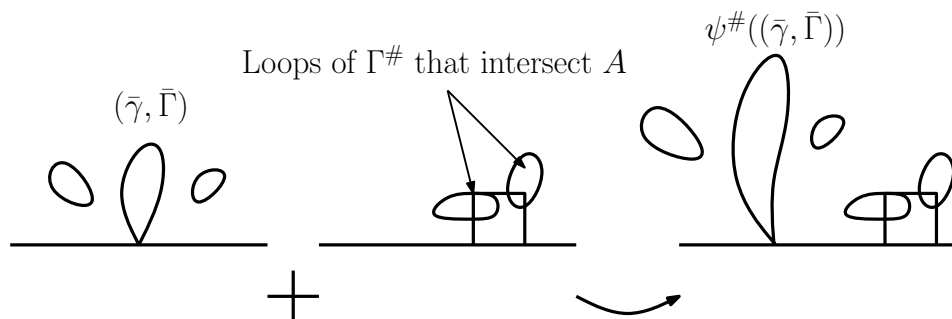

Figure 15: The measure $\mu_A^\#$ (sketch)

Proposition 5.2 (Restriction property for pinned configurations). *The two measures $\bar{\mu}_A$ and $\mu_A^\#$ are identical.*

If we consider the marginal measures on the pinned loops of $\bar{\mu}_A$ and $\mu_A^\#$, we recover Proposition 5.1. The proof is basically identical to that of Proposition 5.1: One just needs also to keep track of the remaining loops, and this is done on the one hand thanks to the CLE’s restriction property, and on the other hand (in the limiting procedure) thanks to the fact that loops are disjoint and at positive distance from the origin. In order to control the $\varepsilon \rightarrow 0$ limiting procedure applied to loop configurations, one can first derive the result for the law of finitely many loops in the loop configuration (for instance those that surround some given point).

5.2 Chordal explorations

As in the case of the CLE, we are going to progressively explore a pinned configuration, cutting out recursively small (images of) semi-circles, and trying to make use of the pinned measure’s restriction property in order to define a “two-point pinned measure”. However, some caution will be needed in handling ideas involving independence because $\bar{\mu}$ is not a probability measure.

Recall that $\bar{\mu}$ is a measure on configurations in a simply connected domain with one special marked boundary point (i.e., the origin, where the pinned loop touches the boundary of the domain). It will therefore be natural to work with chordal ε -admissible explorations instead of radial ones. This will be very similar to the radial case, but we will nonetheless describe in detail here:

It is convenient to first consider the domain to be the upper half-plane and to take ∞ as the marked boundary point instead of the origin. Suppose that Γ is a loop configuration (with no pinned loop) in the upper half-plane \mathbb{H} and choose some bounded closed simply connected set $A \subset \overline{\mathbb{H}}$ such that

1. $\mathbb{H} \setminus A$ is simply connected,
2. A is the closure of the interior of A ,
3. the interior of A is connected, and
4. the length of $\partial A \cap \partial\mathbb{H}$ is positive.

Suppose furthermore that all γ_j 's in Γ that intersect ∂A also intersect the interior of A .

Here, when $x \in \mathbb{R}$, $D(x, \varepsilon)$ will denote the set of points in \mathbb{H} that are at distance less than ε from x . We choose some x_1 on the real line, such that $D(x_1, \varepsilon) \subset A$. Then, we define the set H_1 to be the unbounded connected component of the set obtained when removing from $\mathbb{H} \setminus D(x_1, \varepsilon)$ all loops of Γ that intersect $D(x_1, \varepsilon)$. We also define the conformal map g_1 from H_1 onto \mathbb{H} that is normalized at infinity ($g_1(z) = z + o(1)$ as $z \rightarrow \infty$), and we let $A_2 = g_1(H_1 \cap A)$.

Then, we proceed inductively: For each $n \geq 1$, we choose (when it is possible) x_{n+1} on the real line such that $D(x_n, \varepsilon) \subset A_n$. Then we consider the set H_{n+1} to be the unbounded connected component of the set obtained when removing from $\mathbb{H} \setminus D(x_n, \varepsilon)$ all loops of $g_n \circ \dots \circ g_1(\Gamma)$ that intersect $D(x_n, \varepsilon)$. We also define the conformal map g_{n+1} from H_{n+1} onto \mathbb{H} that is normalized at infinity ($g_{n+1}(z) = z + o(1)$ as $z \rightarrow \infty$), and we let $A_{n+1} = g_{n+1}(H_{n+1} \cap A_n)$.

This procedure necessarily has to stop at some step N , i.e., at this step N , it is not possible to find a point x such that $D(x, \varepsilon) \subset H_N$. This is just because of additivity of the half-plane capacity under composition of the conformal maps (and because the half-plane capacity of A is finite). We say that such an exploration is an ε -admissible (chordal) exploration of (Γ, A) rooted at infinity. The results of Subsection 3.2 and their proofs can be immediately adapted to the present setting. It is for instance easy to check that for any given Γ , for any given loop γ_j in Γ that intersects such a given A , there exists a positive $\varepsilon_0 = \varepsilon_0(\Gamma, A, \gamma_j)$ such that any ε -admissible chordal exploration of (Γ, A) necessarily discovers the loop γ_j as soon as $\varepsilon \leq \varepsilon_0$. Hence, after the last step N of this ε -exploration of (Γ, A) , for all positive α , when ε is chosen to be sufficiently small, one has necessarily discovered all loops of diameter greater than α of Γ that intersect A .

Let us now suppose that Γ is a loop configuration and A is a set satisfying the same conditions as before, except that we also assume that it is at positive distance of the origin. We can now define chordal ε -explorations of (Γ, A) that are rooted at 0: These are just the image under $z \mapsto -1/z$ of the previous explorations of $(-1/\Gamma, -1/A)$, where $-1/\Gamma$

denotes the loop configuration obtained when one considers the loops $(-1/\gamma_j)$. The difference between the exploration rooted at the origin and the exploration rooted at infinity in fact only lies in what we call $D(x, \varepsilon)$, and how one renormalizes the conformal maps g_n at each step. In the exploration rooted at the origin, $D(x, \varepsilon)$ would have to be replaced by the conformal image of $D(x, \varepsilon)$ under the conformal mapping from \mathbb{H} onto \mathbb{H} that fixes x , has derivative 1 at x and maps ∞ onto 0, and the conformal map g_n^{-1} would have to be replaced by the conformal map G_n from \mathbb{H} onto H_n such that $G_n(z) = z + o(z^2)$ when $z \rightarrow 0$.

Let us describe more precisely an iteration step in this case: Let us define, for each $x \in \mathbb{R} \setminus \{0\}$ and each small ε , $C_\varepsilon(x)$ to be the image of C_ε under the Moebius transformation $I_x : z \mapsto -x/(xz - 1)$ of \mathbb{H} that maps 0 onto x and ∞ onto 0. Note that for all x and y in $\mathbb{R} \setminus \{0\}$, $I_x \circ I_y^{-1}(z) \sim z$ when $z \rightarrow 0$ and that $I_x \circ I_y^{-1}(C_\varepsilon(y)) = C_\varepsilon(x)$. When ε is very small, $C_\varepsilon(x)$ is very close to the semi-circle of radius $x^2\varepsilon$ around x (i.e., it is squeezed between to semi-circles of radii close to $x^2\varepsilon$) because $I_x'(0) = x^2$.

Suppose that H_n, G_n are already defined. The choice of x_n is then said to be ε -admissible if $C_\varepsilon(x_n) \subset G_n^{-1}(H_n \cap A)$. We then define H_{n+1} to be the unbounded connected component the domain by removing from $H_n \setminus G_n(C_\varepsilon(x_n))$ all the loops that intersect $G_n(C_\varepsilon(x_n))$.

Clearly, after the last step N of this exploration rooted at the origin (when no ε -admissible point can be found), we again have a set H_N that is in some sense close to H (which is the unbounded connected component of the domain obtained when removing from $\mathbb{H} \setminus A$ all loops that intersect A). One way to make this more precise is to use the Carathéodory topology “seen from the origin”. Even if the origin is a boundary point of the simply connected domains H_N and H , we can symmetrize these domains (by considering their union with their symmetric sets with respect to the real axis), and therefore view the conformal maps G_N and G as conformal maps normalized at the origin, which is now an inner point of the domain. We will implicitly use this topology for domains in the upper half-plane “viewed from the origin”. Then, just as in Subsection 3.2, we get that (for each given Γ and A) H_N converges to H , when $\varepsilon \rightarrow 0$, uniformly with respect to all possible ε -admissible explorations.

5.3 Definition of the two-point pinned measure

We know that the μ -mass of the set of pinned loops that intersect the segment $[1, 1 + i]$ is positive and finite. By scaling, we can choose a in such a way that the μ -mass of the set of pinned loops that intersect $[a, a(1 + i)]$ is equal to 1. On this set of configurations, μ can therefore be viewed as a probability measure. Similarly, the pinned configuration measure $\bar{\mu}$ restricted to the set

$$\mathcal{A} = \mathcal{A}([a, a + ia]) = \{(\bar{\gamma}, \bar{\Gamma}) : \bar{\gamma} \cap [a, a + ia] \neq \emptyset\}$$

is a probability measure that we will denote by $\tilde{P}_{[a, a+ia]}$.

Let us now consider a pinned configuration $(\bar{\gamma}, \bar{\Gamma})$ in \mathcal{A} . Define $u = \min\{y : a + iy \in \bar{\gamma}\}$ so that $a + iu$ is the lowest point of $\bar{\gamma} \cap [a, a + ia]$. Let ψ denote the conformal map from the unbounded connected component H_ψ of the set obtained by removing from $\mathbb{H} \setminus [0, a + iu]$ all the loops of $\bar{\Gamma}$ that intersect this segment back onto \mathbb{H} , normalized by $\psi(0) = 0$, $\psi'(0) = 1$ and $\psi(a + iu) = 1$. We then define \tilde{P} to be the distribution of $\tilde{\gamma} = \psi(\bar{\gamma})$, i.e. the image of the probability measure $\bar{\mu}(\cdot \cap \mathcal{A})$ under this transformation $(\bar{\gamma}, \bar{\Gamma}) \mapsto \psi(\bar{\gamma})$. A by-product of the coming arguments will be that in fact:

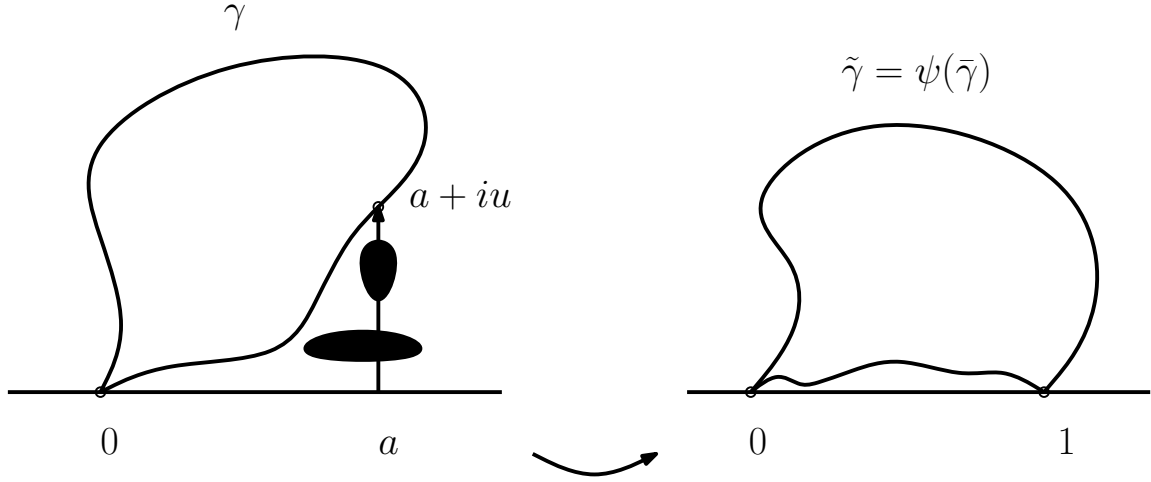

Figure 16: The construction of of the two-point pinned loop (sketch)

Proposition 5.3. *Under $\tilde{P}_{[a, a+ia]}$, the loop $\tilde{\gamma}$ is independent of ψ .*

Define on the other hand the probability measure \tilde{P}_ε to be the measure μ restricted to the set of pinned loops that intersect $C_\varepsilon(1)$, and renormalized in order to be a probability measure. The main first goal of this subsection is to derive the following proposition (which we will later prove together with Proposition 5.3):

Proposition 5.4 (Definition of the two-point pinned measure \tilde{P}). *As $\varepsilon \rightarrow 0$, \tilde{P}_ε converges to \tilde{P} .*

As we have already indicated, the basic idea of the proof will be similar in spirit with the construction of the pinned measure itself: We will use discrete explorations of pinned configurations, and use the pinned measure’s restriction property in order to deduce some independence property between the already discovered loops and the yet-to-be-discovered ones along the exploration; this will enable us to conclude.

Suppose now that A is a set that is at positive distance from the origin, and that satisfies the conditions 1-4 described in the previous subsection. Clearly, if we define

$$\bar{\mathcal{A}}(A) = \{(\bar{\gamma}, \bar{\Gamma}) : \bar{\gamma} \cap A \neq \emptyset\},$$

then $\bar{\mu}(\bar{\mathcal{A}}(A))$ is finite and positive. We can therefore define \tilde{P}_A to be $\bar{\mu}$ restricted to this set, and renormalized in order to be a probability measure.

Suppose now that $H \subset \mathbb{H}$ is a simply connected domain with $d(0, \mathbb{H} \setminus H) > 0$. Define ϕ to be the conformal map from H onto \mathbb{H} such that $\phi(z) = z + o(z^2)$ when $z \rightarrow 0$, and suppose that $C \subset H$ is a set such that $A := \phi(C)$ satisfies the same conditions as before. We then define \tilde{P}_C^H to be the image of \tilde{P}_A under ϕ^{-1} . Basically, \tilde{P}_C^H is the “law” of a pinned configuration in H rooted at the origin and “conditioned” on the event that the pinned loop intersects C .

Suppose now that B is another set at positive distance of the origin that satisfies the four conditions described in the previous subsection and such that $A \subset B$. We are now

going to define, for each such B and A , the measure $\bar{\mu}_{B,A}$ to be the measure $\bar{\mu}$ on pinned configurations $(\bar{\gamma}, \bar{\Gamma})$, restricted to the set $\bar{\mathcal{A}}(B, A) = \bar{\mathcal{A}}(B) \setminus \bar{\mathcal{A}}(A)$ of configurations such that $\bar{\gamma}$ intersects B but not A . When $\bar{\mu}(\bar{\mathcal{A}}(B)) > \bar{\mu}(\bar{\mathcal{A}}(A))$, we then define $\tilde{P}_{B,A}$ to be $\bar{\mu}_{B,A}$ normalized to be a probability measure.

Finally, when we are given $\bar{\Gamma}$ and A , we can define the set \bar{H}_A as before (i.e., the unbounded connected component of the set obtained by removing from $\mathbb{H} \setminus A$ all the loops of $\bar{\Gamma}$ that intersect A). Then, it follows immediately from the pinned measure's restriction property (Proposition 5.2) that:

Corollary 5.5. *Suppose that $(\bar{\gamma}, \bar{\Gamma})$ is sampled according to $\tilde{P}_{B,A}$. Then the conditional law of $\bar{\gamma}$ given $\bar{\Gamma}_A$ (i.e., the loops of $\bar{\Gamma}$ that intersect A) is $\tilde{P}_{B \cap H}^H$ where $H = \bar{H}_A$.*

Suppose now that we are given a configuration $(\bar{\gamma}, \bar{\Gamma})$ that is sampled according to \tilde{P}_A . For each given ε , we can perform a ‘‘Markovian’’ ε -admissible exploration as before (Markovian can simply mean here that we have chosen some deterministic procedure to choose each x_n). When $\bar{\gamma}$ intersects A , this exploration procedure can discover $\bar{\gamma}$ at some (random) step that we call $\bar{N} + 1$, and we know that when $\varepsilon \rightarrow 0$, the probability that \bar{N} exists tends to 1.

Corollary 5.5 shows that conditionally on $\bar{N} = n$, on H_n and on x_n , the law of $\bar{\gamma}$ is $\tilde{P}_{G_n(C_\varepsilon(x_n))}^{H_n}$. This implies in particular that the conditional law of $I_1 \circ I_{x_{\bar{N}}}^{-1} \circ G_{\bar{N}}^{-1}(\bar{\gamma})$ is \tilde{P}_ε (recall that $\psi_{\bar{N}} := I_1 \circ I_{x_{\bar{N}}}^{-1} \circ G_{\bar{N}}^{-1}$ is just the conformal map from $H_{\bar{N}}$ onto \mathbb{H} that maps the origin onto itself, has derivative at the origin equal to 1, and that maps $G_{\bar{N}}(x_{\bar{N}})$ onto 1). Hence (on the event $\bar{N} < \infty$), $\psi_{\bar{N}}(\bar{\gamma})$ is in fact independent of \bar{N} and of $H_{\bar{N}}$.

It is worth stressing at this point that the law of \bar{N} is not geometric as in the CLE case, and that the iteration steps are not i.i.d. anymore, but this will not prevent us from now proving Propositions 5.4 and 5.3:

Proof. The arguments are again close in spirit to the definition of the pinned measure itself. Suppose that K is a large integer, that $\delta = 1/K$, and consider the rectangles $A_{\delta,k} = [a - \delta/2, a + \delta/2] \times [0, ak\delta]$ for $k = 1, \dots, K$. Note that because of scale-invariance and translation invariance, for each given δ , up to a set of configurations of zero measure, all the loops of $(\bar{\gamma}, \bar{\Gamma})$ that intersect some $A_{\delta,k}$ also intersect its interior (when δ is fixed). Furthermore, the probability measure $\tilde{P}_{A_{\delta,K}}$ converges to $\tilde{P}_{[a, a(1+i)]}$.

For each fixed $\delta = 1/K$, we can start to explore each $(\bar{\Gamma} \cup \{\bar{\gamma}\}, A_{\delta,1})$ by a Markovian chordal ε -admissible exploration rooted at 0, then continue exploring $(\bar{\Gamma} \cup \{\bar{\gamma}\}, A_{\delta,2})$ and so on until we either complete a chordal ε -admissible exploration of $A_{\delta,K} = [a - \delta, a + \delta] \times [0, a]$, or we have discovered $\bar{\gamma}$. When $(\bar{\gamma}, \bar{\Gamma})$ is sampled according to \tilde{P} , the probability to discover $\bar{\gamma}$ is going to 1 as $\varepsilon \rightarrow 0+$. Let us call (as before) $\bar{N} + 1$ the (random) step at which $\bar{\gamma}$ is discovered.

Furthermore, for each given δ , it is possible to choose ε small enough, so that the probability that the exploration processes misses no loop of $\bar{\Gamma}$ of diameter greater than 4δ that intersects $[a, a + ia]$ is as close to 1 as we want.

The very same arguments as in the proof of Proposition 3.4 then show that if $\varepsilon(\delta)$ is chosen to be sufficiently small, then the set $H_{\bar{N}}$ converges to H_ψ almost surely, and that $\psi_{\bar{N}}$ converges almost surely to ψ . We then conclude using the independence between $\psi_{\bar{N}}$ and $\psi_{\bar{N}}(\bar{\gamma})$. We safely leave the details to the reader. \square

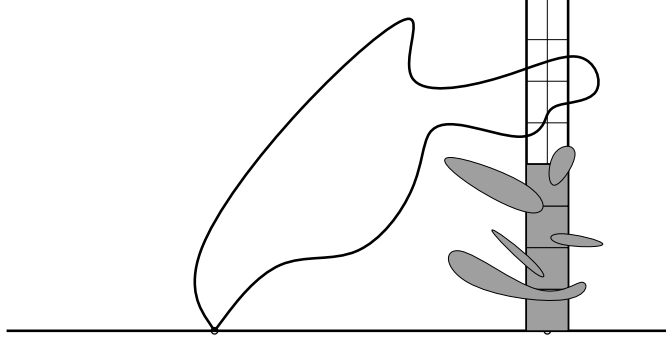

Figure 17: Exploration of the thin rectangle (sketch)

A consequence of Proposition 5.4 is that the probability measure \tilde{P} is invariant under all Moebius transformations of \mathbb{H} onto itself that have 0 and 1 as fixed points. This follows immediately from the conformal covariance property of μ and the description of \tilde{P} as limits of \tilde{P}_ε given in the proposition.

In fact, our proof of Proposition 5.4 works also if we replace the straight segment $[a, a(1+i)]$ by any given other piecewise linear path starting at 1 such that the μ mass of the set of pinned loops that it intersects is finite (we can then just multiply μ by a constant to turn it into a probability measure on this set): Suppose that η is some finite piecewise linear path that starts on the real line, has no double points, and such that all of its segments are horizontal or vertical. We parametrize it “from the real axis to the tip”.

For each pinned configuration $(\tilde{\gamma}, \tilde{\Gamma})$ such that $\tilde{\gamma} \cap \eta \neq \emptyset$, we can define the first meeting time T of η with $\tilde{\gamma}$, i.e. $T = \min\{t : \eta(t) \in \tilde{\gamma}\}$. Let us now consider $\tilde{\Gamma}_\eta$ to be the set of loops of $\tilde{\Gamma}$ that intersect $\eta[0, T]$, and let ψ denote the conformal map as before (that maps the set obtained by removing from $\mathbb{H} \setminus \eta[0, T]$ all the loops of $\tilde{\Gamma}$ that intersect $\eta[0, T]$ back onto \mathbb{H} , normalized by $\psi(0) = 0$, $\psi'(0) = 1$ and $\psi(\eta(T)) = 1$). Note that $\psi(\tilde{\gamma})$ is a pinned loop (the map ψ is smooth near the origin). Note also that $\bar{\mu}(\tilde{\gamma} \cap \eta \neq \emptyset)$ is positive and finite. Then:

Proposition 5.6. *If we consider the measure $\bar{\mu}$ on the event $\{\tilde{\gamma} \cap \eta \neq \emptyset\}$ and if we renormalize it to be a probability measure, then under this probability measure, $\tilde{\gamma} = \psi(\tilde{\gamma})$ is distributed according to the two-point pinned distribution \tilde{P} . Furthermore, $\tilde{\gamma}$ is independent of the conformal map ψ .*

5.4 Independence-property of two-point pinned loops

We are now going to derive the key independence property of the two-point pinned measure. Suppose that $\tilde{\gamma}$ is a two-point pinned loop in \mathbb{H} that touches the real line at 0 and 1. We can define two simple paths γ^* and γ_* from 0 to 1 in \mathbb{H} in such a way that their union is $\tilde{\gamma}$ and that γ_* is “below” γ^* . We now define ψ_* to be the conformal map from the unbounded connected component H_* of $\mathbb{H} \setminus \gamma_*$ onto \mathbb{H} that fixes the three boundary points 0, 1 and ∞ , and finally, we define $U(\tilde{\gamma}) = \psi_*(\gamma^*)$.

Proposition 5.7. *If $\tilde{\gamma}$ is chosen according to the two-point pinned measure \tilde{P} , then $U(\tilde{\gamma})$ and γ_* are independent.*

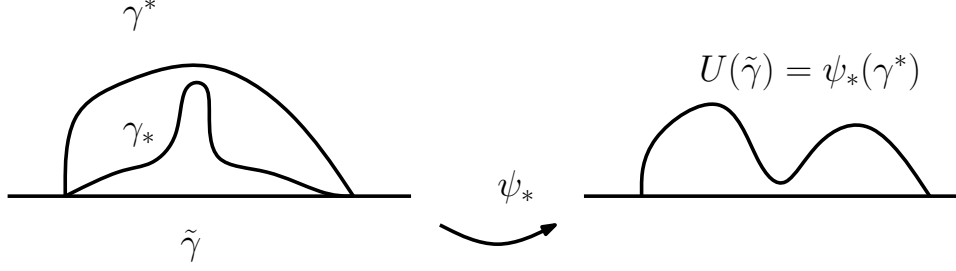

Figure 18: Construction of $U(\tilde{\gamma})$ (sketch)

Recall on the one hand that \tilde{P} is the limit of \tilde{P}_ε when $\varepsilon \rightarrow 0$. Let us now consider a hull $1 \subset \overline{\mathbb{H}}$ that is attached to the interval $(0, 1)$ that satisfies the conditions 1-4 as before. Let $B = A \cup C_\varepsilon(1)$ where ε is sufficiently small, so that $C_\varepsilon(1) \cap A = \emptyset$. Let us now describe the law of $\tilde{\gamma}$ conditioned to avoid A , trying to use Corollary 5.5. Remark first that it is the limit when $\varepsilon \rightarrow 0$ of the pinned measure “renormalized in order to be a probability” on the event $\mathcal{A}(B, A)$ i.e. on the event where γ intersects $C_\varepsilon(1)$ but not A .

But this measure can be described using Corollary 5.5, and we could use this to prove Proposition 5.7 directly. Let us however describe first the “explicit restriction-type-property” for the law \tilde{P} of the two-point pinned loop $\tilde{\gamma}$. Suppose that A is such that $A \cap \mathbb{R} \subset (0, 1)$, and that $\mathbb{H} \setminus A$ is simply connected. We would like describe the conditional law of $\tilde{\gamma}$ given that it does not intersect A .

In order to do so, let us use a CLE $\Gamma^\#$ that is independent of $\tilde{\gamma}$. We will use \tilde{E} , $E^\#$ and $\tilde{E}^\#$ to denote the expectation with respect to $\tilde{\gamma}$, to $\Gamma^\#$ and to both. We define $H^\#$, the unbounded connected component of the set obtained by removing from $\mathbb{H} \setminus A$ all the loops of $\Gamma^\#$ that intersect A . Then, we define the conformal map $\varphi_\#$ from $H^\#$ onto \mathbb{H} such that $\varphi_\#(0) = 0$, $\varphi_\#(1) = 1$ and $\varphi'_\#(1) = 1$. It is easy to check that $\varphi'_\#(0) \leq 1$. The loop $\varphi_\#^{-1}(\tilde{\gamma})$ is clearly two-point pinned loop that avoids A almost surely.

Proposition 5.8. *The conditional law of $\tilde{\gamma}$ given $\tilde{\gamma} \cap A = \emptyset$ satisfies, for a bounded continuous function F on the set of loops,*

$$\tilde{E}(F(\tilde{\gamma}) | \tilde{\gamma} \cap A = \emptyset) = \frac{\tilde{E}^\#(\varphi'_\#(0)^\beta F(\varphi_\#^{-1}(\tilde{\gamma})))}{E^\#((\varphi'_\#(0))^\beta)}.$$

Proof. Proposition 5.4 shows that

$$\tilde{E}(F(\tilde{\gamma}) | \tilde{\gamma} \cap A = \emptyset) = \lim_{\varepsilon \rightarrow 0} \frac{\mu(F(\gamma) 1_{\gamma \cap A = \emptyset} 1_{\gamma \cap C_\varepsilon(1) \neq \emptyset})}{\mu(1_{\gamma \cap A = \emptyset} 1_{\gamma \cap C_\varepsilon(1) \neq \emptyset})}.$$

The measure μ restricted to the set of loops that do not intersect A , is equal μ_A by Proposition 5.1. Recall that in order to define μ_A , we use another CLE $\Gamma^\#$, that we consider the set $H^\#$ and the conformal map $\psi^\#$ from \mathbb{H} onto $H^\#$ such that $\psi^\#(0) = 0$, $(\psi^\#)'(0) = 1$ and $\psi^\#(\infty) = \infty$, and that μ_A is the image of the product measure $\mu \otimes P$ under the mapping $(\gamma, \Gamma^\#) \mapsto \psi^\#(\gamma)$. Hence,

$$\tilde{E}(F(\tilde{\gamma}) | \tilde{\gamma} \cap A = \emptyset) = \lim_{\varepsilon \rightarrow 0} \frac{E^\#(\mu(F(\psi^\#(\gamma)) 1_{\psi^\#(\gamma) \cap C_\varepsilon(1) \neq \emptyset}))}{E^\#(\mu(1_{\psi^\#(\gamma) \cap C_\varepsilon(1) \neq \emptyset}))}.$$

But when ε is very small, the ε -neighborhood of 1 is not much distorted by $\varphi_{\#}$. Furthermore, $\psi^{\#} \circ \varphi_{\#}$ is a conformal mapping from the upper half-plane into itself, that depends on $\Gamma^{\#}$ only, that maps the origin onto itself and its derivative at the origin is equal to $\varphi'_{\#}(0)$. Recall also that μ satisfies conformal covariance with the exponent β . It follows easily by dominated convergence that

$$\begin{aligned}
& \tilde{E}(F(\tilde{\gamma}) | \gamma \cap A = \emptyset) \\
&= \lim_{\varepsilon \rightarrow 0} \frac{E^{\#}(\varphi'_{\#}(0)^{\beta} \mu(F(\varphi_{\#}^{-1}(\gamma)) 1_{\gamma \cap C_{\varepsilon}(1) \neq \emptyset}))}{E^{\#}(\varphi'_{\#}(0)^{\beta} \mu(1_{\gamma \cap C_{\varepsilon}(1) \neq \emptyset}))} \\
&= \lim_{\varepsilon \rightarrow 0} \left(\frac{E^{\#}(\varphi'_{\#}(0)^{\beta} \mu(F(\varphi_{\#}^{-1}(\gamma)) 1_{\gamma \cap C_{\varepsilon}(1) \neq \emptyset}))}{\mu(1_{\gamma \cap C_{\varepsilon}(1) \neq \emptyset})} \times \frac{\mu(1_{\gamma \cap C_{\varepsilon}(1) \neq \emptyset})}{E^{\#}(\varphi'_{\#}(0)^{\beta} \mu(1_{\gamma \cap C_{\varepsilon}(1) \neq \emptyset}))} \right) \\
&= \frac{E^{\#}(\varphi'_{\#}(0)^{\beta} \tilde{E}(F(\varphi_{\#}^{-1}(\tilde{\gamma})))}{E^{\#}(\varphi'_{\#}(0)^{\beta})}.
\end{aligned}$$

□

We now use this to derive Proposition 5.7:

Proof. Let us consider an independent CLE $\Gamma^{\#}$ as before, and for each A as before, such that $A \cap \mathbb{R} \subset (0, 1)$, define $\varphi_{\#}$. It is important to observe that if $\tilde{\gamma}$ is a two-point pinned loop, then $\varphi_{\#}^{-1}(\tilde{\gamma})$ is always a two-point pinned loop, and that $U(\varphi_{\#}^{-1}(\tilde{\gamma})) = U(\tilde{\gamma})$. Furthermore, note that the event $A \cap \tilde{\gamma} = \emptyset$ is identical to the event that $A \cap \gamma_* = \emptyset$.

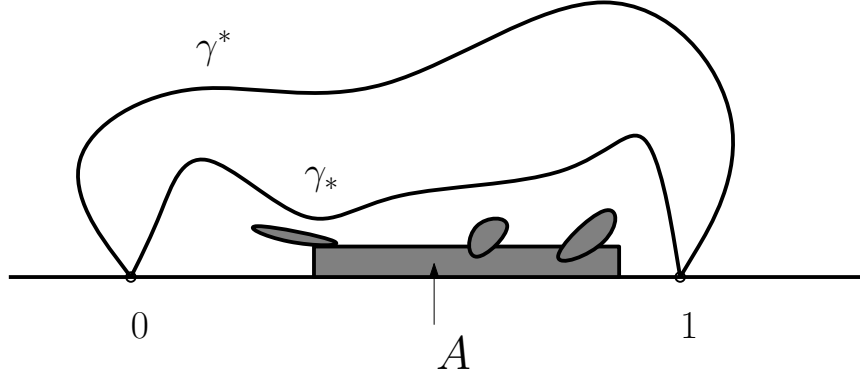

Figure 19: Proof of independence (sketch)

Hence, we get that for all continuous bounded function F on the space of loops (recall that γ and $\varphi_{\#}$ are independent)

$$\begin{aligned}
\tilde{E}(F(U(\tilde{\gamma})) | \gamma_* \cap A = \emptyset) &= E^{\#}(\varphi'_{\#}(0)^{\beta})^{-1} \tilde{E}^{\#}(\varphi'_{\#}(0)^{\beta} F(U(\varphi_{\#}^{-1}(\tilde{\gamma})))) \\
&= E^{\#}(\varphi'_{\#}(0)^{\beta})^{-1} \tilde{E}^{\#}(\varphi'_{\#}(0)^{\beta} F(U(\tilde{\gamma}))) \\
&= E^{\#}(\varphi'_{\#}(0)^{\beta})^{-1} E^{\#}(\varphi'_{\#}(0)^{\beta}) \tilde{E}(F(U(\tilde{\gamma}))) \\
&= \tilde{E}(F(U(\tilde{\gamma}))).
\end{aligned}$$

Since this is true for all such A , it follows that $U(\tilde{\gamma})$ and γ_* are indeed independent. □

In the sequel, we call P^* the law of $U(\tilde{\gamma})$. This is a probability measure on paths joining 1 to 0 in the upper half-plane. Note here that P^* is invariant under the Moebius transformations from \mathbb{H} onto itself that preserve 0 and 1. This follows easily from the corollary and from the fact that the same is true for the two-point pinned measure.

Let us define P^{**} to be the image of P^* under the conformal map $z \mapsto 1 - (1/z)$ of \mathbb{H} onto itself (that maps 1 to 0 and 0 to ∞). P^{**} is then a probability measure on simple paths in \mathbb{H} from 0 to infinity, that is scale-invariant (because the multiplications by positive constants are the Moebius transformations in \mathbb{H} that leave 0 and ∞ invariant).

6 Pinned loops and SLE excursions

6.1 Two-point pinned measure and SLE paths

The goal of this section is show that the pinned measure μ is an ‘‘SLE excursion measure’’. Let us first combine the results of the previous section into a single tractable statement: Consider the pinned configuration measure $\bar{\mu}$ and some finite piecewise linear path η in \mathbb{H} that starts on the positive real half-line, has no double points, and such that all of its segments are horizontal or vertical. We parametrize it ‘‘from the real axis to the tip’’. We also suppose that

$$\mu(\{\gamma : \gamma \cap \eta \neq \emptyset\}) = 1.$$

so that we can view μ (and $\bar{\mu}$ on the corresponding set of configurations) as a probability measure.

For each pinned configuration $(\bar{\gamma}, \bar{\Gamma})$ such that $\bar{\gamma} \cap \eta \neq \emptyset$, we can define the first meeting time T of η with $\bar{\gamma}$, i.e. $T = \min\{t : \eta(t) \in \bar{\gamma}\}$. Let us now consider $\tilde{\Gamma}_\eta$ to be the set of loops of $\bar{\Gamma}$ that intersect $\eta[0, T]$. We also call γ_- the part of γ (when oriented counterclockwise) between 0 and $\eta(T)$, and γ^+ the other part. Let us now define the set H_- to be the unbounded connected component of the set obtained by removing from \mathbb{H} the union of γ_- , $\eta[0, T]$ and the loops of $\tilde{\Gamma}_\eta$. We let ψ_- denote the conformal map from H_- onto \mathbb{H} such that $\psi_-(0-) = 0$, $\psi_-(\eta_T) = 1$ and $\psi_-(\infty) = \infty$.

Note that ψ_- , γ_- and $\tilde{\Gamma}_\eta$ are all deterministic functions of the triple $(\bar{\gamma}, \bar{\Gamma}, \eta)$. We will sometimes write $\psi_{-, \eta}$ and $\gamma_{-, \eta}$, $\gamma^{+, \eta}$ to indicate the dependence in η .

Proposition 6.1. $\psi_-(\gamma^+)$ is independent of ψ_- and γ_- , and its law is P^* .

Proof. This is a direct combination of our previous results. Let ψ_η denote the conformal map from $\mathbb{H} \setminus (\eta[0, T] \cup \tilde{\Gamma}_\eta)$ onto \mathbb{H} with $\psi_\eta(0) = 0$, $\psi_\eta(\eta(T)) = 1$ and $\psi_\eta(\infty) = \infty$. Conformal invariance of \tilde{P} under the maps that preserve 0 and 1, and the definition of the two-point pinned measure shows that $\psi_\eta(\gamma)$ is independent of ψ_η and that its law is the two-point pinned measure \tilde{P} .

If we now define $\gamma_* = \psi_\eta(\gamma_-)$ and $\gamma^* = \psi_\eta(\gamma^+)$, and ψ_* (which depends on γ_* alone) as before, we know from Proposition 5.7 that $\psi_*(\gamma^*)$ is independent of γ_* , and distributed as P^* . Hence, $\psi_*(\gamma^*)$ is independent of $(\gamma_*, \psi_*, \psi_\eta)$.

We can now conclude, noting that $\psi_*(\gamma^*) = \psi_-(\gamma^+)$ and that $\gamma_- = \psi_\eta^{-1}(\gamma_*)$. \square

Suppose now that $\eta : [0, l] \rightarrow \mathbb{H}$ is a finite piecewise linear path as before, but that $\mu(\{\gamma : \gamma \cap \eta[0, l] \neq \emptyset\})$ is not equal to one. We can use scaling in order to find some constant

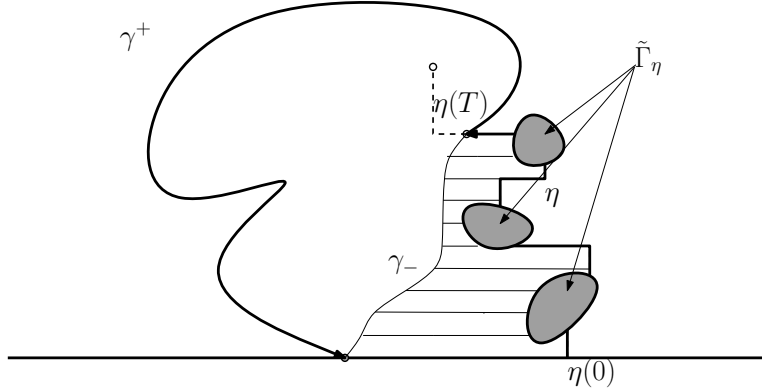

Figure 20: Use of independence (sketch)

λ , in such a way that we can apply the previous statement to $\lambda\eta$, and it therefore follows that Proposition 6.1 still holds if we consider the measure μ on the event $\{\gamma : \gamma \cap \eta[0, l] \neq \emptyset\}$, and renormalized in order to be a probability measure on this event. Since this is true for all l , it also follows that:

Corollary 6.2. *The same statement holds if we consider the measure μ restricted to the event that γ intersects only the last segment of η (and not the previous ones), and if we renormalize the measure μ to be a probability measure on this event.*

We now want to deduce from this corollary the fact that P^* is the law of some SLE_κ from 1 to 0 in \mathbb{H} i.e., that P^{**} is the law of some SLE_κ in \mathbb{H} . We will use Oded Schramm's conformal Markov property characterization of SLE that we now briefly recall. Suppose that one is given a continuous simple curve ξ in $\mathbb{H} \cup \{0\}$ starting at 0. Let us parametrize ξ according to its half-plane capacity, i.e., in such a way that for each t , there exists a conformal map g_t from $H_t := \mathbb{H} \setminus \xi[0, t]$ onto \mathbb{H} such that $g_t(z) = z + 2t/z + o(1/z)$ as $z \rightarrow \infty$. Suppose that the half-plane capacity of ξ is not bounded (i.e., that ξ is defined for all $t \geq 0$), and define $f_t(z) = g_t(z) - g_t(\gamma_t)$, i.e. the conformal map from H_t onto \mathbb{H} with $f_t(\xi_t) = 0$ and $f_t(z) \sim z$ at infinity. Then:

Lemma 6.3 (Schramm [24]). *If the law of ξ is scale-invariant in distribution (i.e., the law of $(\lambda^{-1}\xi_{\lambda^2 t}, t \geq 0)$ does not depend on λ), and if for all $t \geq 0$, the conditional law of $f_t(\xi[t, \infty))$ given $\xi[0, t]$ is identical to the initial law of ξ , then ξ is an SLE curve.*

Recall that this result can be easily understood using Loewner's theory of slit mappings that shows that the curve ξ is characterized by the function $t \mapsto W_t := g_t(\xi_t)$. Indeed, the previous conditions imply on the one hand that the random function $t \mapsto W_t$ has the Brownian scaling property (because ξ is scale-invariant in distribution) and on the other hand that it is a continuous process with independent increments. From that it follows that it is a multiple of a standard Brownian motion (and one can call this multiplicative constant $\sqrt{\kappa}$). As the function W characterizes ξ , this characterizes the law of the path ξ (up to this one-parameter choice). Furthermore, SLE computations (see [24]) show that the fact that the curve is simple implies that $\kappa \leq 4$.

There are several natural ways that one can use in order to parametrize a pinned loop. We are going to choose one that is tailored for our purpose, i.e., to recognize SLE excursions. Let us first choose r_0 in such a way that

$$\mu(R(\gamma) \geq r_0) = 1.$$

Then, the measure μ restricted to the set $\mathcal{Q} = \{\gamma : R(\gamma) \geq r_0\}$ is a probability measure that we will call Q in the present section. Until the rest of the present subsection, we will assume that γ is sampled from this probability measure.

Suppose now that $\gamma \in \mathcal{Q}$ and let us orient it “anti-clockwise”, i.e., γ starts at 0, makes a simple anti-clockwise loop in \mathbb{H} and comes back to 0. On the way, there is the first intersection point z_0 of γ with $\{z : |z| = r_0\}$. We define $b_0 := b_0(\gamma)$ the beginning part of the loop between 0 and z_0 (with the anti-clockwise orientation) and we call $e_0 := e_0(\gamma)$ the other (end-)part of the loop γ between z_0 and 0.

Let h_0 denote the conformal mapping from $\mathbb{H} \setminus b_0$ onto \mathbb{H} normalized by $h_0(z_0) = 0$, $h_0(\infty) = 1$ and $h_0(0-) = \infty$ (where $h_0(0-)$ denotes the image of the left-limit of 0 in $\mathbb{H} \setminus b_0$). The end-part $e_0 = e_0(\gamma)$ of the loop between z_0 and 0 is a continuous simple path from z_0 to $0-$ in $(\mathbb{H} \setminus b_0) \cup \{z_0, 0-\}$. Hence, its image under h_0 is a simple path from 0 to infinity in the upper half-plane that we now call ξ . We parametrize ξ according to its half-plane capacity as before (and define the conformal maps g_t and f_t). This therefore defines (via the map h_0^{-1}) a parametrization of the path e_0 .

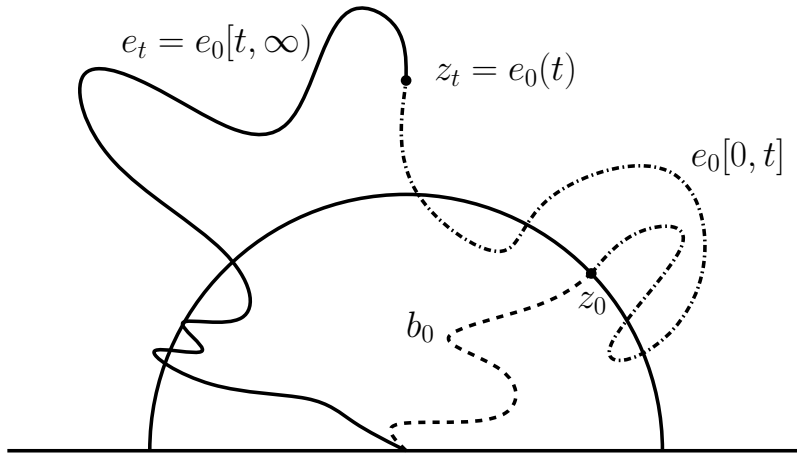

Figure 21: Definition of $e_t(\gamma)$ and $b_t(\gamma)$ (sketch)

For each $t \geq 0$, we now define $z_t = e_0(t)$,

$$b_t := b_t(\gamma) = b_0(\gamma) \cup e_0[0, t] \text{ and } e_t := e_t(\gamma) = e_0[t, \infty).$$

Let us insist on the fact that b_t and e_t are paths (and not points). h_t will denote the conformal map from $\mathbb{H} \setminus b_t(\gamma)$ with $h_t(z_t) = 0$, $h_t(0-) = \infty$ and $h_t(\infty) = 1$. We will now prove the following statement that we will then combine with Lemma 6.3:

Lemma 6.4. *Under the probability measure Q , for each given $t \geq 0$, $h_t(e_t(\gamma)) = f_t(\xi[t, \infty))$ is independent of $b_t(\gamma)$. Furthermore, its law is P^{**} .*

Proof. Let us fix $t \geq 0$. Define ψ_t the conformal map from $\mathbb{H} \setminus b_t(\gamma)$ on \mathbb{H} with $\psi_t(z_t) = 1$, $\psi_t(\infty) = \infty$, $\psi_t(0-) = 0$. Then, the lemma is clearly equivalent to the fact that $\psi_t(e_t)$ is independent of $b_t(\gamma)$, and that its law is P^* .

Define $b_t(\gamma)$ as before (when γ is defined under the probability measure Q). The proof will be based on the independence property of the two-point pinned measure. In order to use this, we will need to discover the pinned loop via some grid-based path that turns out to be close to b_t . Take $n \geq 1$. Let us try to associate to each $b = b_t(\gamma)$ a grid approximation of b_t “from the right side”, that we will call β_n .

First of all, let us note that the diameter of $b_{t+2/n} \setminus b_{t-1/n}$ goes to 0 almost surely when $n \rightarrow \infty$ and that we can find some sequence $\varepsilon_n \rightarrow 0$ such that

$$\lim_{n \rightarrow \infty} Q(d(b_{t-1/2n}, e_t) \geq \varepsilon_n) = 1$$

(this is just because γ is Q -almost surely a simple curve), where here d denotes the usual Euclidean distance. Then, when δ is a mesh-size, we try to define a grid-approximation of $b_{t-1/n}$ on the grid $(\delta\mathbb{N}) \times (\delta\mathbb{Z})$ as follows: Delete all the edges from the grid that are distance less than δ from $b_{t-1/n}$, and consider the unbounded connected component C of the graph that one obtains. Let f denote the first edge of C that γ hits (it is therefore after “time” $t - 1/n$). It is clearly on the “boundary of C seen from $b_{t-1/n}$ ”, and one can find the simple nearest-neighbor path from the positive real axis to f (where f is its last edge) on C that is “closest” to $b_{t-1/n}$. We call this path $\beta = \beta(b, t, n, \delta)$.

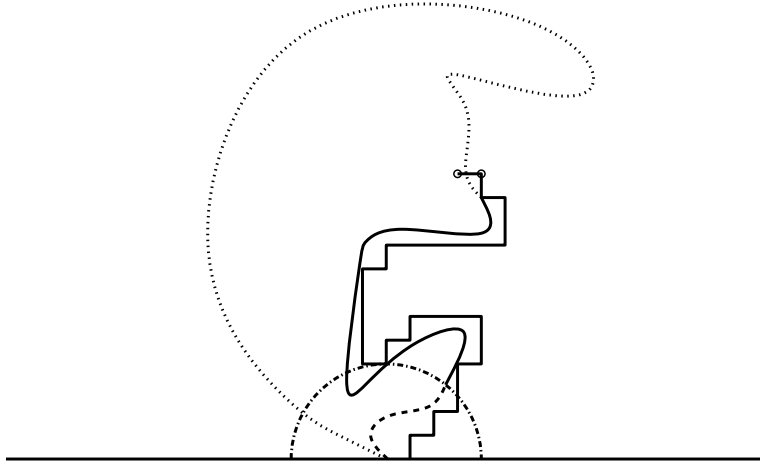

Figure 22: Grid-approximation of some $b_t(\gamma)$ (sketch)

Clearly, when t , n and b are fixed, then when δ is getting smaller, the (Hausdorff) distance between β and b is going to 0. Hence, we can choose δ_n in such a way that

$$\lim_{n \rightarrow \infty} Q(d_H(\beta, b_{t-1/n}) \leq \varepsilon_n^2) = 1$$

(where d_H denotes the Hausdorff distance).

Once these sequences δ_n and ε_n are chosen, we denote for each given n , this grid approximation $\beta(b, t, n, \delta_n)$ by β_n . The previous estimates also ensure that with high probability (when $n \rightarrow \infty$), $\gamma \cap \beta_n \subset b_{t+1/n} \setminus b_{t-1/n}$.

Furthermore, we can observe that if we are given b_t and a finite grid-path η on $\delta_n\mathbb{Z} \times \delta_n\mathbb{N}$, it suffices to look at the path b_t only until the moment it hits η for the first time to check whether $\beta_n = \eta$ or not.

Suppose now that η is some given grid-path that has a positive probability to be equal to β_n . Let us consider a pinned configuration $(\gamma, \bar{\Gamma})$ such that γ intersects η_T , and let us define $\psi_- = \psi_{-, \eta}$, $\gamma_- = \gamma_{-, \eta}$ and $\gamma^+ = \gamma^{+, \eta}$ as before (recall that γ_- and γ^+ are the two parts of γ , before and after it hits $\eta(T)$, which is the first point of η that intersects γ , and that ψ_- corresponds to the domain where one from $\mathbb{H} \setminus \eta[0, T]$ the loops of $\bar{\Gamma}$ that intersect $\eta[0, T]$). Then, we know on the one hand that $\psi_-(\gamma^+)$ is independent of ψ_- and γ_- , and that its law is P^* . On the other hand, we have just argued that the event $\{\beta_n = \eta\}$ is measurable with respect to γ_- (this is because γ_- contains the part of γ up to the first time it hits η), so that the conditional law of $\psi_-(\gamma^+)$ given $\{\beta_n = \eta\}$ is also P^* .

When $\beta_n = \eta$, we define $\psi_{n,-}$ to be this map ψ_- , and we also define $\gamma_{n,+}$ and $\gamma_{n,-}$ to be these γ^+ and γ_- . Note that when n is very large, the probability that β_n intersects some macroscopic loop of $\bar{\Gamma}$ is very small (this is because they are all at positive distance of $\bar{\gamma}$, and that β_n is very close to γ). This, and our definition of β_n ensures readily that $\gamma_{n,-}$ converges (in Hausdorff topology) to b_t , and that $\psi_{n,-}(\gamma_{n,+})$ converges to $\psi_t(e_t)$.

We are now almost ready to conclude: For any continuous bounded functions F and G with respect to the Hausdorff topology, we get that:

$$\begin{aligned}
Q(F(b_t(\gamma))G(\psi_t(e_t))) &= \lim_{n \rightarrow \infty} Q(F(\gamma_{n,-})G(\psi_{n,-}(\gamma_{n,+}))) \\
&= \lim_{n \rightarrow \infty} \sum_{\eta} Q(1_{\{\beta_n = \eta\}} F(\gamma_{-, \eta})G(\psi_{-, \eta}(\gamma^{+, \eta}))) \\
&= \lim_{n \rightarrow \infty} \sum_{\eta} Q(1_{\{\beta_n = \eta\}} F(\gamma_{-, \eta})) \times P^*(G) \\
&= \lim_{n \rightarrow \infty} P^*(G) \times Q(F(\gamma_{n,-})) \\
&= P^*(G) \times Q(F(b_t(\gamma)))
\end{aligned}$$

where we have use the independence property of Corollary 6.2 between the second and the third line. \square

This lemma has a number of consequences: It implies (taking $t = 0$) that the law of ξ itself is P^{**} . We know also that P^{**} is scale-invariant. Hence, we get that ξ is a continuous simple curve from 0 to infinity in the upper half-plane, that is scale-invariant in law, and such that for all t , the conditional law of $f_t(\xi[t, \infty))$ given $\xi[0, t]$ is the same as the law of ξ itself. The previous characterization of SLE therefore implies that:

Corollary 6.5. *The curve ξ is an SLE_{κ} for some $\kappa \in [0, 4]$. Furthermore, ξ is independent of $b_0(\gamma)$.*

The independence between $b_0(\gamma)$ and ξ shows that the probability measure Q can be constructed as follows: First sample $b_0(\gamma)$; this defines its tip z_0 . Then draw an SLE_{κ} (for some given value of κ) from z_0 to 0- in $H \setminus b_0$. Standard SLE computations (see [25]) show that the probability that an SLE_{κ} from 1 to 0 in \mathbb{H} hits the (semi-)circle of radius $\rho > 1$

around the origin decays like $\rho^{-(8/\kappa)+1+o(1)}$ when $\rho \rightarrow \infty$. It follows immediately that if κ is the value associated to the pinned measure μ ,

$$\mu(\{\gamma : R(\gamma) \geq \rho\}) = Q(\{\gamma : R(\gamma) \geq \rho\}) = \rho^{-(8/\kappa)+1+o(1)}$$

as $\rho \rightarrow \infty$. If we compare this with the scaling property of μ , i.e., the fact that

$$\mu(\{\gamma : R(\gamma) \geq \rho\}) = \rho^{-\beta} \mu(\{\gamma : R(\gamma) \geq 1\}),$$

we get that:

Corollary 6.6. *One necessarily has $\kappa = 8/(1 + \beta)$, $\beta \in [1, 2)$ and $\kappa \in (8/3, 4]$.*

The last two statements in the corollary are just due to the fact that we know already that $\beta < 2$ (so that $\kappa > 8/3$) and also that $\kappa \leq 4$ (because γ does not touch the boundary elsewhere than at the origin), which implies that $\beta \geq 1$.

6.2 Pinned measure and SLE excursion measure

In order to show that Corollary 6.5 in fact characterizes the measure μ , let us first recall the following rather standard facts concerning SLE processes and excursions of Bessel processes:

Lemma 6.7. *Suppose that $\kappa \in (8/3, 4]$, and that P^ε denotes the law of an SLE_κ from ε to 0 in the upper half-plane. Then, the measures $\varepsilon^{1-(8/\kappa)}P^\varepsilon$ converge (vaguely) to an infinite measure ν on the set of pinned loops, that we call the SLE_κ excursion measure.*

Vague convergence here means that for all $r > 0$, when restricted on the set of paths with diameter greater than r , $\varepsilon^{1-(8/\kappa)}P^\varepsilon$ converges weakly (with respect to the Hausdorff topology for instance).

Proof. Let us fix a positive ε and consider an SLE_κ curve (for $\kappa \in (8/3, 4]$) from ε to 0 in \mathbb{H} . It is possible to parametrize this curve as a Loewner chain in the upper half-plane, with time measured via the half-plane capacity. If we use this parametrization, then the SLE path is defined up to some (random) time τ , and one can define for each $t \geq 0$, the conformal map g_t from $\mathbb{H} \setminus \gamma[0, t]$ normalized at infinity, and it satisfies Loewner's equation $\partial_t g_t(z) = 2/(g_t(z) - U_t)$ for all $t \leq \tau$ and $z \notin \gamma[0, t]$, where $U_t = g_t(\gamma_t)$. Note also that τ is the hitting time of 0 by $U_t - g_t(0)$ (because γ is almost surely a simple curve).

It is quite easy to argue that the process $X_t := U_t - g_t(0)$ is necessarily a Markov process with the same scaling property as Brownian motion, and therefore the multiple of some Bessel process. In fact, direct computations (see for instance [30]) shows that γ is a so-called $SLE(\kappa, \kappa - 6)$ process stopped at its first swallowing time of 0, i.e., that

$$dU_t = \sqrt{\kappa}dB_t + \frac{\kappa - 6}{U_t - g_t(0)}dt$$

and

$$dX_t = \sqrt{\kappa}dB_t + \frac{\kappa - 4}{X_t}dt$$

where B is a standard Brownian motion. Note that U can be recovered from X because

$$U_t - U_0 = X_t - X_0 + \int_0^t 2dt/X_t.$$

An important feature here is (and this follows immediately from Itô's formula) that for $\beta = 8/\kappa - 1$, $(X_t)^\beta$ is a local martingale up to its first hitting time of 0. For instance, when $X_0 = \varepsilon$, then the probability that X hits $\varepsilon' > \varepsilon$ before hitting 0 is $(\varepsilon/\varepsilon')^\beta$. This makes it possible (in the standard procedure to define Bessel excursions) to define a measure ν on the space of one-dimensional excursions $(Y_t, t \leq \tau)$ (i.e., such that $Y_0 = Y_\tau = 0$ and $Y(0, \tau) \subset (0, \infty)$) in such a way that the ν -mass of the set of paths that reach level ε (at some time τ_ε) is $\varepsilon^{-\beta}$, and that the $(\varepsilon^\beta \nu)$ -law of $(Y_{t+\tau(\varepsilon)}, t \in [0, \tau - \tau_\varepsilon])$ is the law of X as before started from level ε and stopped at its first hitting of 0.

Each such excursion Y clearly defines (via Loewner's equation, replacing X by Y) a two-dimensional pinned loop γ . Furthermore, we can describe the measure ν restricted to the set of loops such that the corresponding excursion Y reaches ε as follows:

- The ν -mass of the set of pinned loops γ such that Y hits ε is $\varepsilon^{-\beta}$.
- On this set, the measure $\nu^\varepsilon = \varepsilon^\beta \nu$ is a probability measure, and one can sample γ by first sampling $\gamma[0, \tau_\varepsilon]$, and then finishing the curve by an independent SLE_κ in $\mathbb{H} \setminus \gamma[0, \tau_\varepsilon]$ from $\gamma(\tau_\varepsilon)$ to 0.

It follows that the difference between ν^ε and P^ε is just the mapping by the random conformal mapping normalized at infinity from $\mathbb{H} \setminus \gamma[0, \tau_\varepsilon]$ onto \mathbb{H} . But this mapping clearly converges to the identity away from the origin, which proves the claim. \square

Proposition 6.8. *The pinned measure μ is the multiple of the SLE_κ -excursion measure ν for $\kappa = 8/(1 + \beta)$ (where β is the “exponent” associated to μ), that is normalized in such a way that $\mu(\gamma \text{ surrounds } i) = 1$.*

A consequence of this proposition is that there exists at most one possible pinned measure associated with each exponent β in $[1, 2)$.

Proof. Recall that we have the following description of μ (this is just the combination of the scaling property of μ and of the definition of r_0): For each $\varepsilon \geq 0$, the μ -mass of the set of loops with radius at least εr_0 is $\varepsilon^{-\beta}$. If we restrict ourselves to this set of loops, and renormalize μ so that it is a probability measure on this set, we can first sample the part of γ up to the point at which it reaches the circle of radius ε , and then complete with an SLE_κ back to the origin in the remaining domain.

We can note that for some absolute constant K_0 , if we consider a loop that does not reach the circle of radius r_0 , then the corresponding Loewner-type function Y as before does not reach K_0 . Hence, the set of loops that reach the circle of radius $r_0 \varepsilon$ contains the set of loops for which the corresponding function Y reaches $K_0 \varepsilon$. Let us now sample the beginning of the loop γ as before up to the first hitting point of the circle of radius εr_0 . Then continue the SLE up to the first time (if it exists) at which the function Y associated to the loop reaches $K_0 \varepsilon$. A fixed positive fraction K_1 (independent of ε because of scale-invariance) of

these SLEs succeed in doing so. Then, after this point, we still are continuing with an SLE_κ in the remaining domain, so that γ is close to a sample of P^ε .

Hence, we conclude readily that μ is a constant multiple of ν (where the constant is given in terms of K_0 , K_1 and β). Another way to describe this constant is to recall that $\mu(\gamma \text{ surrounds } i) = 1$. \square

Let us now make the following comment: Suppose that a CLE in \mathbb{H} is given. This defines a random collection of loops (γ_j) . If we now define the symmetry S with respect to the imaginary axis (i.e. the map $z \mapsto -\bar{z}$), then it is clear from our CLE axioms that the family $(S(\gamma_j))$ is also a CLE in \mathbb{H} . We have just seen that each CLE defines a pinned measure μ that happens to be the (multiple of an) SLE_κ excursion measure. But, by construction, the pinned measure associated to the CLE $(S(\gamma_j))$ is simply the image of μ by the map S . Therefore (noting that both these CLEs correspond to the same exponent β), the CLEs $(S(\gamma_j))$ and (γ_j) correspond to the same SLE excursion measure. Hence:

Corollary 6.9. *If the pinned measure of a CLE is the SLE_κ excursion measure, then it implies that the law of the SLE_κ bubble (as defined in the introduction) is reversible: The trace of SLE_κ bubble traced clockwise has the same law as that of an SLE_κ bubble traced anti-clockwise.*

It has been proved by Dapeng Zhan that SLE_κ for $\kappa \leq 4$ is indeed reversible (see [44]), which in fact implies this last statement. The present set-up (combined with [33] where it is shown that all SLE_κ for $\kappa \in (8/3, 4]$ correspond to some CLE) therefore provides an alternative approach to reversibility of SLE paths.

7 Reconstructing a CLE from the pinned measure

The goal of the present section is to show that if one knows μ , then one can recover the law of the initial CLE, and to make the connection with the CLE_κ families defined in [31]. This will conclude the proof of Theorems 1.2 and 1.3.

The rough idea is to use the radial exploration and to use the same idea as in the proof of the fact that $\beta < 2$, but “backwards”: The fact that $\beta < 2$ will ensure that this exploration (described in Section 4.4) can be approximated by keeping only those steps that discover “large” loops, because the cumulative contribution of the small ones vanish. Furthermore, these large loops can be described using a Poisson point process of intensity μ . This will lead to the description of a “continuous exploration mechanism” that we will relate to $SLE(\kappa, \kappa - 6)$ processes.

7.1 The law of $\gamma(i)$

It is useful to first show how one can recover the law of the loop in the CLE that contains i . Recall that the set-up is the following: We suppose that we are given the law P of a CLE. The previous sections enable us to define its pinned measure μ and we have seen that it is necessarily equal (up to a multiplicative constant) to the SLE_κ excursion measure for some κ in $(8/3, 4]$.

Lemma 7.1. *The pinned measure μ characterizes the law of $\gamma(i)$ under P . In other words, if two (laws of) CLEs define the same pinned measure, then $\gamma(i)$ is distributed in the same way for both CLEs.*

Proof. Let us use on the one hand the radial exploration mechanism in \mathbb{H} . This defines (for each ε) the geometric number N of exploration steps, the conformal maps $\varphi_1^\varepsilon, \dots, \varphi_N^\varepsilon$ that are normalized at i (i.e., $\varphi_n^\varepsilon(i) = i$ and the derivative at i is positive). We also define for all $n \leq N$,

$$\Phi_n^\varepsilon = \varphi_n^\varepsilon \circ \dots \circ \varphi_1^\varepsilon$$

and $\Phi^\varepsilon = \Phi_N^\varepsilon$. Recall that:

- The random variable N is geometric with mean $1/u(\varepsilon)$.
- Conditionally on the value of N , the maps $\varphi_1^\varepsilon, \dots, \varphi_N^\varepsilon$ are i.i.d. (and their law does not depend on N — these are the maps corresponding to the CLE exploration conditioned on the fact that $\gamma(i)$ does not intersect C_ε).
- What one “discovers” at the $(N+1)$ -th step is independent of the value of N and of the maps $\varphi_1^\varepsilon, \dots, \varphi_N^\varepsilon$. It is just a CLE conditioned by the event that the loop surrounding i intersects C_ε .

On the other hand, define a Poisson point process of pinned loops $(\bar{\gamma}_t, t \geq 0)$ with intensity μ , and let T be the first time at which one $\bar{\gamma}_t$ surrounds i . The μ -mass of the set of loops that surround i is equal to 1, so that T is an exponential random variable of parameter 1 (see for instance [22] for background on Poisson point processes). For each of the countably many t in $(0, T)$ such that $\bar{\gamma}_t$ exists, we denote by f_t the conformal map normalized at i by $f_t(i) = i$ and $f_t'(i) > 0$, from the unbounded connected component of $\mathbb{H} \setminus \bar{\gamma}_t$ onto \mathbb{H} . The fact that $\beta < 2$ shows that

$$\begin{aligned} E \left(\sum_{t < T} a(f_t) 1_{R(\bar{\gamma}_t) < 1/2} \right) &\leq E(T) \mu(a(f) 1_{R(\gamma) < 1/2}) \\ &\leq C \mu(R(\gamma)^2 1_{R(\gamma) < 1/2}) \leq C' \int_0^{1/2} \frac{x^2 dx}{x^{1+\beta}} < \infty. \end{aligned}$$

Since $\mu(R(\gamma) \geq 1/2) < \infty$, the number of times t before T at which $R(\bar{\gamma}_t) \geq 1/2$ is almost surely finite, so that almost surely, $\sum_{t < T} a(f_t)$ is finite (here and in this section, we shall re-use notations and arguments that have been presented in the “stability of Loewner chains” paragraph of Section 4.3). Hence, if for each $r > 0$, we define the iteration Ψ^r of the finitely many f_t ’s for $t < T$ (in their order of appearance, let us call the corresponding times $t_1(r), \dots, t_k(r)$) that correspond to pinned loops $\bar{\gamma}_{t_j}$ ’s of radius greater than r , we get that as $r \rightarrow 0+$, the maps Ψ^r converge (in Carathéodory topology, with respect to the marked point i) to some conformal map Ψ that can be interpreted as the iteration of all the conformal maps $(f_t, t < T)$ in their order of appearance. Note that Ψ maps some open set onto the upper half-plane, but that we have no information at this point on the regularity of the boundary of this open set (whether it is a curve or not, etc.).

Our goal now is to prove that when ε is small, then Ψ and Φ^ε are very close (in law – with respect to the Carathéodory topology from i). This will ensure that the law of $\gamma(i)$ in the CLE is identical to that of $\Psi^{-1}(\tilde{\gamma}_T)$, i.e. the image under Ψ^{-1} of an independent sample of μ^i . In order to do so, we are going to introduce the cut-off Ψ^r as before. For each $r > 0$, we define $n_1(r), \dots, n_k(r)$ the steps before N at which one discovers a loop intersecting C_r (note that this number of steps k and the values of the n_j 's are random, and depend on ε as well). The description of μ shows that for each fixed $r > 0$, the joint law of $(\varphi_{n_1(r)}^\varepsilon, \dots, \varphi_{n_k(r)}^\varepsilon)$ converges precisely to that of the corresponding $(f_{t_1(r)}, \dots, f_{t_k(r)})$; the law of their composition $\varphi_{n_k(r)}^\varepsilon \circ \dots \circ \varphi_{n_1(r)}^\varepsilon$ therefore converges to that of Ψ^r .

It now just remains to control

$$\sum_{n \leq N} 1_{n \notin \{n_1(r), \dots, n_k(r)\}} a(\varphi_n^\varepsilon)$$

as $r \rightarrow 0$, uniformly with respect to ε . We will bound the expected value of this quantity. Recall that $\beta < 2$, that the half-plane capacity of a set contained in a disc of radius smaller than r around the origin is bounded by a constant C times r^2 , that N follows a geometric random variable of mean $1/u(\varepsilon)$, and that conditionally on N , the maps $\varphi_1^\varepsilon, \dots, \varphi_N^\varepsilon$ are i.i.d. It follows that

$$E\left(\sum_{n \leq N} 1_{n \notin \{n_1(r), \dots, n_k(r)\}} a(\varphi_n^\varepsilon)\right) \leq E(N)E(a(\varphi_1^\varepsilon)1_{n_1(r) \neq 1})$$

and that

$$E(a(\varphi_1^\varepsilon)1_{n_1(r) \neq 1}) \leq C \times E(R(\tilde{\gamma}(\varepsilon))^2 1_{R(\tilde{\gamma}(\varepsilon)) \leq r}).$$

This last expectation will be controlled thanks to the bound $\beta < 2$: Let us first fix $\delta = 1/2$ and choose some $a \in (0, (2 - \beta)/2)$, for instance $a = (2 - \beta)/4$. We know that

$$\lim_{\eta \rightarrow 0} \frac{v(\delta\eta)}{v(\eta)} \geq \delta^{2-2a}.$$

In particular, for some $\eta_0 > 0$, we get that for all $\eta < \eta_0$,

$$\frac{v(\delta\eta)}{v(\eta)} \geq \delta^{2-a}.$$

Hence, there exists a constant C' such that for all $m \geq n \geq 1$

$$\frac{v(\delta^m)}{v(\delta^n)} \geq C'(\delta^{m-n})^{2-a}.$$

Hence, if $\delta^{n_0+1} \leq \varepsilon \leq \delta^{n_0} \leq \delta^{n_1+1} \leq r \leq \delta^{n_1}$, we get that

$$\begin{aligned}
& E\left(\sum_{n \leq N} 1_{n \notin \{n_1(r), \dots, n_k(r)\}} a(\varphi_n^\varepsilon)\right) \\
& \leq E(N) \times E(R(\tilde{\gamma}(\varepsilon))^2 1_{R(\tilde{\gamma}(\varepsilon))^2 \leq r}) \\
& \leq \frac{C}{u(\delta^{n_0})} \sum_{j \in [n_1, n_0]} \delta^{2j} P(R(\tilde{\gamma}(\delta^{n_0})) \geq \delta^{j+1}) \\
& \leq C'' \sum_{j \in [n_1, n_0]} \delta^{2j} \frac{v(\delta^{n_0-j-1})}{u(\delta^{n_0})} \\
& \leq C''' \sum_{j \geq n_1} \delta^{2j} (\delta^j)^{-2+a} \\
& \leq C''' r^a
\end{aligned}$$

where all the constants do not depend on r and ε , so that this quantity converges to 0 as $r \rightarrow 0+$ independently of ε ; this completes the proof of the fact that the law of Φ_ε converges to Ψ (in Carathéodory topology).

Recall that for each $\varepsilon > 0$, the law of $\gamma(i)$ is described as follows: We consider on the one hand a sample of the conformal map $\Phi^\varepsilon = \Phi_N^\varepsilon$, and on the other hand, an independent sample of the loop $\tilde{\gamma}^\varepsilon$ that surrounds i in a CLE in \mathbb{H} conditioned to intersect C_ε . Then, $\gamma(i)$ is distributed exactly as $\Phi_\varepsilon^{-1}(\tilde{\gamma}^\varepsilon)$.

We have just seen that Φ^ε converges in law to Ψ and we have also proved that the (conditional) law of $\tilde{\gamma}^\varepsilon$ converges to μ^i . It follows therefore that the law of $\gamma(i)$ is described as the image under Ψ^{-1} of an independent sample of μ^i . This description is based solely on the measure μ , so that the law of $\gamma(i)$ can indeed be fully recovered from μ . \square

We may observe that the previous proof also shows that if (z_1, \dots, z_m) are other points in \mathbb{H} , if we restrict ourselves to the event where all these m other points are surrounded by some macroscopic loops that one discovered in this radial exploration mechanism before (or at) the N -th step, the joint distribution of these m loops (some of which may be the same if some loops surround several of these points) in the $\varepsilon \rightarrow 0$ limit is also described via the Poisson point process of pinned loops i.e. via μ .

7.2 Several points

We now want to prove the more general result:

Proposition 7.2. *Two CLE probability measures that define the same pinned measure μ are necessarily equal.*

In other words, the pinned measure μ characterizes the law of the corresponding CLE. This clearly implies Theorem 1.2.

Proof. Note that the law of the CLE is characterized by its “finite-dimensional marginals”, i.e., by the joint distribution of

$$(\gamma(i), \gamma(z_1), \gamma(z_2), \dots, \gamma(z_m))$$

for any finite set of points z_1, \dots, z_m in \mathbb{H} (if we consider the CLE defined in the upper half-plane).

Let us first focus on the law of $(\gamma(i), \gamma(z))$ for some given $z \in \mathbb{H}$ (the general case will be very similar). In order to motivate what follows, let us informally describe what could happen if we simply try to use exactly the same procedure as in the previous subsection. That is, we consider the conformal maps $\varphi_n^\varepsilon, \Phi_n^\varepsilon$ for $n \leq N$ as before. Let K denote the largest $k \leq N$ such that $z \in (\Phi_k^\varepsilon)^{-1}(\mathbb{H})$ (and write $K = N$ if z is not swallowed during the first N steps). We want to keep track of what happens to z , so we define $a_k = \Phi_k^\varepsilon(z)$ (which will be defined up to $k \leq K$). Let us now fix some small positive δ and consider $\varepsilon < \delta$.

We will also introduce another step $K' \leq K$, which is the first step k at which $|a_k| \leq \delta$ or $k = K$. Note that if $K' < K$, this means that after the K' -th step, neither $\gamma(z)$ nor $\gamma(i)$ have been discovered, but that the points z and i are “conformally” quite far away from each other in the domain $H_{K'} = (\Phi_{K'}^\varepsilon)^{-1}(\mathbb{H})$ (i.e., the Green’s function $G_{H_{K'}}(z, i)$ is small — recall that δ is small). This can happen if the exploration gets close to one of the two points in \mathbb{H} , or if it almost disconnects one from the other in \mathbb{H} (and this is in fact a scenario that might really occur).

We can subdivide the case $K' = K$ into three possibilities: The loop $\gamma(z)$ has been discovered before the N -th step (in other words: $K < N$), the loop $\gamma(z)$ is discovered at the N -th step (then with high probability $\gamma(i) = \gamma(z)$ when $\varepsilon \rightarrow 0$), or it has still to be discovered after then N -th step. In all these three cases, the arguments of the previous subsection allow us to conclude that the joint law of $(\gamma(i), \gamma(z))$ on the event that $K' = K$ can be described via the Poisson point process of pinned loops, i.e. thanks to the knowledge of μ .

When $K' < K$, we could just try to continue the exploration process after K' , but at some later step k , it could happen that the exploration procedure captures z because $|a_k| \leq \varepsilon$. Or more generally, the loop $\gamma(z)$ could be discovered in the discrete exploration process at some step k via some loop that intersects C_ε and that has a very small radius (this does not necessarily contradict the fact the $\gamma(z)$ is at positive distance of z). In such a case, the previous argument will clearly not work, as the exploration step corresponding to the discovery of $\gamma(z)$ would not be apparent in the limiting Poisson point process of “macroscopic” pinned loops..

Here is a simple way of fixing this: At the step K' , instead of doing an exploration using the semi-circle C_ε , we use the semi-circle $C_{\sqrt{\delta}}$ of radius $\sqrt{\delta}$. Note that we are only exploring the loops that hit the semicircle (not all the loops hitting the semi-disc) and that $|a_{K'}| \leq \delta$. The harmonic measure of this semi-circle in \mathbb{H} seen from $a_{K'}$ or from i is small (if δ is small). After this K' -th step, z and i are then in two different domains. Furthermore, the probability to discover a loop that intersects also $C_{\delta^{3/4}}$ or $C_{\delta^{1/4}}$ at this K' -th step is very small.

The same arguments as above show convergence (as $\varepsilon \rightarrow 0$) of the laws of the $\Phi_{K'}^\varepsilon$ (in the Carathéodory sense, with normalization at i). With high probability, the K' -th exploration step changes the log conformal radius viewed from either z or i by a fraction that goes to 0 when $\delta \rightarrow 0$. If we keep in mind that the restriction property still holds for non-simply connected subsets of \mathbb{H} (this is the final observation of Section 2), we see that we can then continue the discrete radial exploration (aiming towards i) with ε -semi-circles in the connected component containing i after the K' -th step, and independently another discrete radial exploration (aiming at z) in the domain containing z . In both cases, we continue until

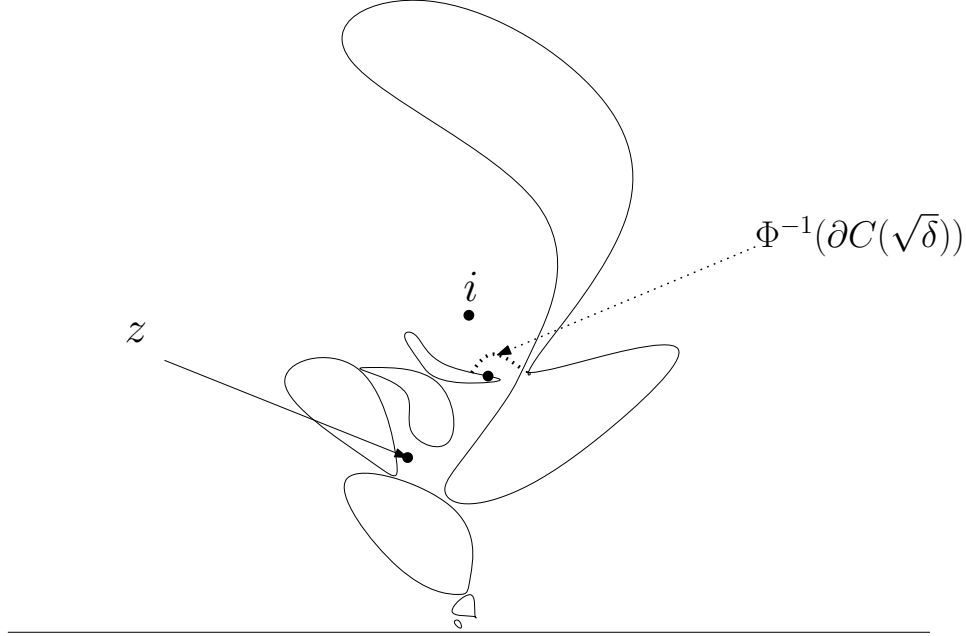

Figure 23: Near separation of z from i (sketch).

we discover $\gamma(i)$ and $\gamma(z)$, and the same arguments as above allow to approximate the laws of these two loops in the two respective domains via two Poisson point processes of loops.

We can therefore conclude that up to an error that tends to 0 with δ , the joint law of $(\gamma(i), \gamma(z))$ on the event where $K' < K$ is also fully described via a procedure that is based on the knowledge of μ only. Hence, the joint law of $(\gamma(i), \gamma(z))$ is fully determined by the pinned measure μ .

Now what if there is more than one additional point, i.e., what about the joint law of $(\gamma(i), \gamma(z_1), \dots, \gamma(z_m))$? We then use the same argument as above, stopping at the first time that *at least one* of the images of the other points gets to a distance less than δ from the origin, i.e., at the step

$$K' = \min\{k : \min(|a_k^1|, \dots, |a_k^m|) \leq \delta\},$$

where $a_k^j = \Phi_k^\varepsilon(z_j)$. Note that at this step, it could happen that several $|a_k^j|$ are in fact quite small simultaneously. If we would explore as before by cutting out the semi-circle $C_{\sqrt{\delta}}$, we might be unlucky and have some a_k^j that lies very close to this semi-circle. However, it is clear that for at least one semi-circle $C_{\delta^{1/j}}$ out of the m semi-circles, $C_{\delta^{1/2}}, C_{\delta^{1/3}}, \dots, C_{\delta^{1/m+1}}$, the harmonic measure of $C_{\delta^{1/j}}$ in \mathbb{H} seen from any of the m points a_k^1, \dots, a_k^m is very small (i.e., tends uniformly to 0 when $\delta \rightarrow 0$). We therefore choose this particular semi-circle to use for the $(K' + 1)$ -th exploration step. This reduces the problem to two independent explorations in the two new domains as before, and each of the two domains contains strictly less than $m + 1$ points. We can then inductively continue the discrete exploration procedure.

For each fixed δ , this shows that up to a small error (that vanishes when $\delta \rightarrow 0$), the $\varepsilon \rightarrow 0$ limit of this exploration procedure is well-approximated via Poisson point processes with intensity μ . This enables to conclude that the joint law of $(\gamma(i), \gamma(z_1), \dots, \gamma(z_m))$ can be fully described in terms of μ . \square

7.3 Background about SLE $(\kappa, \kappa - 6)$

In this section, we briefly review some of the properties of SLE $(\kappa, \kappa - 6)$, in the case where $\kappa \leq 4$ that we are focusing on in the present paper. We refer to [31] for the more precise statements and their proofs. We have already encountered the SLE $(\kappa, \kappa - 6)$ process in Section 6.2. Recall that a process $(X_t, t \geq 0)$ started from $X_0 = x \neq 0$ is called a Bessel process of dimension $\delta \geq 0$ if it is the solution to the ordinary differential equation

$$dX_t = dB_t + \frac{\delta - 1}{2X_t} dt \quad (2)$$

and that this process is well-defined up to its first hitting time of the origin (which is almost surely finite if $\delta < 2$). When $\delta > 0$, it is possible to define it (uniquely) also after it hits the origin, in such a way that $X_t \geq 0$ when $t \geq 0$ and that the Lebesgue measure of the time spent by X at the origin is 0. This is the “instantaneously reflected Bessel process”, that can also be defined by concatenating a Poisson point process $(e_\ell)_{\ell \geq 0}$ of Bessel excursions (see for instance [22] for background on Bessel processes). We will also use a variation of this process obtained when tossing a fair coin for each excursion of the Bessel process in order to decide if it is positive or negative (this process is therefore defined on a larger probability space than the Brownian motion B), which is the “symmetrized Bessel process”.

To each excursion e of the Bessel process of dimension δ , we associate $J(e)$ the integral of $dt/e(t)$ on this excursion. Recall that $(X_t)^\beta$ is a local martingale as long as X_t stays away from the origin (for $\beta = 2 - \delta$); it follows from a simple scaling argument that the $J(e)$'s are finite and that the intensity of the Poisson point process $(J(e_\ell), \ell \geq 0)$ is a multiple of $dx/x^{1+\beta/2}$.

It is already apparent in Section 6.2 that it will be essential to try to make sense of a quantity like $\int_0^t ds/X_s$ when X is a Bessel process. In fact, we will need to focus on the case where $\delta = 3 - 8/\kappa \in (0, 1]$ and $\beta \in [1, 2)$, where this integral is infinite as soon as X starts touching the origin (this is because $\int_0 dx/x^{\beta/2}$ diverges so that almost surely, $\sum_{\ell \leq 1} J(e_\ell) = \infty$). There are two ways around it this problem. The first one involves the notion of “principle values” and is described in [31]. The other one, which works for all $\delta \in (0, 1]$, is simply to consider the symmetrized Bessel process that chooses its signs at random according to independent fair coin tosses on each excursion. In this case, the integral $\int_0^t ds/X_s$ is not absolutely convergent, but the process $t \mapsto I_t := \int_0^t ds/X_s$ can be nevertheless easily defined (this corresponds exactly to the existence of symmetric α -stable processes for $\alpha \in [1, 2)$, even if α -stable subordinators do not exist when $\alpha \geq 1$). We refer to [31] for a more detailed description of the possible options. What we will need here is that in all these cases, one defines a continuous Markov process $(X_t, I_t)_{t \geq 0}$ such that:

- X is a solution to the SDE (2) when it is away from the origin.
- The Lebesgue measure spent by X at the origin is 0.
- On the set of times where X_t is away from the origin, $t \mapsto I_t$ is differentiable and its derivative is $1/X_t$.
- $(X_t, I_t)_{t \geq 0}$ satisfies the Brownian scaling property.

The way to define an $\text{SLE}(\kappa, \kappa - 6)$ process out of this couple $(X_t, I_t)_{t \geq 0}$ goes as follows: Define for all $t \geq 0$, the continuous process

$$U_t = \sqrt{\kappa}X_t + 2I_t/\sqrt{\kappa}$$

and construct the chordal Loewner chain driven by this function, i.e., solve the Loewner differential equation for all $z \in \mathbb{H}$

$$\partial g_t(z) = 2/(g_t(z) - U_t)$$

started from $g_0(z) = z$ in order to define a random Loewner chain. If we define $O_t = I_t/\sqrt{\kappa}$, then when X_t is away from the origin, i.e., when $U_t \neq O_t$, one has $\partial_t O_t = 2/(O_t - U_t)$, i.e., O_t follows the image of some boundary point under the Loewner flow. Hence, putting our various equations together (definitions of X_t , I_t , O_t , and the relation between κ and δ), we get that on the set of times where $O_t \neq U_t$,

$$dU_t = \sqrt{\kappa}dB_t + (\kappa - 6)\frac{dt}{O_t - U_t} \text{ and } dO_t = \frac{2dt}{O_t - U_t}.$$

This continuous driving function $t \mapsto U_t$ defines a Loewner chain, but it is not clear whether this chain is almost surely generated by a path. However, on those time-intervals where $X_t \neq 0$, the law of $t \mapsto U_t/\sqrt{\kappa}$ is (locally) absolutely continuous to that of a standard Brownian motion, and the Loewner chain is therefore tracing stretches of simple paths during these intervals. In fact, each of these intervals correspond to a *simple loop* traced by the $\text{SLE}(\kappa, \kappa - 6)$ Loewner chain. We can say that the positive excursions of X correspond to anti-clockwise loops while the negative ones correspond to clockwise loops.

We have already mentioned that such chordal $\text{SLE}(\kappa, \kappa - 6)$ chains are of particular interest because of the following properties [30]: They are target-independent, and if $X_t > 0$, then the process locally continues exactly as an SLE_κ targeting $g_t^{-1}(O_t)$. This makes it possible (see [31]) to construct a branching $\text{SLE}(\kappa, \kappa - 6)$ process whose law is invariant under conformal automorphisms of \mathbb{H} that fix the origin. In fact, it is also possible to define a radial version of the $\text{SLE}(\kappa, \kappa - 6)$ process (see [30, 31]) in order to also explore the connected components that are “cut out” without having a point on the boundary of \mathbb{H} . This can be either defined using a “radial-chordal” equivalence (like that of $\text{SLE}(6)$) or viewed as a rather direct consequence of the target-independence of the (chordal) $\text{SLE}(\kappa, \kappa - 6)$ (just interpreting the past of the SLE as new boundary points). The obtained set is then dense in the upper half-plane, and it is therefore possible to define the family of all loops that are traced in this way: these are exactly the CLE_κ defined in [31].

Let us make the following simple observation that will be useful later on: Suppose that z_1 and z_2 are two points in the upper half-plane, and that the (random) time τ at which this (branching) $\text{SLE}(\kappa, \kappa - 6)$ process separates z_1 from z_2 is finite. Then, there are two possible ways in which this can happen:

- Either τ is the end-time of an excursion of X , where the SLE traced a closed loop that surrounds one of the two points but not the other.
- Or the SLE has not yet traced a closed loop that surrounds one of the two points and not the other, but the Loewner chain traced by the paths nevertheless separates the

two points from one another. This can for instance happen if the $\text{SLE}(\kappa, \kappa - 6)$ touches the boundary of the domain at a limit time that occurs after the tracing of infinitely many small loops (recall that the $\text{SLE}(\kappa, \kappa - 6)$ is not a simple path).

7.4 $\text{SLE}(\kappa, \kappa - 6)$ and Poisson point process of pinned loops

The definition of $\text{SLE}(\kappa, \kappa - 6)$ clearly shows that it is possible to reconstruct the process $(X_t, t \geq 0)$ starting from a Poisson point process of (positive) Bessel excursions $(e_\ell)_{\ell \geq 0}$ of the corresponding dimension. More precisely (for the symmetrized Bessel process), one defines also an i.i.d. family $(\varepsilon_\ell)_{\ell \geq 0}$ (with $P(\varepsilon_\ell = 1) = P(\varepsilon_\ell = -1) = 1/2$) of “random signs” and then defines X by concatenating the excursions $(\varepsilon_\ell e_\ell, \ell \geq 0)$. Each individual excursion corresponds to a pinned loop $\tilde{\gamma}_\ell$ in the upper-half plane. In fact, this pinned loop is an SLE excursion, and one has tossed the fair coin in order to decide whether to trace it clockwise or anti-clockwise. Hence, an $\text{SLE}(\kappa, \kappa - 6)$ defines the same Poisson point process of pinned loops $(\tilde{\gamma}_\ell)_{\ell \geq 0}$ with intensity μ as in Section 7.1.

But there is a difference in the way this Poisson point process is used in order to construct the “composition” of the corresponding conformal maps f_ℓ . Here, one does not compose the conformal maps f_ℓ that are normalized to have real derivative at i . Instead, one keeps track of the previous location of the tip of the curve and continues growing from there. More precisely, suppose that a pinned loop $\tilde{\gamma}$ is given, and that one decides to trace it clockwise. Consider the unbounded connected component H of its complement in \mathbb{H} and let $0+$ denote the boundary point of H defined as “the origin seen from the right”. Define the conformal map \tilde{f} from H onto \mathbb{H} such that $\tilde{f}(0+) = 0$ and $\tilde{f}'(i) = i$. If the loop was traced counterclockwise, just replace $0+$ by $0-$ in this definition of \tilde{f} .

Then, if one focuses on the radial $\text{SLE}(\kappa, \kappa - 6)$ only at those times t at which $X_t = 0$ and before it draws a loop surrounding i , we have exactly the iteration of the conformal maps \tilde{f}_ℓ .

In other words, let us define $c_\ell \in (-\pi, \pi]$ in such a way that $\tilde{f}'_\ell(i) = e^{ic_\ell}$; then the difference between the radial SLE exploration procedure and the continuous iteration of maps (f_ℓ) described in Section 7.1 is this “Moebius rotation” at the end of each discovered loop. More precisely, let θ_c denote the Moebius transformation of \mathbb{H} onto itself with $\theta_c(i) = i$ and $\theta'_c(i) = e^{ic}$; then $\tilde{f}_\ell = \theta_{c_\ell} \circ f_\ell$.

This gives a motivation to modify the discrete radial exploration mechanism of a CLE that we used in Lemma 7.1 as follows: After each step, instead of normalizing the maps φ_n^ε at i by $\varphi_n^\varepsilon(i) = i$ and $(\varphi_n^\varepsilon)'(i) > 0$, we use the modified map $\tilde{\varphi}_n^\varepsilon$ defined by $\tilde{\varphi}_n^\varepsilon(i) = 0$ and by tossing a fair coin in order to decide whether $\tilde{\varphi}_n^\varepsilon(-\varepsilon) = 0$ or $\tilde{\varphi}_n^\varepsilon(\varepsilon) = 0$. Because the law of a CLE in \mathbb{H} is invariant under Moebius transformations, this does not change the fact that the $(\tilde{\varphi}_n^\varepsilon)$'s are i.i.d., that N is a geometric random variable with mean $1/u(\varepsilon)$, and that what one discovers at the $(N + 1)$ -th step is independent of the value of N and of the maps $\tilde{\varphi}_1^\varepsilon, \dots, \tilde{\varphi}_N^\varepsilon$.

We would now like to see that this discrete exploration mechanism converges (as $\varepsilon \rightarrow 0$) exactly to the radial $\text{SLE}(\kappa, \kappa - 6)$ procedure described before. We already know from the proof of Lemma 7.1 that if we focus on the discovered pinned loops of radius larger than r (for each fixed r), then the corresponding discovered loops converge in law to the corresponding SLE loops (and that the laws of the corresponding conformal maps therefore converge too). The point is therefore only to check that the effect of all these additional “Moebius rotations”

remains under control (in other words, that it tends to 0 when $r \rightarrow 0$, uniformly with respect to ε). But as we shall now see, this follows from the same arguments that allow us to define symmetrized Bessel processes (respectively symmetric α -stable processes) as almost sure limits of processes obtained by the cut-off of all Bessel excursions of small height or length (resp. the cut-off of all jumps of small size) i.e., it is a straightforward consequence of the fact that $\beta < 2$: For each $n \leq N$, we define φ_n^ε and $\tilde{\varphi}_n^\varepsilon$ as before, and choose c_n^ε in such a way that $\tilde{\varphi}_n^\varepsilon = \theta_{c_n^\varepsilon} \circ \varphi_n^\varepsilon$.

Note that there exists a universal constant such that as soon as $R(\tilde{\gamma}(\varepsilon)) \leq 1/2$, the corresponding c^ε satisfies $|c^\varepsilon| \leq C \times R(\tilde{\gamma}(\varepsilon))$ (because harmonic measure scales like the diameter). It follows, using the independence between the exploration steps, and the symmetry (i.e., the fact that c_1^ε and $-c_1^\varepsilon$ have the same law) that

$$E\left(\sum_{n \leq N} 1_{n \notin \{n_1(r), \dots, n_k(r)\}} c_n^\varepsilon\right)^2 = E(N)E((c_1^\varepsilon)^2 1_{1 \neq n_1(r)}) \leq \frac{C}{u(\varepsilon)} E(R(\tilde{\gamma}(\varepsilon))^2 1_{R(\tilde{\gamma}(\varepsilon)) < r}).$$

We have already shown in the proof of Lemma 7.1 that this last quantity goes to 0 as $r \rightarrow 0$, uniformly with respect to ε . Note also that $m \mapsto \sum_{n \leq \min(m, N)} 1_{n \notin \{n_1(r), \dots, n_k(r)\}} c_n^\varepsilon$ is a martingale. Hence, Doob's inequality ensures that uniformly with respect to ε ,

$$\lim_{r \rightarrow 0^+} E\left(\sup_{m \leq N} \left(\sum_{n \leq m} 1_{n \notin \{n_1(r), \dots, n_k(r)\}} c_n^\varepsilon\right)^2\right) \rightarrow 0.$$

From this, it follows that forgetting or adding these ‘‘rotations’’ to the exploration procedure does not affect it much (in Carathéodory sense, seen from i); one can for instance use the Loewner chain interpretation of this exploration procedures, and the above bound on the supremum of the cumulative rotations implies that the radial Loewner driving functions (with or without these rotations) are very close.

7.5 CLE and the SLE $(\kappa, \kappa - 6)$ exploration tree

In this section, we finally complete the proof of Theorem 1.3 by showing that indeed the loops in CLE necessarily have the same law as the set of loops generated by an SLE $(\kappa, \kappa - 6)$ (as constructed in [31]). As before, it is enough to prove that for every finite set $\{z_1, \dots, z_m\}$ of points in \mathbb{H} , the joint law of the $\gamma(z_j)$ is the same for the CLE as for the CLE_κ loops (more precisely, as the outermost loops surrounding these points in the CLE_κ).

Fix the points $\{z_1, \dots, z_m\}$ in \mathbb{H} and consider a radial SLE $(\kappa, \kappa - 6)$ targeting z_1 , say. We do not know whether SLE $(\kappa, \kappa - 6)$ is a continuous curve, but we recall that it is continuous at times in the interior of the loop-tracing intervals (during the excursions of the Bessel process). For each $t > 0$, the hull of the process $K_t \subset \mathbb{H}$ is compact and its complement $H_t = \mathbb{H} \setminus K_t$ contains z_1 . The chain (K_t) also traces loops as explained before. We define τ to be the first time at which at least one of the points z_2, \dots, z_m is ‘‘swallowed’’ by K_t , i.e. separated from z_1 . We will use K_{t-} to denote $\cup_{s < t} K_s$. Note that by the target invariance property, the law of $(K_t, t < \tau)$ does not depend on the fact that we singled out z_1 i.e., τ is just the first time at which K_{t-} separates the set of m points into at least two parts. As mentioned earlier, the time τ can occur in two different ways: either the SLE has traced a loop surrounding some z_j or it has simply disconnected the domain into two parts.

Lemma 7.3. *Consider the following method of generating a random loop $\tilde{\gamma}(z_j)$ surrounding each z_j .*

1. *For each j , if z_j is surrounded by one of the loops traced by $(K_t, t \leq \tau)$, then we let $\tilde{\gamma}(z_j)$ be that loop.*
2. *In each component of $\mathbb{H} \setminus K_{\tau-}$ that is not surrounded by a loop traced by $(K_t, t \leq \tau)$, we then construct an independent copy of the CLE (conformally mapped to that ensemble), and for each z_j in that component, we let $\tilde{\gamma}(z_j)$ be the loop that surrounds z_j in this CLE.*

Then the set $\{\tilde{\gamma}(z_1), \tilde{\gamma}(z_2), \dots, \tilde{\gamma}(z_m)\}$ agrees in law with $\{\gamma(z_1), \gamma(z_2), \dots, \gamma(z_m)\}$.

Given this lemma, Theorem 1.3 follows immediately by induction. Indeed, suppose that the $\{\tilde{\gamma}(z'_j), j \leq m-1\}$ and $\{\gamma(z'_j), j \leq m-1\}$ agreed in law for all collections of $(z'_j, j \leq m-1)$. By construction, each component of $\mathbb{H} \setminus K_{\tau-}$ has fewer than m points; moreover, conditioned on $(K_t, t \leq \tau)$, the remainder of the branching radial SLE $(\kappa, \kappa-6)$ consists of an independent radial SLE $(\kappa, \kappa-6)$ in each component of $\mathbb{H} \setminus K_{\tau-}$ not surrounded by a loop—by inductive hypothesis, the loops traced by such a process agree in law with the $\tilde{\gamma}(z_j)$.

We now proceed to prove Lemma 7.3.

Proof. First, we claim that is enough to prove (for each given $\delta > 0$) the statement of Lemma 7.3 where the time τ is replaced by τ_δ defined as follows. Let first σ_δ denote the first time at which at least one of the images of the z_j gets within distance δ of U_t . Note that typically, at time σ_δ , the Bessel process X will be in the middle of some excursion away from 0. Then, let τ_δ be the first time t at which either:

1. The SLE $(\kappa, \kappa-6)$ completes a loop that surrounds some z_j .
2. The SLE completes the loop it is tracing at σ_δ (i.e., $t \geq \sigma_\delta$ and $X_t = 0$).

Indeed, we know that each of the loops $\gamma(z_j)$ is at finite distance from the z_j . Hence, almost surely, the conformal radius of $H_{\tau_\delta-}$ from each of the z_j 's remains bounded as $\delta \rightarrow 0$; thus, in the Carathéodory sense seen from z_j , the domain surrounding $H_{\tau_\delta-}$ tends to a limit as $\delta \rightarrow 0$ almost surely (note that the τ_δ increase as δ decreases). It is therefore clear that the law of the $\tilde{\gamma}$'s (conditioned on $K_{\tau_\delta-}$) tends to a limit as $\delta \rightarrow 0$ and also that (by the arguments of Section 7.2) this limit is indeed that of an independent CLE in each of the component of $H_{\tau_\delta-}$.

Now it remains only to prove the claim for these τ_δ . To do this, it suffices to return to the modified radial ϵ -exploration scheme (the one including the c_n^ϵ “rotations”) that we have just defined and studied, and use the fact that for each fixed δ , up to τ_δ , it approximates the continuous mechanism corresponding to the SLE $(\kappa, \kappa-6)$ excursions. \square

8 An open problem

When $\kappa \in (4, 8)$, the CLE $_\kappa$ described in [31] are random collections of non-simple loops. However, the outer boundaries of the sets of points traversed by the outermost loops should

be simple loops. We expect (though this was not established in [31], in part because of the CLE_κ construction was not shown there to be starting-point independent) that these random loop collections will satisfy all of the axioms we used to characterize CLE except that they will a.s. contain loops intersecting one another and the boundary of the domain. Are these the only random loop collections for which this is the case?

This is an apparently difficult type of question. We expect that the constructions of one-point and two-point pinned measures in the present paper will have analogs this non-disjoint setting; however the pinned loop will intersect the boundary at other points as well, and our argument for establishing the connection with SLE does not appear to extend to this setting in a straightforward way. Moreover, we have no direct analog of the loop-soup construction (that constructs CLE_κ for $\kappa \in (8/3, 4]$, see [33]) in the case where $\kappa \in (4, 8)$.

References

- [1] V. Beffara (2008), The Hausdorff dimension of SLE curves, *Ann. Probab.* **36**, 1421-1452.
- [2] A.A. Belavin, A.M. Polyakov, A.B. Zamolodchikov (1984), Infinite conformal symmetry in two-dimensional quantum field theory. *Nuclear Phys. B* **241**, 333–380.
- [3] F. Camia, C. Newman (2006), Two-dimensional critical percolation: The full scaling limit, *Comm. Math. Phys.* **268**, 1-38.
- [4] D. Chelkak, S. Smirnov (2010), in preparation.
- [5] B. Doyon (2009), Conformal loop ensembles and the stress-energy tensor. I. Fundamental notions of CLE, preprint.
- [6] B. Doyon (2009), Conformal loop ensembles and the stress-energy tensor. II. Construction of the stress-energy tensor, preprint.
- [7] J. Dubédat (2009), SLE and the Free Field: Partition functions and couplings, *J. Amer. Math. Soc.* **22**, 995-1054.
- [8] B. Duplantier, S. Sheffield (2008), Liouville Quantum Gravity and KPZ, preprint.
- [9] A. Kemppainen (2009), On Random Planar Curves and Their Scaling Limits., Ph.D. thesis, University of Helsinki.
- [10] W. Kager, B. Nienhuis (2004), A guide to stochastic Löwner evolution and its applications, *J. Stat. Phys.* **115**, 1149-1229
- [11] G.F. Lawler, *Conformally invariant processes in the plane*, Math. Surveys and Monographs, AMS, 2005.
- [12] G.F. Lawler (2009), Schramm-Loewner evolution, in *Statistical Mechanics*, S. Sheffield and T. Spencer, ed., IAS/Park City Mathematical Series, AMS , 231-295.
- [13] G.F. Lawler, O. Schramm, W. Werner (2001), Values of Brownian intersection exponents I: Half-plane exponents, *Acta Mathematica* **187**, 237-273.

- [14] G.F. Lawler, O. Schramm, W. Werner (2001), Values of Brownian intersection exponents II: Plane exponents, *Acta Mathematica* **187**, 275-308.
- [15] G.F. Lawler, O. Schramm, W. Werner (2003), Conformal invariance of planar loop-erased random walks and uniform spanning trees, *Ann. Probab.* **92**, 939-995.
- [16] G.F. Lawler, O. Schramm, W. Werner (2003), Conformal restriction properties. The chordal case, *J. Amer. Math. Soc.* **16**, 917-955.
- [17] G.F. Lawler, W. Werner (2004), The Brownian loop-soup, *Probab. Th. Rel. Fields* **128**, 565-588.
- [18] J.-F. Le Gall, G. Miermont (2009), Scaling limits of random planar maps with large faces. *Ann. Probab.*, to appear
- [19] J. Miller (2010), Fluctuations for the Ginzburg-Landau $\nabla\phi$ Interface Model on a Bounded Domain, preprint.
- [20] J. Miller (2010), Universality for SLE(4), preprint.
- [21] B. Nienhuis (1982), Exact critical exponents for the $O(n)$ models in two dimensions, *Phys. Rev. Lett.* **49**, 1062-1065.
- [22] D. Revuz, M. Yor, *Continuous martingales and Brownian motion*, Springer, 1991.
- [23] S. Rohde, O. Schramm (2005), Basic properties of SLE, *Ann. Math.* **161**, 879-920.
- [24] O. Schramm (2000), Scaling limits of loop-erased random walks and uniform spanning trees, *Israel J. Math.* **118**, 221-288.
- [25] O. Schramm (2001), A Percolation formula, *Electr. Comm. Probab.* **6**, paper no. 12.
- [26] O. Schramm, S. Sheffield (2005), Harmonic explorer and its convergence to SLE4, *Ann. Probab.* **33**, 2127-2148.
- [27] O. Schramm, S. Sheffield (2009), Contour lines of the two-dimensional discrete Gaussian Free Field, *Acta Math.* **202**, 21-137.
- [28] O. Schramm, S. Sheffield, D.B. Wilson (2009), Conformal radii in conformal loop ensembles, *Comm. Math. Phys.* **288**, 43-53.
- [29] O. Schramm, S. Smirnov (2010), On the scaling limits of planar percolation, preprint.
- [30] O. Schramm, D.B. Wilson (2005), SLE coordinate changes, *New York J. Math.* **11**, 659-669.
- [31] S. Sheffield (2009), Exploration trees and conformal loop ensembles, *Duke Math. J.* **147**, 79-129.
- [32] S. Sheffield and N. Sun (2010), Strong path convergence from Loewner driving convergence, preprint.

- [33] S. Sheffield, W. Werner (2010), Conformal Loop Ensembles: Construction via loopsoups, preprint
- [34] S. Smirnov (2001), Critical percolation in the plane: conformal invariance, Cardy's formula, scaling limits, C. R. Acad. Sci. Paris Sér. I Math. **333**, 239-244.
- [35] S. Smirnov (2007), Towards conformal invariance of 2D lattice models, Proc. ICM 2006, vol. 2, 1421-1451.
- [36] S. Smirnov (2010), Conformal invariance in random cluster models. I. Holomorphic fermions in the Ising model, Ann. Math. **172**, to appear.
- [37] S. Smirnov (2007), Conformal invariance in random cluster models. II. Scaling limit of the interface, preprint.
- [38] N. Sun (2010), Conformally invariant scaling limits in planar critical percolation, preprint.
- [39] W. Werner (2004), Random planar curves and Schramm-Loewner Evolutions, in 2002 St-Flour summer school, L.N. Math. **1840**, 107-195.
- [40] W. Werner (2003), SLEs as boundaries of clusters of Brownian loops, C.R. Acad. Sci. Paris, Ser. I Math. **337**, 481-486.
- [41] W. Werner (2005), Conformal restriction and related questions, Probability Surveys **2**, 145-190.
- [42] W. Werner (2006), Some recent aspects of random conformally invariant systems, in Les Houches Summer School, Session LXXXIII, Mathematical statistical mechanics, 57-99, Elsevier.
- [43] W. Werner (2008), The conformally invariant measure on self-avoiding loops, J. Amer. Math. Soc. **21**, 137-169.
- [44] D. Zhan (2008), Reversibility of chordal SLE, Ann. Probab. **36**, 1472-1494.

Department of Mathematics MIT, 2-180
77 Massachusetts Avenue
Cambridge, MA 02139-4307
sheffield@math.mit.edu

Laboratoire de Mathématiques
Université Paris-Sud 11
Bâtiment 425
91405 Orsay Cedex, France
wendelin.werner@math.u-psud.fr