

SUPER DUALITY AND IRREDUCIBLE CHARACTERS OF ORTHO-SYMPLECTIC LIE SUPERALGEBRAS

SHUN-JEN CHENG, NGAU LAM, AND WEIQIANG WANG

ABSTRACT. We formulate and establish a super duality which connects parabolic categories O for the ortho-symplectic Lie superalgebras and classical Lie algebras of BCD types. This provides a complete and conceptual solution of the irreducible character problem for the ortho-symplectic Lie superalgebras in a parabolic category O , which includes all finite dimensional irreducible modules, in terms of classical Kazhdan-Lusztig polynomials.

CONTENTS

1. Introduction	1
2. Lie superalgebras of infinite rank	5
3. Categories \mathcal{O} , $\overline{\mathcal{O}}$ and $\widetilde{\mathcal{O}}$	11
4. The character formulas	14
5. Equivalences of categories	19
6. Finite dimensional representations	22
References	28

1. INTRODUCTION

1.1. Finding the irreducible characters is a fundamental problem in representation theory. As a prototype of this problem, consider a complex semisimple Lie algebra \mathfrak{g} . The problem is solved in two steps, following the historical development:

- (1) The category of finite dimensional \mathfrak{g} -modules is semisimple and the corresponding irreducible \mathfrak{g} -characters are given by Weyl's character formula.
- (2) A general solution to the irreducible character problem in the BGG category O was given much later by the Kazhdan-Lusztig (KL) polynomials (theorems of Beilinson-Bernstein and Brylinski-Kashiwara) [KL, BB, BK].

1.2. The study of Lie superalgebras and their representations was largely motivated by the notion of supersymmetry in physics. A Killing-Cartan type classification of finite dimensional complex simple Lie superalgebras was achieved by Kac [K1] in 1977. The most important subclass of the simple Lie superalgebras (called basic classical), including two infinite series of types A and \mathfrak{osp} , bears a close resemblance to the usual simple Lie algebras, so we can make sense of root systems, Dynkin diagrams, triangular decomposition, Cartan and Borel subalgebras, (parabolic) category O , and so on.

However, the representation theory of Lie superalgebras $\bar{\mathfrak{g}}$ has encountered several substantial difficulties, as made clear by numerous works over the last three decades (cf. [BL, K2, KW, LSS, Pen, dHKT, dJ] as a sample of earlier literature, and some more recent references which can be found in the next paragraph):

- (1) There exist non-conjugate Borel subalgebras for a given Lie superalgebra $\bar{\mathfrak{g}}$.
- (2) The category \mathcal{F} of finite dimensional $\bar{\mathfrak{g}}$ -modules is in general not semisimple. A uniform Weyl type finite dimensional character formula does not exist.
- (3) One has a notion of a Weyl group associated to the even subalgebra of $\bar{\mathfrak{g}}$; however, the linkage in the category \mathcal{O} (or in \mathcal{F}) of $\bar{\mathfrak{g}}$ -modules is not solely controlled by the Weyl group.
- (4) A block in the category \mathcal{O} (or in \mathcal{F}) may contain infinitely many simple objects.

The conventional wisdom of solving the irreducible character problem for Lie superalgebras has been to follow closely the two steps for Lie algebras in 1.1. As the problem is already very difficult in the category \mathcal{F} , there has been little attempt in understanding the category \mathcal{O} .

For type A Lie superalgebra $\mathfrak{gl}(m|n)$, there have been several different general approaches over the years. Serganova [Se] in 1996 developed a mixed geometric and algebraic approach to solving the irreducible character problem in the category \mathcal{F} . Brundan in 2003 [Br] developed a new elegant purely algebraic solution to the same problem in \mathcal{F} using Lusztig-Kashiwara canonical basis. Developing the idea of super duality [CW] (which generalizes [CWZ]) which connects the categories \mathcal{O} for Lie superalgebras and Lie algebras of type A for the first time, two of the authors [CL] very recently established the super duality conjecture therein. In particular they provided a complete solution to the irreducible character problem for a fairly general parabolic category \mathcal{O} (including \mathcal{F} as a very special case) in terms of KL polynomials of type A . Independently, Brundan and Stroppel [BS] proved the super duality conjecture in [CWZ], offering yet another solution of the irreducible character problem in \mathcal{F} .

1.3. The goal of this paper is to formulate and establish a super duality which connects parabolic category \mathcal{O} for Lie superalgebra of type \mathfrak{osp} with parabolic category \mathcal{O} for classical Lie algebras of types BCD , vastly generalizing the type A case of [CWZ, CW, CL]. In particular, it provides a complete solution of the irreducible character problem for \mathfrak{osp} in some suitable parabolic category \mathcal{O} , which includes all finite dimensional irreducibles, in terms of parabolic KL polynomials of BCD types (cf. Deodhar [Deo]).

1.4. Before launching on a detailed explanation of our main ideas below, it is helpful to keep in mind the analogy that the ring of symmetric functions (or its super counterpart) in infinitely many variables carries more symmetries than in finitely many variables, and a truncation process can easily recover finitely many variables. The super duality can be morally thought as a categorification of the standard involution ω on the ring of symmetric functions and it only becomes manifest when the underlying Lie (super)algebras pass to infinite rank. Then truncation functors can be used to recover the finite rank cases which we are originally interested in.

Even though the finite dimensional Lie superalgebras of type \mathfrak{osp} depend on two integers m and n , our view is to fix one and let the other, say n , vary, and so let us

denote an \mathfrak{osp} Lie superalgebra by $\overline{\mathfrak{g}}_n$. By choosing appropriately a Borel and a Levi subalgebra of $\overline{\mathfrak{g}}_n$, we formulate a suitable parabolic category $\overline{\mathcal{O}}_n$ of $\overline{\mathfrak{g}}_n$ -modules. It turns out that there are four natural choices one can make here which correspond to the four Dynkin diagrams $\mathfrak{b}, \mathfrak{b}^\bullet, \mathfrak{c}, \mathfrak{d}$ in 2.1 (the type \mathfrak{a} case has been treated in [CL]). There is a natural sequence of inclusions of Lie superalgebras:

$$\overline{\mathfrak{g}}_1 \subset \overline{\mathfrak{g}}_2 \subset \dots \subset \overline{\mathfrak{g}}_n \subset \dots$$

Let $\overline{\mathfrak{g}} := \bigcup_{n=1}^{\infty} \overline{\mathfrak{g}}_n$. A suitable category $\overline{\mathcal{O}}$ of $\overline{\mathfrak{g}}$ -modules can be identified with the inverse limit $\varprojlim \overline{\mathcal{O}}_n$. On the other hand, we introduce truncation functors $\mathfrak{tr}_n^k : \overline{\mathcal{O}}_k \rightarrow \overline{\mathcal{O}}_n$ for $k > n$, as analogues of the truncation functors studied in algebraic group setting (cf. Donkin [Don]). These truncation functors send parabolic Verma modules to parabolic Vermas or zero and irreducibles to irreducibles or zero. In particular, this allows us to derive the irreducible characters in $\overline{\mathcal{O}}_n$ once we know those in $\overline{\mathcal{O}}$.

Corresponding to each of the above choices of $\overline{\mathfrak{g}}_n$ and $\overline{\mathcal{O}}_n$, we have the Lie algebra counterparts \mathfrak{g}_n and parabolic categories \mathcal{O}_n for positive integers n . Moreover, we have natural inclusions of Lie algebras $\mathfrak{g}_n \subset \mathfrak{g}_{n+1}$, for all n , which allow us to define the Lie algebra $\mathfrak{g} := \bigcup_n \mathfrak{g}_n$ and the parabolic category \mathcal{O} of \mathfrak{g} -modules. Similarly, the category \mathcal{O} can be identified with the inverse limit $\varprojlim \mathcal{O}_n$. In the main body of the paper, we actually replace $\mathfrak{g}, \overline{\mathfrak{g}}$ et cetera by their (trivial) central extensions. The reason is that the truncation functors depend implicitly on a stabilization scalar, which is interpreted conceptually as a level of representations with respect to the central extensions.

To establish a connection between $\overline{\mathcal{O}}$ and \mathcal{O} , we introduce another infinite rank Lie superalgebra $\widetilde{\mathfrak{g}}$ and its parabolic category $\widetilde{\mathcal{O}}$. The Lie superalgebra $\widetilde{\mathfrak{g}}$ contains \mathfrak{g} and $\overline{\mathfrak{g}}$ as natural subalgebras (though not as Levi subalgebras), and this enables us to introduce two natural functors $T : \widetilde{\mathcal{O}} \rightarrow \mathcal{O}$ and $\overline{T} : \widetilde{\mathcal{O}} \rightarrow \overline{\mathcal{O}}$. Using the technique of odd reflections among others, we establish in Section 4 a key property that T and \overline{T} respect the parabolic Verma and irreducible modules, respectively. This result is already sufficient to provide a complete solution of irreducible \mathfrak{osp} -characters in the category $\overline{\mathcal{O}}_n$ in the first half of the paper (by the end of Section 4.4). We remark that the idea of introducing an auxiliary Lie superalgebra $\widetilde{\mathfrak{g}}$ and category $\widetilde{\mathcal{O}}$ has been used in the type A superalgebra setting [CL].

Recall that for the usual category \mathcal{O} of Lie algebras, the KL polynomials were interpreted by Vogan [Vo] in terms of Kostant \mathfrak{u} -homology groups. The \mathfrak{u} -homology groups make perfect sense for Lie superalgebras, and we may take this interpretation as the definition for the otherwise undefined KL polynomials in category \mathcal{O} for Lie superalgebras (cf. Section 1.2 (3)), as Serganova [Se] did in the category \mathcal{F} of $\mathfrak{gl}(m|n)$ -modules. In Section 4.5, we show that the functors T and \overline{T} match the corresponding \mathfrak{u} -homology groups and hence the corresponding KL polynomials (compare [CKW]). Actually the computation in [CKW] of the \mathfrak{u} -homology groups with coefficients in the Lie superalgebra oscillator modules via Howe duality was the first direct supporting evidence for the super duality for \mathfrak{osp} as formulated in this paper.

Section 5 of the paper is devoted to proving that both T and \overline{T} are indeed category equivalences. As a consequence, we have established that the categories \mathcal{O} and $\overline{\mathcal{O}}$ are equivalent, which is called super duality. A technical difference here from [CL] is that

we need to deal with the fact that parabolic Verma modules in $\overline{\mathcal{O}}$ may not have finite composition series. An immediate corollary of the super duality is that any known BGG resolution in the category \mathcal{O} gives rise to a BGG type resolution in the category $\overline{\mathcal{O}}$, and vice versa.

1.5. The finite dimensional irreducible \mathfrak{osp} -modules are of highest weight, and they are classified in terms of the Dynkin labels by Kac [K2]. We note that the finite dimensional irreducible modules of non-integral highest weights are typical and so their characters are known [K2, Theorem 1]. It turns out that a more natural labeling of the remaining finite dimensional irreducible \mathfrak{osp} -modules (of integral highest weights) is given in terms of Young diagrams just as for classical Lie algebras (see e.g. [SW] for such a formulation and a new proof using odd reflections).

As Borel subalgebras are not conjugate to each other, it becomes a nontrivial problem to find the extremal weights, i.e. highest weights with respect to different Borel, of a given finite dimensional irreducible \mathfrak{osp} -module. We provide an elegant and simple answer in terms of a combinatorial notion which we call *block Frobenius coordinates* associated to Young diagrams.

We observe that our solution of the irreducible character problem in $\overline{\mathcal{O}}_n$ includes solutions to all finite dimensional irreducible \mathfrak{osp} -characters.

The category \mathcal{F} for a general \mathfrak{osp} (with the exception of $\mathfrak{osp}(2|2n)$) is not a highest weight category and does not admit an abstract KL theory in the sense of Cline, Parshall and Scott [CPS], as indicated in the case of $\mathfrak{osp}(3|2)$ [Ger, Section 2]. For a completely independent and different approach to the finite dimensional irreducible \mathfrak{osp} -characters in the category \mathcal{F} , see Gruson and Serganova [GS]. The finite dimensional irreducible characters of $\mathfrak{osp}(2|2n)$ were obtained in [dJ]. The finite dimensional irreducible characters of $\mathfrak{osp}(k|2)$ were also computed in [SZ].

1.6. In hindsight, here is how our super duality approach overcomes the difficulties as listed in 1.2.

- (1) The existence of non-conjugate Borel subalgebras for a Lie superalgebra is essential for establishing the properties of the functors T and \overline{T} . Choices of suitable Borel subalgebras are crucial for a formulation of the compatible sequence of categories $\overline{\mathcal{O}}_n$ for $n > 0$.
- (2) The category \mathcal{F} of finite dimensional $\overline{\mathfrak{g}}_n$ -modules does not play any special role in our approach. Even the “natural” $\mathfrak{osp}(M|2n)$ -modules $\mathbb{C}^{M|2n}$ do not correspond well with each other under truncation functors, as they are natural with respect to the “wrong” Borel.
- (3) In the $n \rightarrow \infty$ limit, the linkage in the category $\overline{\mathcal{O}}$ of $\overline{\mathfrak{g}}$ -modules is completely controlled by the Weyl group of the corresponding Lie algebra \mathfrak{g} (which contains the even subalgebra of $\overline{\mathfrak{g}}$ as a subalgebra).
- (4) In the $n \rightarrow \infty$ limit, it is no surprise for a block to contain infinitely many simple objects.

In the extreme cases described in Section 2.3, we indeed obtain an equivalence of module categories between two classical (non-super!) Lie algebras of types C and D of infinite rank at opposite levels. If one is willing to regard $\mathfrak{osp}(1|\infty)$ as classical (recall

that the finite dimensional $\mathfrak{osp}(1|2n)$ -module category is semisimple), there is another equivalence of categories which relates $\mathfrak{osp}(1|\infty)$ to the infinite rank Lie algebra of type B . In this sense, our super duality has a flavor of the Langlands duality.

The super duality approach here can be further adapted to the setting of Kac-Moody superalgebras (including affine superalgebras) and this will shed new light on the irreducible character problem for these superalgebras. The details will appear elsewhere.

It is well known that the proof of KL conjectures involves deep geometric machinery and results on D -modules of flag manifolds. The formulation of super duality suggests potential direct connections on the (super) geometric level behind the categories \mathcal{O} and $\overline{\mathcal{O}}$, which will be very important to develop.

1.7. The paper is organized as follows. In Section 2 the Lie superalgebras \mathfrak{g} , $\overline{\mathfrak{g}}$ and $\widetilde{\mathfrak{g}}$ are defined, with their respective module categories \mathcal{O} , $\overline{\mathcal{O}}$ and $\widetilde{\mathcal{O}}$ introduced in Section 3. In Section 4, we provide a complete solution of the irreducible \mathfrak{osp} character problem in category $\overline{\mathcal{O}}_n$ for all n , including all finite dimensional irreducible \mathfrak{osp} -characters, in terms of the KL polynomials of classical type. We establish in Section 5 equivalence of the categories \mathcal{O} and $\overline{\mathcal{O}}$. Section 6 offers a diagrammatic description of the extremal weights of the finite dimensional irreducible \mathfrak{osp} -modules.

Throughout the paper the symbols \mathbb{Z} , \mathbb{N} , and \mathbb{Z}_+ stand for the sets of all, positive and non-negative integers, respectively. All vector spaces, algebras, tensor products, et cetera, are over the field of complex numbers \mathbb{C} .

Acknowledgment. The first author is partially supported by an NSC-grant and an Academia Sinica Investigator grant, and he thanks NCTS/TPE and the Department of Mathematics of University of Virginia for hospitality and support. The second author is partially supported by an NSC-grant and thanks NCTS/SOUTH. The third author is partially supported by NSF and NSA grants, and he thanks the Institute of Mathematics of Academia Sinica in Taiwan for hospitality and support. The results of the paper were announced by the first author in the AMS meeting at Raleigh in April 2009, and they were presented by the third author in conferences at Ottawa, Canada and Durham, UK in July 2009.

2. LIE SUPERALGEBRAS OF INFINITE RANK

In this section, we introduce infinite rank Lie (super)algebras $\mathfrak{g}^{\mathfrak{r}}$, $\overline{\mathfrak{g}}^{\mathfrak{r}}$ and $\widetilde{\mathfrak{g}}^{\mathfrak{r}}$ associated to the 3 Dynkin diagrams in (2.2) below, where \mathfrak{r} denotes one of the four types \mathfrak{b} , \mathfrak{b}^\bullet , \mathfrak{c} , \mathfrak{d} .

2.1. Dynkin diagrams of $\mathfrak{g}^{\mathfrak{r}}$, $\overline{\mathfrak{g}}^{\mathfrak{r}}$ and $\widetilde{\mathfrak{g}}^{\mathfrak{r}}$. Let $m \in \mathbb{Z}_+$. Consider the free abelian group with basis $\{\epsilon_{-m}, \dots, \epsilon_{-1}\} \cup \{\epsilon_r | r \in \frac{1}{2}\mathbb{N}\}$, with a symmetric bilinear form $(\cdot|\cdot)$ given by

$$(\epsilon_r|\epsilon_s) = (-1)^{2r} \delta_{rs}, \quad r, s \in \{-m, \dots, -1\} \cup \frac{1}{2}\mathbb{N}.$$

We set

$$(2.1) \quad \alpha_x := \epsilon_{-1} - \epsilon_{1/2}, \quad \alpha_j := \epsilon_j - \epsilon_{j+1}, \quad -m \leq j \leq -2,$$

$$\beta_x := \epsilon_{-1} - \epsilon_1, \quad \alpha_r := \epsilon_r - \epsilon_{r+1/2}, \quad \beta_r := \epsilon_r - \epsilon_{r+1}, \quad r \in \frac{1}{2}\mathbb{N}.$$

For $\mathfrak{r} = \mathfrak{b}, \mathfrak{b}^\bullet, \mathfrak{c}, \mathfrak{d}$, we denote by $\mathfrak{k}^\mathfrak{r}$ the contragredient Lie (super)algebras ([K1, Section 2.5]) whose Dynkin diagrams $(\mathfrak{k}^\mathfrak{r})$ together with certain distinguished sets of simple roots $\Pi(\mathfrak{k}^\mathfrak{r})$ are listed as follows:

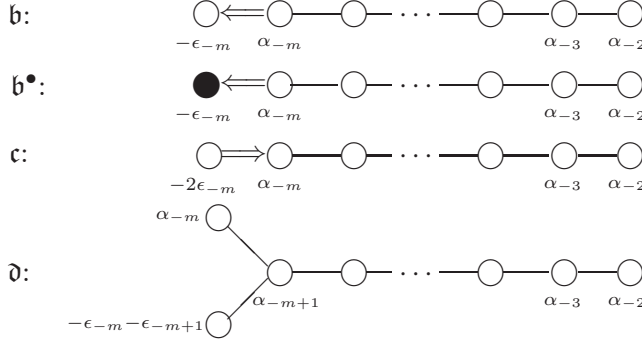

According to [K1, Proposition 2.5.6] these Lie (super)algebras are $\mathfrak{so}(2m+1)$, $\mathfrak{osp}(1|2m)$, $\mathfrak{sp}(2m)$ for $m \geq 1$ and $\mathfrak{so}(2m)$ for $m \geq 2$, respectively. We will use the same notation $(\mathfrak{k}^\mathfrak{r})$ to denote the diagrams of all the degenerate cases for $m = 0, 1$ as well. (See Sections 2.2 and 2.3 below). We have used \bullet to denote an odd non-isotropic simple root. So $\mathfrak{osp}(1|2m)$ is actually a Lie superalgebra (instead of Lie algebra), but it is classical from the super duality viewpoint in this paper.

For $n \in \mathbb{N}$ let (\mathfrak{T}_n) , $(\overline{\mathfrak{T}}_n)$ and $(\widetilde{\mathfrak{T}}_n)$ denote the following Dynkin diagrams, where \otimes denotes an odd isotropic simple root:

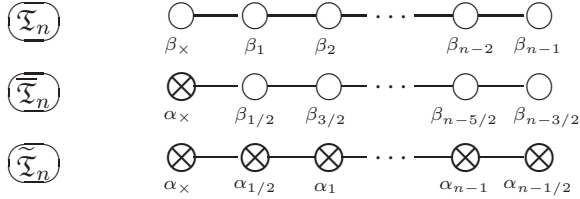

The Lie superalgebras associated with these Dynkin diagrams are $\mathfrak{gl}(n+1)$, $\mathfrak{gl}(1|n)$ and $\mathfrak{gl}(n|n+1)$, respectively. In the limit $n \rightarrow \infty$, the associated Lie superalgebras are direct limits of these Lie superalgebras, and we will simply drop ∞ to write $(\overline{\mathfrak{T}}) = (\overline{\mathfrak{T}}_\infty)$ and so on.

Any of the *head* diagrams $(\mathfrak{k}^\mathfrak{r})$ may be connected with the *tail* diagrams (\mathfrak{T}_n) , $(\overline{\mathfrak{T}}_n)$ and $(\widetilde{\mathfrak{T}}_n)$ to produce the following Dynkin diagrams ($n \in \mathbb{N} \cup \{\infty\}$):

$$(2.2) \quad (\mathfrak{k}^\mathfrak{r}) \text{---} (\mathfrak{T}_n) \qquad (\mathfrak{k}^\mathfrak{r}) \text{---} (\overline{\mathfrak{T}}_n) \qquad (\mathfrak{k}^\mathfrak{r}) \text{---} (\widetilde{\mathfrak{T}}_n)$$

We will denote the sets of simple roots of the above diagrams accordingly by $\Pi_n^\mathfrak{r}$, $\overline{\Pi}_n^\mathfrak{r}$ and $\widetilde{\Pi}_n^\mathfrak{r}$. For $n = \infty$, we also denote the sets of positive roots by $\Phi_+^\mathfrak{r}$, $\overline{\Phi}_+^\mathfrak{r}$ and $\widetilde{\Phi}_+^\mathfrak{r}$, and the sets of roots by $\Phi^\mathfrak{r}$, $\overline{\Phi}^\mathfrak{r}$ and $\widetilde{\Phi}^\mathfrak{r}$, respectively.

2.2. Realization. Let us denote the 3 Dynkin diagrams of (2.2) at $n = \infty$ by $\overline{\mathfrak{g}^t}$, $\widetilde{\mathfrak{g}^t}$ and $\widetilde{\mathfrak{g}^t}$. We provide a realization for the corresponding Lie superalgebras.

For $m \in \mathbb{Z}_+$ consider the following totally ordered set \mathbb{I}_m

$$\cdots < \frac{3}{2} < \bar{1} < \frac{\bar{1}}{2} < \underbrace{\overline{-1} < \overline{-2} < \cdots < \overline{-m}}_m < \bar{0} < \underbrace{-m < \cdots < -1}_m < \frac{1}{2} < 1 < \frac{3}{2} < \cdots$$

For $m \in \mathbb{Z}_+$ define the following subsets of \mathbb{I}_m :

$$\begin{aligned} \mathbb{I}_m &:= \underbrace{\{\overline{-1}, \dots, \overline{-m}\}}_m \cup \underbrace{\{\overline{-m}, \dots, -1\}}_m \cup \{\bar{1}, \bar{2}, \bar{3}, \dots\} \cup \{1, 2, 3, \dots\}, \\ \bar{\mathbb{I}}_m &:= \underbrace{\{\overline{-1}, \dots, \overline{-m}\}}_m \cup \underbrace{\{\overline{-m}, \dots, -1\}}_m \cup \left\{ \frac{\bar{1}}{2}, \frac{\bar{3}}{2}, \frac{\bar{5}}{2}, \dots \right\} \cup \left\{ \frac{1}{2}, \frac{3}{2}, \frac{5}{2}, \dots \right\}, \\ \widetilde{\mathbb{I}}_m^+ &:= \{-m, \dots, -1, \frac{1}{2}, 1, \frac{3}{2}, 2, \dots\}. \end{aligned}$$

For a subset \mathbb{X} of \mathbb{I}_m , define $\mathbb{X}^\times := \mathbb{X} \setminus \{\bar{0}\}$, $\mathbb{X}^+ := \mathbb{X} \cap \widetilde{\mathbb{I}}_m^+$.

2.2.1. General linear Lie superalgebra. For a homogeneous element v in a super vector space $V = V_{\bar{0}} \oplus V_{\bar{1}}$ we denote by $|v|$ its \mathbb{Z}_2 -degree.

For $m \in \mathbb{Z}_+$ consider the infinite dimensional super space \widetilde{V}_m over \mathbb{C} with ordered basis $\{v_i | i \in \mathbb{I}_m\}$. We declare $|v_r| = |v_{\bar{r}}| = \bar{0}$, if $r \in \mathbb{Z} \setminus \{0\}$, and $|v_r| = |v_{\bar{r}}| = \bar{1}$, if $r \in \frac{1}{2} + \mathbb{Z}_+$. The parity of the vector $v_{\bar{0}}$ is to be specified. With respect to this basis a linear map on \widetilde{V}_m may be identified with a complex matrix $(a_{rs})_{r,s \in \mathbb{I}_m}$. The Lie superalgebra $\mathfrak{gl}(\widetilde{V}_m)$ is the Lie subalgebra of linear transformations on \widetilde{V}_m consisting of (a_{rs}) with $a_{rs} = 0$ for all but finitely many a_{rs} 's. Denote by $E_{rs} \in \mathfrak{gl}(\widetilde{V}_m)$ the elementary matrix with 1 at the r th row and s th column and zero elsewhere.

The vector spaces V_m and \bar{V}_m are defined to be subspaces of \widetilde{V}_m with ordered basis $\{v_i\}$ indexed by \mathbb{I}_m and $\bar{\mathbb{I}}_m$, respectively. The corresponding subspaces of V_m , \bar{V}_m and \widetilde{V}_m with basis vectors v_i , with i indexed by \mathbb{I}_m^\times , $\bar{\mathbb{I}}_m^\times$ and $\widetilde{\mathbb{I}}_m^\times$, respectively, are denoted by V_m^\times , \bar{V}_m^\times and \widetilde{V}_m^\times , respectively. This gives rise to Lie superalgebras $\mathfrak{gl}(V_m)$, $\mathfrak{gl}(\bar{V}_m)$, $\mathfrak{gl}(V_m^\times)$, $\mathfrak{gl}(\bar{V}_m^\times)$ and $\mathfrak{gl}(\widetilde{V}_m^\times)$.

Let W be one of the spaces $\widetilde{V}_m, \widetilde{V}_m^\times, V_m, V_m^\times, \bar{V}_m$ or \bar{V}_m^\times . The standard Cartan subalgebra of $\mathfrak{gl}(W)$ is spanned by the basis $\{E_{rr}\}$, with corresponding dual basis $\{\epsilon_r\}$, where r runs over the index sets $\mathbb{I}_m, \bar{\mathbb{I}}_m^\times, \mathbb{I}_m, \mathbb{I}_m^\times, \bar{\mathbb{I}}_m, \bar{\mathbb{I}}_m^\times$, respectively.

2.2.2. Skew-supersymmetric bilinear form on W . In this subsection we set $|v_{\bar{0}}| = \bar{1}$. For $m \in \mathbb{Z}_+$ define a non-degenerate skew-supersymmetric bilinear form $(\cdot | \cdot)$ on \widetilde{V}_m by

$$(2.3) \quad \begin{aligned} (v_r | v_s) &= (v_{\bar{r}} | v_{\bar{s}}) = 0, & (v_r | v_{\bar{s}}) &= \delta_{rs} = -(-1)^{|v_r| |v_s|} (v_{\bar{s}} | v_r), & r, s &\in \widetilde{\mathbb{I}}_m^+, \\ (v_{\bar{0}} | v_{\bar{0}}) &= 1, & (v_{\bar{0}} | v_r) &= (v_{\bar{0}} | v_{\bar{r}}) = 0, & r &\in \widetilde{\mathbb{I}}_m^+. \end{aligned}$$

Restricting the form to $\widetilde{V}_m^\times, V_m, V_m^\times, \bar{V}_m$ and \bar{V}_m^\times gives rise to non-degenerate skew-supersymmetric bilinear forms that will again be denoted by $(\cdot | \cdot)$.

Let W be as before. The Lie superalgebra $\mathfrak{spo}(W)$ is the subalgebra of $\mathfrak{gl}(W)$ preserving the bilinear form $(\cdot|\cdot)$. The standard Cartan subalgebra of $\mathfrak{spo}(W)$ is spanned by the basis $\{E_r := E_{rr} - E_{\bar{r},\bar{r}}\}$, with corresponding dual basis $\{\epsilon_r\}$. We have the following realizations of the corresponding Lie superalgebras for $\mathfrak{r} = \mathfrak{b}^\bullet, \mathfrak{c}$ and $m > 0$:

TABLE 1

Lie superalgebra	Dynkin diagram	Lie superalgebra	Dynkin diagram
$\mathfrak{spo}(\tilde{V}_m)$	$\begin{array}{c} \textcircled{\tilde{\mathfrak{g}}^{\mathfrak{b}^\bullet}} \end{array}$	$\mathfrak{spo}(\tilde{V}_m^\times)$	$\begin{array}{c} \textcircled{\tilde{\mathfrak{g}}^{\mathfrak{c}}} \end{array}$
$\mathfrak{spo}(V_m)$	$\begin{array}{c} \textcircled{\mathfrak{g}^{\mathfrak{b}^\bullet}} \end{array}$	$\mathfrak{spo}(V_m^\times)$	$\begin{array}{c} \textcircled{\mathfrak{g}^{\mathfrak{c}}} \end{array}$
$\mathfrak{spo}(\bar{V}_m)$	$\begin{array}{c} \textcircled{\bar{\mathfrak{g}}^{\mathfrak{b}^\bullet}} \end{array}$	$\mathfrak{spo}(\bar{V}_m^\times)$	$\begin{array}{c} \textcircled{\bar{\mathfrak{g}}^{\mathfrak{c}}} \end{array}$

The sets $\Pi^{\mathfrak{r}}, \bar{\Pi}^{\mathfrak{r}}$ and $\tilde{\Pi}^{\mathfrak{r}}$ give rise to the following sets of positive roots:

$$\begin{aligned} \tilde{\Phi}_+^{\mathfrak{b}^\bullet} &= \{\pm\epsilon_r - \epsilon_s | r < s \ (r, s \in \tilde{\mathbb{I}}_m^+)\} \cup \{-2\epsilon_i \ (i \in \mathbb{I}_m^+)\} \cup \{-\epsilon_r \ (r \in \tilde{\mathbb{I}}_m^+)\}, \\ \tilde{\Phi}_+^{\mathfrak{c}} &= \{\pm\epsilon_r - \epsilon_s | r < s \ (r, s \in \tilde{\mathbb{I}}_m^+)\} \cup \{-2\epsilon_i \ (i \in \mathbb{I}_m^+)\}, \\ \Phi_+^{\mathfrak{b}^\bullet} &= \{\pm\epsilon_i - \epsilon_j | i < j \ (i, j \in \mathbb{I}_m^+)\} \cup \{-\epsilon_i, -2\epsilon_i \ (i \in \mathbb{I}_m^+)\}, \\ \Phi_+^{\mathfrak{c}} &= \{\pm\epsilon_i - \epsilon_j | i < j \ (i, j \in \mathbb{I}_m^+)\} \cup \{-2\epsilon_i \ (i \in \mathbb{I}_m^+)\}, \\ \bar{\Phi}_+^{\mathfrak{b}^\bullet} &= \{\pm\epsilon_r - \epsilon_s | r < s \ (r, s \in \bar{\mathbb{I}}_m^+)\} \cup \{-2\epsilon_i \ (-m \leq i \leq -1)\} \cup \{-\epsilon_r \ (r \in \bar{\mathbb{I}}_m^+)\}, \\ \bar{\Phi}_+^{\mathfrak{c}} &= \{\pm\epsilon_r - \epsilon_s | r < s \ (r, s \in \bar{\mathbb{I}}_m^+)\} \cup \{-2\epsilon_i \ (-m \leq i \leq -1)\}. \end{aligned}$$

The corresponding subsets of simple roots can be read off from the corresponding diagrams in (2.2) (here we recall the notation of roots α 's and β 's from (2.1)).

2.2.3. Supersymmetric bilinear form on W . Let W be as before. In this subsection we set $|v_{\bar{0}}| = \bar{0}$. Define a supersymmetric bilinear form $(\cdot|\cdot)$ on \tilde{V}_m by

$$(2.4) \quad \begin{aligned} (v_r|v_s) &= (v_{\bar{r}}|v_{\bar{s}}) = 0, & (v_r|v_{\bar{s}}) &= \delta_{rs} = (-1)^{|v_r||v_s|} (v_{\bar{s}}|v_r), & r, s &\in \tilde{\mathbb{I}}_m^+, \\ (v_{\bar{0}}|v_{\bar{0}}) &= 1, & (v_{\bar{0}}|v_r) &= (v_{\bar{0}}|v_{\bar{r}}) = 0, & r &\in \tilde{\mathbb{I}}_m^+. \end{aligned}$$

Restricting the form to $\tilde{V}_m^\times, V_m, V_m^\times, \bar{V}_m$ and \bar{V}_m^\times gives respective non-degenerate supersymmetric bilinear forms that will also be denoted by $(\cdot|\cdot)$. The Lie superalgebra $\mathfrak{osp}(W)$ is the subalgebra of $\mathfrak{gl}(W)$ preserving the respective bilinear form determined by (2.4). The standard Cartan subalgebra of $\mathfrak{osp}(W)$ is also spanned by the basis $\{E_r := E_{rr} - E_{\bar{r},\bar{r}}\}$, with corresponding dual basis $\{\epsilon_r\}$. We have the following realizations of the corresponding Lie superalgebras for $\mathfrak{r} = \mathfrak{b}, \mathfrak{d}$ and $m > 0$:

TABLE 2

Lie superalgebra	Dynkin diagram	Lie superalgebra	Dynkin diagram
$\mathfrak{osp}(\tilde{V}_m)$	$\begin{array}{c} \textcircled{\tilde{\mathfrak{g}}^{\mathfrak{b}}} \end{array}$	$\mathfrak{osp}(\tilde{V}_m^\times)$	$\begin{array}{c} \textcircled{\tilde{\mathfrak{g}}^{\mathfrak{d}}} \end{array}$
$\mathfrak{osp}(V_m)$	$\begin{array}{c} \textcircled{\mathfrak{g}^{\mathfrak{b}}} \end{array}$	$\mathfrak{osp}(V_m^\times)$	$\begin{array}{c} \textcircled{\mathfrak{g}^{\mathfrak{d}}} \end{array}$
$\mathfrak{osp}(\bar{V}_m)$	$\begin{array}{c} \textcircled{\bar{\mathfrak{g}}^{\mathfrak{b}}} \end{array}$	$\mathfrak{osp}(\bar{V}_m^\times)$	$\begin{array}{c} \textcircled{\bar{\mathfrak{g}}^{\mathfrak{d}}} \end{array}$

The sets $\Pi^{\mathfrak{f}}$, $\overline{\Pi}^{\mathfrak{f}}$ and $\widetilde{\Pi}^{\mathfrak{f}}$ give rise to the following sets of positive roots:

$$\begin{aligned}\widetilde{\Phi}_+^{\mathfrak{b}} &= \{\pm\epsilon_r - \epsilon_s | r < s \ (r, s \in \widetilde{\mathbb{I}}_m^+)\} \cup \{-2\epsilon_s \ (s \in \overline{\mathbb{I}}_0^+)\} \cup \{-\epsilon_r \ (r \in \widetilde{\mathbb{I}}_m^+)\}, \\ \widetilde{\Phi}_+^{\mathfrak{d}} &= \{\pm\epsilon_r - \epsilon_s | r < s \ (r, s \in \widetilde{\mathbb{I}}_m^+)\} \cup \{-2\epsilon_s \ (s \in \overline{\mathbb{I}}_0^+)\}, \\ \Phi_+^{\mathfrak{b}} &= \{\pm\epsilon_i - \epsilon_j | i < j \ (i, j \in \mathbb{I}_m^+)\} \cup \{-\epsilon_i \ (i \in \mathbb{I}_m^+)\}, \\ \Phi_+^{\mathfrak{d}} &= \{\pm\epsilon_i - \epsilon_j | i < j \ (i, j \in \mathbb{I}_m^+)\}, \\ \overline{\Phi}_+^{\mathfrak{b}} &= \{\pm\epsilon_r - \epsilon_s | r < s \ (r, s \in \overline{\mathbb{I}}_m^+)\} \cup \{-2\epsilon_s \ (s \in \overline{\mathbb{I}}_0^+)\} \cup \{-\epsilon_r \ (r \in \overline{\mathbb{I}}_m^+)\}, \\ \overline{\Phi}_+^{\mathfrak{d}} &= \{\pm\epsilon_r - \epsilon_s | r < s \ (r, s \in \overline{\mathbb{I}}_m^+)\} \cup \{-2\epsilon_s \ (s \in \overline{\mathbb{I}}_0^+)\}.\end{aligned}$$

Again, the subsets of simple roots can be read off from the corresponding diagrams in (2.2).

2.3. The case $m = 0$. The Dynkin diagrams of $\mathfrak{spo}(W)$ with a distinguished set of simple roots, for $W = \widetilde{V}_0, \widetilde{V}_0^\times, V_0, V_0^\times, \overline{V}_0, \overline{V}_0^\times$ are listed in order as follows (see also Remark 2.1 below):

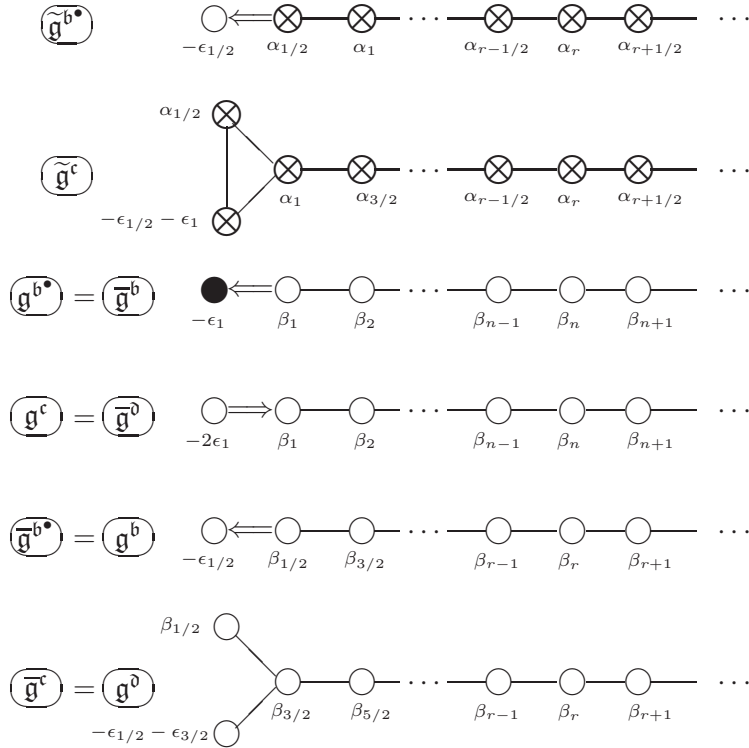

For the sake of completeness we also list the corresponding sets of positive roots.

$$\begin{aligned}\tilde{\Phi}_+^{\mathfrak{b}^\bullet} &= \{\pm\epsilon_r - \epsilon_s | r < s \ (r, s \in \tilde{\mathbb{I}}_0^+)\} \cup \{-2\epsilon_i \ (i \in \mathbb{I}_0^+)\} \cup \{-\epsilon_r \ (r \in \tilde{\mathbb{I}}_0^+)\}, \\ \tilde{\Phi}_+^{\mathfrak{c}} &= \{\pm\epsilon_r - \epsilon_s | r < s \ (r, s \in \tilde{\mathbb{I}}_0^+)\} \cup \{-2\epsilon_i \ (i \in \mathbb{I}_0^+)\}, \\ \Phi_+^{\mathfrak{b}^\bullet} &= \{\pm\epsilon_i - \epsilon_j | i < j \ (i, j \in \mathbb{I}_0^+)\} \cup \{-\epsilon_i, -2\epsilon_i \ (i \in \mathbb{I}_0^+)\}, \\ \Phi_+^{\mathfrak{c}} &= \{\pm\epsilon_i - \epsilon_j | i < j \ (i, j \in \mathbb{I}_0^+)\} \cup \{-2\epsilon_i \ (i \in \mathbb{I}_0^+)\}, \\ \overline{\Phi}_+^{\mathfrak{b}^\bullet} &= \{\pm\epsilon_r - \epsilon_s | r < s \ (r, s \in \overline{\mathbb{I}}_0^+)\} \cup \{-\epsilon_r \ (r \in \overline{\mathbb{I}}_0^+)\}, \\ \overline{\Phi}_+^{\mathfrak{c}} &= \{\pm\epsilon_r - \epsilon_s | r < s \ (r, s \in \overline{\mathbb{I}}_0^+)\}.\end{aligned}$$

Remark 2.1. It is easy to see that we have the following isomorphisms of Lie superalgebras with identical Dynkin diagrams: $\mathfrak{osp}(V_0) \cong \mathfrak{spo}(\overline{V}_0)$, $\mathfrak{osp}(\overline{V}_0) \cong \mathfrak{spo}(V_0)$, $\mathfrak{osp}(V_0^\times) \cong \mathfrak{spo}(\overline{V}_0^\times)$, $\mathfrak{osp}(\overline{V}_0^\times) \cong \mathfrak{spo}(V_0^\times)$.

2.4. Central extensions. We will replace the above matrix realization of the Lie superalgebras with Dynkin diagrams $\textcircled{\mathfrak{g}^\mathfrak{r}}$, $\textcircled{\overline{\mathfrak{g}}^\mathfrak{r}}$ and $\textcircled{\tilde{\mathfrak{g}}^\mathfrak{r}}$ by their central extensions, for $\mathfrak{r} = \mathfrak{b}, \mathfrak{b}^\bullet, \mathfrak{c}, \mathfrak{d}$. These central extensions will be convenient and conceptual for later formulation of truncation functors and super duality.

Let $m \in \mathbb{Z}_+$. Consider the central extension $\widehat{\mathfrak{gl}}(\tilde{V}_m)$ of $\mathfrak{gl}(\tilde{V}_m)$ by the one-dimensional center $\mathbb{C}K$ determined by the 2-cocycle

$$\tau(A, B) := \text{Str}([\mathfrak{J}, A]B), \quad A, B \in \mathfrak{gl}(\tilde{V}_m),$$

where $\mathfrak{J} = E_{00} + \sum_{r \leq \frac{1}{2}} E_{rr}$ and Str denotes the supertrace. Observe that the cocycle τ is a coboundary. Indeed, as a vector space, $\widehat{\mathfrak{gl}}(\tilde{V}_m) = \mathfrak{gl}(\tilde{V}_m) \oplus \mathbb{C}K$, and let us denote by \widehat{X} for $X \in \mathfrak{gl}(\tilde{V}_m)$ to indicate that it is in $\widehat{\mathfrak{gl}}(\tilde{V}_m)$. Then the map from $\widehat{\mathfrak{gl}}(\tilde{V}_m)$ to the direct sum of Lie superalgebras $\mathfrak{gl}(\tilde{V}_m) \oplus \mathbb{C}K$, which sends \widehat{X} to $X' := X - \text{Str}(\mathfrak{J}X)K$, is an algebra isomorphism, i.e., $[X', Y'] = [X, Y]' + \tau(X, Y)K$.

For $W = \tilde{V}_m^\times, V_m, V_m^\times, \overline{V}_m, \overline{V}_m^\times$ the restrictions of τ to the subalgebras $\mathfrak{gl}(W)$ give rise to respective central extensions, which in turn induce central extensions on $\mathfrak{osp}(W)$ and $\mathfrak{spo}(W)$. We denote such a central extension of $\mathfrak{spo}(W)$ or $\mathfrak{osp}(W)$ by $\mathfrak{g}^\mathfrak{r}$ (respectively, $\overline{\mathfrak{g}}^\mathfrak{r}$ and $\tilde{\mathfrak{g}}^\mathfrak{r}$) when it corresponds to the Dynkin diagram $\textcircled{\mathfrak{g}^\mathfrak{r}}$ in Tables 1 and 2 (respectively, $\textcircled{\overline{\mathfrak{g}}^\mathfrak{r}}$ and $\textcircled{\tilde{\mathfrak{g}}^\mathfrak{r}}$).

We make a trivial yet crucial observation that $\mathfrak{g}^\mathfrak{r}$ and $\overline{\mathfrak{g}}^\mathfrak{r}$ are naturally subalgebras of $\tilde{\mathfrak{g}}^\mathfrak{r}$. The standard Cartan subalgebras of $\mathfrak{g}^\mathfrak{r}$, $\overline{\mathfrak{g}}^\mathfrak{r}$ and $\tilde{\mathfrak{g}}^\mathfrak{r}$ will be denoted by $\mathfrak{h}^\mathfrak{r}$, $\overline{\mathfrak{h}}^\mathfrak{r}$ and $\tilde{\mathfrak{h}}^\mathfrak{r}$, respectively. $\mathfrak{h}^\mathfrak{r}$, $\overline{\mathfrak{h}}^\mathfrak{r}$ or $\tilde{\mathfrak{h}}^\mathfrak{r}$ has a basis $\{K, \widehat{E}_r\}$ with dual basis $\{\Lambda_0, \epsilon_r\}$ in the restricted dual $(\mathfrak{h}^\mathfrak{r})^*$, $(\overline{\mathfrak{h}}^\mathfrak{r})^*$ or $(\tilde{\mathfrak{h}}^\mathfrak{r})^*$, where r runs over the index sets \mathbb{I}_m^+ , $\overline{\mathbb{I}}_m^+$ or $\tilde{\mathbb{I}}_m^+$, respectively. Here Λ_0 is defined by letting

$$\Lambda_0(K) = 1, \quad \Lambda_0(\widehat{E}_r) = 0,$$

for all relevant r in each case.

In the remainder of the paper we shall drop the superscript \mathfrak{r} . For example, we write \mathfrak{g} , $\overline{\mathfrak{g}}$ and $\tilde{\mathfrak{g}}$ for $\mathfrak{g}^\mathfrak{r}$, $\overline{\mathfrak{g}}^\mathfrak{r}$ and $\tilde{\mathfrak{g}}^\mathfrak{r}$, with associated Dynkin diagrams $\textcircled{\mathfrak{g}}$, $\textcircled{\overline{\mathfrak{g}}}$ and $\textcircled{\tilde{\mathfrak{g}}}$, respectively, where \mathfrak{r} denotes a fixed type among $\mathfrak{b}, \mathfrak{b}^\bullet, \mathfrak{c}, \mathfrak{d}$.

3. CATEGORIES \mathcal{O} , $\overline{\mathcal{O}}$ AND $\widetilde{\mathcal{O}}$

In this section, we first introduce the categories \mathcal{O} , $\overline{\mathcal{O}}$ and $\widetilde{\mathcal{O}}$ of \mathfrak{g} -modules, $\overline{\mathfrak{g}}$ -modules and $\widetilde{\mathfrak{g}}$ -modules, respectively. Then we study the truncation functors which relate $\overline{\mathfrak{g}}$ to finite dimensional Lie superalgebras of \mathfrak{osp} type.

Let $m \in \mathbb{Z}_+$ be fixed.

3.1. The weights. We fix an arbitrary subset Y_0 of $\Pi(\mathfrak{k})$.

Let Y , \overline{Y} and \widetilde{Y} be the union of Y_0 and the subset of simple roots of $\overline{\mathfrak{g}}$, $\overline{\mathfrak{g}}$ and $\widetilde{\mathfrak{g}}$, respectively, with the leftmost one removed. We have $Y_0 = \emptyset$ for $m = 0$. As Y , \overline{Y} and \widetilde{Y} are fixed, we will make the convention of suppressing them from notations below. Set \mathfrak{l} , $\overline{\mathfrak{l}}$ and $\widetilde{\mathfrak{l}}$ to be the standard Levi subalgebras of \mathfrak{g} , $\overline{\mathfrak{g}}$ and $\widetilde{\mathfrak{g}}$ corresponding to the subsets Y , \overline{Y} and \widetilde{Y} , respectively. The Borel subalgebras of \mathfrak{g} , $\overline{\mathfrak{g}}$ and $\widetilde{\mathfrak{g}}$, spanned by the central element K and upper triangular matrices, are denoted by \mathfrak{b} , $\overline{\mathfrak{b}}$ and $\widetilde{\mathfrak{b}}$, respectively. Let $\mathfrak{p} = \mathfrak{l} + \mathfrak{b}$, $\overline{\mathfrak{p}} = \overline{\mathfrak{l}} + \overline{\mathfrak{b}}$ and $\widetilde{\mathfrak{p}} = \widetilde{\mathfrak{l}} + \widetilde{\mathfrak{b}}$ be the corresponding parabolic subalgebras with nilradicals \mathfrak{u} , $\overline{\mathfrak{u}}$ and $\widetilde{\mathfrak{u}}$ and opposite nilradicals \mathfrak{u}_- , $\overline{\mathfrak{u}}_-$ and $\widetilde{\mathfrak{u}}_-$, respectively.

Given a partition $\mu = (\mu_1, \mu_2, \dots)$, we denote by $\ell(\mu)$ the length of μ and by μ' its conjugate partition. We also denote by $\theta(\mu)$ the modified Frobenius coordinates of μ :

$$\theta(\mu) := (\theta(\mu)_{1/2}, \theta(\mu)_1, \theta(\mu)_{3/2}, \theta(\mu)_2, \dots),$$

where

$$\theta(\mu)_{i-1/2} := \max\{\mu'_i - i + 1, 0\}, \quad \theta(\mu)_i := \max\{\mu_i - i, 0\}, \quad i \in \mathbb{N}.$$

Let $\lambda_{-m}, \dots, \lambda_{-1} \in \mathbb{C}$ and λ^+ be a partition. The tuple $(\lambda_{-m}, \dots, \lambda_{-1}; \lambda^+)$ is said to satisfy a dominant condition if $\langle \sum_{i=-m}^{-1} \lambda_i \epsilon_i, h_\alpha \rangle \in \mathbb{Z}_+$ for all $\alpha \in Y_0$, where h_α denotes the coroot of α . Associated to such a dominant tuple and each $d \in \mathbb{C}$, we define the weights (which will be called *dominant*)

$$(3.1) \quad \lambda := \sum_{i=-m}^{-1} \lambda_i \epsilon_i + \sum_{j \in \mathbb{N}} \lambda_j^+ \epsilon_j + d\Lambda_0 \in \mathfrak{h}^*,$$

$$(3.2) \quad \lambda^\natural := \sum_{i=-m}^{-1} \lambda_i \epsilon_i + \sum_{s \in \frac{1}{2} + \mathbb{Z}_+} (\lambda^+)_{s+\frac{1}{2}}' \epsilon_s + d\Lambda_0 \in \overline{\mathfrak{h}}^*,$$

$$(3.3) \quad \lambda^\theta := \sum_{i=-m}^{-1} \lambda_i \epsilon_i + \sum_{r \in \frac{1}{2}\mathbb{N}} \theta(\lambda^+)_{r} \epsilon_r + d\Lambda_0 \in \widetilde{\mathfrak{h}}^*.$$

We denote by $P^+ \subset \mathfrak{h}^*$, $\overline{P}^+ \subset \overline{\mathfrak{h}}^*$ and $\widetilde{P}^+ \subset \widetilde{\mathfrak{h}}^*$ the sets of all dominant weights of the form (3.1), (3.2) and (3.3) for all $d \in \mathbb{C}$, respectively. By definition we have bijective maps

$$\begin{aligned} \natural : P^+ &\longrightarrow \overline{P}^+, & \lambda &\mapsto \lambda^\natural, \\ \theta : P^+ &\longrightarrow \widetilde{P}^+, & \lambda &\mapsto \lambda^\theta. \end{aligned}$$

For $\mu \in P^+$, let $L(\mathfrak{l}, \mu)$ denote the highest weight irreducible \mathfrak{l} -module of highest weight μ . We extend $L(\mathfrak{l}, \mu)$ to a \mathfrak{p} -module by letting \mathfrak{u} act trivially. Define as usual the parabolic Verma module $\Delta(\mu)$ and its irreducible quotient $L(\mu)$ over \mathfrak{g} :

$$\Delta(\mu) := \text{Ind}_{\mathfrak{p}}^{\mathfrak{g}} L(\mathfrak{l}, \mu), \quad \Delta(\mu) \twoheadrightarrow L(\mu).$$

Similarly, for $\mu \in P^+$, we define the irreducible $\bar{\mathfrak{l}}$ -module $L(\bar{\mathfrak{l}}, \mu^{\natural})$, the parabolic Verma $\bar{\mathfrak{g}}$ -module $\bar{\Delta}(\mu^{\natural})$ and its irreducible $\bar{\mathfrak{g}}$ -quotient $\bar{L}(\mu^{\natural})$, as well as the irreducible $\tilde{\mathfrak{l}}$ -module $L(\tilde{\mathfrak{l}}, \mu^{\theta})$, the parabolic Verma $\tilde{\mathfrak{g}}$ -module $\tilde{\Delta}(\mu^{\theta})$ and its irreducible $\tilde{\mathfrak{g}}$ -quotient $\tilde{L}(\mu^{\theta})$.

3.2. The categories \mathcal{O} , $\bar{\mathcal{O}}$ and $\tilde{\mathcal{O}}$.

Lemma 3.1. *Let $\mu \in P^+$.*

- (i) *The restrictions to \mathfrak{l} of the \mathfrak{g} -modules $\Delta(\mu)$ and $L(\mu)$ decompose into direct sums of $L(\mathfrak{l}, \nu)$ for $\nu \in P^+$.*
- (ii) *The restrictions to $\bar{\mathfrak{l}}$ of the $\bar{\mathfrak{g}}$ -modules $\bar{\Delta}(\mu^{\natural})$ and $\bar{L}(\mu^{\natural})$ decompose into direct sums of $L(\bar{\mathfrak{l}}, \nu^{\natural})$ for $\nu \in P^+$.*
- (iii) *The restrictions to $\tilde{\mathfrak{l}}$ of the $\tilde{\mathfrak{g}}$ -modules $\tilde{\Delta}(\mu^{\theta})$ and $\tilde{L}(\mu^{\theta})$ decompose into direct sums of $L(\tilde{\mathfrak{l}}, \nu^{\theta})$ for $\nu \in P^+$.*

Proof. Part (i) is clear.

The proofs of (ii) and (iii) are analogous, and so we shall only give the proof for (ii). The $\bar{\mathfrak{l}}$ -module $\bar{\mathfrak{u}}_-$ is a direct sum of irreducible modules of the form $L(\bar{\mathfrak{l}}, \nu^{\natural})$. Now the category of $\bar{\mathfrak{l}}$ -modules that have an increasing composition series with composition factors isomorphic to $L(\bar{\mathfrak{l}}, \nu^{\natural})$, with $\nu \in P^+$, is a semi-simple tensor category [CK, Section 3.2]. Thus $\bar{\Delta}(\mu^{\natural}) \cong U(\bar{\mathfrak{u}}_-) \otimes L(\bar{\mathfrak{l}}, \mu^{\natural})$ also decomposes into a direct sum of $L(\bar{\mathfrak{l}}, \nu^{\natural})$ with $\nu \in P^+$, and so does its irreducible quotient $\bar{L}(\mu^{\natural})$. \square

Let \mathcal{O} be the category of \mathfrak{g} -modules M such that M is a semisimple \mathfrak{h} -module with finite dimensional weight subspaces M_{γ} , $\gamma \in \mathfrak{h}^*$, satisfying

- (i) M decomposes over \mathfrak{l} into a direct sum of $L(\mathfrak{l}, \mu)$ for $\mu \in P^+$.
- (ii) There exist finitely many weights $\lambda_1, \lambda_2, \dots, \lambda_k \in P^+$ (depending on M) such that if γ is a weight in M , then $\gamma \in \lambda_i - \sum_{\alpha \in \Pi} \mathbb{Z}_+ \alpha$, for some i .

The parabolic Verma modules $\Delta(\mu)$ and irreducible modules $L(\mu)$ for $\mu \in P^+$ lie in \mathcal{O} , by Lemma 3.1. Analogously we define the categories $\bar{\mathcal{O}}$ and $\tilde{\mathcal{O}}$ of $\bar{\mathfrak{g}}$ - and $\tilde{\mathfrak{g}}$ -modules, respectively. They also contain suitable parabolic Verma and irreducible modules. The morphisms in \mathcal{O} , $\bar{\mathcal{O}}$ and $\tilde{\mathcal{O}}$ are all (not necessarily even) \mathfrak{g} -, $\bar{\mathfrak{g}}$ - and $\tilde{\mathfrak{g}}$ -homomorphisms, respectively.

3.3. The Lie superalgebras \mathfrak{g}_n , $\bar{\mathfrak{g}}_n$ and $\tilde{\mathfrak{g}}_n$ of finite rank. For $n \in \mathbb{N}$, recall the sets $\Pi_n, \bar{\Pi}_n, \tilde{\Pi}_n$ of simple roots for the Dynkin diagrams (2.2). The associated Lie superalgebras \mathfrak{g}_n , $\bar{\mathfrak{g}}_n$ and $\tilde{\mathfrak{g}}_n$ can be identified naturally with the subalgebras of \mathfrak{g} , $\bar{\mathfrak{g}}$ and $\tilde{\mathfrak{g}}$ generated by K and the root vectors of the corresponding Dynkin diagrams in (2.2), and moreover, $\mathfrak{g}_n \subset \mathfrak{g}_{n+1}$, $\bar{\mathfrak{g}}_n \subset \bar{\mathfrak{g}}_{n+1}$ for all n . Observe that the $\bar{\mathfrak{g}}_n$'s (modulo the trivial central extensions) are exactly all the finite dimensional Lie superalgebras of \mathfrak{osp} type. Since $\bar{\mathfrak{g}} = \cup_n \bar{\mathfrak{g}}_n$, the standard Cartan subalgebra of $\bar{\mathfrak{g}}_n$ equals $\bar{\mathfrak{h}}_n = \bar{\mathfrak{h}} \cap \bar{\mathfrak{g}}_n$.

Similarly, we use the notation \mathfrak{h}_n and $\tilde{\mathfrak{h}}_n$ for the standard Cartan subalgebras of \mathfrak{g}_n and $\tilde{\mathfrak{g}}_n$, respectively.

Recall the notation $\lambda \in P^+$, λ^\natural , and λ^θ from (3.1), (3.2) and (3.3). Given $\lambda \in P^+$ with $\lambda_j^+ = 0$ for $j > n$, we may regard it as a weight $\lambda_n \in \mathfrak{h}_n^*$ in a natural way. Similarly, for $\lambda \in P^+$ with $(\lambda^+)'_j = 0$ for $j > n$, we regard λ^\natural as a weight $\lambda_n^\natural \in \tilde{\mathfrak{h}}_n^*$. Finally, for $\lambda \in P^+$ with $\theta(\lambda^+)_j = 0$ for $j > n$, we regard λ^θ as a weight $\lambda_n^\theta \in \tilde{\mathfrak{h}}_n^*$. The subsets of such weights $\lambda_n, \lambda_n^\natural, \lambda_n^\theta$ in $\mathfrak{h}_n^*, \tilde{\mathfrak{h}}_n^*$ and $\tilde{\mathfrak{h}}_n^*$ will be denoted by P_n^+, \bar{P}_n^+ and \tilde{P}_n^+ , respectively.

The corresponding parabolic Verma and irreducible \mathfrak{g}_n -modules are denoted by $\Delta_n(\mu)$ and $L_n(\mu)$, respectively, with $\mu \in P_n^+$, while the corresponding category of \mathfrak{g}_n -modules is denoted by \mathcal{O}_n . Similarly, we introduce the self-explanatory notations $\bar{\Delta}_n(\mu^\natural), \bar{L}_n(\mu^\natural), \bar{\mathcal{O}}_n$, and $\tilde{\Delta}_n(\mu^\theta), \tilde{L}_n(\mu^\theta), \tilde{\mathcal{O}}_n$ for $\bar{\mathfrak{g}}_n$ - and $\tilde{\mathfrak{g}}_n$ -modules, respectively.

3.4. The truncation functors. Let $\infty \geq k > n$. For $M \in \mathcal{O}_k$, we can write $M = \bigoplus_\gamma M_\gamma$, where γ runs over $\gamma \in \sum_{i=-m}^{-1} \mathbb{C}\epsilon_i + \sum_{0 < j \leq k} \mathbb{C}\epsilon_j + \mathbb{C}\Lambda_0$. The *truncation functor*

$$\mathfrak{tr}_n^k : \mathcal{O}_k \rightarrow \mathcal{O}_n$$

is defined by sending M to $\bigoplus_\nu M_\nu$, summed over $\sum_{i=-m}^{-1} \mathbb{C}\epsilon_i + \sum_{0 < j \leq n} \mathbb{C}\epsilon_j + \mathbb{C}\Lambda_0$. When it is clear from the context we shall also write \mathfrak{tr}_n instead of \mathfrak{tr}_n^k . Analogously, truncation functors $\mathfrak{tr}_n^k : \bar{\mathcal{O}}_k \rightarrow \bar{\mathcal{O}}_n$ and $\mathfrak{tr}_n^k : \tilde{\mathcal{O}}_k \rightarrow \tilde{\mathcal{O}}_n$ are defined.

Lemma 3.2. *Let $\infty \geq k > n$ and $X = L, \Delta$.*

- (i) *For $\mu \in P_k^+$ we have $\mathfrak{tr}_n(X_k(\mu)) = \begin{cases} X_n(\mu), & \text{if } \langle \mu, \hat{E}_j \rangle = 0, \forall j > n, \\ 0, & \text{otherwise.} \end{cases}$*
- (ii) *For $\mu \in \bar{P}_k^+$ we have $\mathfrak{tr}_n(\bar{X}_k(\mu)) = \begin{cases} \bar{X}_n(\mu), & \text{if } \langle \mu, \hat{E}_j \rangle = 0, \forall j > n, \\ 0, & \text{otherwise.} \end{cases}$*
- (iii) *For $\mu \in \tilde{P}_k^+$ we have $\mathfrak{tr}_n(\tilde{X}_k(\mu)) = \begin{cases} \tilde{X}_n(\mu), & \text{if } \langle \mu, \hat{E}_j \rangle = 0, \forall j > n, \\ 0, & \text{otherwise.} \end{cases}$*

Proof. We will show (i) only. The proofs of (ii) and (iii) are similar.

Since $\mathfrak{tr}_n^k \circ \mathfrak{tr}_k^l = \mathfrak{tr}_n^l$, it is enough to show (i) for $k = \infty$. Suppose that $\langle \mu, \hat{E}_j \rangle = 0$ for all $j > n$. Let \mathfrak{l}' denote the standard Levi subalgebra of \mathfrak{g} corresponding to the removal of the vertex β_n of the Dynkin diagram of \mathfrak{g} . Then $\mathfrak{l}' \cong \mathfrak{g}_n \oplus \mathfrak{gl}(\infty)$. Now $L(\mu)$ is the unique irreducible quotient of the \mathfrak{g} -module obtained via parabolic induction from the \mathfrak{l}' -module $L_n(\mu)$ (where the \mathfrak{g}_n -module $L_n(\mu)$ is extended to an \mathfrak{l}' -module by a trivial action of $\mathfrak{gl}(\infty)$). Our choice of the Levi subalgebra and of the opposite nilradical assures that this parabolically induced module truncates to $L_n(\mu)$. Thus its irreducible quotient $L(\mu)$ also truncates to $L_n(\mu)$. The remaining case in (i) is clear. \square

Remark 3.3. The central extensions introduced in Section 2.4 allow us to study, in a uniform fashion, modules whose weights stabilize at any $d \in \mathbb{C}$ (not just at $d = 0$). For example, if μ is a weight with $\mu(E_r) = d \neq 0$, for $r \gg 0$, then, without central extensions, the usual truncation functors would always truncate an irreducible or parabolic Verma of such a highest weight to zero. A way around central extensions

is to define truncation functors depending on each $d \in \mathbb{C}$. This approach, although equivalent, looks less elegant.

4. THE CHARACTER FORMULAS

In this section we introduce two functors $T : \tilde{\mathcal{O}} \rightarrow \mathcal{O}$ and $\bar{T} : \tilde{\mathcal{O}} \rightarrow \bar{\mathcal{O}}$, and then establish a fundamental property of these functors (Theorem 4.6). As a consequence, we obtain an irreducible \mathfrak{osp} -character formula in a parabolic category \mathcal{O} in terms of the KL polynomials of BCD types (Theorem 4.8 and Remark 4.9). The Kazhdan-Lusztig polynomials in the categories \mathcal{O} , $\bar{\mathcal{O}}$ and $\tilde{\mathcal{O}}$ in terms of Kostant \mathfrak{u} -homology groups are shown to match perfectly with one another (Theorem 4.13).

4.1. Odd reflections. Let \mathcal{G} be a Lie superalgebra with a Borel subalgebra \mathcal{B} with corresponding sets of simple and positive roots $\Pi(\mathcal{B})$ and $\Phi_+(\mathcal{B})$, respectively. As usual, for a positive root β , we let f_β denote a root vector associated to root $-\beta$.

Let α be an isotropic odd simple root in $\Pi(\mathcal{B})$ and h_α be its corresponding coroot. The set $\Phi_+(\mathcal{B}^\alpha) := \{-\alpha\} \cup \Phi_+(\mathcal{B}) \setminus \{\alpha\}$ forms a new set of positive roots whose corresponding set of simple roots is

$$\Pi(\mathcal{B}^\alpha) = \{\beta \in \Pi(\mathcal{B}) \mid \langle \beta, h_\alpha \rangle = 0, \beta \neq \alpha\} \cup \{\beta + \alpha \mid \beta \in \Pi(\mathcal{B}), \langle \beta, h_\alpha \rangle \neq 0\} \cup \{-\alpha\}.$$

We shall denote by \mathcal{B}^α the corresponding new Borel subalgebra. The process of such a change of Borel subalgebras is referred to as *odd reflection* with respect to α [LSS].

The following simple and fundamental lemma for odd reflections has been used by many authors (cf. e.g. [KW]).

Lemma 4.1. *Let L be a simple \mathcal{G} -module of \mathcal{B} -highest weight λ and let v be a \mathcal{B} -highest weight vector. Let α be a simple isotropic odd root in $\Pi(\mathcal{B})$.*

- (1) *If $\langle \lambda, h_\alpha \rangle = 0$, then L is a \mathcal{G} -module of \mathcal{B}^α -highest weight λ and v is a \mathcal{B}^α -highest weight vector.*
- (2) *If $\langle \lambda, h_\alpha \rangle \neq 0$, then L is a \mathcal{G} -module of \mathcal{B}^α -highest weight $\lambda - \alpha$ and $f_\alpha v$ is a \mathcal{B}^α -highest weight vector.*

4.2. The Borel subalgebras $\tilde{\mathfrak{b}}^c(n)$ and $\tilde{\mathfrak{b}}^s(n)$. Fix $n \in \mathbb{N}$. Starting with the third Dynkin diagram in (2.2) associated to $\tilde{\mathfrak{g}}$, we apply the following sequence of $\frac{n(n+1)}{2}$ odd reflections. First we apply one odd reflection corresponding to $\alpha_{1/2}$, then we apply two odd reflections corresponding to $\alpha_{3/2}$ and $\alpha_{1/2} + \alpha_1 + \alpha_{3/2}$. After that we apply three odd reflections corresponding to $\alpha_{5/2}$, $\alpha_{3/2} + \alpha_2 + \alpha_{5/2}$, and $\alpha_{1/2} + \alpha_1 + \alpha_{3/2} + \alpha_2 + \alpha_{5/2}$, et cetera, until finally we apply n odd reflections corresponding to $\alpha_{n-1/2}$, $\alpha_{n-3/2} + \alpha_{n-1} + \alpha_{n-1/2}$, \dots , $\sum_{i=1}^{2n-1} \alpha_{i/2}$. The resulting new Borel subalgebra for $\tilde{\mathfrak{g}}$ will be denoted by $\tilde{\mathfrak{b}}^c(n)$ and its corresponding simple roots are listed in the following Dynkin diagram:

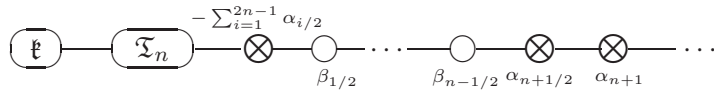

The crucial point here is that the subdiagram to the left of the first \otimes is the Dynkin diagram of \mathfrak{g}_n .

On the other hand, starting with the third Dynkin diagram in (2.2) associated to $\tilde{\mathfrak{g}}$, we apply the following new sequence of $\frac{n(n+1)}{2}$ odd reflections. First we apply one odd reflection corresponding to α_1 , then we apply two odd reflections corresponding to α_2 and $\alpha_1 + \alpha_{3/2} + \alpha_2$. After that we apply three odd reflections corresponding to α_3 , $\alpha_2 + \alpha_{5/2} + \alpha_3$, and $\alpha_1 + \alpha_{3/2} + \alpha_2 + \alpha_{5/2} + \alpha_3$, et cetera, until finally we apply n odd reflections corresponding to $\alpha_n, \alpha_{n-1} + \alpha_{n-1/2} + \alpha_n, \dots, \sum_{i=2}^{2n} \alpha_{i/2}$. The resulting new Borel subalgebra for $\tilde{\mathfrak{g}}$ will be denoted by $\tilde{\mathfrak{b}}^s(n)$ and its corresponding simple roots are listed in the following Dynkin diagram:

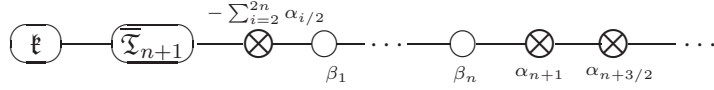

We remark that the subdiagram to the left of the odd simple root $-\sum_{i=2}^{2n} \alpha_{i/2}$ above becomes the Dynkin diagram of $\tilde{\mathfrak{g}}_{n+1}$.

4.3. Highest weights with respect to $\tilde{\mathfrak{b}}^c(n)$ and $\tilde{\mathfrak{b}}^s(n)$. Recall the standard Levi subalgebra $\tilde{\mathfrak{l}}$ of $\tilde{\mathfrak{g}}$ with (opposite) nilradical $\tilde{\mathfrak{u}}$ and $\tilde{\mathfrak{u}}_-$ (see Section 3.1).

Lemma 4.2. *The sequences of odd reflections in 4.2 leave the sets of roots of $\tilde{\mathfrak{u}}$ and $\tilde{\mathfrak{u}}_-$ invariant.*

Proof. This follows from the fact that the simple roots used in the sequences of odd reflections in Section 4.2 are all roots of $\tilde{\mathfrak{l}}$. \square

We denote by $\tilde{\mathfrak{b}}_1^c(n)$ and $\tilde{\mathfrak{b}}_1^s(n)$ the Borel subalgebras of $\tilde{\mathfrak{l}}$ corresponding to the sets of simple roots $\tilde{\Pi}^c(n) \cap \sum_{\alpha \in \tilde{Y}} \mathbb{Z}\alpha$ and $\tilde{\Pi}^s(n) \cap \sum_{\alpha \in \tilde{Y}} \mathbb{Z}\alpha$, respectively. The sequences of odd reflections in 4.2 only affect the tail diagram $(\tilde{\mathfrak{T}})$ and leaves the head diagram (\mathfrak{t}) invariant. Since the tail diagram is of type A , the proofs of [CL, Lemma 3.2] and [CL, Corollary 3.3] can be adapted in a straightforward way to prove the following (where Lemma 4.2 is used).

Proposition 4.3. *Let $\lambda \in P^+$ and $n \in \mathbb{N}$.*

- (i) *Suppose that $\ell(\lambda_+) \leq n$. Then the highest weight of $L(\tilde{\mathfrak{l}}, \lambda^\theta)$ with respect to the Borel subalgebra $\tilde{\mathfrak{b}}_1^c(n)$ is λ . Furthermore, $\tilde{\Delta}(\lambda^\theta)$ and $\tilde{L}(\lambda^\theta)$ are highest weight $\tilde{\mathfrak{g}}$ -modules of highest weight λ with respect to the new Borel subalgebra $\tilde{\mathfrak{b}}^c(n)$.*
- (ii) *Suppose that $\ell(\lambda'_+) \leq n$. Then the highest weight of $L(\tilde{\mathfrak{l}}, \lambda^\theta)$ with respect to the Borel subalgebra $\tilde{\mathfrak{b}}_1^s(n)$ is λ^\natural . Furthermore, $\tilde{\Delta}(\lambda^\theta)$ and $\tilde{L}(\lambda^\theta)$ are highest weight $\tilde{\mathfrak{g}}$ -modules of highest weight λ^\natural with respect to the new Borel subalgebra $\tilde{\mathfrak{b}}^s(n)$.*

4.4. The functors T and \bar{T} . By definition, \mathfrak{g} and $\tilde{\mathfrak{g}}$ are naturally subalgebras of $\tilde{\mathfrak{g}}$, \mathfrak{l} and $\tilde{\mathfrak{l}}$ are subalgebras of $\tilde{\mathfrak{l}}$, while \mathfrak{h} and $\tilde{\mathfrak{h}}$ are subalgebras of $\tilde{\mathfrak{h}}$. Also, we may regard $\mathfrak{h}^* \subset \tilde{\mathfrak{h}}^*$ and $\tilde{\mathfrak{h}}^* \subset \tilde{\mathfrak{h}}^*$.

Given a semisimple $\tilde{\mathfrak{h}}$ -module $\tilde{M} = \bigoplus_{\gamma \in \tilde{\mathfrak{h}}^*} \tilde{M}_\gamma$, we define

$$T(\tilde{M}) := \bigoplus_{\gamma \in \mathfrak{h}^*} \tilde{M}_\gamma, \quad \text{and} \quad \bar{T}(\tilde{M}) := \bigoplus_{\gamma \in \bar{\mathfrak{h}}^*} \tilde{M}_\gamma.$$

Note that $T(\tilde{M})$ is an \mathfrak{h} -submodule of the \tilde{M} , and $\bar{T}(\tilde{M})$ is an $\bar{\mathfrak{h}}$ -submodule of \tilde{M} . One checks that if $\tilde{M} = \bigoplus_{\gamma \in \tilde{\mathfrak{h}}^*} \tilde{M}_\gamma$ is an $\tilde{\mathfrak{l}}$ -module, then $T(\tilde{M})$ is an \mathfrak{l} -submodule of \tilde{M} and $\bar{T}(\tilde{M})$ is an $\bar{\mathfrak{l}}$ -submodule of \tilde{M} . Furthermore, if $\tilde{M} = \bigoplus_{\gamma \in \tilde{\mathfrak{h}}^*} \tilde{M}_\gamma$ is a $\tilde{\mathfrak{g}}$ -module, then $T(\tilde{M})$ is a \mathfrak{g} -submodule of \tilde{M} and $\bar{T}(\tilde{M})$ is a $\bar{\mathfrak{g}}$ -submodule of \tilde{M} .

The direct sum decomposition in \tilde{M} gives rise to the natural projections

$$T_{\tilde{M}} : \tilde{M} \longrightarrow T(\tilde{M}) \quad \text{and} \quad \bar{T}_{\tilde{M}} : \tilde{M} \longrightarrow \bar{T}(\tilde{M})$$

that are \mathfrak{h} - and $\bar{\mathfrak{h}}$ -module homomorphisms, respectively. If $\tilde{f} : \tilde{M} \rightarrow \tilde{N}$ is an $\tilde{\mathfrak{h}}$ -homomorphism, then the following induced maps

$$T[\tilde{f}] : T(\tilde{M}) \longrightarrow T(\tilde{N}) \quad \text{and} \quad \bar{T}[\tilde{f}] : \bar{T}(\tilde{M}) \longrightarrow \bar{T}(\tilde{N})$$

are also \mathfrak{h} - and $\bar{\mathfrak{h}}$ -module homomorphisms, respectively. Also if $\tilde{f} : \tilde{M} \rightarrow \tilde{N}$ is a $\tilde{\mathfrak{g}}$ -homomorphism, then $T_{\tilde{M}}$ and $T[\tilde{f}]$ (respectively, $\bar{T}_{\tilde{M}}$ and $\bar{T}[\tilde{f}]$) are \mathfrak{g} - (respectively, $\bar{\mathfrak{g}}$ -) homomorphisms.

Lemma 4.4. *For $\lambda \in P^+$, we have $T(L(\tilde{\mathfrak{l}}, \lambda^\theta)) = L(\mathfrak{l}, \lambda)$, and $\bar{T}(L(\tilde{\mathfrak{l}}, \lambda^\theta)) = L(\bar{\mathfrak{l}}, \lambda^\natural)$.*

Proof. We shall prove the first formula using a character argument, and the second one can be proved similarly.

Associated to partitions $\nu \subset \lambda$, we denote by $s_\lambda(x_1, x_2, \dots)$ and $s_{\lambda/\nu}(x_1, x_2, \dots)$ the Schur and skew Schur functions in the variables x_1, x_2, \dots . The hook Schur functions associated to λ is defined to be (cf. [Sv, BR])

$$(4.1) \quad hs_\lambda(x_{1/2}, x_1, x_{3/2}, x_2, \dots) := \sum_{\mu \subset \lambda} s_\mu(x_{1/2}, x_{3/2}, \dots) s_{\lambda'/\mu'}(x_1, x_2, \dots).$$

For a dominant tuple $(\lambda_{-m}, \dots, \lambda_{-1}; \lambda^+)$, we have (cf. [CK])

$$(4.2) \quad \text{ch}L(\tilde{\mathfrak{l}}, \lambda^\theta) = \text{ch}L(\tilde{\mathfrak{l}} \cap \mathfrak{k}, \lambda|_{\mathfrak{k}}) hs_{\lambda^+}(x_{1/2}, x_1, x_{3/2}, x_2, \dots).$$

Here $x_r := e^{\epsilon_r}$ for each r , and $L(\tilde{\mathfrak{l}} \cap \mathfrak{k}, \lambda|_{\mathfrak{k}})$ denotes the irreducible $\tilde{\mathfrak{l}} \cap \mathfrak{k}$ -module of highest weight $\lambda|_{\mathfrak{k}} = \sum_{i=-m}^{-1} \lambda_i \epsilon_i$. Note that $\tilde{\mathfrak{l}} \cap \mathfrak{k} = \mathfrak{l} \cap \mathfrak{k}$.

As an \mathfrak{l} -module, $L(\tilde{\mathfrak{l}}, \lambda^\theta)$ is completely reducible. On the character level, applying T to $L(\tilde{\mathfrak{l}}, \lambda^\theta)$ corresponds to setting $x_{1/2}, x_{3/2}, x_{5/2}, \dots$ in the character formula (4.2) to zero. By (4.1), $T(L(\tilde{\mathfrak{l}}, \lambda^\theta))$ is an \mathfrak{l} -module with character $\text{ch}L(\tilde{\mathfrak{l}} \cap \mathfrak{k}, \lambda|_{\mathfrak{k}}) s_{\lambda^+}(x_1, x_2, \dots)$, which is precisely the character of $L(\mathfrak{l}, \lambda)$. This proves the formula. \square

Corollary 4.5. *T and \bar{T} define exact functors from $\tilde{\mathcal{O}}$ to \mathcal{O} and from $\tilde{\mathcal{O}}$ to $\bar{\mathcal{O}}$, respectively.*

The following theorem can be regarded as a weak version of the super duality which is to be established in Theorem 5.4.

Theorem 4.6. *Let $\lambda \in P^+$. If \widetilde{M} is a highest weight $\widetilde{\mathfrak{g}}$ -module of highest weight λ^θ , then $T(\widetilde{M})$ and $\overline{T}(\widetilde{M})$ are highest weight \mathfrak{g} - and $\overline{\mathfrak{g}}$ -modules of highest weights λ and λ^\natural , respectively. Furthermore, we have*

$$\begin{aligned} T(\widetilde{\Delta}(\lambda^\theta)) &= \Delta(\lambda), & T(\widetilde{L}(\lambda^\theta)) &= L(\lambda); \\ \overline{T}(\widetilde{\Delta}(\lambda^\theta)) &= \overline{\Delta}(\lambda^\natural), & \overline{T}(\widetilde{L}(\lambda^\theta)) &= \overline{L}(\lambda^\natural). \end{aligned}$$

Proof. We will prove only the statements involving T , and the statements involving \overline{T} can be proved in the same way.

By Proposition 4.3, \widetilde{M} contains a $\widetilde{\mathfrak{b}}^c(n)$ -highest weight vector v_λ of highest weight λ for $n \gg 0$. The vector v_λ clearly lies in $T(\widetilde{M})$, and it is a \mathfrak{b} -singular vector since $\mathfrak{b} = \mathfrak{g} \cap \widetilde{\mathfrak{b}}^c(n)$. Now $T(\widetilde{M})$ is completely reducible over \mathfrak{l} with all highest weights of its irreducible summands lying in P^+ . Thus to show that $T(\widetilde{M})$ is a highest weight \mathfrak{g} -module it remains to show that any vector in $T(\widetilde{M})$ of weight in P^+ is contained in $U(\mathfrak{g})v_\lambda$. This follows by the same argument in [CL, Lemma 3.5], which only relies on the A -type tail diagram of $\widetilde{\mathfrak{g}}$.

Let us write $\Delta(\lambda) = U(\mathfrak{u}_-) \otimes_{\mathbb{C}} L(\mathfrak{l}, \lambda)$ and $\widetilde{\Delta}(\lambda^\theta) = U(\widetilde{\mathfrak{u}}_-) \otimes_{\mathbb{C}} L(\widetilde{\mathfrak{l}}, \lambda^\theta)$. We observe that all the weights in $U(\mathfrak{u}_-)$, $L(\mathfrak{l}, \lambda)$, $U(\widetilde{\mathfrak{u}}_-)$, and $L(\widetilde{\mathfrak{l}}, \lambda^\theta)$ are of the form $\sum_{j < 0} a_j \epsilon_j + \sum_{r > 0} b_r \epsilon_r$ with $b_r \in \mathbb{Z}_+$. Since also $T(U(\widetilde{\mathfrak{u}}_-)) = U(\mathfrak{u}_-)$, it follows by Lemma 4.4 that $\text{ch}T(\widetilde{\Delta}(\lambda^\theta)) = \text{ch}\Delta(\lambda)$. Since $T(\widetilde{\Delta}(\lambda^\theta))$ is a highest weight module of highest weight λ , we have $T(\widetilde{\Delta}(\lambda^\theta)) = \Delta(\lambda)$.

To show that T sends irreducibles to irreducibles we show that $T(\widetilde{L}(\lambda^\theta))$ has no singular vector apart from the scalar multiples of a highest weight vector. We argue by assuming otherwise and derive a contradiction. If we have another singular vector of weight different from λ , then we can show, following the second part of the proof of [CL, Theorem 3.6], that we also have a singular vector in $\widetilde{L}(\lambda^\theta)$ of weight different from λ^θ . The argument there is applicable here, since it again only depends on the tail diagram, which is of type A . \square

Remark 4.7. It can be shown that tilting modules exist in categories \mathcal{O} , $\overline{\mathcal{O}}$, $\widetilde{\mathcal{O}}$ (cf. [CWZ, CW] for type A) and that the functors T and \overline{T} respect the tilting modules. We choose not to develop the details in order to keep the paper to a reasonable length.

By standard arguments Theorem 4.6 implies the following character formula.

Theorem 4.8. *Let $\lambda \in P^+$, and write $\text{ch}L(\lambda) = \sum_{\mu \in P^+} a_{\mu\lambda} \text{ch}\Delta(\mu)$, $a_{\mu\lambda} \in \mathbb{Z}$. Then*

- (i) $\text{ch}\overline{L}(\lambda^\natural) = \sum_{\mu \in P^+} a_{\mu\lambda} \text{ch}\overline{\Delta}(\mu^\natural)$,
- (ii) $\text{ch}\widetilde{L}(\lambda^\theta) = \sum_{\mu \in P^+} a_{\mu\lambda} \text{ch}\widetilde{\Delta}(\mu^\theta)$.

Remark 4.9. The transition matrix $(a_{\mu\lambda})$ in Theorem 4.8 is known according to the Kazhdan-Lusztig theory. This is because the Kazhdan-Lusztig polynomials in the BGG category \mathcal{O} also determine the composition factors of generalized Verma modules in the corresponding parabolic subcategory (see e.g. [So, p. 445 and Proposition 7.5]). Hence Theorem 4.8 and Lemma 3.2 provide a complete solution to the irreducible character problem in the category $\overline{\mathcal{O}}_n$ for the ortho-symplectic Lie superalgebras.

4.5. Kostant type homology formula. For a precise definition of homology groups of Lie superalgebras with coefficients in a module and a precise formula for the boundary operator we refer the reader to [CL, Section 4] or [Ta].

For $\widetilde{M} \in \widetilde{\mathcal{O}}$ we denote by $M = T(\widetilde{M}) \in \mathcal{O}$ and $\overline{M} = \overline{T}(\widetilde{M}) \in \overline{\mathcal{O}}$. Furthermore let $\widetilde{d} : \Lambda(\widetilde{\mathfrak{u}}_-) \otimes \widetilde{M} \rightarrow \Lambda(\widetilde{\mathfrak{u}}_-) \otimes \widetilde{M}$ be the boundary operator of the complex of $\widetilde{\mathfrak{u}}_-$ -homology groups with coefficients in \widetilde{M} , regarded as a $\widetilde{\mathfrak{u}}_-$ -module. The map \widetilde{d} is an $\widetilde{\mathfrak{l}}$ -module homomorphism and hence the homology groups $H_n(\widetilde{\mathfrak{u}}_-, \widetilde{M})$ are $\widetilde{\mathfrak{l}}$ -modules, for $n \in \mathbb{Z}_+$. Accordingly we let $d : \Lambda(\mathfrak{u}_-) \otimes M \rightarrow \Lambda(\mathfrak{u}_-) \otimes M$ and $\overline{d} : \Lambda(\overline{\mathfrak{u}}_-) \otimes \overline{M} \rightarrow \Lambda(\overline{\mathfrak{u}}_-) \otimes \overline{M}$ stand for the boundary operator of the complex of \mathfrak{u}_- -homology with coefficients in M and the boundary operator of the complex of $\overline{\mathfrak{u}}_-$ -homology with coefficients in \overline{M} , respectively. Similarly, d and \overline{d} are \mathfrak{l} - and $\overline{\mathfrak{l}}$ -homomorphisms, respectively.

Lemma 4.10. *For $\widetilde{M} \in \widetilde{\mathcal{O}}$ and $\lambda \in P^+$, we have*

- (i) $T(\Lambda(\widetilde{\mathfrak{u}}_-) \otimes \widetilde{M}) = \Lambda(\mathfrak{u}_-) \otimes M$, and thus $T(\Lambda(\widetilde{\mathfrak{u}}_-) \otimes \widetilde{L}(\lambda^\theta)) = \Lambda(\mathfrak{u}_-) \otimes L(\lambda)$.
Moreover, $T[\widetilde{d}] = d$.
- (ii) $\overline{T}(\Lambda(\widetilde{\mathfrak{u}}_-) \otimes \widetilde{M}) = \Lambda(\overline{\mathfrak{u}}_-) \otimes \overline{M}$, and thus $\overline{T}(\Lambda(\widetilde{\mathfrak{u}}_-) \otimes \widetilde{L}(\lambda^\theta)) = \Lambda(\overline{\mathfrak{u}}_-) \otimes \overline{L}(\lambda^\natural)$.
Moreover, $\overline{T}[\widetilde{d}] = \overline{d}$.

Proof. We will prove (i) only. It follows by definition of T and $\widetilde{\mathfrak{u}}_-$ that $T(\Lambda(\widetilde{\mathfrak{u}}_-)) = \Lambda(\mathfrak{u}_-)$. Now, since all modules involved have weights of the form $\sum_{i < 0} a_i \epsilon_i + \sum_{r > 0} b_r \epsilon_r$ with $b_r \in \mathbb{Z}_+$, it follows that $T(\Lambda(\widetilde{\mathfrak{u}}_-) \otimes \widetilde{M})$ and $\Lambda(\mathfrak{u}_-) \otimes M$ have the same character. Complete reducibility of the \mathfrak{l} -modules $T(\Lambda(\widetilde{\mathfrak{u}}_-) \otimes \widetilde{M})$ and $\Lambda(\mathfrak{u}_-) \otimes M$ implies that $T(\Lambda(\widetilde{\mathfrak{u}}_-) \otimes \widetilde{M}) = \Lambda(\mathfrak{u}_-) \otimes M$ as \mathfrak{l} -modules. Theorem 4.6 completes the proof of the first part of (i).

The second part of (i) follows from the definitions of \widetilde{d} and d (see e.g. [CL, (4.1)]). \square

By Lemma 4.10 we have the following commutative diagram.

$$(4.3) \quad \begin{array}{ccccc} \dots & \xrightarrow{\widetilde{d}} & \Lambda^{n+1}(\widetilde{\mathfrak{u}}_-) \otimes \widetilde{M} & \xrightarrow{\widetilde{d}} & \Lambda^n(\widetilde{\mathfrak{u}}_-) \otimes \widetilde{M} & \xrightarrow{\widetilde{d}} & \Lambda^{n-1}(\widetilde{\mathfrak{u}}_-) \otimes \widetilde{M} \dots \\ & & \downarrow T_{\Lambda^{n+1}(\widetilde{\mathfrak{u}}_-) \otimes \widetilde{M}} & & \downarrow T_{\Lambda^n(\widetilde{\mathfrak{u}}_-) \otimes \widetilde{M}} & & \downarrow T_{\Lambda^{n-1}(\widetilde{\mathfrak{u}}_-) \otimes \widetilde{M}} \\ \dots & \xrightarrow{d} & \Lambda^{n+1}(\mathfrak{u}_-) \otimes M & \xrightarrow{d} & \Lambda^n(\mathfrak{u}_-) \otimes M & \xrightarrow{d} & \Lambda^{n-1}(\mathfrak{u}_-) \otimes M \dots \end{array}$$

Thus T induces an \mathfrak{l} -homomorphism from $H_n(\widetilde{\mathfrak{u}}_-; \widetilde{M})$ to $H_n(\mathfrak{u}_-; M)$. Similarly, \overline{T} induces an $\overline{\mathfrak{l}}$ -homomorphism from $H_n(\widetilde{\mathfrak{u}}_-; \widetilde{M})$ to $H_n(\overline{\mathfrak{u}}_-; \overline{M})$.

As an $\widetilde{\mathfrak{l}}$ -module, $\Lambda(\widetilde{\mathfrak{u}}_-)$ is a direct sum of $L(\widetilde{\mathfrak{l}}, \mu^\theta)$, $\mu \in P^+$, each appearing with finite multiplicity ([CK, Section 3.2.3]). By [CK, Theorem 3.2], $\Lambda(\widetilde{\mathfrak{u}}_-) \otimes \widetilde{M}$ as an $\widetilde{\mathfrak{l}}$ -module is completely reducible. Write $\Lambda(\widetilde{\mathfrak{u}}_-) \otimes \widetilde{M} \cong \bigoplus_{\mu \in P^+} L(\widetilde{\mathfrak{l}}, \mu^\theta)^{m(\mu)}$ as $\widetilde{\mathfrak{l}}$ -modules. It follows by Lemmas 4.4 and 4.10 that $\Lambda(\mathfrak{u}_-) \otimes M \cong \bigoplus_{\mu \in P^+} L(\mathfrak{l}, \mu)^{m(\mu)}$, as \mathfrak{l} -modules. Similarly, $\Lambda(\overline{\mathfrak{u}}_-) \otimes \overline{M} \cong \bigoplus_{\mu \in P^+} L(\overline{\mathfrak{l}}, \mu^\natural)^{m(\mu)}$, as $\overline{\mathfrak{l}}$ -modules. The commutativity of (4.3) and Lemma 4.10 now allow us to adapt the proof of [CL, Theorem 4.4] to prove the following.

Theorem 4.11. *We have for $n \geq 0$*

- (i) $T(H_n(\tilde{\mathbf{u}}_-; \tilde{M})) \cong H_n(\mathbf{u}_-; M)$, as \mathfrak{l} -modules.
- (ii) $\overline{T}(H_n(\tilde{\mathbf{u}}_-; \tilde{M})) \cong H_n(\overline{\mathbf{u}}_-; \overline{M})$, as $\overline{\mathfrak{l}}$ -modules.

Setting $\tilde{M} = \tilde{L}(\lambda^\theta)$ in Theorem 4.11 and using Theorem 4.6 we obtain the following.

Corollary 4.12. *For $\lambda \in P^+$ and $n \geq 0$, we have*

- (i) $T(H_n(\tilde{\mathbf{u}}_-; \tilde{L}(\lambda^\theta))) \cong H_n(\mathbf{u}_-; L(\lambda))$, as \mathfrak{l} -modules.
- (ii) $\overline{T}(H_n(\tilde{\mathbf{u}}_-; \tilde{L}(\lambda^\theta))) \cong H_n(\overline{\mathbf{u}}_-; \overline{L}(\lambda^\natural))$, as $\overline{\mathfrak{l}}$ -modules.

We define parabolic Kazhdan-Lusztig polynomials in the categories \mathcal{O} , $\overline{\mathcal{O}}$ and $\tilde{\mathcal{O}}$ for $\mu, \lambda \in P^+$ by letting

$$\begin{aligned} \ell_{\mu\lambda}(q) &:= \sum_{n=0}^{\infty} \dim_{\mathbb{C}} \left(\text{Hom}_{\mathfrak{l}} [L(\mathfrak{l}, \mu), H_n(\mathbf{u}_-; L(\lambda))] \right) (-q)^{-n}, \\ \overline{\ell}_{\mu^\natural\lambda^\natural}(q) &:= \sum_{n=0}^{\infty} \dim_{\mathbb{C}} \left(\text{Hom}_{\overline{\mathfrak{l}}} [L(\overline{\mathfrak{l}}, \mu^\natural), H_n(\overline{\mathbf{u}}_-; L(\lambda^\natural))] \right) (-q)^{-n}, \\ \tilde{\ell}_{\mu^\theta\lambda^\theta}(q) &:= \sum_{n=0}^{\infty} \dim_{\mathbb{C}} \left(\text{Hom}_{\tilde{\mathfrak{l}}} [L(\tilde{\mathfrak{l}}, \mu^\theta), H_n(\tilde{\mathbf{u}}_-; L(\lambda^\theta))] \right) (-q)^{-n}. \end{aligned}$$

By Vogan's homological interpretation of the Kazhdan-Lusztig polynomials [Vo, Conjecture 3.4] and the Kazhdan-Lusztig conjectures [KL], proved in [BB, BK], $\ell_{\mu\lambda}(q)$ coincides with the original definition and moreover $\ell_{\mu\lambda}(1) = a_{\mu\lambda}$ (cf. Theorem 4.8). The following reformulation of Corollary 4.12 is a generalization of Theorem 4.8.

Theorem 4.13. *For $\lambda, \mu \in P^+$ we have $\ell_{\mu\lambda}(q) = \tilde{\ell}_{\mu^\theta\lambda^\theta}(q) = \overline{\ell}_{\mu^\natural\lambda^\natural}(q)$.*

5. EQUIVALENCES OF CATEGORIES

5.1. The following is standard (see, for example, [Ku, Lemma 2.1.10]).

Proposition 5.1. *Let $M \in \mathcal{O}$. Then there exists a (possibly infinite) increasing filtration $0 = M_0 \subset M_1 \subset M_2 \subset \cdots$ of \mathfrak{g} -modules such that*

- (i) $\bigcup_{i \geq 0} M_i = M$,
- (ii) M_i/M_{i-1} is a highest weight module of highest weight ν_i with $\nu_i \in P^+$, for $i \geq 1$,
- (iii) the condition $\nu_i - \nu_j \in \sum_{\alpha \in \Pi} \mathbb{Z}_+\alpha$ implies that $i < j$,
- (iv) for any weight μ of M , there exists an $r \in \mathbb{N}$ such that $(M/M_r)_\mu = 0$.

Similar statements hold for $\overline{M} \in \overline{\mathcal{O}}$ and $\tilde{M} \in \tilde{\mathcal{O}}$.

Let $\tilde{\mathcal{O}}^f$ denote the full subcategory of $\tilde{\mathcal{O}}$ consisting of finitely generated $U(\tilde{\mathfrak{g}})$ -modules. The categories $\overline{\mathcal{O}}^f$ and \mathcal{O}^f are defined in a similar fashion.

Proposition 5.1 implies the following.

Proposition 5.2. *Let $M \in \mathcal{O}$. Then $M \in \mathcal{O}^f$ if and only if there exists a finite increasing filtration $0 = M_0 \subset M_1 \subset M_2 \subset \cdots \subset M_k = M$ of \mathfrak{g} -modules such that M_i/M_{i-1} is a highest weight module of highest weight ν_i with $\nu_i \in P^+$, for $1 \leq i \leq k$. Similar statements hold for $\overline{M} \in \overline{\mathcal{O}}$ and $\tilde{M} \in \tilde{\mathcal{O}}$.*

The following proposition is the converse to Theorem 4.6.

- Proposition 5.3.** (i) *If $V(\lambda)$ is a highest weight \mathfrak{g} -module of highest weight $\lambda \in P^+$, then there is a highest weight $\tilde{\mathfrak{g}}$ -module $\tilde{V}(\lambda^\theta)$ of highest weight λ^θ such that $T(\tilde{V}(\lambda^\theta)) = V(\lambda)$.*
- (ii) *If $\overline{V}(\lambda^\natural)$ is a highest weight $\overline{\mathfrak{g}}$ -module of highest weight λ^\natural with $\lambda \in P^+$, then there is a $\tilde{\mathfrak{g}}$ -module $\tilde{V}(\lambda^\theta)$ of highest weight λ^θ such that $\overline{T}(\tilde{V}(\lambda^\theta)) = \overline{V}(\lambda^\natural)$.*

Proof. We shall only prove (i), as (ii) is similar. We let W be the kernel of the natural projection from the $\Delta(\lambda)$ to $V(\lambda)$. Now Theorem 4.6 says that $T(\tilde{\Delta}(\lambda^\theta)) = \Delta(\lambda)$. Thus, by the exactness of functor T , it suffices to prove that W lifts to a submodule \tilde{W} of $\tilde{\Delta}(\lambda^\theta)$ such that $T(\tilde{W}) = W$.

There is an increasing filtration $0 = W_0 \subset W_1 \subset W_2 \subset \dots$ of \mathfrak{g} -modules for W satisfying the properties of Proposition 5.1. For each $i > 0$, let v_i be a weight vector in W_i such that $v_i + W_{i-1}$ is a non-zero highest weight vector of W_i/W_{i-1} . Observe that $\tilde{\Delta}(\lambda^\theta) = \bigoplus_{\mu \in P^+} L(\tilde{\mathfrak{l}}, \mu^\theta)^{m(\mu)}$ and $\Delta(\lambda) = \bigoplus_{\mu \in P^+} L(\mathfrak{l}, \mu)^{m(\mu)}$ are completely reducible $\tilde{\mathfrak{l}}$ - and \mathfrak{l} -modules, respectively. Then, for each $i > 0$, there is a highest weight vector \tilde{v}_i of the $\tilde{\mathfrak{l}}$ -module $U(\tilde{\mathfrak{l}})v_i$ with respect to the Borel subalgebra $\tilde{\mathfrak{b}} \cap \tilde{\mathfrak{l}}$. Let \tilde{W}_i be the submodule of $\tilde{\Delta}(\lambda^\theta)$ generated by $\tilde{v}_1, \tilde{v}_2, \dots, \tilde{v}_i$ and set $\tilde{W}_0 = 0$. It is easy to see \tilde{v}_i is a highest weight vector of the $\tilde{\mathfrak{g}}$ -module $\tilde{W}_i/\tilde{W}_{i-1}$. Let $\tilde{W} = \bigcup_{i \geq 1} \tilde{W}_i$. It is clear that $T(\tilde{W}_i/\tilde{W}_{i-1}) \cong W_i/W_{i-1}$ for all i . This implies $T(\tilde{W}_i) = W_i$ for all i and hence $T(\tilde{W}) = W$. \square

5.2. The categories $\tilde{\mathcal{O}}^{f, \bar{0}}$ and $\overline{\mathcal{O}}^{f, \bar{0}}$. Define an equivalence relation \sim on $\tilde{\mathfrak{h}}^*$ by letting $\mu \sim \nu$ if and only if $\mu - \nu$ lies in the root lattice $\mathbb{Z}\tilde{\Phi}$ of $\tilde{\mathfrak{g}}$. For each such equivalence class $[\mu]$, fix a representative $[\mu]^\circ \in \tilde{\mathfrak{h}}^*$ and declare $[\mu]^\circ$ to have \mathbb{Z}_2 -grading $\bar{0}$. For $\epsilon = \bar{0}, \bar{1}$, set (cf. [Br, §4-e] and [CL, Section 2.5] for type A)

$$\begin{aligned} \tilde{\mathfrak{h}}_\epsilon^* &= \left\{ \mu \in \tilde{\mathfrak{h}}^* \mid \sum_{r \in 1/2 + \mathbb{Z}_+} (\mu - [\mu]^\circ)(\hat{E}_r) \equiv \epsilon \pmod{2} \right\}, \text{ for } \mathfrak{r} = \mathfrak{b}, \mathfrak{c}, \mathfrak{d}, \\ \tilde{\mathfrak{h}}_\epsilon^* &= \left\{ \mu \in \tilde{\mathfrak{h}}^* \mid \sum_{i=1}^m (\mu - [\mu]^\circ)(\hat{E}_{-i}) + \sum_{r \in \mathbb{N}} (\mu - [\mu]^\circ)(\hat{E}_r) \equiv \epsilon \pmod{2} \right\}, \text{ for } \mathfrak{r} = \mathfrak{b}^\bullet. \end{aligned}$$

Recall that $\tilde{V} \in \tilde{\mathcal{O}}$ is a semisimple $\tilde{\mathfrak{h}}$ -module with $\tilde{V} = \bigoplus_{\gamma \in \tilde{\mathfrak{h}}^*} \tilde{V}_\gamma$. Then \tilde{V} acquires a natural \mathbb{Z}_2 -grading $\tilde{V} = \tilde{V}_0 \oplus \tilde{V}_1$ given by

$$(5.1) \quad \tilde{V}_\epsilon := \bigoplus_{\mu \in \tilde{\mathfrak{h}}_\epsilon^*} \tilde{V}_\mu, \quad \epsilon = \bar{0}, \bar{1},$$

which is compatible with the \mathbb{Z}_2 -grading on $\tilde{\mathfrak{g}}$.

We define $\tilde{\mathcal{O}}^{\bar{0}}$ and $\tilde{\mathcal{O}}^{f, \bar{0}}$ to be the full subcategories of $\tilde{\mathcal{O}}$ and $\tilde{\mathcal{O}}^f$, respectively, consisting of objects with \mathbb{Z}_2 -gradation given by (5.1). Note that the morphisms in $\tilde{\mathcal{O}}^{\bar{0}}$ and $\tilde{\mathcal{O}}^{f, \bar{0}}$ are of degree $\bar{0}$. For $\tilde{M} \in \tilde{\mathcal{O}}$, let $\widehat{\tilde{M}} \in \tilde{\mathcal{O}}^{\bar{0}}$ denote the $\tilde{\mathfrak{g}}$ -module \tilde{M} equipped with the \mathbb{Z}_2 -gradation given by (5.1). It is clear that $\widehat{\tilde{M}}$ is isomorphic to \tilde{M} in $\tilde{\mathcal{O}}$. Thus $\tilde{\mathcal{O}}^{\bar{0}}$

and $\widetilde{\mathcal{O}}^{\bar{0}}$ have isomorphic skeletons and hence they are equivalent categories. Similarly, $\widetilde{\mathcal{O}}^f$ and $\widetilde{\mathcal{O}}^{f,\bar{0}}$ are equivalent categories.

Analogously define $\mathcal{O}^{\bar{0}}$, $\mathcal{O}^{f,\bar{0}}$, $\overline{\mathcal{O}}^{\bar{0}}$ and $\overline{\mathcal{O}}^{f,\bar{0}}$ to be the respective full subcategories of \mathcal{O} , \mathcal{O}^f , $\overline{\mathcal{O}}$ and $\overline{\mathcal{O}}^f$ consisting of objects with \mathbb{Z}_2 -gradation given by (5.1). Similarly, $\mathcal{O}^{\bar{0}} \cong \mathcal{O}$, $\overline{\mathcal{O}}^{\bar{0}} \cong \overline{\mathcal{O}}$, and also $\mathcal{O}^{f,\bar{0}} \cong \mathcal{O}^f$, $\overline{\mathcal{O}}^{f,\bar{0}} \cong \overline{\mathcal{O}}^f$. (In case of \mathcal{O} and \mathcal{O}^f , these remarks are trivial except for the type \mathfrak{b}^\bullet which corresponds to a Lie superalgebra).

5.3. Equivalence of the categories. Recall the functors T and \overline{T} from Section 4.4. The following is the main result of this section.

Theorem 5.4. (i) $T : \widetilde{\mathcal{O}} \rightarrow \mathcal{O}$ is an equivalence of categories.

(ii) $\overline{T} : \widetilde{\mathcal{O}} \rightarrow \overline{\mathcal{O}}$ is an equivalence of categories.

Hence, the categories \mathcal{O} and $\overline{\mathcal{O}}$ are equivalent.

Since $\overline{\mathcal{O}}^{\bar{0}} \cong \overline{\mathcal{O}}$ and $\widetilde{\mathcal{O}}^{\bar{0}} \cong \widetilde{\mathcal{O}}$ it is enough to prove Theorem 5.4 for $\overline{\mathcal{O}}^{\bar{0}}$ and $\widetilde{\mathcal{O}}^{\bar{0}}$. In order to keep notation simple we will from now on drop the superscript $\bar{0}$ and use $\overline{\mathcal{O}}$, $\widetilde{\mathcal{O}}$, $\overline{\mathcal{O}}^f$ and $\widetilde{\mathcal{O}}^f$ to denote the respective categories $\overline{\mathcal{O}}^{\bar{0}}$, $\widetilde{\mathcal{O}}^{\bar{0}}$, $\overline{\mathcal{O}}^{f,\bar{0}}$ and $\widetilde{\mathcal{O}}^{f,\bar{0}}$ for the remainder of Section 5. Henceforth, when we write $\widetilde{\Delta}(\lambda^\theta), \widetilde{L}(\lambda^\theta) \in \widetilde{\mathcal{O}}^f$, $\lambda \in P^+$, we will mean the corresponding modules equipped with the \mathbb{Z}_2 -gradation (5.1). Similar convention applies to $\overline{\Delta}(\lambda^\natural)$ and $\overline{L}(\lambda^\natural)$.

For $M, N \in \mathcal{O}$ and $i \in \mathbb{N}$ the i th extension group $\text{Ext}_{\mathcal{O}}^i(M, N)$ can be understood in the sense of Baer-Yoneda (see e.g. [Mit, Chapter VII]) and $\text{Ext}_{\mathcal{O}}^0(M, N) := \text{Hom}_{\mathcal{O}}(M, N)$. In a similar way extensions in $\overline{\mathcal{O}}$ and $\widetilde{\mathcal{O}}$ are interpreted. From this viewpoint the exact functors T and \overline{T} induce natural maps on extensions by taking the projection of the corresponding exact sequences.

Theorem 5.5. We have the following.

(i) $T : \widetilde{\mathcal{O}}^f \rightarrow \mathcal{O}^f$ is an equivalence of categories.

(ii) $\overline{T} : \widetilde{\mathcal{O}}^f \rightarrow \overline{\mathcal{O}}^f$ is an equivalence of categories.

(iii) The categories \mathcal{O}^f and $\overline{\mathcal{O}}^f$ are equivalent.

Theorem 5.5 can be proved following a similar strategy as the one used to prove [CL, Theorem 5.1]. To avoid repeating similar arguments at great length we will just point out the main differences between their proofs. In [CL, Section 5] the main point is to prove that the functor T induces isomorphisms $\text{Hom}_{\overline{\mathcal{O}}}(\widetilde{M}, \widetilde{N}) \cong \text{Hom}_{\mathcal{O}}(M, N)$ and $\text{Ext}_{\overline{\mathcal{O}}}^1(\widetilde{L}, \widetilde{N}) \cong \text{Ext}_{\mathcal{O}}^1(L, N)$, for \widetilde{L} irreducible, and $\widetilde{M}, \widetilde{N}$ having finite composition series. From this [CL, Theorem 5.1] is derived easily. As the isomorphism of the Hom spaces imply the isomorphism of the Ext^1 spaces [CL, Lemma 5.12], we are reduced to establish the isomorphism of the Hom spaces. To prove the isomorphism of the Hom spaces therein, the idea is to prove this isomorphism first for \widetilde{M} irreducible, and then to use induction on the length of the composition series of \widetilde{M} to establish the general case.

Now, thanks to Proposition 5.3, we can proceed similarly as in [CL, Section 5] to prove Theorem 5.5. For this purpose we replace \widetilde{L} by a highest weight module, and

\widetilde{M} and \widetilde{N} by finitely generated modules. As finitely generated modules possess finite filtrations whose subquotients are highest weight modules (cf. Proposition 5.2), we can now borrow the same type of induction arguments from [CL], now inducting on the length of such a filtration instead of the length of a composition series. Therefore, the proof of the isomorphisms is again reduced to a special case, namely when \widetilde{M} is a highest weight module. This case can then be proved using similar arguments as the ones given in the proof of [CL, Lemmas 5.8]. The case of \overline{T} is completely analogous.

Having Theorem 5.5 at our disposal we can now prove Theorem 5.4.

Proof of Theorem 5.4. Since the proofs of (i) and (ii) are similar, we shall only prove (i). (iii) follows from (i) and (ii). For every $M \in \mathcal{O}$, there is an increasing filtration $0 = M_0 \subset M_1 \subset M_2 \subset \cdots$ of \mathfrak{g} -modules for M with $M_i \in \mathcal{O}^f$ satisfying the properties of Proposition 5.1. The filtration $\{M_i\}$ of M lifts to a filtration $\{\widetilde{M}_i\}$ with $\widetilde{M}_i \in \widetilde{\mathcal{O}}^f$ such that $T(\widetilde{M}_i) \cong M_i$ by Theorem 5.5. It is clear that we have $\widetilde{M} := \bigcup_{i \geq 0} \widetilde{M}_i \in \widetilde{\mathcal{O}}$ and $T(\widetilde{M}) \cong M$.

It is well known that a full and faithful functor $F : \mathcal{C} \mapsto \mathcal{C}'$, satisfying the property that for every $M' \in \mathcal{C}'$ there exists $M \in \mathcal{C}$ with $F(M) \cong M'$, is an equivalence of categories (see e.g. [Pop, Proposition 1.5.2]).

Therefore it remains to show that T is full and faithful. By Proposition 5.1, for $\widetilde{M} \in \widetilde{\mathcal{O}}$, we may choose an increasing filtration of $\widetilde{\mathfrak{g}}$ -modules $0 = \widetilde{M}_0 \subset \widetilde{M}_1 \subset \widetilde{M}_2 \subset \cdots$ such that $\bigcup_{i \geq 0} \widetilde{M}_i = \widetilde{M}$ and $\widetilde{M}_i/\widetilde{M}_{i-1}$ is a highest weight module of highest weight ν_i^θ with $\nu_i \in P^+$, for $i \geq 1$. Then the direct limit of \widetilde{M}_i is $\varinjlim \widetilde{M}_i \cong \widetilde{M}$ and $\text{Hom}_{\widetilde{\mathcal{O}}}(\widetilde{M}, \widetilde{N}) \cong \varprojlim \text{Hom}_{\widetilde{\mathcal{O}}}(\widetilde{M}_i, \widetilde{N})$ for every $\widetilde{N} \in \widetilde{\mathcal{O}}$. Similarly we have $\varinjlim M_i \cong M$ and $\text{Hom}_{\mathcal{O}}(M, N) \cong \varprojlim \text{Hom}_{\mathcal{O}}(M_i, N)$ for $N = T(\widetilde{N})$. Furthermore, we have the following commutative diagram (where $\varphi = \varprojlim T_{\widetilde{M}_i, \widetilde{N}}$):

$$\begin{array}{ccc} \text{Hom}_{\widetilde{\mathcal{O}}}(\widetilde{M}, \widetilde{N}) & \xrightarrow{\cong} & \varprojlim \text{Hom}_{\widetilde{\mathcal{O}}}(\widetilde{M}_i, \widetilde{N}) \\ \downarrow T_{\widetilde{M}, \widetilde{N}} & & \downarrow \varphi \\ \text{Hom}_{\mathcal{O}}(M, N) & \xrightarrow{\cong} & \varprojlim \text{Hom}_{\mathcal{O}}(M_i, N) \end{array}$$

Using a similar argument as the one given in [CL, Lemma 5.10], where we replace the induction on the length of composition series therein by induction on the length of finite increasing filtration $0 = \widetilde{M}_0 \subset \widetilde{M}_1 \subset \widetilde{M}_2 \subset \cdots \subset \widetilde{M}_i$, we show that $T_{\widetilde{M}_i, \widetilde{N}} : \text{Hom}_{\widetilde{\mathcal{O}}}(\widetilde{M}_i, \widetilde{N}) \rightarrow \text{Hom}_{\mathcal{O}}(M_i, N)$ are isomorphisms for each i . Therefore φ is an isomorphism and hence $T_{\widetilde{M}, \widetilde{N}}$ is an isomorphism. This completes the proof. \square

6. FINITE DIMENSIONAL REPRESENTATIONS

The main purpose of this section is to determine the extremal weights of finite dimensional irreducible modules over the ortho-symplectic Lie superalgebras with integral highest weights. It follows that all such finite dimensional irreducible modules for the

ortho-symplectic Lie superalgebras are in the category $\overline{\mathcal{O}}_n$. We note that the finite dimensional irreducible modules of non-integral highest weights are typical and so their characters are known [K2, Theorem 1].

6.1. Extremal weights for $\mathfrak{osp}(2m+1|2n)$. Let us denote the weights of the natural $\mathfrak{osp}(2m+1|2n)$ -module $\mathbb{C}^{2n|2m+1}$ by $\pm\delta_i, 0, \pm\bar{\epsilon}_j$ for $1 \leq i \leq n, 1 \leq j \leq m$. We call a weight *integral*, if it lies in \mathbb{Z} -span of the δ_i 's and $\bar{\epsilon}_j$'s. The *standard* Borel subalgebra \mathcal{B}^{st} of $\mathfrak{osp}(2m+1|2n)$ is the one associated to the following set of simple roots

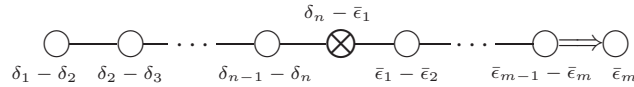

An arbitrary Dynkin diagram for $\mathfrak{osp}(2m+1|2n)$ always has a type *A* end while the other end is a short (even or odd) root. Starting from the type *A* end, the simple roots for a Borel subalgebra \mathcal{B} of $\mathfrak{osp}(2m+1|2n)$ give rise to a sequence of d_1 δ 's, e_1 $\bar{\epsilon}$'s, d_2 δ 's, e_2 $\bar{\epsilon}$'s, \dots , d_r δ 's, e_r $\bar{\epsilon}$'s and sequences of ± 1 's: $(\xi_i)_{1 \leq i \leq n} \cup (\eta_j)_{1 \leq j \leq m}$ (all the d_i and e_j are positive except possibly $d_1 = 0$ or $e_r = 0$). Note that a Dynkin diagram contains a short *odd* root exactly when $e_r = 0$. Let

$$\mathbf{d}_u = \sum_{a=1}^u d_a, \quad \mathbf{e}_u = \sum_{a=1}^u e_a$$

for $u = 1, \dots, r$, and let $\mathbf{d}_0 = \mathbf{e}_0 = 0$. Note $\mathbf{d}_r = n, \mathbf{e}_r = m$. More precisely, there exist a permutation s of $\{1, \dots, n\}$ and a permutation t of $\{1, \dots, m\}$, so that the simple roots for \mathcal{B} are given by

$$\begin{aligned} & \xi_i \delta_{s(i)} - \xi_{i+1} \delta_{s(i+1)}, \quad 1 \leq i \leq n, \quad i \notin \{\mathbf{d}_u | u = 1, \dots, r\}; \\ & \eta_j \bar{\epsilon}_{t(j)} - \eta_{j+1} \bar{\epsilon}_{t(j+1)}, \quad 1 \leq j \leq m, \quad j \notin \{\mathbf{e}_u | u = 1, \dots, r\}; \\ & \xi_{\mathbf{d}_u} \delta_{s(\mathbf{d}_u)} - \eta_{1+\mathbf{e}_{u-1}} \bar{\epsilon}_{t(1+\mathbf{e}_{u-1})}, \quad \text{for } 1 \leq u \leq r \text{ if } e_r > 0 \text{ (or } 1 \leq u < r \text{ if } e_r = 0); \\ & \eta_{\mathbf{e}_u} \bar{\epsilon}_{t(\mathbf{e}_u)} - \xi_{1+\mathbf{d}_u} \delta_{s(1+\mathbf{d}_u)}, \quad u = 1, \dots, r-1; \\ & \eta_{\mathbf{e}_r} \bar{\epsilon}_{t(\mathbf{e}_r)}, \quad \text{if } e_r > 0 \quad (\text{or } \xi_{\mathbf{d}_r} \delta_{s(\mathbf{d}_r)} \text{ if } e_r = 0). \end{aligned}$$

Recall a partition $\lambda = (\lambda_1, \lambda_2, \dots)$ is called an $(n|m)$ -hook partition, if $\lambda_{n+1} \leq m$ (cf. [BR, Sv]). For such a λ , we define

$$\lambda^\# = (\lambda_1, \dots, \lambda_n, \nu_1, \dots, \nu_m),$$

where (ν_1, \dots, ν_m) is the conjugated partition of $(\lambda_{n+1}, \lambda_{n+2}, \dots)$.

Lemma 6.1. [K2] *The irreducible $\mathfrak{osp}(2m+1|2n)$ -module of integral highest weight $\sum_{i=1}^n \lambda_i \delta_i + \sum_{j=1}^m \bar{\lambda}_j \bar{\epsilon}_j$ with respect to the standard Borel subalgebra is finite dimensional if and only if $(\lambda_1, \dots, \lambda_n, \bar{\lambda}_1, \dots, \bar{\lambda}_m) = \lambda^\#$ for some $(n|m)$ -hook partition λ .*

We denote by $L'(\mathfrak{osp}(2m+1|2n), \lambda^\#)$ these irreducible $\mathfrak{osp}(2m+1|2n)$ -modules with respect to the standard Borel subalgebra, to distinguish from earlier notation used for irreducible modules with respect to different Borel subalgebra. Actually the finite dimensionality criterion was given in [K2] in terms of Dynkin labels, which is known to be equivalent to the more natural labeling above in terms of $(n|m)$ -hook partitions

(cf. [SW]). Same remark applies to the finite dimensionality criterion for $\mathfrak{osp}(2m|2n)$ in Lemma 6.8 below.

Example 6.2. Suppose that the corresponding Dynkin diagram of a Borel subalgebra of $\mathfrak{osp}(9|10)$ is as follows:

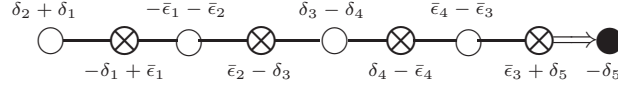

We read off from the above a signed sequence with indices $\delta_2(-\delta_1)(-\bar{\epsilon}_1)\bar{\epsilon}_2\delta_3\delta_4\bar{\epsilon}_4\bar{\epsilon}_3(-\delta_5)$. In particular, we obtain a sequence $\delta\bar{\delta}\bar{\epsilon}\bar{\epsilon}\delta\delta\bar{\epsilon}\bar{\epsilon}\delta$ by ignoring the signs and indices. In this case, $d_1 = d_2 = 2, d_3 = 1$, and $e_1 = e_2 = 2$. Furthermore, the sequences $(\xi_i)_{1 \leq i \leq 5}$ and $(\eta_j)_{1 \leq j \leq 4}$ are $(1, -1, 1, 1, -1)$ and $(-1, 1, 1, 1)$, respectively.

Define the *block Frobenius coordinates* $(p_i|q_j)$ of an $(n|m)$ -hook partition λ associated to \mathcal{B} as follows. For $1 \leq i \leq n, 1 \leq j \leq m$, let

$$\begin{aligned} p_i &= \max\{\lambda_i - \mathbf{e}_u, 0\}, & \text{if } \mathbf{d}_u < i \leq \mathbf{d}_{u+1} \text{ for some } 0 \leq u \leq r-1 \\ q_j &= \max\{\lambda'_j - \mathbf{d}_{u+1}, 0\}, & \text{if } \mathbf{e}_u + 1 < j \leq \mathbf{e}_{u+1} \text{ for some } 0 \leq u \leq r-1. \end{aligned}$$

It is elementary to read off the block Frobenius coordinates of λ from the Young diagram of λ in general, as illustrated by the next example.

Example 6.3. Consider the $(5, 4)$ -hook diagram $\lambda = (14, 11, 8, 8, 7, 4, 3, 2)$. The block Frobenius coordinates associated with \mathcal{B} from Example 6.2 for λ is:

$$p_1 = 14, p_2 = 11, p_3 = p_4 = 6, p_5 = 3; \quad q_1 = q_2 = 6, q_3 = 3, q_4 = 2.$$

These are read off from the Young diagram of λ by following the $\bar{\epsilon}\delta$ sequence $\delta\bar{\delta}\bar{\epsilon}\bar{\epsilon}\delta\delta\bar{\epsilon}\bar{\epsilon}\delta$ as follows:

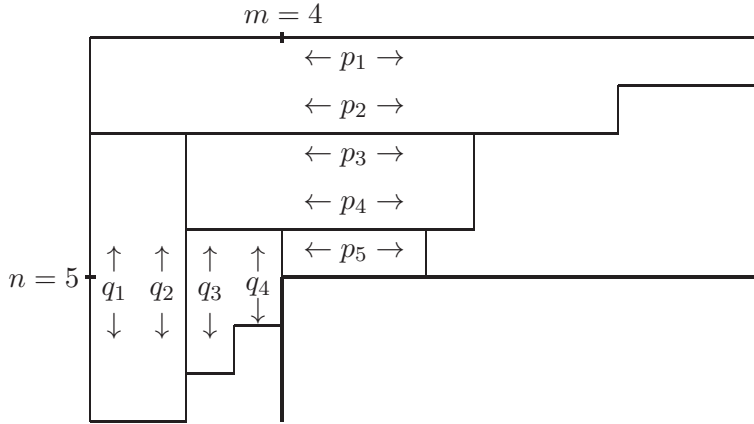

Theorem 6.4. Let λ be an $(n|m)$ -hook partition. Let \mathcal{B} be a Borel subalgebra of $\mathfrak{osp}(2m+1|2n)$ and retain the above notation. Then, the \mathcal{B} -highest weight of the simple

$\mathfrak{osp}(2m+1|2n)$ -module $L'(\mathfrak{osp}(2m+1|2n), \lambda^\#)$ is

$$\lambda^{\mathcal{B}} := \sum_{i=1}^n \xi_i p_i \delta_{s(i)} + \sum_{j=1}^m \eta_j q_j \bar{\epsilon}_{t(j)}.$$

Proof. Let us consider an odd reflection that changes a Borel subalgebra \mathcal{B}_1 to \mathcal{B}_2 . Assume the theorem holds for \mathcal{B}_1 . We observe by Lemma 4.1 that the statement of the theorem for \mathcal{B}_2 follows from the validity of the theorem for \mathcal{B}_1 . The statement of the theorem is apparently consistent with a change of Borel subalgebras induced from a real reflection, and all Borel subalgebras are linked by a sequence of real and odd reflections. Hence, once we know the theorem holds for one particular Borel subalgebra, it holds for all. We finally note that the theorem holds for the standard Borel subalgebra \mathcal{B}^{st} , which corresponds to the sequence of n δ 's followed by m $\bar{\epsilon}$'s with all signs ξ_i and η_j being positive, i.e., $\lambda^{\mathcal{B}^{\text{st}}} = \lambda^\#$. \square

Example 6.5. With respect to the Borel \mathcal{B} of $\mathfrak{osp}(9|10)$ as in Example 6.2, the \mathcal{B} -extremal weight of $L'(\mathfrak{osp}(9|10), \lambda^\#)$ for λ as in Example 6.3 equals to

$$-11\delta_1 + 14\delta_2 + 6\delta_3 + 6\delta_4 - 3\delta_5 - 6\bar{\epsilon}_1 + 6\bar{\epsilon}_2 + 2\bar{\epsilon}_3 + 3\bar{\epsilon}_4.$$

Corollary 6.6. *Every finite dimensional irreducible $\mathfrak{osp}(2m+1|2n)$ -module of integral highest weight is self-contragredient.*

Proof. Denote by \mathcal{B}^{op} the opposite Borel to the standard one \mathcal{B}^{st} . It follows by Theorem 6.4 that the \mathcal{B}^{op} -extremal weight of the module $L'(\mathfrak{osp}(2m+1|2n), \lambda^\#)$ is $-\lambda^\#$. \square

Recall that the following Dynkin diagram of $\mathfrak{osp}(2m+1|2n)$ and of its (trivial) central extension $\bar{\mathfrak{g}}_n^{\text{b}}$ has been in use from the point of view of super duality and it is opposite to the one associated to the standard Borel \mathcal{B}^{st} .

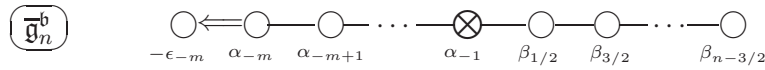

Setting $\bar{\epsilon}_j = \epsilon_{-m+j-1}$ and $\delta_i = \epsilon_{n-i+1/2}$ to match the notation in this section with the one used earlier, we have the following immediate corollary of Lemma 6.1 and Theorem 6.4.

Corollary 6.7. *An irreducible integral highest weight $\mathfrak{osp}(2m+1|2n)$ -module with respect to the Borel subalgebra corresponding to $(\bar{\mathfrak{g}}_n^{\text{b}})$ is finite dimensional if and only if the highest weight is of the form*

$$(6.1) \quad -\sum_{j=1}^m \max\{\lambda'_j - n, 0\} \epsilon_{-j} - \sum_{i=1}^n \lambda_{n-i+1} \epsilon_{i-1/2},$$

where $\lambda = (\lambda_1, \lambda_2, \dots)$ is an $(n|m)$ -hook partition.

6.2. Extremal weights for $\mathfrak{osp}(2m|2n)$. Let us denote the weights of the natural $\mathfrak{osp}(2m|2n)$ -module $\mathbb{C}^{2n|2m}$ by $\pm\delta_i, \pm\bar{\epsilon}_j$ for $1 \leq i \leq n, 1 \leq j \leq m$. The *standard* Borel subalgebra \mathcal{B}^{st} of $\mathfrak{osp}(2m|2n)$ is the one associated to the following set of simple roots

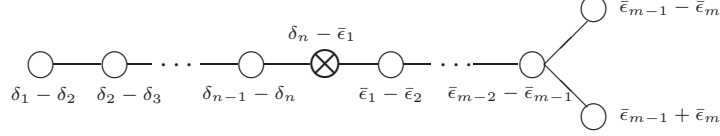

There are two kinds of Dynkin diagrams and corresponding Borel subalgebras for $\mathfrak{osp}(2m|2n)$:

- (i) Diagrams of \lrcorner -shape, i.e., Dynkin diagrams with a long simple root $\pm 2\delta_i$.
- (ii) Diagrams of Υ -shape, i.e., Dynkin diagrams with no long simple root.

We will follow the notation for $\mathfrak{osp}(2m+1|2n)$ in Subsection 6.1 for sets of simple roots in terms of signed $\bar{\epsilon}\delta$ sequences, so we have permutations s, t , and signs ξ_i, η_j . We fix an ambiguity on the choice of the sign η_m associated to a Borel \mathcal{B} of Υ -shape, by demanding the total number of negative signs among $\eta_j (1 \leq j \leq m)$ to be always even.

Let λ be an $(n|m)$ -hook partition, and let the block Frobenius coordinates $(p_i|q_j)$ be as defined in Subsection 6.1. Introduce the following weights:

$$\lambda^{\mathcal{B}} := \sum_{i=1}^n \xi_i p_i \delta_{s(i)} + \sum_{j=1}^m \eta_j q_j \bar{\epsilon}_{t(j)},$$

$$\lambda_{-}^{\mathcal{B}} := \sum_{i=1}^n \xi_i p_i \delta_{s(i)} + \sum_{j=1}^{m-1} \eta_j q_j \bar{\epsilon}_{t(j)} - \eta_m q_m \bar{\epsilon}_{t(m)}.$$

The weight $\lambda_{-}^{\mathcal{B}}$ will only be used for Borel \mathcal{B} of Υ -shape. Note that $\lambda^{\mathcal{B}^{\text{st}}} = \lambda^{\#}$ and we shall denote $\lambda^{\#} := \lambda_{-}^{\mathcal{B}^{\text{st}}}$.

Given a Borel \mathcal{B} of \lrcorner -shape, we define $s(\mathcal{B})$ to be the sign of $\prod_{j=1}^m \eta_j$.

Lemma 6.8. [K2] *The irreducible $\mathfrak{osp}(2m|2n)$ -module of integral highest weight of the form $\sum_{i=1}^n \mu_i \delta_i + \sum_{j=1}^m \bar{\mu}_j \bar{\epsilon}_j$ with respect to the standard Borel subalgebra is finite dimensional if and only if $(\mu_1, \dots, \mu_n, \bar{\mu}_1, \dots, \bar{\mu}_m)$ is either $\lambda^{\#}$ or $\lambda_{-}^{\#}$ for some $(n|m)$ -hook partition λ .*

We shall denote these irreducible $\mathfrak{osp}(2m|2n)$ -modules with respect to the standard Borel by $L'(\mathfrak{osp}(2m|2n), \lambda^{\#})$ and $L'(\mathfrak{osp}(2m|2n), \lambda_{-}^{\#})$. By a similar argument as for Theorem 6.4, we establish the following.

Theorem 6.9. *Let λ be an $(n|m)$ -hook partition.*

- (1) *Assume \mathcal{B} is of Υ -shape. Then,*
 - (i) $\lambda^{\mathcal{B}}$ *is the \mathcal{B} -extremal weight for the module $L'(\mathfrak{osp}(2m|2n), \lambda^{\#})$.*
 - (ii) $\lambda_{-}^{\mathcal{B}}$ *is of the \mathcal{B} -extremal weight for the module $L'(\mathfrak{osp}(2m|2n), \lambda_{-}^{\#})$.*
- (2) *Assume \mathcal{B} is of \lrcorner -shape. Then,*
 - (i) $\lambda^{\mathcal{B}}$ *is the \mathcal{B} -extremal weight for $L'(\mathfrak{osp}(2m|2n), \lambda^{\#})$ if $s(\mathcal{B}) = +$.*
 - (ii) $\lambda^{\mathcal{B}}$ *is the \mathcal{B} -extremal weight for $L'(\mathfrak{osp}(2m|2n), \lambda_{-}^{\#})$ if $s(\mathcal{B}) = -$.*

Corollary 6.10. *For m even, every finite dimensional irreducible $\mathfrak{osp}(2m|2n)$ -module of integral highest weight is self-contragredient.*

Remark 6.11. The remaining \mathcal{B} -extremal weights for the modules $L'(\mathfrak{osp}(2m|2n), \lambda^\#)$ when $s(\mathcal{B}) = -$ or for the modules $L'(\mathfrak{osp}(2m|2n), \lambda_-^\#)$ when $s(\mathcal{B}) = +$ are rather complicated and do not seem to afford a uniform simple answer.

The following Dynkin diagram of $\mathfrak{osp}(2m|2n)$ or $\overline{\mathfrak{g}}_n^\mathfrak{d}$ that has been in use for super duality is opposite to the standard Borel \mathcal{B}^{st} .

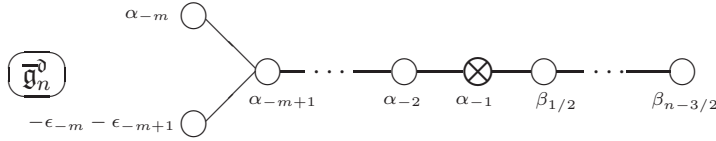

Setting $\bar{\epsilon}_j = \epsilon_{-m+j-1}$ and $\delta_i = \epsilon_{n-i+1/2}$ to match notations, we record the following corollary of Lemma 6.8 and Theorem 6.9.

Corollary 6.12. *An irreducible integral highest weight $\mathfrak{osp}(2m|2n)$ -module with respect to the Borel subalgebra corresponding to $\overline{\mathfrak{g}}_n^\mathfrak{d}$ is finite dimensional if and only if the highest weight is of the form*

$$(6.2) \quad \pm \max\{\lambda'_m - n, 0\} \epsilon_{-m} - \sum_{j=1}^{m-1} \max\{\lambda'_j - n, 0\} \epsilon_{-j} - \sum_{i=1}^n \lambda_{n-i+1} \epsilon_{i-1/2},$$

where $\lambda = (\lambda_1, \lambda_2, \dots)$ is an $(n|m)$ -hook partition.

Remark 6.13. From Corollaries 6.7 and 6.12 it follows that, after passing to the central extension $\overline{\mathfrak{g}}_n$ on which the center K acts as a scalar multiplication by $d \in \mathbb{Z}$, the weights in (6.1) and (6.2) lie in \bar{P}_n^+ whenever $d \leq -\lambda_1$. Hence, Theorem 4.8 and Lemma 3.2 provide a complete solution to the *finite dimensional* irreducible character problem for the ortho-symplectic Lie superalgebras.

Remark 6.14. Recall [BR, Sv] that finite dimensional irreducible *polynomial* $\mathfrak{gl}(n|m)$ -modules are exactly the highest weight modules $L'(\mathfrak{gl}(n|m), \lambda^\#)$ with respect to the standard Borel subalgebra parametrized by $(n|m)$ -hook partitions λ . One can assign to any Borel subalgebra \mathcal{B} of $\mathfrak{gl}(n|m)$ an $\bar{\epsilon}d$ sequence as in Section 6.1, but now with $\xi_i = \eta_j = 1$, for all i, j . By the same argument as for Theorem 6.4, we can show that the highest weights of the polynomial representations of $\mathfrak{gl}(n|m)$ with respect to \mathcal{B} is given by $\lambda^{\mathcal{B}} = \sum_{i=1}^n p_i \delta_{s(i)} + \sum_{j=1}^m q_j \bar{\epsilon}_{t(j)}$.

6.3. By flipping from the left to right the Dynkin diagram of $\overline{\mathfrak{f}}^\mathfrak{r}$ and changing all the simple roots therein to their opposites, we obtain a Dynkin diagram $\overset{\circ}{\overline{\mathfrak{f}}^\mathfrak{r}}$ corresponding to the opposite Borel subalgebras, where $\mathfrak{r} = \mathfrak{b}, \mathfrak{b}^\bullet, \mathfrak{c}, \mathfrak{d}$. Similarly, by flipping the Dynkin diagrams $\overline{\mathfrak{t}}_n$, $\overline{\mathfrak{t}}_n$ and $\overline{\mathfrak{t}}_n$ and changing all signs of the simple roots for $n \in \mathbb{N} \cup \{\infty\}$, we obtain the Dynkin diagrams $\overset{\circ}{\overline{\mathfrak{t}}_n}$, $\overset{\circ}{\overline{\mathfrak{t}}_n}$ and $\overset{\circ}{\overline{\mathfrak{t}}_n}$, respectively, of the opposite Borel subalgebras. We form the diagrams corresponding to the Borel subalgebras opposite to (2.2) as follows:



The corresponding Lie superalgebras are again \mathfrak{g} , $\overline{\mathfrak{g}}$ and $\widetilde{\mathfrak{g}}$, respectively.

The arguments in Sections 3 and 4 can be adapted easily to allow us to compare correspondingly defined parabolic categories ${}^{\circ}\mathcal{O}$, ${}^{\circ}\overline{\mathcal{O}}$ and ${}^{\circ}\widetilde{\mathcal{O}}$ using these opposite Borel subalgebras, whose precise definitions are evident. We note that for the corresponding set of weights ${}^{\circ}P^+$ of the form

$$\sum_{i=1}^m \lambda_i \epsilon_{-i} - \sum_{j \in \mathbb{N}} \lambda_j^+ \epsilon_j + d\Lambda_0, \quad d \in \mathbb{C},$$

to satisfy the corresponding dominant condition we require, besides the obvious dominant condition on the standard Levi subalgebra of $({}^{\circ}\mathbb{F}^{\mathbb{F}})$, also that $\lambda^+ = (\lambda_1^+, \lambda_2^+, \dots)$ is a partition. This allows us to prove an analogous version of Theorem 4.8 and thus to compute irreducible characters of Lie superalgebras in terms of irreducible characters of Lie algebras. Also the results in Section 4.5 and section 5 have fairly straightforward analogues in ${}^{\circ}\mathcal{O}$, ${}^{\circ}\overline{\mathcal{O}}$ and ${}^{\circ}\widetilde{\mathcal{O}}$ as well. In particular, we can prove equivalences of the corresponding finitely generated module subcategories following the strategy of Section 5.

Besides of its own interest, another virtue of this opposite version of super duality lies in the ease of calculation of finite dimensional irreducible characters of modules over the finite dimensional ortho-symplectic Lie superalgebras. As the highest weight modules over $\overline{\mathfrak{g}}$ in this setup already have highest weights over the standard Borel subalgebras, the knowledge of extremal weights for finite dimensional irreducible modules is no longer needed to imply that solution of the irreducible character problem in the category ${}^{\circ}\overline{\mathcal{O}}$ and ${}^{\circ}\widetilde{\mathcal{O}}_n$ also solves the finite dimensional irreducible character problem.

REFERENCES

- [BB] A. Beilinson and J. Bernstein, *Localisation de \mathfrak{g} -modules*, C.R. Acad. Sci. Paris Ser. I Math. **292** (1981), 15–18.
- [BL] I.N. Bernstein and D.A. Leites, *A formula for the characters of the irreducible finite dimensional representations of Lie superalgebras of series gl and sl* , C.R. Aca. Bulg. Sci. **33** (1980), 1049–51 [in Russian].
- [BK] J. L. Brylinski and M. Kashiwara, *Kazhdan-Lusztig conjecture and holonomic systems*, Invent. Math. **64** (1981), 387–410.
- [BR] A. Berele and A. Regev, *Hook Young diagrams with applications to combinatorics and representations of Lie superalgebras*, Adv. Math. **64** (1987), 118–175.
- [Br] J. Brundan, *Kazhdan-Lusztig polynomials and character formulae for the Lie superalgebra $gl(m|n)$* , J. Amer. Math. Soc. **16** (2003), 185–231.
- [BS] J. Brundan and C. Stroppel, *Highest weight categories arising from Khovanov’s diagram algebra IV: the general linear supergroup*, preprint 2009, arXiv:math.RT/0907.2543.
- [CK] S.-J. Cheng and J.-H. Kwon, *Howe duality and Kostant’s homology formula for infinite dimensional Lie superalgebras*, Int. Math. Res. Not. **2008**, Art. ID rnn 085, 52 pp.
- [CKW] S.-J. Cheng, J.-H. Kwon and W. Wang, *Kostant homology formulas for oscillator modules of Lie superalgebras*, Adv. Math. **224** (2010), 1548–1588.
- [CL] S.-J. Cheng, N. Lam, *Irreducible characters of the general linear superalgebra and super duality*, Commun. Math. Phys. **298** (2010), 645–672.
- [CW] S.-J. Cheng and W. Wang, *Brundan-Kazhdan-Lusztig and Super Duality Conjectures*, Publ. Res. Inst. Math. Sci. **44** (2008), 1219–1272.

- [CWZ] S.-J. Cheng, W. Wang and R. B. Zhang, *Super duality and Kazhdan-Lusztig polynomials*, Trans. Amer. Math. Soc. **360** (2008), 5883–5924.
- [CPS] E. Cline, B. Parshall and L. Scott, *Abstract Kazhdan-Lusztig theories*, Tohoku Math. J. **45** (1993), 511–534.
- [dJ] J. Van der Jeugt, *Character formulae for Lie superalgebra $C(n)$* , Comm. Algebra **19**, (1991), 199–222.
- [dHKT] J. Van der Jeugt, J.W.B. Hughes, R. C. King and J. Thierry-Mieg, *Character formulas for irreducible modules of the Lie superalgebras $\mathfrak{sl}(m/n)$* , J. Math. Phys. **31** (1990), 2278–2304.
- [Deo] V. Deodhar: *On some geometric aspects of Bruhat orderings II: the parabolic analogue of Kazhdan-Lusztig polynomials*, J. Algebra **111** (1987) 483–506.
- [Don] S. Donkin, *On tilting modules for algebraic groups*, Math. Z. **212** (1993), 39–60.
- [Ger] J. Germoni, *Indecomposable representations of $\mathfrak{osp}(3, 2)$, $D(2, 1; \alpha)$ and $G(3)$* . Colloquium on Homology and Representation Theory (Spanish) (Vaquerias, 1998). Bol. Acad. Nac. Cienc. (Cordoba) **65** (2000), 147–163.
- [GS] C. Gruson and V. Seganova, *Cohomology of generalized supergrassmannians and character formulae for basic classical Lie superalgebras*, arXiv:math.RT/0906.0918.
- [GL] H. Garland and J. Lepowsky, *Lie Algebra Homology and the Macdonald-Kac Formulas*, Invent. Math. **34** (1976), 37–76.
- [Ho] G. Hochschild, *Relative homological algebra*, Trans. Amer. Math. Soc. **82** (1956), 246–269.
- [K1] V. Kac, *Lie superalgebras*, Adv. Math. **16** (1977), 8–96.
- [K2] V. Kac, *Representations of classical Lie Superalgebras*, Lect. Notes in Math. **676**, pp. 597–626, Springer Verlag, 1978.
- [KW] V. Kac and M. Wakimoto, *Integrable highest weight modules over affine superalgebras and number theory*, Lie theory and geometry, 415–456, Progr. Math., **123**, Birkhauser, Boston, MA, 1994.
- [KL] D. Kazhdan and G. Lusztig, *Representations of Coxeter groups and Hecke algebras*, Invent. Math. **53** (1979), 165–184.
- [Ku] S. Kumar, *Kac-Moody groups, their flag varieties and representation theory*. Progress in Mathematics, **204**. Birkhauser Boston, Inc., Boston, MA, 2002.
- [Liu] L. Liu, *Kostant’s Formula for Kac-Moody Lie algebras*, J. Algebra **149** (1992), 155–178.
- [LSS] D. Leites, M. Saveliev and V. Serganova, *Embedding of $\mathfrak{osp}(N/2)$ and the associated non-linear supersymmetric equations*. Group theoretical methods in physics, Vol. I (Yurmala, 1985), 255–297, VNU Sci. Press, Utrecht, 1986.
- [Mit] B. Mitchell, *Theory of categories*, Pure and Applied Mathematics XVII, Academic Press, New York-San Francisco-London, 1965.
- [Pop] N. Popescu, *Abelian categories with applications to rings and modules*. London Mathematical Society Monographs **3**, Academic Press, London-New York, 1973.
- [Pen] I. Penkov, *Borel-Weil-Bott theory for classical Lie supergroups*, J. Soviet Math. **51** (1990), 2108–2140.
- [RW] A. Rocha-Caridi and N. Wallach, *Projective modules over graded Lie algebras I*, Math. Z. **180** (1982), 151–177.
- [Se] V. Serganova, *Kazhdan-Lusztig polynomials and character formula for the Lie superalgebra $\mathfrak{gl}(m|n)$* , Selecta Math. (N.S.) **2** (1996), 607–651.
- [So] W. Soergel, *Character formulas for tilting modules over Kac-Moody algebras*, Represent. Theory (electronic) **2** (1998), 432–448.
- [Sv] A. Sergeev, *The Tensor algebra of the identity representation as a module over the Lie superalgebras $\mathfrak{gl}(n, m)$ and $Q(n)$* , Math. USSR Sbornik **51** (1985), 419–427.
- [SW] B. Shu and W. Wang, *Modular representations of the ortho-symplectic supergroups*, Proc. London Math. Soc. **96** (2008), 251–271.
- [SZ] Y. Su and R.B. Zhang, *Generalised Verma modules for the orthosymplectic Lie superalgebra $\mathfrak{osp}(k|2)$* , arXiv:0911.0735.
- [Ta] J. Tanaka, *On homology and cohomology of Lie superalgebras with coefficients in their finite dimensional representations*, Proc. Japan Acad. Ser. A Math. Sci. **71** (1995), no. 3, 51–53.

- [Vo] D. Vogan, *Irreducible characters of semisimple Lie Groups II: The Kazhdan-Lusztig Conjectures*, Duke Math. J. **46** (1979), 805–859.

INSTITUTE OF MATHEMATICS, ACADEMIA SINICA, TAIPEI, TAIWAN 10617
E-mail address: `chengsj@math.sinica.edu.tw`

DEPARTMENT OF MATHEMATICS, NATIONAL CHENG-KUNG UNIVERSITY, TAINAN, TAIWAN 70101
E-mail address: `nlam@mail.ncku.edu.tw`

DEPARTMENT OF MATHEMATICS, UNIVERSITY OF VIRGINIA, CHARLOTTESVILLE, VA 22904
E-mail address: `ww9c@virginia.edu`