

# Keldysh technique and non-linear $\sigma$ -model: basic principles and applications

Alex Kamenev and Alex Levchenko

*Department of Physics, University of Minnesota, Minneapolis, MN 55455, USA*

April 27, 2009

## Abstract

The purpose of this review is to provide a comprehensive pedagogical introduction into Keldysh technique for interacting out-of-equilibrium fermionic and bosonic systems. The emphasis is placed on a functional integral representation of underlying microscopic models. A large part of the review is devoted to derivation and applications of the non-linear  $\sigma$ -model for disordered metals and superconductors. We discuss such topics as transport properties, mesoscopic effects, counting statistics, interaction corrections, kinetic equation, *etc.* The chapter devoted to disordered superconductors includes Usadel equation, fluctuation corrections, time-dependent Ginzburg–Landau theory, proximity and Josephson effects, *etc.* (This review is a substantial extension of arXiv:cond-mat/0412296.)

**Keywords:** Keldysh technique; Green functions; kinetic equation; non-linear sigma model; mesoscopic systems; fluctuating superconductors.

# Contents

<b>1</b>	<b>Introduction</b>	<b>4</b>
1.1	Motivation and outline . . . . .	4
1.2	Closed time contour . . . . .	5
<b>2</b>	<b>Bosons</b>	<b>6</b>
2.1	Partition function . . . . .	6
2.2	Green's functions . . . . .	9
2.3	Keldysh action and causality . . . . .	11
2.4	Free bosonic fields . . . . .	12
<b>3</b>	<b>Collisions and kinetic equation for bosons</b>	<b>12</b>
3.1	Interactions . . . . .	12
3.2	Saddle point equations . . . . .	14
3.3	Dyson equation . . . . .	15
3.4	Self-energy . . . . .	16
3.5	Kinetic equation . . . . .	17
<b>4</b>	<b>Particle in contact with an environment</b>	<b>19</b>
4.1	Quantum dissipative action . . . . .	19
4.2	Classical limit . . . . .	20
4.3	Langevin equation . . . . .	21
4.4	Martin-Siggia-Rose method . . . . .	21
4.5	Thermal activation . . . . .	22
4.6	Fokker-Planck equation . . . . .	23
4.7	From Matsubara to Keldysh . . . . .	25
4.8	Dissipative chains and membranes . . . . .	26
<b>5</b>	<b>Fermions</b>	<b>27</b>
5.1	Partition function . . . . .	27
5.2	Green's functions and Keldysh rotation . . . . .	28
5.3	Free fermionic fields and their action . . . . .	30
5.4	External fields and sources . . . . .	30
5.5	Applications I: Quantum transport . . . . .	33
5.5.1	Landauer formula . . . . .	33
5.5.2	Shot noise . . . . .	35
5.5.3	Coulomb drag . . . . .	36
<b>6</b>	<b>Disordered fermionic systems</b>	<b>40</b>
6.1	Disorder averaging . . . . .	41
6.2	Non-linear $\sigma$ -model . . . . .	42
6.3	Tunneling action . . . . .	45
6.4	Usadel equation . . . . .	46
6.5	Fluctuations . . . . .	47
6.6	Applications II: Mesoscopic effects . . . . .	48
6.6.1	Kubo formula and linear response . . . . .	48
6.6.2	Spectral statistics . . . . .	49
6.6.3	Universal conductance fluctuations . . . . .	51
6.6.4	Full counting statistics . . . . .	53

<b>7</b>	<b>Interactions and kinetic equation for fermions</b>	<b>54</b>
7.1	Interactions . . . . .	54
7.2	$\mathcal{K}$ Gauge . . . . .	55
7.3	Non-linear $\sigma$ -model for interacting systems . . . . .	58
7.4	Interaction propagators . . . . .	59
7.5	Kinetic equation . . . . .	59
7.6	Applications III: Interaction effects in disordered metals . . . . .	63
7.6.1	Zero-bias anomaly . . . . .	63
7.6.2	Altshuler-Aronov correction . . . . .	65
7.6.3	Relaxation rate . . . . .	67
7.6.4	Third order drag effect . . . . .	68
<b>8</b>	<b>Superconducting correlations</b>	<b>70</b>
8.1	Generalization of the $\sigma$ -model . . . . .	70
8.2	Quasiclassical approximation . . . . .	72
8.3	Time dependent Ginzburg-Landau theory . . . . .	75
8.4	Applications IV: Non-uniform and fluctuating superconductivity . . . . .	79
8.4.1	Proximity effect . . . . .	79
8.4.2	Josephson current . . . . .	80
8.4.3	Suppression of the density of states above $T_c$ . . . . .	81
8.4.4	Fluctuation corrections to the conductivity . . . . .	83
8.4.5	Tunneling conductance above $T_c$ . . . . .	86
8.4.6	Current noise in fluctuating regime . . . . .	87
<b>9</b>	<b>Concluding remarks and acknowledgments</b>	<b>89</b>
<b>A</b>	<b>Gaussian integrals for bosons and fermions</b>	<b>90</b>
<b>B</b>	<b>Single particle quantum mechanics</b>	<b>90</b>
<b>C</b>	<b>Gradient expansion of the <math>\sigma</math>-model</b>	<b>92</b>
<b>D</b>	<b>Expansion over superconducting fluctuations</b>	<b>93</b>

# 1 Introduction

## 1.1 Motivation and outline

This review is devoted to the Keldysh formalism for the treatment of out-of-equilibrium interacting many-body systems. The technique takes its name from the 1964 paper of L. V. Keldysh [1]. Among earlier approaches that are closely related to the Keldysh technique, one should mention Konstantinov and Perel [2], Schwinger [3], Kadanoff and Baym [4], and Feynman and Vernon [5]. Classical counterparts of the Keldysh technique are extremely useful and interesting on their own right. These include the Wild diagrammatic technique [6] and Martin-Siggia-Rose (MSR) method [7] for stochastic systems (see also related work of DeDominicis [8]).

There is a number of presentations of the method in the existing literature [9, 10, 11, 12, 13, 14, 15]. The emphasis of this review, which is a substantially extended version of Les Houches Session *LXXXI* lectures [16], is on the functional integration approach. It makes the structure and the internal logic of the theory substantially more clear and transparent. We focus on various applications of the method, exposing connections to other techniques such as the equilibrium Matsubara method [17, 18] and the classical Langevin and Fokker-Planck (FP) equations [19, 20]. The major part of the review is devoted to a detailed derivation of the non-linear  $\sigma$ -model (NLSM) [21, 22, 23, 24], which is probably the most powerful calculation technique in the theory of disordered metals and superconductors. This part may be considered as complimentary to earlier presentations of the replica [26, 27, 28, 29, 30] and the supersymmetric [31, 32, 33] versions of the  $\sigma$ -model.

Our aim is to expose the following applications and advantages of the Keldysh formulation of the many-body theory.

- Treatment of systems away from thermal equilibrium, either due to the presence of external fields, or in a transient regime.
- An alternative to replica and supersymmetry methods in the theory of systems with quenched disorder.
- Calculation of the full counting statistics of a quantum observable, as opposed to its average value or correlators.
- Treatment of equilibrium problems, where Matsubara analytical continuation may prove to be cumbersome.

Our intent is not to cover all applications of the technique that have appeared previously in the literature. We rather aim at a systematic and self-contained exposition, helpful for beginners. The choice of cited literature is therefore very partial and subjective. It is mainly intended to provide more in-depth details about the chosen examples, rather than a comprehensive literature guide.

The outline of the present review is as follows. We first introduce the essential elements of the Keldysh method: concept of the closed contour Sec. 1.2, Green's functions, *ext.*, starting from a simple example of non-interacting system of bosons, Sec. 2, and fermions, Sec. 5. Boson interactions, the diagrammatic technique and quantum kinetic equation are discussed in Sec. 3. Section 4 is devoted to a particle in contact with a dissipative environment (bath). This example is used to establish connections with the classical methods (Langevin, Fokker-Planck, Martin-Siggia-Rose) as well as with the equilibrium Matsubara technique. Non-interacting fermions in presence of quenched disorder are treated in Sec. 6 with the help of the Keldysh non-linear  $\sigma$ -model. It is generalized to include Coulomb interactions in Sec. 7 and superconducting correlations in Sec. 8. All technicalities are accompanied by examples of applications, intended to illustrate various aspects of the method. We cover spectral statistics in mesoscopic samples, universal conductance fluctuations (UCFs), shot noise and full counting statistics of electron transport, interaction corrections to the transport coefficients in disordered metals and superconductors, Coulomb drag, *etc.* We also devote much attention to derivations of effective phenomenological models, such as Caldeira-Leggett, time dependent Ginzburg-Landau (TDGL), Usadel, *etc.*, from the microscopic Keldysh formalism.

## 1.2 Closed time contour

Consider a quantum many–body system governed by a (possibly time–dependent) Hamiltonian  $\hat{H}(t)$ . Let us assume that in the distant past  $t = -\infty$  the system was in a state, specified by a many–body density matrix  $\hat{\rho}(-\infty)$ . The precise form of the latter is of no importance. It may be, e.g., the equilibrium density matrix associated with the Hamiltonian  $\hat{H}(-\infty)$ . The density matrix evolves according to the Von Neumann equation  $\partial_t \hat{\rho}(t) = -i[\hat{H}(t), \hat{\rho}(t)]$ , where we set  $\hbar = 1$ . It is formally solved by  $\hat{\rho}(t) = \hat{\mathcal{U}}_{t,-\infty} \hat{\rho}(-\infty) [\hat{\mathcal{U}}_{t,-\infty}]^\dagger = \hat{\mathcal{U}}_{t,-\infty} \hat{\rho}(-\infty) \hat{\mathcal{U}}_{-\infty,t}$ , where the evolution operator is given by the time–ordered exponent:

$$\hat{\mathcal{U}}_{t,t'} = \mathbb{T} \exp \left( -i \int_{t'}^t \hat{H}(\tau) d\tau \right) = \lim_{N \rightarrow \infty} e^{-i\hat{H}(t)\delta_t} e^{-i\hat{H}(t-\delta_t)\delta_t} \dots e^{-i\hat{H}(t'+\delta_t)\delta_t}, \quad (1)$$

where an infinitesimal time-step is  $\delta_t = (t - t')/N$ .

One is usually interested in calculations of expectation value for some observable  $\hat{O}$  (say density or current) at a time  $t$ , defined as

$$\langle \hat{O}(t) \rangle \equiv \frac{\text{Tr}\{\hat{O}\hat{\rho}(t)\}}{\text{Tr}\{\hat{\rho}(t)\}} = \frac{1}{\text{Tr}\{\hat{\rho}(t)\}} \text{Tr}\{\hat{\mathcal{U}}_{-\infty,t} \hat{O} \hat{\mathcal{U}}_{t,-\infty} \hat{\rho}(-\infty)\}, \quad (2)$$

where the traces are performed over the many–body Hilbert space. The expression under the last trace describes (read from right to left) evolution from  $t = -\infty$ , where the initial density matrix is specified, forward to  $t$ , where the observable is calculated, and then backward to  $t = -\infty$ . Such forward–backward evolution is avoided in the equilibrium by a specially designed trick.

Let us recall how it works, for example, in the zero–temperature quantum field theory [18]. The latter deals with the expectation values of the type  $\langle \text{GS} | \hat{O} | \text{GS} \rangle = \langle 0 | \hat{\mathcal{U}}_{-\infty,t} \hat{O} \hat{\mathcal{U}}_{t,-\infty} | 0 \rangle$ , where  $|\text{GS}\rangle = \hat{\mathcal{U}}_{t,-\infty} | 0 \rangle$  is a ground state of full interacting system. The only time dependence allowed for the Hamiltonian is an adiabatic switching of interactions on and off in the distant past and future, respectively. The evolution operator therefore describes the evolution of a simple non–interacting ground state  $|0\rangle$  toward  $|\text{GS}\rangle$  upon adiabatic switching of the interactions. Now comes the trick: one inserts the operator  $\hat{\mathcal{U}}_{+\infty,-\infty}$  in the left–most position to accomplish the evolution along the entire time axis. It is then argued that  $\langle 0 | \hat{\mathcal{U}}_{+\infty,-\infty} = \langle 0 | e^{iL}$ . This argument is based on the assumption that the system adiabatically follows its ground state upon slow switching of the interactions ”on” and ”off” in the distant past and future, respectively. Therefore, the only result of evolving the non–interacting ground–state along the entire time axis is acquiring a phase factor  $e^{iL}$ . One can then compensate for the added evolution segment by dividing this factor out. As the result:  $\langle \text{GS} | \hat{O} | \text{GS} \rangle = \langle 0 | \hat{\mathcal{U}}_{+\infty,t} \hat{O} \hat{\mathcal{U}}_{t,-\infty} | 0 \rangle / e^{iL}$  and one faces description of the evolution along the forward time axis without the backward segment. However, it comes with the price: one has to take care of the denominator (which amounts to subtracting of the so–called disconnected diagrams).

Such a trick does not work in a non–equilibrium situation with a truly time–dependent Hamiltonian. If the system was driven out of equilibrium, then the final state of its evolution does not have to coincide with the initial one. In general, such a final state depends on the peculiarities of the switching procedure as well as on the entire history of the system. Thus, one can not get rid of the backward portion of the evolution history contained in (2). Schwinger [3] was the first to realize that this is not an unsurmountable obstacle. One has to accept that the evolution in the non–equilibrium quantum field theory takes place along the closed time contour. Along with the conventional forward path, the latter contains the backward path. In this way one avoids the need to know the state of the system at  $t = +\infty$ .

It is still convenient to extend the evolution in (2) to  $t = +\infty$  and back to  $t$ . It is important to mention that this operation is identical and does not require any additional assumptions. Inserting  $\hat{\mathcal{U}}_{t,+\infty} \hat{\mathcal{U}}_{+\infty,t} = \hat{1}$  to the left of  $\hat{O}$  in (2), one obtains

$$\langle \hat{O}(t) \rangle = \frac{1}{\text{Tr}\{\hat{\rho}(-\infty)\}} \text{Tr}\{\hat{\mathcal{U}}_{-\infty,+\infty} \hat{\mathcal{U}}_{+\infty,t} \hat{O} \hat{\mathcal{U}}_{t,-\infty} \hat{\rho}(-\infty)\}. \quad (3)$$

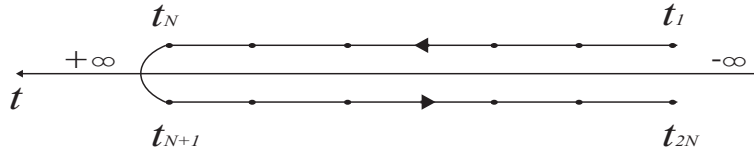

Figure 1: The closed time contour  $C$ . Dots on the forward and the backward branches of the contour denote discrete time points.

Here we also used that, according to the Von Neumann equation, the trace of the density matrix is unchanged under the unitary evolution. As a result, we have obtained the evolution along the closed time contour  $C$  depicted in Figure 1.

The observable  $\hat{O}$  is inserted at time  $t$ , somewhere along the forward branch of the contour. Note that inserting the unit operator  $\hat{U}_{t,+\infty}\hat{U}_{+\infty,t} = \hat{1}$  to the right of  $\hat{O}$ , we could equally well arrange to have an observable on the backward branch of the contour. As we show below, the most convenient choice is to take a half-sum of these two equivalent representations. The observable may be also generated by adding to the Hamiltonian a source term  $\hat{H}_O(t) \equiv \hat{H}(t) \pm \hat{O}\eta(t)/2$ , where the plus (minus) signs refer to the forward (backward) parts of the contour. One needs to calculate then the generating functional  $Z[\eta]$  defined as the trace of the evolution operator along the contour  $C$  with the Hamiltonian  $\hat{H}_O(t)$ . Since the latter is non-symmetric on the two branches, such a closed contour evolution operator is not identical to unity. The expectation value of the observable may then be generated as the result of functional differentiation  $\langle \hat{O}(t) \rangle = \delta Z[\eta]/\delta \eta(t)|_{\eta=0}$ . We first omit the source term and develop a convenient representation for the partition function

$$Z[0] \equiv \frac{\text{Tr}\{\hat{U}_C \hat{\rho}(-\infty)\}}{\text{Tr}\{\hat{\rho}(-\infty)\}} = 1, \quad (4)$$

where  $\hat{U}_C = \hat{U}_{-\infty,+\infty}\hat{U}_{+\infty,-\infty} = \hat{1}$ . The source term, breaking the forward-backward symmetry, will be discussed at a later stage. Note that since  $Z[0] = 1$ , the observable may be equally well written in the form, which is more familiar from the equilibrium context:  $\langle \hat{O}(t) \rangle = \delta \ln Z[\eta]/\delta \eta(t)|_{\eta=0}$ . The logarithm is *optional* in the theory with the closed time contour.

The need to carry the evolution along the two-branch contour complicates the non-equilibrium theory in comparison with the equilibrium theory. The difficulties may be substantially reduced by a proper choice of variables based on the forward-backward symmetry of the theory. There are also good news: there is no denominator  $e^{iL}$ , unavoidably present in the single-branch contour theory. (One should not worry about  $\text{Tr}\{\hat{\rho}(-\infty)\}$  in (4). Indeed, this quantity refers entirely to  $t = -\infty$ , before the interactions were adiabatically switched "on". As a result, it is trivially calculated and never represents a problem.) The absence of the denominator dramatically simplifies description of systems with the quenched disorder. It is the denominator,  $e^{iL}$ , which is the main obstacle in performing the disorder averaging of the expectation values of observables. To overcome this obstacle the replica [25, 26, 27] and the supersymmetry [31, 32] tricks were invented. In the closed time contour theory the denominator is absent and thus there is no need in any of these tricks.

## 2 Bosons

### 2.1 Partition function

Let us consider the simplest many-body system: bosonic particles occupying a single quantum state with energy  $\omega_0$ . Its secondary quantized Hamiltonian has the form

$$\hat{H} = \omega_0 \hat{b}^\dagger \hat{b}, \quad (5)$$

where  $\hat{b}^\dagger$  and  $\hat{b}$  are bosonic creation and annihilation operators with the commutation relation  $[\hat{b}, \hat{b}^\dagger] = 1$ . Let us define the partition function as

$$Z = \frac{\text{Tr}\{\hat{\mathcal{U}}_C \hat{\rho}\}}{\text{Tr}\{\hat{\rho}\}}. \quad (6)$$

If one assumes that all external fields are exactly the same on the forward and backward branches of the contour, then  $\hat{\mathcal{U}}_C = 1$  and, therefore,  $Z = 1$ . The initial density matrix  $\hat{\rho} = \hat{\rho}(\hat{H})$  is some operator-valued function of the Hamiltonian. To simplify the derivations one may choose it to be the equilibrium density matrix,  $\hat{\rho}_0 = \exp\{-\beta(\hat{H} - \mu\hat{N})\} = \exp\{-\beta(\omega_0 - \mu)\hat{b}^\dagger\hat{b}\}$ . Since arbitrary external perturbations may be switched on (and off) at a later time, the choice of the equilibrium initial density matrix does not prevent one from treating non-equilibrium dynamics. For the equilibrium initial density matrix one finds

$$\text{Tr}\{\hat{\rho}_0\} = \sum_{n=0}^{\infty} e^{-\beta(\omega_0 - \mu)n} = [1 - \rho(\omega_0)]^{-1}, \quad (7)$$

where  $\rho(\omega_0) = e^{-\beta(\omega_0 - \mu)}$ . An important point is that, in general,  $\text{Tr}\{\hat{\rho}\}$  is an interaction- and disorder-independent constant. Indeed, both interactions and disorder are supposed to be switched on (and off) on the forward (backward) parts of the contour sometime after (before)  $t = -\infty$ . This constant is, therefore, frequently omitted without causing a confusion.

The next step is to divide the  $C$  contour into  $(2N - 2)$  time-steps of length  $\delta_t$ , such that  $t_1 = t_{2N} = -\infty$  and  $t_N = t_{N+1} = +\infty$  as shown in Figure 1. One then inserts the resolution of unity in the over-complete coherent state basis<sup>1</sup> [34]

$$\hat{1} = \iint \frac{d(\text{Re}\phi_j)d(\text{Im}\phi_j)}{\pi} e^{-|\phi_j|^2} |\phi_j\rangle\langle\phi_j| \quad (8)$$

at each point  $j = 1, 2, \dots, 2N$  along the contour. For example, for  $N = 3$  one obtains the following sequence in the expression for  $\text{Tr}\{\hat{\mathcal{U}}_C \hat{\rho}_0\}$  (read from right to left):

$$\langle\phi_6|\hat{\mathcal{U}}_{-\delta_t}|\phi_5\rangle\langle\phi_5|\hat{\mathcal{U}}_{-\delta_t}|\phi_4\rangle\langle\phi_4|\hat{1}|\phi_3\rangle\langle\phi_3|\hat{\mathcal{U}}_{+\delta_t}|\phi_2\rangle\langle\phi_2|\hat{\mathcal{U}}_{+\delta_t}|\phi_1\rangle\langle\phi_1|\hat{\rho}_0|\phi_6\rangle, \quad (9)$$

where  $\hat{\mathcal{U}}_{\pm\delta_t}$  is the evolution operator during the time interval  $\delta_t$  in the positive (negative) time direction. Its matrix elements are given by:

$$\begin{aligned} \langle\phi_{j+1}|\hat{\mathcal{U}}_{\pm\delta_t}|\phi_j\rangle &\equiv \langle\phi_{j+1}|e^{\mp i\hat{H}(\hat{b}^\dagger, \hat{b})\delta_t}|\phi_j\rangle \approx \langle\phi_{j+1}|(1 \mp i\hat{H}(\hat{b}^\dagger, \hat{b})\delta_t)|\phi_j\rangle \\ &= \langle\phi_{j+1}|\phi_j\rangle(1 \mp iH(\bar{\phi}_{j+1}, \phi_j)\delta_t) \approx \langle\phi_{j+1}|\phi_j\rangle e^{\mp iH(\bar{\phi}_{j+1}, \phi_j)\delta_t}, \end{aligned} \quad (10)$$

where the approximate equalities are valid up to the linear order in  $\delta_t$ . Obviously this result is not restricted to the toy example (5), but holds for any *normally ordered* Hamiltonian. Note that there is no evolution operator inserted between  $t_N$  and  $t_{N+1}$ . Indeed, these two points are physically indistinguishable and thus the system does not evolve during this time interval. Employing the following properties of coherent states:  $\langle\phi|\phi'\rangle = \exp\{\bar{\phi}\phi'\}$  along with  $\langle\phi|e^{-\beta(\omega_0 - \mu)\hat{b}^\dagger\hat{b}}|\phi'\rangle = \exp\{\bar{\phi}\phi'\rho(\omega_0)\}$ , and collecting all of the matrix elements along the contour, one finds for the partition function (6),

$$Z = \frac{1}{\text{Tr}\{\hat{\rho}_0\}} \iint \prod_{j=1}^{2N} \left[ \frac{d(\text{Re}\phi_j)d(\text{Im}\phi_j)}{\pi} \right] \exp\left( i \sum_{j,j'=1}^{2N} \bar{\phi}_j G_{jj'}^{-1} \phi_{j'} \right), \quad (11)$$

<sup>1</sup>The Bosonic coherent state  $|\phi\rangle$  ( $\langle\phi|$ ), parameterized by a complex number  $\phi$ , is defined as a right (left) eigenstate of the annihilation (creation) operator:  $\hat{b}|\phi\rangle = \phi|\phi\rangle$  ( $\langle\phi|\hat{b}^\dagger = \langle\phi|\bar{\phi}$ ). Matrix elements of a *normally ordered* operator, such as Hamiltonian, take the form  $\langle\phi|\hat{H}(\hat{b}^\dagger, \hat{b})|\phi'\rangle = H(\bar{\phi}, \phi')\langle\phi|\phi'\rangle$ . The overlap between two coherent states is  $\langle\phi|\phi'\rangle = \exp\{\bar{\phi}\phi'\}$ . Since the coherent state basis is over-complete, the trace of an operator,  $\hat{A}$ , is calculated with the weight:  $\text{Tr}\{\hat{A}\} = \pi^{-1} \iint d(\text{Re}\phi)d(\text{Im}\phi) e^{-|\phi|^2} \langle\phi|\hat{A}|\phi\rangle$ .

where the  $2N \times 2N$  matrix  $iG_{jj'}^{-1}$  stands for

$$iG_{jj'}^{-1} \equiv \left[ \begin{array}{ccc|ccc} -1 & & & & & \rho(\omega_0) \\ 1-h & -1 & & & & \\ & 1-h & -1 & & & \\ \hline & & & 1 & & \\ & & & -1 & & \\ & & & 1+h & -1 & \\ & & & & 1+h & -1 \end{array} \right], \quad (12)$$

and  $h \equiv i\omega_0\delta_t$ . It is straightforward to evaluate the determinant of such a matrix

$$\text{Det}[i\hat{G}^{-1}] = (-1)^{2N} - \rho(\omega_0)(1-h^2)^{N-1} \approx 1 - \rho(\omega_0)e^{(\omega_0\delta_t)^2(N-1)} \rightarrow 1 - \rho(\omega_0), \quad (13)$$

where one used that  $\delta_t^2 N \rightarrow 0$  if  $N \rightarrow \infty$  (indeed, the assumption was  $\delta_t N \rightarrow \text{const}$ ). Employing the fact that the Gaussian integral in (11) is equal to the inverse determinant of  $i\hat{G}^{-1}$  matrix, see Appendix A, along with (7), one finds

$$Z = \frac{\text{Det}^{-1}[i\hat{G}^{-1}]}{\text{Tr}\{\hat{\rho}_0\}} = 1, \quad (14)$$

as it should be, of course. Note that keeping the upper-right element of the discrete matrix (12) is crucial to maintaining this normalization identity.

One may now take the limit  $N \rightarrow \infty$  and formally write the partition function in the continuum notations,  $\phi_j \rightarrow \phi(t)$ , as

$$Z = \int \mathbf{D}[\bar{\phi}\phi] \exp(iS[\bar{\phi}, \phi]) = \int \mathbf{D}[\bar{\phi}\phi] \exp\left(i \int_C dt [\bar{\phi}(t) \hat{G}^{-1} \phi(t)]\right), \quad (15)$$

where according to (11)–(12) the action is given by

$$S[\bar{\phi}, \phi] = \sum_{j=2}^{2N} \left[ i\bar{\phi}_j \frac{\phi_j - \phi_{j-1}}{\delta t_j} - \omega_0 \bar{\phi}_j \phi_{j-1} \right] \delta t_j + i\bar{\phi}_1 [\phi_1 - \rho(\omega_0)\phi_{2N}], \quad (16)$$

with  $\delta t_j \equiv t_j - t_{j-1} = \pm\delta_t$ . Thus, the continuum form of the operator  $\hat{G}^{-1}$  is

$$\hat{G}^{-1} = i\partial_t - \omega_0. \quad (17)$$

It is important to remember that this continuum notation is only an abbreviation that represents the large discrete matrix (12). In particular, the upper-right element of the matrix (the last term in (16)), which contains the information about the distribution function, is seemingly absent in the continuum notation (17).

To avoid integration along the closed time contour, it is convenient to split the bosonic field  $\phi(t)$  into the two components  $\phi_+(t)$  and  $\phi_-(t)$  that reside on the forward and the backward parts of the time contour, respectively. The continuum action may be then rewritten as

$$S[\bar{\phi}, \phi] = \int_{-\infty}^{+\infty} dt [\bar{\phi}_+(t)(i\partial_t - \omega_0)\phi_+(t) - \bar{\phi}_-(t)(i\partial_t - \omega_0)\phi_-(t)], \quad (18)$$

where the relative minus sign comes from the reversed direction of the time integration on the backward part of the contour. Once again, the continuum notations are somewhat misleading. Indeed, they create an undue impression that  $\phi_+(t)$  and  $\phi_-(t)$  fields are completely uncorrelated. In fact, they are correlated owing to the presence of the non-zero off-diagonal blocks in the discrete matrix (12). It is therefore desirable to develop a continuum representation that automatically takes into account the proper regularization. We shall achieve it in the following sections. First, the Green's functions should be discussed.



## 2.2 Green's functions

According to the basic properties of the Gaussian integrals, see Appendix A, the correlator of the two bosonic fields is given by

$$\langle \phi_j \bar{\phi}_{j'} \rangle \equiv \int \mathbf{D}[\bar{\phi}\phi] \phi_j \bar{\phi}_{j'} \exp\left(i \sum_{j,j'=1}^{2N} \bar{\phi}_j G_{jj'}^{-1} \phi_{j'}\right) = iG_{jj'}. \quad (19)$$

Note the absence of the factor  $Z^{-1}$  in comparison with the analogous definition in the equilibrium theory [34]. Indeed, in the present construction  $Z = 1$ . This seemingly minor difference turns out to be the major issue in the theory of disordered systems (see further discussion in Section 6, devoted to fermions with the quenched disorder). Inverting the discrete matrix in (12), one finds

$$iG_{jj'} = \frac{1}{1-\rho} \left[ \begin{array}{ccc|ccc} 1 & \rho e^h & \rho e^{2h} & \rho e^{2h} & \rho e^h & \rho \\ e^{-h} & 1 & \rho e^h & \rho e^h & \rho & \rho e^{-h} \\ e^{-2h} & e^{-h} & 1 & \rho & \rho e^{-h} & \rho e^{-2h} \\ \hline e^{-2h} & e^{-h} & 1 & 1 & \rho e^{-h} & \rho e^{-2h} \\ e^{-h} & 1 & e^h & e^h & 1 & \rho e^{-h} \\ 1 & e^h & e^{2h} & e^{2h} & e^h & 1 \end{array} \right], \quad (20)$$

where  $\rho \equiv \rho(\omega_0)$ , and following the discussion after (13), we have put  $(1 \pm h)^j \approx e^{\pm jh}$  and  $(1 - h^2)^j \approx 1$ . In terms of the fields  $\phi_{j\pm}$  (hereafter  $j = 1, \dots, N$  and therefore the  $2N \times 2N$  matrix above is labeled as  $1, \dots, N-1, N, N, N-1, \dots, 1$ ) the corresponding correlators read as

$$\langle \phi_{j+} \bar{\phi}_{j'-} \rangle \equiv iG_{jj'}^<, = n_B \exp\{-(j-j')h\}, \quad (21a)$$

$$\langle \phi_{j-} \bar{\phi}_{j'+} \rangle \equiv iG_{jj'}^>, = (n_B + 1) \exp\{-(j-j')h\}, \quad (21b)$$

$$\langle \phi_{j+} \bar{\phi}_{j'+} \rangle \equiv iG_{jj'}^{\mathbb{T}}, = \frac{1}{2} \delta_{jj'} + \theta(j-j') iG_{jj'}^>, + \theta(j'-j) iG_{jj'}^<, , \quad (21c)$$

$$\langle \phi_{j-} \bar{\phi}_{j'-} \rangle \equiv iG_{jj'}^{\bar{\mathbb{T}}}, = \frac{1}{2} \delta_{jj'} + \theta(j'-j) iG_{jj'}^>, + \theta(j-j') iG_{jj'}^<, , \quad (21d)$$

where the bosonic occupation number  $n_B$  stands for  $n_B(\omega_0) \equiv \rho/(1-\rho)$  and symbols  $\mathbb{T}$  (respectively  $\bar{\mathbb{T}}$ ) denote time-ordering (respectively anti-time-ordering). The step-function  $\theta(j)$  is defined such that  $\theta(0) = 1/2$ , so  $\theta(j) + \theta(-j) \equiv 1$ .

Obviously not all four Green's functions defined above are independent. Indeed, a direct inspection shows that

$$G^{\mathbb{T}} + G^{\bar{\mathbb{T}}} - G^> - G^< = -i\delta_{jj'}, \quad (22a)$$

$$G^{\mathbb{T}} - G^{\bar{\mathbb{T}}} = \text{sign}(j-j') (G^> - G^<), \quad (22b)$$

where  $\text{sign}(j) = \theta(j) - \theta(-j)$ . We would like to perform a linear transformation of the fields to benefit explicitly from these relations. This is achieved by the Keldysh rotation

$$\phi_j^{cl} = \frac{1}{\sqrt{2}}(\phi_{j+} + \phi_{j-}), \quad \phi_j^q = \frac{1}{\sqrt{2}}(\phi_{j+} - \phi_{j-}), \quad (23)$$

with the analogous transformation for the conjugated fields. The superscripts “cl” and “q” denote the *classical* and the *quantum* components of the fields, respectively. The rationale for this notation will become clear shortly. First, a simple algebraic manipulation with (21a)–(21d) shows that

$$-i\langle \phi_j^\alpha \bar{\phi}_{j'}^\beta \rangle = \begin{pmatrix} G_{jj'}^K & G_{jj'}^R \\ G_{jj'}^A & -\frac{i}{2} \delta_{jj'} \end{pmatrix}, \quad (24)$$

where hereafter  $\alpha, \beta = (cl, q)$ . The explicit form of the  $(q, q)$  element of this matrix is a manifestation of identity (22a). Superscripts  $R, A$  and  $K$  denote the *retarded*, *advanced* and *Keldysh* components of the Green's function, respectively. These three Green's functions are the fundamental objects of the Keldysh technique. They are defined as

$$G_{jj'}^R = -i\langle\phi_j^{cl}\bar{\phi}_{j'}^q\rangle = \theta(j-j')(G_{jj'}^> - G_{jj'}^<) = -i\theta(j-j')e^{-(j-j')h}, \quad (25a)$$

$$G_{jj'}^A = -i\langle\phi_j^q\bar{\phi}_{j'}^{cl}\rangle = \theta(j'-j)(G_{jj'}^< - G_{jj'}^>) = i\theta(j'-j)e^{-(j-j')h}, \quad (25b)$$

$$G_{jj'}^K = -i\langle\phi_j^{cl}\bar{\phi}_{j'}^{cl}\rangle = -\frac{i}{2}\delta_{jj'} + G_{jj'}^> + G_{jj'}^< = -\frac{i}{2}\delta_{jj'} - i(2n_B + 1)e^{-(j-j')h}. \quad (25c)$$

Since by definition  $[G^<]^\dagger = -G^>$  [cf. (21)], one may notice that

$$G^A = [G^R]^\dagger, \quad G^K = -[G^K]^\dagger. \quad (26)$$

The retarded (advanced) Green's function is lower (upper) triangular matrix in the time domain. Since a product of any number of triangular matrices is again a triangular matrix, one obtains the simple rule:

$$G_1^R \circ G_2^R \circ \dots \circ G_l^R = G^R, \quad (27a)$$

$$G_1^A \circ G_2^A \circ \dots \circ G_l^A = G^A, \quad (27b)$$

where the circular multiplication sign is understood as a convolution in the time domain (i.e. it implies integration over an intermediate time).

One can now take the continuum limit ( $N \rightarrow \infty$ , while  $N\delta_t \rightarrow \text{const}$ ) of the Green's functions. To this end, one defines  $t_j = j\delta_t$  and notices that  $\exp\{-(j-j')h\} \rightarrow \exp\{-i\omega_0(t-t')\}$ . A less trivial observation is that the factors  $\delta_{jj'}$ , see (24) and (25), may be omitted in the continuum limit. The reason for this is twofold: (i) all observables are given by the *off-diagonal* elements of the Green's functions, e.g. the mean occupation number at the moment  $t_j$  is given by  $\langle n_B(t_j) \rangle = iG_{jj+1}^> = iG_{jj+1}^<$ ; (ii) the intermediate expressions contain multiple sums (integrals) of the form  $\delta_t^2 \sum_{j,j'} \delta_{jj'} G_{j'j} \rightarrow \delta_t^2 N \rightarrow 0$ . As a result the proper continuum limit of the relations derived above is

$$-i\langle\phi^\alpha(t)\bar{\phi}^\beta(t')\rangle = G^{\alpha\beta}(t, t') = \begin{pmatrix} G^K(t, t') & G^R(t, t') \\ G^A(t, t') & 0 \end{pmatrix}, \quad (28)$$

where

$$G^R = -i\theta(t-t')e^{-i\omega_0(t-t')} \rightarrow (\epsilon - \omega_0 + i0)^{-1}, \quad (29a)$$

$$G^A = i\theta(t'-t)e^{-i\omega_0(t-t')} \rightarrow (\epsilon - \omega_0 - i0)^{-1}, \quad (29b)$$

$$G^K = -i[2n_B(\omega_0) + 1]e^{-i\omega_0(t-t')} \rightarrow -2\pi i[2n_B(\epsilon) + 1]\delta(\epsilon - \omega_0). \quad (29c)$$

The Fourier transforms with respect to  $t - t'$  are given for each of the three Green's functions. An important property of these Green's functions is [cf. (25)]

$$G^R(t, t) + G^A(t, t) = 0. \quad (30)$$

It is useful to introduce graphic representations for the three Green's functions. To this end, let us denote the classical component of the field by a full line and the quantum component by a dashed line. Then the retarded Green's function is represented by a full arrow-dashed line, the advanced by a dashed arrow-full line and the Keldysh by full arrow-full line, see Figure 2. Note that the dashed arrow-dashed line, which would represent the  $\langle\phi^q\bar{\phi}^q\rangle$  Green's function, is absent in the continuum limit. The arrow shows the direction from  $\phi^\alpha$  towards  $\bar{\phi}^\beta$ .

Notice that the retarded and advanced components only contain information about the spectrum and are independent of the occupation number, whereas the Keldysh component does depend on it. In thermal equilibrium  $\rho = e^{-\beta\epsilon}$ , while  $n_B = (e^{\beta\epsilon} - 1)^{-1}$  and therefore

$$G^K(\epsilon) = [G^R(\epsilon) - G^A(\epsilon)] \coth \frac{\epsilon}{2T}. \quad (31)$$

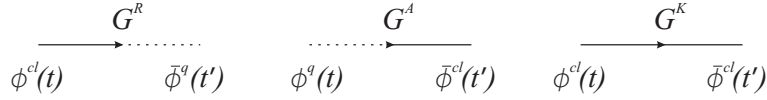

Figure 2: Graphic representation of  $G^R$ ,  $G^A$ , and  $G^K$ . The full line represents the classical field component  $\phi^{cl}$ , while the dashed line the quantum component  $\phi^q$ .

The last equation constitutes the statement of the *fluctuation–dissipation theorem* (FDT). The FDT is, of course, a general property of thermal equilibrium that is not restricted to the toy example considered here. It implies the rigid relation between the response and correlation functions in equilibrium.

In general, it is convenient to parameterize the anti–Hermitian, see (26), Keldysh Green’s function by a Hermitian matrix  $F = F^\dagger$ , as follows

$$G^K = G^R \circ F - F \circ G^A, \quad (32)$$

where  $F = F(t, t')$ , and the circular multiplication sign implies convolution. The Wigner transform (see below),  $\mathbf{f}(\tau, \epsilon)$ , of the matrix  $F$  is referred to as the *distribution function*. In thermal equilibrium  $\mathbf{f}(\epsilon) = \coth(\epsilon/2T)$  ( see (31)).

### 2.3 Keldysh action and causality

One would like to have a continuum action, written in terms of  $\phi^{cl}, \phi^q$ , that properly reproduces the correlators (28) and (29). To this end, one formally inverts the correlator matrix (28), and uses it in the Gaussian action

$$S[\phi^{cl}, \phi^q] = \iint_{-\infty}^{+\infty} dt dt' (\bar{\phi}_t^{cl}, \bar{\phi}_t^q) \begin{pmatrix} 0 & [G_{t,t'}^{-1}]^A \\ [G_{t,t'}^{-1}]^R & [G_{t,t'}^{-1}]^K \end{pmatrix} \begin{pmatrix} \phi_{t'}^{cl} \\ \phi_{t'}^q \end{pmatrix}, \quad (33)$$

where

$$[G^{-1}]^{R(A)} = [G^{R(A)}]^{-1} = \epsilon - \omega_0 \pm i0 \rightarrow \delta_{t,t'} (i\partial_t - \omega_0 \pm i0), \quad (34a)$$

$$[G^{-1}]^K = [G^R]^{-1} \circ F - F \circ [G^A]^{-1}, \quad (34b)$$

where we used that the Fourier transform of  $\epsilon$  is  $\delta_{t,t'} i\partial_t$  and parametrization (32) was employed in the last line. It is important to mention that the actual discrete matrix action (11)–(12), being transformed to  $\phi^{cl}, \phi^q$  according to (23), does *not* have the structure of (33). The action (33) should be viewed as a formal construction devised to reproduce the continuum limit of the correlators according to the rules of the Gaussian integration. It is, however, fully self–consistent in the following sense: (i) it does not need to appeal to the discrete representation for a regularization; (ii) its general structure is intact in every order of the perturbative renormalization.

Here we summarize the main features of the action (33), which, for lack of a better terminology, we call the *causality structure*.

- The  $cl - cl$  component is zero. It reflects the fact that for a pure classical field configuration ( $\phi^q = 0$ ) the action is zero. Indeed, in this case  $\phi_+ = \phi_-$  and the action on the forward part of the contour is canceled by that on the backward part (safe for the boundary terms, that may be omitted in the continuum limit). The very general statement is, therefore, that

$$S[\phi^{cl}, 0] = 0. \quad (35)$$

Obviously this statement should not be restricted to the Gaussian action of the form given by Eq. (33).

- The  $cl-q$  and  $q-cl$  components are mutually Hermitian conjugated upper and lower (advanced and retarded) triangular matrices in the time representation. This property is responsible for the causality of the response functions as well as for protecting the  $cl-cl$  component from a perturbative renormalization (see below). Relation (30) is necessary for the consistency of the theory.
- The  $q-q$  component is an anti-Hermitian matrix [cf. (26)]. In our example  $[G^K]^{-1} = i0F$ , where  $F$  is a Hermitian matrix, with a positive-definite spectrum. It is responsible for the convergence of the functional integral. It also keeps the information about the distribution function.

## 2.4 Free bosonic fields

It is a straightforward matter to generalize the entire construction to bosonic systems with more than one degree of freedom. Suppose the states are labeled by an index  $\mathbf{k}$ , that may be, e.g., a momentum vector. Their energies are given by a function  $\omega_{\mathbf{k}}$ , for example  $\omega_{\mathbf{k}} = \mathbf{k}^2/(2m)$ , where  $m$  is the mass of bosonic atoms. One introduces next a doublet of complex fields (classical and quantum) for every state  $\mathbf{k}$ ,  $(\phi^{cl}(\mathbf{k}, t), \phi^q(\mathbf{k}, t))$ , and writes down the action in the form of (33) including a summation over the index  $\mathbf{k}$ :  $F = F(\mathbf{k}, \mathbf{k}'; t, t')$ . The retarded (advanced) component, on the other hand, has the simple form  $[G^{R(A)}]^{-1} = i\partial_t - \omega_{\mathbf{k}}$ .

If  $\mathbf{k}$  is momentum, it is instructive to perform the Fourier transform to the real space and to deal with  $(\phi^{cl}(\mathbf{r}, t), \phi^q(\mathbf{r}, t))$ . Introducing a combined time-space index  $x = (\mathbf{r}, t)$ , one may write down for the action of the free complex bosonic field (atoms)

$$S_0[\phi^{cl}, \phi^q] = \iint dx dx' (\bar{\phi}_x^{cl}, \bar{\phi}_x^q) \begin{pmatrix} 0 & [G_{x,x'}^A]^{-1} \\ [G_{x,x'}^R]^{-1} & [G_{x,x'}^{-1}]^K \end{pmatrix} \begin{pmatrix} \phi_{x'}^{cl} \\ \phi_{x'}^q \end{pmatrix}, \quad (36)$$

where in the continuum notations

$$[G^{R(A)}]^{-1}(x, x') = \delta(x - x') \left( i\partial_t + \frac{1}{2m} \partial_{\mathbf{r}}^2 + \mu \right), \quad (37)$$

while in the discrete form it is a lower (upper) triangular matrix in time (not in space). The  $[G^{-1}]^K$  component for the free field is only the regularization factor, originating from the (time) boundary terms. It is, in general, non-local in  $x$  and  $x'$ , however, being a pure boundary term it is frequently omitted. It is kept here as a reminder that the inversion,  $\hat{G}$ , of the correlator matrix must possess the causality structure (28). We have introduced the chemical potential  $\mu$  into (37), understanding that one may want to consider an effective Hamiltonian  $\hat{H} - \mu\hat{N}$ , where  $\hat{N}$  is the total particle number operator. The new term may be considered as a mean to enforce a certain particle number with the help of the Lagrange multiplier  $\mu$ . For discussion of real bosonic fields see Appendix B.

## 3 Collisions and kinetic equation for bosons

### 3.1 Interactions

The short range two-body collisions of bosonic atoms are described by the local *four-boson* Hamiltonian  $\hat{H}_{\text{int}} = \lambda \sum_{\mathbf{r}} \hat{b}_{\mathbf{r}}^\dagger \hat{b}_{\mathbf{r}}^\dagger \hat{b}_{\mathbf{r}} \hat{b}_{\mathbf{r}}$ , where index  $\mathbf{r}$  “enumerates” spatial locations. The interaction constant,  $\lambda$ , is related to a commonly used  $s$ -wave scattering length,  $a_s$ , as  $\lambda = 4\pi a_s/m$  (see [35]). The corresponding term in the continuum Keldysh action takes the form

$$S_{\text{int}}[\phi_+, \phi_-] = -\lambda \int d\mathbf{r} \int_C dt (\bar{\phi}\phi)^2 = -\lambda \int d\mathbf{r} \int_{-\infty}^{+\infty} dt [(\bar{\phi}_+\phi_+)^2 - (\bar{\phi}_-\phi_-)^2]. \quad (38)$$

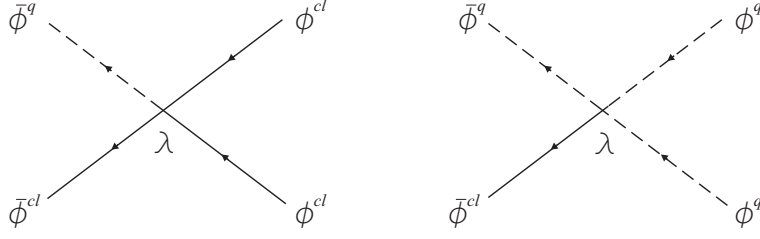

Figure 3: Graphic representation of the two interaction vertices of the  $|\phi|^4$  theory. There are also two complex conjugated vertices with a reversed direction of all arrows.

It is important to remember that there are no interactions in the distant past,  $t = -\infty$  (while they are present in the future,  $t = +\infty$ ). The interactions are supposed to be adiabatically switched on and off on the forward and backward branches, respectively. This guarantees that the off-diagonal blocks of the matrix (12) remain intact. Interactions modify only those matrix elements of the evolution operator (10) that are away from  $t = -\infty$ . It is also worth remembering that in the discrete time form the  $\bar{\phi}$  fields are taken one time step  $\delta_t$  after the  $\phi$  fields along the Keldysh contour  $C$ . Performing the Keldysh rotation (23), one finds

$$S_{\text{int}}[\phi^{cl}, \phi^q] = -\lambda \int d\mathbf{r} \int_{-\infty}^{+\infty} dt \left[ \bar{\phi}^{cl} \bar{\phi}^q [(\phi^{cl})^2 + (\phi^q)^2] + c.c. \right], \quad (39)$$

where *c.c.* denotes the complex conjugate of the first term. The collision action (39) obviously satisfies the causality condition (35). Diagrammatically the action (39) generates two types of vertices depicted in Figures 3 (as well as two complex conjugated vertices, obtained by reversing the direction of the arrows): one with three classical fields (full lines) and one quantum field (dashed line) and the other with one classical field and three quantum fields.

Let us demonstrate that an addition of the collision term to the action does not violate the fundamental normalization,  $Z = 1$ . To this end, one may expand  $\exp(iS_{\text{int}})$  in powers of  $\lambda$  and then average term by term with the Gaussian action (36). To show that the normalization,  $Z = 1$ , is not altered by the collisions, one needs to show that  $\langle S_{\text{int}} \rangle = \langle S_{\text{int}}^2 \rangle = \dots = 0$ . Applying the Wick theorem, one finds for the terms that are linear order in  $\lambda$ :  $\langle \bar{\phi}^q \bar{\phi}^{cl} (\phi^{cl})^2 + c.c. \rangle \sim [G^R(t, t) + G^A(t, t)] G^K(t, t) = 0$ , and  $\langle \bar{\phi}^q \bar{\phi}^{cl} (\phi^q)^2 + c.c. \rangle = 0$ . The first term vanishes owing to the identity (30), while the second vanishes because  $\langle \phi^q \bar{\phi}^q \rangle = 0$  (even if one appeals to the discrete version (24), where  $\langle \phi_j^q \bar{\phi}_{j'}^q \rangle = -i\delta_{jj'}/2 \neq 0$ , this term is still identically zero, since it is given by  $\sum_{jj'} \delta_{jj'} (G_{j',j}^A + G_{j,j'}^R) = 0$ , cf. (30)). There are two families of terms that are second order in  $\lambda$ . The first one is  $\langle \bar{\phi}_1^q \bar{\phi}_1^{cl} (\phi_1^{cl})^2 \phi_2^q \phi_2^{cl} (\bar{\phi}_2^{cl})^2 \rangle \sim G^R(t_2, t_1) G^A(t_2, t_1) [G^K(t_1, t_2)]^2$ , while the second is  $\langle \bar{\phi}_1^q \bar{\phi}_1^{cl} (\phi_1^{cl})^2 \phi_2^q \phi_2^{cl} (\bar{\phi}_2^q)^2 \rangle \sim [G^R(t_1, t_2)]^2 G^R(t_2, t_1) G^A(t_2, t_1)$ , where  $\phi_{1,2}^q \equiv \phi_{j_{1,2}}^q$ . Both of these terms are zero, because  $G^R(t_2, t_1) \sim \theta(t_2 - t_1)$ , while  $G^A(t_2, t_1) \sim G^R(t_1, t_2)^* \sim \theta(t_1 - t_2)$  and thus their product has no support<sup>2</sup>. It is easy to see that, for exactly the same reasons, all higher-order terms vanish and thus the normalization is unmodified (at least in the perturbative expansion).

As another example, consider a real boson field, see Appendix B, with the cubic non-linearity

$$S_{\text{int}} = \frac{\kappa}{6} \int d\mathbf{r} \int_C dt \phi^3 = \frac{\kappa}{6} \int d\mathbf{r} \int_{-\infty}^{+\infty} dt [\phi_+^3 - \phi_-^3] = \kappa \int d\mathbf{r} \int_{-\infty}^{+\infty} dt \left[ (\phi^{cl})^2 \phi^q + \frac{1}{3} (\phi^q)^3 \right]. \quad (40)$$

The causality condition (35) is again satisfied. Diagrammatically the cubic non-linearity generates two types of vertices, Figure 4: one with two classical fields (full lines) and one quantum field

<sup>2</sup>Strictly speaking,  $G^R(t_2, t_1)$  and  $G^A(t_2, t_1)$  are both simultaneously non-zero at the diagonal:  $t_1 = t_2$ . The contribution of the diagonal to the integrals, however, is  $\sim \delta_t^2 N \rightarrow 0$ , when  $N \rightarrow \infty$ .

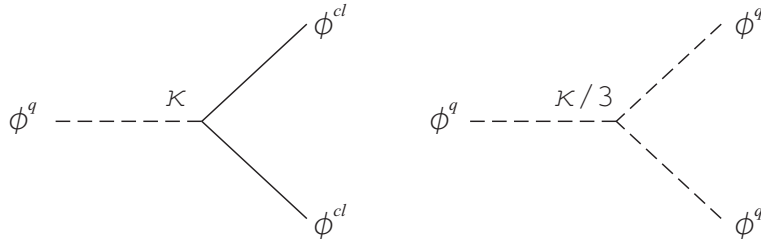

Figure 4: Graphic representation of the two interaction vertices of the  $\phi^3$  theory. Note the relative factor of one–third between them.

(dashed line), and the other with three quantum fields. The former vertex carries the factor  $\kappa$ , while the latter has weight  $\kappa/3$ . Note that for the real field the direction of lines is not specified by arrows.

### 3.2 Saddle point equations

Before developing the perturbation theory further, one has to discuss the saddle points of the action. According to (35), there are no terms in the action that have zero power of both  $\bar{\phi}^q$  and  $\phi^q$ . The same is obviously true regarding  $\delta S / \delta \bar{\phi}^{cl}$  and therefore one of the saddle point equations

$$\frac{\delta S}{\delta \bar{\phi}^{cl}} = 0 \quad (41)$$

may always be solved by

$$\Phi^q = 0, \quad (42)$$

irrespectively of what the classical component,  $\Phi^{cl}$ , is. By capital letter  $\Phi^{cl(q)}$  we denote solutions of the saddle point equations. One may check that this is indeed the case for the action given by e.g. (36) plus (39). Under condition (42) the second saddle point equation takes the form

$$\frac{\delta S}{\delta \bar{\phi}^q} = \left( [G^R]^{-1} - \lambda |\Phi^{cl}|^2 \right) \Phi^{cl} = \left( i\partial_t + \frac{1}{2m} \partial_{\mathbf{r}}^2 + \mu - \lambda |\Phi^{cl}|^2 \right) \Phi^{cl} = 0. \quad (43)$$

This is the non–linear time–dependent Gross–Pitaevskii equation, which determines the classical field configuration, provided some initial and boundary conditions are specified.

The message is that among the possible solutions of the saddle point equations for the Keldysh action, there is always one with zero quantum component and with classical component that obeys the classical (non–linear) equation of motion. We shall call such a saddle point “*classical*”. Thanks to (35) and (42), the action on the classical saddle point field configurations is identically zero. As was argued above, the perturbative expansion in small fluctuations around the classical saddle point leads to a properly normalized partition function,  $Z = 1$ . This seemingly excludes the possibility of having any other saddle points. However, this conclusion is premature. The system may possess “non–classical” saddle points, such that  $\Phi^q \neq 0$ . Such saddle points do not contribute to the partition function (and thus do not alter the fundamental normalization,  $Z = 1$ ), however, they may contribute to observables and correlation functions. In general, the action on a *non–classical* saddle point is non–zero. Its contribution is thus associated with exponentially small (or oscillatory) terms. Examples include tunneling, thermal activation (considered in the next section), oscillatory contributions to the level statistics, *etc.*

Let us develop now a systematic perturbative expansion in deviations from the *classical* saddle point:  $\phi^{cl} = \Phi^{cl} + \delta\phi^{cl}$  and  $\phi^q = 0 + \delta\phi^q$ . As was discussed above, it does not bring any new information about the partition function. It does, however, provide information about the Green’s functions (and thus various observables). Most notably, it generates the kinetic equation for the

distribution function. To simplify the further consideration, we restrict ourselves to situations where no Bose condensate is present, i.e.  $\Phi^{cl} = 0$  is the proper solution of the classical saddle point equation (43). In this case  $\phi^\alpha = \delta\phi^\alpha$  and thus the  $\delta$ -symbol may be omitted.

### 3.3 Dyson equation

The next goal is to calculate the *dressed* Green's function, defined as

$$\mathbf{G}^{\alpha\beta}(t, t') = -i \int \mathbf{D}[\bar{\phi}\phi] \phi^\alpha(t) \bar{\phi}^\beta(t') \exp(iS_0 + iS_{\text{int}}), \quad (44)$$

here  $\alpha, \beta = (cl, q)$  and the action is given by (36) and (39). To this end, one may expand the exponent in powers of  $S_{\text{int}}$ . The functional integration with the remaining Gaussian action is then performed using the Wick theorem, see Appendix A. This leads to the standard diagrammatic series. Combining all one-particle irreducible diagrams into the self-energy matrix  $\hat{\Sigma}$ , one obtains

$$\hat{\mathbf{G}} = \hat{G} + \hat{G} \circ \hat{\Sigma} \circ \hat{G} + \hat{G} \circ \hat{\Sigma} \circ \hat{G} \circ \hat{\Sigma} \circ \hat{G} + \dots = \hat{G} \circ (\hat{1} + \hat{\Sigma} \circ \hat{G}), \quad (45)$$

where  $\hat{G}$  is given by (28) and the circular multiplication sign implies convolution in times and space domain as well as a  $2 \times 2$  matrix multiplication. The only difference compared with the textbook diagrammatic expansion [12, 18, 34] is the presence of the  $2 \times 2$  Keldysh matrix structure. The fact that the series is arranged as a sequence of matrix products is of no surprise. Indeed, the Keldysh index,  $\alpha = (cl, q)$ , is just one more index in addition to time, space, spin, etc. Therefore, as with any other index, there is a summation over all of its intermediate values, hence the matrix multiplication. The concrete form of the self-energy matrix,  $\hat{\Sigma}$ , is specific to the Keldysh technique and is discussed below in some details.

Multiplying both sides of (45) by  $\hat{G}^{-1}$  from the left, one obtains the Dyson equation for the exact dressed Green's function,  $\hat{\mathbf{G}}$ , in the form

$$(\hat{G}^{-1} - \hat{\Sigma}) \circ \hat{\mathbf{G}} = \hat{1}, \quad (46)$$

where  $\hat{1}$  is a unit matrix. The very non-trivial feature of the Keldysh technique is that the self-energy matrix,  $\hat{\Sigma}$ , possesses the same causality structure as  $\hat{G}^{-1}$  (see Eq. (33)), namely

$$\hat{\Sigma} = \begin{pmatrix} 0 & \Sigma^A \\ \Sigma^R & \Sigma^K \end{pmatrix}, \quad (47)$$

where  $\Sigma^{R(A)}$  are lower (upper) triangular matrices in the time domain, while  $\Sigma^K$  is an anti-Hermitian matrix. This fact is demonstrated below. Since both  $\hat{G}^{-1}$  and  $\hat{\Sigma}$  have the same structure, one concludes that the dressed Green's function,  $\hat{\mathbf{G}}$ , also possesses the causality structure, like (28). As a result, the Dyson equation acquires the form

$$\begin{pmatrix} 0 & [G^A]^{-1} - \Sigma^A \\ [G^R]^{-1} - \Sigma^R & -\Sigma^K \end{pmatrix} \circ \begin{pmatrix} \mathbf{G}^K & \mathbf{G}^R \\ \mathbf{G}^A & 0 \end{pmatrix} = \hat{1}, \quad (48)$$

where we have taken into account that  $[G^{-1}]^K$  is a pure regularization ( $\sim i0F$ ) and thus may be omitted in the presence of a non-zero  $\Sigma^K$ . Employing the specific form of  $[G^{R(A)}]^{-1}$  (see (37)), one obtains for the retarded (advanced) components

$$\left( i\partial_t + \frac{1}{2m}\partial_{\mathbf{r}}^2 + \mu - \Sigma^{R(A)} \right) \circ \mathbf{G}^{R(A)} = \delta(t - t')\delta(\mathbf{r} - \mathbf{r}'). \quad (49)$$

Provided the self-energy component  $\Sigma^{R(A)}$  is known (in some approximation), equation (49) constitutes a closed equation for the retarded (advanced) component of the dressed Green's function. The latter carries the information about the spectrum of the interacting system.

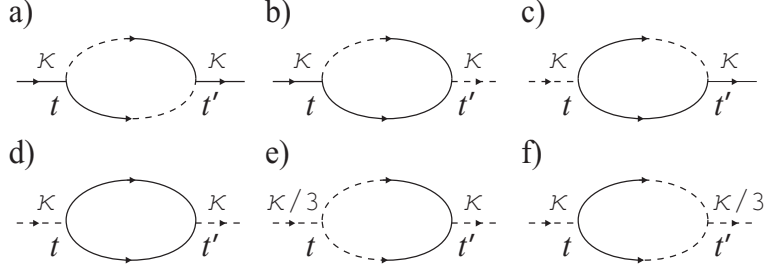

Figure 5: Self-energy diagrams for the  $\phi^3$  theory.

To write down equation for the Keldysh component we parameterize it as  $\mathbf{G}^K = \mathbf{G}^R \circ \mathbf{F} - \mathbf{F} \circ \mathbf{G}^A$ , cf. (32), where  $\mathbf{F}$  is a Hermitian matrix in the time domain. The equation for the Keldysh component then takes the form  $([G^R]^{-1} - \Sigma^R) \circ (\mathbf{G}^R \circ \mathbf{F} - \mathbf{F} \circ \mathbf{G}^A) = \Sigma^K \circ \mathbf{G}^A$ . Multiplying it from the right by  $([G^A]^{-1} - \Sigma^A)$  and employing (49), one finally finds

$$\left[ \mathbf{F}, \left( i\partial_t + \frac{1}{2m}\partial_{\mathbf{r}}^2 \right) \right] = \Sigma^K - (\Sigma^R \circ \mathbf{F} - \mathbf{F} \circ \Sigma^A), \quad (50)$$

where  $[ , ]$  denotes for the commutator. This equation is the quantum kinetic equation for the distribution matrix  $\mathbf{F}$ . Its left-hand side is called the *kinetic* term, while the right-hand side is the *collision integral* (up to a factor). As is shown below,  $\Sigma^K$  has the meaning of an “incoming” term, while  $\Sigma^R \circ \mathbf{F} - \mathbf{F} \circ \Sigma^A$  is an “outgoing” term. In equilibrium these two channels cancel each other (the kinetic term vanishes) and the self-energy has the same structure as the Green’s function:  $\Sigma^K = \Sigma^R \circ \mathbf{F} - \mathbf{F} \circ \Sigma^A$ . This is not the case, however, away from the equilibrium.

### 3.4 Self-energy

Let us demonstrate that the self-energy matrix,  $\hat{\Sigma}$ , indeed possesses the causality structure (47). To this end, we consider the real boson field with the  $\kappa\phi^3$  non-linearity (40), and perform calculations up to the second order in the parameter  $\kappa$ . Employing the two vertices of figure 4 one finds the following.

(i) The *cl-cl* component is given by the single diagram, depicted in Figure 5a. The corresponding analytic expression is  $\Sigma^{cl-cl}(t, t') = 4i\kappa^2 G^R(t, t')G^A(t, t') = 0$ . Indeed, the product  $G^R(t, t')G^A(t, t')$  has no support (see footnote in section 3.1).

(ii) The *cl-q* (advanced) component is given by the single diagram, Figure 5b. The corresponding expression is

$$\Sigma^A(t, t') = 4i\kappa^2 G^A(t, t')G^K(t, t'). \quad (51)$$

Since  $\Sigma^A(t, t') \sim G^A(t, t') \sim \theta(t' - t)$ , it is, indeed, an advanced (upper triangular) matrix. There is a combinatoric factor of four, associated with the diagram (four ways of choosing external legs  $\times$  two internal permutations  $\times 1/(2!)$  for having two identical vertices).

(iii) The *q-cl* (retarded) component is given by the diagram of Figure 5c

$$\Sigma^R(t, t') = 4i\kappa^2 G^R(t, t')G^K(t, t'), \quad (52)$$

that could be obtained, of course, by the Hermitian conjugation of (51) with the help of (26):  $\Sigma^R = [\Sigma^A]^\dagger$ . Since  $\Sigma^R(t, t') \sim G^R(t, t') \sim \theta(t - t')$ , it is indeed a retarded (lower triangular) matrix.

(iv) The *q-q* (Keldysh) component is given by the three diagrams, Figure 5d–5f. The corresponding expression (sum of these diagrams) is

$$\begin{aligned} \Sigma^K(t, t') &= 2i\kappa^2 [G^K(t, t')]^2 + 6i\left(\frac{\kappa}{3}\right)\kappa [G^A(t, t')]^2 + 6i\left(\frac{\kappa}{3}\right)\kappa [G^R(t, t')]^2 \\ &= 2i\kappa^2 \left( [G^K(t, t')]^2 + [G^R(t, t') - G^A(t, t')]^2 \right). \end{aligned} \quad (53)$$



The combinatoric factors are two for diagram Figure 5d, and six for Figure 5e and f. In the last equality the fact that  $G^R(t, t')G^A(t, t') = 0$ , owing to the absence of support in the time domain, has been used again. Employing (26), one finds  $\Sigma^K = -[\Sigma^K]^\dagger$ .

This demonstrates that the self-energy  $\hat{\Sigma}$  possesses the same structure as  $\hat{G}^{-1}$ . One may check that the statement holds in higher orders as well. In (51)–(53) one has omitted the spatial coordinates, which may be restored in an obvious way.

### 3.5 Kinetic equation

To make further progress in the discussion of the kinetic equation it is convenient to perform the Wigner transformation (WT)<sup>3</sup>. The WT of a distribution function matrix,  $\mathbf{F}(\mathbf{r}, \mathbf{r}'; t, t')$ , is a function  $\mathbf{f}(\mathbf{R}, \mathbf{k}; \tau, \epsilon)$ , where  $\tau$  and  $\mathbf{R}$  are central time and coordinate, respectively. According to the definition (32), the  $\mathbf{f}$  function appears in a product with  $G^R - G^A$ . The latter is a sharply peaked function at  $\epsilon = \omega_{\mathbf{k}}$  for free particles, while for the interacting systems this is still the case as long as quasi-particles are well-defined. One therefore frequently writes  $\mathbf{f}(\mathbf{R}, \mathbf{k}, \tau)$ , understanding that  $\epsilon = \omega_{\mathbf{k}}$ .

To rewrite the kinetic term (the left-hand side of (50)) in the Wigner representation, one notices that the WT of  $i\partial_t$  is  $\epsilon$ , while the WT of  $\partial_{\mathbf{r}}^2$  is  $-\mathbf{k}^2$ . Then, e.g.,  $[\mathbf{F}, \partial_{\mathbf{r}}^2]_- \rightarrow [\mathbf{k}^2, \mathbf{f}]_- + i\nabla_{\mathbf{k}}\mathbf{k}^2\nabla_{\mathbf{R}}\mathbf{f} = 2i\mathbf{k}\nabla_{\mathbf{R}}\mathbf{f}$ , where the commutator vanishes, since WTs commute. In a similar way:  $[\mathbf{F}, i\partial_t]_- \rightarrow -i\partial_{\tau}\mathbf{f}$ . If there is a scalar potential  $V(\mathbf{r})\hat{b}_i^\dagger\hat{b}_i$  in the Hamiltonian, it translates into the term  $-V(\bar{\phi}^{cl}\phi^a + \bar{\phi}^a\phi^{cl})$  in the action and thus  $-V(\mathbf{r})$  is added to  $[G^{R(A)}]^{-1}$ . This, in turn, brings the term  $-\mathbf{F}, V]_-$  to the left-hand side of the Dyson equation (50) or, after the WT,  $i\mathbf{E}\nabla_{\mathbf{k}}\mathbf{f}$ , where  $\mathbf{E} \equiv -\nabla_{\mathbf{R}}V$  is the electric field. As a result, the WT of the Dyson equation (50) takes the form

$$(\partial_{\tau} - v_{\mathbf{k}}\nabla_{\mathbf{R}} - \mathbf{E}\nabla_{\mathbf{k}})\mathbf{f}(\mathbf{R}, \mathbf{k}, \tau) = I_{\text{coll}}[\mathbf{f}], \quad (54)$$

where  $v_{\mathbf{k}} \equiv \mathbf{k}/m$  and  $I_{\text{coll}}[\mathbf{f}]$  is the WT of the right-hand side of (50) (times  $i$ ). This is the kinetic equation for the distribution function.

For real bosons with the dispersion relation  $\epsilon = \omega_{\mathbf{k}}$ , see Appendix B, the kinetic term takes the form  $[\epsilon^2 - \omega_{\mathbf{k}}^2, \mathbf{F}]_- \rightarrow 2i(\epsilon\partial_{\tau} - \omega_{\mathbf{k}}(\nabla_{\mathbf{k}}\omega_{\mathbf{k}})\nabla_{\mathbf{R}})\mathbf{f} = 2i\epsilon(\partial_{\tau} - v_{\mathbf{k}}\nabla_{\mathbf{R}})\mathbf{f}$ , where  $v_{\mathbf{k}} \equiv \nabla_{\mathbf{k}}\omega_{\mathbf{k}}$  is the group velocity. As a result, the kinetic equation takes the form:  $(\partial_{\tau} - v_{\mathbf{k}}\nabla_{\mathbf{R}})\mathbf{f}(\mathbf{R}, \mathbf{k}, \tau) = I_{\text{coll}}[\mathbf{f}]$ , where the collision integral  $I_{\text{coll}}[\mathbf{f}]$  is the WT of the right-hand side of (50), divided by  $-2i\epsilon$ .

Let us discuss the collision integral now, using the  $\phi^3$  theory calculations of Section 3.4 as an example. To shorten the algebra, let us consider a system that is spatially uniform and isotropic in the momentum space. One thus focuses on the energy relaxation only. In this case the distribution function is  $\mathbf{f}(\mathbf{R}, \mathbf{k}, \tau) = \mathbf{f}(\tau, \omega_{\mathbf{k}}) = \mathbf{f}(\tau, \epsilon)$ , where the dependence on the modulus of the momentum is substituted by the  $\omega_{\mathbf{k}} = \epsilon$  argument. Employing (51)–(53), one finds for the WT of the right-hand side of<sup>4</sup> (50):

$$\Sigma^R \circ \mathbf{F} - \mathbf{F} \circ \Sigma^A \rightarrow -2i\mathbf{f}(\tau, \epsilon) \int d\omega M(\tau, \epsilon, \omega) [\mathbf{f}(\tau, \epsilon - \omega) + \mathbf{f}(\tau, \omega)], \quad (55a)$$

$$\Sigma^K \rightarrow -2i \int d\omega M(\tau, \epsilon, \omega) [\mathbf{f}(\tau, \epsilon - \omega)\mathbf{f}(\tau, \omega) + 1], \quad (55b)$$

<sup>3</sup>The Wigner transform of a matrix  $A(\mathbf{r}, \mathbf{r}')$  is defined as  $a(\mathbf{R}, \mathbf{k}) \equiv \int d\mathbf{r}_1 A(\mathbf{R} + \frac{\mathbf{r}_1}{2}, \mathbf{R} - \frac{\mathbf{r}_1}{2}) \exp(i\mathbf{k}\mathbf{r}_1)$ . One may show that the Wigner transform of the matrix  $C = A \circ B$ , which means  $C(\mathbf{r}, \mathbf{r}') = \int d\mathbf{r}'' A(\mathbf{r}, \mathbf{r}'')B(\mathbf{r}'', \mathbf{r}')$ , is equal to

$$c(\mathbf{R}, \mathbf{k}) = \iint d\mathbf{r}_1 d\mathbf{r}_2 \iint \frac{d\mathbf{k}_1 d\mathbf{k}_2}{(2\pi)^{2d}} a\left(\mathbf{R} + \frac{\mathbf{r}_1}{2}, \mathbf{k} + \mathbf{k}_1\right) b\left(\mathbf{R} + \frac{\mathbf{r}_2}{2}, \mathbf{k} + \mathbf{k}_2\right) \exp(i(\mathbf{k}_1\mathbf{r}_2 - \mathbf{k}_2\mathbf{r}_1)).$$

Expanding the functions under the integrals in  $\mathbf{k}$ ; and  $\mathbf{r}_i$ , one finds:  $c(\mathbf{R}, \mathbf{k}) = a(\mathbf{R}, \mathbf{k})b(\mathbf{R}, \mathbf{k}) + (2i)^{-1}(\nabla_{\mathbf{R}}a\nabla_{\mathbf{k}}b - \nabla_{\mathbf{k}}a\nabla_{\mathbf{R}}b) + \dots$

<sup>4</sup>Only products of WTs are retained, while all the gradient terms are neglected, in particular  $\mathbf{G}^K \rightarrow \mathbf{f}(\mathbf{g}^R - \mathbf{g}^A)$ . The energy-momentum representation is used, instead of the time-space representation as in (51)–(53), and in the equation for  $\Sigma^R \circ \mathbf{F} - \mathbf{F} \circ \Sigma^A$  one performs a symmetrization between the  $\omega$  and  $\epsilon - \omega$  arguments.

where the transition rate is given by

$$M(\tau, \epsilon, \omega) = 2\pi\kappa^2 \sum_q \Delta_g(\tau, \epsilon - \omega; \mathbf{k} - \mathbf{q}) \Delta_g(\tau, \omega; \mathbf{q}). \quad (56)$$

Here  $\Delta_g \equiv i(\mathbf{g}^R - \mathbf{g}^A)/(2\pi)$  and  $\mathbf{g}^{R(A)}(\tau, \epsilon; \mathbf{k})$  are the WT of the retarded (advanced) Green functions  $\mathbf{G}^{R(A)}$ . One has substituted the dressed Green's functions into (51)–(53) instead of the bare ones to perform a partial resummation of the diagrammatic series. (This trick is sometimes called the *self-consistent Born approximation*. It still neglects the vertex corrections.) Assuming the existence of well-defined quasi-particles at all times, one may regard  $\Delta_g(\tau, \epsilon, \mathbf{k})$  as a sharply peaked function at  $\epsilon = \omega_{\mathbf{k}}$ . In this case (56) simply reflects the fact that an initial particle with  $\epsilon = \omega_{\mathbf{k}}$  decays into two real (on mass-shell) particles with energies  $\omega = \omega_{\mathbf{q}}$  and  $\epsilon - \omega = \omega_{\mathbf{k}-\mathbf{q}}$ . As a result, one finally obtains for the kinetic equation

$$\frac{\partial \mathbf{f}(\epsilon)}{\partial \tau} = \int d\omega \frac{M(\epsilon, \omega)}{\epsilon} \left\{ \mathbf{f}(\epsilon - \omega)\mathbf{f}(\omega) + 1 - \mathbf{f}(\epsilon)[\mathbf{f}(\epsilon - \omega) + \mathbf{f}(\omega)] \right\}, \quad (57)$$

where the time arguments are suppressed for brevity. Due to the identity:  $\coth(a - b) \coth(b) + 1 = \coth(a)(\coth(a - b) + \coth(b))$ , the collision integral is identically nullified by  $\mathbf{f}(\epsilon) = \coth(\epsilon/2T)$  where  $T$  is a temperature. This is the thermal equilibrium distribution function. According to the kinetic equation (57), it is stable for any temperature (the latter is determined either by an external reservoir, or, for a closed system, from the conservation of total energy). Since the equilibrium distribution obviously nullifies the kinetic term, according to (50) the *exact* self-energy satisfies  $\Sigma^K = \coth(\epsilon/2T)[\Sigma^R - \Sigma^A]$ . Since also the bare Green's functions obey the same relation (31), one concludes that in thermal equilibrium the *exact* dressed Green's function satisfies

$$\mathbf{G}^K = (\mathbf{G}^R - \mathbf{G}^A) \coth \frac{\epsilon}{2T}. \quad (58)$$

This is the statement of the *fluctuation-dissipation theorem* (FDT). Its consequence is that in equilibrium the Keldysh component does not contain any additional information with respect to the retarded component. Therefore, the Keldysh technique may be, in principle, substituted by a more compact construction: the Matsubara method. The latter does not work, of course, away from equilibrium.

Returning to the kinetic equation (57), one may identify “in” and “out” terms in the collision integral. It may be done by writing the collision integral in terms of the occupation numbers  $\mathbf{n}_\epsilon$ , defined as  $\mathbf{f}_\epsilon = 1 + 2\mathbf{n}_\epsilon$ . The expression in the curly brackets on the right-hand side of (57) takes the form  $4[\mathbf{n}_{\epsilon-\omega}\mathbf{n}_\omega - \mathbf{n}_\epsilon(\mathbf{n}_{\epsilon-\omega} + \mathbf{n}_\omega + 1)]$ . The first term  $\mathbf{n}_{\epsilon-\omega}\mathbf{n}_\omega$  gives a probability that a particle with energy  $\epsilon - \omega$  absorbs a particle with energy  $\omega$  to populate a state with energy  $\epsilon$ : this is the “in” term of the collision integral. It may be traced back to the  $\Sigma^K$  part of the self-energy. The second term  $-\mathbf{n}_\epsilon(\mathbf{n}_{\epsilon-\omega} + \mathbf{n}_\omega + 1)$  says that a state with energy  $\epsilon$  may be depopulated either by stimulated emission of particles with energies  $\epsilon - \omega$  and  $\omega$ , or by spontaneous emission. This is the “out” term, that may be traced back to the  $\Sigma^{R(A)}$  contributions.

Finally, let us discuss the approximations involved in the Wigner transformations. Although (50) is formally exact, it is very difficult to extract any useful information from it. Therefore, passing to an approximate, but much more tractable, form such as (54) or (57) is highly desirable. In doing it, one has to employ the approximate form of the WT. Indeed, a formally infinite series in  $\nabla_{\mathbf{k}}\nabla_{\mathbf{R}}$  operators is truncated, usually by the first non-vanishing term. This is a justified procedure as long as  $\delta\mathbf{k}\delta\mathbf{R} \gg 1$ , where  $\delta\mathbf{k}$  is a characteristic microscopic scale of the momentum dependence of  $\mathbf{f}$ , while  $\delta\mathbf{R}$  is a characteristic scale of its spatial variations. One may ask if there is a similar requirement in the time domain:  $\delta\epsilon\delta\tau \gg 1$ , with  $\delta\epsilon$  and  $\delta\tau$  being the characteristic energy and the time scales of  $\mathbf{f}$ , correspondingly. Such a requirement is very demanding, since typically  $\delta\epsilon \approx T$  and at low temperature it would only allow very slow processes to be treated: with  $\delta\tau \gg 1/T$ . Fortunately, this is not the case. Because of the peaked structure of  $\Delta_g(\epsilon, \mathbf{k})$ , the energy argument  $\epsilon$  is locked to  $\omega_{\mathbf{k}}$  and does not have its own dynamics as long as the peak is sharp. The actual criterion is therefore that

$\delta\epsilon$  is much larger than the width of the peak in  $\Delta_{\mathbf{g}}(\epsilon, \mathbf{k})$ . The latter is, by definition, the quasi-particle life-time,  $\tau_{qp}$ , and therefore the condition is  $\tau_{qp} \gg 1/T$ . This condition is indeed satisfied by many systems where the interactions are not too strong.

## 4 Particle in contact with an environment

### 4.1 Quantum dissipative action

Consider a particle with the coordinate  $\Phi(t)$ , placed in a potential  $U(\Phi)$  and attached to a harmonic string  $\varphi(x, t)$ . The particle may represent a collective degree of freedom, such as the phase of a Josephson junction or the charge on a quantum dot. On the other hand, the string serves to model a dissipative environment. The advantage of the one-dimensional string is that it is the simplest continuum system, having a constant density of states at small energies. Owing to this property it mimics, for example, interactions with a Fermi sea. A continuum reservoir with a constant density of states at small energies is sometimes called an ‘‘Ohmic’’ environment (or bath). The environment is supposed to be in thermal equilibrium.

The Keldysh action of such a system is given by the three terms  $S = S_p + S_{\text{str}} + S_{\text{int}}$ , where (see Appendix B)

$$S_p[\Phi] = \int_{-\infty}^{+\infty} dt \left[ -2\Phi^q \frac{d^2\Phi^{cl}}{dt^2} - U(\Phi^{cl} + \Phi^q) + U(\Phi^{cl} - \Phi^q) \right], \quad (59a)$$

$$S_{\text{str}}[\varphi] = \int_{-\infty}^{+\infty} dt \int dx \vec{\varphi}^T(x, t) \hat{D}^{-1} \vec{\varphi}(x, t), \quad (59b)$$

$$S_{\text{int}}[\Phi, \varphi] = 2\sqrt{\gamma} \int_{-\infty}^{+\infty} dt \vec{\Phi}^T(t) \hat{\sigma}_x \partial_x \vec{\varphi}(x, t) \Big|_{x=0}. \quad (59c)$$

Here we have introduced vectors of classical and quantum components, e.g.,  $\vec{\Phi}^T \equiv (\Phi^{cl}, \Phi^q)$  and the string correlator,  $\hat{D}^{-1}$ , that has typical bosonic form (36), with  $[D^{R(A)}]^{-1} = -\partial_t^2 + v_s^2 \partial_x^2$ , which follows from (421). The  $S_p$  represents a particle (see corresponding discussion in (417) in Appendix B). The  $S_{\text{str}}$  is the action of the string (421). The interaction term between the particle and the string is taken to be the local product of the particle coordinate and the string stress at  $x = 0$  (so the force acting on the particle is proportional to the local stress of the string). In the time domain the interaction is instantaneous,  $\Phi(t) \partial_x \varphi(x, t) \Big|_{x=0} \rightarrow \Phi_+ \partial_x \varphi_+ - \Phi_- \partial_x \varphi_-$  on the Keldysh contour. Transforming to the classical-quantum notation leads to  $2(\Phi^{cl} \partial_x \varphi^q + \Phi^q \partial_x \varphi^{cl})$ , that satisfies the causality condition (35). In the matrix notation it takes the form of (59c). The interaction constant is denoted  $\sqrt{\gamma}$ .

One may now integrate out the degrees of freedom of the harmonic string to reduce the problem to the particle coordinate only. According to the standard rules of Gaussian integration (see Appendix A), this leads to the so-called dissipative action for the particle

$$S_{\text{diss}} = \gamma \iint_{-\infty}^{+\infty} dt dt' \vec{\Phi}^T(t) \hat{\mathfrak{D}}^{-1}(t-t') \hat{\Phi}(t'), \quad (60a)$$

$$\hat{\mathfrak{D}}^{-1}(t-t') = -\hat{\sigma}_x \partial_x \partial_{x'} \hat{D}(x-x'; t-t') \Big|_{x=x'=0} \hat{\sigma}_x. \quad (60b)$$

The straightforward matrix multiplication shows that the dissipative correlator  $\hat{\mathfrak{D}}^{-1}$  possesses the standard causality structure. Fourier transforming its retarded (advanced) components, one finds

$$[\mathfrak{D}^{R(A)}(\epsilon)]^{-1} = -\sum_k \frac{k^2}{(\epsilon \pm i0)^2 - k^2} = \pm \frac{i}{2} \epsilon + \text{const}, \quad (61)$$

where we put  $v_s = 1$  for brevity. The  $\epsilon$ -independent constant (same for  $R$  and  $A$  components) may be absorbed into the redefinition of the harmonic part of the potential  $U(\Phi) = \text{const} \Phi^2 + \dots$  and,

thus, may be omitted. In equilibrium the Keldysh component of the correlator is set by the FDT

$$[\mathfrak{D}^{-1}]^K(\epsilon) = \left( [\mathfrak{D}^R]^{-1} - [\mathfrak{D}^A]^{-1} \right) \coth \frac{\epsilon}{2T} = i\epsilon \coth \frac{\epsilon}{2T}. \quad (62)$$

It is an anti-Hermitian operator with a positive-definite imaginary part, rendering convergence of the functional integral over  $\Phi$ .

In the time representation the retarded (advanced) component of the correlator takes a time-local form  $[\mathfrak{D}^{R(A)}]^{-1} = \mp \frac{1}{2} \delta(t-t') \partial_t$ . On the other hand, at low temperatures the Keldysh component is a non-local function, that may be found by the inverse Fourier transform of (62):

$$[\mathfrak{D}^{-1}]^K(t-t') = i \left[ (2T+C)\delta(t-t') - \frac{\pi T^2}{\sinh^2[\pi T(t-t')]} \right], \quad (63)$$

where the infinite constant  $C$  serves to satisfy the condition  $\int dt [\mathfrak{D}^{-1}(t)]^K = [\mathfrak{D}^{-1}(\epsilon=0)]^K = 2iT$ . Finally, for the Keldysh action of the particle connected to a string, one obtains

$$S[\Phi] = \int_{-\infty}^{+\infty} dt \left[ -2\Phi^q \left( \frac{d^2\Phi^{cl}}{dt^2} + \frac{\gamma}{2} \frac{d\Phi^{cl}}{dt} \right) - U(\Phi^{cl} + \Phi^q) + U(\Phi^{cl} - \Phi^q) \right] \\ + 2i\gamma \int_{-\infty}^{+\infty} dt \left[ T(\Phi^q(t))^2 + \frac{\pi T^2}{2} \int_{-\infty}^{+\infty} dt' \frac{(\Phi^q(t) - \Phi^q(t'))^2}{\sinh^2[\pi T(t-t')]} \right]. \quad (64)$$

This action satisfies all the causality criterions listed in Sec. 2.3. Note that, in the present case, the Keldysh ( $q-q$ ) component is not just a regularization factor, but rather a quantum fluctuations damping term, originating from the coupling to the string. The other manifestation of the string is the presence of the friction term,  $\sim \gamma \partial_t$ , in the  $R$  and the  $A$  components. In equilibrium the friction coefficient and fluctuations amplitude are connected rigidly by the FDT. The quantum dissipative action (64) is a convenient playground to demonstrate various approximations and connections to other approaches.

## 4.2 Classical limit

The *classical* saddle point equation (the one that takes  $\Phi^q(t) = 0$ ) has the form:

$$-\frac{1}{2} \frac{\delta S[\Phi]}{\delta \Phi^q} \Big|_{\Phi^q=0} = \frac{d^2\Phi^{cl}}{dt^2} + \frac{\gamma}{2} \frac{d\Phi^{cl}}{dt} + \frac{\partial U(\Phi^{cl})}{\partial \Phi^{cl}} = 0. \quad (65)$$

This is the deterministic classical equation of motion. In the present case it happens to be Newton equation with the viscous force  $-(\gamma/2)\Phi^{cl}$ . This approximation neglects both *quantum* and *thermal* fluctuations.

One may keep the thermal fluctuations, while completely neglecting the quantum ones. To this end, it is convenient to restore the Planck constant in the action (64) and then take the limit  $\hbar \rightarrow 0$ . For dimensional reasons, the factor  $\hbar^{-1}$  should stand in front of the action. To keep the part of the action responsible for the classical equation of motion (65) free from the Planck constant it is convenient to rescale the variables as  $\Phi^q \rightarrow \hbar \Phi^q$ . Finally, to keep proper units, one needs to substitute  $T \rightarrow T/\hbar$  in the last term of (64). The limit  $\hbar \rightarrow 0$  is now straightforward: (i) one has to expand  $U(\Phi^{cl} \pm \hbar \Phi^q)$  to the first order in  $\hbar \Phi^q$  and neglect all higher order terms; (ii) in the  $\hbar \rightarrow 0$  limit, which is equivalent to the  $T \rightarrow \infty$ , the non-local part of the action (64) drops out, while the local term  $\propto (\Phi^q(t))^2$  survives. As a result, the classical limit of the dissipative action is

$$S[\Phi] = 2 \int_{-\infty}^{+\infty} dt \left[ -\Phi^q \left( \frac{d^2\Phi^{cl}}{dt^2} + \frac{\gamma}{2} \frac{d\Phi^{cl}}{dt} + \frac{\partial U(\Phi^{cl})}{\partial \Phi^{cl}} \right) + i\gamma T (\Phi^q)^2 \right]. \quad (66)$$

Physically the limit  $\hbar \rightarrow 0$  means that  $\hbar\Omega \ll T$ , where  $\Omega$  is a characteristic classical frequency of the particle. This condition is necessary for the last term of (64) to take the time-local form. The condition for neglecting the higher-order derivatives of  $U$  is  $\hbar \ll \gamma(\tilde{\Phi}^{cl})^2$ , where  $\tilde{\Phi}^{cl}$  is a characteristic classical amplitude of the particle motion.

### 4.3 Langevin equation

One way to proceed with the classical action (66) is to note that the exponent of its last term (times  $i$ ) may be identically rewritten in the following way

$$\exp\left(-2\gamma T \int_{-\infty}^{+\infty} dt [\Phi^q(t)]^2\right) = \int \mathbf{D}[\xi] \exp\left(-\int_{-\infty}^{+\infty} dt \left[\frac{\xi^2(t)}{2\gamma T} - 2i\xi(t)\Phi^q(t)\right]\right). \quad (67)$$

This identity is called the Hubbard–Stratonovich transformation, while  $\xi(t)$  is an auxiliary Hubbard–Stratonovich field. The identity is proved by completing the square in the exponent on the right-hand side and performing the Gaussian integration at every instance of time. There is a constant multiplicative factor hidden in the integration measure,  $\mathbf{D}[\xi]$ .

Exchanging the order of the functional integration over  $\xi$  and  $\Phi$ , one finds for the partition function:

$$\begin{aligned} Z &= \int \mathbf{D}[\xi] \exp\left(-\frac{1}{2\gamma T} \int_{-\infty}^{+\infty} dt \xi^2(t)\right) \\ &\times \int \mathbf{D}[\Phi^{cl}] \int \mathbf{D}[\Phi^q] \exp\left(-2i \int_{-\infty}^{+\infty} dt \Phi^q(t) \left[\frac{d^2\Phi^{cl}}{dt^2} + \frac{\gamma}{2} \frac{d\Phi^{cl}}{dt} + \frac{\partial U(\Phi^{cl})}{\partial \Phi^{cl}} - \xi(t)\right]\right). \end{aligned} \quad (68)$$

Since the exponent depends linearly on  $\Phi^q(t)$ , the integration over  $\mathbf{D}[\Phi^q]$  results in the  $\delta$ -function of the expression in the square brackets. This functional  $\delta$ -function enforces its argument to be zero at every instant of time. Therefore, among all possible trajectories  $\Phi^{cl}(t)$ , only those that satisfy the following equation contribute to the partition function:

$$\frac{d^2\Phi^{cl}}{dt^2} + \frac{\gamma}{2} \frac{d\Phi^{cl}}{dt} + \frac{\partial U(\Phi^{cl})}{\partial \Phi^{cl}} = \xi(t). \quad (69)$$

This is Newton equation with a time-dependent external force  $\xi(t)$ . Since, the same arguments are applicable to any correlation function of the classical fields, e.g.  $\langle \Phi^{cl}(t)\Phi^{cl}(t') \rangle$ , a solution strategy is as follows: (i) choose some realization of  $\xi(t)$ ; (ii) solve (69) (e.g. numerically); (iii) having its solution,  $\Phi^{cl}(t)$ , calculate the correlation function; (iv) average the result over an ensemble of realizations of the force  $\xi(t)$ . The statistics of the latter is dictated by the weight factor in the  $\mathbf{D}[\xi]$  functional integral in (68). It states that  $\xi(t)$  is a Gaussian short-range (white) noise with the correlators

$$\langle \xi(t) \rangle = 0, \quad \langle \xi(t)\xi(t') \rangle = \gamma T \delta(t - t'). \quad (70)$$

Equation (69) with the white noise on the right-hand side is called the Langevin equation. It describes classical Newtonian dynamics in presence of stochastic thermal fluctuations. The fact that the noise amplitude is proportional to the friction coefficient,  $\gamma$ , and the temperature is a manifestation of the FDT. The latter holds as long as the environment (string) is at thermal equilibrium.

### 4.4 Martin–Siggia–Rose method

In the previous section we derived the Langevin equation for a classical coordinate,  $\Phi^{cl}$ , from the action written in terms of  $\Phi^{cl}$  and another field,  $\Phi^q$ . An inverse procedure of deriving the effective action from the Langevin equation is known as Martin–Siggia–Rose (MSR) technique [7]. It is sketched here in the form suggested by DeDominicis [8].

Consider a Langevin equation

$$\hat{\mathcal{O}}[\Phi^{cl}] = \xi(t), \quad (71)$$

where  $\hat{\mathcal{O}}[\Phi^{cl}]$  is a non-linear differential operator acting on the coordinate  $\Phi^{cl}(t)$ , and  $\xi(t)$  is a white noise force, specified by (70). Define the “partition function” as

$$Z[\xi] = \int \mathbf{D}[\Phi^{cl}] \mathcal{J}[\hat{\mathcal{O}}] \delta(\hat{\mathcal{O}}[\Phi^{cl}] - \xi(t)) \equiv 1. \quad (72)$$

It is identically equal to unity by virtue of the integration of the  $\delta$ -function, provided  $\mathcal{J}[\hat{O}]$  is the Jacobian of the operator  $\hat{O}[\Phi^{cl}]$ . The way to interpret (72) is to discretize the time axis, introducing  $N$ -dimensional vectors  $\Phi_j^{cl} = \Phi^{cl}(t_j)$  and  $\xi_j = \xi(t_j)$ . The operator takes the form:  $O_i = O_{ij}\Phi_j^{cl} + \frac{1}{2}\Gamma_{ijk}\Phi_j^{cl}\Phi_k^{cl} + \dots$ , where summations are taken over repeated indexes. The Jacobian,  $\mathcal{J}$ , is given by the absolute value of the determinant of the following  $N \times N$  matrix:  $J_{ij} \equiv \partial O_i / \partial \Phi_j^{cl} = O_{ij} + \Gamma_{ijk}\Phi_k^{cl} + \dots$ . It is possible to choose a proper (retarded) regularization where the  $J_{ij}$  matrix is a lower triangular matrix with a unit main diagonal (coming entirely from the  $O_{ii} = 1$  term). One then finds that, in this case,  $\mathcal{J} = 1$ . Indeed, consider, for example,  $\hat{O}[\Phi^{cl}] = \partial_t \Phi^{cl} - U(\Phi^{cl})$ . The retarded regularized version of the Langevin equation is  $\Phi_i^{cl} = \Phi_{i-1}^{cl} + \delta_t(U(\Phi_{i-1}^{cl}) + \xi_{i-1})$ . Clearly in this case  $J_{ii} = 1$  and  $J_{i,i-1} = -1 - \delta_t U'(\Phi_{i-1}^{cl})$ , while all other components are zero; as a result  $\mathcal{J} = 1$ .

Although the partition function (72) is trivial, it is clear that all meaningful observables and the correlation functions may be obtained by inserting a set of factors:  $\Phi^{cl}(t)\Phi^{cl}(t') \dots$  into the functional integral (72). Having this in mind, let us proceed with the partition function. Employing the integral representation of the  $\delta$ -function with the help of an auxiliary field  $\Phi^q(t)$ , one obtains

$$Z[\xi] = \int \mathbf{D}[\Phi^{cl}, \Phi^q] \exp\left(-2i \int dt \Phi^q(t) [\hat{O}^R[\Phi^{cl}(t)] - \xi(t)]\right), \quad (73)$$

where  $\hat{O}^R$  stands for the retarded regularization of the  $\hat{O}$  operator and thus one takes  $\mathcal{J} = 1$ . One may average now over the white noise (70), by performing the Gaussian integration over  $\xi$

$$\begin{aligned} Z &= \int \mathbf{D}[\xi] \exp\left(-\frac{1}{2\gamma T} \int dt \xi^2(t)\right) Z[\xi] \\ &= \int \mathbf{D}[\Phi^{cl}, \Phi^q] \exp\left(-\int dt \left[2i \Phi^q(t) \hat{O}^R[\Phi^{cl}(t)] + 2\gamma T [\Phi^q(t)]^2\right]\right). \end{aligned} \quad (74)$$

The exponent in (74) is exactly the classical limit of the Keldysh action, cf. (66), including the retarded regularization of the differential operator. The message is that MSR action is nothing else but the classical (high-temperature) limit of the Keldysh action. The MSR technique provides a simple way to transform from a classical stochastic problem to its proper functional representation. The latter is useful for analytical calculations. One example is given below.

## 4.5 Thermal activation

Consider a particle in a meta-stable potential well, plotted in Figure 6a. The potential has a meta-stable minimum at  $\Phi = 0$ , and a maximum at  $\Phi = 1$  with the relative height  $U_0$ . Let us also assume that the particle's motion is over-damped, i.e.  $\gamma \gg \sqrt{U''}$ . In this case one may disregard the inertia term, leaving only viscous relaxation dynamics. The classical dissipative action (66) takes the form

$$S[\Phi] = 2 \int_{-\infty}^{+\infty} dt \left[ -\Phi^q(t) \left( \frac{\gamma}{2} \frac{d\Phi^{cl}}{dt} + \frac{\partial U(\Phi^{cl})}{\partial \Phi^{cl}} \right) + i\gamma T [\Phi^q(t)]^2 \right]. \quad (75)$$

The corresponding saddle point equations are

$$\frac{\gamma}{2} \dot{\Phi}^{cl} = -\frac{\partial U(\Phi^{cl})}{\partial \Phi^{cl}} + 2i\gamma T \Phi^q, \quad (76a)$$

$$\frac{\gamma}{2} \dot{\Phi}^q = \Phi^q \frac{\partial^2 U(\Phi^{cl})}{\partial (\Phi^{cl})^2}. \quad (76b)$$

These equations possess the *classical* solution:  $\Phi^q(t) \equiv 0$  whereas  $\Phi^{cl}(t)$  satisfies the classical equation of motion:  $\frac{\gamma}{2} \dot{\Phi}^{cl} = -\partial U(\Phi^{cl}) / \partial \Phi^{cl}$ . For the initial condition  $\Phi^{cl}(0) < 1$  the latter equation predicts the viscous relaxation towards the minimum at  $\Phi^{cl} = 0$ . According to this equation, there

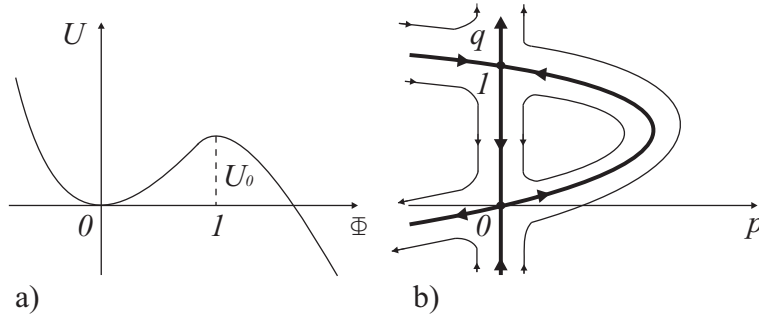

Figure 6: a) A potential with a meta-stable minimum. b) The phase portrait of the Hamiltonian system (77). Thick lines correspond to zero energy, arrows indicate evolution direction.

is no possibility to escape from this minimum. Therefore, the classical solution of (76) does *not* describe thermal activation. Thus, one has to look for another possible solution of (76), the one with  $\Phi^q \neq 0$ .

To this end, let us perform a linear change of variables:  $\Phi^{cl}(t) = q(t)$  and  $\Phi^q(t) = p(t)/(i\gamma)$ . Then the dissipative action (75) acquires the form of a Hamiltonian action  $iS = -\int dt (p\dot{q} - H(p, q))$  where the effective Hamiltonian

$$H(p, q) \equiv \frac{2}{\gamma} \left[ -p \frac{\partial U(q)}{\partial q} + T p^2 \right], \quad (77)$$

is introduced. It is straightforward to see that in terms of the new variables the equations of motion (76) take the form of the Hamilton equations:  $\dot{q} = \partial H / \partial p$  and  $\dot{p} = -\partial H / \partial q$ . One needs, thus, to investigate the Hamiltonian system with the Hamiltonian (77). To visualize it, one may plot its phase portrait, consisting of lines of constant energy  $E = H(p(t), q(t))$  on the  $(p, q)$  plane, see Figure 6b. The topology is determined by the two lines of zero energy,  $p = 0$  and  $Tp = \partial U(q) / \partial q$ , that intersect at the two stationary points of the potential,  $q = 0$  and  $q = 1$ . The  $p = 0$  line corresponds to the classical (without Langevin noise) dynamics (note that the action is identically zero for motion along this line) and thus  $q = 0$  is the stable point, while  $q = 1$  is the unstable one. Owing to Liouville theorem, every fixed point must have one stable and one unstable direction. Therefore, along the “non-classical” line  $p = T^{-1} \partial U(q) / \partial q$ , the situation is reversed:  $q = 0$  is unstable, while  $q = 1$  is stable. It is clear now that to escape from the bottom of the potential well,  $q = 0$ , the system must evolve along the non-classical line of zero energy until it reaches the top of the barrier,  $q = 1$ , and then continue to move according to the classical equation of motion (i.e. moving along the classical line  $p = 0$ ). There is a non-zero action associated with the motion along the non-classical line

$$iS = -\int dt p\dot{q} = -\int_0^1 p(q) dq = -\frac{1}{T} \int_0^1 \frac{\partial U(q)}{\partial q} dq = -\frac{U_0}{T},$$

where one has used that  $H = 0$  along the trajectory. As a result, the thermal escape probability is proportional to  $e^{iS} = e^{-U_0/T}$ , which is nothing but the thermal activation exponent.

Amazingly, this trick of rewriting viscous (or diffusive) dynamics in a Hamiltonian form works in a wide class of problems, see e.g. [37]. The price one has to pay is the doubling of the number of degrees of freedom:  $q$  and  $p$  in the Hamiltonian language, or “classical” and “quantum” components in the Keldysh language.

#### 4.6 Fokker-Planck equation

Another way to approach the action (75) is to notice that it is quadratic in  $\Phi^q$  and therefore the  $\mathbf{D}[\Phi^q]$  integration may be performed explicitly. To shorten notation and emphasize the relation to the

classical coordinate, we follow the previous section and use the notation  $\Phi^{cl}(t) \equiv q(t)$ . Performing the Gaussian integration over  $\Phi^q$  of  $\exp(iS[\Phi])$ , with  $S[\Phi^{cl}, \Phi^q]$  given by (75), one finds the action, depending on  $\Phi^{cl} \equiv q$  only

$$iS[q] = -\frac{1}{2\gamma T} \int_{-\infty}^{+\infty} dt \left( \frac{\gamma}{2} \dot{q} + U'_q \right)^2. \quad (78)$$

One may now employ the same trick, which allows to pass from the Feynman path integral to the Schrödinger equation [38]. Namely, let us introduce the “wave function”,  $\mathcal{P}(q, t)$ , that is a result of the functional integration of  $\exp(iS[q])$  over all trajectories that at time  $t + \delta_t$  pass through the point  $q_N \equiv q$ . Considering explicitly the last time–step,  $\delta_t$ , integration, one may write  $\mathcal{P}(q_N, t + \delta_t)$  as an integral of  $\mathcal{P}(q_{N-1}, t) = \mathcal{P}(q - \delta_q, t)$  over  $\delta_q \equiv q - q_{N-1}$ :

$$\begin{aligned} \mathcal{P}(q, t + \delta_t) &= C \int_{-\infty}^{\infty} d[\delta_q] \exp\left(-\frac{\delta_t}{2\gamma T} \left[ \frac{\gamma}{2} \frac{\delta_q}{\delta_t} + U'_q(q - \delta_q) \right]^2\right) \mathcal{P}(q - \delta_q, t) \\ &= C \int_{-\infty}^{\infty} d[\delta_q] \exp\left(-\frac{\gamma}{8T} \frac{\delta_q^2}{\delta_t}\right) \left[ \exp\left(-\frac{\delta_q}{2T} U'_q(q - \delta_q) - \frac{\delta_t}{2\gamma T} (U'_q)^2\right) \mathcal{P}(q - \delta_q, t) \right], \end{aligned} \quad (79)$$

where the integration measure  $C$  is determined by the condition:  $C \int d[\delta_q] \exp(-\gamma\delta_q^2/(8T\delta_t)) = 1$ . Expanding the expression in the square brackets on the right–hand side of the last equation to the second order in  $\delta_q$  and the first order in  $\delta_t$ , one finds

$$\begin{aligned} \mathcal{P}(t + \delta_t) &= \left( 1 + \frac{\langle \delta_q^2 \rangle}{2T} U''_{qq} + \frac{1}{2} \frac{\langle \delta_q^2 \rangle}{4T^2} (U'_q)^2 - \frac{\delta_t}{2\gamma T} (U'_q)^2 \right) \mathcal{P} + \frac{\langle \delta_q^2 \rangle}{2T} U'_q \mathcal{P}'_q + \frac{\langle \delta_q^2 \rangle}{2} \mathcal{P}''_{qq} \\ &= \mathcal{P}(t) + \frac{2\delta_t}{\gamma} (U''_{qq} \mathcal{P} + U'_q \mathcal{P}'_q + T \mathcal{P}''_{qq}), \end{aligned} \quad (80)$$

where

$$\langle \delta_q^2 \rangle \equiv C \int_{-\infty}^{\infty} d[\delta_q] \delta_q^2 \exp\left(-\frac{\gamma\delta_q^2}{8T\delta_t}\right) = 4T\delta_t/\gamma.$$

Finally, rewriting the last expression in the differential form, one obtains

$$\frac{\partial \mathcal{P}}{\partial t} = \frac{2}{\gamma} \left[ \frac{\partial}{\partial q} \frac{\partial U}{\partial q} + T \frac{\partial^2}{\partial q^2} \right] \mathcal{P} = \frac{2}{\gamma} \frac{\partial}{\partial q} \left[ \frac{\partial U}{\partial q} \mathcal{P} + T \frac{\partial \mathcal{P}}{\partial q} \right]. \quad (81)$$

This is the Fokker–Planck (FP) equation for the evolution of the probability distribution function,  $\mathcal{P}(q, t)$ . The latter describes the probability to find the particle at a point  $q = \Phi^{cl}$  at time  $t$ . If one starts from an initially sharp (deterministic) distribution,  $\mathcal{P}(q, 0) = \delta(q - q(0))$ , then the first term on the right–hand side of the FP equation describes the viscous drift of the particle in the potential  $U(q)$ . Indeed, in the absence of the second term ( $T = 0$ ), the equation is solved by  $\mathcal{P}(q, t) = \delta(q - q(t))$ , where  $q(t)$  satisfies the deterministic equation of motion<sup>5</sup>  $(\gamma/2)\dot{q}(t) = -\partial U(q(t))/\partial q$ . The second term on the right–hand side describes the diffusion spreading of the probability distribution owing to the thermal stochastic noise  $\xi(t)$ . For a confining potential  $U(q)$  (such that  $U(\pm\infty) \rightarrow \infty$ ) the stationary solution of the FP equation is the equilibrium Boltzmann distribution:  $\mathcal{P}(q) \sim \exp\{-U(q)/T\}$ .

The FP equation may be considered as the (imaginary time) Schrödinger equation:  $\dot{\mathcal{P}} = \hat{H}\mathcal{P}$ , where the Hamiltonian,  $\hat{H}$ , is nothing but the “quantized” version of the classical Hamiltonian (77), introduced in the previous section. The “quantization” rule is  $p \rightarrow \hat{p} \equiv -\partial/\partial q$ , so the canonical

<sup>5</sup>To check this statement one may substitute  $\mathcal{P}(q, t) = \delta(q - q(t))$  into the  $T = 0$  FP equation:  $\delta'_q(q - q(t))(-\dot{q}(t)) = (2/\gamma) [U''_{qq}\delta(q - q(t)) + U'_q\delta'_q(q - q(t))]$ . Then multiplying both parts of this equation by  $q$  and integrating over  $dq$  (by performing integration by parts), one finds  $\dot{q}(t) = -(2/\gamma)U'_q(q(t))$ .



commutation relation  $[q, \hat{p}] = 1$ , holds. Notice that before applying this quantization rule, the corresponding classical Hamiltonian must be *normally ordered*. Namely, the momentum  $\hat{p}$  should be to the left of the coordinate  $q$ , cf. (77). Using the commutation relation, one may rewrite the quantized Hamiltonian as

$$\hat{H} = T\hat{p}^2 - \hat{p}U'_q = T(\hat{p} - U'_q/(2T))(\hat{p} - U'_q/(2T)) - (U'_q)^2/(4T) + U''_{qq}/2$$

(we put  $\gamma/2 = 1$ ) and perform the canonical transformation  $Q = q$  and  $\hat{P} = \hat{p} - U'_q/(2T)$ . In terms of these new variables the Hamiltonian takes the familiar form  $\hat{H} = T\hat{P}^2 + V(Q)$ , where  $V(Q) = -(U'_Q)^2/(4T) + U''_{QQ}/2$ , while the “wave function” transforms as  $\tilde{\mathcal{P}}(Q, t) = e^{U(Q)/(2T)}\mathcal{P}$ .

## 4.7 From Matsubara to Keldysh

In some applications it may be convenient to derive an action in the equilibrium *Matsubara* technique [17, 18] and change to the Keldysh representation at a later stage to tackle out-of-equilibrium problems. This section intends to illustrate how such a transformation may be carried out. To this end, consider the following bosonic Matsubara action:

$$S[\Phi_m] = \gamma T \sum_{m=-\infty}^{\infty} \frac{1}{2} |\epsilon_m| |\Phi_m|^2, \quad (82)$$

where  $\epsilon_m = 2\pi Tm$  and  $\Phi_m = \Phi_{-m}^* = \int_0^\beta d\tau \Phi(\tau) e^{i\epsilon_m \tau}$  are the Matsubara components of a real bosonic field,  $\Phi(\tau)$ , with the periodic boundary conditions  $\Phi(0) = \Phi(\beta)$ . Note that, owing to the absolute value sign,  $|\epsilon_m| \neq i\partial_\tau$ . In fact, in the imaginary time representation the kernel  $\mathbb{K}_m = |\epsilon_m|$  of the action (82) acquires the form  $\mathbb{K}(\tau) = \sum_m |\epsilon_m| e^{-i\epsilon_m \tau} = C\delta(\tau) - \pi T^2 / \sin^2(\pi T\tau)$ , where the infinite constant  $C$  is chosen to satisfy  $\int_0^\beta d\tau \mathbb{K}(\tau) = \mathbb{K}_0 = 0$ . As a result, in the imaginary time representation the action (82) has the following non-local form

$$\begin{aligned} S[\Phi] &= \frac{\gamma T}{2} \iint_0^{\beta=1/T} d\tau d\tau' \Phi(\tau) \mathbb{K}(\tau - \tau') \Phi(\tau') \\ &= \frac{\gamma}{4\pi} \iint_0^\beta d\tau d\tau' \frac{\pi^2 T^2}{\sin^2[\pi T(\tau - \tau')]} (\Phi(\tau) - \Phi(\tau'))^2. \end{aligned} \quad (83)$$

This action is frequently named after Caldeira and Leggett [36], who used it to investigate the influence of dissipation on quantum tunneling.

To transform to the Keldysh representation one needs to double the number of degrees of freedom:  $\Phi \rightarrow \vec{\Phi} = (\Phi^{cl}, \Phi^q)^T$ . Then according to the causality structure, Section 2.4, the general form of the time translationally invariant Keldysh action is

$$S[\Phi^{cl}, \Phi^q] = \gamma \int \frac{d\epsilon}{2\pi} (\Phi_\epsilon^{cl}, \Phi_\epsilon^q) \begin{pmatrix} 0 & [\mathfrak{D}^A(\epsilon)]^{-1} \\ [\mathfrak{D}^R(\epsilon)]^{-1} & [\mathfrak{D}^{-1}(\epsilon)]^K \end{pmatrix} \begin{pmatrix} \Phi_\epsilon^{cl} \\ \Phi_\epsilon^q \end{pmatrix}, \quad (84)$$

where  $[\mathfrak{D}^{R(A)}(\epsilon)]^{-1}$  is the analytic continuation of the Matsubara correlator  $|\epsilon_m|/2$  from the *upper (lower)* half-plane of the complex variable  $\epsilon_m$  to the real axis:  $-i\epsilon_m \rightarrow \epsilon$ , see [18]. As a result,  $[\mathfrak{D}^{R(A)}(\epsilon)]^{-1} = \pm i\epsilon/2$ . In equilibrium the Keldysh component follows from the FDT:  $[\mathfrak{D}^{-1}(\epsilon)]^K = ([\mathfrak{D}^R]^{-1} - [\mathfrak{D}^A]^{-1}) \coth(\epsilon/2T) = i\epsilon \coth(\epsilon/2T)$ , cf. (61) and (62). Therefore, the Keldysh counterpart of the Matsubara action (82) or (83), is the already familiar dissipative action (64), (without the potential and inertial terms, of course). One may now include external fields and allow the system to deviate from the equilibrium.

## 4.8 Dissipative chains and membranes

Instead of dealing with a single particle connected to a bath, let us now consider a chain or a lattice of coupled particles, with each one connected to a bath. To this end, we (i) supply a spatial index,  $\mathbf{r}$ , to the field  $\Phi(t) \rightarrow \Phi(\mathbf{r}, t)$ , and (ii) adds the harmonic interaction potential between neighboring particles:  $\sim D(\Phi(\mathbf{r}, t) - \Phi(\mathbf{r} + \mathbf{1}, t))^2 \rightarrow D(\partial_{\mathbf{r}}\Phi)^2$  in the continuum limit, where  $D$  is the rigidity of the chain or membrane. By changing to the classical–quantum components and performing the spatial integration by parts [cf. (421)], the gradient term translates to:  $D(\Phi^q \partial_{\mathbf{r}}^2 \Phi^{cl} + \Phi^{cl} \partial_{\mathbf{r}}^2 \Phi^q)$ . Thus, it modifies the retarded and advanced components of the correlator, but it does *not* affect the  $(q - q)$  Keldysh component:

$$[\mathfrak{D}^{R(A)}]^{-1} = \frac{1}{2} \delta(t - t') \delta(\mathbf{r} - \mathbf{r}') (\mp \partial_t + D \partial_{\mathbf{r}}^2). \quad (85)$$

In the Fourier representation  $[\mathfrak{D}^{R(A)}(\mathbf{k}, \epsilon)]^{-1} = \frac{1}{2} (\pm i\epsilon - D\mathbf{k}^2)$ . In equilibrium the Keldysh component is not affected by the gradient terms, and is given by (62) (in the real space representation it acquires the factor  $\delta(\mathbf{r} - \mathbf{r}')$ ). In particular, its classical limit is  $[\mathfrak{D}^{-1}]^K = i2T\delta(t - t')\delta(\mathbf{r} - \mathbf{r}')$ , cf. (63). As a result, the action of a classical elastic membrane in contact with a bath is

$$S[\Phi^{cl}, \Phi^q] = 2 \iint d\mathbf{r} dt \left[ -\Phi^q \left( \partial_t \Phi^{cl} - D \partial_{\mathbf{r}}^2 \Phi^{cl} + \frac{\partial U(\Phi^{cl})}{\partial \Phi^{cl}} \right) + i2T[\Phi^q]^2 \right], \quad (86)$$

where the inertia terms have been neglected and we put  $\gamma/2 = 1$  for brevity. One may introduce now an auxiliary Hubbard–Stratonovich field  $\xi(\mathbf{r}, t)$  and write the Langevin equation according to Section 4.4:

$$\partial_t \Phi^{cl} - D \partial_{\mathbf{r}}^2 \Phi^{cl} + \frac{\partial U(\Phi^{cl})}{\partial \Phi^{cl}} = \xi(\mathbf{r}, t), \quad (87)$$

where  $\xi$  is a Gaussian noise with short–range correlations  $\langle \xi(\mathbf{r}, t) \xi(\mathbf{r}', t') \rangle = 2T\delta(t - t')\delta(\mathbf{r} - \mathbf{r}')$ .

Let us consider an elastic chain placed in the bottom of the ( $\mathbf{r}$ –independent) meta–stable potential well, depicted in Figure 6a. If a sufficiently large piece of the chain thermally escapes from the well, it may find it favorable to slide down the potential, pulling the entire chain out of the well. To find the shape of such an optimally large critical domain and its action, let us change to the Hamiltonian variables of Section 4.7:  $q(\mathbf{r}, t) \equiv \Phi^{cl}(\mathbf{r}, t)$  and  $p(\mathbf{r}, t) \equiv 2i\Phi^q(\mathbf{r}, t)$ . The action (86) takes the Hamiltonian form  $iS = - \iint d\mathbf{r} dt (p \dot{q} - H(p, q))$  with

$$H \equiv p D \partial_{\mathbf{r}}^2 q - p \frac{\partial U(q)}{\partial q} + T p^2, \quad (88)$$

and the corresponding equations of motion are

$$\dot{q} = \frac{\delta H}{\delta p} = D \partial_{\mathbf{r}}^2 q - U'_q(q) + 2T p, \quad (89a)$$

$$\dot{p} = -\frac{\delta H}{\delta q} = -D \partial_{\mathbf{r}}^2 p + p U''_{qq}(q). \quad (89b)$$

These are complicated partial differential equations, that cannot be solved in general. Fortunately, the shape of the optimal critical domain can be found. As was discussed in Section 4.7, the minimal action trajectory corresponds to a motion with zero energy,  $H = 0$ . According to Eq. (88), this is the case if either  $p = 0$  (classical zero–action trajectory), or  $Tp = U'_q(q) - D \partial_{\mathbf{r}}^2 q$  (finite–action escape trajectory). In the latter case the equation of motion for  $q(\mathbf{r}, t)$  takes the form of the classical equation in the *reversed time*:  $\dot{q} = -D \partial_{\mathbf{r}}^2 q + U'_q(q) = Tp$ . Thanks to the last equality the equation of motion for  $p(\mathbf{r}, t)$  is automatically satisfied<sup>6</sup>. In the reversed time dynamics the  $q(\mathbf{r}, t) = 0$  configuration is unstable and therefore the chain develops a “tongue” that grows until it reaches the stationary shape:

$$-D \partial_{\mathbf{r}}^2 q + U'_q(q) = 0. \quad (90)$$

<sup>6</sup>Indeed,  $T\dot{p} = \partial_t \dot{q} = -D \partial_{\mathbf{r}}^2 \dot{q} + \dot{q} U''_{qq} = T(-D \partial_{\mathbf{r}}^2 p + p U''_{qq})$ . This non–trivial fact reflects the existence of an accidental conservation law:  $H(p(\mathbf{r}, t), q(\mathbf{r}, t)) = 0$  – *locally!* While from the general principles only the total global energy has to be conserved.

The solution of this equation with the boundary conditions  $q(\pm\infty) = 0$  gives the shape of the critical domain. Once it is formed, it may grow further according to the classical equation  $\dot{q} = D\partial_r^2 q - U'_q(q)$  and  $p = 0$  with zero action. The action along the non-classical escape trajectory, paid to form the “tongue” is ( $H(p, q) = 0$ ):

$$iS = - \iint \mathrm{d}\mathbf{r} \mathrm{d}t p \dot{q} = -\frac{1}{T} \iint \mathrm{d}\mathbf{r} \mathrm{d}t \left( -D\partial_r^2 q + U'_q(q) \right) \dot{q} = -\frac{1}{T} \int \mathrm{d}\mathbf{r} \left( \frac{D}{2} (\partial_r q)^2 + U(q) \right), \quad (91)$$

where in the last equality an explicit integration over time was performed. The escape action is given therefore by the static activation expression that includes both the elastic and the potential energies. The optimal domain (90), is found by the minimization of this static action (91). One arrives, thus, at a thermodynamic Landau-type description of the first-order phase transitions. Note that the effective thermodynamic description appears owing to the assumption that  $H(p, q) = 0$ , when all the processes take infinitely long time.

## 5 Fermions

### 5.1 Partition function

Consider a single quantum state with energy  $\epsilon_0$ . This state is populated by spin-less fermions (particles obeying the Pauli exclusion principle). In fact, one may have either zero, or one particle in this state. The secondary quantized Hamiltonian of such a system has the form

$$\hat{H} = \epsilon_0 \hat{c}^\dagger \hat{c}, \quad (92)$$

where  $\hat{c}^\dagger$  and  $\hat{c}$  are creation and annihilation operators of fermions on the state  $\epsilon_0$ . They obey standard anti-commutation relations:  $\{\hat{c}, \hat{c}^\dagger\} = 1$  and  $\{\hat{c}, \hat{c}\} = \{\hat{c}^\dagger, \hat{c}^\dagger\} = 0$ , where  $\{, \}$  stands for the anti-commutator.

One can now consider the evolution operator along the Keldysh contour,  $C$  and the corresponding partition function,  $Z = 1$ , defined in exactly the same way as for bosonic systems (6). The trace of the equilibrium density matrix is  $\mathrm{Tr}\{\hat{\rho}_0\} = 1 + \rho(\epsilon_0)$ , where the two terms stand for the empty and the singly occupied states. One divides the Keldysh contour onto  $(2N - 2)$  time intervals of length  $\delta_t \sim 1/N \rightarrow 0$  and introduces resolutions of unity in  $2N$  points along the Keldysh contour,  $C$ ; see Figure 1. The only difference from the bosonic case of Section 2.1 is that now one uses the resolution of unity in the fermionic coherent state basis<sup>7</sup>

$$\hat{1} = \iint \mathrm{d}\bar{\psi}_j \mathrm{d}\psi_j e^{-\bar{\psi}_j \psi_j} |\psi_j\rangle \langle \psi_j|, \quad (93)$$

where  $\bar{\psi}_j$  and  $\psi_j$  are *mutually independent* Grassmann variables. The rest of the algebra goes through exactly as in the bosonic case, see Section 2.1. As a result, one arrives at

$$Z = \frac{1}{\mathrm{Tr}\{\hat{\rho}_0\}} \iint \prod_{j=1}^{2N} [\mathrm{d}\bar{\psi}_j \mathrm{d}\psi_j] \exp \left( i \sum_{j,j'=1}^{2N} \bar{\psi}_j G_{jj'}^{-1} \psi_{j'} \right), \quad (94)$$

<sup>7</sup>The fermionic coherent state  $|\psi\rangle \equiv (1 - \psi \hat{c}^\dagger)|0\rangle$ , parameterized by a Grassmann number  $\psi$  (such that  $\{\psi, \psi'\} = \{\psi, \hat{c}\} = 0$ ), is an eigenstate of the annihilation operator:  $\hat{c}|\psi\rangle = \psi|\psi\rangle$ . Similarly,  $\langle \psi|\hat{c}^\dagger = \langle \psi|\bar{\psi}$ , where  $\bar{\psi}$  is another Grassmann number, *unrelated* to  $\psi$ . The matrix elements of a *normally ordered* operator, such as e.g. the Hamiltonian, take the form  $\langle \psi|\hat{H}(\hat{c}^\dagger, \hat{c})|\psi'\rangle = H(\bar{\psi}, \psi')\langle \psi|\psi'\rangle$ . The overlap between any two coherent states is  $\langle \psi|\psi'\rangle = 1 + \bar{\psi}\psi' = \exp\{\bar{\psi}\psi'\}$ . The trace of an operator,  $\hat{O}$ , is calculated as  $\mathrm{Tr}\{\hat{O}\} = \langle 0|\hat{O}|0\rangle + \langle 1|\hat{O}|1\rangle = \langle 0|\hat{O}|0\rangle + \langle 0|\hat{c}\hat{O}\hat{c}^\dagger|0\rangle = \iint \mathrm{d}\bar{\psi} \mathrm{d}\psi e^{-\bar{\psi}\psi} \langle -\bar{\psi}|\hat{O}|\psi\rangle$ , where the Grassmann integrals are *defined* as  $\int \mathrm{d}\psi \psi = 0$  and  $\int \mathrm{d}\psi \psi = 1$ .

where the  $2N \times 2N$  matrix  $G_{jj'}^{-1}$  is

$$iG_{jj'}^{-1} \equiv \left[ \begin{array}{ccc|ccc} -1 & & & & & \\ 1-h & -1 & & & & -\rho(\epsilon_0) \\ & 1-h & -1 & & & \\ \hline & & & 1 & & \\ & & & -1 & & \\ & & & 1+h & -1 & \\ & & & & 1+h & -1 \end{array} \right], \quad (95)$$

and  $h \equiv i\epsilon_0\delta_t$ . The only difference from the bosonic case is the negative sign in front of  $\rho(\epsilon_0)$  matrix element, originating from the minus sign in the  $\langle -\psi_{2N} |$  coherent state in the expression for the fermionic trace. To check the normalization, let us evaluate the determinant of such a matrix

$$\text{Det}[i\hat{G}^{-1}] = 1 + \rho(\epsilon_0)(1 - h^2)^{N-1} \approx 1 + \rho(\epsilon_0) e^{(\epsilon_0\delta_t)^2(N-1)} \rightarrow 1 + \rho(\epsilon_0). \quad (96)$$

Employing the fact that the fermionic Gaussian integral is given by the determinant (unlike the inverse determinant for bosons) of the correlation matrix, (see Appendix A for details), one finds

$$Z = \frac{\text{Det}[i\hat{G}^{-1}]}{\text{Tr}\{\hat{\rho}_0\}} = 1, \quad (97)$$

as it should be. Once again, the upper-right element of the discrete matrix (95) is crucial to maintain the correct normalization. Taking the limit  $N \rightarrow \infty$  and introducing the continuum notation,  $\psi_j \rightarrow \psi(t)$ , one obtains

$$Z = \int \mathbf{D}[\bar{\psi}\psi] \exp(iS[\bar{\psi}, \psi]) = \int \mathbf{D}[\bar{\psi}\psi] \exp\left(i \int_C dt [\bar{\psi}(t) \hat{G}^{-1} \psi(t)]\right), \quad (98)$$

where according to (94) and (95) the action is given by

$$S[\bar{\psi}, \psi] = \sum_{j=2}^{2N} \left[ i\bar{\psi}_j \frac{\psi_j - \psi_{j-1}}{\delta t_j} - \epsilon_0 \bar{\psi}_j \psi_{j-1} \right] \delta t_j + i\bar{\psi}_1 [\psi_1 + \rho(\epsilon_0)\psi_{2N}], \quad (99)$$

with  $\delta t_j \equiv t_j - t_{j-1} = \pm\delta_t$ . Thus the continuum form of the operator  $\hat{G}^{-1}$  is the same as for bosons (17):  $\hat{G}^{-1} = i\partial_t - \epsilon_0$ . Again the upper-right element of the discrete matrix (the last term in (99)), which contains information about the distribution function, is seemingly absent in the continuum notation.

Splitting the Grassmann field  $\psi(t)$  into the two components  $\psi_+(t)$  and  $\psi_-(t)$  that reside on the forward and the backward parts of the time contour, respectively, one may rewrite the action as

$$S[\bar{\psi}, \psi] = \int_{-\infty}^{+\infty} dt [\bar{\psi}_+(t)(i\partial_t - \epsilon_0)\psi_+(t) - \bar{\psi}_-(t)(i\partial_t - \epsilon_0)\psi_-(t)], \quad (100)$$

where the dynamics of  $\psi_+$  and  $\psi_-$  are actually *not* independent from each other, owing to the presence of non-zero off-diagonal blocks in the discrete matrix (95).

## 5.2 Green's functions and Keldysh rotation

The four fermionic Green's functions:  $G^{\mathbb{T}(\bar{\mathbb{T}})}$  and  $G^{<(>)}$  are defined in the same way as their bosonic counterparts, see (21),

$$\langle \psi_+(t)\bar{\psi}_-(t') \rangle \equiv iG^{<}(t, t') = -n_F \exp\{-i\epsilon_0(t - t')\}, \quad (101a)$$

$$\langle \psi_-(t)\bar{\psi}_+(t') \rangle \equiv iG^{>}(t, t') = (1 - n_F) \exp\{-i\epsilon_0(t - t')\}, \quad (101b)$$

$$\langle \psi_+(t)\bar{\psi}_+(t') \rangle \equiv iG^{\mathbb{T}}(t, t') = \theta(t - t')iG^{>}(t, t') + \theta(t' - t)iG^{<}(t, t'), \quad (101c)$$

$$\langle \psi_-(t) \bar{\psi}_-(t') \rangle \equiv iG^{\bar{\mathbb{T}}}(t, t') = \theta(t' - t) iG^>(t, t') + \theta(t - t') iG^<(t, t'). \quad (101d)$$

The difference, however, is in the minus sign in the expression for  $G^<$ , due to the anti-commutation relations, and Bose occupation number is exchanged for the Fermi occupation number:  $n_B \rightarrow n_F \equiv \rho(\epsilon_0)/(1 + \rho(\epsilon_0))$ . Equations (22a) and (22b) hold for the fermionic Green's functions as well.

It is customary to perform the Keldysh rotation in the fermionic case in a different manner from the bosonic one. Define the new fields as

$$\psi_1(t) = \frac{1}{\sqrt{2}}(\psi_+(t) + \psi_-(t)), \quad \psi_2(t) = \frac{1}{\sqrt{2}}(\psi_+(t) - \psi_-(t)). \quad (102)$$

Following Larkin and Ovchinnikov [39], it is agreed that the *bar*-fields transform in a different way:

$$\bar{\psi}_1(t) = \frac{1}{\sqrt{2}}(\bar{\psi}_+(t) - \bar{\psi}_-(t)), \quad \bar{\psi}_2(t) = \frac{1}{\sqrt{2}}(\bar{\psi}_+(t) + \bar{\psi}_-(t)). \quad (103)$$

The point is that the Grassmann fields  $\bar{\psi}$  are *not* conjugated to  $\psi$ , but rather are completely independent fields, that may be transformed in an arbitrary manner (as long as the transformation matrix has a non-zero determinant). Note that there is no issue regarding the convergence of the integrals, since the Grassmann integrals are always convergent. We also avoid the subscripts  $cl$  and  $q$ , because the Grassmann variables never have a classical meaning. Indeed, one can never write a saddle point or any other equation in terms of  $\bar{\psi}, \psi$ , rather they must always be integrated out in some stage of the calculations.

Employing (102), (103) along with Eq. (101), one finds

$$-i\langle \psi_a(t) \bar{\psi}_b(t') \rangle = G_{ab}(t, t') = \begin{pmatrix} G^R(t, t') & G^K(t, t') \\ 0 & G^A(t, t') \end{pmatrix}, \quad (104)$$

where hereafter  $a, b = (1, 2)$ . The fact that the  $(2, 1)$  element of this matrix is zero is a manifestation of identity (22a). The *retarded*, *advanced* and *Keldysh* components of the Green's function (104) are expressed in terms of  $G^{\mathbb{T}(\bar{\mathbb{T}})}$  and  $G^{<(>)}$  in exactly the same way as their bosonic analogs (25), and therefore posses the same symmetry properties: (26)–(30). An important consequence of (27) and (30) is

$$\text{Tr} \{ G_{ab}^{(1)} \circ G_{bc}^{(2)} \circ \dots \circ G_{za}^{(l)} \}(t, t) = 0, \quad (105)$$

where the circular multiplication sign involves convolution in the time domain along with the  $2 \times 2$  matrix multiplication. The argument  $(t, t)$  states that the first time argument of  $G^{(1)}$  and the last argument of  $G^{(l)}$  are the same.

Note that the fermionic Green's function has a different structure compared to its bosonic counterpart (28): the positions of the  $R, A$  and  $K$  components in the matrix are exchanged. The reason, of course, is the different convention for transformation of the *bar* fields. One could choose the fermionic convention to be the same as the bosonic (but *not* the other way around), thus having the same structure (28) for the fermions as for the bosons. The rationale for the Larkin–Ovchinnikov choice (104) is that the inverse Green's function,  $\hat{G}^{-1}$  and fermionic self-energy  $\hat{\Sigma}_F$  have the same appearance as  $\hat{G}$ , namely

$$\hat{G}^{-1} = \begin{pmatrix} [G^R]^{-1} & [G^{-1}]^K \\ 0 & [G^A]^{-1} \end{pmatrix}, \quad \hat{\Sigma}_F = \begin{pmatrix} \Sigma_F^R & \Sigma_F^K \\ 0 & \Sigma_F^A \end{pmatrix}, \quad (106)$$

whereas in the case of bosons  $\hat{G}^{-1}$  (see (33)) and  $\hat{\Sigma}$  (see (47)) look differently from  $\hat{G}$  (see (28)). This fact gives the form (104) and (106) a certain technical advantage.

For the single fermionic state, after the Keldysh rotation, the correlation functions (101) allow us to find components of the matrix (104)

$$G^R(t, t') = -i\theta(t - t') e^{-i\epsilon_0(t-t')} \rightarrow (\epsilon - \epsilon_0 + i0)^{-1}, \quad (107a)$$

$$G^A(t, t') = i\theta(t' - t)e^{-i\epsilon_0(t-t')} \rightarrow (\epsilon - \epsilon_0 - i0)^{-1}, \quad (107b)$$

$$G^K(t, t') = -i(1 - 2n_F)e^{-i\epsilon_0(t-t')} \rightarrow -2\pi i(1 - 2n_F)\delta(\epsilon - \epsilon_0), \quad (107c)$$

where the right-hand side provides also the Fourier transforms. In thermal equilibrium, one obtains

$$G^K(\epsilon) = [G^R(\epsilon) - G^A(\epsilon)] \tanh \frac{\epsilon}{2T}. \quad (108)$$

This is the FDT for fermions. As in the case of bosons, FDT is a generic feature of an equilibrium system, not restricted to the toy model. In general, it is convenient to parameterize the anti-Hermitian Keldysh Green's function by a Hermitian matrix  $F = F^\dagger$  as

$$G^K = G^R \circ F - F \circ G^A. \quad (109)$$

The Wigner transform of  $F(t, t')$  plays the role of the fermionic distribution function.

### 5.3 Free fermionic fields and their action

One may proceed now to a system with many degrees of freedom, labeled by an index  $\mathbf{k}$ . To this end, one changes  $\epsilon_0 \rightarrow \epsilon_{\mathbf{k}}$  and performs summations over  $\mathbf{k}$ . If  $\mathbf{k}$  is a momentum and  $\epsilon_{\mathbf{k}} = \mathbf{k}^2/(2m)$ , it is instructive to transform to the coordinate space representation  $\psi(\mathbf{k}, t) \rightarrow \psi(\mathbf{r}, t)$ , while  $\epsilon_{\mathbf{k}} = \mathbf{k}^2/(2m) \rightarrow -\partial_{\mathbf{r}}^2/(2m)$ . Finally, the Keldysh action for a non-interacting gas of fermions takes the form

$$S_0[\bar{\psi}, \psi] = \iint dx dx' \sum_{a,b=1}^2 \bar{\psi}_a(x) [\hat{G}^{-1}(x, x')]_{ab} \psi_b(x'), \quad (110)$$

where  $x = (\mathbf{r}, t)$  and the matrix correlator  $[\hat{G}^{-1}]_{ab}$  has the structure of (106) with

$$[G^{R(A)}(x, x')]^{-1} = \delta(x - x') \left( i\partial_t + \frac{1}{2m}\partial_{\mathbf{r}}^2 + \mu \right). \quad (111)$$

Although in continuum notation the  $R$  and the  $A$  components look seemingly the same, one has to remember that in the discrete time representation, they are matrices with the structure below and above the main diagonal, respectively. The Keldysh component is a pure regularization, in the sense that it does not have a continuum limit (the self-energy Keldysh component does have a non-zero continuum representation). All of this information is already properly taken into account, however, in the structure of the Green's function (104).

### 5.4 External fields and sources

According to the basic idea of the Keldysh technique, the partition function  $Z = 1$  is normalized by construction, see (97). To make the entire theory meaningful one should introduce auxiliary source fields, which enable one to compute various observable quantities: density of particles, currents, etc. For example, one may introduce an external time-dependent scalar potential  $V(\mathbf{r}, t)$  defined along the contour  $C$ . It interacts with the fermions as  $S_V = \int d\mathbf{r} \int_C dt V(\mathbf{r}, t) \bar{\psi}(\mathbf{r}, t) \psi(\mathbf{r}, t)$ . Expressing it via the field components residing on the forward and backward contour branches, one finds

$$\begin{aligned} S_V &= \int d\mathbf{r} \int_{-\infty}^{+\infty} dt [V_+ \bar{\psi}_+ \psi_+ - V_- \bar{\psi}_- \psi_-] \\ &= \int d\mathbf{r} \int_{-\infty}^{+\infty} dt [V^{cl}(\bar{\psi}_+ \psi_+ - \bar{\psi}_- \psi_-) + V^q(\bar{\psi}_+ \psi_+ + \bar{\psi}_- \psi_-)] \\ &= \int d\mathbf{r} \int_{-\infty}^{+\infty} dt [V^{cl}(\bar{\psi}_1 \psi_1 + \bar{\psi}_2 \psi_2) + V^q(\bar{\psi}_1 \psi_2 + \bar{\psi}_2 \psi_1)], \end{aligned} \quad (112)$$

where the  $V^{cl(q)}$  components are defined in the standard way for real boson fields,  $V^{cl(q)} = (V_+ \pm V_-)/2$ , way. We also performed rotation from  $\psi_{\pm}$  to  $\psi_{1(2)}$  according to (102) and (103). Note that the physical fermionic density (symmetrized over the two branches of the Keldysh contour)  $\rho = \frac{1}{2}(\bar{\psi}_+\psi_+ + \bar{\psi}_-\psi_-)$  is coupled to the quantum component of the source field,  $V^q$ . On the other hand, the classical source component,  $V^{cl}$ , is nothing but an external physical scalar potential, the same at the two branches.

Notation may be substantially compactified by introducing two vertex  $\hat{\gamma}$ -matrices:

$$\hat{\gamma}^{cl} \equiv \begin{pmatrix} 1 & 0 \\ 0 & 1 \end{pmatrix}, \quad \hat{\gamma}^q \equiv \begin{pmatrix} 0 & 1 \\ 1 & 0 \end{pmatrix}. \quad (113)$$

With the help of these definitions, the source action (112) may be written as

$$S_V = \int d\mathbf{r} \int_{-\infty}^{+\infty} dt \sum_{a,b=1}^2 [V^{cl} \bar{\psi}_a \gamma_{ab}^{cl} \psi_b + V^q \bar{\psi}_a \gamma_{ab}^q \psi_b] = \text{Tr}\{\vec{\Psi} \hat{V} \vec{\Psi}\}, \quad (114)$$

where we have introduced Keldysh doublet  $\vec{\Psi}$  and matrix  $\hat{V}$ , defined as

$$\vec{\Psi} = \begin{pmatrix} \psi_1 \\ \psi_2 \end{pmatrix}, \quad \hat{V} = V^\alpha \hat{\gamma}^\alpha = \begin{pmatrix} V^{cl} & V^q \\ V^q & V^{cl} \end{pmatrix}, \quad (115)$$

where  $\alpha = (cl, q)$ .

In a similar way one may introduce external vector potential into the formalism. The corresponding part of the action<sup>8</sup>  $S_A = \int d\mathbf{r} \int_C dt \mathbf{A}(\mathbf{r}, t) \mathbf{j}(\mathbf{r}, t)$  represents the coupling between  $\mathbf{A}(\mathbf{r}, t)$  and the fermion current  $\mathbf{j}(\mathbf{r}, t) = \frac{1}{2m}[\bar{\psi}(\mathbf{r}, t) \partial_{\mathbf{r}} \psi(\mathbf{r}, t) - \partial_{\mathbf{r}} \bar{\psi}(\mathbf{r}, t) \psi(\mathbf{r}, t)]$ . By splitting  $\int_C dt$  into forward and backward parts, performing Keldysh rotation, one finds by analogy with the scalar potential case (112) that

$$S_A = \text{Tr}\{\vec{\Psi} \hat{\mathbf{A}} \mathbf{v}_F \vec{\Psi}\}, \quad \hat{\mathbf{A}} = \mathbf{A}^\alpha \hat{\gamma}^\alpha = \begin{pmatrix} \mathbf{A}^{cl} & \mathbf{A}^q \\ \mathbf{A}^q & \mathbf{A}^{cl} \end{pmatrix}. \quad (116)$$

We have linearized the fermionic dispersion relation near the Fermi energy and employed that  $-i\partial_{\mathbf{r}} \approx \mathbf{p}_F$  and  $\mathbf{v}_F = \mathbf{p}_F/m$ .

Let us now define the generating function as

$$Z[V^{cl}, V^q] \equiv \langle \exp(iS_V) \rangle, \quad (117)$$

where the angular brackets denote the functional integration over the Grassmann fields  $\bar{\psi}$  and  $\psi$  with the weight  $\exp(iS_0)$ , specified by the fermionic action (110). In the absence of the quantum component,  $V^q = 0$ , the source field is the same at both branches of the time contour. Therefore, the evolution along the contour brings the system back to its exact original state. Thus, one expects that the classical component alone does not change the fundamental normalization,  $Z = 1$ . As a result,

$$Z[V^{cl}, 0] \equiv 1, \quad (118)$$

as we already discussed in Section 2, see (35). Indeed, one may verify this statement explicitly by expanding the partition function (117) in powers of  $V^{cl}$  and employing the Wick theorem. For example, in the first order, one finds  $Z[V^{cl}, 0] = 1 + \int dt \text{Tr}[\hat{\gamma}^{cl} \hat{G}(t, t)] = 1$ , where one uses that  $\hat{\gamma}^{cl} = \hat{1}$  along with (105). It is straightforward to see that for exactly the same reason all higher-order terms in  $V^{cl}$  vanish as well.

A lesson from (118) is that one necessarily has to introduce *quantum* sources (which change sign between the forward and the backward branches of the contour). The presence of such source fields explicitly violates causality, and thus changes the generating function. On the other hand, these

<sup>8</sup>The vector source  $\mathbf{A}(\mathbf{r}, t)$  that we are using here differs from the actual vector potential by the factor of  $e/c$ . However, we refer to it as the vector potential and restore electron charge in the final expressions.

fields usually do not have a physical meaning and play only an auxiliary role. In most cases one uses them only to generate observables by an appropriate differentiation. Indeed, as was mentioned above, the physical density is coupled to the quantum component of the source. In the end, one takes the quantum sources to be zero, restoring the causality of the action. Note that the classical component,  $V^{cl}$ , does *not* have to be taken to zero.

Let us see how it works. Suppose we are interested in the average fermion density  $\varrho$  at time  $t$  in the presence of a certain physical scalar potential  $V^{cl}(t)$ . According to (112) and (117) it is given by

$$\varrho(x; V^{cl}) = -\frac{i}{2} \frac{\delta}{\delta V^q(x)} Z[V^{cl}, V^q] \Big|_{V^q=0}, \quad (119)$$

where  $x = (\mathbf{r}, t)$ . The problem is simplified if the external field,  $V^{cl}$ , is weak in some sense. One may then restrict oneself to the linear response, by defining the susceptibility

$$\Pi^R(x, x') \equiv \frac{\delta}{\delta V^{cl}(x')} \varrho(x; V^{cl}) \Big|_{V^{cl}=0} = -\frac{i}{2} \frac{\delta^2 Z[V^{cl}, V^q]}{\delta V^{cl}(x') \delta V^q(x)} \Big|_{V^q=V^{cl}=0}. \quad (120)$$

We add the subscript  $R$  anticipating on the physical ground that the response function must be *re-tarded* (causality). We demonstrate it momentarily. First, let us introduce the *polarization* matrix as

$$\hat{\Pi}^{\alpha\beta}(x, x') \equiv -\frac{i}{2} \frac{\delta^2 \ln Z[\hat{V}]}{\delta V^\beta(x') \delta V^\alpha(x)} \Big|_{\hat{V}=0} = \begin{pmatrix} 0 & \Pi^A(x, x') \\ \Pi^R(x, x') & \Pi^K(x, x') \end{pmatrix}. \quad (121)$$

Owing to the fundamental normalization, (118), the logarithm is redundant for the  $R$  and the  $A$  components and therefore the two definitions (120) and (121) are not in contradiction. The fact that  $\Pi^{cl,cl} = 0$  is obvious from (118). To evaluate the polarization matrix,  $\hat{\Pi}$ , consider the Gaussian action (110). Adding the source term (114), one finds:  $S_0 + S_V = \int dx \bar{\Psi}[\hat{G}^{-1} + V^\alpha \hat{\gamma}^\alpha] \Psi$ . Integrating out the fermion fields  $\bar{\Psi}, \Psi$  according to the rules of fermionic Gaussian integration, Appendix A, one obtains

$$Z[V^{cl}, V^q] = \frac{1}{\text{Tr}\{\hat{\rho}_0\}} \text{Det} [i\hat{G}^{-1} + iV^\alpha \hat{\gamma}^\alpha] = \text{Det} [\hat{1} + \hat{G} V^\alpha \hat{\gamma}^\alpha] = \exp \{ \text{Tr} \ln [\hat{1} + \hat{G} V^\alpha \hat{\gamma}^\alpha] \}, \quad (122)$$

where (97) has been used. Since  $Z[0] = 1$ , the normalization is exactly right. One may now expand  $\ln[\hat{1} + \hat{G} V^\alpha \hat{\gamma}^\alpha]$  to the second order in  $V^\alpha$ . As a result, one finds for the polarization matrix

$$\hat{\Pi}^{\alpha\beta}(x, x') = -\frac{i}{2} \text{Tr} \{ \hat{\gamma}^\alpha \hat{G}(x, x') \hat{\gamma}^\beta \hat{G}(x', x) \}, \quad (123)$$

which has a transparent diagrammatic representation, see Figure 7.

Substituting the explicit form of the gamma matrices, (113), and the Green's functions (104), one obtains for the *response* and the *correlation* components

$$\Pi^{R(A)}(x, x') = -\frac{i}{2} [G^{R(A)}(x, x') G^K(x', x) + G^K(x, x') G^{A(R)}(x', x)], \quad (124a)$$

$$\Pi^K(x, x') = -\frac{i}{2} [G^K(x, x') G^K(x', x) + G^R(x, x') G^A(x', x) + G^A(x, x') G^R(x', x)]. \quad (124b)$$

From the first line it is obvious that  $\Pi^{R(A)}(x, x')$  is indeed a lower (upper) triangular matrix in the time domain, justifying their superscripts. Moreover, from the symmetry properties of the fermionic Green's functions one finds:  $\Pi^R = [\Pi^A]^\dagger$  and  $\Pi^K = -[\Pi^K]^\dagger$ . As a result, the polarization matrix,  $\hat{\Pi}$ , possesses all the symmetry properties of the bosonic self-energy  $\hat{\Sigma}$ , see (47).

Equation (124) for  $\Pi^R$  constitutes the Kubo formula [12, 40] for the density–density response function. In equilibrium it may be derived using the Matsubara technique. The Matsubara routine involves the analytical continuation from discrete imaginary frequency  $\omega_m = 2\pi imT$  to the real frequency  $\omega$ . This procedure may prove to be cumbersome in specific applications. The purpose of the above discussion is to demonstrate how the linear response problems may be compactly formulated in the Keldysh language. The latter allows to circumvent the analytical continuation and yields results directly in the real frequency domain.



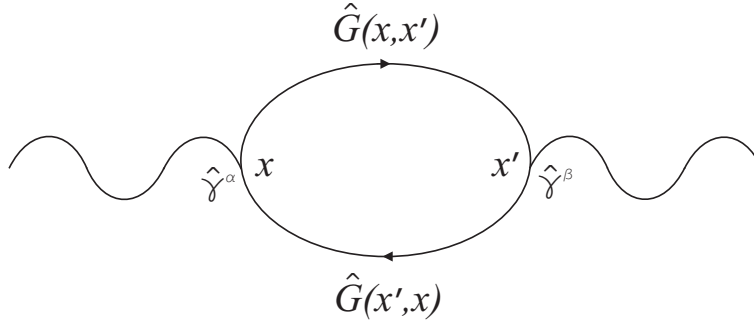

Figure 7: Polarization operator  $\hat{\Pi}^{\alpha\beta}(x, x')$ : each solid line stands for the fermion matrix Green function (104), wavy lines represent external classical or quantum potentials  $V^{cl(q)}$ , and  $x = (\mathbf{r}, t)$ . The loop diagram is a graphic representation of the trace in (123).

## 5.5 Applications I: Quantum transport

### 5.5.1 Landauer formula

Let us illustrate how Keldysh technique can be applied to calculate Landauer conductance [41] of a quantum point contact (QPC). For that purpose consider quasi-one-dimensional adiabatic constriction connected to two reservoirs, to be referred to as left ( $L$ ) and right ( $R$ ). The distribution functions of electrons in the reservoirs are Fermi distributions  $n_{L(R)}(\epsilon_k) = [\exp[(\epsilon_k - \mu_{L(R)})/T] + 1]^{-1}$ , with electrochemical potentials shifted by the voltage  $\mu_L - \mu_R = eV$ . Within QPC electron motion is separable into transverse and longitudinal components. Owing to the confinement transverse motion is quantized and we assign quantum number  $n$  to label transverse conduction channels with  $\phi_n(\mathbf{r}_\perp)$  being corresponding transversal wave functions. The longitudinal motion is described in terms of the extended scattering states, i.e. normalized electron plane waves incident from the left

$$u_n^L(k, \mathbf{r}) = \phi_n(\mathbf{r}_\perp) \begin{cases} e^{ikx} + \mathbf{r}_n(k)e^{-ikx} & x \rightarrow -\infty \\ \mathbf{t}_n(k)e^{ikx} & x \rightarrow +\infty \end{cases}, \quad (125)$$

and the right

$$u_n^R(k, \mathbf{r}) = \phi_n(\mathbf{r}_\perp) \begin{cases} e^{-ikx} + \mathbf{r}_n(k)e^{ikx} & x \rightarrow +\infty \\ \mathbf{t}_n(k)e^{-ikx} & x \rightarrow -\infty \end{cases}, \quad (126)$$

onto mesoscopic scattering region (Figure 8). Here  $k(\epsilon)$  is the electron wave vector and  $\mathbf{t}_n(k)$  and  $\mathbf{r}_n(k)$  are channel specific transmission and reflection amplitudes. Second quantized electron field operator is introduced in the standard way

$$\hat{\Psi}(\mathbf{r}, t) = \sum_{nk} [\hat{\psi}_n^L(k, t)u_n^L(k, \mathbf{r}) + \hat{\psi}_n^R(k, t)u_n^R(k, \mathbf{r})], \quad (127)$$

where  $\hat{\psi}_n^{L(R)}(k, t)$  are fermion destruction operators in the left and right reservoirs, respectively. For the future use we define also current operator

$$\hat{I}(x, t) = \sum_{nk, n'k'} M_{nn'}^{ab} \hat{\psi}_n^{\dagger a}(k, t) \hat{\psi}_{n'}^b(k', t), \quad (128)$$

with the matrix elements

$$M_{nn'}^{ab}(x, k, k') = \frac{e}{2im} \int d\mathbf{r}_\perp [u_n^{*a}(k, \mathbf{r}) \partial_x u_{n'}^b(k', \mathbf{r}) - [\partial_x u_n^{*a}(k, \mathbf{r})] u_{n'}^b(k', \mathbf{r})], \quad a = L, R, \quad (129)$$

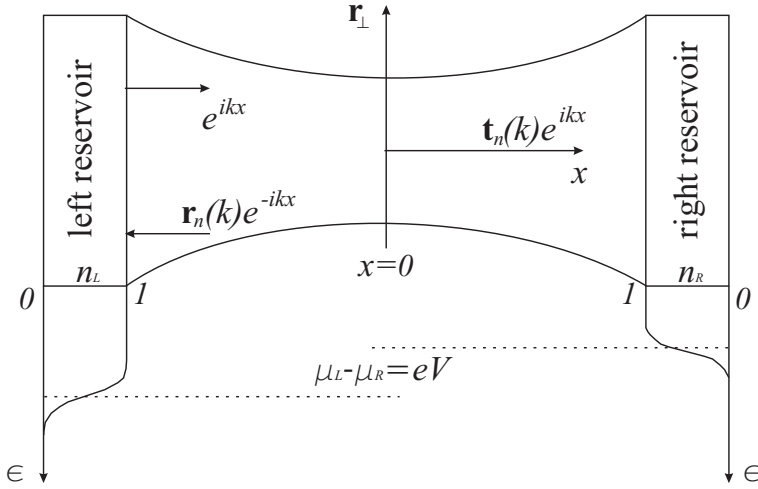

Figure 8: Two terminal scattering problem from the quantum point contact.

which are constructed from the scattering states (125)–(126). Based on the orthogonality condition  $\int d\mathbf{r}_\perp \phi_n(\mathbf{r}_\perp) \phi_{n'}^*(\mathbf{r}_\perp) = \delta_{nn'}$ , direct calculation of  $\hat{M}_{nn'}(x; k, k')$  for  $x > 0$  gives<sup>9</sup>

$$\hat{M}_{nn'}(k, k') = ev_F \delta_{nn'} \begin{pmatrix} \mathbf{t}_n^*(k) \mathbf{t}_n(k') & \mathbf{t}_n^*(k) \mathbf{r}_n(k') \\ \mathbf{r}_n^*(k) \mathbf{t}_n(k') & \mathbf{r}_n^*(k) \mathbf{r}_n(k') - 1 \end{pmatrix} \approx ev_F \delta_{nn'} \begin{pmatrix} |\mathbf{t}_n|^2 & \mathbf{t}_n^* \mathbf{r}_n \\ \mathbf{r}_n^* \mathbf{t}_n & -|\mathbf{t}_n|^2 \end{pmatrix}, \quad (130)$$

where  $v_F = k_F/m$  is Fermi velocity. For  $x < 0$  the expression for  $\hat{M}$  is similar and different from (130) by an overall sign and complex conjugation. The second approximate relation on the right-hand side is written for the case when the transmission amplitudes depend weakly on the wavenumber  $k$  on the scale dictated by temperature or the applied bias, and thus their momentum dependence may be disregarded.

One can set up now the partition function for this transport problem as

$$Z[A] = \frac{1}{\text{Tr}\{\hat{\rho}_0\}} \int \mathbf{D}[\bar{\psi}\psi] \exp \left\{ i \bar{\Psi} [\hat{\mathbf{G}}^{-1} + \hat{A} \hat{M}] \bar{\Psi} \right\}, \quad (131)$$

here  $\bar{\Psi} = (\bar{\psi}^L, \bar{\psi}^R)$ ,  $\hat{\mathbf{G}} = \text{diag}\{\hat{G}_L, \hat{G}_R\}$  is  $4 \times 4$  Green's function matrix, whereas  $\hat{G}_a$  is  $2 \times 2$  matrix in the Keldysh space, and  $\hat{A}$  is auxiliary vector potential, c.f. (116). Since the functional integral over fermionic fields in (131) is quadratic, one finds upon Gaussian integration

$$\ln Z[A] = \text{Tr} \ln [\hat{1} + \hat{\mathbf{G}} \hat{A} \hat{M}]. \quad (132)$$

In analogy with (119) the average current is generated from  $Z[A]$  via its functional differentiation with respect to the quantum component of the vector potential  $\langle I \rangle = -(i/2) \delta \ln Z[A] / \delta A^q(t)|_{A^q=0}$ . By expanding trace of the logarithm to the linear order in  $\hat{A}$ , as  $\text{Tr} \ln [\hat{1} + \hat{\mathbf{G}} \hat{A} \hat{M}] \approx \text{Tr} [\hat{\mathbf{G}} \hat{A} \hat{M}]$ , one finds for the current

$$\langle I \rangle = -\frac{iev_F}{2} \text{Tr} \left\{ \begin{pmatrix} \hat{G}_L \hat{\gamma}^q & 0 \\ 0 & \hat{G}_R \hat{\gamma}^q \end{pmatrix} \begin{pmatrix} |\mathbf{t}_n|^2 & \mathbf{t}_n^* \mathbf{r}_n \\ \mathbf{r}_n^* \mathbf{t}_n & -|\mathbf{t}_n|^2 \end{pmatrix} \right\} = -\frac{iev_F}{2} \sum_{nk} T_n(\epsilon_k) \int \frac{d\epsilon}{2\pi} [G_L^K(\epsilon, k) - G_R^K(\epsilon, k)], \quad (133)$$

<sup>9</sup>Equation (130) is obtained as a result of certain approximations. The exact expression for the current matrix explicitly depends on coordinate  $x$ . There are two types of terms. The first depends on  $x$  as  $\exp(\pm i(k+k')x) \approx \exp(\pm 2ik_F x)$ , where  $k_F$  is Fermi momentum, it represents Friedel oscillations. Their contribution to the current is small as  $(k-k')/k_F \ll 1$ , and thus neglected. The second type of terms contains  $\exp(\pm i(k-k')x) \approx 1$ , since  $|k-k'| \sim L_T^{-1} \ll x^{-1}$ , where  $L_T = v_F/T$  is ballistic thermal length, and the coordinate  $x$  is confined by the sample size  $L \ll L_T$ . See corresponding discussions in [42].

where we used Keldysh trace

$$\text{Tr}\{\hat{G}_a \hat{\gamma}^q\} = G_a^K(t, t, k) = \int \frac{d\epsilon}{2\pi} G_a^K(\epsilon, k),$$

and introduced QPC transmission probability  $T_n(\epsilon_k) = |\mathbf{t}_n(k)|^2$ . The last step is to take Keldysh component of the Green's function  $G_a^K(\epsilon, k) = -2\pi i \delta(\epsilon - \epsilon_k + \mu_a) [1 - 2n_F(\epsilon)]$ , with  $\epsilon_k = v_F k$  [see (107)], and to perform momentum integration which is straightforward owing to the delta function in  $G^K$ . The result is

$$\langle I \rangle = \frac{e}{2\pi} \sum_n \int d\epsilon T_n(\epsilon) [n_L(\epsilon) - n_R(\epsilon)]. \quad (134)$$

For a small temperature and applied voltage (134) gives a conductance  $\langle I \rangle = gV$ , where

$$g = \frac{e^2}{2\pi\hbar} \sum_n T_n, \quad (135)$$

and all transmissions are taken at the Fermi energy  $T_n = T_n(\epsilon_F)$  (note that we restored Planck constant  $\hbar$  in the final expression for the conductance). Equation (135) is known as a multi-channel Landauer formula (see [43, 44] for detailed reviews on this subject).

### 5.5.2 Shot noise

Based on the previous example we can make one step forward and calculate the second moment of the current fluctuations, so-called noise power, defined as the Fourier transform of current correlations

$$S(\omega, V) = \int dt e^{i\omega t} \langle \delta \hat{I}(t) \delta \hat{I}(0) + \delta \hat{I}(0) \delta \hat{I}(t) \rangle, \quad \delta \hat{I}(t) = \hat{I}(t) - \langle I \rangle. \quad (136)$$

Within Keldysh technique this correlator may be deduced from  $Z[A]$  (see (132)). Indeed, one needs now to expand trace of the logarithm in (132) to the second order in auxiliary vector potential  $\hat{A}$  and differentiate  $\ln Z[A] \propto \text{Tr}[\hat{\mathbf{G}} \hat{\mathbf{A}} \hat{\mathbf{M}} \hat{\mathbf{G}} \hat{\mathbf{A}} \hat{\mathbf{M}}]$  twice over the quantum component,  $A^q$ :

$$S(\omega, V) = -\frac{1}{2} \frac{\delta^2 \ln Z[A]}{\delta A^q(\omega) \delta A^q(-\omega)} \Big|_{A^q=0}. \quad (137)$$

This expression automatically gives properly symmetrized noise power (136). As a result of the differentiation one finds

$$\begin{aligned} S(\omega, V) = & \frac{1}{2} \text{Tr} \left\{ \hat{\mathbf{G}}(\epsilon_+) \hat{\gamma}^q \hat{\mathbf{M}} \hat{\mathbf{G}}(\epsilon_-) \hat{\gamma}^q \hat{\mathbf{M}} \right\} = \frac{e^2 v_F^2}{2} \sum_{kk'} \int \frac{d\epsilon}{2\pi} \left[ T_n^2 \text{Tr} \{ \hat{G}_L(\epsilon_+) \hat{\gamma}^q \hat{G}_L(\epsilon_-) \hat{\gamma}^q \} \right. \\ & \left. + T_n R_n \text{Tr} \{ \hat{G}_L(\epsilon_+) \hat{\gamma}^q \hat{G}_R(\epsilon_-) \hat{\gamma}^q \} + T_n R_n \text{Tr} \{ \hat{G}_R(\epsilon_+) \hat{\gamma}^q \hat{G}_L(\epsilon_-) \hat{\gamma}^q \} + T_n^2 \text{Tr} \{ \hat{G}_R(\epsilon_+) \hat{\gamma}^q \hat{G}_R(\epsilon_-) \hat{\gamma}^q \} \right], \quad (138) \end{aligned}$$

where we already calculated partial trace over the left/right subspace, assuming that transmissions are energy independent, and used notations  $\epsilon_{\pm} = \epsilon \pm \omega/2$  and  $R_n = 1 - T_n$ . Calculation of Keldysh traces requires (104) and (113) and gives

$$\text{Tr} \{ \hat{G}_a \hat{\gamma}^q \hat{G}_b \hat{\gamma}^q \} = G_a^K G_b^K + G_a^R G_b^A + G_a^A G_b^R. \quad (139)$$

The remaining step is the momentum integration. One uses  $G_a^{R(A)}(\epsilon, k) = (\epsilon - v_F k + \mu_a \pm i0)^{-1}$  and  $G_a^K(\epsilon, k) = -2\pi i \delta(\epsilon - v_F k + \mu_a) [1 - 2n_F(\epsilon)]$  from (107), and finds that  $\sum_{kk'} \int d\epsilon \text{Tr} \{ \hat{G}_a \hat{\gamma}^q \hat{G}_b \hat{\gamma}^q \} = v_F^{-2} \int d\epsilon [1 - (1 - 2n_a)(1 - 2n_b)]$ . As a result, the final expression for the noise power obtained by Lesovik [45] reads as

$$S(\omega, V) = \frac{e^2}{2\pi\hbar} \sum_n \int d\epsilon \left[ T_n^2 B_{LL}(\epsilon) + T_n R_n B_{LR}(\epsilon) + T_n R_n B_{RL}(\epsilon) + T_n^2 B_{RR}(\epsilon) \right], \quad (140)$$

where statistical factors are  $B_{ab}(\epsilon) = n_a(\epsilon_+)[1 - n_b(\epsilon_-)] + n_b(\epsilon_-)[1 - n_a(\epsilon_+)]$  and we again restored  $\hbar$  in the end. Despite its complicated appearance,  $\epsilon$  integration in (140) can be performed in the closed form<sup>10</sup>

$$\mathcal{S}(\omega, V) = \frac{e^2}{2\pi\hbar} \sum_n \left[ T_n^2 \omega \coth\left(\frac{\omega}{2T}\right) + T_n(1 - T_n)(eV + \omega) \coth\left(\frac{eV + \omega}{2T}\right) + \{\omega \rightarrow -\omega\} \right]. \quad (141)$$

There are two limiting cases of interest, which can be easily extracted from (141). The first one corresponds to the thermally equilibrium current fluctuations,  $V \rightarrow 0$ . In this case

$$\mathcal{S}(\omega, 0) = 2g\omega \coth\left(\frac{\omega}{2T}\right), \quad (142)$$

where we used (135) for conductance  $g$ . This result is nothing but familiar fluctuation–dissipation relation for the current fluctuations. Note, that despite the complicated dependence on transmission amplitudes in (140) the equilibrium noise power (142) is written in terms of conductance (135) only. The other limiting case is fully non–equilibrium noise at zero temperature  $T \rightarrow 0$  and a finite bias  $V$ . For such a case one finds from (141) for the excess part of the noise

$$\mathcal{S}(\omega, V) - \mathcal{S}(\omega, 0) = \frac{e^2}{2\pi\hbar} (|eV + \omega| + |eV - \omega| - 2|\omega|) \sum_n T_n(1 - T_n), \quad (143)$$

which is called the *shot* noise. An important observation here is that in contrast to equilibrium noise (142), shot noise can not be written solely in terms of the conductance  $g$ . Only for the case of tunnel junction, where all transmissions are small,  $T_n \ll 1$ , Equation (143) reduces to  $\mathcal{S}(0, V) = 2eVg = 2e\langle I \rangle$ , which is known as Schottky formula (for a review of shot noise in various systems see e.g. [46, 47, 48]).

### 5.5.3 Coulomb drag

Drag effect proposed by Pogrebinskii [49] and Price [50] by now is one of the standard ways to access and measure electron–electron scattering. In bulk two–dimensional systems (two parallel two–dimensional electron gases, separated by an insulator) the drag effect is well established experimentally [51, 52, 53, 54, 55] and studied theoretically [56, 57, 58, 59]. Recently a number of experiments were performed to study Coulomb drag in quantum confined geometries such as quantum wires [60, 61, 62, 63], quantum dots [64, 65] or QPCs [66]. In these systems a source–drain voltage  $V$  is applied to generate current in the *drive circuit* while an induced current (or voltage) is measured in the *drag circuit*. Such a drag current is a function of the drive voltage  $V$  as well as gate voltages,  $V_g$ , which control transmission of one or both circuits. Figure 9a shows an example of such a setup, where both drive and drag circuits are represented by two QPCs.

The Keldysh technique is an efficient way to tackle the drag problem both in linear response regime and away from the equilibrium, when a relatively large bias is applied to the drive circuit. Within each QPC electrons are assumed to be non–interacting and their motion is separated into quantized–transversal, and extended–longitudinal, see Section 5.5.1. The action describing non–interacting point contacts is

$$iS_{\text{QPC}} = i \text{Tr} \{ \vec{\Psi} \hat{\mathbf{G}}^{-1} \vec{\Psi} \}, \quad (144)$$

where  $\vec{\Psi} = (\bar{\psi}_{jn}^L, \bar{\psi}_{jn}^R)$  and  $\hat{\mathbf{G}} = \delta_{jj'} \text{diag} \{ \hat{G}_L, \hat{G}_R \}$ . Index  $j = 1, 2$  labels QPC<sub>1(2)</sub> respectively,  $n$  is the transverse channel index within each QPC, and  $\hat{G}_{L(R)}$  is a  $2 \times 2$  Keldysh matrix (104).

The interaction term between the two QPC is

$$iS_{\text{int}} = \sum_{\alpha\beta\gamma} \iint_{-\infty}^{+\infty} dt dt' I_{1\alpha}^\alpha(t) \mathbf{K}_{\alpha\beta}^{\alpha\beta}(t - t') I_{2\beta}^\beta(t'), \quad (145)$$

<sup>10</sup>Deriving (141) one writes statistical factors as  $B_{ab}(\epsilon) = \frac{1}{2} [1 - \tanh[(\epsilon_+ - \mu_a)/2T] \tanh[(\epsilon_- - \mu_b)/2T]]$  and uses the integral  $\int_{-\infty}^{+\infty} dx [1 - \tanh(x + y) \tanh(x - y)] = 4y \coth(2y)$ .

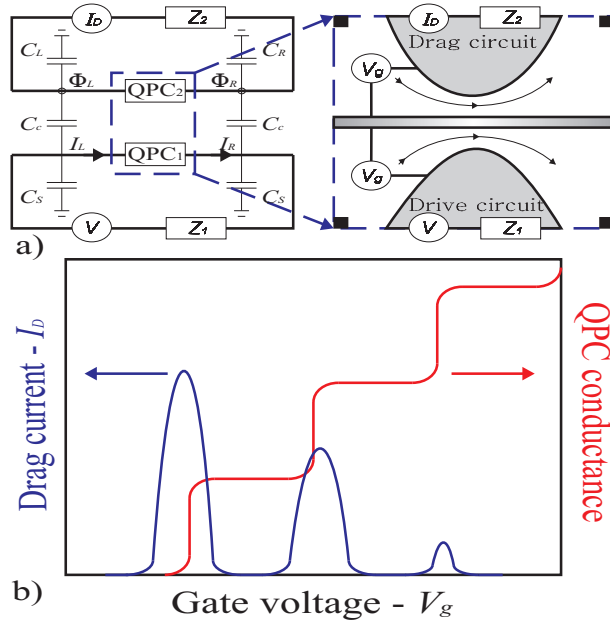

Figure 9: a) Two coupled QPCs and surrounding electric circuitry. The Coulomb coupling is due to mutual capacitances  $C_c$ . Gate voltage  $V_g$  control transmission of, e.g., drive QPC. b) Schematic representation of conductance of the drive QPC along with the drag current as a function of the gate voltage.

where  $I_{jR(L)}(t)$  are current operators, on the right (left) of QPC $_j$ , coupled by the kernel  $\hat{\mathbf{K}}_{ab}(t-t')$ , which encodes electromagnetic environment of the circuit. The retarded and advanced components of the interaction kernel are related to the trans-impedance matrix  $\mathbf{K}_{ab}^{R(A)}(\omega) = \mathbf{Z}_{ab}^{R(A)}(\omega)/(\omega \pm i0)$ . The latter is defined as  $\mathbf{Z}_{ab}^{R(A)}(\omega) = \partial\Phi_a(\pm\omega)/\partial I_b(\mp\omega)$ , where the corresponding local fluctuating currents  $I_a$  and voltages  $\Phi_a$  are indicated in Figure 9a. The Keldysh component of the interaction kernel is dictated by the fluctuation-dissipation theorem:  $\mathbf{K}_{ab}^K(\omega) = [\mathbf{K}_{ab}^R(\omega) - \mathbf{K}_{ab}^A(\omega)] \coth(\omega/2T)$ , i.e. we assume that the surrounding electric environment is close to equilibrium. Finally the current operators are given by (128) and (130).

The drag current is found by averaging  $I_2$  over the fermionic degrees of freedom

$$I_D = \int \mathbf{D}[\psi\bar{\psi}] \text{Tr}[\bar{\psi}_2 M \psi_2] \exp(iS_{\text{QPC}}[\bar{\psi}\psi] + iS_{\text{int}}[\bar{\psi}\psi]). \quad (146)$$

Expanding the exponent to the second order in the interaction term  $S_{\text{int}}$ , one obtains

$$I_D = \frac{1}{2} \int \mathbf{D}[\psi\bar{\psi}] \text{Tr}[\bar{\psi}_2 M \psi_2] \text{Tr}[I_1 \mathbf{K} I_2] \text{Tr}[I_1 \mathbf{K} I_2] \exp(iS_{\text{QPC}}[\bar{\psi}\psi]). \quad (147)$$

The remaining Gaussian integral over the fermionic fields is calculated using the Wick's theorem. One employs expression (128) for the current operators with the  $M$ -matrix given by (130) and takes into the account all possible Wick's contractions between the  $\psi$ -fields. The latter are given by the Green's functions (104). This way one finds for the drag current

$$I_D(V) = \int \frac{d\omega}{4\pi\omega^2} \text{Tr}[\hat{\mathbf{Z}}(\omega) \hat{\mathcal{S}}_1(\omega, V) \hat{\mathbf{Z}}(-\omega) \hat{\Gamma}_2(\omega)]. \quad (148)$$

The drive circuit is characterized by the *excess* part  $\mathcal{S}_1^{ab}(\omega, V) = \mathcal{S}_{ab}(\omega, V) - \mathcal{S}_{ab}(\omega, 0)$  of the current-

current correlation matrix  $\mathcal{S}_{ab}(\omega, V) = \int dt e^{i\omega t} \langle \langle \delta \hat{I}_a(t) \delta \hat{I}_b(0) + \delta \hat{I}_b(0) \delta \hat{I}_a(t) \rangle \rangle$ , given by, e.g.,

$$\begin{aligned} \mathcal{S}_{RR}(\omega, V) = & \frac{2}{R_Q} \sum_n \int d\epsilon [B_{LL}(\epsilon) |\mathbf{t}_n^L(\epsilon_+)|^2 |\mathbf{t}_n^L(\epsilon_-)|^2 + B_{LR}(\epsilon) |\mathbf{t}_n^L(\epsilon_+)|^2 |\mathbf{r}_n^R(\epsilon_-)|^2 \\ & + B_{RL}(\epsilon) |\mathbf{r}_n^R(\epsilon_+)|^2 |\mathbf{t}_n^L(\epsilon_-)|^2 + B_{RR}(\epsilon) [1 - \mathbf{r}_n^{*R}(\epsilon_+) \mathbf{r}_n^R(\epsilon_-)] [1 - \mathbf{r}_n^R(\epsilon_+) \mathbf{r}_n^{*R}(\epsilon_-)]], \end{aligned} \quad (149)$$

where  $\epsilon_{\pm} = \epsilon \pm \omega/2$ ,  $\mathbf{t}_n^{L(R)}(\epsilon_{\pm}) = \mathbf{t}_n^{L(R)}(\epsilon_{\pm} + eV_{L(R)})$  and  $\mathbf{r}_n^{L(R)}(\epsilon_{\pm}) = \mathbf{r}_n^{L(R)}(\epsilon_{\pm} + eV_{L(R)})$ , while  $R_Q = 2\pi\hbar/e^2$  is quantum resistance, and statistical occupation form-factors  $B_{ab}(\epsilon)$  are given by (140). Here  $\mathcal{S}_{RR}(\omega, V)$  generalizes (140) to the case of energy dependent transmissions [42]. Expressions for other components of the noise matrix  $\mathcal{S}_{LL}$ ,  $\mathcal{S}_{LR}$ , and  $\mathcal{S}_{RL}$  are similar, see Refs. [42, 68].

The drag circuit in (148) is characterized by the rectification coefficient  $\hat{\Gamma}_2(\omega) = \Gamma_2(\omega) \hat{\zeta}_z$  of ac voltage fluctuations applied to the (near-equilibrium) drag QPC<sub>2</sub>, where  $\hat{\zeta}_z$  is the third Pauli matrix acting in the left–right subspace. Rectification is given by<sup>11</sup>

$$\Gamma_2(\omega) = \frac{2e}{R_Q} \sum_n \int d\epsilon [n_F(\epsilon_-) - n_F(\epsilon_+)] [|\mathbf{t}_n(\epsilon_+)|^2 - |\mathbf{t}_n(\epsilon_-)|^2]. \quad (150)$$

Characteristics of the QPC<sub>2</sub> enter through its energy–dependent transmission probabilities  $|\mathbf{t}_n(\epsilon)|^2$ . This expression admits a transparent interpretation: potential fluctuations with frequency  $\omega$ , say on the left of the QPC, create electron–hole pairs with energies  $\epsilon_{\pm}$  on the branch of right moving particles. Consequently the electrons can pass through the QPC with the probability  $|\mathbf{t}_n(\epsilon_+)|^2$ , while the holes with the probability  $|\mathbf{t}_n(\epsilon_-)|^2$ . The difference between the two gives the dc current flowing across the QPC. Note that the energy dependence of the transmission probabilities in the drag QPC is crucial in order to have the asymmetry between electrons and holes, and thus non–zero rectification  $\Gamma_2(\omega)$ . At the diagrammatic level (148) has transparent representation shown in Figure 10.

Focusing on a single partially open channel in a smooth QPC, one may think of the potential barrier across it as being practically parabolic. In such a case its transmission probability is given by

$$|\mathbf{t}(\epsilon)|^2 = \left( \exp((eV_g - \epsilon)/\Delta_j) + 1 \right)^{-1}, \quad (151)$$

where  $\Delta_j$  is an energy scale associated with the curvature of the parabolic barrier in QPC<sub>j</sub> and gate voltage  $V_g$  shifts the top of the barrier relative to the Fermi energy. This form of transmission was used to explain QPC conductance quantization [69] and it turns out to be useful in application to the Coulomb drag problem. Inserting (151) into Eq. (150) and carrying out the energy integration, one finds

$$\Gamma_2(\omega) = \frac{2e\Delta_2}{R_Q} \ln \left( 1 + \frac{\sinh^2(\omega/2\Delta_2)}{\cosh^2(eV_g/2\Delta_2)} \right) \quad (152)$$

for  $T \ll \Delta_2$ . In the other limit,  $T \gg \Delta_2$ , one should replace  $\Delta_2 \rightarrow T$  in (152). Note that for small frequency  $\omega \ll \Delta_2$  one has  $\Gamma_2 \sim \omega^2$ , thus making the integral in (148) convergent in  $\omega \rightarrow 0$  region.

**Linear drag regime.** For small applied voltages  $V$  one expects the response current  $I_D$  to be linear in  $V$ . Expanding  $\hat{\mathcal{S}}_1(\omega, V)$  to the linear order in  $V$ , one finds that only diagonal components of the current–current correlation matrix contribute to the linear response and as a result,

$$\hat{\mathcal{S}}_1(\omega, V) = V \frac{\partial}{\partial \omega} \left[ \coth \frac{\omega}{2T} \right] \Gamma_1(\omega) \hat{\zeta}_z + O(V^3), \quad (153)$$

<sup>11</sup>In terms of the Keldysh matrices the rectification coefficient is given by the following trace  $\Gamma_2(\omega) = \text{Tr}[\hat{G} \hat{\gamma}^q \hat{M} \hat{G} \hat{\gamma}^{cl} \hat{M} \hat{G} \hat{\gamma}^{cl} \hat{M}]$ . Finding  $\Gamma_2(\omega)$  in the form of (150) one uses Keldysh trace  $\text{Tr}[\hat{G} \hat{\gamma}^q \hat{G} \hat{\gamma}^{cl} \hat{G} \hat{\gamma}^{cl}] = \sum_{\pm} [G^R(\epsilon) G^R(\epsilon \pm \omega) G^K(\epsilon) + G^R(\epsilon) G^K(\epsilon \pm \omega) G^A(\epsilon) + G^K(\epsilon) G^A(\epsilon \pm \omega) G^A(\epsilon)]$ . To simplify this expression further one should decompose each Keldysh component of the Green's function using fluctuation–dissipation relation  $G^K(\epsilon) = [G^R(\epsilon) - G^A(\epsilon)] [1 - 2n(\epsilon)]$  and keep in the resulting expression only those terms, which have a proper causality, i.e. combinations having three Green's functions of the same kind, like  $G^A G^A G^A$  and  $G^R G^R G^R$ , do not contribute. In this way, one finds for the Keldysh trace  $\text{Tr}[\hat{G} \hat{\gamma}^q \hat{G} \hat{\gamma}^{cl} \hat{G} \hat{\gamma}^{cl}] \propto [n_F(\epsilon_-) - n_F(\epsilon_+)]$ . Remaining trace in the left–right subspace over the current vertex matrices  $\hat{M}$  reduces to the transmission probabilities at shifted energies, namely  $\text{Tr}[\hat{M} \hat{M} \hat{M}] \propto |\mathbf{t}_n(\epsilon_+)|^2 - |\mathbf{t}_n(\epsilon_-)|^2$ , leading to (150).

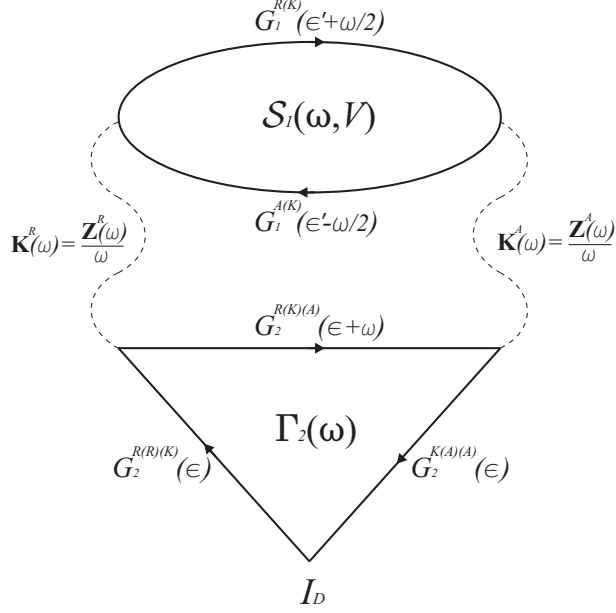

Figure 10: Drag current  $I_D$  in the second order in inter-circuit interactions  $\mathbf{K} = \mathbf{Z}/\omega$  (wavy lines). The drag circuit is represented by triangular rectification vertex  $\Gamma_2(\omega)$ , while the drive circuit by the non-equilibrium current-current correlator  $S_1(\omega, V)$  (loop).

where  $\Gamma_1(\omega)$  is obtained from (150) by substituting transmission probabilities of QPC<sub>2</sub>, by that of QPC<sub>1</sub>. Inserting (153) into (148) one finds

$$I_D = V \frac{R_Q^2}{4\pi} \int d\omega \frac{\alpha_+(\omega)}{\omega^2} \frac{\partial}{\partial \omega} \left[ \coth \frac{\omega}{2T} \right] \Gamma_1(\omega) \Gamma_2(\omega), \quad (154)$$

where dimensionless interaction kernel  $\alpha_+(\omega)$  is expressed through the trans-impedance matrix as

$$\alpha_+(\omega) = \frac{1}{2R_Q^2} \text{Tr}[\hat{\mathbf{Z}}(\omega) \hat{\zeta}_z \hat{\mathbf{Z}}(\omega) \hat{\zeta}_z].$$

Equation (154) has the same general structure as the one for the drag current in bulk two-dimensional systems [58, 59]. Being symmetric with respect  $1 \leftrightarrow 2$  permutation, it satisfies Onsager relation for the linear response coefficient. Performing remaining frequency integration in (154), it is sufficient to take the interaction kernel at zero frequency. Indeed, frequency scale at which  $\alpha_+(\omega)$  changes is set by inverse  $RC$ -time of the circuit. If load impedance of the drag circuit is large compared to that of the drive circuit  $Z_1 \ll Z_2 \ll R_Q$ , which is the case for most experiments, and the mutual capacitance of the two circuits is small  $C_c \ll C_{R,L,S}$ , see Figure 9a, one finds  $\tau_{RC}^{-1} = (Z_1 C_s)^{-1} \gg T$ . Since  $I_D$  in (154) is determined by  $\omega \lesssim T$ , it is justified to approximate<sup>12</sup>  $\alpha_+(\omega) \approx \alpha_+(0)$ . Substituting (152) into (154), one finds for, e.g., low-temperature regime  $T \ll \Delta_{1,2}$

$$I_D = \frac{V}{R_Q} \frac{\alpha_+(0) \pi^2}{6} \frac{T^2}{\Delta_1 \Delta_2} \frac{1}{\cosh^2(eV_g/2\Delta_1)}, \quad (155)$$

<sup>12</sup>For the circuit shown in the Figure 9 one finds for the low-frequency limit of the trans-impedance kernel

$$\alpha_{\pm}(0) = \frac{Z_1^2}{8R_Q^2} \frac{C_c^2}{C_L^2 C_R^2} \begin{cases} 2C_L^2 + 2C_L C_R + 2C_R^2 \\ C_L^2 - C_R^2 \end{cases}$$

where we assumed that the gate voltage of QPC<sub>2</sub> is tuned to adjust the top of its barrier with the Fermi energy and wrote  $I_D$  as a function of the gate voltage in QPC<sub>1</sub>. The resulting expression exhibits a peak at  $V_g = 0$  similar to that depicted in Fig. 9b. This expression describes rectification of near-equilibrium thermal fluctuations (hence the factor  $T^2$ ), which is due to the electron-hole asymmetry (hence, non-monotonous dependence on  $V_g$ ).

**Nonlinear regime.** At larger drive voltages drag current ceases to be linear in  $V$ . Furthermore, contrary to the linear response case,  $\hat{\mathcal{S}}_1(\omega, V)$  does not require energy dependence of the transmission probabilities and could be evaluated for energy independent  $|t_n|^2$  (this is a fair assumption for  $T, eV \ll \Delta_1$ ). Assuming in addition  $T \ll eV$ , one finds  $\hat{\mathcal{S}}_1^{ab}(\omega, V) = [\mathcal{S}_{ab}(\omega, V) - \mathcal{S}_{ab}(\omega, 0)]\hat{\zeta}_0$ , where  $\mathcal{S}_1(\omega, V)$  is given by (143) (recall that  $T_n \equiv |t_n|^2$ ). Inserting it into (148), after the frequency integration bounded by the voltage, one finds for the drag current

$$I_D = \frac{eV^2}{\Delta_2 R_Q} \alpha_-(0) \sum_n T_n (1 - T_n). \quad (156)$$

Here again we assumed that the detector QPC<sub>2</sub> is tuned to the transition between the plateaus. We also assumed  $eV \ll (Z_1 C_s)^{-1}$  to substitute

$$\alpha_-(\omega) = \frac{1}{2R_Q^2} \text{Tr}[\hat{\mathbf{Z}}(\omega)\hat{\zeta}_0\hat{\mathbf{Z}}(\omega)\hat{\zeta}_z]$$

by its dc value,  $\alpha_-(0)$ . One should notice that while  $\alpha_+ > 0$ , the sign of  $\alpha_-$  is arbitrary, since  $\alpha_- \propto C_L^2 - C_R^2$ , see Figure 9a and Note 12. For a completely symmetric circuit  $\alpha_- = 0$ , while for extremely asymmetric one  $|\alpha_-| \approx \alpha_+/2$ . Although we presented derivation of (156) for  $T \ll eV$ , one may show that it remains valid at any temperature as long as  $T \ll \min\{\Delta_1, (Z_1 C_s)^{-1}\}$ .

Equation (156) shows that the drag current is the result of the rectification of the quantum shot noise and is hence proportional to the Fano factor [45] of the drive circuit. It exhibits the generic behavior depicted in Figure 9b, but the reason is rather different from the similar behavior in the linear regime. The direction of the non-linear drag current is determined by the inversion asymmetry of the circuit (through the sign of  $\alpha_-$ ) rather than the direction of the drive current. As a result, for a certain polarity of the drive voltage, the drag current appears to be *negative*. Finally, assuming that for a generic circuit  $\alpha_+ \sim \alpha_-$  and comparing (155) and (156) one concludes that the transition from the linear to the non-linear regime takes place at  $V \approx V^*$  with  $eV^* = T^2/\Delta_1 \ll T$ , for  $T \ll \Delta_1$ . In the opposite limit,  $T > \Delta_1$ , the crossover voltage is given by the temperature  $eV^* = T$ . Further details and discussions can be found in [68].

## 6 Disordered fermionic systems

One is often interested in calculating, say, density-density or current-current response functions, in the presence of static (quenched) space-dependent disorder potential  $U_{\text{dis}}(\mathbf{r})$ . Moreover, one wants to know their averages taken over an ensemble of realizations of  $U_{\text{dis}}(\mathbf{r})$ , since the exact form of the disorder potential is, in general, not known. The response function in the Keldysh formulation, may be defined as variation of the generating function and *not the logarithm* of the generating function. More precisely, the two definitions with, and without the logarithm coincide owing to the fundamental normalization  $Z = 1$ . This is not the case in the equilibrium formalism, where the presence of the logarithm (leading to the factor  $Z^{-1}$  after differentiation) is unavoidable in order to have the correct normalization. Such a disorder-dependent factor  $Z^{-1} = Z^{-1}[U_{\text{dis}}]$  formidably complicates the averaging over  $U_{\text{dis}}$ . Two techniques were invented to perform the averaging: the replica trick [25, 26, 27, 28, 29] and the supersymmetry [31, 32]. The first one utilizes the observation that  $\ln Z = \lim_{n \rightarrow 0} (Z^n - 1)/n$ , to perform calculations for an integer number,  $n$ , of replicas of the same system and take  $n \rightarrow 0$  in the end of the calculations. The second one is based on the fact that  $Z^{-1}$  of the non-interacting fermionic system equals to  $Z$  of a bosonic system in the same random



potential. One thus introduces an additional bosonic replica of the fermionic system at hand. The Keldysh formalism provides an alternative to these two methods ensuring that  $Z = 1$  by construction [21, 22, 23]. The purpose of this section is to show how the effective field theory of disordered electron gas, known as the non-linear  $\sigma$ -model (NLSM), is constructed within Keldysh formalism.

## 6.1 Disorder averaging

We add the disorder dependent term to the fermionic action  $S_{\text{dis}}[\bar{\psi}, \psi] = \int_C dt \int d\mathbf{r} U_{\text{dis}}(\mathbf{r}) \bar{\psi}(\mathbf{r}, t) \psi(\mathbf{r}, t)$ , where  $U_{\text{dis}}(\mathbf{r})$  is a static scalar potential, created by a random configuration of impurities. It is usually reasonable to assume that impurities are short-ranged and distributed uniformly over the system, thus having the correlation function of the form  $\langle U_{\text{dis}}(\mathbf{r}) U_{\text{dis}}(\mathbf{r}') \rangle \sim \delta(\mathbf{r} - \mathbf{r}')$ . Assuming, in addition, Gaussian distribution of the impurity potential, one ends up with the disorder averaging performed with the help of the following functional integral:

$$\langle \dots \rangle_{\text{dis}} = \int \mathbf{D}[U_{\text{dis}}] \dots \exp \left\{ -\pi\nu\tau_{\text{el}} \int d\mathbf{r} U_{\text{dis}}^2(\mathbf{r}) \right\}, \quad (157)$$

where the disorder strength is characterized by the elastic mean free time  $\tau_{\text{el}}$ , and  $\nu$  is the electronic density of states at the Fermi energy. Since the disorder potential possesses only the classical component, it is exactly the same on both branches of the Keldysh contour. Thus, it is coupled only to  $\hat{\gamma}^{cl} = \hat{1}$  vertex matrix. Next, we perform the Gaussian integration over  $U_{\text{dis}}$  of the disorder-dependent term of the partition function (at this step we crucially use the absence of the normalization factor) and find

$$\begin{aligned} & \int \mathbf{D}[U_{\text{dis}}] \exp \left( - \int d\mathbf{r} \left[ \pi\nu\tau_{\text{el}} U_{\text{dis}}^2(\mathbf{r}) - iU_{\text{dis}}(\mathbf{r}) \int_{-\infty}^{+\infty} dt \bar{\psi}^a(\mathbf{r}, t) \hat{\gamma}_{ab}^{cl} \psi^b(\mathbf{r}, t) \right] \right) \\ &= \exp \left( - \frac{1}{4\pi\nu\tau_{\text{el}}} \int d\mathbf{r} \iint_{-\infty}^{+\infty} dt dt' [\bar{\psi}^a(\mathbf{r}, t) \psi^a(\mathbf{r}, t)] [\bar{\psi}^b(\mathbf{r}, t') \psi^b(\mathbf{r}, t')] \right), \end{aligned} \quad (158)$$

where  $a, b = 1, 2$ , and summations over all repeated indices are assumed. One can rearrange  $[\bar{\psi}^a(\mathbf{r}, t) \psi^a(\mathbf{r}, t)] [\bar{\psi}^b(\mathbf{r}, t') \psi^b(\mathbf{r}, t')] = -[\bar{\psi}^a(\mathbf{r}, t) \psi^b(\mathbf{r}, t')] [\bar{\psi}^b(\mathbf{r}, t') \psi^a(\mathbf{r}, t)]$  in the exponent on the right-hand side of the last equation (the minus sign originates from anti-commuting property of the Grassmann numbers) and then use Hubbard-Stratonovich matrix-valued field,  $\hat{Q} = Q_{tt'}^{ab}(\mathbf{r})$  to decouple (time non-local) four-fermion term as<sup>13</sup>

$$\begin{aligned} & \exp \left( \frac{1}{4\pi\nu\tau_{\text{el}}} \int d\mathbf{r} \iint_{-\infty}^{+\infty} dt dt' [\bar{\psi}^a(\mathbf{r}, t) \psi^b(\mathbf{r}, t')] [\bar{\psi}^b(\mathbf{r}, t') \psi^a(\mathbf{r}, t)] \right) \\ &= \int \mathbf{D}[\hat{Q}] \exp \left( - \frac{\pi\nu}{4\tau_{\text{el}}} \text{Tr}\{\hat{Q}^2\} - \frac{1}{2\tau_{\text{el}}} \int d\mathbf{r} \iint_{-\infty}^{+\infty} dt dt' Q_{tt'}^{ab}(\mathbf{r}) \bar{\psi}^b(\mathbf{r}, t') \psi^a(\mathbf{r}, t) \right). \end{aligned} \quad (159)$$

Here we have introduced that the trace of the  $\hat{Q}^2$  implies summation over the matrix indices as well as time and spatial integrations

$$\text{Tr}\{\hat{Q}^2\} = \int d\mathbf{r} \iint_{-\infty}^{+\infty} dt dt' \sum_{a,b=1}^2 Q_{tt'}^{ab}(\mathbf{r}) Q_{t't}^{ba}(\mathbf{r}). \quad (160)$$

Now the *averaged* action is quadratic in the Grassmann variables  $S[\Psi, \hat{Q}] = \text{Tr}\{\bar{\Psi}[\hat{G}^{-1} + \frac{i}{2\tau_{\text{el}}}\hat{Q}]\Psi\}$ , and they may be integrated out explicitly, leading to the determinant of the corresponding quadratic

<sup>13</sup>Since we do not keep track of the time-reversal symmetry, i.e. the fact that the Hamiltonian is a real operator, the following considerations are restricted to the case, where the time-reversal invariance is broken by, e.g., an external magnetic field (complex Hermitian Hamiltonian). This is the so-called *unitary* NLSM. The *orthogonal* NLSM, i.e. the one where the time-reversal symmetry is restored is considered in Section 8, devoted to disordered superconductors.

form:  $\hat{G}^{-1} + \frac{i}{2\tau_{\text{el}}}\hat{Q}$ . All of the matrices here should be understood as having  $2 \times 2$  Keldysh structure along with the  $N \times N$  structure in the discrete time. One thus finds for the disorder averaged generating function  $\mathcal{Z} = \langle Z \rangle_{\text{dis}}$ :

$$\mathcal{Z} = \int \mathbf{D}[\hat{Q}] \exp(iS[\hat{Q}]),$$

$$iS[\hat{Q}] = -\frac{\pi\nu}{4\tau_{\text{el}}}\text{Tr}\{\hat{Q}^2\} + \text{Tr} \ln \left[ \hat{G}^{-1} + \frac{i}{2\tau_{\text{el}}}\hat{Q} \right]. \quad (161)$$

As a result, one has traded the initial functional integral over the static field  $U_{\text{dis}}(\mathbf{r})$  for the functional integral over the dynamic matrix field  $\hat{Q}_{t't'}(\mathbf{r})$ . At a first glance, it does not strike as a terribly bright idea. Nevertheless, there is a great simplification hidden in this procedure. The point is that the disorder potential, being  $\delta$ -correlated, is a rapidly oscillating function. On the other hand, as shown below, the  $\hat{Q}$  matrix field is a slow (both in space and time) function. Thus, it represents true macroscopic (or hydrodynamic) degrees of freedom of the system, which are diffusively propagating modes.

## 6.2 Non-linear $\sigma$ -model

To proceed we look for stationary configurations of the action  $S[\hat{Q}]$  in (161). Taking the variation over  $\hat{Q}_{t't'}(\mathbf{r})$ , one obtains the saddle point equation

$$\hat{Q}_{t't'}(\mathbf{r}) = \frac{i}{\pi\nu} \left( \hat{G}^{-1} + \frac{i}{2\tau_{\text{el}}}\hat{Q} \right)_{t't',\mathbf{r}\mathbf{r}}^{-1}, \quad (162)$$

where  $\hat{Q}_{t't'}(\mathbf{r})$  denotes a stationary configuration of the fluctuating field  $\hat{Q}_{t't'}(\mathbf{r})$ . The strategy is to find first a spatially uniform and time-translationally invariant solution  $\hat{Q}_{t-t'}$  of (162) and then consider space- and time-dependent deviations from such a solution. This strategy is adopted from the theory of magnetic systems, where one first finds a uniform static magnetized configurations and then treats spin-waves as smooth perturbations on top of such a static uniform solution. From the structure of (162) one expects that the stationary configuration  $\hat{Q}$  possesses the same form as the fermionic self-energy (106) (more accurately, one expects that among possible stationary configurations there is a *classical* configuration that admits the causality structure (106)). One looks, therefore, for a solution of (162) in the form of the matrix

$$\hat{Q}_{t-t'} = \hat{\Lambda}_{t-t'} = \begin{pmatrix} \Lambda_{t-t'}^R & \Lambda_{t-t'}^K \\ 0 & \Lambda_{t-t'}^A \end{pmatrix}. \quad (163)$$

Substituting this expression into (162), which in the energy/momentum representation reads as  $\hat{\Lambda}_\epsilon = \frac{i}{\pi\nu} \sum_p (\epsilon - \epsilon_p + \frac{i}{2\tau_{\text{el}}}\hat{\Lambda}_\epsilon)^{-1}$ , with  $\epsilon_p \equiv p^2/2m - \epsilon_F$ , one finds

$$\Lambda_\epsilon^{R(A)} = \frac{i}{\pi\nu} \sum_p \frac{1}{\epsilon - \epsilon_p + \frac{i}{2\tau_{\text{el}}}\Lambda_\epsilon^{R(A)}} = \pm 1, \quad (164)$$

where one adopts the convention  $\sum_p \dots \rightarrow \nu \int d\epsilon_p$ . The signs on the right-hand side are chosen so as to respect causality: the retarded (advanced) Green's function is analytic in the entire upper (lower) half-plane of complex energy  $\epsilon$ . One has also assumed that  $1/\tau_{\text{el}} \ll \epsilon_F$  to extend the energy integration to minus infinity, while using constant density of states  $\nu$ . The Keldysh component, as always, may be parameterized through a Hermitian distribution function:  $\Lambda^K = \Lambda^R \circ F - F \circ \Lambda^A$ , where the distribution function  $F$  is not fixed by the saddle point equation (162) and must be determined through the boundary conditions. In equilibrium, however,  $F$  is nothing but the thermal fermionic

distribution function  $F_\epsilon^{eq} = \tanh \frac{\epsilon}{2T}$ , thus  $\Lambda_\epsilon^K = (\Lambda_\epsilon^R - \Lambda_\epsilon^A)F_\epsilon^{eq} = 2F_\epsilon^{eq}$ . Finally we have for the stationary  $\hat{Q}$  matrix configuration

$$\hat{\Lambda}_\epsilon = \begin{pmatrix} 1_\epsilon^R & 2F_\epsilon \\ 0 & -1_\epsilon^A \end{pmatrix}, \quad (165)$$

where we have introduced the retarded and advanced unit matrices to remind about causality structure and the superscript "eq" in the distribution  $F$  was suppressed for brevity. Transforming back to the time representation, one finds  $\Lambda_{t-t'}^{R(A)} = \pm\delta(t-t' \mp 0)$ , where  $\mp 0$  indicates that  $\delta$ -function is shifted below (above) the main diagonal,  $t = t'$ . As a result,  $\text{Tr}\{\hat{\Lambda}\} = 0$  and  $S[\hat{\Lambda}] = 0$ , as it should be, of course, for any purely classical field configuration (163). One should note, however, that this particular form of the saddle point solution (165) is a result of the approximation that the single-particle density of states  $\nu$  is independent of energy. In general, it does depend on  $\epsilon$  and thus retarded (advanced) components of  $\hat{\Lambda}_\epsilon$  are analytic functions of energy in the upper (lower) half-plane, which do depend on energy on the scale of order of the Fermi energy  $\epsilon_F$ . Therefore, the infinitesimally shifted  $\delta$ -functions in  $\Lambda_{t-t'}^{R(A)} = \pm\delta(t-t' \mp 0)$  should be understood as  $\delta_{t\mp 0} = f_\pm(t)\theta(\pm t)$ , where  $\theta(\pm t)$  is the Heaviside step function, and  $f_\pm(t)$  are functions that are highly peaked for  $|t| \lesssim \epsilon_F^{-1}$  and satisfy the normalization  $\int_0^{\pm\infty} dt f_\pm(t) = \pm 1$ . This high-energy regularization is important to remember in calculations to avoid spurious unphysical constants. In particular, for this reasons  $1_{t-t'}^R M_{t',t}^R = 0$ , and  $1_{t-t'}^A M_{t',t}^A = 0$ , where  $M_{t',t}^{R(A)}$  is an arbitrary retarded (advanced) matrix in the time space.

Now we are on a position to examine the fluctuations around the saddle point (165). The fluctuations of  $\hat{Q}$  fall into two general classes: (i) massive, with the mass  $\propto \nu/\tau_{el}$  and (ii) massless, i.e. such that the action depends only on gradients or time derivatives of these degrees of freedom. The fluctuations along the massive modes can be integrated out in the Gaussian approximation and lead to insignificant renormalization of the parameters in the action. The massless, or Goldstone, modes describe diffusive motion of the electrons. The fluctuations of  $\hat{Q}$  matrix along these massless modes are not small and should be parameterized by the matrices satisfying a certain non-linear constraint. To identify the relevant Goldstone modes consider the first term in the action  $S[\hat{Q}]$  of (161). The stationary configuration given by (165) satisfies

$$\hat{Q}^2 = \begin{pmatrix} 1_\epsilon^R & 0 \\ 0 & 1_\epsilon^A \end{pmatrix} = \hat{1}. \quad (166)$$

Note that  $\text{Tr}\{\hat{Q}^2\} = \text{Tr}\{\hat{1}^R\} + \text{Tr}\{\hat{1}^A\} = 0$ , owing to the definition of the retarded/advanced unit matrices. The fluctuations of  $\hat{Q}$  which do not satisfy (166) are massive. The class of  $\hat{Q}$  matrix configurations, that obeys the constraint (166), is generated by rotations of the stationary matrix  $\hat{\Lambda}_\epsilon$  and may be parameterized as follows

$$\hat{Q} = \hat{\mathcal{R}}^{-1} \circ \hat{\Lambda} \circ \hat{\mathcal{R}}. \quad (167)$$

The specific form of  $\hat{\mathcal{R}}$  is not important at the moment and will be chosen later. The massless modes, or spin waves, if one adopts magnetic analogy, which are associated with  $\hat{\mathcal{R}}_{t'}(\mathbf{r})$  are slow functions of  $t + t'$  and  $\mathbf{r}$  and their gradients are small. Our goal now is to derive an action for soft-mode  $\hat{Q}$  field configurations given by (166) and (167).

To this end, one substitutes (167) into (161) and cyclically permutes  $\hat{\mathcal{R}}$  matrices under the trace. This way one arrives at  $\hat{\mathcal{R}} \circ \hat{G}^{-1} \circ \hat{\mathcal{R}}^{-1} = \hat{G}^{-1} + \hat{\mathcal{R}} \circ [\hat{G}^{-1} \circ \hat{\mathcal{R}}^{-1}] = \hat{G}^{-1} + i\hat{\mathcal{R}}\partial_t\hat{\mathcal{R}}^{-1} + i\hat{\mathcal{R}}\mathbf{v}_F\partial_{\mathbf{r}}\hat{\mathcal{R}}^{-1}$ , where one has linearized the dispersion relation near the Fermi surface  $\epsilon_p = p^2/2m - \epsilon_F \approx \mathbf{v}_F\mathbf{p} \rightarrow -i\mathbf{v}_F\partial_{\mathbf{r}}$ . As a result, the desired action has the form

$$iS[\hat{Q}] = \text{Tr} \ln \left[ \hat{1} + i\hat{\mathcal{G}}\hat{\mathcal{R}}\partial_t\hat{\mathcal{R}}^{-1} + i\hat{\mathcal{G}}\hat{\mathcal{R}}\mathbf{v}_F\partial_{\mathbf{r}}\hat{\mathcal{R}}^{-1} \right], \quad (168)$$

where we omit circular multiplication sign for brevity. Here  $\hat{\mathcal{G}}$  is the *impurity dressed* Green's function matrix, defined through the Dyson equation  $(\hat{G}^{-1} + \frac{i}{2\tau_{el}}\hat{\Lambda})\hat{\mathcal{G}} = \hat{1}$ . For practical calculations

it is convenient to write  $\hat{\mathcal{G}}$  in the form

$$\hat{\mathcal{G}} = \begin{pmatrix} \mathcal{G}^R & \mathcal{G}^K \\ 0 & \mathcal{G}^A \end{pmatrix} = \frac{1}{2}\mathcal{G}^R[\hat{1} + \hat{\Lambda}] + \frac{1}{2}\mathcal{G}^A[\hat{1} - \hat{\Lambda}], \quad (169)$$

with retarded, advanced and Keldysh components given by

$$\mathcal{G}^{R(A)}(\mathbf{p}, \epsilon) = [\epsilon - \epsilon_p \pm i/2\tau_{\text{el}}]^{-1}, \quad \mathcal{G}^K(\mathbf{p}, \epsilon) = \mathcal{G}^R(\mathbf{p}, \epsilon)F_\epsilon - F_\epsilon\mathcal{G}^A(\mathbf{p}, \epsilon). \quad (170)$$

One may now expand the logarithm in (168) in gradients of the rotation matrices  $\hat{\mathcal{R}}$  to the linear order in  $\partial_i\hat{\mathcal{R}}^{-1}$  and to the quadratic order in  $\partial_r\hat{\mathcal{R}}^{-1}$  terms (contribution, linear in the spatial gradient, vanishes owing to the angular integration). As a result

$$iS[\hat{\mathcal{Q}}] \approx i\text{Tr}\{\hat{\mathcal{G}}\hat{\mathcal{R}}\partial_i\hat{\mathcal{R}}^{-1}\} + \frac{1}{2}\text{Tr}\{\hat{\mathcal{G}}(\hat{\mathcal{R}}\mathbf{v}_F\partial_r\hat{\mathcal{R}}^{-1})\hat{\mathcal{G}}(\hat{\mathcal{R}}\mathbf{v}_F\partial_r\hat{\mathcal{R}}^{-1})\}. \quad (171)$$

Since  $\sum_p \hat{\mathcal{G}}(\mathbf{p}, \epsilon) = -i\pi\nu\hat{\Lambda}_\epsilon$ , which directly follows from the saddle point Equation (162), one finds for the  $\partial_i$  term in the action  $i\text{Tr}\{\hat{\mathcal{G}}\hat{\mathcal{R}}\partial_i\hat{\mathcal{R}}^{-1}\} = \pi\nu\text{Tr}\{\partial_i\hat{\mathcal{Q}}\}$ . For the  $\partial_r$  term, one finds  $-\frac{1}{4}\pi\nu D\text{Tr}\{(\partial_r\hat{\mathcal{Q}})^2\}$ , where  $D = v_F^2\tau_{\text{el}}/d$  is the diffusion constant and  $d$  is the spatial dimensionality. Indeed, for the product of the Green's functions one uses  $\sum_p \mathcal{G}^R(\mathbf{p}, \epsilon)\mathbf{v}_F\mathcal{G}^A(\mathbf{p}, \epsilon)\mathbf{v}_F = 2\pi\nu\tau_{\text{el}}v_F^2/d = 2\pi\nu D$ , while the corresponding  $R - -R$  and  $A - -A$  terms vanish upon performing  $\epsilon_p$  integration. Employing then (169), one arrives at  $\text{Tr}\{[\hat{1} + \hat{\Lambda}](\hat{\mathcal{R}}\partial_r\hat{\mathcal{R}}^{-1})[\hat{1} - \hat{\Lambda}](\hat{\mathcal{R}}\partial_r\hat{\mathcal{R}}^{-1})\} = -\frac{1}{2}\text{Tr}\{(\partial_r(\hat{\mathcal{R}}^{-1}\hat{\Lambda}\hat{\mathcal{R}}))^2\} = -\frac{1}{2}\text{Tr}\{(\partial_r\hat{\mathcal{Q}})^2\}$ . Finally, one finds for the action of the soft-mode configurations [21, 22, 23]

$$iS[\hat{\mathcal{Q}}] = -\frac{\pi\nu}{4}\text{Tr}\{D(\partial_r\hat{\mathcal{Q}})^2 - 4\partial_r\hat{\mathcal{Q}}\}. \quad (172)$$

Despite of its simple appearance, the action (172) is highly non-linear owing to the constraint  $\hat{\mathcal{Q}}^2 = \hat{1}$ . The theory specified by (166) and (172) is called the *matrix non-linear  $\sigma$ -model*. The name came from the theory of magnetism, where the unit-length vector  $\vec{\sigma}(\mathbf{r})$ , represents a local (classical) spin, that may rotate over the sphere  $\vec{\sigma}^2 = 1$ .

One may now incorporate source terms  $S_V$  and  $S_A$  (see (112) and (116)) into the fermionic part of the action:

$$\text{Tr}\left\{\vec{\Psi}\left[\hat{G}^{-1} + \frac{i}{2\tau_{\text{el}}}\hat{\mathcal{Q}} + \hat{V} + \mathbf{v}_F\hat{\mathbf{A}}\right]\vec{\Psi}\right\}.$$

After Gaussian integration over  $\vec{\Psi}$  and  $\Psi$ , one finds for the source-fields-dependent partition function, compare with (cf. (161))

$$\begin{aligned} \mathcal{Z}[\mathbf{A}, V] &= \int \mathbf{D}[\hat{\mathcal{Q}}] \exp(iS[\hat{\mathcal{Q}}, \mathbf{A}, V]), \\ iS[\hat{\mathcal{Q}}, \mathbf{A}, V] &= -\frac{\pi\nu}{4\tau_{\text{el}}}\text{Tr}\{\hat{\mathcal{Q}}^2\} + \text{Tr}\ln\left[\hat{G}^{-1} + \frac{i}{2\tau_{\text{el}}}\hat{\mathcal{Q}} + \hat{V} + \mathbf{v}_F\hat{\mathbf{A}}\right]. \end{aligned} \quad (173)$$

Expanding trace of the logarithm in gradients of  $\hat{\mathcal{Q}}$  with the help of (167), one assumes that source fields  $\hat{V}$  and  $\hat{\mathbf{A}}$  are small in some sense and do not disturb the stationary configuration (165) (see Section 7 for discussions of this point). Then, similarly to (172), one finds from (173)

$$iS[\hat{\mathcal{Q}}, \mathbf{A}, V] = \frac{i\nu}{2}\text{Tr}\{\hat{V}\hat{\sigma}_x\hat{V}\} - \frac{\pi\nu}{4}\text{Tr}\{D(\hat{\partial}_r\hat{\mathcal{Q}})^2 - 4\partial_r\hat{\mathcal{Q}} + 4i\hat{V}\hat{\mathcal{Q}}\}, \quad (174)$$

where  $\hat{\sigma}_x$  is the Pauli matrix acting in the Keldysh space, and we have introduced covariant derivative

$$\hat{\partial}_r\hat{\mathcal{Q}} = \partial_r\hat{\mathcal{Q}} - i[\hat{\mathbf{A}}, \hat{\mathcal{Q}}]. \quad (175)$$

A few comments are in order regarding (174). First, it is still restricted to the manifold of  $\hat{\mathcal{Q}}$  matrices satisfying  $\hat{\mathcal{Q}}^2 = \hat{1}$ . The second trace on the right-hand side of (174), containing  $\hat{\mathcal{Q}}$ , originates from

$\sum_p \mathbf{v}_F \mathcal{G}^R \mathbf{v}_F \mathcal{G}^A$  and  $\sum_p \mathcal{G}^{R(A)}$  combinations in the expansion of the logarithm. On the other hand, the first term on the right-hand side of (174) originates from  $\sum_p \mathcal{G}^R \mathcal{G}^R$  and  $\sum_p \mathcal{G}^A \mathcal{G}^A$  combinations. These terms should be retained since the matrix  $V^\alpha(\epsilon - \epsilon') \hat{\gamma}^\alpha$  is not restricted to the  $1/\tau_{\text{el}}$  shell near the Fermi energy. This is so, because the scalar potential shifts the entire electronic band and not only energy strip  $|\epsilon|, |\epsilon'| < 1/\tau_{\text{el}}$ . Thus, it is essential to follow the variations of the electron spectrum all the way down to the bottom of the band to respect the charge neutrality. To derive  $\text{Tr}\{\hat{V} \hat{\sigma}_x \hat{V}\}$  one has to employ the fact that for any physical fermionic distribution function  $F_{\epsilon \rightarrow \pm\infty} \rightarrow \pm 1$ . Equations (174) and (175) generalize an effective  $\sigma$ -model action given by (172). Additional technical details needed to derive (174) from (173) are provided in Appendix C.

### 6.3 Tunneling action

Consider two metallic leads separated by a tunneling barrier, such that upon applying external voltage a current may flow between them. In this case one has to add corresponding tunneling term to the Hamiltonian of the system

$$\hat{H}_T = \int_{\mathbf{r} \in L} d\mathbf{r} \int_{\mathbf{r}' \in R} d\mathbf{r}' [T_{\mathbf{r}\mathbf{r}'} \hat{\psi}_L^\dagger(\mathbf{r}) \hat{\psi}_R(\mathbf{r}') + T_{\mathbf{r}\mathbf{r}'}^* \hat{\psi}_R^\dagger(\mathbf{r}') \hat{\psi}_L(\mathbf{r})],$$

where  $\hat{\psi}_{L(R)}$  is the electron annihilation operator to the left(right) from the tunneling barrier. The  $\hat{\psi}_{L(R)}^\dagger$  is corresponding creation operator. The  $T_{\mathbf{r}\mathbf{r}'}$  and  $T_{\mathbf{r}\mathbf{r}'}^*$  are tunneling matrix elements whose range is restricted to the vicinity of the junction, since the overlap of electron wave functions decay exponentially away from it. Tunneling Hamiltonian translates into the fermionic tunneling action

$$iS_T = \int_C dt \iint d\mathbf{r} d\mathbf{r}' [T_{\mathbf{r}\mathbf{r}'} \bar{\psi}_L(\mathbf{r}, t) \psi_R(\mathbf{r}', t) + T_{\mathbf{r}\mathbf{r}'}^* \bar{\psi}_R(\mathbf{r}', t) \psi_L(\mathbf{r}, t)].$$

Since  $S_T$  is still quadratic in fermion fields, the Gaussian integration over them is straightforward, leading to the disorder averaged action in the form

$$\mathcal{Z} = \int \mathbf{D}[\hat{Q}_L, \hat{Q}_R] \exp(iS[\hat{Q}_L, \hat{Q}_R]),$$

$$iS[\hat{Q}_L, \hat{Q}_R] = -\frac{\pi\nu}{4\tau_{\text{el}}} \sum_{a=L,R} \text{Tr}\{\hat{Q}_a^2\} + \text{Tr} \ln \begin{pmatrix} \hat{G}_L^{-1} + \frac{i}{2\tau_{\text{el}}} \hat{Q}_L & \hat{T} \\ \hat{T}^\dagger & \hat{G}_R^{-1} + \frac{i}{2\tau_{\text{el}}} \hat{Q}_R \end{pmatrix}. \quad (176)$$

Deriving (176) one has to introduce two  $\hat{Q}$  matrices to decouple disorder mediated four-fermion term (159) in each of the two leads independently. In doing so it was assumed for simplicity that both disordered samples are characterized by equal mean free times and bare electronic densities of states. Equation (176) contains an additional  $2 \times 2$  matrix structure in the space of left-right electronic subsystems, described by  $\hat{Q}_{L(R)}$ , respectively. Note also that the tunneling matrix elements entering  $S[\hat{Q}_L, \hat{Q}_R]$  are unit matrices in the Keldysh subspace  $\hat{T}_{\mathbf{r}\mathbf{r}'} = T_{\mathbf{r}\mathbf{r}'} \hat{\sigma}_0$ .

Introducing the notation  $\hat{\mathbf{G}}_a^{-1} = \hat{G}_a^{-1} + \frac{i}{2\tau_{\text{el}}} \hat{Q}_a$ , one identically rewrites the last term of the action  $S[\hat{Q}_L, \hat{Q}_R]$  in (176) as

$$\text{Tr} \ln \begin{pmatrix} \hat{\mathbf{G}}_L^{-1} & \hat{T} \\ \hat{T}^\dagger & \hat{\mathbf{G}}_R^{-1} \end{pmatrix} = \text{Tr} \ln \begin{pmatrix} \hat{\mathbf{G}}_L^{-1} & 0 \\ 0 & \hat{\mathbf{G}}_R^{-1} \end{pmatrix} + \text{Tr} \ln \left[ \hat{1} + \begin{pmatrix} 0 & \hat{\mathbf{G}}_L \hat{T} \\ \hat{\mathbf{G}}_R \hat{T}^\dagger & 0 \end{pmatrix} \right]. \quad (177)$$

Expanding now  $\text{Tr} \ln \hat{\mathbf{G}}_a^{-1}$  in gradients of  $\hat{Q}_a$  matrix around the saddle point  $\hat{\Lambda}_a$ , one obtains sigma model action (172), for each of the two leads independently. The coupling between them is described by the second term on the right-hand side of (177), which defines tunneling action  $S_T[\hat{Q}_L, \hat{Q}_R]$ . For a small transparency tunneling junction, one may expand trace of the logarithm to the leading (second) order in  $\hat{T}$  and obtain

$$iS_T[\hat{Q}_L, \hat{Q}_R] = \text{Tr} \ln \left[ \hat{1} + \begin{pmatrix} 0 & \hat{\mathbf{G}}_L \hat{T} \\ \hat{\mathbf{G}}_R \hat{T}^\dagger & 0 \end{pmatrix} \right] \approx -\text{Tr}\{\hat{\mathbf{G}}_L \hat{T} \hat{\mathbf{G}}_R \hat{T}^\dagger\} + \dots \quad (178)$$

Employing the local nature of matrix elements  $T_{\mathbf{r}\mathbf{r}'}$  and the fact that at the soft-mode manifold  $\hat{Q}_a = \frac{i}{\pi\nu}\hat{\mathbf{G}}_a(\mathbf{r}, \mathbf{r})$ , see (162), one finds for the tunneling part of the action

$$iS_T[\hat{Q}_L, \hat{Q}_R] = \frac{g_T}{4g_Q}\text{Tr}\{\hat{Q}_L\hat{Q}_R\} = -\frac{g_T}{8g_Q}\text{Tr}\{(\hat{Q}_L - \hat{Q}_R)^2\}. \quad (179)$$

Here we approximated the tunneling matrices as  $T_{\mathbf{r}\mathbf{r}'} = T_0\delta(\mathbf{r} - \mathbf{r}')$  and introduced the tunneling conductance  $g_T = 4\pi^2e^2|T_0|^2\nu^2$ , and the quantum conductance  $g_Q = e^2/(2\pi\hbar)$ . The tunneling action (179) is a generalization of the  $\text{Tr}\{D(\partial_r Q)^2\}$  term of the NLSM action (172) for the tunneling geometry.

If the tunneling amplitudes  $T_{\mathbf{r}\mathbf{r}'}$  are not small one needs to keep higher orders in the expansion of the logarithm in (178). It is convenient to express products of the even number of the tunneling amplitudes  $T_{\mathbf{r}\mathbf{r}'}$  through the transmission probabilities of individual transverse channels  $T_n$  (see, for example, Appendix C of [73]). With the help of (162), one may show that expansion of the logarithm in (178) is order by order equivalent to the expansion of the following action [70, 71, 72]

$$iS_T[\hat{Q}_L, \hat{Q}_R] = \frac{1}{2}\sum_n \text{Tr} \ln \left[ \hat{1} - \frac{T_n}{4} (\hat{Q}_L - \hat{Q}_R)^2 \right]. \quad (180)$$

If all transmissions are small,  $T_n \ll 1$ , one may expand (180) to the leading order in  $T_n$  and recover (179), identifying the tunneling conductance as  $g_T = g_Q \sum_n T_n$ , c.f. (135). Equation (180) goes beyond this limit and allows mesoscopic transport to be treated in arbitrary two-terminal geometries. Its generalization for multi-terminal case was also developed by Nazarov *et. al.* [70, 74, 75].

## 6.4 Usadel equation

Let us return to the action specified by (172). Our goal is to investigate the physical consequences of NLSM. As a first step, one needs to determine the most probable (stationary) configuration,  $\hat{Q}_{tr'}(\mathbf{r})$ , on the soft-mode manifold (166). To this end, one parameterizes deviations from  $\hat{Q}_{tr'}(\mathbf{r})$  as  $\hat{Q} = \hat{\mathcal{R}}^{-1} \circ \hat{Q} \circ \hat{\mathcal{R}}$  and chooses  $\hat{\mathcal{R}} = \exp(\hat{\mathcal{W}}/2)$ , where  $\hat{\mathcal{W}}_{tr'}(\mathbf{r})$  is the generator of rotations. Expanding to the first order in  $\hat{\mathcal{W}}$ , one finds  $\hat{Q} = \hat{Q} - [\hat{\mathcal{W}} \circ \hat{Q}]/2$ . One may now substitute such a  $\hat{Q}$  matrix into the action (172) and require that the terms linear in  $\hat{\mathcal{W}}$  vanish. This leads to the saddle point equation for  $\hat{Q}$ . For the first term in the curly brackets on the right-hand side of (172) one obtains  $\frac{1}{2}\text{Tr}\{\hat{\mathcal{W}}\partial_r D[(\partial_r \hat{Q})\hat{Q} - \hat{Q}\partial_r \hat{Q}]\} = -\text{Tr}\{\hat{\mathcal{W}}\partial_r D(\hat{Q}\partial_r \hat{Q})\}$ , where one has employed  $\partial_r \hat{Q} \circ \hat{Q} + \hat{Q} \circ \partial_r \hat{Q} = 0$ , since  $\hat{Q}^2 = \hat{1}$ . For the second term one finds  $\text{Tr}\{\hat{\mathcal{W}}_{tr'}(\partial_t + \partial_{t'})\hat{Q}_{tr'}\} = \text{Tr}\{\hat{\mathcal{W}}\{\partial_t, \hat{Q}\}\}$ . Demanding that the linear term in  $\hat{\mathcal{W}}$  vanishes, one obtains

$$\partial_r(D\hat{Q} \circ \partial_r \hat{Q}) - \{\partial_t, \hat{Q}\} = 0. \quad (181)$$

This is the Usadel equation [76] for the stationary  $\hat{Q}$ -matrix. If one looks for the solution of the Usadel equation in the subspace of "classical", having causality structure, configurations, then one takes  $\hat{Q} = \hat{\Lambda}$ , with as-yet unspecified distribution function  $F_{tr'}(\mathbf{r})$ . Therefore, in this case the Usadel equation is reduced to the single equation for the distribution function  $F_{tr'}(\mathbf{r})$ . Substituting  $\hat{\Lambda}$  from (165) into (181) and performing the Wigner transformation

$$F_{tr'}(\mathbf{r}) = \int \frac{d\epsilon}{2\pi} F_\epsilon(\mathbf{r}, \tau) e^{-i\epsilon(t-t')}, \quad \tau = \frac{t+t'}{2}, \quad (182)$$

one obtains

$$\partial_r[D(\mathbf{r})\partial_r F_\epsilon(\mathbf{r}, \tau)] - \partial_\tau F_\epsilon(\mathbf{r}, \tau) = 0, \quad (183)$$

where we allowed for a (smooth) spatial dependence of the diffusion constant. This is the kinetic equation for the fermionic distribution function of the disordered system in the non-interacting limit,

which happens to be the diffusion equation. Note that it is the same equation for any energy  $\epsilon$  and different energies do not "talk" to each other, which is natural for the non-interacting system. In the presence of interactions, the equation acquires the collision integral on the right-hand side that mixes different energies between themselves. It is worth mentioning that elastic scattering does not show up in the collision integral. It was already fully taken into account in the derivation of the Usadel equation and went into the diffusion term.

As an example, let us consider a disordered quasi-one-dimensional wire of length  $L$ , attached to two leads, kept at different voltages [77]. We look for the space dependent, stationary function  $F_\epsilon(x)$  with  $x$  being coordinate along the wire, that satisfies  $D\partial_x^2 F_\epsilon(x) = 0$ , supplemented by the boundary conditions  $F_\epsilon(x=0) = F_L(\epsilon)$  and  $F_\epsilon(x=L) = F_R(\epsilon)$ , where  $F_{R(L)}(\epsilon)$  are the distribution functions of the left and right leads. The proper solution is

$$F_\epsilon(x) = F_L(\epsilon) + [F_R(\epsilon) - F_L(\epsilon)]\frac{x}{L}. \quad (184)$$

The distribution function inside the wire interpolates between the two distribution linearly. At low temperatures it looks like a two-step function, where the energy separation between the steps is the applied voltage,  $eV$ , while the relative height depends on the position  $x$ . Comparing (183) with the continuity equation, one notes that the current density (at a given energy  $\epsilon$ ) is given by  $j(\epsilon) = D\partial_x F_\epsilon(x) = D[F_R(\epsilon) - F_L(\epsilon)]/L$ . The total electric current, is thus

$$I = ev \int d\epsilon j(\epsilon) = \frac{evD}{L} \int d\epsilon [F_R(\epsilon) - F_L(\epsilon)] = e^2 \frac{vD}{L} V = \sigma_D V/L,$$

where the Drude conductivity of the diffusive wire is given by  $\sigma_D = e^2 vD$ .

## 6.5 Fluctuations

Following the discussions in previous sections we consider fluctuations near the stationary solution  $\underline{\hat{Q}}_{t'}(\mathbf{r}) = \hat{\Lambda}_{t-\nu}$ , see (165). We restrict ourselves to the soft-mode fluctuations that satisfy  $\hat{Q}^2 = \hat{1}$  and neglect all massive modes that stay outside of this manifold. The massless fluctuations of the  $\hat{Q}$ -matrix may be parameterized as

$$\hat{Q} = \hat{U} \circ e^{-\hat{W}/2} \circ \hat{\sigma}_z \circ e^{\hat{W}/2} \circ \hat{U}^{-1}, \quad (185)$$

where rotation generators are given by

$$\hat{W} = \begin{pmatrix} 0 & d \\ \bar{d} & 0 \end{pmatrix}, \quad \hat{U} = \hat{U}^{-1} = \begin{pmatrix} 1 & F \\ 0 & -1 \end{pmatrix}. \quad (186)$$

Here  $d_{t'}(\mathbf{r})$  and  $\bar{d}_{t'}(\mathbf{r})$  are two independent Hermitian matrices in the time space. One, thus, understands the functional integration over  $\hat{Q}_{t'}(\mathbf{r})$  in (173) as an integration over two mutually independent Hermitian matrices in the time domain,  $d_{t'}(\mathbf{r})$  and  $\bar{d}_{t'}(\mathbf{r})$ . The physical meaning of  $d_{t'}(\mathbf{r})$  is a deviation of the fermionic distribution function  $F_{t'}(\mathbf{r})$  from its stationary value. At the same time,  $\bar{d}_{t'}(\mathbf{r})$  has no classical interpretation. To a large extent, it plays the role of the quantum counterpart of  $d_{t'}(\mathbf{r})$ , that appears only as the internal line in the diagrams. The reason for choosing  $\hat{Q}$  in the form of (185) can be justified as follows. First, one notes that  $\hat{Q} \equiv \hat{\Lambda} = \hat{U} \hat{\sigma}_z \hat{U}^{-1}$ . Second, one should realize that the part of  $\hat{W}$  that commutes with  $\hat{Q}$  does not generate any fluctuations, therefore, one restricts  $\hat{W}$  to satisfy  $\hat{W} \hat{\sigma}_z + \hat{\sigma}_z \hat{W} = 0$ . Thus,  $\hat{W}$  has to be off-diagonal and most generally parameterized by two independent fields,  $d$  and  $\bar{d}$ , see (186).

One may expand now the action (172) in powers of  $\bar{d}_{t'}(\mathbf{r})$  and  $d_{t'}(\mathbf{r})$ . Since  $\hat{Q}_{t'}$  was chosen to be a stationary point, the expansion starts from the second order. If stationary  $\underline{\hat{F}}_{t,t'}(\mathbf{r})$  is spatially uniform, one obtains

$$iS[\hat{W}] = -\frac{\pi\nu}{2} \int d\mathbf{r} \iint dt dt' \bar{d}_{t'}(\mathbf{r}) [-D\partial_t^2 + \partial_t + \partial_{t'}] d_{t'}(\mathbf{r}). \quad (187)$$

The quadratic form may be diagonalized by transforming to the energy/momentum representation

$$\hat{W}_{\epsilon\epsilon'}(\mathbf{q}) = \int d\mathbf{r} \iint dt dt' \hat{W}_{tt'}(\mathbf{r}) \exp(i\epsilon t - i\epsilon' t') \exp(-i\mathbf{q}\mathbf{r}).$$

As a result, the propagator of small  $\hat{Q}$  matrix fluctuations is

$$\langle d_{\epsilon_2\epsilon_1}(\mathbf{q}) \bar{d}_{\epsilon_3\epsilon_4}(-\mathbf{q}) \rangle_{\mathcal{W}} = -\frac{2}{\pi\nu} \frac{\delta_{\epsilon_1\epsilon_3} \delta_{\epsilon_2\epsilon_4}}{Dq^2 + i\omega} \equiv -\frac{2}{\pi\nu} \delta_{\epsilon_1\epsilon_3} \delta_{\epsilon_2\epsilon_4} \mathcal{D}^A(\mathbf{q}, \omega), \quad (188)$$

where  $\omega \equiv \epsilon_1 - \epsilon_2 = \epsilon_3 - \epsilon_4$  and object  $\mathcal{D}^{R(A)}(\mathbf{q}, \omega) = \mathcal{D}^{R(A)}(\mathbf{q}, \epsilon_1 - \epsilon_2) = [Dq^2 \mp i(\epsilon_1 - \epsilon_2)]^{-1}$  is called the *diffuson*. The higher-order terms of the action (172) expansion over  $d_{tt'}(\mathbf{r})$  and  $\bar{d}_{tt'}(\mathbf{r})$  describe non-linear interactions of the diffusive modes with the vertices called *Hikami boxes* [78, 79]. These non-linear terms are responsible for weak-localization corrections [79, 80, 81, 82]. If the distribution function  $F_{tt'}(\mathbf{r})$  is spatially non-uniform, there is an additional term in the quadratic action  $-(\pi\nu D/2)\text{Tr}\{\bar{d}(\partial_{\mathbf{r}}F)d(\partial_{\mathbf{r}}F)\}$ . This term generates non-zero correlations of the type  $\langle dd \rangle_{\mathcal{W}}$ , which are important for some applications.

## 6.6 Applications II: Mesoscopic effects

### 6.6.1 Kubo formula and linear response

It was demonstrated in Section 5.4 how the linear response theory is formulated in the Keldysh technique. Let us see now how the polarization operator of the disordered electron gas may be obtained from NLSM action. To this end, one uses general definition of the density response function  $\Pi^R(x, x')$  given by (121) along with the disorder averaged action (174), which gives

$$\Pi^R(x, x') = -\frac{i}{2} \frac{\delta^2 \mathcal{Z}[V^{cl}, V^q]}{\delta V^{cl}(x') \delta V^q(x)} \Big|_{\hat{V}=0} = \nu \delta(\mathbf{r} - \mathbf{r}') \delta(t - t') + \frac{i}{2} (\pi\nu)^2 \langle \text{Tr}\{\hat{\gamma}^q \hat{Q}_{tt}(\mathbf{r})\} \text{Tr}\{\hat{\gamma}^{cl} \hat{Q}_{t't'}(\mathbf{r}')\} \rangle_Q, \quad (189)$$

where  $x = (\mathbf{r}, t)$  and angular brackets stand for the averaging over the action (172). The first term on the right-hand side of (189) originates from the differentiation of  $\text{Tr}\{\hat{V}\hat{\sigma}_x\hat{V}\}$  part of the action (174), while the second term comes from differentiation of  $\text{Tr}\{\hat{V}\hat{Q}\}$ . Equation (189) represents the  $\sigma$ -model equivalent of the Kubo formula for the linear density response.

In the Fourier representation the last equation takes the form

$$\Pi^R(\mathbf{q}, \omega) = \nu + \frac{i}{2} (\pi\nu)^2 \iint \frac{d\epsilon d\epsilon'}{4\pi^2} \langle \text{Tr}\{\hat{\gamma}^q \hat{Q}_{\epsilon+\omega, \epsilon}(\mathbf{q})\} \text{Tr}\{\hat{\gamma}^{cl} \hat{Q}_{\epsilon', \epsilon'+\omega}(-\mathbf{q})\} \rangle_Q. \quad (190)$$

Employing (185) and (186), one finds in the linear order in the diffusive fluctuations (the only contribution in the zeroth order is  $\nu$ , indeed  $\text{Tr}\{\hat{\gamma}^{cl}\hat{\Lambda}\} = 0$ )

$$\begin{aligned} \text{Tr}\{\hat{\gamma}^{cl} \hat{Q}_{\epsilon', \epsilon'+\omega}(-\mathbf{q})\} &= \bar{d}_{\epsilon', \epsilon'+\omega}(-\mathbf{q})(F_{\epsilon'+\omega} - F_{\epsilon'}), \\ \text{Tr}\{\hat{\gamma}^q \hat{Q}_{\epsilon+\omega, \epsilon}(\mathbf{q})\} &= \bar{d}_{\epsilon+\omega, \epsilon}(\mathbf{q})(1 - F_{\epsilon} F_{\epsilon+\omega}) - d_{\epsilon+\omega, \epsilon}(\mathbf{q}). \end{aligned} \quad (191)$$

Since  $\langle \bar{d}\bar{d} \rangle_{\mathcal{W}} \equiv 0$  only the last term of the last expression contributes to the average in (190). The result is

$$\Pi^R(\mathbf{q}, \omega) = \nu + \frac{i\pi\nu^2}{4} \int_{-\infty}^{+\infty} d\epsilon (F_{\epsilon} - F_{\epsilon+\omega}) \langle d_{\epsilon+\omega, \epsilon}(\mathbf{q}) \bar{d}_{\epsilon, \epsilon+\omega}(-\mathbf{q}) \rangle_{\mathcal{W}} = \nu \left[ 1 + \frac{i\omega}{Dq^2 - i\omega} \right] = \frac{\nu Dq^2}{Dq^2 - i\omega}, \quad (192)$$

where we have used the propagator of diffusons (188) and the integral  $\int d\epsilon (F_{\epsilon} - F_{\epsilon+\omega}) = -2\omega$ . The fact that  $\Pi^R(0, \omega) = 0$  is a consequence of the particle number conservation. One has obtained the diffusion form of the density-density response function. Also note that this function is indeed retarded (analytic in the upper half-plane of complex  $\omega$ ), as it should be. The current-current response



function,  $K^R(\mathbf{q}, \omega)$ , may be obtained in the similar manner. However, more straightforward way is to use continuity equation  $\mathbf{q} \cdot \mathbf{j} + \omega \rho = 0$ , which implies the following relation between density and current response functions  $K^R(\mathbf{q}, \omega) = \omega^2 \Pi^R(\mathbf{q}, \omega)/q^2$ . As a result the conductivity is given by

$$\sigma(\mathbf{q}, \omega) = \frac{e^2}{i\omega} K^R(\mathbf{q}, \omega) = e^2 \frac{-i\omega}{q^2} \Pi^R(\mathbf{q}, \omega) = e^2 \nu D \frac{-i\omega}{Dq^2 - i\omega}, \quad (193)$$

which in the uniform limit  $\mathbf{q} \rightarrow 0$  reduces to the Drude result  $\sigma_D \equiv \sigma(0, \omega) = e^2 \nu D$ .

### 6.6.2 Spectral statistics

Consider a piece of disordered metal of size  $L$  such that  $L \gg l$ , where  $l \equiv v_F \tau_{el}$  is the elastic mean free path. The spectrum of the Schrödinger equation consists of a discrete set of levels,  $\epsilon_n$ , that may be characterized by the *sample-specific* density of states (DOS),  $\nu(\epsilon) = \sum_n \delta(\epsilon - \epsilon_n)$ . This quantity fluctuates strongly and usually cannot (and does not need to) be calculated analytically. One may average it over realizations of disorder to obtain a mean DOS:  $\langle \nu(\epsilon) \rangle_{\text{dis}}$ . The latter is a smooth function of energy on the scale of the Fermi energy and thus may be taken as a constant  $\langle \nu(\epsilon_F) \rangle_{\text{dis}} \equiv \nu$ . This is exactly the DOS that was used in the previous sections.

One may wonder how to sense fluctuations of the sample-specific DOS  $\nu(\epsilon)$  and, in particular, how a given spectrum at one energy  $\epsilon$  is correlated with itself at another energy  $\epsilon'$ . To answer this question one may calculate the spectral correlation function

$$R(\epsilon, \epsilon') \equiv \langle \nu(\epsilon) \nu(\epsilon') \rangle_{\text{dis}} - \nu^2. \quad (194)$$

This function was calculated in the seminal paper of Altshuler and Shklovskii [83]. Here we derive it using the Keldysh NLSM.

The DOS is defined as

$$\nu(\epsilon) = i \sum_k (G^R(\mathbf{k}, \epsilon) - G^A(\mathbf{k}, \epsilon)) / (2\pi) = (\langle \psi_1 \bar{\psi}_1 \rangle - \langle \psi_2 \bar{\psi}_2 \rangle) / (2\pi) = -\langle \vec{\Psi} \hat{\sigma}_z \vec{\Psi} \rangle / (2\pi),$$

where the angular brackets denote quantum (as opposed to disorder) averaging and the indices are in Keldysh space. To generate the DOS at any given energy one adds a source term

$$iS_{\text{DOS}} = - \int \frac{d\epsilon}{2\pi} J_\epsilon \int d\mathbf{r} \vec{\Psi}(\epsilon, \mathbf{r}) \hat{\sigma}_z \vec{\Psi}(\epsilon, \mathbf{r}) = - \iint dt dt' \int d\mathbf{r} \vec{\Psi}(\mathbf{r}, t) J_{t-t'} \hat{\sigma}_z \vec{\Psi}(\mathbf{r}, t'),$$

to the fermionic action (172). After averaging over disorder and changing to the  $\hat{Q}$  matrix representation the DOS source term is translated to

$$iS_{\text{DOS}} = \pi \nu \int \frac{d\epsilon}{2\pi} J_\epsilon \int d\mathbf{r} \text{Tr} \{ \hat{Q}_{\epsilon\epsilon}(\mathbf{r}) \hat{\sigma}_z \}.$$

Then the DOS is generated by  $\nu(\epsilon) = \delta \mathcal{Z}[J] / \delta J_\epsilon$ . It is now clear that  $\langle \nu(\epsilon) \rangle_{\text{dis}} = \frac{1}{2} \nu \langle \text{Tr} \{ \hat{Q}_{\epsilon\epsilon} \hat{\sigma}_z \} \rangle_Q$ . Substituting  $\hat{Q}_{\epsilon\epsilon} = \hat{\Lambda}_\epsilon$  one finds  $\langle \nu(\epsilon) \rangle_{\text{dis}} = \nu$ , as it should be, of course. It is also easy to check that the fluctuations around  $\hat{\Lambda}$  do not change the result (all the fluctuation diagrams cancel owing to the causality constraints). We are now in a position to calculate the correlation function (194),

$$R(\epsilon, \epsilon') \equiv \frac{\delta^2 \mathcal{Z}[J]}{\delta J_\epsilon \delta J_{\epsilon'}} - \nu^2 = \nu^2 \left[ \frac{1}{4} \langle \text{Tr} \{ \hat{Q}_{\epsilon\epsilon} \hat{\sigma}_z \} \text{Tr} \{ \hat{Q}_{\epsilon'\epsilon'} \hat{\sigma}_z \} \rangle_Q - 1 \right]. \quad (195)$$

Employing the parametrization of (185), one finds, up to the second order in the diffusive fluctuations  $\hat{\mathcal{W}}$ ,

$$\text{Tr} \{ \hat{Q} \hat{\sigma}_z \} = \frac{1}{2} [4 - 2F \circ \bar{d} - 2\bar{d} \circ F + d \circ \bar{d} + \bar{d} \circ d]. \quad (196)$$

Since  $\langle \bar{d}\bar{d} \rangle_W = 0$ , the only non-vanishing terms contributing to (195) are those with no  $d$  and  $\bar{d}$  at all (they cancel  $v^2$  term) and those of the type  $\langle d\bar{d}\bar{d}\bar{d} \rangle_W$ . Collecting the latter terms one finds

$$R(\epsilon, \epsilon') = \frac{v^2}{16} \int d\mathbf{r} \iint \frac{d\epsilon_1 d\epsilon_2}{(2\pi)^2} \langle (d_{\epsilon_1\epsilon_2} \bar{d}_{\epsilon_1\epsilon} + \bar{d}_{\epsilon_1\epsilon} d_{\epsilon_1\epsilon_2}) (d_{\epsilon'\epsilon_2} \bar{d}_{\epsilon_2\epsilon'} + \bar{d}_{\epsilon'\epsilon_2} d_{\epsilon_2\epsilon'}) \rangle_W. \quad (197)$$

Now one has to perform Wick's contractions, using correlation function  $\langle d_{\epsilon\epsilon'} \bar{d}_{\epsilon'\epsilon} \rangle_W \propto \mathcal{D}^R(\epsilon - \epsilon')$ , which follows from (188), and also take into account  $\int d\epsilon_1 [\mathcal{D}^{R(A)}(\mathbf{q}, \epsilon - \epsilon_1)]^2 = 0$ , owing to the integration of a function which is analytic in the entire upper (lower) half-plane of  $\epsilon_1$ . As a result,

$$R(\epsilon, \epsilon') = \frac{1}{4\pi^2} \sum_q [(\mathcal{D}^R(\mathbf{q}, \epsilon - \epsilon'))^2 + (\mathcal{D}^A(\mathbf{q}, \epsilon - \epsilon'))^2], \quad (198)$$

where the momentum summation stands for a summation over the discrete modes of the diffusion operator  $D\partial_r^2$  with the zero current (zero derivative) at the boundary of the metal. This is the result of Altshuler and Shklovskii [83] for the unitary symmetry class. Note that the correlation function  $R(\epsilon, \epsilon')$  depends only on the energy difference  $\omega = \epsilon - \epsilon'$ . Diagrammatic representation of  $R(\epsilon, \epsilon')$  function is shown in Figure 11. Adopting an explicit form of the diffusion propagator, we find spectral correlation function in the form

$$R(\epsilon - \epsilon') = -\frac{1}{2\pi^2} \text{Re} \sum_n \frac{1}{(\epsilon - \epsilon' + iDq_n^2)^2}, \quad (199)$$

where  $q_n^2 = \sum_\mu \pi^2 n_\mu^2 / L_\mu^2$ , with  $\mu = x, y, z$ ;  $n_\mu = 0, 1, 2, \dots$  and  $L_\mu$  are spatial dimensions of the mesoscopic sample.

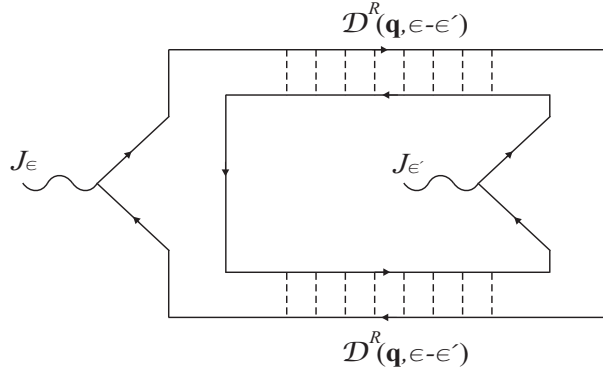

Figure 11: Diagram for calculation of mesoscopic fluctuations of the density of states,  $R(\epsilon, \epsilon')$ , see (195). It is generated from the Wick contraction  $\langle d_{\epsilon\epsilon_1} \bar{d}_{\epsilon_1\epsilon} \bar{d}_{\epsilon'\epsilon_2} d_{\epsilon_2\epsilon'} \rangle_W \rightarrow \langle d_{\epsilon\epsilon_1} \bar{d}_{\epsilon'\epsilon_2} \rangle_W \langle \bar{d}_{\epsilon_1\epsilon} d_{\epsilon_2\epsilon'} \rangle_W \propto [\mathcal{D}^R(\mathbf{q}, \epsilon - \epsilon')]^2 \delta_{\epsilon_1\epsilon'} \delta_{\epsilon_2\epsilon}$ , see (197). There is also a similar diagram with the advanced diffusons.

For a small energy difference  $\omega \ll E_{Th} = D/L^2$  only the lowest homogenous mode,  $q_n = 0$ , of the diffusion operator (the so-called zero mode) may be retained and, thus,  $R(\omega) = -1/(2\pi^2\omega^2)$ . This is the universal random matrix result. The fact that the correlation function is negative means that the energy levels are *less* likely to be found at a small distance  $\omega$  from each other. This is a manifestation of the energy levels repulsion. Note that the correlations decay very slowly — as the inverse square of the energy distance. One may note that the random matrix result [84]

$$R_{RMT}(\omega) = -\frac{1 - \cos(2\pi\omega/\delta)}{2\pi^2\omega^2}, \quad (200)$$

where  $\delta$  is the mean level spacing, contains also an oscillatory function of the energy difference. These oscillations reflect discreteness of the underlying energy spectrum. They cannot be found in the perturbation theory in small fluctuations near the  $\hat{\Lambda}$  “point”. However, they may be recovered once additional stationary points (not possessing the causality structure) are taken into account [85]. The saddle point method and perturbation theory work as long as  $\omega \gg \delta$ . Currently it is not known how to treat the Keldysh NLSM at  $\omega \lesssim \delta$ .

### 6.6.3 Universal conductance fluctuations

Similarly to the discussions of the previous section consider an ensemble of small metallic samples with the size  $L$  comparable to the electron phase coherence length,  $L \sim L_\phi$ . Their conductances exhibit sample-to-sample fluctuations owing to differences in their specific realizations of disorder potential. These reproducible fluctuations are known as *universal conductance fluctuations* (UCFs). Theoretical studies of UCFs were initiated by Altshuler [86], and Lee and Stone [87]. More detailed study of UCFs was given later in [83, 88]. The technique developed in this section for treating UCFs in the framework of the Keldysh non-linear  $\sigma$ -model is closely parallel to the theory developed by Altshuler, Kravtsov and Lerner [89] in the framework of the zero temperature replica non-linear sigma model.

Our starting point is the expression for the dc conductivity within the linear response given by

$$\sigma_{\mu\nu} = -\frac{e^2}{2} \lim_{\Omega \rightarrow 0} \frac{1}{\Omega} \left( \frac{\delta^2 \mathcal{Z}[\mathbf{A}^{cl}, \mathbf{A}^q]}{\delta A_{\nu_i}^{cl}(\Omega) \delta A_{\mu_i}^q(-\Omega)} \right)_{\mathbf{A}^{cl}=\mathbf{A}^q=0}, \quad (201)$$

where indices  $\mu, \nu$  stand for the spatial Cartesian coordinates. Expanding action (174) to the quadratic order in the vector potential with the help of (175) one finds that corresponding term in the generating function reads as  $\mathcal{Z}[\mathbf{A}^{cl}, \mathbf{A}^q] = \frac{\pi\nu D}{2} \langle \text{Tr} \{ \hat{\mathbf{A}} \hat{\mathcal{Q}} \hat{\mathbf{A}} \hat{\mathcal{Q}} \} \rangle_{\mathcal{Q}}$ . At the saddle point  $\hat{\mathcal{Q}} = \hat{\Lambda}$ , after consecutive differentiation over the vector potential in (201) one finds for the average conductivity

$$\langle \sigma_{\mu\nu} \rangle_{\text{dis}} = \delta_{\mu\nu} \lim_{\Omega \rightarrow 0} \frac{\pi\sigma_D}{4\Omega} \text{Tr} \{ \hat{\gamma}^{cl} \hat{\Lambda}_{\epsilon+\Omega} \hat{\gamma}^q \hat{\Lambda}_{\epsilon-\Omega} \} = \delta_{\mu\nu} \frac{\pi\sigma_D}{2} \lim_{\Omega \rightarrow 0} \frac{1}{\Omega} \int \frac{d\epsilon}{2\pi} (F_{\epsilon+\Omega} - F_{\epsilon-\Omega}) = \sigma_D \delta_{\mu\nu} \quad (202)$$

where  $\sigma_D = e^2 \nu D$ , as it should be of course. At this level, retaining fluctuations  $\hat{\mathcal{W}}$  of the  $\hat{\mathcal{Q}}$  matrix around the saddle point  $\hat{\Lambda}$ , one can calculate weak-localization corrections [78, 79, 80, 81, 82] to the average conductivity. In what follows we are interested in calculation of the irreducible correlation function for the conductivity fluctuations which is defined in the following way

$$\langle \delta\sigma_{\mu_1\nu_1} \delta\sigma_{\mu_2\nu_2} \rangle_{\text{dis}} = \langle (\sigma_{\mu_1\nu_1} - \langle \sigma_{\mu_1\nu_1} \rangle) (\sigma_{\mu_2\nu_2} - \langle \sigma_{\mu_2\nu_2} \rangle) \rangle_{\text{dis}}.$$

In view of (201) this irreducible correlator can be expressed through the  $\hat{\mathcal{Q}}$  matrix as

$$\langle \delta\sigma_{\mu_1\nu_1} \delta\sigma_{\mu_2\nu_2} \rangle_{\text{dis}} = \left( \frac{\pi\sigma_D}{4} \right)^2 \prod_{i=1}^2 \left( \lim_{\Omega_i \rightarrow 0} \frac{1}{\Omega_i} \frac{\delta^2}{\delta A_{\nu_i}^{cl}(\Omega_i) \delta A_{\mu_i}^q(-\Omega_i)} \right) \langle \text{Tr} \{ \hat{\mathbf{A}} \hat{\mathcal{Q}} \hat{\mathbf{A}} \hat{\mathcal{Q}} \} \text{Tr} \{ \hat{\mathbf{A}} \hat{\mathcal{Q}} \hat{\mathbf{A}} \hat{\mathcal{Q}} \} \rangle_{\mathcal{Q}} - \sigma_D^2 \delta_{\mu_1\nu_1} \delta_{\mu_2\nu_2}, \quad (203)$$

where we have used (174) and expanded  $\exp(iS[\hat{\mathcal{Q}}, \mathbf{A}])$  up to the fourth order in the vector potential. Now one has to account for fluctuations of the  $\hat{\mathcal{Q}}$  matrix up to the second order in generators  $\hat{\mathcal{W}}$ . There are two possibilities here: within each trace on the right-hand side of (203) one may expand each  $\hat{\mathcal{Q}}$  matrix either to the linear order in  $\hat{\mathcal{W}}$  resulting in  $\mathcal{T}_1[\hat{\mathcal{W}}] = \text{Tr} \{ \hat{\mathbf{A}} \hat{\sigma}_z \hat{\mathcal{W}} \hat{\mathbf{A}} \hat{\sigma}_z \hat{\mathcal{W}} \}$ ; or alternatively set one of  $\hat{\mathcal{Q}}$  matrices to be  $\hat{\Lambda}$ , while expanding the other one to the second order, resulting in  $\mathcal{T}_2[\hat{\mathcal{W}}] = \text{Tr} \{ \hat{\mathbf{A}} \hat{\sigma}_z \hat{\mathbf{A}} \hat{\sigma}_z \hat{\mathcal{W}}^2 \}$ , where  $\hat{\mathbf{A}} = \hat{\mathcal{U}}^{-1} \hat{\Lambda} \hat{\mathcal{U}}$ . As a result, (203) takes the form

$$\langle \delta\sigma_{\mu_1\nu_1} \delta\sigma_{\mu_2\nu_2} \rangle_{\text{dis}} = \left( \frac{\pi\sigma_D}{4} \right)^2 \prod_{i=1}^2 \left( \lim_{\Omega_i \rightarrow 0} \frac{1}{\Omega_i} \frac{\delta^2}{\delta A_{\nu_i}^{cl}(\Omega_i) \delta A_{\mu_i}^q(-\Omega_i)} \right) \left[ \langle \mathcal{T}_1[\hat{\mathcal{W}}] \mathcal{T}_1[\hat{\mathcal{W}}] \rangle_{\mathcal{W}} + \langle \mathcal{T}_2[\hat{\mathcal{W}}] \mathcal{T}_2[\hat{\mathcal{W}}] \rangle_{\mathcal{W}} \right] - \sigma_D^2 \delta_{\mu_1\nu_1} \delta_{\mu_2\nu_2}. \quad (204)$$

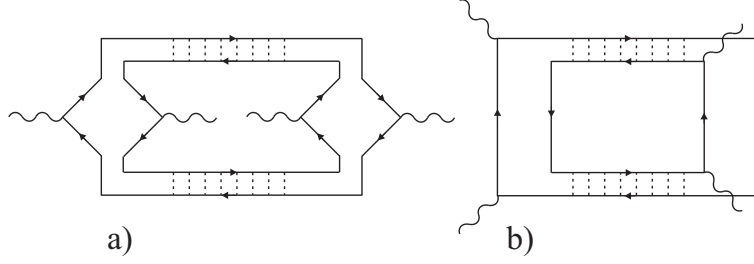

Figure 12: Diagrams for the variance of conductance fluctuations.

It is convenient to represent each average here diagrammatically, see Figure 12. A rhombus in Figure 12a correspond to the term with  $\mathcal{T}_1[\hat{\mathcal{W}}]$ , where the opposite vertices represent matrices  $\hat{\mathbb{A}}$ , while rectangles with adjacent vertices in Figure 12b correspond to the term with  $\mathcal{T}_2[\hat{\mathcal{W}}]$ . The vertices are connected by the diffuson propagators of the field  $\hat{\mathcal{W}}$ . Equation (204) should also contain the cross-contribution  $2\langle \mathcal{T}_1[\hat{\mathcal{W}}]\mathcal{T}_2[\hat{\mathcal{W}}] \rangle_{\mathcal{W}}$ , which vanishes, however, upon  $\hat{\mathcal{W}}$  averaging.

Differentiating each term of the (204) individually, multiplying matrices and using diffuson propagators from (188), one finds for (204)

$$\langle \delta\sigma_{\mu_1\nu_1}\delta\sigma_{\mu_2\nu_2} \rangle_{\text{dis}} = \left( \frac{4\sigma_D}{\pi V} \right)^2 \iint_{-\infty}^{+\infty} \frac{d\epsilon_1 d\epsilon_2}{[2T \cosh(\epsilon_1/2T) \cosh(\epsilon_2/2T)]^2} \sum_q \left[ |\mathcal{D}^R(\mathbf{q}, \epsilon_1 - \epsilon_2)|^2 (\delta_{\mu_1\mu_2}\delta_{\nu_1\nu_2} + \delta_{\mu_1\nu_2}\delta_{\nu_1\mu_2}) + \text{Re} [\mathcal{D}^R(\mathbf{q}, \epsilon_1 - \epsilon_2)]^2 \delta_{\mu_1\nu_1}\delta_{\mu_2\nu_2} \right]. \quad (205)$$

The first term in the square brackets of (205) corresponds to Figure 12a and the second one to Figure 12b. Introducing  $\epsilon_1 - \epsilon_2 = \omega$  and  $\epsilon_1 + \epsilon_2 = 2\epsilon$ , and integrating over  $\epsilon$ , Equation (205) may be cast into the form

$$\langle \delta\sigma_{\mu_1\nu_1}\delta\sigma_{\mu_2\nu_2} \rangle_{\text{dis}} = \sigma_1^2 (\delta_{\mu_1\mu_2}\delta_{\nu_1\nu_2} + \delta_{\mu_1\nu_2}\delta_{\nu_1\mu_2}) + \sigma_2^2 \delta_{\mu_1\nu_1}\delta_{\mu_2\nu_2}, \quad (206)$$

where

$$\sigma_1^2 = \left( \frac{4\sigma_D}{\pi V} \right)^2 \int_{-\infty}^{+\infty} \frac{d\omega}{2T} \mathcal{F}\left(\frac{\omega}{2T}\right) \sum_q \frac{1}{(Dq^2)^2 + \omega^2}, \quad (207a)$$

$$\sigma_2^2 = \left( \frac{4\sigma_D}{\pi V} \right)^2 \int_{-\infty}^{+\infty} \frac{d\omega}{2T} \mathcal{F}\left(\frac{\omega}{2T}\right) \text{Re} \sum_q \frac{1}{(Dq^2 - i\omega)^2}, \quad (207b)$$

and dimensionless function is given by  $\mathcal{F}(x) = [x \coth(x) - 1]/\sinh^2(x)$ . Here  $\sigma_1^2$  may be regarded as contribution from the mesoscopic fluctuations of the diffusion coefficient, Figure 12a, while  $\sigma_2^2$  as the corresponding contribution from the fluctuations of the density of states, Figure 12b. The fact that  $\langle \mathcal{T}_1[\hat{\mathcal{W}}]\mathcal{T}_2[\hat{\mathcal{W}}] \rangle_{\mathcal{W}} = 0$  implies that mesoscopic fluctuations of the diffusion coefficient and density of states are statistically independent. In general,  $\sigma_1^2$  and  $\sigma_2^2$  contributions are distinct. At zero temperature  $\omega \rightarrow 0$ , however, they are equal, resulting in

$$\langle \delta\sigma_{\mu_1\nu_1}\delta\sigma_{\mu_2\nu_2} \rangle = c_d \left( \frac{e^2}{2\pi\hbar} \right)^2 (\delta_{\mu_1\mu_2}\delta_{\nu_1\nu_2} + \delta_{\mu_1\nu_2}\delta_{\nu_1\mu_2} + \delta_{\mu_1\nu_1}\delta_{\mu_2\nu_2}), \quad (208)$$

where  $c_d = (4/\pi)^2 \sum_{n_\mu} (\pi n_\mu n_\mu)^{-2}$  is dimensionality- and geometry-dependent coefficient (note that in the final answer we have restored Planck's constant). This expression reflects the universality of conductance fluctuations and, of course, coincides with the result obtained originally from the impurity diagram technique [83, 87], for review see [82, 90].

### 6.6.4 Full counting statistics

When current  $I(t)$  flows in a conductor it generally fluctuates around its average value  $\langle I \rangle$ . One is often interested in calculation of the second, or even higher moments of current fluctuations. An example of this sort was already considered in the Section 5.5.2. Remarkably, in certain cases one may calculate not only a given moment of the fluctuating current, but rather restore full distribution function of current fluctuations. Theoretical approach, utilizing Keldysh technique, to the full counting statistics (FCS) of electron transport was pioneered by Levitov and Lesovik and coworkers [91, 92, 93]. In the following we consider its application to the diffusive electronic transport developed by Nazarov [94].

Consider two reservoirs, with the chemical potentials shifted by externally applied voltage  $V$ . It is assumed that reservoirs are connected to each other by diffusive quasi-one-dimensional wire of length  $L$ . The wire conductance is  $g_D = \sigma_D \mathcal{A}/L$ , with  $\mathcal{A}$  being wire cross section. Describing diffusive electron transport across the wire one starts from the disorder averaged generating function  $\mathcal{Z}[\chi] = \int \mathbf{D}[\hat{Q}] \exp(iS[\hat{Q}, A_\chi])$ . The action is given by (174), while the auxiliary vector potential  $\hat{A}_\chi$  enters the problem through the covariant derivative (175). We choose  $\hat{A}_\chi$  to be purely quantum, without classical component, as

$$\hat{A}_\chi(t) = \frac{\hat{\gamma}^q}{2L} \begin{cases} \chi & 0 < t < t_0 \\ 0 & \text{otherwise} \end{cases}. \quad (209)$$

Here the quantum Keldysh matrix  $\hat{\gamma}^q$  is given by (113) and  $\chi$  is called *counting field*. The action  $S[\hat{Q}, A_\chi]$  is accompanied by the boundary conditions on  $\hat{Q}(x)$  matrix at the ends of the wire:

$$\hat{Q}(0) = \begin{pmatrix} 1 & 2F_\epsilon \\ 0 & -1 \end{pmatrix}, \quad \hat{Q}(L) = \begin{pmatrix} 1 & 2F_{\epsilon-eV} \\ 0 & -1 \end{pmatrix}. \quad (210)$$

Knowing  $\mathcal{Z}[\chi]$  one can find then any moment  $\langle q^n \rangle$  of the number of electrons transferred between reservoirs during the time of measurement  $t_0$  via differentiation of  $\mathcal{Z}[\chi]$  with respect to the counting field  $\chi$ . The irreducible correlators are defined as  $C_1 = \langle q \rangle = q_0$  and  $C_n = \langle (q - q_0)^n \rangle$  with  $n = 2, 3, \dots$ , where  $q = \frac{1}{e} \int_0^{t_0} I(t) dt$  and  $q_0 = t_0 g_D V/e = t_0 \langle I \rangle/e$ , where  $g_D$  is the average diffusive conductance. They may be found through the expansion of the logarithm of  $\mathcal{Z}[\chi]$  in powers of the counting field

$$\ln \mathcal{Z}[\chi] = \sum_{n=0}^{\infty} \frac{(i\chi)^n}{n!} C_n. \quad (211)$$

One calculates  $\mathcal{Z}[\chi]$ , by taking the action at the saddle point  $\hat{Q} = \hat{\Lambda}_\chi$  which extremizes  $S[\hat{Q}, A_\chi]$ . The difficulty is that the action  $S[\hat{Q}, A_\chi]$  depends explicitly on the counting field  $\chi$  and solution of the corresponding saddle point equation is not know for an arbitrary  $A_\chi$ . This obstacle can be overcome by realizing that vector potential (209) is a pure gauge and it can be gauged away from the action  $S[\hat{Q}, A_\chi] \rightarrow S[\hat{Q}_\chi]$  by the transformation

$$\hat{Q}(x; t, t') = \exp\{ix\hat{A}_\chi(t)\} \hat{Q}_\chi(x; t, t') \exp\{-ix\hat{A}_\chi(t')\}. \quad (212)$$

It comes with the price though: the boundary conditions (210) change accordingly

$$\hat{Q}_\chi(0) = \hat{Q}(0), \quad \hat{Q}_\chi(L) = \exp(-i\chi\hat{\gamma}^q/2)\hat{Q}(L)\exp(i\chi\hat{\gamma}^q/2). \quad (213)$$

The advantage of this transformation is that the saddle point equation for  $\hat{Q}_\chi$ , which is nothing else but the Usadel equation (181)

$$D \frac{\partial}{\partial x} \left( \hat{Q}_\chi \circ \frac{\partial \hat{Q}_\chi}{\partial x} \right) = 0, \quad (214)$$

can be solved explicitly now. To this end, notice that  $\hat{Q}_\chi \circ \partial_x \hat{Q}_\chi = -\partial_x \hat{Q}_\chi \circ \hat{Q}_\chi = \hat{J}$  is a constant, i.e.  $x$ -independent, matrix. Since  $\hat{Q}_\chi^2 = \hat{1}$ ,  $\hat{J}$  anti-commutes with  $\hat{Q}_\chi$ , i.e.  $\hat{Q}_\chi \circ \hat{J} + \hat{J} \circ \hat{Q}_\chi = 0$ . As a

result one finds  $\hat{Q}_\chi(x) = \hat{Q}_\chi(0) \exp(\hat{J}x)$ . Putting  $x = L$  and multiplying by  $\hat{Q}_\chi(0)$  from the left, one expresses as–yet unknown matrix  $\hat{J}$  through the boundary conditions (213):  $\hat{J} = \frac{1}{L} \ln [\hat{Q}_\chi(0)\hat{Q}_\chi(L)]$ .

Having determined the saddle point configuration of the  $\hat{Q}_\chi$  matrix, for an arbitrary choice of the counting field  $\chi$ , one substitutes it back into the action  $S[\hat{Q}_\chi]$  to find the generating function

$$\ln \mathcal{Z}[\chi] = iS[\hat{Q}_\chi] = -\frac{\pi\nu D}{4} \text{Tr}\{(\partial_x \hat{Q}_\chi)^2\} = \frac{\pi\nu D}{4} \text{Tr}\{\hat{J}^2\},$$

where we used anti–commutativity relation  $\{\hat{Q}_\chi(0), \hat{J}\} = 0$ . Calculating time integrals one passes to the Wigner transform  $\iint dt dt' \rightarrow t_0 \int \frac{d\epsilon}{2\pi}$ , where  $t_0$  emerges from the integral over the central time, and finds

$$\ln \mathcal{Z}[\chi] = \frac{t_0 g_D}{8e^2} \int d\epsilon \text{Tr} \ln^2 \left[ \hat{Q}(0) \exp(-i\chi\hat{\gamma}^q/2) \hat{Q}(L) \exp(i\chi\hat{\gamma}^q/2) \right]. \quad (215)$$

In the following we analyze (215) in the zero–temperature limit,  $T = 0$ , where  $F_\epsilon = \tanh(\epsilon/2T) \rightarrow \text{sign}(\epsilon)$ . The algebra can be further significantly shortened by performing the rotation  $\hat{Q} = \hat{O}^{-1} \hat{Q} \hat{O}$  with the help of the matrix

$$\hat{O} = \frac{1}{\sqrt{2}} \begin{pmatrix} 1 & -1 \\ 1 & 1 \end{pmatrix}. \quad (216)$$

One should note also that  $\hat{O}^{-1} \exp(\pm i\chi\hat{\gamma}^q/2) \hat{O} = \exp(\pm i\chi\hat{\sigma}_z/2)$ . It is not difficult to show that for  $T = 0$  the only energy interval that contributes to the trace in (215) is that where  $0 < \epsilon < eV$ . Furthermore, at such energies rotated  $\hat{Q}$ –matrices are energy independent and given by

$$\hat{Q}(0) = \begin{pmatrix} -1 & -2 \\ 0 & 1 \end{pmatrix}, \quad \hat{Q}(L) = \begin{pmatrix} 1 & 0 \\ -2 & -1 \end{pmatrix}. \quad (217)$$

As a result, the  $\epsilon$  integration in Eq. (215) gives a factor  $eV$  and inserting  $\hat{Q}$  into  $\ln \mathcal{Z}[\chi]$  the latter reduces to

$$\ln \mathcal{Z}[\chi] = \frac{t_0 g_D V}{8e} \text{Tr} \ln^2 \begin{pmatrix} -1 + 4e^{i\chi} & 2 \\ -2e^{i\chi} & -1 \end{pmatrix}. \quad (218)$$

Since the trace is invariant with respect to the choice of the basis, it is convenient to evaluate it in the basis where matrix under the logarithm in (218) is diagonal. Solving the eigenvalue problem and calculating the trace, as the final result one finds

$$\ln \mathcal{Z}[\chi] = \frac{t_0 g_D V}{4e} \ln^2 \left[ p_\chi + \sqrt{p_\chi^2 - 1} \right], \quad p_\chi = 2e^{i\chi} - 1. \quad (219)$$

Knowing  $\ln \mathcal{Z}[\chi]$  one can extract now all the cummulants of interest by expanding in powers of  $\chi$  and employing (211), for example,  $C_1 = q_0$ ,  $C_2 = q_0/3$ ,  $C_3 = q_0/15$ , *etc.* For a review devoted to FCS see [95].

## 7 Interactions and kinetic equation for fermions

### 7.1 Interactions

Consider a liquid of electrons that interact through the instantaneous density–density interactions

$$\hat{H}_{\text{int}} = -\frac{1}{2} \iint d\mathbf{r} d\mathbf{r}' : \hat{\rho}(\mathbf{r}) U_0(\mathbf{r} - \mathbf{r}') \hat{\rho}(\mathbf{r}') :,$$

where  $\hat{\rho}(\mathbf{r}) = \hat{\psi}^\dagger(\mathbf{r}) \hat{\psi}(\mathbf{r})$  is the local density operator,  $U_0(\mathbf{r} - \mathbf{r}')$  is the bare Coulomb interaction potential and  $: \dots :$  stands for normal ordering. The corresponding Keldysh contour action has the form

$$S_{\text{int}}[\bar{\psi}, \psi] = -\frac{1}{2} \int_C dt \iint d\mathbf{r} d\mathbf{r}' \bar{\psi}(\mathbf{r}, t) \bar{\psi}(\mathbf{r}', t) U_0(\mathbf{r} - \mathbf{r}') \psi(\mathbf{r}', t) \psi(\mathbf{r}, t). \quad (220)$$

One may now perform the Hubbard–Stratonovich transformation with the help of a real boson field  $\phi(\mathbf{r}, t)$ , defined along the contour, to decouple the interaction term

$$\begin{aligned} \exp(iS_{\text{int}}[\bar{\psi}, \psi]) &= \int \mathbf{D}[\phi] \exp\left(\frac{i}{2} \int_C dt \iint d\mathbf{r} d\mathbf{r}' \phi(\mathbf{r}, t) U_0^{-1}(\mathbf{r} - \mathbf{r}') \phi(\mathbf{r}', t)\right) \\ &\quad \times \exp\left(i \int_C dt \int d\mathbf{r} \phi(\mathbf{r}, t) \bar{\psi}(\mathbf{r}, t) \psi(\mathbf{r}, t)\right), \end{aligned} \quad (221)$$

where  $U_0^{-1}$  is an inverse interaction kernel, i.e.  $\int d\mathbf{r}'' U_0(\mathbf{r} - \mathbf{r}'') U_0^{-1}(\mathbf{r}'' - \mathbf{r}') = \delta(\mathbf{r} - \mathbf{r}')$ . One may notice that the auxiliary bosonic field,  $\phi(\mathbf{r}, t)$ , enters the fermionic action in exactly the same manner as a scalar source field (112). Following (114), one introduces  $\phi^{cl(q)} \equiv (\phi_+ \pm \phi_-)/2$  and rewrites the fermion–boson interaction term as  $\bar{\psi}_a \phi^\alpha \hat{\gamma}_{ab}^\alpha \psi_b$ , where summations over  $a, b = (1, 2)$  and  $\alpha = (cl, q)$  are assumed and gamma matrices  $\hat{\gamma}^\alpha$  are defined by (113). The free bosonic term takes the form  $\frac{1}{2} \phi U_0^{-1} \phi \rightarrow \phi^\alpha U^{-1} \hat{\sigma}_x^{\alpha\beta} \phi^\beta$ . Following (221) one may integrate fermions explicitly to obtain the partition function for the interacting disordered electron liquid

$$\begin{aligned} \mathcal{Z} &= \int \mathbf{D}[\Phi] \exp(i\text{Tr}\{\vec{\Phi}^T U_0^{-1} \hat{\sigma}_x \vec{\Phi}\}) \int \mathbf{D}[\hat{Q}] \exp(iS[\hat{Q}, \Phi]), \\ iS[\hat{Q}, \Phi] &= -\frac{\pi\nu}{4\tau_{\text{el}}} \text{Tr}\{\hat{Q}^2\} + \text{Tr} \ln \left[ \hat{G}^{-1} + \frac{i}{2\tau_{\text{el}}} \hat{Q} + \hat{\Phi} + \mathbf{v}_F \hat{\mathbf{A}} \right], \end{aligned} \quad (222)$$

where we introduced doublet  $\vec{\Phi}^T = (\phi^{cl}, \phi^q)$  and matrix  $\hat{\Phi} = \phi^\alpha \hat{\gamma}^\alpha$ . This should be compared to the non–interacting version of the action given by (174). An extra complication, which stems from interactions, is an additional functional integral over the dynamic bosonic field  $\hat{\Phi}$  entering (222).

Varying the action in (222) over the  $\hat{Q}$  matrix  $\delta S[\hat{Q}, \Phi]/\delta \hat{Q} = 0$ , at zero external vector potential  $\hat{\mathbf{A}} = 0$ , one obtains the following equation for the saddle point matrix  $\underline{\hat{Q}} = \underline{\hat{Q}}[\Phi]$ :

$$\underline{\hat{Q}}_{t't'}(\mathbf{r}) = \frac{i}{\pi\nu} \left( \hat{G}^{-1} + \frac{i}{2\tau_{\text{el}}} \underline{\hat{Q}} + \hat{\Phi} \right)_{t't', \mathbf{r}\mathbf{r}}^{-1}, \quad (223)$$

which is a generalization of (162) for the interacting case. Our strategy will be to find a stationary solution of (223) for a given realization of the fluctuating bosonic field  $\hat{\Phi}$ , and then consider space– and time–dependent deviations from such a solution.

The conceptual problem here is that the saddle point Equation (223) can not be solved exactly for an arbitrary  $\hat{\Phi}(\mathbf{r}, t)$ . Note, however, that (223) can be solved for a particular case of spatially uniform realization of the boson field,  $\hat{\Phi} = \hat{\Phi}(t)$ . This is achieved with the help of the gauge transformation of the non–interacting saddle point

$$\underline{\hat{Q}}_{t't'}[\Phi(t)] = \exp\left(i \int^t dt \hat{\Phi}(t)\right) \hat{\Lambda}_{t-t'} \exp\left(-i \int^{t'} dt \hat{\Phi}(t)\right). \quad (224)$$

The validity of this solution can be verified by acting with the operator  $\hat{G}^{-1} + i/(2\tau_{\text{el}}) \underline{\hat{Q}} + \hat{\Phi}$  on both sides of (223), and utilizing the fact that  $\hat{\Lambda}_{t-t'}$  solves (223) with  $\hat{\Phi} = 0$ . We also rely on the commutativity of the vertex matrices  $[\hat{\gamma}^{cl}, \hat{\gamma}^q] = 0$ , in writing the solution in the form of (224). This example shows that a properly chosen gauge may considerably simplify the task of finding the saddle point and performing perturbative expansion around it. We show in the following that there is a particularly convenient gauge (the  $\mathcal{K}$  gauge) suited for calculations of interaction effects.

## 7.2 $\mathcal{K}$ Gauge

Let us perform a gauge transformation from the old  $\hat{Q}$  matrix to a new one, which we call  $\hat{Q}_{\mathcal{K}}$  matrix. It is defined as

$$\hat{Q}_{\mathcal{K}}(\mathbf{r}; t, t') = \exp(-i\hat{\mathcal{K}}(\mathbf{r}, t)) \hat{Q}_{t't'}(\mathbf{r}) \exp(i\hat{\mathcal{K}}(\mathbf{r}, t')), \quad (225)$$

where the matrix  $\hat{\mathcal{K}}(\mathbf{r}, t) = \mathcal{K}^\alpha(\mathbf{r}, t)\hat{\gamma}^\alpha$  is defined through two scalar fields  $\mathcal{K}^\alpha(\mathbf{r}, t)$  with  $\alpha = (cl, q)$ , which are specified below. Substituting  $\hat{\mathcal{Q}} = e^{i\hat{\mathcal{K}}}\hat{\mathcal{Q}}_{\mathcal{K}}e^{-i\hat{\mathcal{K}}}$  into the action (222) and using the invariance of the trace under a cyclic permutations, we can rewrite the action as <sup>14</sup>

$$iS[\hat{\mathcal{Q}}_{\mathcal{K}}, \Phi] = -\frac{\pi\nu}{4\tau_{\text{el}}}\text{Tr}\{\hat{\mathcal{Q}}_{\mathcal{K}}^2\} + \text{Tr}\ln\left[\hat{G}^{-1} + \hat{C} + \frac{i}{2\tau_{\text{el}}}\hat{\mathcal{Q}}_{\mathcal{K}} - \frac{1}{2m}(\partial_{\mathbf{r}}\hat{\mathcal{K}})^2\right], \quad (226)$$

where we have introduced the notation  $\hat{C}(\mathbf{r}, t) = \hat{\Phi}_{\mathcal{K}}(\mathbf{r}, t) + \mathbf{v}_F\hat{\mathbf{A}}_{\mathcal{K}}(\mathbf{r}, t)$  along with the gauge transformed electromagnetic potentials

$$\hat{\Phi}_{\mathcal{K}}(\mathbf{r}, t) = \hat{\Phi}(\mathbf{r}, t) - \partial_t\hat{\mathcal{K}}(\mathbf{r}, t), \quad \hat{\mathbf{A}}_{\mathcal{K}}(\mathbf{r}, t) = \hat{\mathbf{A}}(\mathbf{r}, t) - \partial_{\mathbf{r}}\hat{\mathcal{K}}(\mathbf{r}, t). \quad (227)$$

We assume now that the saddle point of the new field  $\hat{\mathcal{Q}}_{\mathcal{K}}$  is close to the non-interacting saddle point  $\hat{\Lambda}$ , (165), and use the freedom of choosing two fields  $\hat{\mathcal{K}}^\alpha$  to enforce it. To this end, we substitute  $\hat{\mathcal{Q}}_{\mathcal{K}} = \hat{\Lambda} + \delta\hat{\mathcal{Q}}_{\mathcal{K}}$  into (226) and expand it in powers of the deviation  $\delta\hat{\mathcal{Q}}_{\mathcal{K}}$  as well as the electromagnetic potentials, encapsulated in  $\hat{C}$ . The first non-trivial term of such an expansion is

$$iS[\delta\hat{\mathcal{Q}}_{\mathcal{K}}, \Phi] = -\frac{i}{2\tau_{\text{el}}}\text{Tr}\{\hat{\mathcal{G}}\hat{C}\hat{\mathcal{G}}\delta\hat{\mathcal{Q}}_{\mathcal{K}}\} + \dots, \quad (228)$$

where we have employed the fact that  $\hat{\Lambda}$  is the saddle point of the non-interacting model and, thus, in the absence of the electromagnetic potentials, there are no linear terms in deviations  $\delta\hat{\mathcal{Q}}_{\mathcal{K}}$ . We have also neglected the diamagnetic  $(\partial_{\mathbf{r}}\hat{\mathcal{K}})^2/2m$  term, since it is quadratic in  $\hat{\mathcal{K}}$ , and hence (as shown below) in  $\hat{\Phi}$ .

We now demand that this linear in  $\delta\hat{\mathcal{Q}}_{\mathcal{K},\mu}(\mathbf{r})$  term vanishes. Performing the Fourier transform, one notices that this takes place for an arbitrary  $\delta\hat{\mathcal{Q}}_{\mathcal{K},\epsilon,\epsilon_+}(\mathbf{q})$ , if the following matrix identity holds for any  $\epsilon, \omega$  and  $\mathbf{q}$

$$\sum_p \hat{\mathcal{G}}(\mathbf{p}_+, \epsilon_+)\hat{C}(\mathbf{q}, \omega)\hat{\mathcal{G}}(\mathbf{p}_-, \epsilon_-) = 0, \quad (229)$$

where  $\mathbf{p}_\pm = \mathbf{p} \pm \mathbf{q}/2$  and  $\epsilon_\pm = \epsilon \pm \omega/2$ . Condition (229) represents matrix equation, which expresses as-yet unspecified gauge fields  $\mathcal{K}^\alpha$  through  $\hat{\Phi}^\alpha$  and  $\mathbf{A}^\alpha$ . Employing (169), and the following identities

$$\sum_p \mathcal{G}^R(\mathbf{p}_\pm, \epsilon_\pm)\mathcal{G}^A(\mathbf{p}_\mp, \epsilon_\mp) \approx 2\pi\nu\tau_{\text{el}}, \quad (230a)$$

$$\sum_p \mathbf{v}_F \mathcal{G}^R(\mathbf{p}_\pm, \epsilon_\pm)\mathcal{G}^A(\mathbf{p}_\mp, \epsilon_\mp) \approx \mp 2\pi i\nu\tau_{\text{el}}D\mathbf{q}, \quad (230b)$$

one may transform (229) into

$$\frac{1}{\pi\nu\tau_{\text{el}}}\sum_p \hat{\mathcal{G}}(\mathbf{p}_+, \epsilon_+)\hat{C}(\mathbf{q}, \omega)\hat{\mathcal{G}}(\mathbf{p}_-, \epsilon_-) = (\hat{\gamma}^\alpha - \hat{\Lambda}_{\epsilon_+}\hat{\gamma}^\alpha\hat{\Lambda}_{\epsilon_-})\hat{\Phi}_{\mathcal{K}}^\alpha - (\hat{\Lambda}_{\epsilon_+}\hat{\gamma}^\alpha - \hat{\gamma}^\alpha\hat{\Lambda}_{\epsilon_-})D\text{div}\mathbf{A}_{\mathcal{K}}^\alpha = 0. \quad (231)$$

It is in general impossible to satisfy this condition for any  $\epsilon$  and  $\omega$  by a choice of two fields  $\mathcal{K}^\alpha(\mathbf{r}, \omega)$ . In thermal equilibrium, however, there is a ‘‘magic’’ fact that

$$\frac{1 - F_{\epsilon_+}F_{\epsilon_-}}{F_{\epsilon_+} - F_{\epsilon_-}} = \coth \frac{\omega}{2T} \equiv B_\omega, \quad (232)$$

<sup>14</sup>Deriving (226) one uses obvious equality between the traces  $\text{Tr}\{\hat{\mathcal{Q}}_{\mathcal{K}}^2\} = \text{Tr}\{\hat{\mathcal{Q}}^2\}$ . As to the logarithm term, one writes  $\text{Tr}\left\{e^{-i\hat{\mathcal{K}}}\ln\left[\hat{G}^{-1} + \hat{\Phi} + \mathbf{v}_F\hat{\mathbf{A}} + \frac{i}{2\tau_{\text{el}}}e^{i\hat{\mathcal{K}}}\hat{\mathcal{Q}}_{\mathcal{K}}e^{-i\hat{\mathcal{K}}}\right]e^{i\hat{\mathcal{K}}}\right\} = \text{Tr}\ln\left[e^{-i\hat{\mathcal{K}}}\hat{G}^{-1}e^{i\hat{\mathcal{K}}} + \hat{\Phi} + \mathbf{v}_F\hat{\mathbf{A}} + \frac{i}{2\tau_{\text{el}}}\hat{\mathcal{Q}}_{\mathcal{K}}\right]$ , where familiar algebraic identity  $\text{Tr}\{\hat{L}f(\hat{A})\hat{L}\} = \text{Tr}\{f(\hat{L}\hat{A}\hat{L}^{-1})\}$  was used, which holds for any analytic function  $f$  of matrix  $\hat{A}$ . Finally, one rewrites  $e^{-i\hat{\mathcal{K}}}\hat{G}^{-1}e^{i\hat{\mathcal{K}}} = \hat{G}^{-1} + e^{-i\hat{\mathcal{K}}}[\hat{G}^{-1}, e^{i\hat{\mathcal{K}}}]$  and calculates the commutator  $[\hat{G}^{-1}, e^{i\hat{\mathcal{K}}}] = e^{i\hat{\mathcal{K}}}\left(-\partial_t\hat{\mathcal{K}} - \mathbf{v}_F\partial_{\mathbf{r}}\hat{\mathcal{K}} - \frac{1}{2m}(\partial_{\mathbf{r}}\hat{\mathcal{K}})^2\right)$ .



which depends on  $\omega$  only, but *not* on  $\epsilon$ . This allows for the condition (231) to be satisfied if the following vector relation between the gauge transformed potentials (227) holds:

$$\vec{\Phi}_{\mathcal{K}}(\mathbf{r}, \omega) = \begin{pmatrix} 1 & 2B_\omega \\ 0 & -1 \end{pmatrix} D \operatorname{div} \vec{\mathbf{A}}_{\mathcal{K}}(\mathbf{r}, \omega). \quad (233)$$

This equation specifies the  $\mathcal{K}$ -gauge for both classical and quantum components of the electromagnetic potentials.

The advantage of the  $\mathcal{K}$  gauge is that the action does not contain terms linear in the deviations of the  $\hat{Q}_{\mathcal{K}}$  matrix from its saddle point  $\hat{\Lambda}$  and *linear* in the electromagnetic potentials. Note that there are still terms which are linear in  $\delta\hat{Q}_{\mathcal{K}}$  and quadratic in electromagnetic potentials. This means that, strictly speaking,  $\hat{\Lambda}$  is not the exact saddle point on the  $\hat{Q}_{\mathcal{K}}$  manifold for any realization of the electromagnetic potentials. However, since the deviations from the true saddle point are pushed to the second order in potentials, the  $\mathcal{K}$  gauge substantially simplifies the structure of the perturbation theory. Moreover, this state of affairs holds only in equilibrium. For out-of-equilibrium situations condition (231) cannot be identically satisfied and terms linear in  $\delta\hat{Q}_{\mathcal{K}}$  and electromagnetic fields appear in the action. As we explain below, it is precisely these terms which are responsible for the collision integral in the kinetic equation. Still the  $\mathcal{K}$  gauge is a useful concept in the out-of-equilibrium context as well. In such a case one should define the bosonic distribution function  $B_\omega$  in (233) as

$$B_\omega(\mathbf{r}, \tau) = \frac{1}{2\omega} \int_{-\infty}^{+\infty} d\epsilon [1 - F_{\epsilon+\omega/2}(\mathbf{r}, \tau) F_{\epsilon-\omega/2}(\mathbf{r}, \tau)], \quad (234)$$

where  $F_\epsilon(\mathbf{r}, \tau)$  is WT of the fermionic matrix  $F_{t,t'}(\mathbf{r})$ .

With the help of (227) the definition of the  $\mathcal{K}$  gauge (233) may be viewed as an explicit relation determining the gauge fields  $\mathcal{K}^\alpha$  through the electromagnetic potentials  $\Phi^\alpha$  and  $\mathbf{A}^\alpha$ . Taking  $\hat{\mathbf{A}} = 0$  for simplicity, one finds for the quantum and classical components of the gauge field

$$(D\partial_{\mathbf{r}}^2 - i\omega)\mathcal{K}^q(\mathbf{r}, \omega) = \Phi^q(\mathbf{r}, \omega), \quad (235a)$$

$$(D\partial_{\mathbf{r}}^2 + i\omega)\mathcal{K}^{cl}(\mathbf{r}, \omega) + 2B_\omega D\partial_{\mathbf{r}}^2 \mathcal{K}^q(\mathbf{r}, \omega) = -\Phi^{cl}(\mathbf{r}, \omega). \quad (235b)$$

In general case it is convenient to cast these relations into the matrix form

$$\vec{\mathcal{K}}(\mathbf{q}, \omega) = \hat{\mathcal{D}}^{-1}(\mathbf{q}, \omega) (\hat{\mathcal{B}}_\omega^{-1} \vec{\Phi}(\mathbf{q}, \omega) - D \hat{\sigma}_x \mathbf{q} \cdot \vec{\mathbf{A}}(\mathbf{q}, \omega)), \quad (236)$$

with the vector  $\vec{\mathcal{K}}^T = (\mathcal{K}^{cl}, \mathcal{K}^q)$ . Here we have introduced diffuson bosonic matrix propagator

$$\hat{\mathcal{D}}(\mathbf{q}, \omega) = \begin{pmatrix} \mathcal{D}^K(\mathbf{q}, \omega) & \mathcal{D}^R(\mathbf{q}, \omega) \\ \mathcal{D}^A(\mathbf{q}, \omega) & 0 \end{pmatrix}, \quad (237)$$

having matrix components

$$\mathcal{D}^{R(A)}(\mathbf{q}, \omega) = (Dq^2 \mp i\omega)^{-1}, \quad \mathcal{D}^K(\mathbf{q}, \omega) = B_\omega [\mathcal{D}^R(\mathbf{q}, \omega) - \mathcal{D}^A(\mathbf{q}, \omega)], \quad (238)$$

and

$$\hat{\mathcal{B}}_\omega = \begin{pmatrix} 2B_\omega & 1_\omega^R \\ -1_\omega^A & 0 \end{pmatrix}. \quad (239)$$

Equation (236) provides an explicit *linear* relation between the gauge fields  $\mathcal{K}^\alpha$  and the electromagnetic potentials. It thus gives an explicit definition of the gauge transformed field  $\hat{Q}_{\mathcal{K}}$ , cf. (226). The latter has the saddle point which is rather close to the non-interacting saddle point  $\hat{\Lambda}$  (with deviations being quadratic in electromagnetic fields). Returning to the original gauge, one realizes that the following  $\hat{Q}$  matrix

$$\hat{Q}_{t,t'}(\mathbf{r}) = \exp(i\mathcal{K}^\alpha(\mathbf{r}, t)\hat{\gamma}^\alpha) \hat{\Lambda}_{t-t'} \exp(-i\mathcal{K}^\beta(\mathbf{r}, t')\hat{\gamma}^\beta), \quad (240)$$

provides a good approximation for the solution of the generic saddle point Equation (223) for any given realization of the fluctuating potentials. This statement holds only for the equilibrium conditions. Away from equilibrium,  $\hat{\Phi}\delta\hat{Q}_{\mathcal{K}}$  terms reappear and have to be taken into the account to obtain the proper form of the kinetic equation (see further discussions in Section 7.5). In addition, terms  $\sim \hat{\Phi}^2\delta\hat{Q}_{\mathcal{K}}$  exist even in equilibrium. They lead to interaction corrections to the transport coefficients (details are given in Section 7.6).

### 7.3 Non-linear $\sigma$ -model for interacting systems

Performing gradient expansion for the trace of the logarithm term in (226) (this procedure is closely analogous to that presented in Section 6.2), one obtains an effective action written in terms of  $\hat{Q}_{\mathcal{K}}$  matrix field and electromagnetic potentials in the  $\mathcal{K}$  gauge

$$iS[\hat{Q}_{\mathcal{K}}, \Phi] = \frac{i\nu}{2} \text{Tr} \{ \hat{\Phi}_{\mathcal{K}} \hat{\sigma}_x \hat{\Phi}_{\mathcal{K}} \} - \frac{\pi\nu}{4} \text{Tr} \{ D(\hat{\partial}_r \hat{Q}_{\mathcal{K}})^2 - 4\partial_t \hat{Q}_{\mathcal{K}} + 4i\hat{\Phi}_{\mathcal{K}} \hat{Q}_{\mathcal{K}} \}, \quad (241)$$

where

$$\hat{\partial}_r \hat{Q}_{\mathcal{K}} = \partial_r \hat{Q}_{\mathcal{K}} - i[\hat{\mathbf{A}}_{\mathcal{K}}, \hat{Q}_{\mathcal{K}}]. \quad (242)$$

Equation (241), together with the saddle point condition (236)–(239), generalizes the effective  $\sigma$ -model action (172) to include Coulomb interaction effects. Employing the explicit form of the long covariant derivative (242), and the relation between the  $\hat{\mathcal{K}}$  and  $\hat{\Phi}$  fields at  $\hat{\mathbf{A}} = 0$  (see (235)), one finds for the partition function

$$\mathcal{Z} = \int \mathbf{D}[\Phi] \exp(i \text{Tr} \{ \vec{\Phi}^T \hat{U}_{RPA}^{-1} \vec{\Phi} \}) \int \mathbf{D}[\hat{Q}_{\mathcal{K}}] \exp(iS_0[\hat{Q}_{\mathcal{K}}] + iS_1[\hat{Q}_{\mathcal{K}}, \partial_r \mathcal{K}] + iS_2[\hat{Q}_{\mathcal{K}}, \partial_r \mathcal{K}]), \quad (243)$$

where  $S_l$ , with  $l = 0, 1, 2$  contain the  $l$ -th power of the electromagnetic potentials and are given by

$$iS_0[\hat{Q}_{\mathcal{K}}] = -\frac{\pi\nu}{4} \text{Tr} \{ D(\partial_r \hat{Q}_{\mathcal{K}})^2 - 4i\partial_t \hat{Q}_{\mathcal{K}} \}, \quad (244a)$$

$$iS_1[\hat{Q}_{\mathcal{K}}, \partial_r \mathcal{K}] = -i\pi\nu \text{Tr} \{ D(\partial_r \hat{\mathcal{K}}) \hat{Q}_{\mathcal{K}} (\partial_r \hat{Q}_{\mathcal{K}}) + \hat{\Phi}_{\mathcal{K}} \hat{Q}_{\mathcal{K}} \}, \quad (244b)$$

$$iS_2[\hat{Q}_{\mathcal{K}}, \partial_r \mathcal{K}] = \frac{\pi\nu D}{2} \text{Tr} \{ (\partial_r \hat{\mathcal{K}}) \hat{Q}_{\mathcal{K}} (\partial_r \hat{\mathcal{K}}) \hat{Q}_{\mathcal{K}} - (\partial_r \hat{\mathcal{K}}) \hat{\Lambda} (\partial_r \hat{\mathcal{K}}) \hat{\Lambda} \}. \quad (244c)$$

The effective interaction matrix  $\hat{U}_{RPA}$  is nothing but the screened interaction in the random-phase approximation (RPA)

$$\hat{U}_{RPA}(\mathbf{q}, \omega) = [U_0^{-1} \hat{\sigma}_x + \hat{\Pi}(\mathbf{q}, \omega)]^{-1}, \quad (245)$$

where  $\hat{\Pi}(\mathbf{q}, \omega)$  is the density–density correlator. According to (121) and (192) it has a typical form of a bosonic propagator in the Keldysh space

$$\hat{\Pi}(\mathbf{q}, \omega) = \begin{pmatrix} 0 & \Pi^A(\mathbf{q}, \omega) \\ \Pi^R(\mathbf{q}, \omega) & \Pi^K(\mathbf{q}, \omega) \end{pmatrix}, \quad (246)$$

with the components

$$\Pi^{R(A)}(\mathbf{q}, \omega) = \frac{\nu D q^2}{D q^2 \mp i\omega}, \quad \Pi^K(\mathbf{q}, \omega) = B_\omega [\Pi^R(\mathbf{q}, \omega) - \Pi^A(\mathbf{q}, \omega)]. \quad (247)$$

To derive (243)–(247) one has to add and subtract the term  $\text{Tr} \{ (\partial_r \hat{\mathcal{K}}) \hat{\Lambda} (\partial_r \hat{\mathcal{K}}) \hat{\Lambda} \}$ , and employ the equation

$$\int_{-\infty}^{+\infty} d\epsilon \text{Tr} \{ \hat{\gamma}^\alpha \hat{\gamma}^\beta - \hat{\gamma}^\alpha \hat{\Lambda}_{\epsilon_+} \hat{\gamma}^\beta \hat{\Lambda}_{\epsilon_-} \} = 4\omega (\hat{B}_\omega^{-1})^{\alpha\beta}, \quad (248)$$

where  $\epsilon_{\pm} = \epsilon \pm \omega/2$ , and matrices  $\hat{\Lambda}$  and  $\hat{\mathcal{B}}$  are defined by (165) and (239) correspondingly. Equation (248) is a consequence of the following integral relations between bosonic and fermionic distribution functions

$$\int_{-\infty}^{+\infty} d\epsilon (F_{\epsilon_+} - F_{\epsilon_-}) = 2\omega, \quad \int_{-\infty}^{+\infty} d\epsilon (1 - F_{\epsilon_+} F_{\epsilon_-}) = 2\omega B_{\omega}. \quad (249)$$

Equations (243)–(247) constitute an effective non-linear  $\sigma$ -model for interacting disordered Fermi liquid. The model consists of two interacting fields: the matrix field  $\hat{Q}_{\mathcal{K}}$ , obeying non-linear constraint  $\hat{Q}_{\mathcal{K}}^2 = \hat{1}$ , and the bosonic longitudinal field  $\partial_r \mathcal{K}$  (or equivalently  $\hat{\Phi}$ ). As will be apparent later,  $\hat{Q}_{\mathcal{K}}$  field describes fluctuations of the quasi-particle distribution function, whereas  $\hat{\Phi}$  (or  $\hat{\mathcal{K}}$ ) represents propagation of electromagnetic modes through the media.

## 7.4 Interaction propagators

For future applications we introduce correlation function

$$\mathcal{V}^{\alpha\beta}(\mathbf{r} - \mathbf{r}', t - t') = -2i \langle \mathcal{K}^{\alpha}(\mathbf{r}, t) \mathcal{K}^{\beta}(\mathbf{r}', t') \rangle = -2i \int \mathbf{D}[\hat{\Phi}] \mathcal{K}^{\alpha}(\mathbf{r}, t) \mathcal{K}^{\beta}(\mathbf{r}', t') \exp(i \text{Tr} \{ \vec{\Phi}^T \hat{U}_{RPA}^{-1} \vec{\Phi} \}), \quad (250)$$

where factor  $-2i$  is used for convenience. Since  $\hat{\Phi}$  and  $\hat{\mathcal{K}}$  are linearly related through (236), one may evaluate this Gaussian integral and find for the gauge field correlation function

$$\hat{\mathcal{V}}(\mathbf{q}, \omega) = \hat{\mathcal{D}}(\mathbf{q}, \omega) \hat{\mathcal{B}}_{\omega}^{-1} \hat{U}_{RPA}(\mathbf{q}, \omega) (\hat{\mathcal{B}}_{-\omega}^{-1})^T \hat{\mathcal{D}}^T(-\mathbf{q}, -\omega). \quad (251)$$

The bosonic correlation matrix  $\hat{\mathcal{V}}(\mathbf{q}, \omega)$  has the standard Keldysh structure

$$\hat{\mathcal{V}}(\mathbf{q}, \omega) = \begin{pmatrix} \mathcal{V}^K(\mathbf{q}, \omega) & \mathcal{V}^R(\mathbf{q}, \omega) \\ \mathcal{V}^A(\mathbf{q}, \omega) & 0 \end{pmatrix}, \quad (252)$$

with the elements

$$\mathcal{V}^{R(A)}(\mathbf{q}, \omega) = -\frac{1}{(Dq^2 \mp i\omega)^2} \left( U_0^{-1} + \frac{\nu D q^2}{Dq^2 \mp i\omega} \right)^{-1}, \quad (253a)$$

$$\mathcal{V}^K(\mathbf{q}, \omega) = B_{\omega} [\mathcal{V}^R(\mathbf{q}, \omega) - \mathcal{V}^A(\mathbf{q}, \omega)]. \quad (253b)$$

This propagator corresponds to the screened dynamic Coulomb interaction, dressed by the two diffusons at the vertices, Figure 13a. Thus, the role of the gauge field  $\mathcal{K}$  is to take into account automatically both the RPA-screened interactions, Figure 13b, and its vertex renormalization by the diffusons. Owing to the linear dependence between  $\hat{\Phi}$  and  $\hat{\mathcal{K}}$ , (see (236)), we use averaging over  $\hat{\Phi}$  or  $\hat{\mathcal{K}}$  fields interchangeably. The essence is that the correlator of two  $\hat{\mathcal{K}}^{\alpha}$  fields is given by (250)–(253).

## 7.5 Kinetic equation

The aim of this section is to show how the kinetic equation for the distribution function  $F$  appears naturally in the framework of the Keldysh formulation. In Section 6.4 it was demonstrated that the kinetic equation for non-interacting fermions is nothing but the saddle point equation for the effective action of the  $\hat{Q}$  matrix. In the case of interacting electrons it is obtained from the action  $S[\hat{Q}_{\mathcal{K}}, \Phi]$ , (see (241)), by first integrating out fast degrees of freedom: diffusive,  $\hat{\mathcal{W}}$ , and electromagnetic,  $\hat{\mathcal{K}}$  (or, equivalently,  $\hat{\Phi}$ ).

Let us outline the logic of the entire procedure, which leads from the partition function (243) and (244) to the kinetic equation. As the first step we separate slow and fast degrees of freedom in the action  $S_l[\hat{Q}_{\mathcal{K}}, \partial_r \mathcal{K}]$ , where  $l = 0, 1, 2$  (see (244)). The former are encoded in the distribution function  $F_{l'}(\mathbf{r})$ , while the latter are carried by diffusons  $\hat{\mathcal{W}}_{l'}(\mathbf{r})$  and electromagnetic modes  $\hat{\mathcal{K}}(\mathbf{r}, t)$ .

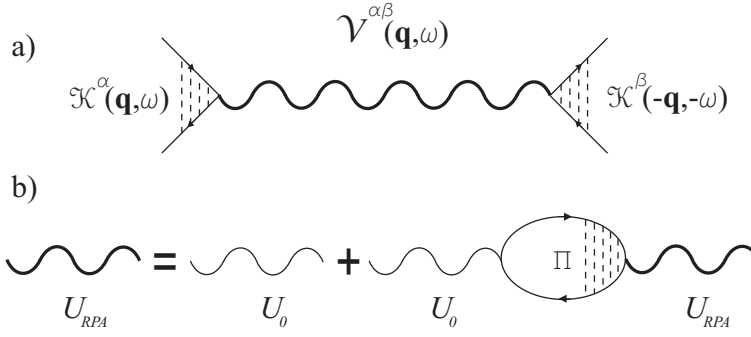

Figure 13: a) Diagrammatic representation of the gauge field propagator  $\hat{\mathcal{V}}(\mathbf{q}, \omega)$ : wavy line represents Coulomb interaction. Vertices dressed by the diffusons are shown by the ladders of dashed lines. b) Screened Coulomb interaction in RPA,  $\hat{U}_{RPA}(\mathbf{q}, \omega)$ . Bold and thin wavy lines represent screened and bare interactions correspondingly, the loop represents polarization operator dressed by the diffusion ladder.

This separation is achieved by an appropriate parametrization of the  $\hat{Q}_{\mathcal{K}}$ -matrix. One convenient choice is  $\hat{Q}_{\mathcal{K}} = \hat{\mathcal{U}}_z \circ \hat{Q}_{\text{fast}} \circ \hat{\mathcal{U}}_z^{-1}$ , where rotation matrices

$$\hat{\mathcal{U}}_z = \begin{pmatrix} 1 - F \circ Z & F \\ Z & -1 \end{pmatrix}, \quad \hat{\mathcal{U}}_z^{-1} = \begin{pmatrix} 1 & F \\ Z & -1 + Z \circ F \end{pmatrix}, \quad (254)$$

with  $A \circ B = \int dt' A_{tt'} B_{t't'}$  carry information about slow degrees of freedom, and the fast part of  $\hat{Q}_{\mathcal{K}}$  matrix is parameterized by the diffuson fields  $\hat{Q}_{\text{fast}} = \exp\{-\hat{\mathcal{W}}/2\} \circ \hat{\sigma}_z \circ \exp\{\hat{\mathcal{W}}/2\}$  (compare this parametrization with that given by (185)). In the last equation  $Z_{tt'}(\mathbf{r})$  (not to be confused with the partition function) may be thought of as the *quantum* component of the distribution function  $F_{tt'}(\mathbf{r})$ . Although  $Z_{tt'}(\mathbf{r})$  is put to zero in the end of the calculations, it was emphasized in the [96] that  $Z_{tt'}(\mathbf{r})$  must be kept explicitly in  $\hat{Q}$  parametrization to obtain the proper form of the collision integral in the kinetic equation.

As the second step, one performs integrations over  $\hat{\Phi}$  (or equivalently  $\hat{\mathcal{K}}$ , since the relation between them is fixed by (236)), and over  $\hat{\mathcal{W}}$  fields in the partition function (243), to arrive at the effective action

$$\mathcal{Z} = \int \mathbf{D}[\hat{Q}_{\mathcal{K}}, \Phi] \exp(iS[\hat{\mathcal{W}}, \partial_t \mathcal{K}]) = \int \mathbf{D}[F, Z] \exp(iS_{\text{eff}}[F, Z]). \quad (255)$$

Note that after the decomposition given by (185), with the  $\hat{\mathcal{U}}_z$  and  $\hat{\mathcal{U}}_z^{-1}$  matrices in the form of (254), one understands the functional integral over  $\hat{Q}_{\mathcal{K}}$  matrix in the (255) as taken over the independent matrix fields  $F$ ,  $Z$  and  $\hat{\mathcal{W}}$ . As a result, the effective action  $S_{\text{eff}}$  will depend on  $F$  and its quantum component  $Z$ , and possibly the classical external fields, such as, e.g., scalar or vector potentials. One then looks for the saddle point equation for the distribution function  $F$ :

$$\left. \frac{\delta S_{\text{eff}}[F, Z]}{\delta Z} \right|_{Z=0} = 0, \quad (256)$$

which is a desired kinetic equation.

Proceeding along these lines, one expands the action (244) in terms of  $F$ ,  $Z$ ,  $\hat{\mathcal{W}}$ , and electromagnetic potentials  $\Phi$  and  $\mathcal{K}$ . For the slow part of the action one finds from (244a) that  $\text{Tr}\{(\partial_t \hat{Q}_{\mathcal{K}})^2\} = 8\text{tr}\{\partial_t F_{tt'} \partial_t Z_{t't}\} + O(Z^2)$  and  $\text{Tr}\{\partial_t \hat{Q}_{\mathcal{K}}\} = 2\text{tr}\{\partial_t Z_{tt'} F_{t't} - \partial_t F_{tt'} Z_{t't}\}$ , where  $\text{tr}\{\dots\}$  denotes the spatial and time integrations only and Keldysh structure was traced out explicitly. Passing to the Wigner transform representation (182), one obtains

$$iS_0[F, Z] = 2\pi\nu \text{tr} \left\{ [D\partial_t^2 F_\epsilon(\mathbf{r}, \tau) - \partial_\tau F_\epsilon(\mathbf{r}, \tau)] Z_\epsilon(\mathbf{r}, \tau) \right\}, \quad (257)$$

where  $\tau = (t + t')/2$ . Already at this stage, differentiating  $S_0[F, Z]$  with respect to  $Z$  one recovers from (256) the non–interacting kinetic Equation (183). In a similar fashion, one finds dynamic part of the action for the fast degrees of freedom,

$$iS_0[\hat{\mathcal{W}}] = -\frac{\pi\nu}{2} \text{tr} \left\{ \bar{d}_\epsilon(\mathbf{r}, \tau) [D\partial_{\mathbf{r}}^2 - \partial_\tau] d_\epsilon(\mathbf{r}, \tau) \right\}, \quad (258)$$

which is nothing else but Wigner representation of (187).

We continue now with the coupling terms between the  $\hat{\mathcal{W}}$  and  $\Phi$  modes. For  $S_1[\hat{\mathcal{W}}, F, Z]$  part of the action, which follows from (244b) upon expansion, one obtains

$$iS_1[\hat{\mathcal{W}}, F, Z] = -i\pi\nu \text{tr} \left\{ ([F, X_+^{cl}] + X_+^q - FX_+^q F) \bar{d} + ([Z, X_-^{cl}] - X_-^q + ZFX_-^q + X_-^q FZ) d \right\}, \quad (259)$$

where

$$X_\pm^\alpha = \Phi^\alpha - \partial_t \mathcal{K}^\alpha \pm D\partial_{\mathbf{r}}^2 \mathcal{K}^\alpha. \quad (260)$$

Deriving the functional relation between  $\hat{\Phi}$  and  $\hat{\mathcal{K}}$  fields, our logic was to nullify  $S_1$  part of the action (recall (228)). This step turns out to be impossible to implement for the non–equilibrium situation. However, we may still satisfy (235a) by imposing a condition  $X_-^q = 0$ . Although the Keldysh component of (231) cannot be satisfied identically, it still makes sense to demand that  $\mathcal{K}^{cl}$  obeys the following non–equilibrium generalization of equation (235b)

$$(D\partial_{\mathbf{r}}^2 + i\omega)\mathcal{K}^{cl}(\mathbf{r}, \omega) + 2B_\omega(\mathbf{r}, \tau)D\partial_{\mathbf{r}}^2 \mathcal{K}^q(\mathbf{r}, \omega) = -\Phi^{cl}(\mathbf{r}, \omega), \quad (261)$$

where non–equilibrium bosonic distribution function is defined by (234). Note, however, that this generalization *does not* imply that linear in  $\hat{\mathcal{W}}$  (i.e. in  $d$  and  $\bar{d}$ ) terms vanish in (259). Indeed, using (235a) which relates quantum components of  $\hat{\Phi}$  and  $\hat{\mathcal{K}}$ , and (261), performing Wigner transform, one finds that  $S_1[\hat{\mathcal{W}}, F, Z]$  part of the action can be brought to the form

$$iS_1[\hat{\mathcal{W}}, F, Z] = -i\pi\nu \text{tr} \left\{ I[F]X_+^q(\mathbf{r}, \omega)\bar{d}_{\epsilon_-}(\mathbf{r}, \tau)e^{-i\omega\tau} + Z_\epsilon(\mathbf{r}, \tau)X_-^{cl}(\mathbf{r}, \omega)[d_{\epsilon_-}(\mathbf{r}, \tau) - d_{\epsilon_+}(\mathbf{r}, \tau)]e^{-i\omega\tau} \right\}, \quad (262)$$

where  $\epsilon_\pm = \epsilon \pm \omega/2$  and we have introduced functional

$$I[F] = B_\omega(\mathbf{r}, \tau)[F_{\epsilon-\omega}(\mathbf{r}, \tau) - F_\epsilon(\mathbf{r}, \tau)] + 1 - F_{\epsilon-\omega}(\mathbf{r}, \tau)F_\epsilon(\mathbf{r}, \tau). \quad (263)$$

Note that, in equilibrium,  $I[F] \equiv 0$ . In (262) one keeps an explicit  $\omega$  dependence, thus not performing expansion for small  $\omega$  as compared to  $\epsilon$  in the conventional Wigner transform sense. In addition, equation (262) should also contain terms proportional to  $FZX_-^q d$ , which will not contribute to the kinetic equation after  $\mathcal{K}$  averaging, thus omitted for brevity.

The remaining  $S_2$  part of the action (244c) is already quadratic in the fast degrees of freedom  $S_2 \propto (\partial_{\mathbf{r}}\mathcal{K})^2$ , therefore it can be taken at  $\hat{\mathcal{W}} = 0$ :

$$iS_2[F, Z] = 4\pi\nu D \text{tr} \left\{ (\partial_{\mathbf{r}}\mathcal{K}^{cl})(\partial_{\mathbf{r}}\mathcal{K}^q)Z - (\partial_{\mathbf{r}}\mathcal{K}^{cl})F(\partial_{\mathbf{r}}\mathcal{K}^q)FZ - (\partial_{\mathbf{r}}\mathcal{K}^q)(\partial_{\mathbf{r}}\mathcal{K}^{cl})Z + (\partial_{\mathbf{r}}\mathcal{K}^q)F(\partial_{\mathbf{r}}\mathcal{K}^{cl})FZ \right. \\ \left. + (\partial_{\mathbf{r}}\mathcal{K}^{cl})Z(\partial_{\mathbf{r}}\mathcal{K}^{cl})F - \frac{1}{2}(\partial_{\mathbf{r}}\mathcal{K}^{cl})(\partial_{\mathbf{r}}\mathcal{K}^{cl})FZ - \frac{1}{2}(\partial_{\mathbf{r}}\mathcal{K}^{cl})(\partial_{\mathbf{r}}\mathcal{K}^{cl})ZF \right\}. \quad (264)$$

The next step is to perform the Gaussian integration over the fast degrees of freedom: diffusons  $(d, \bar{d})$  and gauge fields  $(\mathcal{K}^{cl}, \mathcal{K}^q)$ . For  $S_1$  part of the action, employing (258) and (262) we obtain

$$\left\langle \exp(iS_0[\hat{\mathcal{W}}] + iS_1[\hat{\mathcal{W}}, F, Z]) \right\rangle_{\mathcal{W}, \mathcal{K}} = \exp(iS_{\text{eff}}^{(1)}[F, Z]), \quad (265)$$

where

$$iS_{\text{eff}}^{(1)}[F, Z] = -4i\pi\nu \text{tr} \left\{ (Dq^2)^2 [\mathcal{D}^A(\mathbf{q}, \omega)\mathcal{V}^R(\mathbf{q}, \omega) - \mathcal{D}^R(\mathbf{q}, \omega)\mathcal{V}^A(\mathbf{q}, \omega)] I[F]Z \right\}. \quad (266)$$

To derive  $S_{\text{eff}}^{(1)}$  in the form of (266), one observes that upon  $\hat{\mathcal{W}}$  integration the terms  $\text{tr}\{I[F]X_+^q\bar{d}\}$  and  $\text{tr}\{ZX_-^cl\}$  in (262) produce an effective interaction vertex between  $F$  and  $Z$ , namely:  $\langle \exp(iS_1) \rangle_{\mathcal{W}} = \exp(\text{tr}\{I[F]X_+^q\mathcal{D}^AZX_-^cl\})$ . The latter has to be averaged over  $\mathcal{K}$ , which is done observing that

$$\langle X_-^cl(\mathbf{q}, \omega)X_+^q(-\mathbf{q}, -\omega) \rangle_{\mathcal{K}} = -4D^2 \langle \partial_{\mathbf{r}}^2\mathcal{K}^cl(\mathbf{q}, \omega)\partial_{\mathbf{r}}^2\mathcal{K}^q(-\mathbf{q}, -\omega) \rangle_{\mathcal{K}} = -2i(Dq^2)^2\mathcal{V}^R(\mathbf{q}, \omega). \quad (267)$$

The last equation is a direct consequence of (260) and (261), and correlator given by (250).

For  $S_2$  part of the action, using (264), one finds

$$\langle \exp(iS_2[F, Z]) \rangle_{\mathcal{K}} = \exp(iS_{\text{eff}}^{(2)}[F, Z]), \quad (268)$$

where

$$iS_{\text{eff}}^{(2)}[F, Z] = 2i\pi\nu \text{tr} \left\{ Dq^2 [\mathcal{V}^R(\mathbf{q}, \omega) - \mathcal{V}^A(\mathbf{q}, \omega)] I[F]Z \right\}. \quad (269)$$

To derive equation (269) one has to use interaction propagators for the gauge fields (251), and adopt *quasi-equilibrium* FDT relation for the Keldysh component at coinciding arguments

$$\mathcal{V}^K(\mathbf{r}, \mathbf{r}, \tau) = B_\omega(\mathbf{r}, \tau) \sum_q [\mathcal{V}^R(\mathbf{q}, \omega) - \mathcal{V}^A(\mathbf{q}, \omega)], \quad (270)$$

which holds in the non-equilibrium conditions as long as  $F_\epsilon(\mathbf{r}, \tau)$  changes slowly on the spatial scale  $L_T = \sqrt{D/T}$  (this implies that gradient of  $F_\epsilon(\mathbf{r}, \tau)$  is small). The correction to the (270) is of the form  $\propto \omega \int d\mathbf{r}' \mathcal{D}^R(\mathbf{r} - \mathbf{r}', \omega) \partial_\tau B_\omega(\mathbf{r}', \tau) \partial_\omega \mathcal{D}^A(\mathbf{r}' - \mathbf{r})$ , see [22].

As the final step, one combines  $S_0[F, Z]$  from Eq. (257), together with  $S_{\text{eff}}^{(1),(2)}[F, Z]$  parts of the action given by Eqs. (266) and (269), and employs Eq. (256) to arrive at the kinetic equation

$$D\partial_{\mathbf{r}}^2 F_\epsilon(\mathbf{r}, \tau) - \partial_\tau F_\epsilon(\mathbf{r}, \tau) = \mathcal{I}_{\text{col}}[F], \quad (271)$$

where the collision integral is given by

$$\mathcal{I}_{\text{col}}[F] = \sum_q \int \frac{d\omega}{2\pi} \mathcal{M}(\mathbf{q}, \omega) [1 - F_{\epsilon-\omega}(\mathbf{r}, \tau) F_\epsilon(\mathbf{r}, \tau) + B_\omega(\mathbf{r}, \tau) [F_{\epsilon-\omega}(\mathbf{r}, \tau) - F_\epsilon(\mathbf{r}, \tau)]], \quad (272)$$

with the kernel

$$\mathcal{M}(\mathbf{q}, \omega) = -iDq^2 \{ [\mathcal{V}^R(\mathbf{q}, \omega) - \mathcal{V}^A(\mathbf{q}, \omega)] - 2Dq^2 [\mathcal{D}^A(\mathbf{q}, \omega)\mathcal{V}^R(\mathbf{q}, \omega) - \mathcal{D}^R(\mathbf{q}, \omega)\mathcal{V}^A(\mathbf{q}, \omega)] \}. \quad (273)$$

This equation can be simplified by noticing that the gauge field propagator  $\mathcal{V}^{R(A)}(\mathbf{q}, \omega)$  may be written in terms of the diffusons and screened RPA interactions, as  $\mathcal{V}^R(\mathbf{q}, \omega) = -[\mathcal{D}^R(\mathbf{q}, \omega)]^2 U_{RPA}^R(\mathbf{q}, \omega)$  and similarly for the advanced component, which is direct consequence of (245). Using this form of  $\mathcal{V}^{R(A)}(\mathbf{q}, \omega)$ , after some algebra the interaction kernel  $\mathcal{M}(\mathbf{q}, \omega)$  reduces to

$$\mathcal{M}(\mathbf{q}, \omega) = 2 \text{Re}[\mathcal{D}^R(\mathbf{q}, \omega)] \text{Im}[U_{RPA}^R(\mathbf{q}, \omega)]. \quad (274)$$

For the conventional choice of the fermion distribution function  $\mathbf{n}_\epsilon(\mathbf{r}, \tau) = (1 - F_\epsilon(\mathbf{r}, \tau))/2$ , one can rewrite the collision integral (272) in the usual form with "out" and "in" relaxation terms. Indeed, employing (249), one identically rewrites the right hand side of (271) as [97, 98]

$$\mathcal{I}_{\text{col}}[\mathbf{n}] = \sum_q \iint_{-\infty}^{+\infty} d\omega d\epsilon' \mathbb{K}(\mathbf{q}, \omega) [\mathbf{n}_\epsilon \mathbf{n}_{\epsilon'-\omega} (1 - \mathbf{n}_{\epsilon'}) (1 - \mathbf{n}_{\epsilon-\omega}) - \mathbf{n}_{\epsilon'} \mathbf{n}_{\epsilon-\omega} (1 - \mathbf{n}_\epsilon) (1 - \mathbf{n}_{\epsilon'-\omega})], \quad (275)$$

where collision kernel is  $\mathbb{K}(\mathbf{q}, \omega) = 2\mathcal{M}(\mathbf{q}, \omega)/\pi\omega$ .

There are several important points which has to be discussed regarding the general structure of the kinetic equation. (i) The term  $\text{tr}\{ZFX_-^qd\}$ , neglected in the (262), produces an effective vertex of the type  $\text{tr}\{I[F]X_+^q\mathcal{D}^AZFX_-^q\}$  after  $\hat{\mathcal{W}}$  integration, which indeed vanishes after  $\mathcal{K}$  averaging, since

$\langle X_{\pm}^q X_{\pm}^q \rangle_{\mathcal{X}} \equiv 0$ . Thus, it indeed does not generate any additional terms into the collision integral. (ii) Throughout the derivation of the collision integral we persistently neglected all spatial  $\partial_{\mathbf{r}} F_{\epsilon}(\mathbf{r}, \tau)$  and time  $\partial_{\tau} F_{\epsilon}(\mathbf{r}, \tau)$  derivatives of the distribution function, e.g. in (270). This is justified as long as there is a spatial scale at which  $F_{\epsilon}(\mathbf{r}, \tau)$  changes slowly. In fact, gradients of the distribution, if kept explicitly, contribute to the elastic part of the collision integral [96, 99]. (iii) We kept in the effective action only terms which are linear in the quantum component of the distribution function. There are, however, terms which are quadratic in  $Z_{\epsilon}(\mathbf{r}, \tau)$ . These terms are responsible for the fluctuations in the distribution function and lead to the so-called *stochastic kinetic equation* or, equivalently, Boltzmann–Langevin kinetic theory [46, 100, 101]. It was shown recently that Keldysh  $\sigma$ -model with retained  $Z_{\epsilon}^2(\mathbf{r}, \tau)$  terms is equivalent to the effective Boltzmann–Langevin description [102, 103]. (iv) A collision integral similar to Eq. (272) was derived within Keldysh  $\sigma$ -model formalism in [22]. However, the  $S_{\text{eff}}^{(1)}$  part of the effective action was overlooked and as a result, the obtained kernel of the collision integral turns out to be correct only in the universal limit  $U_0^{-1} \rightarrow 0$ . One finds from (274) for  $U_0^{-1} \rightarrow 0$  that  $\mathcal{M}(\mathbf{q}, \omega)$  reduces to  $\mathcal{M}(\mathbf{q}, \omega) = -\frac{2}{v} \text{Im}[\mathcal{D}^R(\mathbf{q}, \omega)]$ , which is result of [22]. (v) Finally, the present discussion can be generalized to include a spin degree of freedom. Corresponding kinetic equation and collision kernel were obtained in [104, 105].

## 7.6 Applications III: Interaction effects in disordered metals

### 7.6.1 Zero-bias anomaly

Having discussed in Section 6.6 several examples, where non-interacting version of the  $\sigma$ -model may be applied, we turn now to consideration of interaction effects. The first example of interest is the modification of the bare single particle density of states  $\nu$  of free electrons by Coulomb interactions. The question was addressed by Altshuler, Aronov and Lee [106, 107, 108]. Although in their original work only leading order interaction correction was calculated, one may extent treatment of zero-bias anomaly beyond the perturbation theory [28, 110, 111, 112]. Here we follow the sigma-model calculation of [22].

We are interested in the single-particle Green function at coinciding spatial points

$$\mathcal{G}^{ab}(t-t') = -i \langle \langle \psi_a(\mathbf{r}, t) \bar{\psi}_b(\mathbf{r}, t') \rangle \rangle, \quad (276)$$

where  $\langle \langle \dots \rangle \rangle$  denotes both the quantum and disorder averaging. One may evaluate it introducing a corresponding source term into the action which is directly coupled to the bilinear combination of the fermion operators. Following the same algebra as in the Section 6, performing Keldysh rotation and disorder averaging, one finds that this source term enters into the logarithm in (161). Differentiating the latter with respect to the source and putting it to zero, one obtains for the Green's function

$$\hat{\mathcal{G}}(t-t') = \int \mathbf{D}[\Phi] \exp(i \text{Tr} \{ \vec{\Phi}^T U_0^{-1} \hat{\sigma}_x \vec{\Phi} \}) \int \mathbf{D}[\hat{Q}] \left[ \hat{G}^{-1} + \frac{i}{2\tau_{\text{el}}} \hat{Q} + \hat{\Phi} \right]_{t', \mathbf{r}\mathbf{r}}^{-1} \exp(iS[\hat{Q}, \Phi]). \quad (277)$$

One evaluates the integral over the  $\hat{Q}$  matrix in the saddle point approximation, neglecting both the massive and the massless fluctuations around the stationary point. Then, according to (223), the pre-exponential factor is simply  $-i\pi\nu \hat{Q}_{t'}$ . At the saddle point  $\hat{Q}$  matrix is given by Eq. (240). As a result, one obtains for (277) the following representation

$$\hat{\mathcal{G}}(t-t') = -i\pi\nu \int \mathbf{D}[\Phi] \exp(i \text{Tr} \{ \vec{\Phi}^T \hat{U}_{RPA}^{-1} \vec{\Phi} \}) \exp(i\hat{\mathcal{K}}(\mathbf{r}, t)) \hat{\Lambda}_{t-t'} \exp(-i\hat{\mathcal{K}}(\mathbf{r}, t')). \quad (278)$$

Since  $\hat{\mathcal{K}}$  is the linear functional of  $\hat{\Phi}$ , given by (235), the remaining functional integral is Gaussian.

To calculate the latter, one rewrites phase factors of the gauge field as<sup>15</sup>

$$e^{\pm i\mathcal{K}^\alpha \gamma^\alpha} = \frac{1}{2} \left[ e^{\pm i(\mathcal{K}^{cl} + \mathcal{K}^g)} + e^{\pm i(\mathcal{K}^{cl} - \mathcal{K}^g)} \right] \hat{\gamma}^{cl} + \frac{1}{2} \left[ e^{\pm i(\mathcal{K}^{cl} + \mathcal{K}^g)} - e^{\pm i(\mathcal{K}^{cl} - \mathcal{K}^g)} \right] \hat{\gamma}^g. \quad (279)$$

Performing Gaussian integration in (278) with the help of (279), the result may be conveniently expressed in the form

$$\hat{\mathcal{G}}(t) = -i\pi\nu \sum_{\alpha\beta} (\hat{\gamma}^\alpha \hat{\Lambda}_t \hat{\gamma}^\beta) \mathbb{B}^{\alpha\beta}(t), \quad (280)$$

where the auxiliary propagator  $\mathbb{B}^{\alpha\beta}(t)$  has the standard bosonic structure [as in, e.g., (252)] with

$$\mathbb{B}^{R(A)}(t) = i \exp(i[\mathcal{V}^K(t) - \mathcal{V}^K(0)]/2) \sin(\mathcal{V}^{R(A)}(t)/2), \quad (281a)$$

$$\mathbb{B}^K(t) = \exp(i[\mathcal{V}^K(t) - \mathcal{V}^K(0)]/2) \cos([\mathcal{V}^R(t) - \mathcal{V}^A(t)]/2). \quad (281b)$$

The gauge fields propagator,  $\hat{\mathcal{V}}(\mathbf{r}, t)$ , defined by (252) and (253), enters (281) at coinciding spatial points

$$\hat{\mathcal{V}}(t) = \int \frac{d\omega}{2\pi} \exp(-i\omega t) \sum_q \hat{\mathcal{V}}(\mathbf{q}, \omega). \quad (282)$$

Knowledge of the Green's function (280) allows to determine the density of states according to the standard definition

$$\nu(\epsilon) = \frac{i}{2\pi} [\mathcal{G}^R(\epsilon) - \mathcal{G}^A(\epsilon)]. \quad (283)$$

In the thermal equilibrium, the Green's functions obey FDT (see (108)), which together with the relations  $\mathcal{G}^K(\epsilon) = \mathcal{G}^>(\epsilon) + \mathcal{G}^<(\epsilon)$  and  $\mathcal{G}^>(\epsilon) = -\exp(\epsilon/T)\mathcal{G}^<(\epsilon)$  allows to rewrite (283) in the equivalent form

$$\nu(\epsilon) = \frac{i}{2\pi} \mathcal{G}^>(\epsilon) [1 + \exp(-\epsilon/T)]. \quad (284)$$

Using (280) one relates greater (lesser) Green's functions  $\mathcal{G}^{>(<)}$  to the corresponding components of the auxiliary propagators  $\mathbb{B}^{>(<)}$ :

$$\mathcal{G}^{>(<)}(t) = -i\pi\nu \Lambda_t^{>(<)} \mathbb{B}^{>(<)}(t). \quad (285)$$

The latter are found explicitly to be

$$\mathbb{B}^{>(<)}(t) = \frac{1}{2} \exp \left( \int \frac{d\omega}{2\pi} \left[ \coth \frac{\omega}{2T} (1 - \cos \omega t) \pm i \sin \omega t \right] \text{Im} \sum_q \mathcal{V}^R(\mathbf{q}, \omega) \right), \quad (286)$$

where we employed (281) along with the bosonic FDT relations  $\mathbb{B}^R(t) - \mathbb{B}^A(t) = \mathbb{B}^>(t) - \mathbb{B}^<(t)$ , and  $\mathbb{B}^K(t) = \mathbb{B}^>(t) + \mathbb{B}^<(t)$ . Finally, combining (284) and (285) together, one finds for the density of states

$$\nu(\epsilon) = \frac{\nu}{\tanh(\epsilon/2T)} \int dt F_t \mathbb{B}^K(t) \exp(i\epsilon t). \quad (287)$$

Expanding (286) to the first order in the interaction,  $\mathcal{V}(\mathbf{q}, \omega)$ , and substituting into (287), one recovers Altshuler and Aronov result for the zero-bias anomaly [106].

<sup>15</sup>Equation (279) is based on the following property: consider an arbitrary function which is linear form in Pauli matrices  $f(a + \mathbf{b}\hat{\sigma})$ , where  $a$  is some arbitrary number and  $\mathbf{b}$  some vector. The observation is that  $f(a + \mathbf{b}\hat{\sigma}) = A + \mathbf{B}\hat{\sigma}$ , where  $A$  is some new number and  $\mathbf{B}$  a new vector. To see this, let us choose  $z$ -axis along the direction of the  $\mathbf{b}$  vector. Then the eigenvalues of the operator  $a + \mathbf{b}\hat{\sigma}$  are  $a \pm b$ , and corresponding eigenvalues of the operator  $f(a + \mathbf{b}\hat{\sigma})$  are  $f(a \pm b)$ . Thus one concludes that  $A = \frac{1}{2}[f(a + b) + f(a - b)]$  and  $\mathbf{B} = \frac{\mathbf{b}}{2b}[f(a + b) - f(a - b)]$ .



We restrict ourselves to the analysis of the non-perturbative result, (286) and (287), only at zero temperature. Noting that for  $T = 0$ ,  $F_t = (i\pi t)^{-1}$ , one obtains

$$\begin{aligned} \nu(\epsilon) = \frac{\nu}{\pi} \int dt \frac{\sin|\epsilon|t}{t} \exp\left(\int_0^\infty \frac{d\omega}{\pi} \operatorname{Im} \sum_q \mathcal{V}^R(\mathbf{q}, \omega)(1 - \cos \omega t)\right) \\ \times \cos\left(\int_0^\infty \frac{d\omega}{\pi} \operatorname{Im} \sum_q \mathcal{V}^R(\mathbf{q}, \omega) \sin \omega t\right). \end{aligned} \quad (288)$$

In the two-dimensional case (253) with  $U_0 = 2\pi e^2/q$  leads to

$$\int_0^{+\infty} \frac{d\omega}{\pi} \sum_q \operatorname{Im}[\mathcal{V}^R(\mathbf{q}, \omega)] \begin{pmatrix} 1 - \cos \omega t \\ \sin \omega t \end{pmatrix} = -\frac{1}{8\pi^2 g} \left\{ \frac{\ln(t/\tau_{\text{el}}) \ln(t\tau_{\text{el}}\omega_0^2) + 2\mathbb{C} \ln(t\omega_0)}{\pi \ln(t\omega_0)} \right\}, \quad (289)$$

where  $g = \nu D$  is the dimensionless conductance,  $\omega_0 = D\kappa^2$ ,  $\kappa^2 = 2\pi e^2\nu$  is the inverse Thomas-Fermi screening radius and  $\mathbb{C} = 0.577\dots$  is the Euler constant. Since the fluctuations  $\hat{\mathcal{W}}$  of the  $\hat{Q}$  matrix were neglected, while calculating functional integral in (277), the obtained result (288) does not capture corrections, which are of the order of  $\sim g^{-1} \ln(t/\tau_{\text{el}})$  (in  $d = 2$ ), see Section 7.6.2. Therefore, (288) can only be trusted for  $\epsilon$  not too small, such that  $(8\pi^2 g)^{-1} \ln(\epsilon\tau_{\text{el}})^{-1} \ll 1$ , however,  $\ln^2(t/\tau_{\text{el}})$  terms have been accounted correctly by the preceding procedure. If, in addition,  $g^{-1} \ln(\omega_0\tau_{\text{el}}) \ll 1$ , the time integral in (288) may be performed by the stationary point method, resulting in

$$\nu(\epsilon) = \nu \exp\left\{-\frac{1}{8\pi^2 g} \ln(|\epsilon|\tau_{\text{el}})^{-1} \ln(\tau_{\text{el}}\omega_0^2/|\epsilon|)\right\}. \quad (290)$$

Thus, one achieved a non-perturbative resummation of anomalously divergent,  $\propto \ln^2(\epsilon\tau_{\text{el}})$ , terms for a single-particle Green's function. The non-perturbative expression for the density of states essentially arises from the gauge non-invariance of the single-particle Green's function. The calculations above are in essence the Debye-Waller factor [109] owing to the almost pure gauge fluctuations of electric potential, cf. (278). Gauge-invariant characteristics (such as conductivity, for example) do not carry phase factors, and therefore are not affected by the interactions on this level of accuracy (fluctuations of  $\hat{Q}$  matrix should be retained, see next section).

## 7.6.2 Altshuler-Aronov correction

Here we consider yet another example where interactions are essential, namely electron-electron interactions correction  $\delta\sigma_{\text{AA}}$  to the Drude conductivity  $\sigma_D$  of the disordered metal [106, 107, 108]. In contrast to the previous example, where density of states of an interacting disordered electron liquid was considered (Section 7.6.1), the correction to the conductivity is not affected by the interactions at the level of trial saddle point  $\hat{Q}_{\mathcal{K}} = \hat{\Lambda}$  and fluctuations  $\hat{\mathcal{W}}$  must be retained. In what follows, we restrict our consideration to the lowest non-vanishing order in the expansion of the action (244) over  $\hat{\mathcal{W}}$ , (187) and (188), and identify those terms of the action which are responsible for interaction correction  $\delta\sigma_{\text{AA}}$ .

One starts from the part of the action  $S_1[\hat{Q}_{\mathcal{K}}, \partial_r \mathcal{K}]$  given by (244b). To the linear order in fluctuations  $\hat{\mathcal{W}}$  one finds

$$iS_1[\hat{\mathcal{W}}, \partial_r \mathcal{K}] = -\frac{i\pi\nu}{2} \operatorname{Tr} \left\{ \left[ D\partial_r^2 \mathcal{K}^\alpha (\hat{\Lambda} \hat{\gamma}^\alpha \hat{\Lambda} - \hat{\gamma}^\alpha) + (\Phi^\alpha - \partial_r \mathcal{K}^\alpha) (\hat{\gamma}^\alpha \hat{\Lambda} - \hat{\Lambda} \hat{\gamma}^\alpha) \right] \hat{\mathcal{W}} \right\}, \quad (291)$$

where  $\hat{\mathcal{W}} = \hat{\mathcal{U}} \circ \hat{\mathcal{W}} \circ \hat{\mathcal{U}}^{-1}$ , see (185) and (186). Note that in thermal equilibrium  $iS_1[\hat{\mathcal{W}}, \partial_r \mathcal{K}] \equiv 0$ . Indeed, the expression in the square brackets on the right-hand side of (291) coincides with (231), which was used to determine the  $\hat{\mathcal{K}}[\Phi]$  functional. In equilibrium it was possible to solve (231) by an appropriate choice of  $\hat{\mathcal{K}}[\Phi]$ , see (236). This was precisely the motivation behind looking for the

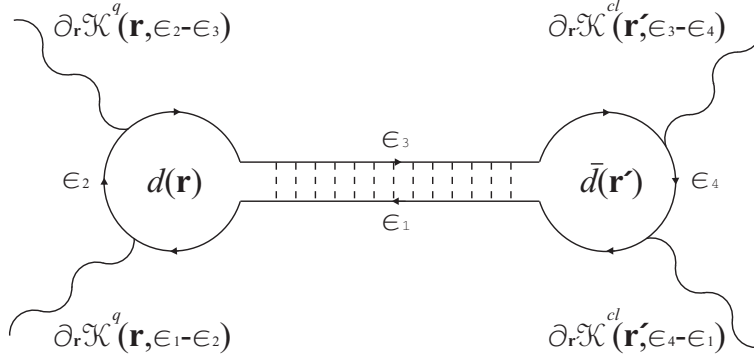

Figure 14: Diagrammatic representation of an effective four–leg vertex  $\mathbb{V}_{AA}$ , see (296), which generates Altshuler–Aronov correction to the conductivity.

saddle point for each realization of the field  $\hat{\Phi}$  to cancel terms linear in  $\hat{\mathcal{W}}$ . Since it was not possible to find the exact saddle point, such terms do appear, however, only in the second order in  $\partial_r \mathcal{K}$ . These latter terms originate from the  $S_2[\hat{\mathcal{Q}}_{\mathcal{K}}, \partial_r \mathcal{K}]$  part of the action. Expanding (244c) to the linear order in  $\hat{\mathcal{W}}$  one finds

$$\begin{aligned} iS_2[\hat{\mathcal{W}}, \partial_r \mathcal{K}] &= \frac{\pi\nu D}{2} \text{Tr} \left\{ \partial_r \mathcal{K}^\alpha(\epsilon_1 - \epsilon_2) \left[ \hat{\gamma}^\alpha \hat{\Lambda}_{\epsilon_2} \hat{\gamma}^\beta \hat{\Lambda}_{\epsilon_3} - \hat{\Lambda}_{\epsilon_1} \hat{\gamma}^\alpha \hat{\Lambda}_{\epsilon_2} \hat{\gamma}^\beta \right] \hat{\mathcal{W}}_{\epsilon_3 \epsilon_1} \partial_r \mathcal{K}^\beta(\epsilon_2 - \epsilon_3) \right\} \\ &= \pi\nu D \text{Tr} \left\{ \partial_r \vec{\mathcal{K}}^T(\epsilon_1 - \epsilon_2) \left[ M_{\epsilon_2 \epsilon_3 \epsilon_1}^d d_{\epsilon_3 \epsilon_1} + M_{\epsilon_1 \epsilon_2 \epsilon_3}^{\bar{d}} \bar{d}_{\epsilon_3 \epsilon_1} \right] \partial_r \vec{\mathcal{K}}(\epsilon_2 - \epsilon_3) \right\}, \end{aligned} \quad (292)$$

where we used notation  $\vec{\mathcal{K}}^T = (\mathcal{K}^{cl}, \mathcal{K}^q)$ , and introduced coupling matrices between diffusons  $\{d, \bar{d}\}$  and the gauge fields  $\mathcal{K}^{cl(q)}$

$$M_{\epsilon_2}^d = \begin{pmatrix} 0 & 0 \\ 0 & -2F_{\epsilon_2} \end{pmatrix}, \quad M_{\epsilon_1 \epsilon_2 \epsilon_3}^{\bar{d}} = \begin{pmatrix} 2F_{\epsilon_2} - F_{\epsilon_1} - F_{\epsilon_3} & 1 + F_{\epsilon_1} F_{\epsilon_3} - 2F_{\epsilon_2} F_{\epsilon_3} \\ -1 - F_{\epsilon_1} F_{\epsilon_3} + 2F_{\epsilon_2} F_{\epsilon_1} & F_{\epsilon_1} + F_{\epsilon_3} - 2F_{\epsilon_1} F_{\epsilon_2} F_{\epsilon_3} \end{pmatrix}. \quad (293)$$

Employing now the general expression for the conductivity (201), we show that Altshuler–Aronov interaction correction to the conductivity  $\delta\sigma_{AA}$  is obtained from (292)

$$\delta\sigma_{AA} = -\frac{e^2}{2} \lim_{\Omega \rightarrow 0} \frac{1}{\Omega} \left\langle \frac{\delta^2}{\delta(\partial_r \mathcal{K}^{cl}(\Omega)) \delta(\partial_r \mathcal{K}^q(-\Omega))} \exp(iS_2[\hat{\mathcal{W}}, \partial_r \mathcal{K}]) \right\rangle_{\mathcal{W}, \mathcal{K}}, \quad (294)$$

where the averaging goes over the diffusive modes as well as over the fluctuations of the electric potential. Note also that as compared to (201) here we perform differentiation over  $\partial_r \mathcal{K}$  and not the vector potential  $\mathbf{A}$  itself. The two definitions are the same since the vector potential and the gauge field enter the action (241) in the gauge invariant combination (227).

Having (187) and (292) we deal with a Gaussian theory of the diffuson modes  $d$  and  $\bar{d}$  fluctuations, which allows for a straightforward averaging in (294). Integrating over the diffuson modes, one finds

$$\left\langle \exp(iS_2[\hat{\mathcal{W}}, \partial_r \mathcal{K}]) \right\rangle_{\mathcal{W}} = \exp(i\mathbb{V}_{AA}[\mathcal{K}]). \quad (295)$$

This way the  $(\partial_r \mathcal{K})^4$  effective four–gauge–field vertex is generated

$$\begin{aligned} \mathbb{V}_{AA}[\mathcal{K}] &= 4\pi\nu D^2 \text{Tr} \left\{ F_{\epsilon_2} (2F_{\epsilon_4} - F_{\epsilon_1} - F_{\epsilon_3}) \partial_r \mathcal{K}^q(\mathbf{r}, \epsilon_1 - \epsilon_2) \partial_r \mathcal{K}^q(\mathbf{r}, \epsilon_2 - \epsilon_3) \right. \\ &\quad \left. \times \mathcal{D}^R(\mathbf{r} - \mathbf{r}', \epsilon_3 - \epsilon_1) \partial_{\mathbf{r}'} \mathcal{K}^{cl}(\mathbf{r}', \epsilon_3 - \epsilon_4) \partial_{\mathbf{r}'} \mathcal{K}^{cl}(\mathbf{r}', \epsilon_4 - \epsilon_1) \right\}. \end{aligned} \quad (296)$$

Its diagrammatic representation is depicted in Figure 14. This vertex originates from  $\text{Tr}\{\partial_r \mathcal{K} M^d d \partial_r \mathcal{K}\}$  and  $\text{Tr}\{\partial_r \mathcal{K} M^{\bar{d}} \bar{d} \partial_r \mathcal{K}\}$  parts of the action (292) after we pair  $d$  and  $\bar{d}$  by the diffuson propagator

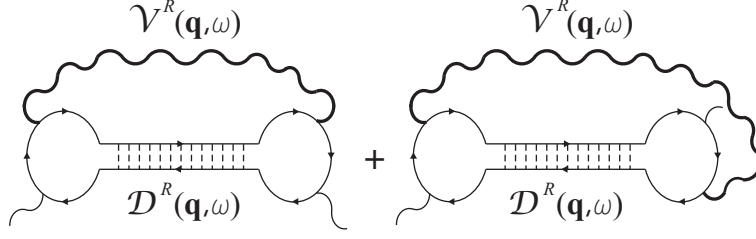

Figure 15: Diagrams for the interaction correction to the conductivity  $\delta\sigma_{AA}$ . These diagrams are constructed from the effective vertex  $\mathbb{V}_{AA}[\mathcal{K}]$  by keeping one classical and one quantum leg to be external, while connecting the remaining two by the interaction propagator  $\mathcal{V}^R(\mathbf{q}, \omega)$ .

$\langle \bar{d}d \rangle_{\mathcal{W}} \propto \mathcal{D}^A$ . The factor  $F_{e_2}$  originates from  $q - q$  element of the matrix  $M^d$ , while the combination  $2F_{e_4} - F_{e_1} - F_{e_3}$  of the distribution functions in (296) is the  $cl - cl$  element of the matrix  $M^d$ . By writing  $\mathbb{V}_{AA}[\mathcal{K}]$  in the form of (296) we kept only contributions with the lowest possible number of quantum gauge fields  $\partial_r \mathcal{K}^q$ . However, matrix  $M^d$  has all four non-zero elements, thus  $\mathbb{V}_{AA}[\mathcal{K}]$  in principle also contains contributions with four and three legs carrying the quantum gauge fields. The latter are to be employed in calculations of the corresponding interactions corrections to the shot-noise power, see [113] for details.

Having performed  $\mathcal{W}$  averaging, one brings now  $\mathbb{V}_{AA}[\mathcal{K}]$  into (294) and integrates out  $\mathcal{K}$  field. For the conductivity correction this gives

$$\delta\sigma_{AA} = 4\pi e^2 v D^2 \sum_q \iint \frac{d\epsilon d\omega}{4\pi^2} (F_{\epsilon_+} + F_{\epsilon_-}) (\partial_\epsilon F_{\epsilon_+} - \partial_\epsilon F_{\epsilon_-}) \mathcal{D}^R(\mathbf{q}, \omega) \langle \partial_r \mathcal{K}^{cl}(\mathbf{q}, \omega) \partial_r \mathcal{K}^q(-\mathbf{q}, -\omega) \rangle_{\mathcal{K}}, \quad (297)$$

where new integration variables  $\epsilon = (\epsilon_3 + \epsilon_1)/2$  and  $\omega = \epsilon_3 - \epsilon_1$  were introduced. The  $\mathcal{K}$  averaging produces two diagrams, Fig. 15, for  $\delta\sigma_{AA}$ , which follows naturally from the effective vertex shown in Figure 14, after one pairs two external legs by the interaction propagator. In the universal limit of strong interactions  $U_0^{-1} \rightarrow 0$  the propagator  $\mathcal{V}^R(\mathbf{q}, \omega)$  takes the simple form. As a result,

$$\langle \partial_r \mathcal{K}^{cl}(\mathbf{q}, \omega) \partial_r \mathcal{K}^q(-\mathbf{q}, -\omega) \rangle_{\mathcal{K}} = \frac{iq^2}{2} \mathcal{V}^R(\mathbf{q}, \omega) = -\frac{i}{2vD} \frac{1}{Dq^2 - i\omega}, \quad (298)$$

which follows from (251) and (253). Inserting (298) into Eq. (297) and carrying  $\epsilon$  integration one finds

$$\frac{\delta\sigma_{AA}}{\sigma_D} = \frac{2i}{\pi v} \sum_q \int d\omega \frac{\partial}{\partial\omega} \left[ \omega \coth \frac{\omega}{2T} \right] \frac{1}{(Dq^2 - i\omega)^2}. \quad (299)$$

In two dimensions this expression leads to the logarithmically divergent negative correction to the conductivity:  $\delta\sigma_{AA} = -\frac{e^2}{2\pi^2} \ln(1/T\tau_{el})$ , where the elastic scattering rate  $\tau_{el}^{-1}$  enters as an upper cutoff in the integral over the frequency  $\omega$ . A detailed review of the effects of the interaction corrections on disordered conductors can be found in [108], see also [96].

### 7.6.3 Relaxation rate

Kinetic equation discussed in Section 7.5 may be used to find energy relaxation rate [98, 108, 114, 115]. Focusing on the "out" term of the collision integral in (275), one may introduce the out relaxation rate for an electron of energy  $\epsilon$ , as

$$\frac{1}{\tau_{out}(\epsilon)} = - \sum_q \int d\omega d\epsilon' \mathbb{K}(\mathbf{q}, \omega) \mathbf{n}_F(\epsilon) [1 - \mathbf{n}_F(\epsilon - \omega)] \mathbf{n}_F(\epsilon') [1 - \mathbf{n}_F(\epsilon + \omega)], \quad (300)$$

where all electron distributions were substituted by Fermi functions. This is appropriate if one is interested in small (linear) deviations of  $\mathbf{n}_e$  from its equilibrium value  $\mathbf{n}_F(\epsilon)$ . Equation (300) simplifies considerably at zero temperature,  $T = 0$ . Indeed, Fermi distribution functions limit energy integration to two ranges  $-\omega < \epsilon' < 0$  and  $0 < \omega < \epsilon$ , where the product of all occupation numbers is just unity. In the universal limit of strong interactions,  $U_0^{-1} \rightarrow 0$ , the kernel acquires a form, see Eq. (274)

$$\mathbb{K}(\mathbf{q}, \omega) = -\frac{4}{\pi v} \frac{1}{(Dq^2)^2 + \omega^2}. \quad (301)$$

Inserting  $\mathbb{K}(\mathbf{q}, \omega)$  into (300), one finds for the out relaxation rate the following expression

$$\frac{1}{\tau_{\text{out}}(\epsilon)} = \frac{4}{\pi v} \sum_q \int_0^{|\epsilon|} d\omega \int_{-\omega}^0 d\epsilon' \frac{1}{(Dq^2)^2 + \omega^2} = \frac{|\epsilon|}{4\pi g}, \quad (302)$$

where  $g = vD$  and momentum integral was performed for the two-dimensional case. For an arbitrary dimensionality  $d$ , out rate scales with energy as  $\tau_{\text{out}}^{-1}(\epsilon) \propto (1/v_d)(\epsilon/D)^{d/2}$ , see [108] for further details.

### 7.6.4 Third order drag effect

Discussing Coulomb drag in Section 5.5.3 it was emphasized that the effect appears already in the second order in inter-circuit interactions and the particle-hole asymmetry is crucial. In the linear response at small temperatures the drag conductance appears to be quadratic in temperature, see (155). Here we discuss the third order in the inter-layer interaction contribution to the drag conductance. Although, being subleading in the interaction strength, it does not rely on the electron-hole asymmetry (in bulk systems the latter is due to the curvature of dispersion relation near the Fermi energy and thus very small). We show that such a third order drag is temperature independent and thus may be a dominant effect at small enough temperatures [116]. Technically the third-order contributions originate from the four-leg vertices (see Figure 14 and corresponding (296)), which describe induced non-linear interactions of electromagnetic fields through excitations of electron-hole pairs in each of the layers.

Following [116] we consider two-dimensional electron gas bilayer and apply NLSM to calculate the drag conductivity. From the general expression (201) with the help of (296) one defines drag conductivity as

$$\sigma_{\text{drag}} = -\frac{e^2}{2} \lim_{\Omega \rightarrow 0} \frac{1}{\Omega} \left\langle \frac{\delta \nabla_{\text{AA}}[\mathcal{K}]}{\delta(\partial_r \mathcal{K}_1^{cl}(\Omega))} \frac{\delta \nabla_{\text{AA}}[\mathcal{K}]}{\delta(\partial_r \mathcal{K}_2^q(-\Omega))} \right\rangle_{\mathcal{K}}, \quad (303)$$

where indices 1, 2 refer to the drive and dragged layers, respectively, following notations of Section 5.5.3. The averaging over the fluctuating gauge field  $\mathcal{K}$  is performed with the help of the correlation function

$$\mathcal{V}_{ab}^R(\mathbf{q}, \omega) = 2i \langle \mathcal{K}_a^{cl}(\mathbf{q}, \omega) \mathcal{K}_b^q(-\mathbf{q}, -\omega) \rangle_{\mathcal{K}} = \frac{q^2 U_{ab}^R(\mathbf{q}, \omega)}{(D_a q^2 - i\omega)(D_b q^2 - i\omega)}, \quad (304)$$

where  $a, b = (1, 2)$  and  $U_{ab}^R(\mathbf{q}, \omega)$  is  $2 \times 2$  matrix of retarded screened intra- and inter-layer interactions calculated within RPA. It is a solution of the following matrix Dyson equation,  $\hat{U}^R = \hat{U}_0 + \hat{U}_0 \hat{\Pi}^R \hat{U}^R$ , where

$$\hat{U}_0 = \frac{2\pi e^2}{q} \begin{pmatrix} 1 & e^{-qd} \\ e^{-qd} & 1 \end{pmatrix}, \quad \hat{\Pi}^R = \begin{pmatrix} \frac{\nu_1 D_1 q^2}{D_1 q^2 - i\omega} & 0 \\ 0 & \frac{\nu_2 D_2 q^2}{D_2 q^2 - i\omega} \end{pmatrix}. \quad (305)$$

Off-diagonal components of  $\hat{U}_0$  matrix represent bare Coulomb interaction between the layers, where  $d$  is the inter-layer spacing. Note also that the polarization operator matrix  $\hat{\Pi}^R(\mathbf{q}, \omega)$  is diagonal, reflecting the absence of tunneling between the layers.

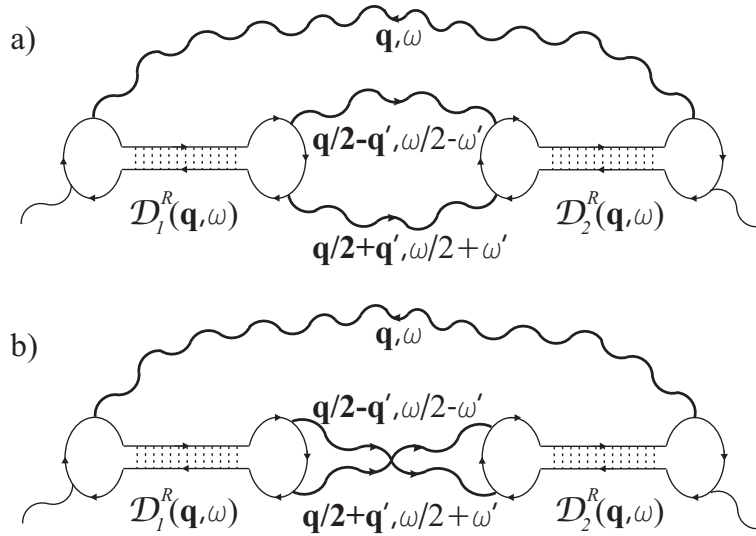

Figure 16: Two diagrams for the drag conductivity  $\sigma_{\text{drag}}$  in the third order in the inter-layer interactions,  $\mathcal{V}_{12}^R(\mathbf{q}, \omega)$ , denoted by wavy lines. The intra-layer diffusion propagators  $\mathcal{D}_a^R(\mathbf{q}, \omega) = (D_a q^2 - i\omega)^{-1}$  are denoted by ladders.

We are now on the position to evaluate the third-order drag conductivity. Inserting (296) into (303) and performing averaging with the help of (305), one finds the following expression for drag conductivity

$$\begin{aligned} \sigma_{\text{drag}} &= 32e^2 T v_1 v_2 D_1^2 D_2^2 \int_0^\infty \frac{d\omega d\omega'}{4\pi^2} \mathcal{H}_1(\omega, \omega') \mathcal{H}_2(\omega, \omega') \\ &\times \sum_{\mathbf{q}, \mathbf{q}'} \text{Im} \left[ \mathcal{D}_1^R(\mathbf{q}, \omega) \mathcal{D}_2^R(\mathbf{q}, \omega) \mathcal{V}_{12}^R(\mathbf{q}, \omega) \mathcal{V}_{12}^R\left(\frac{\mathbf{q}}{2} - \mathbf{q}', \frac{\omega}{2} - \omega'\right) \mathcal{V}_{12}^R\left(\frac{\mathbf{q}}{2} + \mathbf{q}', \frac{\omega}{2} + \omega'\right) \right]. \end{aligned} \quad (306)$$

The two functions  $\mathcal{H}_1(\omega, \Omega)$  and  $\mathcal{H}_2(\omega, \Omega)$  originate from the integration over the fast electronic energy  $\varepsilon$ , Figure 15, in the active and passive layers, respectively. In the dc limit they are given by

$$\mathcal{H}_1(\omega, \omega') = 2 - \mathcal{B}(\omega' + \omega/2) - \mathcal{B}(\omega' - \omega/2) + \mathcal{B}(\omega), \quad (307a)$$

$$\mathcal{H}_2(\omega, \omega') = T \frac{\partial}{\partial \omega'} [\mathcal{B}(\omega' + \omega/2) - \mathcal{B}(\omega' - \omega/2)], \quad (307b)$$

$$\mathcal{B}(\omega) = \frac{\omega}{T} \coth\left(\frac{\omega}{2T}\right). \quad (307c)$$

The corresponding diagrams are constructed from the two vertices of Figure 14: one for each of the layers, see Figure 16. It turns out that there are only two ways to connect them, using the propagators  $\mathcal{V}_{ab}(\mathbf{q}, \omega)$ , since  $\langle \mathcal{K}_a^q \mathcal{K}_b^q \rangle = 0$ .

In the following we assume identical layers and consider the experimentally most relevant case of the long-ranged coupling, where  $\kappa d \gg 1$ . Here  $\kappa = 2\pi e^2 v$  is the Thomas-Fermi inverse screening radius. In this limit the effective interlayer interaction potential, Eqs. (304), acquires a simple form

$$\mathcal{V}_{12}^R(\mathbf{q}, \omega) = \frac{1}{g} \frac{1}{\kappa d D q^2 - 2i\omega}, \quad (308)$$

where  $g = \nu D$ . Next, we substitute  $\mathcal{D}^R(\mathbf{q}, \omega)$  along with (307) and (308) into (306) and perform the energy and momentum integrations. Inspection of the integrals shows that both energies  $\omega$  and  $\omega'$

are of the order of the temperature  $\omega \sim \omega' \sim T$ . On the other hand, the characteristic value of the transferred momenta is  $q \sim q' \sim \sqrt{T/(D\kappa d)} \ll \sqrt{T/D}$ , cf. (308). Therefore, we may disregard  $Dq^2$  in comparison with  $i\omega$  in the expressions for  $\mathcal{D}_a^R(\mathbf{q}, \omega)$ , approximating the product  $\mathcal{D}_1^R \mathcal{D}_2^R$  in (306) by  $-\omega^{-2}$ . Such a scale separation implies that the four-leg vertices are effectively spatially local, while the three inter-layer interaction lines are long-ranged.

Rescaling energies by  $T$  and momenta by  $\sqrt{T/(D\kappa d)}$ , one may reduce expression (306) for the drag conductivity to  $\sigma_{\text{drag}} = R_Q^{-1} g^{-1} (\kappa d)^{-2} \times$  (dimensionless integral). The latter integral does not contain any parameters, and may be evaluated numerically [116]. In the limit  $\sigma_{\text{drag}} \ll g/R_Q$  the drag resistance  $\rho_{\text{drag}}$  is given by  $\rho_{\text{drag}} = \sigma_{\text{drag}} R_Q^2 / g^2$ , resulting finally in  $\rho_{\text{drag}} \approx 0.27 R_Q g^{-3} (1/\kappa d)^2$ . This is the temperature-independent drag resistivity, which may be larger than the second order (in the inter-layer interactions) contribution. The latter goes to zero at small temperatures as  $T^2$ . Further details and discussions can be found in [116].

## 8 Superconducting correlations

### 8.1 Generalization of the $\sigma$ -model

So far we have been discussing the *unitary* version of Keldysh  $\sigma$ -model, i.e. the one, where the time-reversal symmetry was supposed to be broken by, e.g., external magnetic field. We now switch to the *orthogonal* symmetry class, with the unbroken time-reversal invariance. The case in point is superconducting fluctuations in disordered metals. The Keldysh sigma-model, generalized for the disordered superconductors was developed by Feigel'man, Larkin and Skvortsov [24, 117]. It is also applicable for treating weak-localization effects in normal metals.

We proceed to describe disordered superconductors by adding the BCS term to the Hamiltonian of a metal

$$\hat{H}_{\text{BCS}} = -\frac{\lambda}{v} \int d\mathbf{r} \hat{\psi}_{\uparrow}^{\dagger}(\mathbf{r}) \hat{\psi}_{\downarrow}^{\dagger}(\mathbf{r}) \hat{\psi}_{\downarrow}(\mathbf{r}) \hat{\psi}_{\uparrow}(\mathbf{r}),$$

which corresponds to the short-range attraction in the particle-particle (Cooper) channel mediated by electron-phonon interactions, where  $\lambda$  is dimensionless coupling constant. In a standard way  $\hat{H}_{\text{BCS}}$  translates into the Keldysh action

$$S_{\text{BCS}} = \frac{\lambda}{v} \int_C dt \int d\mathbf{r} \bar{\psi}_{\uparrow}(\mathbf{r}, t) \bar{\psi}_{\downarrow}(\mathbf{r}, t) \psi_{\downarrow}(\mathbf{r}, t) \psi_{\uparrow}(\mathbf{r}, t),$$

where the time integral is calculated along the Keldysh contour. This four-fermion interaction term may be decoupled via Hubbard-Stratonovich transformation, by introducing an auxiliary functional integral over the complex field  $\Delta(\mathbf{r}, t)$ :

$$\exp(iS_{\text{BCS}}) = \int \mathbf{D}[\Delta] \exp\left(i \int dx \left[ -\frac{\nu}{\lambda} |\Delta(x)|^2 + \Delta(x) \bar{\psi}_{\uparrow}(x) \bar{\psi}_{\downarrow}(x) + \Delta^*(x) \psi_{\downarrow}(x) \psi_{\uparrow}(x) \right]\right), \quad (309)$$

here  $x = (\mathbf{r}, t)$  and  $\int dx = \int_C dt \int d\mathbf{r}$ . To make further notations compact it is convenient to introduce a bispinor fermionic vectors  $\Psi = 1/\sqrt{2}(\psi_{\uparrow}, \psi_{\downarrow}, \bar{\psi}_{\downarrow}, -\bar{\psi}_{\uparrow})^T$  and  $\Psi^+ = 1/\sqrt{2}(\bar{\psi}_{\uparrow}, \bar{\psi}_{\downarrow}, -\psi_{\downarrow}, \psi_{\uparrow})$  defined in the four-dimensional space  $\Omega$ , which can be viewed as the direct product  $S \otimes T$  of the spin  $(\psi_{\uparrow}, \psi_{\downarrow})$  and time-reversal spaces  $(\psi, \bar{\psi})$ . In principle, choice of the bispinors is not unique. One can rearrange components of the bispinors in a different manner, separating explicitly the Gor'kov-Nambu [118, 119] ( $N$ )  $(\psi_{\uparrow}, \bar{\psi}_{\downarrow})$  and spin spaces. Finally one may equally think of  $\Psi$  as acting in the direct product of the Nambu and time-reversal subspaces. These three representations are equivalent  $\Omega = S \otimes T \propto N \otimes S \propto N \otimes T$  and the choice between them is dictated by convenience in calculations for a particular problem at hand. In most cases we use  $N \otimes S$  choice and omit the  $S$  part, since the theory is diagonal in spin subspace. Vectors  $\Psi$  and  $\Psi^+$  are not independent and related to each other  $\Psi^+ = (\check{C}\Psi)^T$ , by the charge-conjugation matrix  $\check{C} \equiv i\hat{\tau}_y \otimes \hat{s}_x$ , where  $\hat{\tau}_i$  and  $\hat{s}_i$ , for  $i = 0, x, y, z$ ,

are Pauli matrices acting in the Nambu and spin subspaces, respectively;  $\hat{\sigma}_i$  matrices, as before, act in the Keldysh sub-space. To avoid confusions, we shall specify, where appropriate, Keldysh and Nambu sub-spaces by subscripts  $K$  and  $N$  correspondingly.

After the Hubbard–Stratonovich transformation (309), along with the standard treatment of disorder and Coulomb interactions, the action appears to be quadratic in fermion operators. Performing thus Gaussian Grassmann integration, one obtains for the disordered averaged partition function

$$\mathcal{Z} = \int \mathbf{D}[\Phi, \Delta] \exp\left(\frac{i}{2}\text{Tr}\{\check{\Phi}U_0^{-1}\check{Y}\check{\Phi}\} - \frac{i\nu}{2\lambda}\text{Tr}\{\check{\Delta}^\dagger\check{Y}\check{\Delta}\}\right) \int \mathbf{D}[\check{Q}] \exp(iS[\check{Q}, \Delta, \mathbf{A}, \Phi]),$$

$$iS[\check{Q}, \Delta, \mathbf{A}, \Phi] = -\frac{\pi\nu}{4\tau_{\text{el}}}\text{Tr}\{\check{Q}^2\} + \text{Tr} \ln \left[ \check{G}^{-1} + \frac{i}{2\tau_{\text{el}}}\check{Q} + \check{\Phi} + \mathbf{v}_F\check{\Xi}\check{\mathbf{A}} + \check{\Delta} \right], \quad (310)$$

which generalizes (222). In the last equation and throughout the rest of this chapter we use the check symbol  $\check{O}$  to denote  $4 \times 4$  matrices acting in the  $K \otimes N$  space, while hat symbol  $\hat{O}$  for the  $2 \times 2$  matrices acting in Nambu and Keldysh subspaces. Equation (310) contains matrices  $\check{Y} = \hat{\sigma}_x \otimes \hat{\tau}_0$ ,  $\check{\Xi} = \hat{\sigma}_0 \otimes \hat{\tau}_z$ ,  $\check{G}^{-1} = i\check{\Xi}\partial_t + \partial_r^2/2m + \mu$ , and matrix fields

$$\check{\Phi}(\mathbf{r}, t) = [\Phi^{cl}(\mathbf{r}, t)\hat{\sigma}_0 + \Phi^q(\mathbf{r}, t)\hat{\sigma}_x] \otimes \hat{\tau}_0, \quad \check{\mathbf{A}}(\mathbf{r}, t) = [\mathbf{A}^{cl}(\mathbf{r}, t)\hat{\sigma}_0 + \mathbf{A}^q(\mathbf{r}, t)\hat{\sigma}_x] \otimes \hat{\tau}_0,$$

$$\check{\Delta}(\mathbf{r}, t) = [\Delta^{cl}(\mathbf{r}, t)\hat{\sigma}_0 + \Delta^q(\mathbf{r}, t)\hat{\sigma}_x] \otimes \hat{\tau}_+ - [\Delta^{*cl}(\mathbf{r}, t)\hat{\sigma}_0 + \Delta^{*q}(\mathbf{r}, t)\hat{\sigma}_x] \otimes \hat{\tau}_-, \quad (311)$$

with  $\hat{\tau}_\pm = (\hat{\tau}_x \pm i\hat{\tau}_y)/2$ ;  $\check{Q}$  matrix also has  $4 \times 4$  structure in Keldysh and Nambu spaces along with the matrix structure in the time domain.

We next perform the gauge transformation in (310) with the help of  $\mathcal{K}^{cl(q)}(\mathbf{r}, t)$  fields, as in<sup>16</sup> (225), and expand the logarithm under the trace operation in gradients of  $\check{Q}_{\mathcal{K}}$  matrix (similar to the calculation presented in Section 6). As a result, one obtains the action of disordered superconductors in the following form

$$S[\check{Q}, \Delta, \mathbf{A}, \Phi] = S_\Delta + S_\Phi + S_\sigma, \quad (312a)$$

$$S_\Delta = -\frac{\nu}{2\lambda}\text{Tr}\{\check{\Delta}_{\mathcal{K}}^\dagger\check{Y}\check{\Delta}_{\mathcal{K}}\}, \quad S_\Phi = \frac{\nu}{2}\text{Tr}\{\check{\Phi}_{\mathcal{K}}\check{Y}\check{\Phi}_{\mathcal{K}}\}, \quad (312b)$$

$$S_\sigma = \frac{i\pi\nu}{4}\text{Tr}\{D(\hat{\partial}_r\check{Q}_{\mathcal{K}})^2 - 4\check{\Xi}\partial_t\check{Q}_{\mathcal{K}} + 4i\check{\Phi}_{\mathcal{K}}\check{Q}_{\mathcal{K}} + 4i\check{\Delta}_{\mathcal{K}}\check{Q}_{\mathcal{K}}\}. \quad (312c)$$

Here gauged electromagnetic potentials  $\check{\Phi}_{\mathcal{K}}$  and  $\check{\mathbf{A}}_{\mathcal{K}}$  are related to the bare ones  $\check{\Phi}$  and  $\check{\mathbf{A}}$  by (227), while the gauged order parameter field is given by

$$\check{\Delta}_{\mathcal{K}}(\mathbf{r}, t) = \exp\left(-i\check{\Xi}\check{\mathcal{K}}(\mathbf{r}, t)\right)\check{\Delta}(\mathbf{r}, t)\exp\left(i\check{\mathcal{K}}(\mathbf{r}, t)\check{\Xi}\right). \quad (313)$$

As compared with (242) the covariant spatial derivative in (312c) contains an extra  $\check{\Xi}$  matrix due to Nambu structure, i.e.

$$\hat{\partial}_r\check{Q}_{\mathcal{K}} = \partial_r\check{Q}_{\mathcal{K}} - i[\check{\Xi}\check{\mathbf{A}}_{\mathcal{K}}, \check{Q}_{\mathcal{K}}]. \quad (314)$$

Varying the action (312) with respect to  $\check{Q}_{\mathcal{K}}$ , under the constraint  $\check{Q}_{\mathcal{K}}^2 = \check{\mathbb{1}}$ , yields the saddle point equation

$$\hat{\partial}_r(D\check{Q}_{\mathcal{K}} \circ \hat{\partial}_r\check{Q}_{\mathcal{K}}) - \{\check{\Xi}\partial_t, \check{Q}_{\mathcal{K}}\}_+ + i[\check{\Phi}_{\mathcal{K}} + \check{\Delta}_{\mathcal{K}}, \check{Q}_{\mathcal{K}}] = 0, \quad (315)$$

which for  $\check{\mathcal{K}} = 0$  coincides with the dynamic Usadel equation [39]. The classical solution of this equation is to be sought in the form

$$\check{Q}_{\mathcal{K}} = \begin{pmatrix} \hat{Q}_{\mathcal{K}}^R & \hat{Q}_{\mathcal{K}}^K \\ 0 & \hat{Q}_{\mathcal{K}}^A \end{pmatrix}_K, \quad (316)$$

with retarded, advanced and Keldysh components being matrices in Nambu subspace.

<sup>16</sup>In the superconducting case the gauge transformation contains phase factors  $\exp(\pm i\check{\Xi}\check{\mathcal{K}})$ , which is different from (225) by an extra matrix  $\check{\Xi}$  in the exponential.

Varying the action with respect to the quantum component  $\Delta^{*q}(\mathbf{r}, t)$  of the order parameter field, one finds the self-consistency equation for the classical component of the order parameter

$$\Delta_{\mathcal{K}}^{cl}(\mathbf{r}, t) = \pi\lambda\text{Tr}\{(\hat{\sigma}_x \otimes \hat{\tau}_-)\check{Q}_{\mathcal{K}}\}. \quad (317)$$

Finally, varying the action with respect to the quantum components  $\Phi^q$  and  $\mathbf{A}^q$  of the electromagnetic potentials one obtains set of Maxwell equations, which together with the dynamic Usadel equation (315) and self-consistency condition (317) represent the closed system of equations governing dynamics of the superconductor.

In the generalized  $\sigma$ -model action (312), and subsequent dynamical equations for  $\check{Q}_{tr}(\mathbf{r})$  and  $\check{\Delta}(\mathbf{r}, t)$ , all the relevant low-energy excitations have been kept indiscriminately. The price one pays for this is the technical complexity of the theory. In many practical cases this exhaustive description is excessive and the theory may be significantly simplified. For example, one often considers a superconductor in the deep superconducting state  $T \rightarrow 0$ , with well defined gap  $|\Delta|$ , and studies dynamical responses when perturbing frequency  $\omega$  of the external field is small  $\omega \ll |\Delta|$ , thus dealing with the quasi-stationary conditions. For this case quasiclassical kinetic equations of superconductor can be derived from (315). As an alternative, one may consider temperature range in the vicinity of the transition  $|T - T_c| \ll T_c$ , where the order parameter is small  $|\Delta| \ll T_c$ , and develop an effective theory of the  $\Delta(\mathbf{r}, t)$  dynamics, i.e Ginzburg-Landau theory. Both approximations follow naturally from the general  $\sigma$ -model theory and will be considered in the next sections.

## 8.2 Quasiclassical approximation

In the superconducting state, choosing an optimal gauge field  $\vec{\mathcal{K}}(\mathbf{r}, \epsilon)$  that is valid in the whole energy range is a complicated task. However, it had been shown in the [120] that in the deep subgap limit ( $\epsilon \ll |\Delta|$ ) the effect of the electric potential on the quasiclassical Green's function  $\check{Q}$  is small in the parameter  $\epsilon/|\Delta| \ll 1$  and hence as an approximation one may set  $\vec{\mathcal{K}}(\mathbf{r}, \epsilon) = 0$ . This assumption will be used below <sup>17</sup>.

In a spatially uniform, equilibrium superconductor the saddle point Usadel equation is solved by the the following  $\check{Q}$ -matrix

$$\hat{Q}^{R(A)}(\epsilon) = \pm \frac{1}{\sqrt{(\epsilon \pm i0)^2 - |\Delta|^2}} \begin{pmatrix} \epsilon & \Delta \\ -\Delta^* & -\epsilon \end{pmatrix}_N, \quad (318)$$

while  $\hat{Q}^K = \tanh \frac{\epsilon}{2T}(\hat{Q}^R - \hat{Q}^A)$ . We have suppressed superscript  $cl$ , writing the order parameter as  $\Delta$  (its quantum component will not appear within this section). Substituting (318) into the self-consistency condition (317), one obtains the standard BCS gap equation

$$\Delta = \lambda\Delta \int_{|\Delta|}^{\omega_D} \frac{d\epsilon}{\sqrt{\epsilon^2 - |\Delta|^2}} \tanh \frac{\epsilon}{2T}, \quad (319)$$

which has a non-zero solution for  $|\Delta|$  below a critical temperature  $T_c$ .

In presence of boundaries or proximity to a normal metal one faces the problem of spatially non-uniform superconductivity. In this case, both  $\Delta$  and  $\hat{Q}^{R(A)}$  acquire a coordinate dependence and one should look for a solution of (315) and (317). In doing so, we will assume that  $\check{Q}_{tr}$  is static, i.e. independent of the central time and pass to the Wigner transform representation. From the retarded block of the  $4 \times 4$  matrix Usadel equation at  $\Phi = 0$  and  $\mathbf{A} = 0$  we obtain

$$\partial_{\mathbf{r}}(D \hat{Q}^R \partial_{\mathbf{r}} \hat{Q}^R) + i\epsilon[\hat{\tau}_z, \hat{Q}^R] + i[\hat{\Delta}, \hat{Q}^R] = 0. \quad (320)$$

With the similar equation for the advanced block of the matrix Usadel Equation (315). The Keldysh sector provides another equation, which is

$$\partial_{\mathbf{r}}(D \hat{Q}^R \partial_{\mathbf{r}} \hat{Q}^K + D \hat{Q}^K \partial_{\mathbf{r}} \hat{Q}^A) + i\epsilon[\hat{\tau}_z, \hat{Q}^K] + i[\hat{\Delta}, \hat{Q}^K] = 0. \quad (321)$$

<sup>17</sup>Within this section the subscript  $\mathcal{K}$  is suppressed in the notations of  $\check{Q}_{\mathcal{K}}$  matrix,  $\check{Q}_{\mathcal{K}} \rightarrow \check{Q}$ , and all other gauged fields.



The non-linear constraint  $\hat{Q}^2 = \hat{1}$  imposes the following conditions

$$\hat{Q}^R \hat{Q}^R = \hat{Q}^A \hat{Q}^A = \hat{1}, \quad \hat{Q}^R \hat{Q}^K + \hat{Q}^K \hat{Q}^A = 0. \quad (322)$$

They may be explicitly resolved by the angular parametrization [121] for the retarded and advanced blocks of the Green's function matrix:

$$\hat{Q}^R(\mathbf{r}, \epsilon) = \begin{pmatrix} \cosh \theta & \sinh \theta \exp(i\chi) \\ -\sinh \theta \exp(-i\chi) & -\cosh \theta \end{pmatrix}_N, \quad (323a)$$

$$\hat{Q}^A(\mathbf{r}, \epsilon) = -\hat{\tau}_z [\hat{Q}^R]^\dagger \hat{\tau}_z = \begin{pmatrix} -\cosh \bar{\theta} & -\sinh \bar{\theta} \exp(i\bar{\chi}) \\ \sinh \bar{\theta} \exp(-i\bar{\chi}) & \cosh \bar{\theta} \end{pmatrix}_N, \quad (323b)$$

where  $\theta(\mathbf{r}, \epsilon)$  and  $\chi(\mathbf{r}, \epsilon)$  are complex, coordinate- and energy-dependent scalar functions. As to the Keldysh component, it can be always chosen as

$$\hat{Q}^K = \hat{Q}^R \circ \hat{F} - \hat{F} \circ \hat{Q}^A, \quad (324)$$

where  $\hat{F}$  may be thought of as a generalized matrix distribution function. Following Schmidt-Schön [122], and Larkin-Ovchinnikov [123] we choose

$$\hat{F}(\mathbf{r}, \epsilon) = \begin{pmatrix} F_L(\mathbf{r}, \epsilon) + F_T(\mathbf{r}, \epsilon) & 0 \\ 0 & F_L(\mathbf{r}, \epsilon) - F_T(\mathbf{r}, \epsilon) \end{pmatrix}_N = F_L(\mathbf{r}, \epsilon) \hat{\tau}_0 + F_T(\mathbf{r}, \epsilon) \hat{\tau}_z, \quad (325)$$

where abbreviations  $F_{L(T)}$  refer to the *longitudinal* and *transverse* components of the distribution function with respect to the order parameter. Physically  $F_T$  corresponds to the charge mode of the system and determines the electric current density, while  $F_L$  corresponds to the energy mode, determining the heat (energy) current (further discussions may be found in books of Tinkham [124] and Kopnin [125]).

Substituting  $\hat{Q}^R$  in the form of (323) into (320), one finds from the diagonal elements of the corresponding matrix equation

$$D \partial_r (\sinh^2 \theta \partial_r \chi) = 2i|\Delta| \sinh \theta \sin(\varphi - \chi), \quad (326)$$

where the order parameter is parameterized as  $\Delta(\mathbf{r}) = |\Delta(\mathbf{r})| \exp(i\varphi(\mathbf{r}))$ . From the off-diagonal block of the matrix Equation (320), using (326), one obtains

$$D \partial_r^2 \theta + 2i\epsilon \sinh \theta - 2i|\Delta| \cosh \theta \cos(\varphi - \chi) = \frac{D}{2} (\partial_r \chi)^2 \sinh 2\theta. \quad (327)$$

We proceed with the equation for the Keldysh component of the Green's function matrix  $\hat{Q}^K$ . Using decomposition (324) and substituting it into Eq. (321), one obtains

$$D \left( \partial_r^2 \hat{F} + \hat{Q}^R \partial_r \hat{Q}^R \partial_r \hat{F} - \partial_r \hat{F} \hat{Q}^A \partial_r \hat{Q}^A - \partial_r (\hat{Q}^R \partial_r \hat{F} \hat{Q}^A) \right) + i\epsilon \left( \hat{Q}^R [\hat{\tau}_z, \hat{F}] - [\hat{\tau}_z, \hat{F}] \hat{Q}^A \right) + i \left( \hat{Q}^R [\hat{\Delta}, \hat{F}] - [\hat{\Delta}, \hat{F}] \hat{Q}^A \right) = 0. \quad (328)$$

Now using (325) for  $\hat{F}$  and: (i) taking Nambu trace of the above matrix equation; (ii) multiplying the above equation by  $\hat{\tau}_z$  and then tracing it; one finds two coupled kinetic equations for the non-equilibrium distribution junctions  $F_{L(T)}$ , which can be written in the form of conservation laws [126]

$$\partial_r (\mathcal{D}_L \partial_r F_L - D \partial_r F_T Y) + D \partial_r F_T \mathcal{J}_S = \mathcal{I}_{\text{coll}}^a, \quad (329a)$$

$$\partial_r (\mathcal{D}_T \partial_r F_T + D \partial_r F_L Y) + D \partial_r F_L \mathcal{J}_S = \mathcal{I}_{\text{coll}}^b. \quad (329b)$$

Here we have introduced energy- and coordinate-dependent diffusion coefficients

$$\mathcal{D}_L(\mathbf{r}, \epsilon) = \frac{D}{4} \text{Tr} \left\{ \hat{\tau}_0 - \hat{Q}^R \hat{Q}^A \right\}_N = \frac{D}{2} \left[ 1 + |\cosh \theta|^2 - |\sinh \theta|^2 \cosh(2\text{Im}[\chi]) \right], \quad (330a)$$

$$\mathcal{D}_T(\mathbf{r}, \epsilon) = \frac{D}{4} \text{Tr} \left\{ \hat{\tau}_0 - \hat{\tau}_z \hat{Q}^R \hat{\tau}_z \hat{Q}^A \right\}_N = \frac{D}{2} \left[ 1 + |\cosh \theta|^2 + |\sinh \theta|^2 \cosh(2\text{Im}[\chi]) \right], \quad (330b)$$

density of the supercurrent carrying states

$$\mathcal{J}_S(\mathbf{r}, \epsilon) = \frac{1}{4} \text{Tr} \left\{ \hat{\tau}_z (\hat{Q}^R \partial_r \hat{Q}^A - \hat{Q}^A \partial_r \hat{Q}^R) \right\}_N = -\text{Im}(\sinh^2 \theta \partial_r \chi), \quad (331)$$

and the spectral function

$$Y(\mathbf{r}, \epsilon) = \frac{1}{4} \text{Tr} \left\{ \hat{Q}^R \hat{\tau}_z \hat{Q}^A \right\}_N = \frac{1}{2} |\sinh \theta|^2 \sinh(2\text{Im}[\chi]). \quad (332)$$

Finally, the right hand side of (329) contains the collision integrals

$$\mathcal{I}_{\text{coll}}^a = \frac{F_T}{2} \text{Tr} \left\{ \hat{\tau}_z (\hat{Q}^R \hat{\Delta} + \hat{\Delta} \hat{Q}^A) \right\}_N = 2F_T |\Delta| \text{Re}[\sinh \theta \sin(\varphi - \chi)], \quad (333a)$$

$$\mathcal{I}_{\text{coll}}^b = \frac{F_T}{2} \text{Tr} \left\{ \hat{Q}^R \hat{\Delta} + \hat{\Delta} \hat{Q}^A \right\}_N = -2F_T |\Delta| \text{Im}[\sinh \theta \cos(\varphi - \chi)]. \quad (333b)$$

Collision integrals associated with the inelastic electron–electron and electron–phonon interactions are not discussed here, one may find corresponding derivations in the book of Kopnin [125]. Equations (326), (327) and (329), together with the spectral quantities (330)–(333) represent a complete set of kinetic equations for disordered superconductors applicable within quasi–classical approximation. These equations are supplemented by the self–consistency relation, see (317)

$$\Delta(\mathbf{r}) = \frac{\lambda}{2} \int d\epsilon \left\{ [\sinh \theta \exp(i\chi) + \sinh \bar{\theta} \exp(i\bar{\chi})] F_L - [\sinh \theta \exp(i\chi) - \sinh \bar{\theta} \exp(i\bar{\chi})] F_T \right\}, \quad (334)$$

and the boundary conditions for the Green’s functions, expressing the current continuity [70, 127, 128, 129],

$$\sigma_L \mathcal{A}_L \check{Q}_L \partial_r \check{Q}_L = \sigma_R \mathcal{A}_R \check{Q}_R \partial_r \check{Q}_R = g_T [\check{Q}_L, \check{Q}_R], \quad (335)$$

where  $\sigma$  and  $\mathcal{A}$  are the bulk normal–state conductivity and the cross section of the wire next to the interface,  $L/R$  denote left/right from the interface, respectively, and  $g_T$  is the interface tunneling conductance.

An analytic solution of the system of kinetic equations (326)–(329) is rarely possible. In general, one has to rely on numerical methods. To find solution for a given transport problem, one should proceed as follows [121].

1. Start with a certain  $\Delta(\mathbf{r})$ . Usually one takes  $\Delta = \text{const}$  everywhere in the superconductors and  $\Delta = 0$  in the normal metals.
2. Solve Usadel equations (326)–(327) for the retarded Green function, thus determining spectral angles  $\theta(\mathbf{r}, \epsilon)$  and  $\chi(\mathbf{r}, \epsilon)$ .
3. Use these solutions to calculate spectral kinetic quantities  $\mathcal{D}_{L,T}(\mathbf{r}, \epsilon)$ ,  $\mathcal{J}_S(\mathbf{r}, \epsilon)$  and  $Y(\mathbf{r}, \epsilon)$ .
4. Solve kinetic equations (329) for  $F_{L/T}(\mathbf{r}, \epsilon)$ .
5. Calculate new  $\Delta(\mathbf{r})$  from Equation (334), and iterate this procedure until the self–consistency is achieved.

Having solved the kinetic equations one may determine physical quantities of interest. For example, for the electric current one finds  $\mathbf{j} = \mathbf{j}_n + \mathbf{j}_s$ , where  $\mathbf{j}_n(\mathbf{r}) = v \int d\epsilon \mathcal{D}_T(\mathbf{r}, \epsilon) \partial_r F_T(\mathbf{r}, \epsilon)$  is the normal component and  $\mathbf{j}_s(\mathbf{r}) = vD \int d\epsilon F_L(\mathbf{r}, \epsilon) \mathcal{J}_S(\mathbf{r}, \epsilon)$  is the supercurrent density.

The quasiclassical kinetic theory of disordered superconductors, outlined above, may be applied to study various phenomena. To name a few: the proximity related problems in the superconductor–normal metal heterostructures [130, 131, 132, 133], non–equilibrium Josephson effect [134, 135], Hall effect [136], thermoelectric phenomena [137, 138] in superconductors, shot noise [139], engineering of non–equilibrium distribution functions [140] and many other problems may be successfully tackled with the help of (326)–(329). Several relatively simple (equilibrium) examples are considered in Section 8.4 for illustration.

### 8.3 Time dependent Ginzburg–Landau theory

Gor’kov [141] had shown that the phenomenological Ginzburg–Landau (GL) theory [142] follows naturally from the microscopic BCS model in the limit when temperature is close to the critical one  $|T - T_c| \ll T_c$ . Later Gor’kov and Eliashberg [143] extended application of the Ginzburg–Landau theory to include time dependent dynamical phenomena. It was revisited in a number of subsequent publications [144, 145, 146, 147, 148, 149, 150] and books [124, 125, 151]. Within the  $\sigma$ -model terminology the static GL functional may be obtained by means of supersymmetric [152] or replica [153] approaches. Here we discuss the dynamic theory in Keldysh formulation [154].

The way dynamical time dependent Ginzburg–Landau (TDGL) theory is derived from (312) allows to formulate it in terms of the effective action, rather than the equation for the order parameter only, as it is done in a traditional way. As a result, in addition to the average quantities one has an access to fluctuation effects, since TDGL action contains the stochastic noise term, which serves to satisfy the fluctuation–dissipation theorem. Moreover, one may naturally and unmistakably identify an anomalous Gor’kov–Eliashberg (GE) term [143], which preserves gauge invariance of the theory, along with the Aslamazov–Larkin (AL) [155], Maki–Thompson (MT) [156] and density of states (DOS) terms [162], which renormalize the conductivity and single particle density of states owing to superconductive fluctuations. Although Aslamazov–Larkin term is correctly captured by most of the approaches to TDGL equation, Gor’kov–Eliashberg, Maki–Thompson and DOS are frequently lost in many works on TDGL.

The strategy of deriving the effective TDGL theory starting from the general  $\sigma$ -model action (312) is as follows. (i) Choose a parametrization of a saddle point  $\check{Q}$  matrix manifold, which resolves the non-linear constraint  $\check{Q}^2 = \check{1}$ . (ii) Integrates out Gaussian fluctuations around the saddle point and (iii) keeps terms up to the second order in all *quantum* fields (the order parameter  $\Delta$  and electromagnetic potentials  $\Phi$  and  $\mathbf{A}$ ) in the resulting action. (iv) Rely on the assumption that the electronic system is always in a local thermal equilibrium. This in turn implies that the external fields are not too large. More precisely, the electric field  $\mathbf{E}$  is such that  $e|\mathbf{E}|\xi_0 \ll T_c$ , while the magnetic field  $\mathbf{H}$  is restricted by the condition  $e|\mathbf{H}|\xi_0 \ll 1/\xi_0$ , where  $\xi_0 = \sqrt{D/T_c}$  is superconductive coherence length. The restrictions on spatial and temporal scales of the external fields along with the fact that electrons are in local equilibrium considerably simplify the theory. In particular, most of the terms in the effective action acquire a local form in space and time. Nevertheless, the effective theory does not take a completely local form.

This procedure is relatively straightforward in the case of gapless superconductivity. The latter occurs either in the presence of magnetic impurities, or in the fluctuating regime above the critical temperature  $T \gtrsim T_c$ . In the gapped phases,  $T \lesssim T_c$ , the situation becomes more complicated. As noted by Gor’kov and Eliashberg [143], the difficulty stems from the singularity of the BCS density of states at the gap edge. The latter leads to a slowly decaying oscillatory response at frequency  $2\Delta/\hbar$  in the time domain. As a result, the expansion in powers of the small parameter  $\Delta/T_c \ll 1$  fails. In principle, it may be augmented by an expansion in  $\Delta/(\hbar\omega)$ , in case of high-frequency external fields. To describe low-frequency responses in the gapped phase, one needs a time *non-local* version of the TDGL theory. The analysis is greatly simplified in the presence of a pair-breaking mechanism, such as magnetic impurities or energy relaxation. Such a mechanism may eliminate singularity in the density of states, leading to gapless phase in the presence of finite  $\Delta$ . Under these conditions, an expansion in powers of  $\Delta\tau_\phi/\hbar \ll 1$  and  $\omega\tau_\phi \ll 1$  is justified and thus a time-local TDGL equation may be recovered (here  $\tau_\phi$  is the pair-breaking time). Within this section only fluctuating regime,  $T \gtrsim T_c$ , will be considered. In this case the spectrum is gapless automatically and there is no need in an explicit pair-breaking mechanism.

Proceeding along the steps (i)–(iv), outlined above, one recalls that at  $T > T_c$  energy gap self-consistency Equation (317) has only trivial solution with  $\langle \Delta^{cl} \rangle = 0$ . Thus the trial saddle point of the action (312) collapses back to the metallic state  $\check{Q}_{\mathcal{X}} = \check{\Lambda} = \hat{\Lambda} \otimes \hat{\tau}_z$ , where  $\hat{\Lambda}$  is defined by (165). The Gaussian integration around this  $\check{Q}_{\mathcal{X}}$  includes Cooper modes, which are accounted for in the

following parametrization of  $\hat{Q}_{\mathcal{K}}$ -matrix:

$$\check{Q}_{\mathcal{K}} = \check{\mathcal{U}} \circ e^{-\check{W}/2} \circ (\hat{\sigma}_z \otimes \hat{\tau}_z) \circ e^{\check{W}/2} \circ \check{\mathcal{U}}^{-1}, \quad (336)$$

with the following choice of the fluctuation matrix

$$\check{W}_{tr}(\mathbf{r}) = \begin{pmatrix} c_{tr}(\mathbf{r})\hat{\tau}_+ - c_{tr}^*(\mathbf{r})\hat{\tau}_- & d_{tr}(\mathbf{r})\hat{\tau}_0 + d_{tr}^z(\mathbf{r})\hat{\tau}_z \\ \bar{d}_{tr}(\mathbf{r})\hat{\tau}_0 + \bar{d}_{tr}^z(\mathbf{r})\hat{\tau}_z & \bar{c}_{tr}(\mathbf{r})\hat{\tau}_+ - \bar{c}_{tr}^*(\mathbf{r})\hat{\tau}_- \end{pmatrix}_K, \quad \check{\mathcal{U}} = \check{\mathcal{U}}^{-1} = \begin{pmatrix} 1 & F \\ 0 & -1 \end{pmatrix}_K \otimes \hat{\tau}_0. \quad (337)$$

As compared with (186),  $\check{W}$  contains twice as many diffusive modes, which are described by four Hermitian matrices in time subspace:  $\{d, \bar{d}\}$  and  $\{d^z, \bar{d}^z\}$ . It also contains the Cooper modes described by two independent *complex* matrix fields  $\{c, \bar{c}\}$ . Now substitutes the  $\check{W}$ -dependent  $\hat{Q}_{\mathcal{K}}$  matrix  $\check{Q}_{\mathcal{K}}[\check{W}]$  into (312) and expands the action up to the second order in  $\check{W}$  fluctuations:  $S[\check{Q}, \Delta, \mathbf{A}, \Phi] \Rightarrow S[\check{W}, \Delta, \mathbf{A}, \Phi]$ . After this step the Gaussian integration over  $\check{W}$  is possible (see details of this procedure in Appendix D)

$$\int \mathbf{D}[\check{W}] \exp(iS[\check{W}, \Delta, \mathbf{A}, \Phi]) = \exp(iS_{\text{eff}}[\Delta, \mathbf{A}, \Phi]), \quad (338)$$

which leads eventually to the effective TDGL action. It consists of several contributions:

$$S_{\text{eff}}[\Delta, \mathbf{A}, \Phi] = S_{\text{N}}[\mathbf{A}, \Phi] + S_{\text{GL}}[\Delta, \mathbf{A}, \Phi] + S_{\text{SC}}[\Delta, \mathbf{A}, \Phi] + S_{\text{MT}}[\Delta, \mathbf{A}, \Phi] + S_{\text{DOS}}[\Delta, \mathbf{A}, \Phi], \quad (339)$$

which we describe in order.

The action  $S_{\text{N}}[\mathbf{A}, \Phi]$  is the normal metal part of (312), which is obtained from  $S[\check{Q}, \Delta, \mathbf{A}, \Phi]$  by setting  $\check{Q}_{\mathcal{K}} = \check{\Lambda}$  and  $\check{\Delta} = 0$ . It reads as<sup>18</sup>

$$S_{\text{N}}[\mathbf{A}, \Phi] = e^2 \nu D \text{Tr} \left\{ \vec{\mathbf{A}}_{\mathcal{K}}^T \begin{pmatrix} 0 & D \partial_{\mathbf{r}}^2 - \overleftarrow{\partial}_t \\ D \partial_{\mathbf{r}}^2 - \overrightarrow{\partial}_t & 4iT \end{pmatrix}_K \vec{\mathbf{A}}_{\mathcal{K}} \right\}, \quad (340)$$

where arrows on top of the time derivative indicate direction of differentiation. Since our starting point is the normal saddle point (165),  $\vec{\mathcal{K}}[\Phi]$  functional is given by Eq. (233) and gauged vector potential  $\mathbf{A}_{\mathcal{K}}$  is defined by Eq. (227).

The  $S_{\text{GL}}$  is the time dependent Ginzburg–Landau part of the action

$$S_{\text{GL}}[\Delta, \mathbf{A}, \Phi] = 2\nu \text{Tr} \left\{ \vec{\Delta}_{\mathcal{K}}^{\dagger}(\mathbf{r}, t) \hat{L}^{-1} \vec{\Delta}_{\mathcal{K}}(\mathbf{r}, t) \right\}, \quad (341)$$

which governs time and space variations of the order parameter under the influence of external potentials. The effective propagator  $\hat{L}^{-1}$  has the typical bosonic structure in the Keldysh space

$$\hat{L}^{-1} = \begin{pmatrix} 0 & L_A^{-1} \\ L_R^{-1} & L_K^{-1} \end{pmatrix}_K, \quad (342)$$

with the components given by

$$L_{R(A)}^{-1} = \frac{\pi}{8T_c} \left[ \mp \partial_t - \tau_{\text{GL}}^{-1} + D(\partial_{\mathbf{r}} - 2ie\mathbf{A}_{\mathcal{K}}^{cl})^2 - \frac{7\zeta(3)}{\pi^3 T_c} |\Delta_{\mathcal{K}}^{cl}|^2 \right], \quad (343a)$$

$$L_K^{-1} = \coth \frac{\omega}{2T} [L_R^{-1}(\omega) - L_A^{-1}(\omega)] \approx \frac{i\pi}{2}, \quad (343b)$$

where  $\omega \ll T \approx T_c$  and Ginzburg–Landau relaxation time is defined as  $\tau_{\text{GL}} = \pi/8(T - T_c)$ . Note that under the assumption  $T - T_c \ll T_c$ , GL part of the action acquires a time–local form.

<sup>18</sup>Note that in (340) and throughout the rest of this section we have restored electron charge  $e$  accompanying source fields  $\mathbf{A} \rightarrow e\mathbf{A}$  and  $\Phi \rightarrow e\Phi$ , such that  $\mathbf{A}$  and  $\Phi$  are now actual electromagnetic potentials, see Note 8.

The  $S_{\text{SC}}$  part of the action is responsible for the super-current

$$S_{\text{SC}}[\Delta, \mathbf{A}, \Phi] = \frac{\pi e \nu D}{2T} \text{Tr} \left\{ \mathbf{A}_{\mathcal{K}}^q \text{Im} [\Delta_{\mathcal{K}}^{*cl} (\partial_{\mathbf{r}} - 2ie \mathbf{A}_{\mathcal{K}}^{cl}) \Delta_{\mathcal{K}}^{cl}] \right\}. \quad (344)$$

The abbreviation is due to the fact that  $S_{\text{SC}}$ , being differentiated with respect to  $\mathbf{A}^q$ , provides standard expression for the super-current in terms of the order parameter [124].

The Maki–Thompson part of the action,  $S_{\text{MT}}$ , is responsible for renormalization of the diffusion coefficient in the normal action  $S_{\text{N}}$  owing to the superconductive fluctuations. It reads as

$$S_{\text{MT}}[\Delta, \mathbf{A}, \Phi] = e^2 \nu \text{Tr} \left\{ \vec{\mathbf{A}}_{\mathcal{K}}^T(\mathbf{r}, t) \hat{\mathcal{T}}_{\delta D}(t, t') \vec{\mathbf{A}}_{\mathcal{K}}(\mathbf{r}, t') \right\}, \quad (345)$$

where the operator  $\hat{\mathcal{T}}_{\delta D}(t, t')$  is given by

$$\hat{\mathcal{T}}_{\delta D} = \begin{pmatrix} 0 & -\overleftarrow{\partial}_t \delta D_{\mathbf{r}, t'}^{\text{MT}} \\ -\delta D_{\mathbf{r}, t'}^{\text{MT}} \overrightarrow{\partial}_{t'} & 2iT (\delta D_{\mathbf{r}, t'}^{\text{MT}} + \delta D_{\mathbf{r}, t'}^{\text{MT}}) \end{pmatrix}_K. \quad (346)$$

The diffusion coefficient correction  $\delta D^{\text{MT}}[\Delta_{\mathcal{K}}]$  is the non-local functional of the fluctuating order parameter

$$\delta D_{\mathbf{r}, t'}^{\text{MT}} = \frac{\pi D}{4T} \int d\mathbf{r}' d\mathbf{r}'' C_{\tau, t, t'}^{\mathbf{r}, \mathbf{r}'} \Delta_{\mathcal{K}}^{*cl}(\mathbf{r}', \tau) \Delta_{\mathcal{K}}^{cl}(\mathbf{r}'', \tau) \bar{C}_{\tau, t', t}^{\mathbf{r}'', \mathbf{r}}, \quad (347)$$

where  $\tau = (t + t')/2$ . The retarded  $C_{\tau, t, t'}^{\mathbf{r}, \mathbf{r}'} \sim \theta(t - t')$  and advanced  $\bar{C}_{\tau, t, t'}^{\mathbf{r}'', \mathbf{r}} \sim \theta(t' - t)$  Cooperon propagators are Green's functions of the following equations:

$$\left\{ \partial_t - ie\Phi_{\mathcal{K}}^{cl}(\mathbf{r}, \tau_+) + ie\Phi_{\mathcal{K}}^{cl}(\mathbf{r}, \tau_-) - D \left[ \partial_{\mathbf{r}} - ie\mathbf{A}_{\mathcal{K}}^{cl}(\mathbf{r}, \tau_+) - ie\mathbf{A}_{\mathcal{K}}^{cl}(\mathbf{r}, \tau_-) \right]^2 \right\} C_{\tau, t, t'}^{\mathbf{r}, \mathbf{r}'} = \delta_{\mathbf{r}-\mathbf{r}'} \delta_{t-t'}, \quad (348a)$$

$$\left\{ -\partial_t + ie\Phi_{\mathcal{K}}^{cl}(\mathbf{r}, \tau_+) - ie\Phi_{\mathcal{K}}^{cl}(\mathbf{r}, \tau_-) - D \left[ \partial_{\mathbf{r}} - ie\mathbf{A}_{\mathcal{K}}^{cl}(\mathbf{r}, \tau_+) - ie\mathbf{A}_{\mathcal{K}}^{cl}(\mathbf{r}, \tau_-) \right]^2 \right\} \bar{C}_{\tau, t, t'}^{\mathbf{r}'', \mathbf{r}} = \delta_{\mathbf{r}-\mathbf{r}''} \delta_{t-t'}, \quad (348b)$$

with  $\tau_{\pm} = \tau \pm t/2$ . Note that MT action (345), has exactly the same structure as the normal action  $S_{\text{N}}$ . It therefore can be incorporated into (340) by adding a renormalization of the normal diffusion constant  $D\delta_{t-t'} \rightarrow D\delta_{t-t'} + \delta D_{\mathbf{r}, t, t'}^{\text{MT}}$  that is non-local in time.

Finally,  $S_{\text{DOS}}$  has similar structure to  $S_{\text{MT}}$  in (345)

$$S_{\text{DOS}}[\Delta, \mathbf{A}, \Phi] = e^2 D \text{Tr} \left\{ \delta \nu_{\mathbf{r}, t}^{\text{DOS}} \left[ \vec{\mathbf{A}}_{\mathcal{K}}^T(\mathbf{r}, t) \begin{pmatrix} 0 & -\overleftarrow{\partial}_t \\ -\overrightarrow{\partial}_t & 4iT \end{pmatrix}_K \vec{\mathbf{A}}_{\mathcal{K}}(\mathbf{r}, t) \right] \right\}, \quad (349)$$

with locally renormalized density of states

$$\delta \nu_{\mathbf{r}, t}^{\text{DOS}} = -\nu \frac{7\zeta(3)}{4\pi^2 T^2} |\Delta_{\mathcal{K}}^{cl}(\mathbf{r}, t)|^2. \quad (350)$$

Each term of the effective action (339) admits a transparent diagrammatic representation, shown in Figure 17.

An equivalent way to display the same information, which is encoded in the effective action (339), is to use the set of stochastic time dependent Ginzburg–Landau equations. To derive those one needs to get rid of terms quadratic in quantum components of the fields:  $\Delta_{\mathcal{K}}^q$  in  $S_{\text{GL}}$ , and  $\mathbf{A}_{\mathcal{K}}^q$  in  $S_{\text{N}} + S_{\text{MT}} + S_{\text{DOS}}$ . For the first one, this is achieved with the Hubbard–Stratonovich transformation

$$\exp \left( -\frac{\pi \nu}{2} \text{Tr} \{ |\Delta_{\mathcal{K}}^q|^2 \} \right) = \int \mathbf{D}[\xi_{\Delta}] \exp \left( -\frac{\pi \nu}{8T} \text{Tr} \left\{ \frac{|\xi_{\Delta}|^2}{4T} - i\xi_{\Delta}^* \Delta_{\mathcal{K}}^q - i\xi_{\Delta} \Delta_{\mathcal{K}}^{*q} \right\} \right). \quad (351)$$

As a result, the effective action  $S_{\text{eff}}$  in (339) acquires the form linear in quantum components of the order parameter. Integration over the latter leads to the functional delta-function, imposing the stochastic equation of motion. This way the TDGL equation is derived

$$\left[ \partial_t + \tau_{\text{GL}}^{-1} - D \left[ \partial_{\mathbf{r}} - 2ie\mathbf{A}_{\mathcal{K}}^{cl}(\mathbf{r}, t) \right]^2 + \frac{7\zeta(3)}{\pi^3 T} |\Delta_{\mathcal{K}}^{cl}(\mathbf{r}, t)|^2 \right] \Delta_{\mathcal{K}}^{cl}(\mathbf{r}, t) = \xi_{\Delta}(\mathbf{r}, t). \quad (352)$$

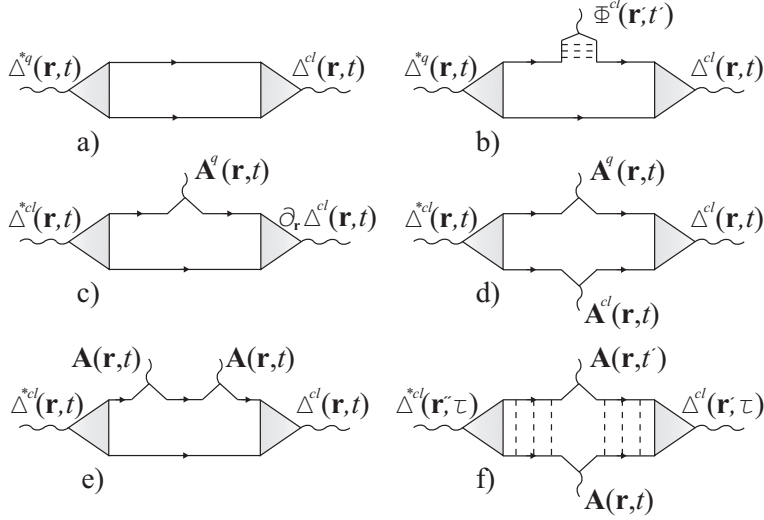

Figure 17: Diagrammatic representation of the effective action  $S_{\text{eff}}[\Delta, \mathbf{A}, \Phi]$ . a) Conventional Ginzburg–Landau functional  $S_{\text{GL}}$ , see (341). b) Anomalous Gor’kov–Eliashberg coupling between the scalar potential and the order parameter (see (357) and discussions below). c) Paramagnetic and d) diamagnetic parts of the super-current action  $S_{\text{SC}}$ . e) Local DOS term  $S_{\text{DOS}}$ . f) Nonlocal MT term  $S_{\text{MT}}$ . In the case of diagrams e) and f) there are two possible choices for the vector potentials: *classical–quantum*, which is a part of the current, and *quantum–quantum*, which is its FDT counterpart.

The complex Gaussian noise  $\xi_{\Delta}(\mathbf{r}, t)$  has white noise correlation function

$$\langle \xi_{\Delta}(\mathbf{r}, t) \xi_{\Delta}^*(\mathbf{r}', t') \rangle = \frac{16T^2}{\pi\nu} \delta(\mathbf{r} - \mathbf{r}') \delta(t - t'). \quad (353)$$

In a similar way one decouples quadratic in  $\mathbf{A}_{\mathcal{K}}^q$  terms in the action (339) by introducing vectorial Hubbard–Stratonovich field  $\xi_{\mathcal{J}}(\mathbf{r}, t)$

$$\exp\left(-4T\text{Tr}\{\sigma_{\mathbf{r},t,t'}[\mathbf{A}_{\mathcal{K}}^q]^2\}\right) = \int \mathbf{D}[\xi_{\mathcal{J}}] \exp\left(-\text{Tr}\left\{\frac{\xi_{\mathcal{J}}^2}{4T\sigma_{\mathbf{r},t,t'}} + 2i\mathbf{A}_{\mathcal{K}}^q \xi_{\mathcal{J}}\right\}\right), \quad (354)$$

where  $\sigma_{\mathbf{r},t,t'} = \sigma_D + e^2 D \delta v_{\mathbf{r},t}^{\text{DOS}} + e^2 \nu \delta D_{\mathbf{r},t,t'}^{\text{MT}}$  is the complete conductivity including both DOS and MT renormalizations. The resulting action is now linear in both  $\Phi_{\mathcal{K}}^q$  and  $\mathbf{A}_{\mathcal{K}}^q$  fields, allowing us to define the charge  $\varrho(\mathbf{r}, t) = (1/2)\delta S_{\text{eff}}/\delta\Phi^q(\mathbf{r}, t)$  and current  $\mathbf{j}(\mathbf{r}, t) = (1/2)\delta S_{\text{eff}}/\delta\mathbf{A}^q(\mathbf{r}, t)$  densities. It is important to emphasize that the differentiation here is performed over the bare electromagnetic potentials  $\{\mathbf{A}, \Phi\}$ , while the action  $S_{\text{eff}}$  in (339) is written in terms of the gauged ones  $\{\mathbf{A}_{\mathcal{K}}, \Phi_{\mathcal{K}}\}$ . The connection between the two  $\{\Phi, \mathbf{A}\} \rightleftharpoons \{\mathbf{A}_{\mathcal{K}}, \Phi_{\mathcal{K}}\}$  is provided by the functional  $\mathcal{K}[\Phi]$ , which is implicit in (233). A simple algebra then leads to a set of the continuity equation  $\partial_t \varrho(\mathbf{r}, t) + \text{div} \mathbf{j}(\mathbf{r}, t) = 0$ , and expression for the current density

$$\begin{aligned} \mathbf{j}(\mathbf{r}, t) &= \int dt' [D\delta_{t-t'} + \delta D_{\mathbf{r},t,t'}^{\text{MT}}] [e^2 (\nu + \delta v_{\mathbf{r},t'}^{\text{DOS}}) \mathbf{E}(\mathbf{r}, t') - \partial_{\mathbf{r}} \varrho(\mathbf{r}, t')] \\ &+ \frac{\pi e \nu D}{4T} \text{Im} \left\{ \Delta_{\mathcal{K}}^{*cl}(\mathbf{r}, t) [\partial_{\mathbf{r}} - 2ie\mathbf{A}_{\mathcal{K}}^{cl}(\mathbf{r}, t)] \Delta_{\mathcal{K}}^{cl}(\mathbf{r}, t) \right\} + \xi_{\mathcal{J}}(\mathbf{r}, t), \end{aligned} \quad (355)$$

where  $\mathbf{E}(\mathbf{r}, t) = \partial_t \mathbf{A}_{\mathcal{K}} - \partial_{\mathbf{r}} \Phi_{\mathcal{K}}$  is electric field. The current fluctuations are induced by vector Gaussian white noise with the correlator

$$\langle \xi_{\mathcal{J}}^{\mu}(\mathbf{r}, t) \xi_{\mathcal{J}}^{\nu}(\mathbf{r}', t') \rangle = \delta_{\mu\nu} T e^2 \left( 2(\nu + \delta v_{\mathbf{r},t}^{\text{DOS}}) D \delta_{t-t'} + \nu \delta D_{\mathbf{r},t,t'}^{\text{MT}} + \nu \delta D_{\mathbf{r},t',t}^{\text{MT}} \right) \delta(\mathbf{r} - \mathbf{r}'), \quad (356)$$

guaranteeing the validity of FDT. Equations (352) and (355) together with the continuity relation must be also supplemented by Maxwell equations for the electromagnetic potentials.

It is instructive to rewrite TDGL equation (352) back in the original gauge. This is achieved by the substitution of the gauged order parameter  $\Delta_{\mathcal{K}}^{cl} = \Delta^{cl} \exp(-2ie\mathcal{K}^{cl})$  into (352). This way one finds for the bare order parameter  $\Delta^{cl}$  the following equation

$$[\partial_t - 2ie\partial_t\mathcal{K}^{cl}(\mathbf{r}, t)]\Delta^{cl}(\mathbf{r}, t) = \left[ D[\partial_{\mathbf{r}} - 2ie\mathbf{A}^{cl}(\mathbf{r}, t)]^2 - \tau_{\text{GL}}^{-1} - \frac{7\zeta(3)}{\pi^3 T} |\Delta^{cl}(\mathbf{r}, t)|^2 \right] \Delta^{cl}(\mathbf{r}, t) + \xi_{\Delta}(\mathbf{r}, t), \quad (357)$$

where we have redefined the order parameter noise as  $\xi_{\Delta} \rightarrow \xi_{\Delta} \exp(2ie\mathcal{K}^{cl})$ , which, however, does not change its correlation function (353). Unlike TDGL equations frequently found in the literature, the left hand side of (357) contains Gor'kov–Eliashberg (GE) anomalous term  $\partial_t\mathcal{K}^{cl}(\mathbf{r}, t)$  instead of the scalar potential  $\Phi^{cl}(\mathbf{r}, t)$ , see Figure 17b. In a generic case  $\mathcal{K}^{cl}(\mathbf{r}, t)$  is a non–local functional of the scalar and the longitudinal vector potentials, given by (236). For the classical component (236) provides

$$(\partial_t - D\partial_{\mathbf{r}}^2)\mathcal{K}^{cl}(\mathbf{r}, t) = \Phi^{cl}(\mathbf{r}, t) - D \text{div}\mathbf{A}^{cl}(\mathbf{r}, t). \quad (358)$$

Fields  $\partial_t\mathcal{K}^{cl}$  and  $\Phi^{cl}$  coincide for spatially uniform potentials, however in general they are distinct. The standard motivation behind writing the scalar potential  $\Phi^{cl}(\mathbf{r}, t)$  on the left–hand side of TDGL equation is the gauge invariance. Note, however, that a local gauge transformation

$$\begin{aligned} \Delta^{cl} &\rightarrow \Delta^{cl} e^{-2ie\chi}, & \Phi^{cl} &\rightarrow \Phi^{cl} - \partial_t\chi, \\ \mathbf{A}^{cl} &\rightarrow \mathbf{A}^{cl} - \partial_{\mathbf{r}}\chi, & \mathcal{K}^{cl} &\rightarrow \mathcal{K}^{cl} - \chi, \end{aligned} \quad (359)$$

leaves (357) unchanged and therefore this form of TDGL equation is perfectly gauge invariant. The last expression in (359) is an immediate consequence of (358) and the rules of the gauge transformation for  $\Phi(\mathbf{r}, t)$  and  $\mathbf{A}(\mathbf{r}, t)$ . In the  $\mathcal{K}$  gauge, specified by  $\chi(\mathbf{r}, t) = \mathcal{K}^{cl}(\mathbf{r}, t)$ , the anomalous GE term disappears from TDGL Equation (357), and one returns back to Eq. (352).

## 8.4 Applications IV: Non–uniform and fluctuating superconductivity

### 8.4.1 Proximity effect

Close to the interface with a superconductor a normal metal acquires partial superconducting properties. At the same time the superconductor is weakened by the normal metal. This mutual influence is called *proximity* effect. The quasiclassical Usadel and kinetic equations discussed in the Section 8.2 give full account of proximity related phenomena for superconductor–normal metal structures. One example of this kind is considered in this section.

Consider a normal diffusive wire of the length  $L$  placed between two bulk superconductors, forming superconductor–normal metal–superconductor (SNS) junction. We are interested to study how the proximity to the superconductor modifies quasiparticle energy spectrum in the normal wire. It follows from the Usadel equation (327) that the density of states in the wire acquires an energy gap  $\epsilon_g$  and exhibits square–root non–analytic behavior  $\sim \sqrt{\epsilon - \epsilon_g}$  above it, at  $\epsilon > \epsilon_g$  [132, 158]. To see this explicitly we assume that the wire cross–section dimension is much smaller than the superconductive coherence length  $\xi = \sqrt{D/\Delta}$ . In this case the wire may be thought of as being quasi–one–dimensional, such that all the variations occur along the  $x$  coordinate of the wire. If there are no attractive interactions in the wire,  $\lambda = 0$ , then according to the self–consistency Equation (334) pair potential  $\Delta(\mathbf{r}) = 0$  within the wire  $-L/2 \leq x \leq L/2$ , and  $\Delta(\mathbf{r}) = \Delta$  outside this interval. If in addition there is no phase difference between the two superconductors,  $\partial_x\chi = 0$ , the Usadel equation (327) simplifies considerably and reads as

$$D\partial_x^2\theta(x, \epsilon) + 2i\epsilon \sinh\theta(x, \epsilon) = 0. \quad (360)$$

At the interfaces with the superconductors,  $x = \pm L/2$ , this equation is supplemented by the boundary conditions  $\theta(\pm L/2, \epsilon) = \theta_{\text{BCS}}(\epsilon)$ , where  $\tanh\theta_{\text{BCS}}(\epsilon) = \Delta/\epsilon$ . It is assumed here that superconductors

are very large and negligibly perturbed by the wire, such that one can use coordinate-independent  $\theta_{BCS}(\epsilon)$  everywhere inside the superconductors. Having solved (360) one finds density of states as  $\nu(x, \epsilon) = \nu \text{Re}[\cosh \theta(x, \epsilon)]$ .

It is convenient to perform rotation  $\theta(x, \epsilon) = i\pi/2 - \vartheta(x, \epsilon)$  such that Eq. (360) becomes real and allows the straightforward integration

$$\sqrt{\frac{\epsilon}{E_{Th}}} = \int_{\vartheta_{BCS}}^{\vartheta_0} \frac{d\vartheta}{\sqrt{\sinh \vartheta_0 - \sinh \vartheta}} \equiv K(\vartheta_0, \epsilon), \quad (361)$$

where  $E_{Th} = D/L^2$ ,  $\vartheta_0 = \vartheta(0, \epsilon)$  and  $\sinh \vartheta_{BCS} = \epsilon/\sqrt{\Delta^2 - \epsilon^2}$ . Equation (361) defines  $\vartheta_0$  as a function of energy  $\epsilon$ . Knowing  $\vartheta_0(\epsilon)$  one determines density of states in the middle of the wire as  $\nu(0, \epsilon) = \nu \text{Im}[\sinh \vartheta_0(\epsilon)]$ .

In the limit of the long wire,  $\xi \ll L$ , modifications of the density of states occur in the deep sub-gap limit,  $\epsilon \ll \Delta$ . One may thus approximate  $\vartheta_{BCS} \approx 0$  and the function on the right-hand side of (361) is essentially energy independent  $K(\vartheta_0, \epsilon) \approx K(\vartheta_0, 0)$ . It exhibits the maximum  $K_{\max} = K(\vartheta_0^*) \approx 1.75$  at  $\vartheta_0^* \approx 1.5$ , whereas the left-hand side of (361) can be larger than  $K_{\max}$  for  $\epsilon > K_{\max}^2 E_{Th} = \epsilon_g$ . Thus, for all the energies  $\epsilon < \epsilon_g$ , Equation (361) has only real solution for  $\vartheta_0$  and  $\nu(0, \epsilon) \equiv 0$ , since  $\nu(0, \epsilon) \propto \text{Im}[\sinh \vartheta_0]$ . For  $\epsilon > \epsilon_g$  function  $\vartheta_0$  becomes complex and gives finite density of states. Right above the gap,  $0 < \epsilon - \epsilon_g \ll \epsilon_g$ , one finds with the help of Eq. (361)

$$\nu(\epsilon) = 3.7\delta^{-1} \sqrt{\frac{\epsilon}{\epsilon_g} - 1}, \quad (362)$$

where  $\nu(\epsilon) = \mathcal{A} \int \nu(x, \epsilon) dx$  is global density of states, integrated over the volume of the wire ( $\mathcal{A}$  is the wire cross-section area, and  $\delta = 1/(\nu \mathcal{A} L)$  is its level spacing). Note that since  $\epsilon_g \sim E_{Th} \ll \Delta$  the approximation  $\vartheta_{BCS}(\epsilon \sim \epsilon_g) \approx 0$  is well justified.

In the opposite limit of the short wire,  $L \ll \xi$ , or equivalently,  $E_{Th} \gg \Delta$ , Equation (361) is still applicable. However, one must keep the full energy dependence of  $\vartheta_{BCS}(\epsilon)$ . One may show that the energy gap is given by  $\epsilon_g = \Delta - \Delta^3/8E_{Th}^2$  and is only slightly smaller than the bulk gap  $\Delta$ . This is natural, since the proximity effect for the short wire is expected to be strong. Immediately above the induced gap, the density of states again exhibits the square-root non-analyticity. The coefficient in front of it, however, is large,  $\nu(\epsilon) \sim \delta^{-1}(E_{Th}/\Delta)^2 \sqrt{\epsilon/\epsilon_g - 1}$ , (see [159]).

#### 8.4.2 Josephson current

Another example which may be treated with the help of Usadel Equations (326) and (327) is the Josephson effect. Consider the same geometry of SNS junction, as in the previous section, assuming a finite phase difference between the pair potentials on the boundaries of the junction, i.e.  $\chi(L/2, \epsilon) - \chi(-L/2, \epsilon) = \phi$ . Under this condition Josephson super-current  $I_S(\phi)$  may flow across the junction. The aim of this section is to illustrate how Josephson phase-current relation may be obtained from the Usadel equations.

For the model of step-function pair potential,  $\Delta(x) = \Delta$  for  $|x| > L/2$  and  $\Delta = 0$  for  $|x| < L/2$ , equations (326), (327) acquire the form

$$D \partial_x (\sinh^2 \theta \partial_x \chi) = 0, \quad (363a)$$

$$D \partial_x^2 \theta + 2i\epsilon \sinh \theta = \frac{D}{2} (\partial_x \chi)^2 \sinh 2\theta. \quad (363b)$$

The latter are supplemented by the boundary conditions  $\theta(\pm L/2, \epsilon) = \theta_{BCS}(\epsilon)$ , while boundary condition for the  $\chi$ -function is determined by the fixed phase  $\phi$  across the junction mentioned above,  $\chi(L/2, \epsilon) - \chi(-L/2, \epsilon) = \phi$ . For the short wire,  $L \ll \xi$ , the second term on the left-hand side of (363b) is smaller than the gradient term by  $\epsilon/E_{Th} \ll 1$  and thus may be neglected. Since (363a)



allows for the first integral  $\sinh^2 \theta \partial_x \chi = \mathcal{J}/L$ , one may eliminate  $\partial_x \chi$  from Eq. (363b) and find  $L^2 \partial_x^2 \theta = \mathcal{J}^2 \cosh \theta / \sinh^3 \theta$ . This equation may be solved exactly

$$\cosh \theta(z, \epsilon) = \cosh \theta_0 \cosh \left( \frac{\mathcal{J}z}{\sinh \theta_0} \right), \quad (364)$$

where  $\theta_0 = \theta(0, \epsilon)$  and  $z = x/L$ . Knowing  $\theta(x, \epsilon)$ , one inserts it back into the first integral of (363a),  $\phi = \int_{-L/2}^{L/2} dx \partial_x \chi = \mathcal{J} \int_{-1/2}^{1/2} dz / \sinh^2 \theta(z, \epsilon)$ , to find

$$\tan(\phi/2) = \frac{1}{\sinh \theta_0} \tanh \left( \frac{\mathcal{J}}{2 \sinh \theta_0} \right). \quad (365)$$

This last equation along with Eq. (364) taken at the NS interfaces,  $z = \pm 1/2$ , constitutes the system of the two algebraic equations for the two unknown quantities:  $\mathcal{J}$  and  $\theta_0$ . Such an algebraic problem may be easily solved, resulting in  $\mathcal{J}(\epsilon, \phi) = 2 \sinh \theta_0 \operatorname{arctanh}[\sinh \theta_0 \tan(\phi/2)]$  and  $\sinh \theta_0 = \sinh \theta_{BCS} / \sqrt{1 + \tan^2(\phi/2) \cosh^2 \theta_{BCS}}$ , where  $\cosh \theta_{BCS} = \epsilon / \sqrt{\epsilon^2 - \Delta^2}$ . Knowing  $\mathcal{J}(\epsilon, \phi)$  one finds Josephson current with the help of

$$I_S(\phi) = \frac{g_D}{e} \int_0^\infty d\epsilon \tanh \left( \frac{\epsilon}{2T} \right) \operatorname{Im} \mathcal{J}(\epsilon, \phi), \quad (366)$$

where  $g_D$  is the wire conductance. Using the obtained solution for  $\mathcal{J}(\epsilon, \phi)$  one concludes that

$$\operatorname{Im} \mathcal{J}(\epsilon, \phi) = \frac{\pi \Delta \cos(\phi/2)}{\sqrt{\epsilon^2 - \Delta^2 \cos^2(\phi/2)}} \quad (367)$$

for  $\Delta \cos(\phi/2) < \epsilon < \Delta$ , and  $\operatorname{Im} \mathcal{J}(\epsilon, \phi) = 0$  otherwise. Employing (366) and (367), one arrives at the result derived by Kulik and Omelyanchuk [160] for the zero-temperature Josephson current of the short diffusive SNS junction

$$I_S(\phi) = \frac{\pi g_D \Delta}{e} \cos(\phi/2) \operatorname{arctanh}[\sin(\phi/2)]. \quad (368)$$

In the original work [160] imaginary time technique was used to derive  $I_S(\phi)$ . This result was reproduced later in [134, 161] with the help of real time (energy) Usadel equation.

### 8.4.3 Suppression of the density of states above $T_c$

Superconductor below  $T_c$  has an energy gap  $|\Delta(T)|$  in the excitation spectrum. Superconductor above and far away from  $T_c$  has metallic, constant density of states. One of the manifestations of superconducting fluctuations in the vicinity of the transition,  $0 < T - T_c \ll T_c$ , is the depletion of the density of states near the Fermi energy. Fluctuations mediated suppression of the density of states increases with the lowering of temperature and eventually transforms into the full gap. In this section we calculate the temperature dependence of this effect employing Keldysh formalism and compare it to the original works [162, 163], where Matsubara technique and analytic continuation procedure was used. For comprehensive discussions one may consult the recent book of Larkin and Varlamov [151].

Our starting point is the expression for the density of states given in terms of the  $\check{Q}$  matrix

$$\nu(\epsilon) = \frac{\nu}{4} \left\langle \operatorname{Tr} \{ \hat{\sigma}_z \otimes \hat{\tau}_z \check{Q}_{\epsilon\epsilon} \} \right\rangle_Q,$$

cf. Section 6.6.2. By taking  $\check{Q} = \check{\Lambda}$  one finds  $\nu(\epsilon) = \nu$ , as it should be for a normal metal. Expanding  $\check{Q}$  to the quadratic order in the Cooperon fluctuations  $\check{W}$ , see (336), one finds for the density of states correction

$$\delta\nu(\epsilon) = \frac{\nu}{4} \sum_q \int \frac{d\epsilon'}{2\pi} \langle \langle c_{\epsilon\epsilon'}(\mathbf{q}) c_{\epsilon'\epsilon}^*(-\mathbf{q}) + \bar{c}_{\epsilon\epsilon'}(\mathbf{q}) \bar{c}_{\epsilon'\epsilon}^*(-\mathbf{q}) \rangle \rangle_{W, \Delta}. \quad (369)$$

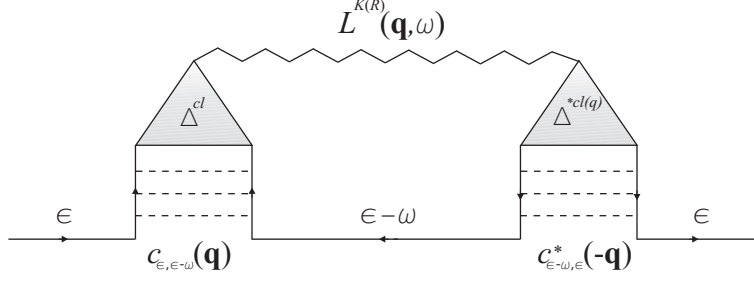

Figure 18: Diagram for the density of states correction, (372), in the vicinity of the critical temperature  $T_c$ . Two Cooperon fields  $c$  and  $c^*$ , shown by the ladders, are connected to the order parameter  $\Delta^{cl(q)}$ , shown as a filled triangle, which are paired by the fluctuations propagator.

The next step is to perform averaging over fluctuating  $c$  and  $\bar{c}$  fields. For this purpose one uses (435), which relates Cooper modes  $c$  and  $\bar{c}$  with the fluctuations of the order parameter. The latter are governed by the following correlation functions

$$\begin{aligned} \langle \Delta^{cl}(\mathbf{q}, \omega) \Delta^{*cl}(-\mathbf{q}, -\omega) \rangle_{\Delta} &= \frac{i}{2\nu} L^K(\mathbf{q}, \omega), & \langle \Delta^{cl}(\mathbf{q}, \omega) \Delta^{*q}(-\mathbf{q}, -\omega) \rangle_{\Delta} &= \frac{i}{2\nu} L^R(\mathbf{q}, \omega), \\ \langle \Delta^q(\mathbf{q}, \omega) \Delta^{*cl}(-\mathbf{q}, -\omega) \rangle_{\Delta} &= \frac{i}{2\nu} L^A(\mathbf{q}, \omega), & \langle \Delta^q(\mathbf{q}, \omega) \Delta^{*q}(-\mathbf{q}, -\omega) \rangle_{\Delta} &= 0, \end{aligned} \quad (370)$$

which follow from the time-dependent Ginzburg–Landau action (341). As a result one finds for the correlators of the Cooperon fields

$$\langle \langle c_{\epsilon, \epsilon-\omega}(\mathbf{q}) c_{\epsilon-\omega, \epsilon}^*(-\mathbf{q}) \rangle \rangle = \frac{2i}{\nu} \frac{L^K + F_{\epsilon-\omega} L^R + F_{\epsilon} L^A}{(Dq^2 - 2i\epsilon + i\omega)^2}, \quad (371a)$$

$$\langle \langle \bar{c}_{\epsilon, \epsilon-\omega}(\mathbf{q}) \bar{c}_{\epsilon-\omega, \epsilon}^*(-\mathbf{q}) \rangle \rangle = \frac{2i}{\nu} \frac{L^K - F_{\epsilon-\omega} L^A - F_{\epsilon} L^R}{(Dq^2 + 2i\epsilon - i\omega)^2}. \quad (371b)$$

Inserting these into (369) and summing up the two contributions, one obtains

$$\delta\nu(\epsilon) = \text{Im} \sum_q \int_{-\infty}^{+\infty} \frac{d\omega}{2\pi} \frac{L^K(\mathbf{q}, \omega) + F_{\epsilon-\omega} L^R(\mathbf{q}, \omega)}{(Dq^2 - 2i\epsilon + i\omega)^2}, \quad (372)$$

where terms proportional to  $F_{\epsilon} L^{A(R)}(\omega)$  in the averages  $\langle \langle cc^* \rangle \rangle$  and  $\langle \langle \bar{c}\bar{c}^* \rangle \rangle$  drop out from (372) upon  $\omega$  integration, as being integrals of purely advanced and retarded functions, respectively. Equation (372) allows convenient diagrammatic representation shown in Figure 18. Using now fluctuation propagator in the form of (444) and approximating bosonic distribution function as  $B_{\omega} \approx 2T_c/\omega$ , since the relevant frequencies  $\omega \sim T - T_c \ll T_c$ , the density of states correction (372) reduces to

$$\delta\nu(\epsilon) = -\frac{16T_c^2}{\pi^2} \text{Re} \sum_q \int_{-\infty}^{+\infty} \frac{d\omega}{[(Dq^2 + \tau_{\text{GL}}^{-1})^2 + \omega^2][Dq^2 - 2i\epsilon + i\omega]^2}, \quad (373)$$

where  $\tau_{\text{GL}}^{-1} = 8(T - T_c)/\pi$ .

The further analysis of this expression depends on the effective dimensionality of the system. We focus on quasi-two-dimensional case: a metal film with the thickness  $b$  which is much smaller than superconducting coherence length  $b \ll \xi(T) = \sqrt{D\tau_{\text{GL}}}$ . Replace the momentum summation by the integration  $\sum_q \rightarrow \frac{1}{b} \int \frac{dq^2}{4\pi^2}$ , introduce the dimensionless parameters  $x = Dq^2/T_c$  and  $y = \omega/T_c$ , integrates over  $y$  using residue theorem and finds

$$\frac{\delta\nu(\epsilon)}{\nu} = -\frac{\text{Gi}}{16} \left( \frac{T_c}{T - T_c} \right)^2 \mathcal{Y}(\epsilon\tau_{\text{GL}}), \quad \mathcal{Y}(z) = \text{Re} \int_0^{+\infty} \frac{dx}{(1+x)(1+2x-2iz)^2}, \quad (374)$$

where  $Gi = \hbar/\nu Db$  is the Ginzburg number. For small deviations from the Fermi energy,  $\varepsilon\tau_{GL} \ll 1$ , the DOS suppression scales as  $\delta\nu(0) \propto -(T/T_c - 1)^{-2}$ , while at larger energies  $\varepsilon\tau_{GL} \gg 1$  DOS approaches its normal value as  $\delta\nu(\varepsilon) \propto -(T_c/\varepsilon)^2 \ln(\varepsilon\tau_{GL})$ . Note also that  $\int d\varepsilon \delta\nu(\varepsilon) \equiv 0$ , which is expected, since the fluctuations only redistribute states around the Fermi energy.

#### 8.4.4 Fluctuation corrections to the conductivity

Superconductive fluctuations above  $T_c$  modify not only the density of states, but also transport properties. In the case of conductivity, there are three types of the corrections, density of states (DOS)  $\delta\sigma_{\text{DOS}}$ , Aslamazov–Larkin (AL)  $\delta\sigma_{\text{AL}}$  and Maki–Thompson (MT)  $\delta\sigma_{\text{MT}}$  terms, see. [155, 156, 157, 162]. Although we have already partially discussed this topic in Section 8.3, the goal of this section is to show explicitly how all of them are obtained within Keldysh  $\sigma$ -model approach.

According to the definition given by (201), to find conductivity one needs to know partition function  $\mathcal{Z}[\mathbf{A}^{cl}, \mathbf{A}^q]$  to the quadratic order in vector potential. Using (312) one finds <sup>19</sup>

$$\mathcal{Z}[\mathbf{A}^{cl}, \mathbf{A}^q] \approx \int \mathbf{D}[\check{Q}, \Delta] \left[ 1 + \frac{\pi\nu D}{2} \text{Tr}\{\check{\mathbf{A}}\check{Q}\check{\mathbf{A}}\check{Q}\} - \frac{(\pi\nu D)^2}{8} \left( \text{Tr}\{\partial_r \check{Q}[\check{\mathbf{A}}, \check{Q}]\} \right)^2 \right] \exp(iS_\sigma[\check{Q}, \Delta]), \quad (375)$$

where diamagnetic contribution  $\text{Tr}\{\check{\mathbf{A}}\check{\mathbf{A}}\}$  was omitted. As it was demonstrated in the Section 6.6.3, by taking  $\check{Q} = \check{\mathbf{A}}$  and using (201) one finds Drude conductivity  $\sigma_D$ . To capture superconductive corrections  $\delta\sigma$  to normal metal conductivity  $\sigma_D$  one has to expand  $\check{Q}$ -matrix in fluctuations  $\check{W}$  to the leading (quadratic) order and analyze all possible contributions.

From the first trace on the right-hand side of (375) by taking one of the  $\check{Q}$  matrices to be  $\check{\mathbf{A}}$ , while expanding the other one to  $\check{W}^2$  order, one finds

$$\mathcal{Z}_{\text{DOS}}[\mathbf{A}^{cl}, \mathbf{A}^q] = \frac{\pi\nu D}{2} \left\langle \left\langle \text{Tr}\{\check{\mathbf{A}}_{\varepsilon_1\varepsilon_2}(\hat{\sigma}_z \otimes \hat{\tau}_z)\check{\mathbf{A}}_{\varepsilon_2\varepsilon_3}(\hat{\sigma}_z \otimes \hat{\tau}_z)\check{W}_{\varepsilon_3\varepsilon_4}\check{W}_{\varepsilon_4\varepsilon_1}\} \right\rangle \right\rangle_{\mathcal{W}, \Delta}, \quad (376)$$

where the current vertex matrix is

$$\check{\mathbf{A}}_{\varepsilon\varepsilon'} \equiv \check{U}_\varepsilon^{-1} \check{\mathbf{A}}_{\varepsilon-\varepsilon'} \check{U}_{\varepsilon'} = \begin{pmatrix} \mathbf{A}_{\varepsilon-\varepsilon'}^{cl} + F_\varepsilon \mathbf{A}_{\varepsilon-\varepsilon'}^q & \mathbf{A}_{\varepsilon-\varepsilon'}^q [F_\varepsilon F_{\varepsilon'} - 1] + \mathbf{A}_{\varepsilon-\varepsilon'}^{cl} [F_{\varepsilon'} - F_\varepsilon] \\ -\mathbf{A}_{\varepsilon-\varepsilon'}^q & \mathbf{A}_{\varepsilon-\varepsilon'}^{cl} - F_{\varepsilon'} \mathbf{A}_{\varepsilon-\varepsilon'}^q \end{pmatrix} \otimes \hat{\tau}_z. \quad (377)$$

It will be shown momentarily, that  $\mathcal{Z}_{\text{DOS}}$  defines density of states type contribution to the conductivity in the vicinity of the critical temperature. Indeed, one substitutes (376) into (201), carries differentiation over the vector potentials, takes the dc limit  $\Omega \rightarrow 0$  and evaluates matrix traces. As a result, one finds

$$\delta\sigma_{\text{DOS}} = \frac{\pi e^2 \nu D}{2} \sum_q \iint \frac{d\varepsilon_2 d\varepsilon_4}{4\pi^2} \partial_{\varepsilon_2} F_{\varepsilon_2} \left\langle \left\langle c_{\varepsilon_2\varepsilon_4}(\mathbf{q}) c_{\varepsilon_4\varepsilon_2}^*(-\mathbf{q}) + \bar{c}_{\varepsilon_2\varepsilon_4}(\mathbf{q}) \bar{c}_{\varepsilon_4\varepsilon_2}^*(-\mathbf{q}) \right\rangle \right\rangle_{\mathcal{W}, \Delta}. \quad (378)$$

As the next step, one uses (435) and performs  $\Delta$  averaging with the help of correlation functions Eq. (370). Changing integration variables  $\varepsilon_2 \rightarrow \varepsilon$  and  $\varepsilon_4 \rightarrow \varepsilon - \omega$ , correction  $\delta\sigma_{\text{DOS}}$  becomes

$$\delta\sigma_{\text{DOS}} = \frac{e^2 D}{2\pi} \text{Im} \sum_q \int_{-\infty}^{+\infty} d\varepsilon d\omega \partial_\varepsilon F_\varepsilon \frac{L^K(\mathbf{q}, \omega) + F_{\varepsilon-\omega} L^R(\mathbf{q}, \omega)}{(Dq^2 - 2i\varepsilon + i\omega)^2}. \quad (379)$$

By comparing this expression to (372) one concludes that  $\delta\sigma_{\text{DOS}} \propto \int d\varepsilon \partial_\varepsilon F_\varepsilon \delta\nu(\varepsilon)$ , which establishes connection between  $\delta\sigma_{\text{DOS}}$  and density of states suppression  $\delta\nu(\varepsilon)$ , see also Figure 19a for diagrammatic representation. In order to extract the most divergent part of  $\delta\sigma_{\text{DOS}}$ , in powers of

<sup>19</sup>Since Coulomb interactions do not lead to a singular temperature dependence for kinetic coefficients in the vicinity of  $T_c$ , we set  $\Phi_{\mathcal{K}} = 0$  and suppress subscript  $\mathcal{K}$  throughout this section.

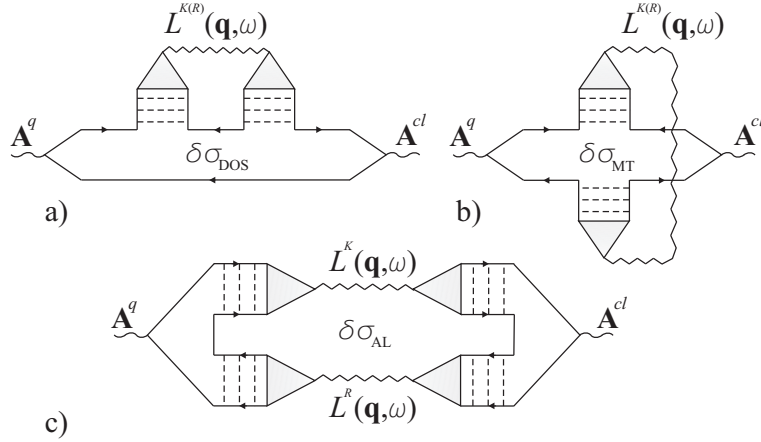

Figure 19: Diagrams for superconductive fluctuation corrections to the conductivity in a vicinity of  $T_c$ : a) density of states term; b) Maki–Thompson correction; c) Aslamazov–Larkin correction.

the deviation  $T - T_c$ , one only needs to keep in (379) Keldysh propagator. The  $F_{\varepsilon-\omega}L^R$  term gives parametrically smaller contribution. Using (444) one finds

$$\delta\sigma_{\text{DOS}} = -\frac{16e^2DT_c^2}{\pi^2} \text{Re} \sum_q \iint_{-\infty}^{+\infty} d\varepsilon d\omega \frac{\partial_\varepsilon F_\varepsilon}{[(Dq^2 + \tau_{\text{GL}}^{-1})^2 + \omega^2][Dq^2 - 2i\varepsilon + i\omega]^2}. \quad (380)$$

After remaining frequency and momentum integrations, for the quasi–two–dimensional case, one finds

$$\frac{\delta\sigma_{\text{DOS}}}{\sigma_D} = -\frac{7\zeta(3)\text{Gi}}{\pi^4} \ln\left(\frac{T_c}{T - T_c}\right). \quad (381)$$

This correction is negative as expected, which stems from the depletion of the density of states by fluctuations, and has relatively weak temperature dependence. It is worth emphasizing that  $\delta\sigma_{\text{DOS}}$  can be extracted from the effective time dependent Ginzburg–Landau theory, which was discussed in the Section 8.3. Indeed, one can show that  $\delta\sigma_{\text{DOS}} = e^2D\langle\delta v_{\mathbf{r},t}^{\text{DOS}}\rangle_\Delta$ , where  $\delta v_{\mathbf{r},t}^{\text{DOS}}$  is taken from (350), reproduces (381).

Let us return back to (375) and look for different possible contributions. Focusing again on the first trace on the right–hand side of (375), one may expand now each of the  $\hat{Q}$  matrices to the first order in fluctuations  $\hat{\mathcal{W}}$ . This way one identifies

$$\mathcal{Z}_{\text{MT}}[\mathbf{A}^{cl}, \mathbf{A}^q] = \frac{\pi\nu D}{2} \left\langle \left\langle \text{Tr} \left\{ \check{\mathbb{A}}_{\varepsilon_1\varepsilon_2} (\hat{\sigma}_z \otimes \hat{\tau}_z) \check{\mathcal{W}}_{\varepsilon_2\varepsilon_3} \check{\mathbb{A}}_{\varepsilon_3\varepsilon_4} (\hat{\sigma}_z \otimes \hat{\tau}_z) \check{\mathcal{W}}_{\varepsilon_4\varepsilon_1} \right\} \right\rangle_{\mathcal{W}, \Delta} \right\rangle, \quad (382)$$

which leads to Maki–Thompson correction to the conductivity. After differentiation of  $\mathcal{Z}_{\text{MT}}[\mathbf{A}^{cl}, \mathbf{A}^q]$  over the vector potential, and evaluation of the traces, in the dc limit, one finds

$$\delta\sigma_{\text{MT}} = \frac{\pi e^2\nu D}{2} \sum_q \iint \frac{d\varepsilon_2 d\varepsilon_4}{4\pi^2} \partial_{\varepsilon_2} F_{\varepsilon_2} \left\langle \left\langle c_{\varepsilon_2\varepsilon_4}(\mathbf{q}) \bar{c}_{\varepsilon_4\varepsilon_2}^*(-\mathbf{q}) + c_{\varepsilon_2\varepsilon_4}^*(\mathbf{q}) \bar{c}_{\varepsilon_4\varepsilon_2}(-\mathbf{q}) \right\rangle_{\mathcal{W}, \Delta} \right\rangle. \quad (383)$$

As compared to  $\delta\sigma_{\text{DOS}}$  in (378)  $\delta\sigma_{\text{MT}}$  consists of products of mixed retarded  $c$  and advanced  $\bar{c}$  Cooperons, while  $\delta\sigma_{\text{DOS}}$  contains Cooperon fields of the same causality. Using (370) and (435) one carries averaging in (383) over  $\Delta$  fluctuations, then changes integration variables in the same way as in (379) and arrives at

$$\delta\sigma_{\text{MT}} = -\frac{e^2D}{\pi} \sum_q \int_{-\infty}^{+\infty} d\varepsilon d\omega \partial_\varepsilon F_\varepsilon \frac{\text{Im}[L^R(\mathbf{q}, \omega)](B_\omega - F_{\varepsilon-\omega})}{(Dq^2)^2 + (2\varepsilon + \omega)^2}. \quad (384)$$

The corresponding diagram is shown in Figure 19b. With the same accuracy as earlier, approximating  $B_\omega \approx 2T_c/\omega$ , neglecting  $F_{\varepsilon-\omega}$  and using (444) for the fluctuations propagator, the latter expression for  $\delta\sigma_{MT}$  reduces to

$$\delta\sigma_{MT} = \frac{16e^2DT_c^2}{\pi^2} \sum_q \iint_{-\infty}^{+\infty} d\varepsilon d\omega \frac{\partial_\varepsilon F_\varepsilon}{[(Dq^2 + \tau_{GL}^{-1})^2 + \omega^2][(Dq^2)^2 + (2\varepsilon + \omega)^2]}. \quad (385)$$

Finally, after the remaining integrations for quasi-two-dimensional case, one finds

$$\frac{\delta\sigma_{MT}}{\sigma_D} = \frac{Gi}{8} \left( \frac{T_c}{T - T_c} \right) \left( \frac{1}{1 - \tau_{GL}/\tau_\phi} \right) \ln \left( \frac{\tau_\phi}{\tau_{GL}} \right), \quad (386)$$

where infrared divergency in momentum integral was cut off by a dephasing rate  $Dq_{\min}^2 = \tau_\phi^{-1}$ . This divergency is a well-known feature of the Maki–Thompson diagram. It can be regularized by some phase-braking mechanism in the Cooper channel. For example, if magnetic impurities are present in the system, then the role of  $\tau_\phi$  is played by the spin-flip time. In contrast to  $\delta\sigma_{DOS}$  Maki–Thompson correction (386) is positive and has much stronger (power law) temperature dependence. Interestingly, that  $\delta\sigma_{MT}$  follows from the effective Ginzburg–Landau theory as well. Indeed, defining  $\delta\sigma_{MT} = e^2\nu\langle\delta D_{\mathbf{r},t,t'}^{MT}\rangle_\Delta$ , employing (347) and performing averaging over  $\Delta$ , one recovers (386).

There is yet another correction to conductivity, called Aslamazov–Larkin contribution. It is obtained from the second trace on the right-hand side of (375). Indeed, expanding each  $\check{Q}$  matrix to the linear order in  $\check{W}$ , one finds

$$\mathcal{Z}_{AL}[\mathbf{A}^{cl}, \mathbf{A}^q] = -\frac{(\pi\nu D)^2}{2} \left\langle \left\langle \left( \text{Tr} \{ \check{A}_{\varepsilon_1\varepsilon_2} (\hat{\sigma}_z \otimes \hat{\tau}_z) \check{W}_{\varepsilon_2\varepsilon_3} \partial_{\mathbf{r}} \check{W}_{\varepsilon_3\varepsilon_1} \} \right)^2 \right\rangle \right\rangle_{\mathcal{W}, \Delta}. \quad (387)$$

It is convenient to introduce two vertices, which follows from (387) after differentiation over the vector potential

$$\begin{aligned} \mathbb{V}_{AL}^{cl}[\check{W}] &= \frac{\delta}{\delta \mathbf{A}^{cl}(\Omega)} \text{Tr} \{ \check{A}_{\varepsilon_1\varepsilon_2} (\hat{\sigma}_z \otimes \hat{\tau}_z) \check{W}_{\varepsilon_2\varepsilon_3} \partial_{\mathbf{r}} \check{W}_{\varepsilon_3\varepsilon_1} \} \\ &= \text{tr} \{ c_{\varepsilon_2\varepsilon_3}(\mathbf{r}) \partial_{\mathbf{r}} c_{\varepsilon_3\varepsilon_2+\Omega}^*(\mathbf{r}) + c_{\varepsilon_2\varepsilon_3}^*(\mathbf{r}) \partial_{\mathbf{r}} c_{\varepsilon_3\varepsilon_2+\Omega}(\mathbf{r}) - (c \rightarrow \bar{c}) \}, \end{aligned} \quad (388a)$$

$$\begin{aligned} \mathbb{V}_{AL}^q[\check{W}] &= \frac{\delta}{\delta \mathbf{A}^q(0)} \text{Tr} \{ \check{A}_{\varepsilon_1\varepsilon_2} (\hat{\sigma}_z \otimes \hat{\tau}_z) \check{W}_{\varepsilon_2\varepsilon_3} \partial_{\mathbf{r}} \check{W}_{\varepsilon_3\varepsilon_1} \} \\ &= -\text{tr} \{ F_{\varepsilon_2}(c_{\varepsilon_2\varepsilon_3}(\mathbf{r}) \partial_{\mathbf{r}} c_{\varepsilon_3\varepsilon_2}^*(\mathbf{r}) + c_{\varepsilon_2\varepsilon_3}^*(\mathbf{r}) \partial_{\mathbf{r}} c_{\varepsilon_3\varepsilon_2}(\mathbf{r}) + (c \rightarrow \bar{c})) \}. \end{aligned} \quad (388b)$$

Notice that for  $\mathbb{V}_{AL}^q$  it is sufficient to take external frequency to be zero right away,  $\Omega = 0$ , while for  $\mathbb{V}_{AL}^{cl}$  it is important to keep finite  $\Omega$  and take the dc limit,  $\Omega \rightarrow 0$ , only after  $\check{W}$  averaging. Performing averaging over Cooperons, one uses (435). In the case of  $\mathbb{V}_{AL}^q[\check{W}]$ , for the product of two Cooper fields it is sufficient to retain only contributions with classical components of the order parameter,  $\mathbb{V}_{AL}^q[\check{W}] \propto \text{Tr} \{ F[c\partial_{\mathbf{r}}c^* + c^*\partial_{\mathbf{r}}c] \} \propto \Delta^{cl}\partial_{\mathbf{r}}\Delta^{*cl} - \Delta^{*cl}\partial_{\mathbf{r}}\Delta^{cl}$ . In contrast, for the  $\mathbb{V}_{AL}^{cl}[\check{W}]$  vertex, it is crucial to keep at least one quantum component of the order parameter  $\Delta^q$ , since the corresponding contribution with two classical components vanishes owing to causality structure. As a result, the leading contribution is  $\mathbb{V}_{AL}^{cl}[\check{W}] \propto \text{Tr} \{ c\partial_{\mathbf{r}}c^* + c^*\partial_{\mathbf{r}}c \} \propto \Delta^{cl}\partial_{\mathbf{r}}\Delta^{*q} + \Delta^q\partial_{\mathbf{r}}\Delta^{*cl} - c.c..$  The remaining  $\Delta$  averaging of the product  $\langle \mathbb{V}_{AL}^{cl}[\check{W}]\mathbb{V}_{AL}^q[\check{W}] \rangle_\Delta$  is done with the help of (370). Passing to the momentum representation and collecting all the factors, Aslamazov–Larkin type correction to conductivity in the dc limit takes the form

$$\delta\sigma_{AL} = \frac{\pi^2 e^2 D}{8T_c^2} \sum_q Dq^2 \int_{-\infty}^{+\infty} \frac{d\omega}{2\pi} \frac{\partial}{\partial\omega} \left[ \coth \frac{\omega}{2T} \right] [\text{Im}L^R(\mathbf{q}, \omega)]^2. \quad (389)$$

The corresponding diagram is shown in Figure 19c. Since only  $Dq^2 \sim \omega \sim \tau_{GL}^{-1} \ll T_c$  are relevant, one may approximate  $\partial_\omega[\coth \omega/2T] \approx -2T_c/\omega^2$  and use  $\text{Im}L^R(\mathbf{q}, \omega) = -(8iT_c\omega/\pi)[(Dq^2 + \tau_{GL}^{-1})^2 + \omega^2]^{-1}$  to obtain

$$\delta\sigma_{AL} = \frac{8e^2DT_c}{\pi} \sum_q \int_{-\infty}^{+\infty} d\omega \frac{Dq^2}{[(Dq^2 + \tau_{GL}^{-1})^2 + \omega^2]^2}. \quad (390)$$

Performing remaining integrations, one finds for the quasi-two-dimensional film

$$\frac{\delta\sigma_{AL}}{\sigma_D} = \frac{\text{Gi}}{16} \left( \frac{T_c}{T - T_c} \right). \quad (391)$$

At the level of effective time-dependent GL functional, Aslamazov–Larkin conductivity correction  $\delta\sigma_{AL}$  appears from the  $S_{SC}$  part of the action (344). The easiest way to see this is to use current

$$\mathbf{j}_{SC} = \frac{\pi e v D}{4T_c} \text{Im}[\Delta^{*cl} \partial_r \Delta^{cl}],$$

which follows from  $S_{SC}$ , along with the fluctuation–dissipation relation  $\delta\sigma_{AL} \propto \langle \mathbf{j}_{SC} \cdot \mathbf{j}_{SC} \rangle_\Delta \propto \sum_{q\omega} Dq^2 |L^R(\mathbf{q}, \omega)|^2$ . The latter reproduces (390).

The technique which was employed within this section allows to reproduce all the results for fluctuations–induced conductivity, known from conventional Matsubara diagrammatic approach. The simplification here is that no analytical continuation was needed. Although it is not so complicated for the problem at hand, in some cases avoiding the analytical continuation may be an advantage.

#### 8.4.5 Tunneling conductance above $T_c$

Consider voltage–biased superconductor–normal metal tunnel junction, where the superconductor is assumed to be at the temperature just above the transition  $T_c$ , i.e. in the fluctuating regime. It is natural to expect that depletion in the density of states, mediated by fluctuations (see Section 8.4.3), modifies current–voltage characteristics of the junction [164, 165, 166]. This effect can be studied within  $\sigma$ –model, using tunneling part of the action  $S_T[\check{Q}_L, \check{Q}_R]$ .

One starts from (179) and performs gauge transformation  $\check{Q}_a \rightarrow \exp(-i\check{\Xi}\check{\Phi}_a)\check{Q}_a \exp(i\check{\Xi}\check{\Phi}_a)$ , for  $a = L, R$ , where  $\check{\Phi}_a(t) = \int^t \check{V}_a(t)dt = [\Phi_a^{cl}(t)\hat{\sigma}_0 + \Phi_a^q(t)\hat{\sigma}_x] \otimes \hat{\tau}_0$ , and  $\Phi_L^{cl} - \Phi_R^{cl} = eVt$ , which moves an applied voltage  $V$  from the Keldysh blocks of the  $\check{Q}$  matrices, to the tunneling part of the action

$$iS_T[\check{Q}_L, \check{Q}_R] = \frac{g_T}{4g_Q} \text{Tr}\{\check{Q}_L e^{-i\check{\Xi}\check{\Phi}} \check{Q}_R e^{i\check{\Xi}\check{\Phi}}\}, \quad (392)$$

here  $\check{\Phi} = \check{\Phi}_L - \check{\Phi}_R$ , and  $\Phi^q(t)$  serves as the generating field. Indeed, since the phase  $\check{\Phi}$  is quantum canonical conjugate to the number of particles  $\check{N} = i\partial/\partial\check{\Phi}$  the tunneling current is obtained by differentiating the partition function  $\mathcal{Z}_T[\check{\Phi}] = \exp(iS_T[\check{Q}_L, \check{Q}_R])$  with respect to the quantum component of the phase

$$I_T(t) = ie \left( \frac{\delta \mathcal{Z}_T[\check{\Phi}]}{\delta \Phi^q(t)} \right)_{\Phi^q=0}. \quad (393)$$

Applying this definition to (392), using

$$\left. \frac{\delta \exp(\pm i\check{\Xi}\check{\Phi})}{\delta \Phi^q(t')} \right|_{\Phi^q=0} = \pm i\delta(t-t') (\hat{\sigma}_x \otimes \hat{\tau}_z) \exp[\pm ieVt\check{\Xi}] \quad (394)$$

and taking  $\check{Q}_L = \check{Q}_R = \check{\Lambda}$ , one finds Ohm’s law  $I_T = g_T V$ , as it should be, for the tunneling junction in the normal state. One may account now for the fluctuation effects by expanding one of the  $\check{Q}$  matrices in (392) over Cooper modes  $\check{W}$ . This leads to the correction of the form

$$\delta I_T(V) = -\frac{\pi g_T}{2e} \sum_q \iint \frac{d\varepsilon d\varepsilon'}{4\pi^2} (F_{\varepsilon+eV} - F_{\varepsilon-eV}) \langle \langle c_{\varepsilon\varepsilon'}(\mathbf{q}) c_{\varepsilon'\varepsilon}^*(-\mathbf{q}) + \bar{c}_{\varepsilon\varepsilon'}(\mathbf{q}) \bar{c}_{\varepsilon'\varepsilon}^*(-\mathbf{q}) \rangle \rangle_{\check{W}, \Delta}, \quad (395)$$

which is physically expected result. Indeed, from the combination of the Cooper modes in (395) one recognizes density of states correction  $\delta\nu(\varepsilon)$ , see (369). The latter is convoluted in (395) with the difference of Fermi functions, leading to the correction to the tunneling current of the form  $\delta I_T(V) \sim \int d\varepsilon [F_{\varepsilon+eV} - F_{\varepsilon-eV}] \delta\nu_L(\varepsilon) \nu_R$ . Using previous result for  $\delta\nu(\varepsilon)$  from (373), bringing it into (395) and transforming to the dimensionless units  $x = Dq^2/T$ ,  $y = \omega/T$ ,  $z = \varepsilon/2T$  one finds for the tunneling differential conductance correction  $\delta g_T(V) = \partial \delta I_T(V)/\partial V$  the following expression:

$$\frac{\delta g_T(V)}{g_T} = \frac{4\text{Gi}}{\pi^3} \int_0^\infty dx \iint_{-\infty}^{+\infty} dy dz \left[ \frac{1}{\cosh^2(z+u)} + \frac{1}{\cosh^2(z-u)} \right] \quad (396)$$

$$\times \text{Re} \left[ \frac{1}{(x+iy-4iz)^2((x+1/T\tau_{\text{GL}})^2+y^2)} \right], \quad (397)$$

where  $u = eV/2T$  and we assumed quasi-two-dimensional geometry. Remaining integrations can be done in the closed form, resulting in [164]

$$\frac{\delta g_T(V)}{g_T} = \frac{\text{Gi}}{\pi^4} \ln \left( \frac{T_c}{T-T_c} \right) \text{Re} \psi^{[2]} \left( \frac{1}{2} - \frac{ieV}{2\pi T} \right), \quad (398)$$

where  $\psi^{[2]}(x)$  is the second order derivative of the digamma function  $\psi(x)$ . Notice, that although having direct relation to the density of states suppression  $\delta\nu(\varepsilon)$ , the differential conductance correction  $\delta g_T$  exhibits much weaker temperature dependence. The sharp suppression in the density of states  $\delta\nu(0) \propto (T-T_c)^{-2}$  translates only into the moderate logarithmic in temperature correction  $\delta g_T \propto \ln(T_c\tau_{\text{GL}})$ . Another interesting feature is that suppression of the  $\delta\nu(\varepsilon)$  occurs at the energies  $\varepsilon \sim \tau_{\text{GL}}^{-1} \sim T-T_c$ , while corresponding suppression of the differential conductance happens at voltages  $V \sim T_c$ , and not at  $V \sim T-T_c$ . Finally one should mention, that more singular in  $(T-T_c)$  MT and AL corrections appear only in the fourth order in the tunneling matrix elements, while the discussed DOS effect is linear in  $g_T$  (i.e. it is of the second order in the tunneling matrix elements).

#### 8.4.6 Current noise in fluctuating regime

Apart from the density of states related effects, there are interesting consequences of superconducting fluctuations on the current noise of the tunneling junction [151, 167, 168, 169, 170]. Assume now that both sides of the junction are made from identical superconductors that are kept right above  $T_c$ . While there is no average Josephson current in this case, the noise power turns out to be sensitive to the Josephson frequency,  $\omega_J = 2eV/\hbar$ , and exhibits sharp peak at  $\omega = \omega_J$ . The height and shape of this peak have a singular temperature dependence near  $T_c$ , which makes its experimental detection possible. To show this we establish an expression for the fluctuating part of the tunneling current  $\delta I_T(t)$  in terms of the product of fluctuating order parameters  $\Delta_{L(R)}(\mathbf{r}, t)$  residing on the different sides of the junction, namely  $\delta I_T(t) \propto \int d\mathbf{r} [\Delta_R(\mathbf{r}, t) \Delta_L^*(\mathbf{r}, t) \exp(-i\omega_J t) - c.c.]$ . Since  $\langle \Delta_{L(R)} \rangle = 0$  above  $T_c$ , it is clear that  $\langle \delta I_T(t) \rangle = 0$ . However, the average square of the current  $\langle \delta I_T(t) \delta I_T(t') \rangle$  is not vanishing and its Fourier transform displays a peak at the Josephson frequency. In what follows we calculate its temperature dependence.

One starts from the definition of the current-current correlation function

$$S_T(\omega) = -e^2 \int_{-\infty}^{+\infty} d(t-t') \left( \frac{\delta^2 \mathcal{Z}_T[\Phi]}{\delta \Phi^q(t) \delta \Phi^q(t')} \right)_{\Phi^q=0} e^{-i\omega(t-t')}. \quad (399)$$

In the normal state  $\check{Q}_L = \check{Q}_R = \check{\Lambda}$  and the noise power of the tunneling junction, as it follows from (399), is given by the Schottky formula  $S_T(\omega) = 2g_T T \sum_{\pm} v_{\pm} \coth v_{\pm}$ , where  $v_{\pm} = (eV \pm \omega)/2T$ . To account for the superconductive fluctuations on both sides of the junction one has to expand each of the  $\check{Q}$  matrices in (392) to the leading (linear) order in Cooper modes. This gives for the fluctuation correction to the current

$$\delta I_T(t) = \frac{i\pi g_T}{4e} \frac{\delta}{\delta \Phi^q(t)} \text{Tr} \left\{ e^{i\check{\Phi}} \check{U}(\hat{\sigma}_z \otimes \hat{\tau}_z) \check{W}_L \check{U}^{-1} e^{-i\check{\Phi}} \check{U}(\hat{\sigma}_z \otimes \hat{\tau}_z) \check{W}_R \check{U}^{-1} \right\}. \quad (400)$$

To proceed further, one simplifies (400), exploring separation of time scales between electronic and order parameter degrees of freedom. Indeed, one should notice that, as follows from (444), the relevant energies and momenta for the order–parameter variations are  $Dq^2 \sim \omega \sim \tau_{\text{GL}}^{-1}$ , while the relevant fermionic energies entering the Cooperons are  $\epsilon \sim \epsilon' \sim T \gg \tau_{\text{GL}}^{-1}$ . As a result, non–local relations between Cooper modes (337) and the order parameter, see Eqs. (435), may be approximated as

$$\begin{aligned} \check{W}_{t't'}^a(\mathbf{r}) &\approx -i\hat{\Theta}_{t't'} \otimes \hat{\Delta}_{t't'}^a(\mathbf{r}), \quad \hat{\Theta}_{t't'} = \begin{pmatrix} \theta(t-t') & 0 \\ 0 & -\theta(t'-t) \end{pmatrix}_K, \\ \hat{\Delta}_{t't'}^a(\mathbf{r}) &= \Delta_a^{cl}\left(\mathbf{r}, \frac{t+t'}{2}\right)\hat{\tau}_+ + \Delta_a^{*cl}\left(\mathbf{r}, \frac{t+t'}{2}\right)\hat{\tau}_-, \quad a = L, R, \end{aligned} \quad (401)$$

where  $\theta(t)$  is the step function. Physically (401) implies that Cooperon is short–ranged, having characteristic length scale  $\xi_0 = \sqrt{D/T_c}$ , as compared to the long–ranged fluctuations of the order parameter, which propagates to the distances of the order of  $\xi_{\text{GL}} = \sqrt{D\tau_{\text{GL}}} \gg \xi_0$ . Thus, relations (435) are effectively local, which considerably simplifies the further analysis. Equations (401) allow us to trace Keldysh subspace in (400) explicitly to arrive at

$$\delta I_T(t) = -\frac{\pi g_T}{e} \text{Tr} \left\{ \theta(t_2 - t_1) F_{t_1-t} \theta(t - t_2) \hat{\Delta}_{t_2}^L \hat{\tau}_z \hat{\Delta}_{t_2 t_1}^R e^{ieV(t+t_2)\hat{\tau}_z} \right\}_N, \quad (402)$$

where we have used (394) and wrote trace in the real space–time representation (note that  $\text{Tr}\{\dots\}$  here does not imply time  $t$  integration). Changing integration variables  $t_1 = t - \mu$  and  $t_2 = t - \eta$ , and rescaling  $\eta, \mu$  in the units of temperature  $T\eta \rightarrow \eta, T\mu \rightarrow \mu$ , one finds for Eq. (402) an equivalent representation,

$$\delta I_T(t) = -\frac{i\pi g_T}{eT} \int_{-\infty}^{+\infty} d\eta d\mu \frac{\theta(\eta)\theta(\mu-\eta)}{\sinh(\pi\mu)} \text{Tr} \left\{ \hat{\Delta}_{t, t-\frac{\eta}{T}}^L \hat{\tau}_z \hat{\Delta}_{t-\frac{\eta}{T}, t-\frac{\mu}{T}}^R e^{ieV(2t-\frac{\eta}{T})\hat{\tau}_z} \right\}_N, \quad (403)$$

where we used equilibrium fermionic distribution function in the time domain  $F_t = -iT/\sinh(\pi Tt)$ . The most significant contribution to the above integrals comes from  $\eta \sim \mu \lesssim 1$ . At this range ratios  $\{\eta, \mu\}/T$  change on the scale of inverse temperature, while as we already discussed, order–parameter variations are set by  $t \sim \tau_{\text{GL}} \gg 1/T$ . Thus, performing  $\eta$  and  $\mu$  integrations one may neglect  $\{\eta, \mu\}/T$  dependence of the order parameters and the exponent. As a result one finds

$$\delta I_T(t) = \frac{i\pi g_T}{4eT} \int \frac{d^2\mathbf{r}}{\mathcal{A}} \left[ \Delta_R^{cl}(\mathbf{r}, t) \Delta_L^{*cl}(\mathbf{r}, t) e^{-i\omega_J t} - c.c. \right], \quad (404)$$

where the spatial integration runs over the junction area  $\mathcal{A}$  and  $\omega_J = 2eV/\hbar$ . Finally one is ready to calculate corresponding contribution to the current noise. One substitutes two currents in the form of (404) into (399) and pairs fluctuating order parameters using the correlation function, which follows from (370),

$$\langle \Delta_a^{cl}(\mathbf{r}, t) \Delta_b^{*cl}(\mathbf{r}', t') \rangle_\Delta = \frac{i}{2v} \delta_{ab} L^K(\mathbf{r} - \mathbf{r}', t - t').$$

As a result, superconducting fluctuation correction to the noise power is given by

$$\delta \mathcal{S}_T(\omega) = -\frac{1}{4v^2} \left( \frac{\pi g_T}{4eT_c} \right)^2 \sum_{\pm} \int \frac{d^2\mathbf{r}}{\mathcal{A}} \int_{-\infty}^{+\infty} dt [L^K(\mathbf{r}, t)]^2 \exp(-i\omega_{\pm} t), \quad (405)$$

where  $\omega_{\pm} = \omega \pm \omega_J$ . Performing the remaining integrations one finds first Keldysh component of the fluctuation propagator in the mixed momentum/time representation  $L^K(\mathbf{q}, t) = \int L^K(\mathbf{q}, \omega) e^{-i\omega t} d\omega/2\pi$ , which is

$$L^K(\mathbf{q}, t) = -\frac{2iT_c^2}{T - T_c} \frac{e^{-\varkappa_q |t|/\tau_{\text{GL}}}}{\varkappa_q}, \quad \varkappa_q = (\xi_{\text{GL}} q)^2 + 1. \quad (406)$$



Then insert  $L^K(\mathbf{r}, t) = \int L^K(\mathbf{q}, t) e^{i\mathbf{q}\mathbf{r}} d^2q / 4\pi$  into (405), introduces dimensionless time  $\tau = t/\tau_{GL}$ , and changes from  $q$  to  $\kappa_q$  integration  $dq^2 = d\kappa_q/\xi_{GL}^2$ , which gives altogether [170]

$$\delta\mathcal{S}_T(\omega) = \sum_{\pm} \frac{\pi G i^2}{64 T_c} \left( \frac{g_T T_c}{e} \right)^2 \frac{\xi_0^2}{\mathcal{A}} \left( \frac{T_c}{T - T_c} \right)^2 \mathcal{N}(\omega_{\pm} \tau_{GL}), \quad (407)$$

where the spectral function is given by

$$\mathcal{N}(z) = \int_{-\infty}^{+\infty} d\tau \int_1^{+\infty} \frac{d\kappa}{\kappa^2} \exp(-2\kappa|\tau| - iz\tau) = \frac{4}{z^2} \ln \sqrt{1 + z^2/4}. \quad (408)$$

The noise power correction  $\delta\mathcal{S}_T(\omega)$  is peaked at the Josephson frequency  $\omega = \pm\omega_J$  and has strong temperature dependence, which makes its experimental detection possible in a vicinity of the superconducting transition.

## 9 Concluding remarks and acknowledgments

We have attempted to review various ingredients and elements of the Keldysh technique in applications to systems of interacting bosons and fermions. The emphasis has been on the functional integral representation of microscopic models and some modern developments, such as non-linear  $\sigma$ -model. Our motivation was not to review some specific area of physics, where Keldysh technique may be applied successfully, but rather to focus on exposing the method itself. The goal was to give a broad perspective of the technique and its applications. To accomplish this goal we have (rather subjectively) chosen examples from mesoscopic physics of normal metals as well superconducting kinetics. We hope that this review may serve as a learning source for interested graduate students and a reference point for experts.

We benefited greatly from collaboration and discussions with many of our colleagues: I. Aleiner, A. Altland, A. Andreev, M. Feigel'man, Y. Gefen, L. Glazman, A. I. Larkin, I. Lerner, M. Skvortsov and many others who shaped this paper. While writing this review, communications with D. Bagrets, I. Burmistrov, G. Catelani, A. Chudnovskiy, M. Khodas, and A. Varlamov were especially helpful. This work was supported by NSF Grants DMR-0405212 and DMR-0804266. A. L. was supported by the Doctoral Dissertation Fellowship from the University of Minnesota.

## A Gaussian integrals for bosons and fermions

For any complex  $N \times N$  matrix  $A_{ij}$ , where  $i, j = 1, \dots, N$ , such that all its eigenvalues,  $\lambda_i$ , have a positive real part,  $\text{Re}\lambda_i > 0$ , the following statement holds

$$Z[J] = \iint_{-\infty}^{+\infty} \prod_{j=1}^N \frac{d(\text{Re}z_j)d(\text{Im}z_j)}{\pi} \exp\left(-\sum_{ij} \bar{z}_i A_{ij} z_j + \sum_j [\bar{z}_j J_j + \bar{J}_j z_j]\right) = \frac{\exp\left(\sum_{ij} \bar{J}_i (A^{-1})_{ij} J_j\right)}{\text{Det}(A)}, \quad (409)$$

where  $J_j$  is an arbitrary complex vector. To prove it, one may start from a Hermitian matrix, that is diagonalized by a unitary transformation:  $A = U^\dagger \Lambda U$ , where  $\Lambda = \text{diag}\{\lambda_j\}$ . The identity is then easily proven by a change of variables (with unit Jacobian) to  $w_i = U_{ij} z_j$ . Finally, one notices that the right-hand side of (409) is an analytic function of both  $\text{Re}A_{ij}$  and  $\text{Im}A_{ij}$ . Therefore, one may continue them analytically to the complex plane to reach an arbitrary complex matrix  $A_{ij}$ . The identity (409) is thus valid as long as the integral is well defined, that is all the eigenvalues of  $A_{ij}$  have a positive real part.

The Wick theorem deals with the average value of a string  $z_{a_1} \dots z_{a_k} \bar{z}_{b_1} \dots \bar{z}_{b_k}$  weighted with the factor  $\exp(-\sum_{ij} \bar{z}_i A_{ij} z_j)$ . The theorem states that this average is given by the sum of all possible products of pair-wise averages. For example,

$$\begin{aligned} \langle z_a \bar{z}_b \rangle &\equiv \frac{1}{Z[0]} \left. \frac{\delta^2 Z[J]}{\delta \bar{J}_a \delta J_b} \right|_{J=0} = (A^{-1})_{ab}, \\ \langle z_a z_b \bar{z}_c \bar{z}_d \rangle &\equiv \frac{1}{Z[0]} \left. \frac{\delta^4 Z[J]}{\delta \bar{J}_a \delta \bar{J}_b \delta J_c \delta J_d} \right|_{J=0} = A_{ac}^{-1} A_{bd}^{-1} + A_{ad}^{-1} A_{bc}^{-1}, \end{aligned} \quad (410)$$

and so on.

The Gaussian identity for integration over real variables has the form

$$Z[J] = \int_{-\infty}^{+\infty} \prod_{j=1}^N \frac{dx_j}{\sqrt{\pi}} \exp\left(-\sum_{ij} x_i A_{ij} x_j + 2 \sum_j x_j J_j\right) = \frac{\exp\left(\sum_{ij} J_i (A^{-1})_{ij} J_j\right)}{\sqrt{\text{Det}(A)}}, \quad (411)$$

where  $A$  is a *symmetric* complex matrix with all its eigenvalues having a positive real part. The proof is similar to the proof in the case of complex variables: one starts from a real symmetric matrix, that may be diagonalized by an orthogonal transformation. The identity (411) is then easily proved by the change of variables. Finally, one may analytically continue the right-hand side (as long as the integral is well defined) from a real symmetric matrix  $A_{ij}$ , to a *complex symmetric* matrix.

For an integration over two sets of *independent* Grassmann variables,  $\bar{\xi}_j$  and  $\xi_j$ , where  $j = 1, 2, \dots, N$ , the Gaussian identity is valid for *any invertible* complex matrix  $A$

$$Z[\bar{\chi}, \chi] = \iint \prod_{j=1}^N d\bar{\xi}_j d\xi_j \exp\left(-\sum_{ij} \bar{\xi}_i A_{ij} \xi_j + \sum_j [\bar{\xi}_j \chi_j + \bar{\chi}_j \xi_j]\right) = \text{Det}(A) \exp\left(\sum_{ij} \bar{\chi}_i (A^{-1})_{ij} \chi_j\right). \quad (412)$$

Here  $\bar{\chi}_j$  and  $\chi_j$  are two additional mutually independent (and independent from  $\bar{\xi}_j$  and  $\xi_j$ ) sets of Grassmann numbers. The proof may be obtained by, e.g., brute force expansion of the exponential factors, while noticing that only terms that are linear in *all*  $2N$  variables  $\bar{\xi}_j$  and  $\xi_j$  are non-zero. The Wick theorem is formulated in the same manner as for the bosonic case, with the exception that every combination is multiplied by the parity of the corresponding permutation. For example, the first term on the right-hand side of the second expression of (410) comes with the minus sign.

## B Single particle quantum mechanics

The simplest many-body system of a single bosonic state (considered in Section 2) is, of course, equivalent to a single-particle harmonic oscillator. To make this connection explicit, consider the

Keldysh contour action (15) with the correlator (17) written in terms of the complex field  $\phi(t)$ . The latter may be parameterized by its real and imaginary parts as

$$\phi(t) = \frac{1}{\sqrt{2\omega_0}} (p(t) - i\omega_0 q(t)), \quad \bar{\phi}(t) = \frac{1}{\sqrt{2\omega_0}} (p(t) + i\omega_0 q(t)). \quad (413)$$

In terms of the real fields  $p(t)$  and  $q(t)$  the action (15) takes the form

$$S[p, q] = \int_C dt \left[ p \dot{q} - \frac{1}{2} (p^2 + \omega_0^2 q^2) \right], \quad (414)$$

where the full time derivatives of  $p^2$ ,  $q^2$  and  $pq$  were omitted, since they contribute only to the boundary terms, not written explicitly in the continuum notation (they have to be kept for the proper regularization). Equation (414) is nothing but the action of the quantum harmonic oscillator in the Hamiltonian form. One may perform the Gaussian integration over the  $p(t)$  field to obtain

$$S[q] = \frac{1}{2} \int_C dt [\dot{q}^2 - \omega_0^2 q^2]. \quad (415)$$

This is the Feynman Lagrangian action of the harmonic oscillator, written on the Keldysh contour. It may be generalized for an arbitrary single-particle potential  $U(q)$

$$S[q(t)] = \int_C dt \left[ \frac{1}{2} (\dot{q}(t))^2 - U(q(t)) \right]. \quad (416)$$

One may split the  $q(t)$  field into two components,  $q_+(t)$  and  $q_-(t)$ , residing on the forward and backward branches of the contour, and then perform the Keldysh rotation:  $q_{\pm} = q^{cl} \pm q^q$ . In terms of these fields the action takes the form

$$S[q^{cl}, q^q] = \int_{-\infty}^{+\infty} dt \left[ -2q^q \frac{d^2 q^{cl}}{dt^2} - U(q^{cl} + q^q) + U(q^{cl} - q^q) \right], \quad (417)$$

where integration by parts was performed in the term  $\dot{q}^q \dot{q}^{cl}$ . This is the Keldysh form of the Feynman path integral. The omitted boundary terms provide a convergence factor of the form  $\sim i0(q^q)^2$ .

If the fluctuations of the quantum component  $q^q(t)$  are regarded as small, one may expand the potential to the first order and find for the action

$$S[q^{cl}, q^q] = \int_{-\infty}^{+\infty} dt \left[ -2q^q \left( \frac{d^2 q^{cl}}{dt^2} + \frac{\partial U(q^{cl})}{\partial q^{cl}} \right) + i0(q^q)^2 + O[(q^q)^3] \right]. \quad (418)$$

In this limit the integration over the quantum component,  $q^q$ , may be explicitly performed, leading to a functional  $\delta$ -function of the expression in the round brackets. This  $\delta$ -function enforces the classical Newtonian dynamics of  $q^{cl}$

$$\frac{d^2 q^{cl}}{dt^2} = -\frac{\partial U(q^{cl})}{\partial q^{cl}}. \quad (419)$$

For this reason the symmetric (over forward and backward branches) part of the Keldysh field is called the classical component. The quantum-mechanical information is contained in the higher-order terms in  $q^q$ , omitted in (418). Note that for the harmonic oscillator potential the terms denoted as  $O[(q^q)^3]$  are absent identically. The quantum (semiclassical) information resides, thus, in the convergence term,  $i0(q^q)^2$ , as well as in the retarded regularization of the  $d^2/(dt^2)$  operator in (418).

One may generalize the single-particle quantum mechanics onto a chain (or lattice) of harmonically coupled particles by assigning an index  $\mathbf{r}$  to particle coordinates,  $q_{\mathbf{r}}(t)$ , and adding the spring

potential energy,  $\frac{v_s^2}{2}(q_{\mathbf{r}+1}(t) - q_{\mathbf{r}}(t))^2$ . Changing to spatially continuum notation,  $\phi(\mathbf{r}, t) \equiv q_{\mathbf{r}}(t)$ , one finds for the Keldysh action of the real (e.g. phonon) field

$$S[\phi] = \int d\mathbf{r} \int_C dt \left[ \frac{1}{2} \dot{\phi}^2 - \frac{v_s^2}{2} (\partial_{\mathbf{r}} \phi)^2 - U(\phi) \right], \quad (420)$$

where the constant  $v_s$  has the meaning of the sound velocity. Finally, splitting the field into  $(\phi_+, \phi_-)$  components and performing the Keldysh transformation,  $\phi_{\pm} = \phi^{cl} \pm \phi^q$ , and integrating by parts, one obtains

$$S[\phi^{cl}, \phi^q] = \int d\mathbf{r} \int_{-\infty}^{+\infty} dt \left[ 2\phi^q (-\partial_t^2 + v_s^2 \partial_{\mathbf{r}}^2) \phi^{cl} - U(\phi^{cl} + \phi^q) + U(\phi^{cl} - \phi^q) \right]. \quad (421)$$

According to the general structure of the Keldysh theory the differential operator  $(-\partial_t^2 + v_s^2 \partial_{\mathbf{r}}^2)$ , should be understood as the retarded one. This means it is a lower-triangular matrix in the time domain. Actually, one may symmetrize the action by performing the integration by parts, and write it as  $\phi^q (-\partial_t^2 + v_s^2 \partial_{\mathbf{r}}^2)^R \phi^{cl} + \phi^{cl} (-\partial_t^2 + v_s^2 \partial_{\mathbf{r}}^2)^A \phi^q$ , with the advanced regularization in the second term.

## C Gradient expansion of the $\sigma$ -model

This Appendix serves as the complementary material for Section 6.2. Its purpose is to provide technical details hidden behind the transition from (173) to (174). For the gradient expansion of the logarithm in (173) one uses  $\hat{Q}$  matrix in the form of (167) and finds in analogy with (168):

$$iS[\hat{Q}, \mathbf{A}, V] = \text{Tr} \ln \left[ \hat{1} + i\hat{\mathcal{G}}\hat{\mathcal{R}}\partial_t\hat{\mathcal{R}}^{-1} + i\hat{\mathcal{G}}\hat{\mathcal{R}}\mathbf{v}_F\partial_{\mathbf{r}}\hat{\mathcal{R}}^{-1} + \hat{\mathcal{G}}\hat{\mathcal{R}}\hat{V}\hat{\mathcal{R}}^{-1} + \hat{\mathcal{G}}\hat{\mathcal{R}}\mathbf{v}_F\hat{\mathbf{A}}\hat{\mathcal{R}}^{-1} \right]. \quad (422)$$

Expanding this expression to the linear order in  $\hat{\mathcal{G}}\hat{\mathcal{R}}\partial_t\hat{\mathcal{R}}^{-1}$  and quadratic in  $\hat{\mathcal{G}}\hat{\mathcal{R}}\mathbf{v}_F\partial_{\mathbf{r}}\hat{\mathcal{R}}^{-1}$ , one reproduces (171) for  $S[\hat{Q}]$ , which leads eventually to (172). To the linear order in  $\hat{V}$  and  $\hat{\mathbf{A}}$  one finds from (422)

$$iS_1[\hat{Q}, \mathbf{A}, V] = \text{Tr}\{\hat{\mathcal{G}}\hat{\mathcal{R}}\hat{V}\hat{\mathcal{R}}^{-1}\} - i\text{Tr}\{\hat{\mathcal{G}}(\hat{\mathcal{R}}\mathbf{v}_F\partial_{\mathbf{r}}\hat{\mathcal{R}}^{-1})\hat{\mathcal{G}}(\hat{\mathcal{R}}\mathbf{v}_F\hat{\mathbf{A}}\hat{\mathcal{R}}^{-1})\}. \quad (423)$$

In view of  $\sum_p \hat{\mathcal{G}}(\mathbf{p}, \epsilon) = -i\pi\nu\hat{\Lambda}_\epsilon$ , which follows from the saddle point Equation (162), for the first term on the right-hand side of (423) one finds, using cyclic property of trace  $\text{Tr}\{\hat{\mathcal{G}}\hat{\mathcal{R}}\hat{V}\hat{\mathcal{R}}^{-1}\} = -i\pi\nu\text{Tr}\{\hat{\mathcal{R}}^{-1}\hat{\Lambda}\hat{\mathcal{R}}\hat{V}\} = -i\pi\nu\text{Tr}\{\hat{V}\hat{Q}\}$ . As to the second term on the right-hand side of (423), retaining retarded-advanced products of the Green functions  $\sum_p \mathcal{G}^R(\mathbf{p}, \epsilon)\mathbf{v}_F\mathcal{G}^A(\mathbf{p}, \epsilon)\mathbf{v}_F = 2\pi\nu D$ , one finds

$$\text{Tr}\{\hat{\mathcal{G}}(\hat{\mathcal{R}}\mathbf{v}_F\partial_{\mathbf{r}}\hat{\mathcal{R}}^{-1})\hat{\mathcal{G}}(\hat{\mathcal{R}}\mathbf{v}_F\hat{\mathbf{A}}\hat{\mathcal{R}}^{-1})\} = -\pi\nu D \text{Tr}\{(\hat{\mathcal{R}}^{-1}\partial_{\mathbf{r}}\hat{\mathcal{R}} + \hat{\mathcal{R}}^{-1}\hat{\Lambda}\hat{\mathcal{R}}\partial_{\mathbf{r}}\hat{\mathcal{R}}^{-1}\hat{\Lambda}\hat{\mathcal{R}})\hat{\mathbf{A}}\} = -\pi\nu D \text{Tr}\{\hat{\mathbf{A}}\hat{Q}\partial_{\mathbf{r}}\hat{Q}\},$$

where  $\hat{\mathcal{R}} \circ \partial_{\mathbf{r}}\hat{\mathcal{R}}^{-1} = -\partial_{\mathbf{r}}\hat{\mathcal{R}} \circ \hat{\mathcal{R}}^{-1}$  was used. All together it gives for (423)

$$iS_1[\hat{Q}, \mathbf{A}, V] = -i\pi\nu\text{Tr}\{\hat{V}\hat{Q}\} + i\pi\nu D \text{Tr}\{\hat{\mathbf{A}}\hat{Q}\partial_{\mathbf{r}}\hat{Q}\}. \quad (424)$$

To the second order in  $\hat{V}$  and  $\hat{\mathbf{A}}$  one finds

$$iS_2[\hat{Q}, \mathbf{A}, V] = -\frac{1}{2}\text{Tr}\{\hat{\mathcal{G}}\hat{V}\hat{\mathcal{G}}\hat{V}\} - \frac{1}{2}\text{Tr}\{\hat{\mathcal{G}}(\hat{\mathcal{R}}\mathbf{v}_F\hat{\mathbf{A}}\hat{\mathcal{R}}^{-1})\hat{\mathcal{G}}(\hat{\mathcal{R}}\mathbf{v}_F\hat{\mathbf{A}}\hat{\mathcal{R}}^{-1})\}. \quad (425)$$

Note that in the term  $\sim \hat{V}^2$  we took  $\hat{\mathcal{R}} = \hat{\mathcal{R}}^{-1} = \hat{1}$ . This is because  $\sim \hat{V}^2$  contribution represents essentially static compressibility of the electron gas which is determined by the entire energy band, while  $\hat{\mathcal{R}}$  and  $\hat{\mathcal{R}}^{-1}$  matrices are different from unit matrix only in the narrow energy strip around the Fermi energy. Thus, for the first term on the right-hand side of (425) one can write  $\text{Tr}\{\hat{\mathcal{G}}\hat{V}\hat{\mathcal{G}}\hat{V}\} = \text{Tr}\{V^\alpha \hat{\Upsilon}^{\alpha\beta} V^\beta\}$ , where

$$\hat{\Upsilon}^{\alpha\beta} = -\frac{1}{2} \sum_p \int \frac{d\epsilon}{2\pi} \text{Tr}\{\hat{\mathcal{G}}(\mathbf{p}, \epsilon_+) \hat{\Upsilon}^\alpha \hat{\mathcal{G}}(\mathbf{p}, \epsilon_-) \hat{\Upsilon}^\beta\}, \quad \epsilon_{\pm} = \epsilon \pm \omega/2, \quad (426)$$

and trace spans only over the Keldysh matrix structure. Using (169) for the matrix Green function, and retaining only retarded–retarded and advanced–advanced products one finds

$$\hat{\Upsilon}^{\alpha\beta} = -\frac{1}{8} \sum_p \int \frac{d\epsilon}{2\pi} \text{Tr} \{ (\mathcal{G}^R)^2 [\hat{1} + \hat{\Lambda}_{\epsilon_+}] \hat{\gamma}^\alpha [\hat{1} + \hat{\Lambda}_{\epsilon_-}] \hat{\gamma}^\beta + (\mathcal{G}^A)^2 [\hat{1} - \hat{\Lambda}_{\epsilon_+}] \hat{\gamma}^\alpha [\hat{1} - \hat{\Lambda}_{\epsilon_-}] \hat{\gamma}^\beta \} = iv \hat{\sigma}_x^{\alpha\beta}. \quad (427)$$

This result is derived noticing that  $[\mathcal{G}^{R(A)}(\mathbf{p}, \epsilon)]^2 = -\partial_\epsilon \mathcal{G}^{R(A)}(\mathbf{p}, \epsilon)$ , and integrating by parts

$$\int d\epsilon F_\epsilon \sum_p \left[ [\mathcal{G}^R(\mathbf{p}, \epsilon)]^2 - [\mathcal{G}^A(\mathbf{p}, \epsilon)]^2 \right] = \int d\epsilon \frac{\partial F_\epsilon}{\partial \epsilon} \sum_p \left[ \mathcal{G}^R(\mathbf{p}, \epsilon) - \mathcal{G}^A(\mathbf{p}, \epsilon) \right] = -4i\pi\nu, \quad (428)$$

using  $\sum_p (\mathcal{G}^R(\mathbf{p}, \epsilon) - \mathcal{G}^A(\mathbf{p}, \epsilon)) = -2\pi i\nu$  and assuming that  $F_{\epsilon \rightarrow \pm\infty} \rightarrow \pm 1$ . An additional contribution to  $\hat{\Upsilon}^{\alpha\beta}$ , originating from the retarded–advanced products of Green’s functions, although non–zero, contains an extra small factor  $\omega\tau_{\text{el}} \ll 1$ , and thus neglected.

For the second term on the right hand side of (425) one finds  $\text{Tr}\{\hat{\mathcal{G}}(\hat{\mathcal{R}}\mathbf{v}_F\hat{\mathbf{A}}\hat{\mathcal{R}}^{-1})\hat{\mathcal{G}}(\hat{\mathcal{R}}\mathbf{v}_F\hat{\mathbf{A}}\hat{\mathcal{R}}^{-1})\} = \pi\nu D \text{Tr}\{[\hat{1} + \hat{\Lambda}]\hat{\mathcal{R}}\hat{\mathbf{A}}\hat{\mathcal{R}}^{-1}[\hat{1} - \hat{\Lambda}]\hat{\mathcal{R}}\hat{\mathbf{A}}\hat{\mathcal{R}}^{-1}\} = \pi\nu D \text{Tr}\{\hat{\mathbf{A}}^2 - \hat{\mathbf{A}}\hat{\mathcal{Q}}\hat{\mathbf{A}}\hat{\mathcal{Q}}\}$ , which finally gives for the  $S_2[\hat{\mathcal{Q}}, \mathbf{A}, V]$  part of the action

$$iS_2[\hat{\mathcal{Q}}, \mathbf{A}, V] = -\frac{\nu}{2} \text{Tr}\{\hat{V}\hat{\sigma}_x\hat{V}\} + \frac{\pi\nu D}{2} \text{Tr}\{\hat{\mathbf{A}}\hat{\mathcal{Q}}\hat{\mathbf{A}}\hat{\mathcal{Q}} - \hat{\mathbf{A}}^2\}. \quad (429)$$

Combining now (172) together with  $S_1[\hat{\mathcal{Q}}, \mathbf{A}, V]$ , and  $S_2[\hat{\mathcal{Q}}, \mathbf{A}, V]$ , and taking into account that  $\text{Tr}\{(\partial_r\hat{\mathcal{Q}})^2 - 4i\hat{\mathbf{A}}\hat{\mathcal{Q}}\partial_r\hat{\mathcal{Q}} - 2(\hat{\mathbf{A}}\hat{\mathcal{Q}}\hat{\mathbf{A}}\hat{\mathcal{Q}} - \hat{\mathbf{A}}^2)\} = \text{Tr}\{(\hat{\partial}_r\hat{\mathcal{Q}})^2\}$ , where covariant derivative is defined according to (175), one finds the full action in the form of (174).

## D Expansion over superconducting fluctuations

In this section we provide details of the Gaussian integration over the Cooper modes performed in (338). Throughout this section we suppress subscript– $\mathcal{K}$  in  $\check{Q}_{\mathcal{K}}$  and  $\Delta_{\mathcal{K}}$  for brevity. As a first step one expands (312) in fluctuations  $\check{W}$  around the metallic saddle point  $\check{Q} = \check{\Lambda}$ :  $S[\check{Q}, \Delta] \Rightarrow S[\check{W}, \Delta]$ . To this end, we take  $\check{W}$  from (337) and substitute it into (312c). For the spatial gradient part of the action  $S_\sigma$  one finds in quadratic order  $\text{Tr}\{(\partial_r\check{Q})^2\} = \text{Tr}\{\check{W}_{\epsilon\epsilon'}\partial_r^2\check{W}_{\epsilon'\epsilon}\}$ . Tracing the latter over Keldysh $\otimes$ Nambu space gives

$$D \text{Tr}\{(\partial_r\check{Q})^2\} = 2 \sum_q \iint \frac{d\epsilon d\epsilon'}{4\pi^2} Dq^2 [c_{\epsilon\epsilon'}^*(\mathbf{q})c_{\epsilon'\epsilon}(-\mathbf{q}) + \bar{c}_{\epsilon\epsilon'}^*(\mathbf{q})\bar{c}_{\epsilon'\epsilon}(-\mathbf{q})], \quad (430)$$

where we kept only Cooper modes  $c$  and  $\bar{c}$ , while omitting the diffuson modes  $d$  and  $\bar{d}$ , since expansion for the latter was already given in (187). For the time derivative term in the action  $S_\sigma$  one finds  $\text{Tr}\{\check{\Xi}\partial_t\check{Q}\} = -\frac{i}{2} \text{Tr}\{\epsilon(\hat{\sigma}_z \otimes \hat{\tau}_0)\check{W}_{\epsilon\epsilon'}\check{W}_{\epsilon'\epsilon}\}$ , where we took  $\partial_t \rightarrow -i\epsilon$  in the energy space. The latter, after evaluation of the trace reduces to

$$\text{Tr}\{\check{\Xi}\partial_t\check{Q}\} = \frac{i}{2} \sum_q \iint \frac{d\epsilon d\epsilon'}{4\pi^2} (\epsilon + \epsilon') [c_{\epsilon\epsilon'}^*(\mathbf{q})c_{\epsilon'\epsilon}(-\mathbf{q}) - \bar{c}_{\epsilon\epsilon'}^*(\mathbf{q})\bar{c}_{\epsilon'\epsilon}(-\mathbf{q})]. \quad (431)$$

To the leading order in  $\check{W}$  the coupling term between Cooper modes and the order parameter,  $\Delta$ , reads as  $\text{Tr}\{\check{\Delta}\check{Q}\} = \text{Tr}\{\check{\mathcal{U}}_\epsilon \check{\Delta}_{\epsilon-\epsilon'} \check{\mathcal{U}}_{\epsilon'}^{-1} (\hat{\sigma}_z \otimes \hat{\tau}_z) \check{W}_{\epsilon'\epsilon}\} + O(\Delta^2)$ , where  $\check{\mathcal{U}}$  is given by Eq. (337). Evaluating traces, one finds

$$\text{Tr}\{\check{\Delta}\check{Q}\} = \sum_q \iint \frac{d\epsilon d\epsilon'}{4\pi^2} [\Delta_{\epsilon\epsilon'}^c(\mathbf{q})c_{\epsilon'\epsilon}^*(-\mathbf{q}) - \Delta_{\epsilon\epsilon'}^{\bar{c}}(\mathbf{q})\bar{c}_{\epsilon'\epsilon}^*(-\mathbf{q}) - c.c.], \quad (432)$$

where the following form factors were introduced

$$\Delta_{\epsilon\epsilon'}^c(\mathbf{q}) = \Delta^{cl}(\mathbf{q}, \epsilon - \epsilon') + F_\epsilon \Delta^q(\mathbf{q}, \epsilon - \epsilon'), \quad \Delta_{\epsilon\epsilon'}^{\bar{c}}(\mathbf{q}) = \Delta^{cl}(\mathbf{q}, \epsilon - \epsilon') - F_{\epsilon'} \Delta^q(\mathbf{q}, \epsilon - \epsilon'). \quad (433)$$

It is important to emphasize, that the diffusion modes  $\{d, \bar{d}\}$  couple to  $\Delta$  only starting from the quadratic order in  $\check{W}$ . These terms produce non-local and non-linear interaction vertices between the order parameter components and will not be considered here, see [154] for more details. Combining now (430)–(432), one finds for the quadratic part of the action  $S_\sigma[\check{W}, \Delta] = S_\sigma^c[\check{W}, \Delta] + S_\sigma^{\bar{c}}[\check{W}, \Delta]$ , where

$$iS_\sigma^c[\check{W}, \Delta] = -\frac{\pi\nu}{2} \text{tr} \left\{ c_{\epsilon\epsilon'}^*(\mathbf{q}) [Dq^2 - i(\epsilon + \epsilon')] c_{\epsilon'\epsilon}(-\mathbf{q}) + 2i\Delta_{\epsilon\epsilon'}^c(\mathbf{q}) c_{\epsilon'\epsilon}^*(-\mathbf{q}) - 2i\Delta_{\epsilon\epsilon'}^{*c}(\mathbf{q}) c_{\epsilon'\epsilon}(-\mathbf{q}) \right\}, \quad (434a)$$

$$iS_\sigma^{\bar{c}}[\check{W}, \Delta] = -\frac{\pi\nu}{2} \text{tr} \left\{ \bar{c}_{\epsilon\epsilon'}^*(\mathbf{q}) [Dq^2 + i(\epsilon + \epsilon')] \bar{c}_{\epsilon'\epsilon}(-\mathbf{q}) - 2i\Delta_{\epsilon\epsilon'}^{\bar{c}}(\mathbf{q}) \bar{c}_{\epsilon'\epsilon}^*(-\mathbf{q}) + 2i\Delta_{\epsilon\epsilon'}^{*\bar{c}}(\mathbf{q}) \bar{c}_{\epsilon'\epsilon}(-\mathbf{q}) \right\}, \quad (434b)$$

and traces stand for energy and momentum integrations  $\text{tr} = \sum_q \iint \frac{d\epsilon d\epsilon'}{4\pi^2}$ . At this stage, one is prepared to perform Gaussian integration over the Cooper modes  $c$  and  $\bar{c}$ . Quadratic forms in (434) are extremized by

$$c_{\epsilon\epsilon'}(\mathbf{q}) = \frac{-2i\Delta_{\epsilon\epsilon'}^c(\mathbf{q})}{Dq^2 - i(\epsilon + \epsilon')}, \quad \bar{c}_{\epsilon\epsilon'}(\mathbf{q}) = \frac{2i\Delta_{\epsilon\epsilon'}^{\bar{c}}(\mathbf{q})}{Dq^2 + i(\epsilon + \epsilon')}. \quad (435)$$

Similar equations for the conjugated fields, are obtained from (435) by replacing  $\Delta \rightarrow \Delta^*$  and flipping an overall sign. The Gaussian integral  $\int \mathbf{D}[\check{W}] \exp(iS_\sigma[\check{W}, \Delta]) = \exp(iS_\sigma[\Delta])$ , where  $S_\sigma[\Delta]$  is calculated on the extremum (435):

$$iS_\sigma[\Delta] = 4\pi\nu \sum_q \iint \frac{d\epsilon d\omega}{4\pi^2} \frac{[\Delta_+^{cl} + F_{\epsilon_+} \Delta_+^q][\Delta_-^{*cl} + F_{\epsilon_-} \Delta_-^{*q}]}{Dq^2 - 2i\epsilon}, \quad (436)$$

where  $\Delta_\pm^{cl(q)} = \Delta^{cl(q)}(\pm\mathbf{q}, \pm\omega)$  and  $\epsilon_\pm = \epsilon \pm \omega/2$ . We have also introduced new integration variables  $\omega = \epsilon - \epsilon'$ ,  $\epsilon = (\epsilon + \epsilon')/2$  and employed the fact that  $F_\epsilon$  is an odd function to change variables as  $\epsilon \rightarrow -\epsilon$  in the contribution coming from  $\bar{c}$  fields. The contribution to  $iS_\sigma[\Delta]$  with the two classical components of the order parameter  $\sim \Delta_+^{cl} \Delta_-^{*cl}$  vanishes identically after the  $\epsilon$ -integration as being an integral of the purely retarded function. This is nothing, but manifestation of the normalization condition for the Keldysh-type action (see Section 2.3 for discussions). Adding to  $iS_\sigma[\Delta]$  zero in the form  $-4\pi\nu \text{tr} \{ \Delta_+^q \Delta_-^{*q} / [Dq^2 - 2i\epsilon] \}$ , which vanishes after  $\epsilon$  integration by causality, and combining (436) with  $S_\Delta$  from Eq. (312b), one finds for  $S_{\text{GL}}[\Delta] = S_\sigma[\Delta] + S_\Delta[\Delta]$  the following result

$$S_{\text{GL}}[\Delta] = 2\nu \sum_q \int \frac{d\omega}{2\pi} \left[ \Delta_-^{*q} L_R^{-1} \Delta_+^{cl} + \Delta_-^{*cl} L_A^{-1} \Delta_+^q + \Delta_-^{*q} B_\omega [L_R^{-1} - L_A^{-1}] \Delta_+^q \right], \quad (437)$$

where superconducting fluctuations propagator is given by the integral

$$L_{R(A)}^{-1}(\mathbf{q}, \omega) = -\frac{1}{\lambda} - i \int d\epsilon \frac{F_{\epsilon\mp\omega/2}}{Dq^2 - 2i\epsilon}. \quad (438)$$

This expression for  $L(\mathbf{q}, \omega)$  can be reduced to the more familiar form. Indeed, adding and subtracting right-hand side of (438) taken at zero frequency and momentum one writes

$$L_R^{-1}(\mathbf{q}, \omega) = -\frac{1}{\lambda} + \int_{-\omega_D}^{+\omega_D} d\epsilon \frac{F_\epsilon}{2\epsilon} - i \int_{-\infty}^{+\infty} d\epsilon \left[ \frac{F_\epsilon}{Dq^2 - i\omega - 2i\epsilon} + \frac{F_\epsilon}{2\epsilon} \right], \quad (439)$$

where the second term on the right-hand side is the logarithmically divergent integral which is to be cut in the standard way by the Debye frequency  $\omega_D$ . Introducing dimensionless variable  $x = \epsilon/2T$ , and performing the integration in the last term on the right-hand side of (439) by parts with the help of the identity  $\int_0^\infty dx \ln(x) \text{sech}^2(x) = -\ln \frac{4\gamma}{\pi}$ , where  $\gamma = e^{\mathbb{C}}$  with  $\mathbb{C} = 0.577$  is the Euler constant, and using the definition of the superconductive transition temperature  $T_c = (2\gamma\omega_D/\pi) \exp(-1/\lambda\nu)$ , one finds for (439)

$$L_R^{-1}(\mathbf{q}, \omega) = \ln \frac{T_c}{T} - \frac{i}{2} \int_{-\infty}^{+\infty} dx \left[ \frac{\tanh(x)}{\frac{Dq^2 - i\omega}{4T} - ix} + \frac{\tanh(x)}{ix} \right]. \quad (440)$$

With the help of the expansion

$$\tanh(x) = \sum_{n=0}^{\infty} \frac{2x}{x^2 + x_n^2}, \quad x_n = \pi(n + 1/2), \quad (441)$$

one may perform the  $x$ -integration explicitly interchanging the order of summation and integration

$$\int_{-\infty}^{+\infty} \frac{dx}{x^2 + x_n^2} = \frac{\pi}{x_n}, \quad \int_{-\infty}^{+\infty} \frac{xdx}{[x^2 + x_n^2] \left[ \frac{Dq^2 - i\omega}{4T} - ix \right]} = \frac{i\pi}{\frac{Dq^2 - i\omega}{4T} + x_n}. \quad (442)$$

Recalling now the definition of the digamma function

$$\psi(x) = -\mathbb{C} - \sum_{n=0}^{\infty} \left[ \frac{1}{n+x} - \frac{1}{n+1} \right], \quad (443)$$

one transforms (438) to the final result

$$L_R^{-1}(\mathbf{q}, \omega) = \ln \frac{T_c}{T} - \psi \left( \frac{Dq^2 - i\omega}{4\pi T} + \frac{1}{2} \right) + \psi \left( \frac{1}{2} \right) \approx -\frac{\pi}{8T} (Dq^2 + \tau_{\text{GL}}^{-1} - i\omega), \quad (444)$$

where  $\tau_{\text{GL}}^{-1} = 8(T - T_c)/\pi$ . Since according to the last expression  $Dq^2 \sim \omega \sim \tau_{\text{GL}}^{-1} \ll T$ , the expansion of the digamma function is justified.

As a result, the time dependent Ginzburg–Landau part of the effective action (339) is obtained (compare (437) and (444) with (341)). The non-linear contribution  $\sim |\Delta|^2$  in (343) can be restored once  $\sim \text{Tr}\{\check{\mathcal{W}}^3 \check{\Delta}\}$  is kept in the expansion of  $\text{Tr}\{\check{\mathcal{Q}} \check{\Delta}\}$  part of the action. Furthermore, for  $Dq^2 \rightarrow -D\partial_{\mathbf{r}}^2$  in (444), one actually has  $D(\partial_{\mathbf{r}} - 2ie\mathbf{A}_{\mathcal{K}}^{cl})^2$ , once the vector potential is kept explicitly in the action.

Let us comment now on the origin of the other terms in the effective action (339). The super-current part of the action  $S_{SC}$  emerges from the  $\text{Tr}\{\partial_{\mathbf{r}} \check{\mathcal{Q}}_{\mathcal{K}} [\check{\Xi} \check{\mathbf{A}}_{\mathcal{K}}, \check{\mathcal{Q}}_{\mathcal{K}}]\}$  upon second order expansion over the Cooper modes, namely

$$S_{SC}[\Delta, \mathbf{A}, \Phi] = \frac{i\pi\nu}{4} \text{Tr}\{c_{it}^*(\mathbf{r}) \mathcal{N}_{it}^{\text{SC}} c_{it}(\mathbf{r}) + \bar{c}_{it}^*(\mathbf{r}) \mathcal{N}_{it}^{\text{SC}} \bar{c}_{it}(\mathbf{r})\}, \quad (445)$$

where

$$\mathcal{N}_{it}^{\text{SC}} = -\delta_{t-t'} \frac{2eD}{T} \left[ \frac{1}{2} \text{div} \mathbf{A}_{\mathcal{K}}^q(\mathbf{r}, t) + \mathbf{A}_{\mathcal{K}}^q(\mathbf{r}, t) [\partial_{\mathbf{r}} - 2ie\mathbf{A}_{\mathcal{K}}^{cl}(\mathbf{r}, t)] \right]. \quad (446)$$

Deriving  $\mathcal{N}_{it}^{\text{SC}}$  one uses an approximation for the equilibrium Fermi function

$$F_t = -\frac{iT}{\sinh(\pi T t)} \xrightarrow{t \gg 1/T} \frac{i}{2T} \delta'(t), \quad (447)$$

which is applicable for slowly varying external fields. Performing integration over the Cooper modes one substitutes (435) into (445). Noticing that in the real-space representation (435) reads as

$$c_{it}(\mathbf{r}) = -i\theta(t-t') \Delta_{\mathcal{K}}^{cl} \left( \mathbf{r}, \frac{t+t'}{2} \right) + \chi(t-t') \Delta_{\mathcal{K}}^q \left( \mathbf{r}, \frac{t+t'}{2} \right), \quad (448a)$$

$$\bar{c}_{it}(\mathbf{r}) = i\theta(t-t') \Delta_{\mathcal{K}}^{cl} \left( \mathbf{r}, \frac{t+t'}{2} \right) - \chi(t-t') \Delta_{\mathcal{K}}^q \left( \mathbf{r}, \frac{t+t'}{2} \right), \quad (448b)$$

$$\chi(t) = \int_{-\infty}^{+\infty} \frac{d\epsilon}{2\pi} \tanh\left(\frac{\epsilon}{2T}\right) \frac{e^{-i\epsilon t}}{\epsilon + i0} = \frac{2}{\pi} \text{arctanh}(\exp(-\pi T|t|)), \quad (448c)$$

and keeping contributions only with the classical components of fluctuating order parameter, since  $\mathcal{N}^{\text{SC}}$  is already linear in quantum field  $\mathbf{A}_{\mathcal{K}}^q$ , one can perform  $t'$  integration in (445) explicitly and recover  $S_{SC}$  in the form given by (344).

The Maki–Thompson part of the effective action  $S_{\text{MT}}$  emerges from  $\text{Tr}\{([\check{\Xi}\check{\mathbf{A}}_{\mathcal{J}}, \check{\mathcal{Q}}_{\mathcal{J}}])^2\}$  when each  $\check{\mathcal{Q}}_{\mathcal{J}}$  matrix is expanded to the first order in fluctuations  $\check{\mathcal{W}}$ :

$$S_{\text{MT}}[\Delta, \mathbf{A}, \Phi] = -\frac{\pi\nu}{4}\text{Tr}\{c_{it}^*(\mathbf{r})\mathcal{N}_{it}^{\text{MT}}\bar{c}_{it}(\mathbf{r}) + \bar{c}_{it}^*(\mathbf{r})\mathcal{N}_{it}^{\text{MT}}c_{it}(\mathbf{r})\}, \quad (449)$$

where

$$\mathcal{N}_{it}^{\text{MT}} = -2e^2D \left[ \mathbf{A}_{\mathcal{J}}^q(\mathbf{r}, t) + \frac{i}{2T}\partial_t\mathbf{A}_{\mathcal{J}}^{cl}(\mathbf{r}, t) \right] \mathbf{A}_{\mathcal{J}}^q(\mathbf{r}, t'), \quad (450)$$

and we again used (447). With the help of (448) one should perform now integration over Cooper modes in (449). Observe, however, that in contrast to (445), where we had product of either two retarded or two advanced Cooperon fields, which restricted integration over one of the time variables, in the case of MT contribution (449), we end up with the product between one retarded and one advanced Cooperon and the time integration running over the entire range  $t > t'$ . Precisely, this difference between (445) and (449) makes contribution  $S_{\text{SC}}$  to be local, while  $S_{\text{MT}}$  non–local. Finally, in each of the Cooperon fields  $c, \bar{c}$ , (449), one keeps only contribution with the classical component of the order parameter and recovers  $S_{\text{MT}}$  in the form given by (345).

The remaining density of states part of the effective action  $S_{\text{DOS}}$  emerges, similarly to  $S_{\text{MT}}$ , from  $\text{Tr}\{([\check{\Xi}\check{\mathbf{A}}_{\mathcal{J}}, \check{\mathcal{Q}}_{\mathcal{J}}])^2\}$ . This time one of the  $\check{\mathcal{Q}}_{\mathcal{J}}$  matrices is kept at the saddle point  $\check{\Lambda}$ , while another is expanded to the second order in  $\check{\mathcal{W}}$ :

$$S_{\text{DOS}}[\Delta, \mathbf{A}, \Phi] = \frac{i\pi\nu}{4}\text{Tr}\{c_{it'}^*(\mathbf{r})\mathcal{N}_{it't''}^{\text{DOS}}c_{it''}(\mathbf{r}) + \bar{c}_{it'}^*(\mathbf{r})\mathcal{N}_{it't''}^{\text{DOS}}\bar{c}_{it''}(\mathbf{r})\}, \quad (451)$$

where

$$\mathcal{N}_{it't''}^{\text{DOS}} = 2e^2D \left[ \mathbf{A}_{\mathcal{J}}^q(\mathbf{r}, t)[\mathbf{A}_{\mathcal{J}}^{cl}(\mathbf{r}, t) - \mathbf{A}_{\mathcal{J}}^{cl}(\mathbf{r}, t'')]F_{t-t''} + \int dt''' \mathbf{A}_{\mathcal{J}}^q(\mathbf{r}, t)F_{t-t'''}\mathbf{A}_{\mathcal{J}}^q(\mathbf{r}, t''')F_{t''-t'''} \right]. \quad (452)$$

It is important to emphasize here, that as compared to (446) and (450), when deriving  $\mathcal{N}^{\text{DOS}}$  it is *not* sufficient to take the approximate form of the distribution function (447), but rather one should keep full  $F_t$ . In what follows, we deal with the part of the action (451) having one classical and one quantum components of the vector potential. The other one, having two quantum fields can be restored via FDT. To this end, we substitute Cooperon generators in the form (448) into the action (451). We keep only classical components of  $\Delta_{\mathcal{J}}$  (the quantum one produce insignificant contributions) and account for an additional factor of 2 due to identical contributions from  $c$  and  $\bar{c}$  Cooperons. Changing time integration variables  $t - t'' = \tau$  and  $t + t'' = 2\eta$ , one finds

$$S_{\text{DOS}}[\Delta, \mathbf{A}, \Phi] = i\pi e^2\nu D \text{Tr} \left[ \mathbf{A}_{\mathcal{J}}^q(\mathbf{r}, \eta + \tau/2)[\mathbf{A}_{\mathcal{J}}^{cl}(\mathbf{r}, \eta + \tau/2) - \mathbf{A}_{\mathcal{J}}^{cl}(\mathbf{r}, \eta - \tau/2)]F_{\tau} \right. \\ \left. \times \theta(\eta + \tau/2 - t')\theta(t' - \eta + \tau/2)\Delta_{\mathcal{J}}^{*cl} \left( \mathbf{r}, \frac{\eta + \tau/2 - t'}{2} \right) \Delta_{\mathcal{J}}^{cl} \left( \mathbf{r}, \frac{\eta - \tau/2 - t'}{2} \right) \right]. \quad (453)$$

Note that owing to the step functions, integration over  $t'$  is restricted to be in the range  $\eta + \tau/2 > t' > \eta - \tau/2$ . Since  $F_{\tau}$  is a rapidly decreasing function of its argument, the main contribution to the  $\tau$  integral comes from the range  $\tau \sim 1/T \ll \eta$ . Keeping this in mind, one makes use of the following approximations:  $\mathbf{A}_{\mathcal{J}}^q(\mathbf{r}, \eta + \tau/2)[\mathbf{A}_{\mathcal{J}}^{cl}(\mathbf{r}, \eta + \tau/2) - \mathbf{A}_{\mathcal{J}}^{cl}(\mathbf{r}, \eta - \tau/2)] \approx \tau\mathbf{A}_{\mathcal{J}}^q(\mathbf{r}, \eta)\partial_{\eta}\mathbf{A}_{\mathcal{J}}^{cl}(\mathbf{r}, \eta)$  and  $\Delta_{\mathcal{J}}^{*cl} \left( \mathbf{r}, \frac{\eta + \tau/2 - t'}{2} \right) \Delta_{\mathcal{J}}^{cl} \left( \mathbf{r}, \frac{\eta - \tau/2 - t'}{2} \right) \approx |\Delta_{\mathcal{J}}^{cl}(\mathbf{r}, \eta)|^2$ , which allows to integrate over  $t'$  explicitly  $\int dt'\theta(\eta + \tau/2 - t')\theta(t' - \eta + \tau/2) = \tau\theta(\tau)$ . Using fermionic distribution function (447) and collecting all factors, we find

$$S_{\text{DOS}}[\Delta, \mathbf{A}, \Phi] = \pi e^2\nu DT \text{Tr} \left[ \mathbf{A}_{\mathcal{J}}^q(\mathbf{r}, t)\partial_t\mathbf{A}_{\mathcal{J}}^{cl}(\mathbf{r}, t)|\Delta_{\mathcal{J}}^{cl}(\mathbf{r}, t)|^2 \right] \int_0^{\infty} \frac{\tau^2 d\tau}{\sinh(\pi T\tau)} \quad (454)$$

where we set  $\eta \rightarrow t$ . Performing remaining integration over  $\tau$  and restoring  $S_{\text{DOS}} \sim \mathbf{A}_{\mathcal{J}}^q\mathbf{A}_{\mathcal{J}}^q$  via FDT, we arrive at  $S_{\text{DOS}}$  in the form given by (349). Additional details of the derivation of the effective action (339) can be found in [154].



## References

- [1] Keldysh, L. V., 1964, Zh. Eksp. Teor. Fiz., **47**, 1515; [Sov. Phys. JETP, 1965, **20**, 1018].
- [2] Konstantinov, O. V., and Perel, V. I., 1960, Zh. Eksp. Teor. Fiz., **39**, 197; [Sov. Phys. JETP, 1961, **12**, 142].
- [3] Schwinger, J., 1961, J. Math. Phys., **2**, 407.
- [4] Kadanoff, L. P., and Baym, G., 1962, *Quantum Statistical Mechanics*, (Benjamin, New York).
- [5] Feynman, R. P., and Vernon Jr., F. L., 1963, Ann. Phys., **24**, 118.
- [6] Wyld, H. W., 1961, Ann. Phys., **14**, 143.
- [7] Martin, P. C., Siggia, E. D., and Rose, H. A., 1973, Phys. Rev. A, **8**, 423.
- [8] DeDominicis, J., 1976, J. Physique (Paris), **37**, C1.
- [9] Lifshitz, E. M., and Pitaevskii, L. P., 1980, *Statistical Physics, part II*, (Pergamon Press, Oxford).
- [10] Rammer, J., and Smith, H., 1986, Rev. Mod. Phys., **58**, 323.
- [11] Smith, H., and Jensen, H. H., 1989, *Transport phenomena*, (Clarendon Press, Oxford).
- [12] Mahan, G. D., 1990, *Many-particle physics*, (Plenum Press, NY).
- [13] Rammer, J., 1998, *Quantum transport theory*, (Perseus Books, MA).
- [14] Schwab, P., Raimondi, R., 2003, Ann. Phys. (Leipzig), **12**, 471.
- [15] Spicka, V., Velicky, B., and Kalvova, A., 2005, Phys. E–Low–Dim. Syst. and Nanostruct., **29**, 154; and **29**, 175.
- [16] Kamenev, A., 2005, *Many-body theory of non-equilibrium systems*, in *Nanophysics: Coherence and Transport*, edited by H. Bouchiat *et. al.*, (Elsevier), p. 177.
- [17] Matsubara, T., 1955, Prog. Theor. Phys., **14**, 351.
- [18] Abrikosov, A. A., Gor'kov, L. P., and Dzyaloshinski, I. E., 1963, *Methods of quantum field theory in statistical physics* (Dover, NY).
- [19] Gardiner, C. W., 1997, *Handbook of stochastic methods for physics, chemistry, and the natural sciences*, (New York: Springer-Verlag).
- [20] Risken, H., 1989, *The Fokker–Planck equation: methods of solution and applications*, (New York: Springer-Verlag).
- [21] Horbach, M. L., and Schön, G., 1993, Ann. Phys. (N.Y.), **2**, 51.
- [22] Kamenev, A., and Andreev, A., 1999, Phys. Rev. B, **60**, 2218.
- [23] Chamon, C., Ludwig, A. W., Nayak, C., 1999, Phys. Rev. B, **60**, 2239.
- [24] Feigel'man, M. V., Larkin, A. I., and Skvortsov, M. A., 2000, Phys. Rev. B, **61**, 12361.
- [25] Edwards, F., and Anderson, P. W., 1975, J. Phys. **F5**, 965.
- [26] Wegner, F. J., 1979, Z. Phys. B, **35**, 207.

- [27] Efetov, K. B., Larkin, A. I., and Khmel'nitskii, D. E., 1980, *Zh. Eksp. Teor. Fiz.*, **79**, 1120; [*Sov. Phys. JETP*, 1980, **52**, 568].
- [28] Finkel'stein, A. M., 1990, *Electron Liquid in Disordered Conductors*, edited by I. M. Khalatnikov, *Soviet Scientific Reviews* Vol. **14**, (Harwood, London).
- [29] Belitz, D., and Kirkpatrick, T. R., 1994, *Rev. Mod. Phys.*, **66**, 261.
- [30] Lerner, I. V., 2003, *Nonlinear sigma model for normal and superconducting systems: A pedestrian approach*, in *Quantum phenomena in mesoscopic systems*, edited by B. L. Altshuler *et al.*, (IOS Press, Amsterdam), p. 271.
- [31] Efetov, K. B., 1983, *Adv. Phys.*, **32**, 53.
- [32] Efetov, K. B., 1997, *Supersymmetry in disorder and chaos*, (Cambridge University Press).
- [33] Mirlin, A. D., 2000, *Phys. Rep.*, **326**, 259.
- [34] Negele, J. W., and Orland, H., 1988, *Quantum Many-Particle Systems*, (Adelison-Wesley).
- [35] Leggett, A. J., 2001, *Rev. Mod. Phys.*, **73**, 307.
- [36] Caldeira, A. O., and Leggett, A. J., 1983, *Ann. Phys. (NY)*, **149**, 374.
- [37] Elgart, V., and Kamenev, A., 2004, *Phys. Rev. E*, **70**, 041106.
- [38] Feynman R. P., and Hibbs A. R., 1965, *Quantum Mechanics and Path Integrals*, (NY, McGraw-Hill).
- [39] Larkin, A. I., and Ovchinnikov, Yu. N., 1986, *Vortex motion in Superconductors*, in *Nonequilibrium Superconductivity*, edited by D. N. Langenberg and A. I. Larkin, (Elsevier), p. 493.
- [40] Kubo, R., 1957, *J. Phys. Soc. Jpn.*, **12**, 570.
- [41] Landauer, R., 1957, *IBM J. Res. Dev.*, **1**, 233; Landauer, R., 1985, *Localization, Interaction, and Transport Phenomena*, edited by G. Bergmann and Y. Bruynseraede (Springer-Verlag, New York), p. 38.
- [42] Buttiker, M., 1992, *Phys. Rev. B*, **45**, 3807.
- [43] Imry, Y., 1986, in *Perspectives on Condensed Matter Physics*, edited by G. Grinstein and E. Mazenko (World Scientific, Singapore) and Imry, Y., 1997, *Introduction to Mesoscopic Physics* (Oxford University Press).
- [44] Datta, S., 1995, *Electronic Transport in Mesoscopic Systems*, (Cambridge University Press).
- [45] Lesovik, G. B., 1989, *JETP Lett.*, **49**, 592.
- [46] Kogan, Sh., 1996, *Electronic noise and fluctuations in solids*, (Cambridge University Press).
- [47] Blanter, Ya. M., and Büttiker, M., 2000, *Phys. Rep.* **336**, 1.
- [48] Martin, T., 2005, *Noise in mesoscopic physics*, in *Nanophysics: Coherence and Transport*, edited by H. Bouchiat *et al.*, (Elsevier), p. 283.
- [49] Pogrebinskii, M. B., 1977, *Fiz. Tekh Poluprov.*, **11** 637; [*Sov. Phys.–Semicond.*, 1977, **11**, 372].
- [50] Price, P. J., 1983, *Physica B+C*, **117+118**, 750.

- [51] Solomon, P. M., Price, P. J., Frank, D. J., and La Tulipe, D. C., 1989, Phys. Rev. Lett. **63**, 2508.
- [52] Gramila, T. J., Eisenstein, J. P., MacDonald, A. H., Pfeiffer, L. N., and West, K. W., 1991, Phys. Rev. Lett. **66** 1216.
- [53] Sivan, U., Solomon, P. M., and Shtrikman, H., 1992, Phys. Rev. Lett., **68**, 1196.
- [54] Lilly, M. P., Eisenstein, J. P., Pfeiffer, L. N., and West, K. W., 1998, Phys. Rev. Lett., **80**, 1714.
- [55] Pillarisetty, R., Noh, H., Tsui, D. C., De Poortere, E. P., Tutuc, E., and Shayegan, M., 2002, Phys. Rev. Lett., **89**, 016805.
- [56] Jauho, A. P., and Smith, H., 1993, Phys. Rev. B, **47**, 4420.
- [57] Zheng, L., and MacDonald, A. H., 1993, Phys. Rev. B, **48**, 8203.
- [58] Kamenev, A., and Oreg, Y., 1995, Phys. Rev. B, **52**, 7516.
- [59] Flensberg, K., Hu, B. Y. K., Jauho, A. P., and Kinaret, J. M., Phys. Rev. B, 1995, **52**, 14761.
- [60] Debray, P., Vasilopoulos, P., Raichev, O., Perrin, R., Rahman, M., and Mitchel, W. C., 2000, Physica E, **6**, 694.
- [61] Debray, P., Zverev, V., Raichev, O., Klesse, R., Vasilopoulos, P., and Newrock, R. S., 2001, J. Phys.: Condens. Matter, **13**, 3389.
- [62] Morimoto, T., Iwase, Y., Aoki, N., Sasaki, T., Ochiai, Y., Shalios, A., Bird, J. P., Lilly, M. P., Reno, J. L., and Simmons, J. A., 2003, Appl. Phys. Lett., **82**, 3952.
- [63] Yamamoto, M., Stopa, M., Tokura, Y., Hirayama, Y., and Tarucha, S., 2006, Science, **313**, 204.
- [64] Aguado, R., and Kouwenhoven, L. P., 2000, Phys. Rev. Lett., **84**, 1986.
- [65] Onac, E., Balestro, F., Willems van Beveren, L. H., Hartmann, U., Nazarov, Y. V., and Kouwenhoven, L. P., 2006, Phys. Rev. Lett., **96**, 176601.
- [66] Khrapai, V. S., Ludwig, S., Kotthaus, J. P., Tranitz, H. P., and Wegscheider, W., 2006, Phys. Rev. Lett., **97**, 176803; and 2007, Phys. Rev. Lett., **99**, 096803.
- [67] Reznikov, M., Heiblum, M., Shtrikman, H., and Mahalu, D., 1995, Phys. Rev. Lett., **75**, 3340.
- [68] Levchenko, A., and Kamenev, A., 2008, Phys. Rev. Lett., **101**, 216806.
- [69] Glazman, L. I., Lesovik, G. B., Khmel'nitskii, D. E., and Shekhter, R. I., 1988, JETP Lett., **48**, 238.
- [70] Nazarov, Yu. V., 1999, Superlattices and Microstruct., **25**, 1221.
- [71] Belzig, W., and Nazarov, Yu. V., 2001, Phys. Rev. Lett., **87**, 067006.
- [72] Feigelman, M. V., Kamenev, A., Larkin, A. I., and Skvortsov, M. A., 2002, Phys. Rev. B, **66**, 054502.
- [73] Aleiner, I. L., Brouwer, P. W., and Glazman, L. I., 2002, Phys. Rep., **358**, 309.
- [74] Nazarov, Yu. V., 1999, Phys. Rev. Lett., **82**, 1245.
- [75] Snyman, I., and Nazarov, Yu. V., 2008, Phys. Rev. B, **77**, 165118.

- [76] Usadel, K., 1970, Phys. Rev. Lett., **25**, 507.
- [77] Pierre, F., Pothier, H., Esteve, D., and Devoret, M. H., 2000, J. Low. Temp. Phys., **118**, 437.
- [78] Hikami, S., 1981, Phys. Rev. B, **24**, 2671.
- [79] Gor'kov, L. P., Larkin, A. I., and Khmel'nitskii, D. E., 1979, Pis'ma Zh. Eksp. Teor. Fiz., **30**, 248; [Sov. Phys. JETP Lett., 1979, **30**, 228].
- [80] Altshuler, B. L., Aronov, A. G., Khmel'nitskii, D. E., and Larkin, A. I., 1983, in *Quantum theory of solids*, ed. I. M., Lifshits, (MIR Publishers, Moscow).
- [81] Lee, P. A., and Ramakrishnan, T. V., 1985, Rev. Mod. Phys., **57**, 287.
- [82] Altshuler, B. L., Lee, P. A., and Webb, R. A., Eds., 1991, *Mesoscopic phenomena in solids*, (North Holland, NY).
- [83] Altshuler, B. L., and Shklovskii, B. I., 1986, Zh. Eksp. Teor. Fiz., **91**, 220; [Sov. Phys. JETP, 1986, **64**, 127].
- [84] Mehta, M. L., 1991, *Random Matrices*, (Academic, NY).
- [85] Altland, A., and Kamenev, A., 2000, Phys. Rev. Lett., **85**, 5615.
- [86] Altshuler, B. L., 1985, Pis'ma Zh. Eksp. Teor. Fiz., **41**, 530.
- [87] Lee, P. A., and Stone, A. D., 1985, Phys. Rev. Lett., **55**, 1622.
- [88] Lee, P. A., Stone, A. D., and Fukuyama, H., 1987, Phys. Rev. B, **35**, 1039.
- [89] Altshuler, B. L., Kravtsov, V. E., and Lerner, I. V., 1986, Zh. Eksp. Teor. Fiz., **91**, 2276.
- [90] Beenakker, C. W., 1997, Rev. Mod. Phys., **69**, 731.
- [91] Levitov, L. S., and Lesovik, G. B., 1992, Pis'ma Zh. Eksp. Teor. Fiz., **55**, 534; [JETP Lett., 1992, **55**, 555].
- [92] Levitov, L. S., and Lesovik, G. B., 1993, Pis'ma Zh. Eksp. Teor. Fiz., **58**, 225; [JETP Lett., 1993, **58**, 230].
- [93] Lee, H., Levitov, L. S., and Yakovets, A. Yu., 1995, Phys. Rev. B, **51**, 4079.
- [94] Nazarov, Yu. V., 1999, Ann. Phys. (Leipzig), **8**, 507.
- [95] Levitov, L. S., 2003, *The statistical theory of mesoscopic noise*, in *Quantum Noise in Mesoscopic Physics*, edited by Yu. Nazarov and Ya. M. Blanter, (Kluwer, Dordrecht), p. 373.
- [96] Zala, G., Narozhny, B. N., and Aleiner, I.L., 2001, Phys. Rev. B, **64**, 214204.
- [97] Altshuler, B. L., 1978, Zh. Eksp. Teor. Fiz., **75**, 1330; [Sov. Phys. JETP, 1978, **48**, 670].
- [98] Altshuler, B. L., and Aronov, A. G., 1979, Pisma Zh. Eksp. Teor. Fiz., **30**, 514; [Sov. Phys. JETP Lett., 1979, **30**, 482].
- [99] Catelani, G., and Aleiner, I. L., 2005, Zh. Eksp. Teor. Fiz., **127**, 372; [JETP, 2005, **100**, 331].
- [100] Kogan, Sh. M., and Shul'man, A. Ya., 1969, Zh. Eksp. Teor. Fiz., **56**, 862; [Sov. Phys. JETP, 1969, **29**, 467].
- [101] Nagaev, K. E., 1992, Phys. Lett. A, **169**, 103.

- [102] Gutman, D. B., Mirlin, A. D., and Gefen, Y., 2005, Phys. Rev. B, **71**, 085118.
- [103] Bagrets, D. A., 2004, Phys. Rev. Lett., **93**, 236803.
- [104] Dimitrova, O. V., and Kravtsov, V. E., 2007, JETP Lett., **86**, 670.
- [105] Chtchelkatchev, N. M., and Burmistrov, I. S., 2008, Phys. Rev. Lett., **100**, 206804.
- [106] Altshuler, B. L., and Aronov, A. G., 1979, Zh. Eksp. Teor. Fiz., **77**, 2028; [Sov. Phys. JETP, 1979, **50**, 968].
- [107] Altshuler, B. L., Aronov, A. G., and Lee, P. A., 1980, Phys. Rev. Lett., **44**, 1288.
- [108] Altshuler, B. L., and Aronov, A. G., 1985, *Electron-electron interaction in Disordered Systems*, edited by A. J. Efros and M. Pollak, (Elsevier, Amsterdam), p. 1.
- [109] Finkel'stein, A. M., 1994, Physica B, **197**, 636.
- [110] Nazarov, Yu. V., 1989, Zh. Eksp. Teor. Fiz., **96**, 975; [Sov. Phys. JETP, 1989, **68**, 561].
- [111] Levitov, L. S., and Shytov, A. V., 1997, Pis'ma Zh. Eksp. Teor. Fiz., **66**, 200; [JETP Lett., 1989, **66**, 214].
- [112] Kopietz, P., 1998, Phys. Rev. Lett., **81**, 2120.
- [113] Gutman, D. B., and Gefen, Y., 2001, Phys. Rev. B, **64**, 205317.
- [114] Schmid, A., 1974, Z. Phys., **271**, 251.
- [115] Blanter, Ya. M., 1996, Phys. Rev. B, **54**, 12807.
- [116] Levchenko, A., and Kamenev, A., 2008, Phys. Rev. Lett., **100**, 026805.
- [117] Skvortsov, M. A., Larkin, A. I., and Feigel'man, M. V., 2001, Phys. Rev. B, **63**, 134507.
- [118] Gor'kov, L. P., 1958, Zh. Eksp. Teor. Fiz., **34**, 735; [Sov. Phys. JETP, 1958, **7**, 505].
- [119] Nambu, Y., 1960, Phys. Rev., **117**, 648.
- [120] Narozhny, B. N., Aleiner, I. L., and Altshuler, B. L., 1999, Phys. Rev. B, **60**, 7213.
- [121] Belzig, W., Wilhelm, F. K., Bruder, C., Schön, G., and Zaikin, A. D., 1999, Superlatt. Microstruct., **25**, 1251.
- [122] Schmidt, A. and Schön, G., 1975, J. Low. Temp. Phys., **20**, 207.
- [123] Larkin, A. I., and Ovchinnikov, Yu. N., 1975, Zh. Eksp. Teor. Fiz., **68**, 1915; [Sov. Phys. JETP, 1975, **41**, 960].
- [124] Tinkham, M., 1996, *Introduction to superconductivity* 2nd ed., (McGraw Hill, NY).
- [125] Kopnin, N. B., 2001, *Theory of nonequilibrium superconductivity*, no. 110 in International series of monographs on physics (Oxford University Press).
- [126] Larkin, A. I., and Ovchinnikov, Yu. N., 1977, Zh. Eksp. Teor. Fiz., **73**, 299; [Sov. Phys. JETP, 1977, **46**, 155].
- [127] Zaitsev, A. V., 1984, Zh. Eksp. Teor. Fiz., **86**, 1742; [Sov. Phys. JETP, 1984, **59**, 1015].
- [128] Kuprianov, M. Yu., and Lukichev, V. F., 1988, Zh. Eksp. Teor. Fiz., **94**, 139; [Sov. Phys. JETP, 1988, **67**, 1163].

- [129] Lambert, C. J., Raimondi, R., Sweeney, V., and Volkov, A. F., 1997, Phys. Rev. B, **55**, 6015.
- [130] Belzig, W., Bruder, C., and Schön, G., 1996, Phys. Rev. B, **54**, 9443.
- [131] Guéron, S., Pothier, H., Birge, N. O., Esteve, D., and Devoret, M. H., 1996, Phys. Rev. Lett., **77**, 3025.
- [132] Zhou, F., Charlet, P., Pannetier, B., and Spivak, B., 1998, J. Low. Temp. Phys., **110**, 841.
- [133] Hammer, J. C., Cuevas, J. C., Bergeret, F. S., and Belzig, W., 2007, Phys. Rev. B, **76**, 064514.
- [134] Heikkilä, T. T., Särkkä, J. S., and Wilhelm, F. K., 2002, Phys. Rev. B, **66**, 184513.
- [135] Wilhelm, F. K., Schön, G., and Zaikin, A. D., 1998, Phys. Rev. Lett., **81**, 1682.
- [136] Zhou, F., and Spivak, B., 1998, Phys. Rev. Lett., **80**, 3847.
- [137] Stoof, T. H., and Nazarov, Yu. V., 1996, Phys. Rev. B, **53**, 14496.
- [138] Virtanen, P., and Heikkilä, T. T., 2004, J. Low. Temp. Phys., **136**, 401.
- [139] Stenberg, M. P., Virtanen, P., and Heikkilä, T. T., 2007, Phys. Rev. B, **76**, 144504.
- [140] Crosser, M. S., Huang, J., Pierre, F., Virtanen, P., Heikkilä, T. T., Wilhelm, F. K., and Birge, N. O., 2008, Phys. Rev. B, **77**, 014528.
- [141] Gor'kov, L. P., 1959, Zh. Eksp. Teor. Fiz., **36**, 1918; [Sov. Phys. JETP, 1959, **9**, 1364].
- [142] Ginzburg, V. L., and Landau, L. D., 1950, Zh. Eksp. Teor. Fiz., **20**, 1064.
- [143] Gor'kov, L. P., and Eliashberg, G. M., 1968, Zh. Eksp. Teor. Fiz., **54**, 612; [Sov. Phys. JETP, 1959, **27**, 328].
- [144] Houghton, A., and Maki, K., 1971, Phys. Rev. B, **3**, 1625.
- [145] Hu, C. R., and Thompson, R. S., 1972, Phys. Rev. B, **6**, 110.
- [146] Kramer, L., and Watts-Tobin, R. J., 1978, Phys. Rev. Lett., **40**, 1041.
- [147] Schön, G., and Ambegaokar, V., 1979, Phys. Rev. B, **19**, 3515.
- [148] Hu, C. R., 1980, Phys. Rev. B, **21**, 2775.
- [149] Kremapsky, J. J., and Thompson, R. S., 1985, Phys. Rev. B, **32**, 2965.
- [150] Otterlo, A., Golubev, D. S., Zaikin, A. D., and Blatter, G., 1999, Eur. Phys. J. B, **10**, 131.
- [151] Larkin, A. I., and Varlamov, A., 2005, *Theory of Fluctuations in Superconductors*, (Clarendon, Oxford).
- [152] Altland, A., Simons, B. D., and Taras-Semchuk, D., 2000, Adv. Phys., **49**, 321.
- [153] Yurkevich, I. V., and Lerner, I. V., 2001, Phys. Rev. B, **63**, 064522.
- [154] Levchenko, A., and Kamenev, A., 2007, Phys. Rev. B, **76**, 094518.
- [155] Aslamazov, L. G., and Larkin, A. I., 1968, Fiz. Tverd. Tela., **10**, 1104; [Sov. Phys. Solid State, 1968, **10**, 875].
- [156] Maki, K., 1968, Prog. Teor. Phys., **39**, 897.
- [157] Thompson, R. S., 1970, Phys. Rev. B, **1**, 327.

- [158] Golubov, A. A., Kupriyanov, M. Yu., 1989, Sov. Phys. JETP, **69**, 805.
- [159] Levchenko, A., 2008, Phys. Rev. B, **77**, 180503(R).
- [160] Kulik, I. O., Omelyanchuk, A. N., 1977, Sov. J. Low Temp. Phys., **3**, 459; 1978, Sov. J. Low Temp. Phys., **4**, 142.
- [161] Levchenko, A., Kamenev, A., and Glazman, L., 2006, Phys. Rev. B, **74**, 212509.
- [162] Hurault, J. P., and Maki, K., 1970, Phys. Rev. B, **2**, 2560.
- [163] Abrahams, E., Redi, M., and Woo, J. W., 1970, Phys. Rev. B, **1**, 208.
- [164] Varlamov, A. A., and Dorin, V. V., 1983, Zh. Eksp. Teor. Fiz., **84**, 1868; [Sov. Phys. JETP, 1983, **57**, 1089].
- [165] Di Castro, C., Raimondi, R., Castellani, C., and Varlamov, A. A., 1990, Phys. Rev. B, **42**, 10211.
- [166] Reizer, M. Yu., 1993, Phys. Rev. B, **48**, 13703.
- [167] Kulik, I. O., 1969, Pis'ma Zh. Eksp. Teor. Fiz., **10**, 488; [Sov. Phys. JETP Lett., 1969, **10**, 313].
- [168] Scalapino, D. J., 1970, Phys. Rev. Lett., **24**, 1052.
- [169] Martin, I., and Balatsky, A., 2000, Phys. Rev. B, **62**, R6124.
- [170] Levchenko, A., 2008, Phys. Rev. B, **78**, 104507.