

Blow-up of generalized complex 4-manifolds

Gil R. Cavalcanti* and Marco Gualtieri†

Abstract

We introduce blow-up and blow-down operations for generalized complex 4-manifolds. Combining these with a surgery analogous to the logarithmic transform, we then construct generalized complex structures on $n\mathbb{C}P^2\#m\overline{\mathbb{C}P^2}$ for n odd, a family of 4-manifolds which admit neither complex nor symplectic structures unless $n = 1$. We also extend the notion of a symplectic elliptic Lefschetz fibration, so that it expresses a generalized complex 4-manifold as a fibration over a two-dimensional manifold with boundary.

Introduction

Generalized complex structures [13, 9] are a simultaneous generalization of complex and symplectic structures. Since their introduction, it has been natural to ask whether generalized complex manifolds encompass a genuinely larger class than complex or symplectic manifolds. Indeed, the only obstruction for existence known is that the underlying manifold must be almost complex [9]. Generalized complex structures in dimension 2 are either complex or symplectic, so this question becomes nontrivial first in real dimension 4.

In [1], the authors answered the above question in the affirmative, by constructing a generalized complex structure on $3\mathbb{C}P^2\#19\overline{\mathbb{C}P^2}$. This manifold does not have complex or symplectic structures, due to Kodaira’s classification of complex surfaces and the fact that it has vanishing Seiberg–Witten invariants [15, 18, 21].

In this article, we develop blow-up and blow-down operations for generalized complex manifolds. We then show how this significantly enlarges the list of manifolds which are generalized complex but not complex or symplectic; in particular we prove that $n\mathbb{C}P^2\#m\overline{\mathbb{C}P^2}$ has a generalized complex structure if and only if it is almost complex, i.e. n is odd.

The four-dimensional generalized complex manifolds which we consider may be understood classically as symplectic structures which acquire a singularity along a two-dimensional submanifold called the *complex* or *type change* locus, which itself acquires a complex structure. We prove that if a point is in the complex locus, then it may be blown up, just as a point on a complex surface. This is done by proving a normal form theorem for neighbourhoods of such points.

Just as in the complex case, blowing up a point introduces an exceptional divisor, although in our case it is not a complex curve but rather a two-dimensional submanifold which is Lagrangian away from its intersection with the complex locus; such submanifolds are called *generalized complex branes*. We then show that these branes have standard tubular neighbourhoods, in analogy to Weinstein’s Lagrangian neighbourhood theorem. This allows us to show that spherical branes intersecting the complex locus at one point may be blown down.

*Utrecht University; g.r.cavalcanti@uu.nl.

†University of Toronto; mgualt@math.utoronto.ca.

Finally, we apply our blow-up and blow-down operations to generalized complex 4-manifolds obtained from symplectic fiber sums of rational elliptic surfaces via the logarithmic transform introduced in [1]. Describing the symplectic 4-manifolds as Lefschetz fibrations, we use the method of vanishing cycles to find spherical branes in the associated generalized complex four-manifolds which may be blown down. Using Kirby calculus, the resulting generalized complex manifolds are then shown to be diffeomorphic to $n\mathbb{C}P^2 \# m\overline{\mathbb{C}P^2}$ for n odd.

Motivated by these manipulations, we extend the notion of a (genus 1) symplectic Lefschetz fibration so that it applies to generalized complex 4-manifolds. The base for these generalized Lefschetz fibrations may be any two-dimensional manifold with boundary. The one-dimensional boundary of the base corresponds precisely to the complex locus in the 4-manifold. A more thorough study of these fibrations is in progress.

This paper is organized as follows: in the first section, we introduce generalized complex structures and prove a neighbourhood theorem for a point in the complex locus; in Section 2, we recall the definition of branes and prove a neighbourhood theorem for generic branes in 4-manifolds; in Section 3, we show that it is possible to blow up points in the complex locus as well as blow down spherical branes intersecting the complex locus transversally at a single point; in Section 4, we recall the surgery introduced in [1] and describe its effect on Lefschetz fibrations; in the final section, we prove that $n\mathbb{C}P^2 \# m\overline{\mathbb{C}P^2}$ has a generalized complex structure if n is odd. This last result requires a Kirby calculus computation, which we provide in the Appendix.

1 Generalized complex structures

Given a closed 3-form H on a manifold M , the *Courant bracket* [2, 17] of sections of $TM \oplus T^*M$ is defined by

$$[X + \xi, Y + \eta]_H = [X, Y] + \mathcal{L}_X \eta - \mathcal{L}_Y \xi - \frac{1}{2}d(\eta(X) - \xi(Y)) + i_Y i_X H.$$

The bundle $TM \oplus T^*M$ is also endowed with a natural symmetric pairing of signature (n, n) :

$$\langle X + \xi, Y + \eta \rangle = \frac{1}{2}(\eta(X) + \xi(Y)).$$

Definition 1.1. A *generalized complex structure* on (M, H) is a complex structure \mathcal{J} on the bundle $TM \oplus T^*M$ which preserves the natural pairing and whose $+i$ -eigenbundle is closed under the Courant bracket.

Recall that the differential forms $\Omega^\bullet(M)$ carry a natural spin representation for the metric bundle $TM \oplus T^*M$; the Clifford action of $X + \xi \in TM \oplus T^*M$ on $\rho \in \Omega^\bullet(M)$ is

$$(X + \xi) \cdot \rho = i_X \rho + \xi \wedge \rho.$$

The $+i$ -eigenbundle of \mathcal{J} is a maximal isotropic subbundle of $T_{\mathbb{C}}M \oplus T_{\mathbb{C}}^*M$, and we may use the correspondence between maximal isotropics and pure spinors to encode \mathcal{J} as a line subbundle of the complex differential forms.

Definition 1.2. The *canonical bundle* of \mathcal{J} is the complex line bundle $K \subset \wedge^\bullet T_{\mathbb{C}}^*M$ annihilated by the $+i$ -eigenbundle of \mathcal{J} .

As shown in [9], a complex differential form ρ must satisfy the following properties in order to be a local generator of the canonical bundle of a generalized complex structure (and hence determine \mathcal{J} uniquely):

1. At each point, ρ has the algebraic form

$$\rho = e^{B+i\omega} \wedge \Omega, \quad (1.1)$$

where B and ω are real 2-forms and Ω is a decomposable complex form.

2. At each point, ρ satisfies the nondegeneracy condition

$$(\rho, \bar{\rho}) = \Omega \wedge \bar{\Omega} \wedge (2i\omega)^{n-k} \neq 0. \quad (1.2)$$

3. The form ρ is integrable, in the sense

$$d\rho + H \wedge \rho = (X + \xi) \cdot \rho,$$

for some section $X + \xi$ of $TM \oplus T^*M$.

The first condition is equivalent to the fact that ρ must be a pure spinor, which is a point-wise algebraic condition. The second condition derives from the transversality of the $\pm i$ -eigenbundles of \mathcal{J} , and involves the natural Spin-invariant pairing of differential forms with values in the top degree forms:

$$(\rho, \sigma) = [\rho^\top \wedge \sigma]_{top}.$$

(Here, ρ^\top denotes the reversal anti-automorphism of forms). We see from this condition that the volume form $i^{-n}(\rho, \bar{\rho})$ defines a canonical global orientation on any $2n$ -dimensional generalized complex manifold. We also derive the fact that at each point of a generalized complex manifold, $\ker \Omega \wedge \bar{\Omega}$ is a subspace of the real tangent space with induced symplectic structure and transverse complex structure.

Definition 1.3. Let \mathcal{J} be a generalized complex structure and $e^{B+i\omega} \wedge \Omega$ a generator of its canonical bundle at a point p . The *type* of \mathcal{J} at p is the degree of Ω and the *parity* of \mathcal{J} is the parity of its type.

We will shortly see examples where the type of a generalized complex structure jumps along loci in the manifold. However, its parity must clearly remain constant on connected components of M .

Example 1.4. Let (M^{2n}, I) be a complex manifold. Then the following operator on $TM \oplus T^*M$ is a generalized complex structure:

$$\mathcal{J}_I = \begin{pmatrix} -I & 0 \\ 0 & I^* \end{pmatrix}$$

The $+i$ -eigenspace of \mathcal{J}_I is $T^{0,1}M \oplus T^{*1,0}M$, which annihilates the canonical bundle $K = \wedge^{n,0}T^*M$ and is therefore of type n . The orientation induced by the generalized complex structure is the same as the one induced by the underlying complex structure.

Example 1.5. Let (M, ω) be a symplectic manifold. Then

$$\mathcal{J}_\omega = \begin{pmatrix} 0 & -\omega^{-1} \\ \omega & 0 \end{pmatrix}$$

is a generalized complex structure with $+i$ -eigenspace $\{X - i\omega(X) : X \in T_{\mathbb{C}}M\}$ and canonical bundle generated by the differential form $e^{i\omega}$. Symplectic structures, therefore, have type zero. The orientation induced by this generalized complex structure is the same as the orientation induced by the symplectic structure.

Example 1.6. Let (z, w) be standard complex coordinates on \mathbb{C}^2 . The complex differential form

$$\rho = w + dw \wedge dz$$

may be expressed as $\rho = w \exp(w^{-1}dw \wedge dz)$ when $w \neq 0$ and as $\rho = dw \wedge dz$ when $w = 0$. Hence it is a pure spinor by (1.1). Further, it is nondegenerate since $(\rho, \bar{\rho}) = dw \wedge d\bar{w} \wedge dz \wedge d\bar{z} \neq 0$. Finally, we see that ρ is integrable, since

$$d\rho = -\partial_z \cdot \rho.$$

Hence ρ defines a generalized complex structure on \mathbb{C}^2 which undergoes type change: it has complex type (type 2) along the locus $w = 0$, and symplectic type (type 0) elsewhere.

Example 1.7. Any real 2-form B gives rise to an orthogonal transformation of $TM \oplus T^*M$ via $e^B : X + \xi \mapsto X + \xi - i_X B$. This transformation induces an isomorphism between the H -Courant bracket and the $H + dB$ -Courant bracket, hence it acts by conjugation on any given generalized complex structure \mathcal{J} on (M, H) , producing a new one $e^{-B} \mathcal{J} e^B$ on $(M, H + dB)$. The induced action on the canonical bundle is simply

$$K \mapsto e^B \wedge K = (1 + B + \frac{1}{2}B \wedge B + \dots) \wedge K.$$

Example 1.7 indicates that there are symmetries of the Courant bracket beyond the usual diffeomorphisms. We now use this to define morphisms between generalized complex manifolds.

Definition 1.8. Let $\mathcal{M}_i = (M_i, H_i)_{i=1,2}$ be manifolds equipped with closed 3-forms. Then $\Phi = (\varphi, B) \in C^\infty(M_1, M_2) \times \Omega^2(M_1, \mathbb{R})$ is called a generalized map $\mathcal{M}_1 \rightarrow \mathcal{M}_2$ when $\varphi^* H_2 - H_1 = dB$. When φ is a diffeomorphism we call Φ a *B-diffeomorphism*.

A generalized map establishes a correspondence between the tangent and cotangent bundles which is neither covariant nor contravariant. We say that $X + \xi \in TM_1 \oplus T^*M_1$ is Φ -related to $Y + \eta \in TM_2 \oplus T^*M_2$, and write

$$X + \xi \sim_\Phi Y + \eta,$$

when $Y = \varphi_* X$ and $\xi = \varphi^* \eta + i_X B$.

Definition 1.9. Let $\Phi : \mathcal{M}_1 \rightarrow \mathcal{M}_2$ be a generalized map, and let \mathcal{J}_i be generalized complex structures on \mathcal{M}_i . Then Φ is *holomorphic*¹ when

$$\mathcal{J}_1(X + \xi) \sim_\Phi \mathcal{J}_2(Y + \eta)$$

for all $(X + \xi) \sim_\Phi (Y + \eta)$. When Φ is a *B-diffeomorphism*, we say $\mathcal{J}_1, \mathcal{J}_2$ are *isomorphic*.

This notion of morphism specializes to a holomorphic map if the \mathcal{J}_i are usual complex structures, and to a symplectomorphism if the structures are symplectic. In the case of an isomorphism, we see directly that $\mathcal{J}_1 = e^{-B}(\varphi^* \mathcal{J}_2)e^B$, while on canonical bundles the isomorphism yields

$$K_1 = e^B \varphi^* K_2.$$

We now construct further examples of generalized complex structures by deforming the usual complex manifolds from Example 1.4.

¹This notion of morphism essentially coincides with that described in [3] and [11].

Theorem 1.10 (Gualtieri [9]). *Any holomorphic Poisson bivector β on a complex manifold (M, I) deforms the complex structure into a generalized complex structure \mathcal{J}_β , with canonical bundle*

$$K_\beta = e^\beta \Omega^{n,0}, \quad (1.3)$$

where β acts by interior product.

The action of β on $TM \oplus T^*M$ giving rise to (1.3) is $e^P : X + \xi \mapsto X - P(\xi) + \xi$, for $P = \beta + \bar{\beta}$. Hence the deformed complex structure on $TM \oplus T^*M$ is

$$\mathcal{J}_\beta = e^P \mathcal{J}_I e^{-P} = \begin{pmatrix} -I & Q \\ 0 & I^* \end{pmatrix}, \quad (1.4)$$

where $Q = -4\text{Im}(\beta)$.

Generalized complex structures obtained by deformation in this way do not necessarily have constant type over M : the deformed structure has type equal to the corank of β , which may vary along the manifold. We now investigate several examples of deformed complex surfaces, where the resulting generalized complex structure has generic type zero (symplectic type) jumping to type 2 (complex type) along the vanishing locus of β , an anticanonical divisor.

Example 1.11. Let Σ be a Riemann surface and $\pi : L \rightarrow \Sigma$ be a holomorphic line bundle. The total space of L is a complex surface S , and hence any holomorphic bivector field on S is automatically Poisson. Using the fact that TS is an extension of $\pi^*T\Sigma$ by π^*L , we see that $\wedge^2 TS = \pi^*T\Sigma \otimes \pi^*L$. By a fibrewise Taylor expansion about the zero section, we obtain a filtration of $H^0(S, \wedge^2 TS)$ by sections of polynomial degree at most k along the fibers:

$$H_k^0(S, \wedge^2 TS) = \bigoplus_{i=0}^k H^0(\Sigma, L^{1-i} \otimes T\Sigma).$$

Taking $i = 1$ above, we obtain a holomorphic bivector vanishing to order 1 along the zero section as long as $T\Sigma$ is trivial, i.e. Σ is an elliptic curve. Hence we obtain a generalized complex structure of generic type 0, jumping to complex type along an elliptic curve, irrespective of the line bundle L .

Taking $i = 2$ above, and setting $L = T\Sigma$, we obtain a holomorphic bivector vanishing to order 2 along the zero section, giving rise to a generalized complex structure which undergoes type change along the zero section of $T\Sigma$, irrespective of Σ .

The preceding example suggests that the nature of the type change locus depends on a certain order of vanishing. Indeed, a generalized complex structure of generic type 0 will undergo type change precisely where the projection of $K \subset \wedge^\bullet T_{\mathbb{C}}^*M$ to $\wedge^0 T_{\mathbb{C}}^*M = \mathbb{C}$ vanishes. In other words, this projection defines a section $s \in C^\infty(K^*)$ and the type change occurs at the zero locus of s . For a 4-dimensional manifold, this is the only possible type change, since type 2 is maximal.

Definition 1.12. A point p in the complex (type 2) locus of a generalized complex 4-manifold is called *nondegenerate* if it is a nondegenerate zero of the section $s \in \Gamma(K^*)$. If p is a zero of order a of the section s , then we call p a degenerate complex point of order a .

In the remainder of this section, we show that Example 1.6 provides a normal form for a neighbourhood of any nondegenerate complex point. We may view this model as a deformation of the standard \mathbb{C}^2 by the bivector $\beta = w\partial_w \wedge \partial_z$, since

$$\rho = e^\beta \cdot dw \wedge dz = w + dw \wedge dz. \quad (1.5)$$

Theorem 1.13. *Let (M, \mathcal{J}) be a generalized complex 4-manifold and let $p \in M$ be a non-degenerate complex point. Then p has a neighbourhood which is B -diffeomorphic to a neighbourhood of the origin in \mathbb{C}^2 with the generalized complex structure determined by*

$$\rho = w + dw \wedge dz.$$

Proof. Let $\rho = \rho_0 + \rho_2 + \rho_4$, $\deg(\rho_i) = i$, be a trivialization of K in a neighbourhood of p with $\rho_0(p) = 0$. Since ρ is annihilated by the $+i$ -eigenbundle of \mathcal{J} , there is a unique real section $X + \xi \in C^\infty(TM \oplus T^*M)$ such that

$$d\rho = (X + \xi) \cdot \rho. \quad (1.6)$$

Nondegeneracy implies that $d\rho_0|_p \neq 0$. Hence condition (1.6) implies that $X(p) \neq 0$, and therefore X is nonzero in a neighbourhood of p . So we can parametrize a neighbourhood of p by $(v, x) \in \mathbb{R}^3 \times \mathbb{R}$, with $X = \partial_x$. Then the closed 2-form

$$B(v, x) = \int_0^x d\xi(v, t) dt$$

is such that

$$d(i_X B - \xi) = \mathcal{L}_X B - d\xi = 0.$$

Therefore, $i_X B - \xi = df$ for some function f . Finally we obtain that

$$d(e^{f+B} \rho) = (df + X + \xi - i_X B) \cdot e^{f+B} \rho = X \cdot e^{f+B} \rho,$$

so that $d\tilde{\rho} = X \cdot \tilde{\rho}$ for $\tilde{\rho} = e^{f+B} \rho$. Therefore, we see that \mathcal{J} is B -diffeomorphic, near p , to a generalized complex structure, which we henceforth denote \mathcal{J} , whose canonical bundle is generated by a form ρ which satisfies $d\rho = X \cdot \rho$ for a real vector field X . An immediate consequence of this is that $\mathcal{L}_X \rho = 0$, and hence \mathcal{J} is invariant in the X direction.

Now consider the real section $\mathcal{J}X = Y + \eta$: since \mathcal{J} is X -invariant, we see that $\mathcal{L}_X(Y + \eta) = 0$, implying that $[X, Y] = 0$ and $X \cdot d\eta = 0$ (since $\eta(X) = \langle X, \mathcal{J}X \rangle = 0$, by orthogonality of \mathcal{J}).

Since \mathcal{J} is a complex structure at p , the real vector field Y is nonvanishing near p . Since $[X, Y] = 0$, we may choose coordinates $(v, x, y) \in \mathbb{R}^2 \times \mathbb{R} \times \mathbb{R}$ near p such that $X = \partial_x$ and $Y = \partial_y$. Then define the closed 2-form

$$B = \tilde{B} + dy \wedge (\eta - i_Y \tilde{B}),$$

where \tilde{B} is the closed 2-form defined by

$$\tilde{B}(v, x, y) = \int_0^y d\eta(v, x, t) dt.$$

The form B is constructed precisely so that $i_X B = 0$ while $i_Y B = \eta$. Therefore we obtain

$$e^{-B} \mathcal{J} e^B X = Y,$$

showing that \mathcal{J} is B -diffeomorphic, near p , to a generalized complex structure (henceforth denoted \mathcal{J}) with generator ρ satisfying $d\rho = X \cdot \rho$ and such that $\mathcal{J}X = Y$, for nonvanishing real vector fields X, Y .

A direct result is that $X - iY$ lies in the $+i$ -eigenbundle of \mathcal{J} , which annihilates ρ . In particular, $(X - iY) \cdot \rho_4 = 0$, which implies $\rho_4 = 0$. Therefore, we have $\rho = \rho_0 + \rho_2$, with nondegeneracy guaranteeing $\rho_2 \wedge \bar{\rho}_2 \neq 0$ and integrability giving $d\rho_2 = 0$. Therefore ρ_2 determines a complex structure in the neighbourhood of p . Integrability also implies $d\rho_0 \wedge \rho_2 = 0$, meaning ρ_0 is a holomorphic function; define $w = \rho_0$ and choose z so that $\rho_2 = dw \wedge dz$. These coordinates therefore render \mathcal{J} into the desired normal form. \square

Theorem 1.13 allows us to determine what structures are inherited by the complex locus from the ambient generalized complex geometry. Let U_i be neighbourhoods for which the above theorem holds, with generalized complex structures defined by $\rho_i = w_i + dw_i \wedge dz_i$. On the overlaps $U_i \cap U_j$ we have

$$\rho_i = g_{ij} e^{B_{ij}} \rho_j, \quad (1.7)$$

for $g_{ij} : U_i \cap U_j \rightarrow \mathbb{C}^*$ and $B_{ij} \in \Omega_{cl}^2(U_i \cap U_j, \mathbb{R})$ smooth Čech cocycles. In degrees 0 and 2, this equation becomes

$$w_i = g_{ij} w_j \quad (1.8)$$

$$dw_i \wedge dz_i = g_{ij} dw_j \wedge dz_j + w_j g_{ij} B_{ij}. \quad (1.9)$$

Differentiating (1.8) and subtracting from (1.9), we obtain

$$g_{ij} dw_j \wedge (dz_j - dz_i) = w_j (g_{ij} B_{ij} + dg_{ij} \wedge dz_i), \quad (1.10)$$

which vanishes on the complex locus Σ , defined by $w_j = 0$. Expanding (1.10) along Σ , we obtain

$$g_{ij} dw_j \wedge (dz_j - \frac{\partial z_i}{\partial z_j} dz_j - \frac{\partial z_i}{\partial \bar{z}_j} d\bar{z}_j - \frac{\partial z_i}{\partial \bar{w}_j} d\bar{w}_j) \Big|_{\Sigma} = 0, \quad (1.11)$$

This implies that z_j is a holomorphic function of z_i on Σ , and furthermore $\partial z_j / \partial z_i = 1$. Hence the complex locus, where it is nondegenerate, inherits a complex structure with a distinguished trivialization of its holomorphic tangent bundle. This trivialization ∂_z corresponds precisely to the vector field $X + iY$ in the proof of Theorem 1.13.

Taking the Lie derivative of (1.9) in the \bar{z}_j direction and restricting to the complex locus, we see that $\partial g_{ij} / \partial \bar{z}_j = 0$, showing that the conormal bundle of Σ inherits a holomorphic structure. Summarizing, we obtain the following result, extending work in [1].

Corollary 1.14. Let Σ be the set of nondegenerate type changing points of a 4-dimensional generalized complex manifold M . Then Σ is a smooth 2-dimensional submanifold and inherits a holomorphic structure (i.e. it is a Riemann surface) as well as a distinguished trivialization Z of its holomorphic tangent bundle (of course, this determines a holomorphic differential $\Omega = Z^{-1}$). It follows immediately that any compact component of Σ must be an elliptic curve. Furthermore, the conormal bundle $N^*\Sigma$ inherits the structure of a holomorphic bundle.

Remark. The holomorphic vector field $Z = X + iY$ induced on the nondegenerate complex locus Σ has no canonical extension to the whole 4-manifold M . However, there is a natural extension of Y to a global class in the Poisson cohomology of M with respect to a real Poisson structure P obtained from the generalized complex structure (see [10] for details). In fact this extension is the *modular class* of the Poisson structure P in the sense of Weinstein [19].

2 Branes

Generalized complex branes [10] are a natural class of submanifolds defined for any generalized complex manifold. For usual complex manifolds the definition specializes to the notion of complex submanifold. In the symplectic case, Lagrangian submanifolds provide examples. It is appropriate to call these *(D)-branes* since they provide boundary conditions in topological open string theory.

Definition 2.1. A *brane* in a generalized complex manifold (M, H, \mathcal{J}) is a submanifold $\iota : \Sigma \hookrightarrow M$ together with a 2-form $F \in \Omega^2(\Sigma)$ satisfying $dF = \iota^*H$ and such that the subbundle $\tau_F \subset (TM \oplus T^*M)|_{\Sigma}$, defined by

$$\tau_F = \{X + \xi \in T\Sigma \oplus T^*M : \iota^*\xi = i_X F\},$$

is invariant under \mathcal{J} (i.e. τ_F is a complex subbundle).

Note that τ_F is a maximal isotropic subbundle isomorphic to $T\Sigma \oplus N^*\Sigma \subset TM \oplus T^*M$. When (M, \mathcal{J}) is a $2n$ -manifold of symplectic type, with canonical bundle generated by $e^{B+i\omega}$, the branes of lowest dimension are Lagrangian submanifolds $\iota : \Sigma \rightarrow M$ with $F = \iota^*B$. As shown in [9], there may exist non-Lagrangian branes on a symplectic $2n$ -manifold, of dimension $n + 2k$, corresponding to the coisotropic A-branes discovered by Kapustin and Orlov [14]. On the other hand, when (M, \mathcal{J}) is a usual complex structure, then (Σ, F) is a brane if and only if Σ is a complex submanifold and F is a $(1, 1)$ -form.

It follows from these extremal cases that even generalized complex 4-manifolds may only have 0, 2, or 4-dimensional branes. Branes of dimension zero coincide with points in the complex locus, since points of a symplectic manifold are not branes. It is shown in [10] that branes of dimension 4 only occur when (M, \mathcal{J}) is a deformation of a complex manifold via Theorem 1.10. We therefore concentrate on the description of branes of dimension 2.

Proposition 2.2. *Let (M, H, \mathcal{J}) be an even generalized complex 4-manifold, and let $\Sigma \subset M$ be a 2-dimensional submanifold intersecting the complex locus transversally at nondegenerate points. Then there exists $F \in \Omega^2(\Sigma)$ such that (Σ, F) is a brane if and only if Σ is Lagrangian away from the complex locus. Furthermore, F is unique when it exists.*

Proof. One implication follows from the description of branes for complex and symplectic structures. For the other implication, let U be the dense open set where the structure is of symplectic type, i.e. given by the form $e^{B+i\omega}$. Then $F = B|_\Sigma$ is the unique 2-form on $\Sigma \cap U$ such that τ_F is \mathcal{J} -invariant over $\Sigma \cap U$. Since \mathcal{J} -invariance is a closed condition, τ_F will be \mathcal{J} -invariant over all of Σ as long as F extends smoothly to Σ . Therefore it remains to show that F extends smoothly to the points where Σ intersects the complex locus.

Near a nondegenerate complex point, Proposition 1.13 provides the following normal form for \mathcal{J} : it is defined by

$$\rho = w + dw \wedge dz,$$

with $w = 0$ defining the complex locus. In coordinates $(w, z) = (x + iy, u + iv)$, we have that $\rho = we^{B+i\omega}$, for

$$\begin{aligned} B &= \frac{1}{x^2+y^2}(x(dx \wedge du - dy \wedge dv) + y(dx \wedge dv + dy \wedge du)), \\ \omega &= \frac{1}{x^2+y^2}(x(dx \wedge dv + dy \wedge du) - y(dx \wedge du - dy \wedge dv)). \end{aligned}$$

Since Σ is transversal to the complex locus, we can parametrize it as $\mathbb{X}(x, y) = (x, y, u(x, y), v(x, y))$ where u and v vanish at 0. Since Σ is Lagrangian, we have $\omega(\mathbb{X}_x, \mathbb{X}_y) = 0$, yielding

$$x(v_y - u_x) - y(u_y + v_x) = 0. \quad (2.1)$$

In particular, there exists a smooth function $f : \mathbb{R}^2 \rightarrow \mathbb{R}$ such that $u_y + v_x = x f$ and we can compute

$$\begin{aligned} B(\mathbb{X}_x, \mathbb{X}_y) &= \frac{1}{x^2+y^2}(x(u_y + v_x) + y(v_y - u_x)) \\ &= \frac{1}{x^2+y^2}(x(u_y + v_x) + \frac{y^2}{x}(u_y + v_x)) \\ &= \frac{1}{x}(u_y + v_x) = f, \end{aligned}$$

where in the second equality we used (2.1). Hence the restriction of B to Σ extends smoothly to $w = 0$, showing F is well defined on all of Σ . \square

In the case that \mathcal{J} is obtained by deforming a complex structure via Theorem 1.10, there is a rich source of examples of such 2-dimensional branes; in fact, curves in the original complex surface remain branes after the deformation, as we now show.

Proposition 2.3. *Let \mathcal{J}_β be the generalized complex structure obtained by deforming the complex surface (M, I) by the holomorphic bivector β . Then any smooth complex curve $\Sigma \subset M$ with respect to I is a brane for \mathcal{J}_β , with $F = 0$.*

Proof. Σ is a curve for I , hence

$$\tau_0 = \{X + \xi \in T\Sigma \oplus T^*M : \xi|_\Sigma = 0\} = T\Sigma \oplus N^*\Sigma$$

is invariant under \mathcal{J}_I . By Theorem 1.10, we have $\mathcal{J}_\beta = e^P \mathcal{J}_I e^{-P}$, for $P = \beta + \bar{\beta}$. The result then follows from the fact that $e^P \tau_0 = \tau_0$, which we now show. If $X + \xi \in \tau_0$, then $e^P(X + \xi) = X - P(\xi) + \xi$. But $P(N^*\Sigma) \subset T\Sigma$, i.e. Σ is P -coisotropic, since Σ is of type $(1, 1)$ with respect to I while P is of type $(2, 0) + (0, 2)$. \square

Example 1.11 provides examples of β -deformed complex structures on the total space of a holomorphic line bundle $\pi : L \rightarrow \Sigma$ over a Riemann surface; holomorphic bivectors of homogeneous degree i along the fibres are again given by

$$H^0(\Sigma, K_\Sigma^{-1} \otimes L^{1-i}). \quad (2.2)$$

Before deformation, complex curves in these examples include the zero section Σ , as well as any fiber $\pi^{-1}(p)$, $p \in \Sigma$. Therefore, by Proposition 2.3, all these give examples of 2-branes for \mathcal{J}_β . Taking $i = 0$, we obtain examples where the zero section Σ is a generically Lagrangian brane, as follows.

Example 2.4. Let Σ be a Riemann surface, and $D = \sum a_i p_i$, $a_i > 0$ an effective divisor on Σ , for p_1, \dots, p_n points in Σ . Let $\mathcal{O}(D)$ be the associated holomorphic line bundle, with section $\beta \in H^0(\Sigma, \mathcal{O}(D))$ such that $D = (\beta)$. By (2.2), β defines a deformation of the complex structure on the total space of $L = K_\Sigma(D)$ which is constant along the fibres and vanishes precisely on the fibres $\pi^{-1}(p_i)$ above the divisor. Hence the zero section Σ is a brane for \mathcal{J}_β which is generically Lagrangian but intersects the complex locus transversally at the points $p_i \in \Sigma$; at these points the complex locus is degenerate of order a_i .

This structure is easily described in coordinates: let $U_0 = \Sigma \setminus \{p_1, \dots, p_n\}$ and let $z_i : U_i \rightarrow \mathbb{C}$ be coordinates such that $z_i(p_i) = 0$ and $U_i \cap U_j = \emptyset$ for nonzero i, j unless $i = j$. The bundle $\mathcal{O}(D)$ is taken to be trivial on the U_i , with transition functions $f_{i0}(z_i) = z_i^{a_i}$. The defining section for the divisor D is given by the functions $z_i^{a_i}$ (in U_i , $i \neq 0$) and the constant function 1 in U_0 .

The line bundle $L = K_\Sigma(D)$ is described by tensoring the above trivialization of $\mathcal{O}(D)$ with $K_\Sigma = T^*\Sigma$. To specify the generalized complex structure, we give differential forms ρ_i on $\tilde{U}_i = T^*U_i$ and cocycles g_{ij}, B_{ij} such that (1.7) holds. Let w_i be the canonically conjugate coordinate to z_i on T^*U_i , let $\Omega = B + i\omega$ be the natural holomorphic symplectic form on $T^*\Sigma$, i.e. $\Omega|_{U_i} = dz_i \wedge dw_i$, and define

$$\begin{aligned} \rho_0 &= e^{i\omega}|_{\tilde{U}_0}, \\ \rho_i &= z_i^{a_i} + dz_i \wedge dw_i, \\ g_{i0}(z_i) &= z_i^{a_i}, \\ B_{i0} &= B|_{\tilde{U}_i \cap \tilde{U}_0}. \end{aligned}$$

Note that we glue T^*U_i to T^*U_0 via the diffeomorphism $\varphi_{i0} : (z_i, w_i) \mapsto (z_i, z_i^{a_i} w_i)$, due to the twisting by D . Therefore we have $\rho_i = \varphi_{i0}^* z_i^{a_i} (1 + dz_i \wedge dw_i) = \varphi_{i0}^* g_{i0} e^{B_{i0}} \rho_0$ in $U_0 \cap U_i$, as required.

The generalized complex structure in the previous example does not depend on the holomorphic structure of the initial Riemann surface Σ , or on the locations of the points p_i , since

a (orientation-preserving) diffeomorphism $\psi : \Sigma \rightarrow \Sigma'$ may always be chosen to send p_i to p'_i and to take z_i to z'_i in a neighbourhood of the points p_i, p'_i . The symplectic form on $T^*\Sigma$ is diffeomorphism invariant, hence we obtain $\psi^*\rho'_i = \rho_i$ for all i , yielding an isomorphism of generalized complex structures. This suggests the following more general example.

Example 2.5. Let Σ be a real smooth 2-manifold and $D = \sum a_i p_i$, $a_i > 0$, be a smooth effective divisor, i.e. a positive integer linear combination of points p_i of Σ . Choose complex coordinates z_i in neighbourhoods $U_i \subset \Sigma$ of p_i and canonically conjugate coordinates w_i in $\tilde{U}_i = T^*U_i$, so that $dz_i \wedge dw_i = B_i + i\omega$, where ω is the canonical real symplectic form on $T^*\Sigma$. Then setting $\tilde{U}_0 = T^*(\Sigma \setminus \{p_1, \dots, p_n\})$, the forms

$$\begin{aligned}\rho_0 &= e^{i\omega}|_{\tilde{U}_0}, \\ \rho_i &= z_i^{a_i} + dz_i \wedge dw_i, \\ g_{i0}(z_i) &= z_i^{a_i}, \\ B_{i0} &= B_i|_{\tilde{U}_i \cap \tilde{U}_0}.\end{aligned}$$

define a generalized complex structure on the total space $\Omega_{\Sigma}^1(D)$ of the cotangent bundle of Σ twisted by the line bundle with Euler class Poincaré dual to D .

When Σ is non-orientable, this generalized complex structure depends only on the diffeomorphism class of Σ and the set $a = \{a_1, \dots, a_n\}$ of multiplicities; we denote this generalized complex manifold by $\Omega_{\Sigma}^1(a)$, and simply $\Omega_{\Sigma}^1(n)$ if all $a_i = 1$.

When Σ is oriented, however, the chosen complex coordinates z_i may not be compatible with the orientation; indeed, we may divide the points into two groups $\{p_1, \dots, p_k\}, \{p_{k+1}, \dots, p_n\}$ according to whether z_i is compatible with orientation or not, respectively. Then the generalized complex structure depends only on the diffeomorphism class of the oriented 2-manifold Σ and the two sets of multiplicities $a_+ = \{a_1, \dots, a_k\}$, $a_- = \{a_{k+1}, \dots, a_n\}$. We denote this generalized complex manifold by $\Omega_{\Sigma}^1(a_+, a_-)$, and simply $\Omega_{\Sigma}^1(k, n-k)$ if all $a_i = 1$. In this case, therefore, we obtain a generalized complex structure on $\Omega_{\Sigma}^1(D)$ such that the zero section Σ defines an oriented 2-brane which intersects the complex loci $\pi^{-1}(p_i)$, $i \leq k$ positively and the remaining complex loci $\pi^{-1}(p_i)$, $i > k$ negatively, with respect to the natural orientation on the complex locus.

We have seen that 2-branes in even generalized complex 4-manifolds are generically Lagrangian; we now prove that such 2-branes have a standard tubular neighbourhood up to B -diffeomorphism, just as in the familiar case of Lagrangian submanifolds of symplectic manifolds. We restrict to the case where the 2-brane intersects the complex locus transversally; in this case, the standard neighbourhood is given by a neighbourhood of the zero section in $\Omega_{\Sigma}^1(n)$ or $\Omega_{\Sigma}^1(k, n-k)$ from Example 2.5.

Theorem 2.6 (Brane neighbourhood theorem). *Let $(\Sigma, F) \xrightarrow{\iota} (M, \mathcal{J})$ be a compact 2-brane in an even generalized complex 4-manifold which intersects the complex locus transversally at n nondegenerate points.*

- i) If Σ is non-orientable, then it has a tubular neighbourhood isomorphic to a neighbourhood of the zero section in $\Omega_{\Sigma}^1(n)$.*
- ii) Otherwise, orient Σ and let k be the number of points where its intersection with the complex locus is positive. Then Σ has a tubular neighbourhood isomorphic to a neighbourhood of the zero section in $\Omega_{\Sigma}^1(k, n-k)$.*

The proof will require the following two preliminary results.

Lemma 2.7. Under the hypotheses of Theorem 2.6, one can find coordinates around a point in the intersection of the brane with the complex locus so that the generalized complex structure is determined by

$$\rho = w + dw \wedge dz \quad (2.3)$$

and the brane is given by $z = 0$.

Proof. According to Theorem 1.13, a neighbourhood of a nondegenerate point in the complex locus is B -diffeomorphic to a neighbourhood of the origin in \mathbb{C}^2 , equipped with the generalized complex structure given by

$$w + dw \wedge dz = w \exp\left(\frac{dw \wedge dz}{w}\right).$$

Choose such coordinates so that the origin is a point p in the intersection of Σ with the complex locus.

Now let $B + i\omega = \frac{dw \wedge dz}{w}$. Since (Σ, F) is a brane, $F = B|_{\Sigma}$ is a well defined 2-form. Since Σ is transversal to $w = 0$ at p , in a neighbourhood around p we can write $F = \iota^* \tilde{F}$, where $\tilde{F} = -ib(w, \bar{w})dw \wedge d\bar{w}$, for a real function b . Note that \tilde{F} is a closed 2-form on a neighbourhood of 0 in \mathbb{C}^2 .

Now we can perform a B -field transform by \tilde{F} to obtain:

$$\begin{aligned} e^{-\tilde{F}}\rho &= w + dw \wedge dz - iwb dw \wedge d\bar{w} \\ &= w + dw \wedge (dz - iwb d\bar{w}) \\ &= w + dw \wedge d\tilde{z}, \end{aligned}$$

for new complex coordinates (w, \tilde{z}) . Since Σ is a brane, $\omega|_{\Sigma} = 0$ and by construction $(B - F)|_{\Sigma} = 0$, hence $dw \wedge d\tilde{z}$ annihilates $T\Sigma$, which shows that Σ is a complex submanifold of \mathbb{C}^2 with respect to this new complex structure. Therefore there is a holomorphic function $f(w)$ such that $\Sigma = \{(w, f(w))\}$ and hence $(w, z) := (w, \tilde{z} - f(w))$ are the required coordinates in which the generalized complex structure has the standard form (2.3) and Σ is given by $\{z = 0\}$. \square

Lemma 2.8. Under the hypotheses of Theorem 2.6, the normal bundle to Σ is diffeomorphic to $\Omega_{\Sigma}^1(D)$, i.e. the cotangent bundle twisted by the complex line bundle Poincaré dual to $[D] \in H_0(\Sigma, \mathbb{Z}_{\omega})$ (homology with orientation-twisted coefficients). Here $D = \sum p_i$, for $\{p_1, \dots, p_n\}$ the intersection of Σ with the complex locus.

Proof. The bundle τ_F is an extension of the form

$$0 \longrightarrow N^*\Sigma \longrightarrow \tau_F \longrightarrow T\Sigma \longrightarrow 0.$$

composing \mathcal{J} with the projection onto the tangent bundle π_T , we obtain a map

$$\pi_T \circ \mathcal{J} : \mathcal{N}^* \longrightarrow T\Sigma.$$

Fibrewise, this map vanishes precisely at the intersection points $\{p_i\}$ of Σ with the complex locus; otherwise it is an isomorphism.

By Lemma 2.7, near an intersection point, we can find coordinates so that the structure is given by (2.3) and Σ is given by $\{z = 0\}$. In this case, dz is a section of $N^*\Sigma$ and $\pi \mathcal{J} dz = 2iw \partial_w$. Therefore this point contributes with a +1 to the Euler characteristic of $T\Sigma$, i.e.

$$\chi(T\Sigma) = \chi(N^*\Sigma) + n.$$

Hence, as differentiable bundles, we have

$$N\Sigma \cong \Omega_{\Sigma}^1(D).$$

□

Proof of Theorem 2.6. By Lemma 2.8, a tubular neighbourhood of Σ is diffeomorphic to a neighbourhood of the zero section in $\Omega_{\Sigma}^1(D)$, for $D = \sum p_i$ given by the sum of the intersection points with the complex locus. This diffeomorphism can be chosen so that the generalized complex structure \mathcal{J} agrees, at the points $\{p_i\}$, with the normal form \mathcal{J}_0 given in Example 2.5, namely $\Omega_{\Sigma}^1(n)$ (for case *i*) or $\Omega_{\Sigma}^1(k, n - k)$ (for case *ii*).

According to Lemma 2.7, there is a B -diffeomorphism identifying \mathcal{J} with \mathcal{J}_0 in neighbourhoods of the intersection points $\{p_i\}$. Away from these neighbourhoods, $\mathcal{J}, \mathcal{J}_0$ have the form $\exp(B + i\omega)$, $\exp(B_0 + i\omega_0)$, and Σ is simply a Lagrangian submanifold for the symplectic structure ω , by Proposition 2.2. Moser's argument then furnishes a diffeomorphism ψ , compactly supported in the symplectic locus and fixing Σ , and such that $\psi^*\omega = \omega_0$ in a tubular neighbourhood of Σ . Finally we apply the B -field transform by $B_0 - \psi^*B$ to identify \mathcal{J} with \mathcal{J}_0 on the tubular neighbourhood, as required. □

3 Blowing up and down

A common feature of complex and symplectic manifolds is that any point p may be blown up to obtain a new complex or symplectic manifold, where p has been replaced by a complex projective space of real codimension 2, called the exceptional divisor. In the complex case, the blowup is uniquely determined by the choice of point; the exceptional divisor may be canonically identified with the projectivized tangent space to p . In the symplectic case, the blowup is not unique: it depends on a real parameter measuring the symplectic size of the exceptional divisor.

A point of symplectic type in a generalized complex manifold has a neighbourhood B -diffeomorphic to a symplectic structure. Hence, symplectic blow-up may be used to produce new generalized complex manifolds just as is done in symplectic geometry. Since this construction is based on the symplectic blow-up, the generalized complex structure obtained is non-unique.

In this section, we show that a nondegenerate complex point p in a generalized complex 4-manifold M may be blown up in a canonical fashion, just as for a complex manifold. Since the tangent space T_pM is complex, we may identify the exceptional divisor Σ with the complex projective line $\mathbb{C}\mathbb{P}(T_pM)$, which contains a distinguished point \tilde{p} corresponding to the tangent line to the locus of complex points near p . A neighbourhood of Σ is then isomorphic to a neighbourhood of the zero section in the tautological line bundle over Σ , equipped with the generalized complex structure from Example 2.4 with $D = \tilde{p}$; that is, Σ becomes a 2-brane which is Lagrangian away from \tilde{p} .

Conversely, we show that any 2-brane Σ in a generalized complex 4-manifold \tilde{M} which intersects the complex locus transversally in a single nondegenerate point \tilde{p} may be blown down, yielding a generalized complex 4-manifold M , with a marked nondegenerate complex point p . This is analogous to the result that any rational -1 -curve in a complex surface may be blown down.

By Theorem 1.13, a nondegenerate complex point $p \in M$ has a coordinate neighbourhood U with generalized complex structure \mathcal{J}_{β} given, in complex coordinates (w, z) , by

$$\rho = w + dw \wedge dz = e^{\beta}(dw \wedge dz), \tag{3.1}$$

for the bivector $\beta = w\partial_w \wedge \partial_z$. Let \tilde{U} be the usual complex blowup of U at p , so that \tilde{U} may be described as a neighbourhood of the zero section Σ of $\mathcal{O}(-1)$ over $\mathbb{C}P^1$. The anticanonical section β naturally lifts to a bivector $\tilde{\beta}$ on the blowup, which then defines a generalized complex structure $\tilde{\mathcal{J}}_{\tilde{\beta}}$ on \tilde{U} as in Example 1.11. Furthermore, as in Example 2.4, the exceptional divisor Σ becomes a 2-brane in \tilde{U} which is Lagrangian except at its intersection with the complex point $\tilde{p} = [z_1 = 0]$.

Choosing affine charts $\tilde{U}_1 = \{(w, \tilde{z}) = (w, z/w)\}$, $\tilde{U}_2 = \{(\tilde{w}, z) = (w/z, z)\}$ for the blowup, the bivector $\tilde{\beta}$ may be written as

$$\tilde{\beta} = \begin{cases} \partial_w \wedge \partial_{\tilde{z}} & \text{in } \tilde{U}_1 \\ \tilde{w}\partial_{\tilde{w}} \wedge \partial_z & \text{in } \tilde{U}_2, \end{cases}$$

giving a generalized complex structure $\tilde{\mathcal{J}}$ on \tilde{U} described by the forms

$$\tilde{\rho} = \begin{cases} 1 + dw \wedge d\tilde{z} & \text{in } \tilde{U}_1 \\ \tilde{w} + d\tilde{w} \wedge dz & \text{in } \tilde{U}_2. \end{cases} \quad (3.2)$$

This allows us to see explicitly that the exceptional divisor is a generically Lagrangian 2-brane (since $dw \wedge d\tilde{z}$ is a $(2, 0)$ -form, and hence vanishes upon pullback to Σ).

Proposition 3.1. *Let $\pi : \tilde{U} \rightarrow U$ be the blowup projection map. With respect to the generalized complex structures described above, the generalized map $\Pi = (\pi, 0)$ is holomorphic. Further, its restriction $\tilde{U} \setminus \pi^{-1}(p) \rightarrow U \setminus \{p\}$ is an isomorphism.*

Proof. Let $\pi_i : \tilde{U}_i \rightarrow U$ be the blowup projection restricted to the \tilde{U}_i , so that $\pi_1 : (w, \tilde{z}) \mapsto (w, w\tilde{z})$ while $\pi_2 : (\tilde{w}, z) \mapsto (\tilde{w}z, z)$. Calculating the pullback of $\rho = w + dw \wedge dz$, we have

$$\begin{aligned} \pi_1^* \rho &= w + wdw \wedge d\tilde{z} = w(1 + dw \wedge d\tilde{z}) \\ \pi_2^* \rho &= \tilde{w}z + zd\tilde{w} \wedge dz = z(\tilde{w} + \tilde{w} \wedge dz). \end{aligned}$$

Comparing with (3.2), we see that $\pi^* \rho$ defines the same generalized complex structure as $\tilde{\rho}$, away from the exceptional divisor. Since holomorphicity is a closed condition, we conclude that the generalized map $(\pi, 0)$ is holomorphic, as required. \square

Proposition 3.2. *Any generalized complex automorphism $\Phi = (\varphi, B)$ of U fixing p has a canonical lift to an automorphism $\tilde{\Phi} = (\tilde{\varphi}, \tilde{B})$ of the blowup \tilde{U} making the following diagram commute, where Π denotes the generalized holomorphic projection $(\pi, 0)$.*

$$\begin{array}{ccc} \tilde{U} & \xrightarrow{\Pi} & U \\ \tilde{\Phi} \downarrow & & \downarrow \Phi \\ \tilde{U} & \xrightarrow{\Pi} & U \end{array} \quad (3.3)$$

Proof. Since Φ is a generalized complex automorphism which fixes p , and since p is a complex point, $d\varphi|_p$ must be a complex linear automorphism of $T_p U$ (and $B|_p$ must be of type $(1, 1)$). Hence φ lifts to a diffeomorphism $\tilde{\varphi} : \tilde{U} \rightarrow \tilde{U}$ which acts via $\mathbb{P}(d\varphi|_p)$ on the exceptional divisor $\mathbb{P}(T_p U)$ and which coincides with φ elsewhere. Then we may take $\tilde{B} = \pi^* B$, yielding $\Pi \circ \tilde{\Phi} = \Phi \circ \Pi$, and $\tilde{\Phi}$ must be an automorphism since $\Pi^{-1} \circ \Phi \circ \Pi$ is an isomorphism on the dense set $\pi^{-1}(U \setminus \{p\})$. \square

Theorem 3.3 (Blowing up). *For any nondegenerate complex point $p \in M$ in a generalized complex 4-manifold, there exists a generalized complex 4-manifold \tilde{M} and a generalized holomorphic map $\pi : \tilde{M} \rightarrow M$ which is an isomorphism $\tilde{M} \setminus \pi^{-1}(p) \rightarrow M \setminus \{p\}$ and which is equivalent to $\pi : \tilde{U} \rightarrow U$ as above in a neighbourhood of $\pi^{-1}(p) \cong \mathbb{C}\mathbb{P}(T_p M)$. The pair (\tilde{M}, π) is called the blowup of M at p , and is unique up to canonical isomorphism.*

Proof. Choose a coordinate neighbourhood U of p which is standard in the sense of (3.1) and let $\pi : \tilde{U} \rightarrow U$ be the standard complex blowup as above. Then define $\tilde{M} = M \setminus \{p\} \cup_{\pi} \tilde{U}$ and extend π by the identity map to all of \tilde{M} . Then by Proposition 3.2, \tilde{M} is canonically independent of the chosen coordinates. \square

By Theorem 2.6, any 2-brane which intersects the complex locus in a single nondegenerate point has a standard tubular neighbourhood; in particular, such a 2-brane must have self-intersection -1 . Observing that the exceptional divisor $\Sigma = \pi^{-1}(p)$ of the blowup described above is precisely such a 2-brane, we obtain the following result.

Theorem 3.4 (Blowing down). *A generalized complex 4-manifold \tilde{M} containing a 2-brane $\Sigma \cong S^2$ intersecting the complex locus in a single nondegenerate point may be blown down; i.e. there is a generalized holomorphic map $\pi : \tilde{M} \rightarrow M$ to a generalized complex manifold M which is an isomorphism $\tilde{M} \setminus \Sigma \rightarrow M \setminus \{p = \pi(\Sigma)\}$, and which is equivalent to $\pi : \tilde{U} \rightarrow U$ as above in a neighbourhood of Σ .*

4 C^∞ log transform

In [1], the authors introduced a construction of generalized complex manifolds, wherein a symplectic 4-manifold (M, ω) undergoes surgery along an embedded symplectic 2-torus with trivial normal bundle to yield a generalized complex manifold with type change along a 2-torus. This type of 4-manifold surgery is called a C^∞ log transform [7]. We now clarify this construction and study its effect on a Lefschetz fibration.

Let $T \hookrightarrow M$ be a symplectic 2-torus with trivial normal bundle and symplectic area A . By Moser's argument, we may choose polar coordinates (r, θ_1) transverse to T and angular coordinates (θ_2, θ_3) along T such that the symplectic form becomes, for $r < \varepsilon$,

$$\omega = r dr \wedge d\theta_1 + \frac{A}{4\pi^2} d\theta_2 \wedge d\theta_3. \quad (4.1)$$

Let $U_0 = M \setminus \{(r, \theta_1, \theta_2, \theta_3) : r \leq \frac{\varepsilon}{2}\}$, and equip it with the given symplectic structure

$$\rho_0 = e^{i\omega}|_{U_0}.$$

We now compare this to the singular symplectic structure near the complex locus of a generalized complex manifold.

Consider the quotient of the generalized complex structure from Example 1.6 by the lattice $\Gamma = \langle A, iA \rangle \subset \mathbb{C}$, where $\gamma \in \Gamma$ acts via $\gamma : (z, w) \mapsto (z + \gamma, w)$. Then the complex locus $\Sigma = \{w = 0\}$ is an elliptic curve with modular parameter $\tau = i$. As per Corollary 1.14, Σ inherits a canonical holomorphic differential $\Omega = dz$, which in turn defines A via $A^2 = \int_{\Sigma} i\Omega \wedge \bar{\Omega}$. With respect to polar coordinates $w = \tilde{r}e^{i\tilde{\theta}_1}$ and angular coordinates $\tilde{\theta}_2 = \frac{2\pi}{A} \operatorname{Re}(z)$, $\tilde{\theta}_3 = \frac{2\pi}{A} \operatorname{Im}(z)$, the generalized complex structure is given by

$$\rho_1 = \tilde{r}e^{i\tilde{\theta}_1} \left(1 + \frac{A}{4\pi^2} (d \log \tilde{r} + i d\tilde{\theta}_1) \wedge (d\tilde{\theta}_2 + i d\tilde{\theta}_3) \right),$$

which is proportional to $e^{\tilde{B} + i\tilde{\omega}}$ for the singular forms

$$\begin{aligned} \tilde{B} &= \frac{A}{4\pi^2} (d \log \tilde{r} \wedge d\tilde{\theta}_2 - d\tilde{\theta}_1 \wedge d\tilde{\theta}_3), \\ \tilde{\omega} &= \frac{A}{4\pi^2} (d \log \tilde{r} \wedge d\tilde{\theta}_3 + d\tilde{\theta}_1 \wedge d\tilde{\theta}_2). \end{aligned}$$

We then observe that $\tilde{\omega}$ (for $\tilde{r} > \tilde{r}_0 > 0$) is symplectomorphic to ω (for $r > 0$) via the coordinate transformation

$$\varphi_{\tilde{r}_0} : (r, \theta_1, \theta_2, \theta_3) \mapsto (\tilde{r}, \tilde{\theta}_1, \tilde{\theta}_2, \tilde{\theta}_3) = (\tilde{r}_0 e^{2\pi^2 A^{-1} r^2}, \theta_2, \theta_3, \theta_1).$$

If we glue the open set U_0 to the open set $U_1 = \{(\tilde{r}, \tilde{\theta}_1, \tilde{\theta}_2, \tilde{\theta}_3) : \tilde{r} < 1\}$ along the neck $\varepsilon/2 < r < \varepsilon$, using the diffeomorphism $\varphi_{\tilde{r}_0}$, with $\tilde{r}_0 = e^{-2\pi^2 A^{-1} \varepsilon^2}$ (so that, for $\varepsilon/2 < r < \varepsilon$ we have $\tilde{r}_0 e^{\frac{\pi^2 \varepsilon^2}{2A}} < \tilde{r} < 1$), then we observe that, in $U_0 \cap U_1$, we have

$$e^{B_{01}} \varphi_{\tilde{r}_0}^* \rho_1 = e^{i\omega} = \rho_0,$$

for the closed 2-form $B_{01} \in \Omega^2(U \cap V, \mathbb{R})$ given by

$$B_{01} = -r dr \wedge d\theta_3 - \frac{A}{4\pi^2} d\theta_1 \wedge d\theta_2. \quad (4.2)$$

Choosing a Čech trivialization $B_{01} = (B_1 - B_0)|_{U_0 \cap U_1}$ for $B_i \in \Omega^2(U_i, \mathbb{R})$, we see that $\{e^{B_i} \rho_i\}$ defines a generalized complex structure on the surgered manifold $\hat{M} = U_0 \cup_{\varphi_{\tilde{r}_0}} U_1$, which has symplectic type in U_0 and which changes type in U_1 along an elliptic curve. While the underlying 3-form of the original symplectic manifold (M, ω) vanishes, this is not the case for \hat{M} , where the 3-form is given by $H|_{U_i} = -dB_i$.

The cohomology class $[H]$ may be easily described, since for any closed 1-form ξ , we have

$$\int_{\hat{M}} H \wedge \xi = - \int_{T^3 \simeq U_0 \cap U_1} B_{01} \wedge \xi.$$

Hence by (4.2), $[H]$ is Poincaré dual to A times the circle parametrized by θ_3 . Since θ_3 corresponds to θ_2 in the gluing, we may describe this circle as an integral circle of the real part of the canonical holomorphic vector field $Z = \partial/\partial z$ on Σ . The 4-manifold surgery described above is known as a C^∞ logarithmic transform of multiplicity zero. We now summarize the above discussion.

Theorem 4.1 (Cavalcanti–Gualtieri [1]). *Let (M, ω) be a symplectic 4-manifold, $T \hookrightarrow M$ be a symplectic 2-torus of area A with trivial normal bundle. Then the multiplicity zero C^∞ logarithmic transform of M along T , denoted \hat{M} , admits a generalized complex structure such that:*

1. *The complex locus is given by an elliptic curve Σ with modular parameter $\tau = i$, and the induced holomorphic differential Ω has periods $\langle A, iA \rangle$.*
2. *Integrability holds with respect to a 3-form H , which is Poincaré dual to A times the homology class of an integral circle of $\text{Re}(\Omega^{-1})$ in Σ .*

Example 4.2 (Lefschetz fibrations). Let (M, ω) be a symplectic 4-manifold which is expressed as a symplectic Lefschetz fibration (in the sense of [4]) $\pi : M \rightarrow B$ whose generic fiber has genus 1. If T is a smooth fiber, then it is a symplectic 2-torus with trivial normal bundle. Trivialize the fibration near T so that a neighbourhood of T is diffeomorphic to $D^2 \times T^2$, where π is the first projection. In coordinates, we have $\pi(r, \theta_1, \theta_2, \theta_3) = (r, \theta_1)$.

We may now apply an isotopy, supported in a sufficiently small neighbourhood of T , taking ω into the standard form (4.1) in some neighbourhood of T and such that π remains a symplectic Lefschetz fibration.

Now, let \hat{M} be the C^∞ logarithmic transform of M along T as in Theorem 4.1. Then, using the preceding notation, the fibration projection π is still well defined on U_0 . We extend π to U_1 , and hence to all of \hat{M} , as follows. For points in $U_0 \cap U_1$ (for which $\tilde{r} > \tilde{r}_0 e^{\pi^2 \varepsilon^2 (2A)^{-1}}$), the projection may be written

$$\pi : (\tilde{r}, \tilde{\theta}_1, \tilde{\theta}_2, \tilde{\theta}_3) \mapsto (r, \theta_1) = \left(\left(\frac{A}{2\pi^2} \log \frac{\tilde{r}}{\tilde{r}_0} \right)^{1/2}, \tilde{\theta}_3 \right). \quad (4.3)$$

To extend this to all of U_1 , we choose $f : [0, 1] \rightarrow [\varepsilon/4, \varepsilon]$ to be a smooth monotone function of \tilde{r} such that $f(0) = \varepsilon/4$ and f agrees with $r = r(\tilde{r})$ (see (4.3)) for $\tilde{r}_0 e^{(2A)^{-1} \pi^2 \varepsilon^2} < \tilde{r} < 1$. Then we define, for all $\tilde{r} \in [0, 1]$,

$$\hat{\pi}|_{U_1} : (\tilde{r}, \tilde{\theta}_1, \tilde{\theta}_2, \tilde{\theta}_3) \mapsto (f(\tilde{r}), \tilde{\theta}_3).$$

This defines a projection of U_1 onto an open-closed annulus $\varepsilon/4 \leq r < 1$; together with the projection $\pi : U_0 \rightarrow B \setminus \{r \leq \varepsilon\}$, we obtain a projection of \hat{M} onto the surface with boundary $\hat{B} = B \setminus D_{\varepsilon/4}^2$:

$$\hat{\pi} : \hat{M} \longrightarrow \hat{B} = B \setminus \{(r, \theta) : r < \varepsilon/4\}.$$

This map is a symplectic Lefschetz fibration away from the boundary $\partial \hat{B} = \{r = \varepsilon/4\}$, where the fiber degenerates to a circle; indeed $\hat{\pi}^{-1}(\partial \hat{B})$ is precisely the elliptic curve forming the complex locus of the generalized complex manifold. The fibers over boundary points are the integral circles for $\text{Re}(Z)$, and we obtain from $\hat{\pi}_* \text{Im}(Z)$ a vector field along the boundary with period A . Note also that since we are not changing the Lefschetz fibration outside a neighbourhood of $\partial \hat{B}$, the monodromy about any path homotopic to the boundary is trivial.

The generalized Lefschetz fibration described above provides a pictorial description of the behaviour of the generalized complex structure: the geometry is symplectic over the interior $\hat{B} \setminus \partial B$ and complex over the boundary ∂B . Furthermore, the generalized complex structure is integrable with respect to a closed 3-form H which is Poincaré dual to A times the homology class of the circle $\hat{\pi}^{-1}(p)$, for $p \in \partial \hat{B}$.

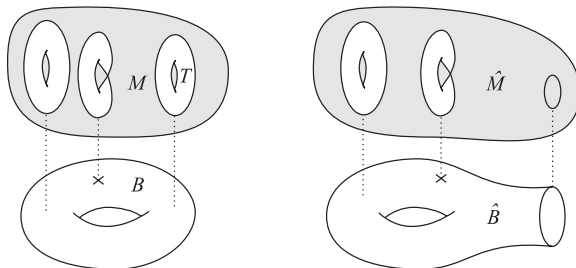

Figure 1: A symplectic genus 1 Lefschetz fibration undergoes surgery along a smooth fiber T , becoming a generalized Lefschetz fibration of a generalized complex 4-manifold over a surface with boundary.

5 Examples

In this section, we use the tools introduced above, namely blowing up and down as well as the C^∞ log transform, in conjunction with the representation of a generalized complex 4-manifold as a generalized elliptic Lefschetz fibration, to produce new examples of generalized complex manifolds. In particular, we show that the connected sum of any odd number of copies of $\mathbb{C}P^2$ has a generalized complex structure.

Example 5.1 (Fiber sums). Given symplectic manifolds M_1, M_2 , each equipped with a genus 1 Lefschetz fibration over bases B_1, B_2 respectively, we may produce their symplectic fiber sum (see [6]), denoted $M_1 \#_f M_2$, using a symplectic identification of smooth fibers. The fiber sum is then a Lefschetz fibration over the connected sum $B_1 \# B_2$.

The C^∞ log transform $\widehat{M_1 \#_f M_2}$ then has a generalized Lefschetz fibration over a manifold with boundary which is precisely the *boundary connected sum* of the surfaces with boundary \hat{B}_1, \hat{B}_2 which form the bases of the generalized Lefschetz fibrations associated to the C^∞ log transforms \hat{M}_1, \hat{M}_2 . We therefore obtain a connected sum operation for the generalized Lefschetz fibrations described above along the boundary fiber.

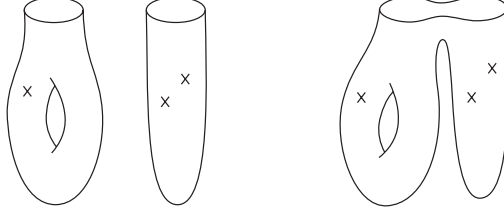

Figure 2: The connected sum of generalized Lefschetz fibrations over \hat{B}_1, \hat{B}_2 along the boundary fiber is itself a generalized Lefschetz fibration over the boundary connected sum $\hat{B}_1 \#_{\partial} \hat{B}_2$.

Example 5.2 (Branes and blow down). A standard tool in symplectic topology, described in [4], is the construction of Lagrangian spheres in symplectic manifolds by the method of vanishing cycles. This proceeds essentially by choosing a path in the base of a Lefschetz fibration connecting two nodal fibers which is such that the same cycle degenerates at each end of the path. Using a connection determined by the symplectic orthogonal of the fibers, a representative of the vanishing cycle traces out a Lagrangian sphere fibering over the original path.

For a generalized complex 4-manifold presented as a generalized Lefschetz fibration, we may use the method of vanishing cycles to construct two types of branes in addition to the Lagrangian spheres which exist in the symplectic locus. The first is obtained by connecting two boundary points in the base by a path such that the same cycle degenerates near each end. In this case we obtain a 2-sphere which is Lagrangian in the symplectic locus and intersects the complex locus transversally at two points. Proposition 2.2 then implies that this sphere is a brane, which according to Theorem 2.6 has trivial normal bundle.

The more interesting case arises when connecting a boundary point in the base with the base point of a nodal fiber in such a way that the same cycle degenerates at each end. Then we obtain a 2-sphere brane intersecting the complex locus transversally at precisely one nondegenerate point (hence by Theorem 2.6 it has self-intersection -1). According to Theorem 3.4 we may blow down such a spherical brane to obtain a new generalized complex manifold. Note that the blow down does not inherit a Lefschetz fibration; rather, it may be viewed as an analogue of a Lefschetz pencil.

In the final example, we show that the connected sum of any odd number of copies of $\mathbb{C}P^2$ admits a generalized complex structure. This is of particular interest for the following reasons. First, due to the Kodaira classification of complex surfaces and a fundamental result in Seiberg–Witten theory, the manifolds $n\mathbb{C}P^2 \# m\overline{\mathbb{C}P^2}$ have neither complex nor symplectic structures when $n > 1$ [15, 18, 21]. Therefore, this example produces a family of generalized complex manifolds which do not admit complex or symplectic structures. Second, due to results of Hirzebruch and Hopf [12], an oriented simply connected 4-manifold admits an almost complex structure if and only if b_2^+ is odd. Since generalized complex manifolds are necessarily almost complex [10], this example shows that for connected sums of $\mathbb{C}P^2$ and $\overline{\mathbb{C}P^2}$, there is no obstruction to the existence of a generalized complex structure besides that of being almost complex.

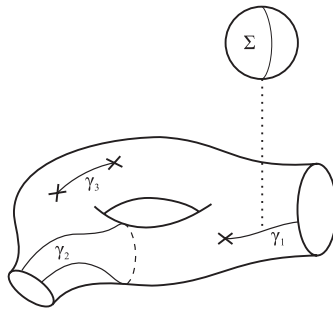

Figure 3: The path γ_1 joins a boundary fiber to a nodal fiber with equal vanishing cycle and lifts to a 2-sphere brane Σ with self-intersection -1 . The path γ_2 joins boundary fibers with equal vanishing cycle and lifts to a 2-sphere brane with trivial normal bundle. The path γ_3 joins nodal fibers with same vanishing cycle, and lifts to a usual Lagrangian sphere in the symplectic locus.

Example 5.3 (A generalized complex structure on $(2n - 1)\mathbb{C}P^2$). The blow up of $\mathbb{C}P^2$ at the 9 points of intersection of two generic cubics provides a basic example of a symplectic 4-manifold equipped with an elliptic Lefschetz fibration. This manifold is sometimes denoted by $E(1)$, and $E(n)$ is the fiber sum of n copies of $E(1)$. For example, $E(2)$ is diffeomorphic to a $K3$ surface. A relevant fact concerning the manifolds $E(n)$ is that the multiplicity zero C^∞ logarithmic transform along a smooth fiber, $\widehat{E(n)}$, “dissolves” [8]:

$$\widehat{E(n)} = (2n - 1)\mathbb{C}P^2 \# (10n - 1)\overline{\mathbb{C}P^2}.$$

For $n = 1$ we obtain the diffeomorphism $\widehat{E(1)} = \mathbb{C}P^2 \# 9\overline{\mathbb{C}P^2} = E(1)$. In light of Example 5.2, we can see the nine -1 spheres in the generalized complex manifold $\widehat{E(1)}$ explicitly in the following way. The Lefschetz fibration of $E(1)$ over S^2 has twelve nodal fibers with critical values which we label $\{y_1, y_2, y_3, x_1, \dots, x_9\}$. Choose a smooth fiber F_0 about which to perform the C^∞ log transform. With respect to a fixed set of paths joining F_0 to the nodal fibers, and using a basis $\{a, b\}$ for $H_1(F_0, \mathbb{Z})$, the degenerating cycles are $a + 3b, a, a - 3b$ for the fibers over y_1, y_2, y_3 , and b for the remaining 9 fibers over x_i (see e.g., Example 8.2.11 in [8]). We now perform the C^∞ log transform about F_0 , collapsing the cycle b . We obtain a generalized Lefschetz fibration of $\widehat{E(1)}$ over a disk with boundary, as in Figure 4.

Since the paths joining the points x_i to F_0 have vanishing cycle b , after the surgery they become paths joining nodal fibers to boundary points with equal vanishing cycles, and hence lift to a configuration of nine 2-sphere branes intersecting the complex locus at single points. By Theorem 3.4, we may blow down each of these spheres and obtain a generalized complex structure on the blow down, which by Proposition 5.4 in the Appendix, is diffeomorphic to $\mathbb{C}P^2$. Generalized complex structures on $\mathbb{C}P^2$ similar to this one may alternatively be obtained by deforming the complex structure by a Poisson bivector as in Theorem 1.10.

For a more interesting example, construct the connected sum of $\widehat{E(1)}$ with itself along the boundary fiber, as in Example 5.1, obtaining a new generalized Lefschetz fibration over the boundary connected sum, as in Figure 5. When performing the fiber sum, we must choose an identification of the tori which fiber over the boundary circles. If $(a_i, b_i), i = 1, 2$ form a basis for the first homology of a smooth fiber on each summand, then we require that b_2 is identified with b_1 . We obtain in this way a generalized complex 4-manifold containing nine 2-sphere branes from each summand, resulting in 18 clearly visible 2-sphere branes which intersect the complex locus in single points. There is some freedom in the identification of a_1 in the connected sum; if we set $a_2 = a_1 - 7b_1$, then using the monodromy around $a_1 - 3b_1$ we

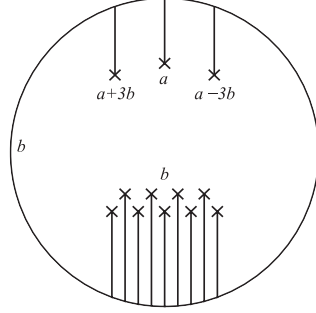

Figure 4: A generalized Lefschetz fibration of $\widehat{E(1)}$ over a disk with boundary, where the C^∞ log transform along $F_0 \subset E(1)$ collapses the b cycle at the boundary fiber. The chosen paths are shown, and the vanishing cycles at nodal fibers are labeled.

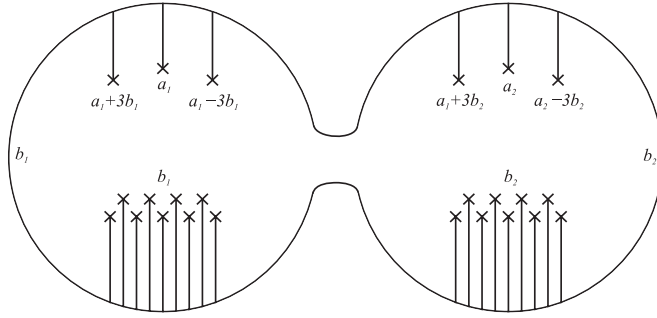

Figure 5: A generalized Lefschetz fibration of $\widehat{E(2)} = 3\mathbb{C}P^2 \# 19\overline{\mathbb{C}P^2}$, over the boundary connect sum of closed discs from Figure 4. The boundary vanishing cycle b_1 is identified with b_2 in the connect sum, hence we immediately see 18 2-sphere branes of self-intersection -1 .

can change the cycle $a_2 + 3b_2 = a_1 - 4b_1$ into $-b_1$. The new path which realizes this vanishing cycle is denoted by γ in Figure 6.

Therefore, in the boundary fiber connected sum $\widehat{E(2)}$, we find 19 2-sphere branes intersecting the complex locus in single nondegenerate points. Since $\widehat{E(2)} = 3\mathbb{C}P^2 \# 19\overline{\mathbb{C}P^2}$, we would like to conclude that upon blowing down these 19 spheres, we obtain a generalized complex structure on the differentiable manifold $3\mathbb{C}P^2$. In Proposition 5.4 (see Appendix), we use Kirby calculus to verify this claim.

The procedure above may be iterated, taking successive boundary connect sum with $\widehat{E(1)}$, so that with each new summand we obtain 10 more 2-sphere branes intersecting the complex locus in nondegenerate points. Therefore we obtain $10n - 1$ spherical branes of self-intersection -1 in the generalized complex manifold $\widehat{E(n)}$ which can be blown down. Using Kirby calculus again, we prove that the resulting manifold is precisely $(2n - 1)\mathbb{C}P^2$, which therefore has a generalized complex structure.

Remark. While we use Kirby calculus in the above example to prove that the manifold

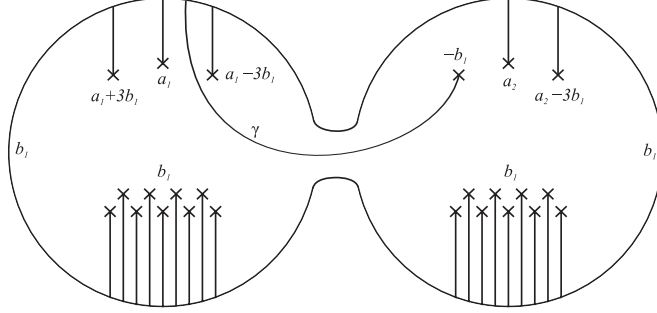

Figure 6: Using the monodromy around the $a_1 - 3b_1$ critical value, we reveal a 19^{th} 2-sphere brane of self-intersection -1 , fibering over the path γ .

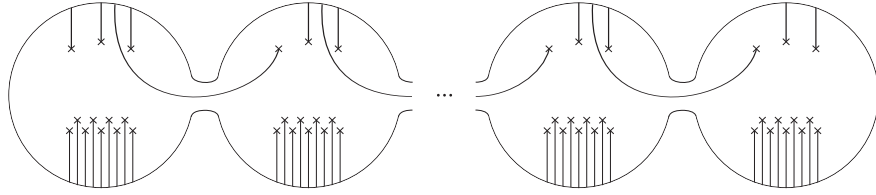

Figure 7: Iterating the boundary fiber connected sum, we find $(10n - 1)$ 2-sphere branes in $\widehat{E}(n) = (2n - 1)\mathbb{C}P^2 \# (10n - 1)\overline{\mathbb{C}P^2}$ intersecting the complex locus in single points. Blowing down each of these, we obtain a generalized complex structure on $(2n - 1)\mathbb{C}P^2$.

obtained after blowing down the $(10n - 1)\overline{\mathbb{C}P^2}$ is diffeomorphic to $(2n - 1)\mathbb{C}P^2$, there is a simple argument establishing a homotopy equivalence. Indeed, after blowing down all the $\overline{\mathbb{C}P^2}$, we obtain a smooth 1-connected manifold with positive intersection form. By results of Donaldson [5], the only possible intersection form is the diagonal $(2n - 1)\mathbf{1}$. Since this manifold has the same intersection form as $(2n - 1)\mathbb{C}P^2$, they must be homotopic [20, 16].

Appendix 1 – Kirby calculus

In the previous section we obtained a manifold, $\widehat{E}(n)$, as a boundary fiber connected sum of n copies of $\widehat{E}(1)$, or equivalently, as a C^∞ log transform applied to the symplectic fiber sum of n copies of $E(1) = \mathbb{C}P^2 \# 9\overline{\mathbb{C}P^2}$. In this section we give a handlebody decomposition of $\widehat{E}(n)$ which makes clear the effect of blowing down the $(10n - 1)\overline{\mathbb{C}P^2}$. This will show that the resulting manifold is indeed $(2n - 1)\mathbb{C}P^2$.

Proposition 5.4. *The manifold obtained in Example 5.3 as the blow-down of the specified $(10n - 1)\overline{\mathbb{C}P^2}$ in $\widehat{E}(n)$ is diffeomorphic to $(2n - 1)\mathbb{C}P^2$.*

Proof. The first step is to simplify the vanishing cycle information in the description of $\widehat{E}(n)$ in Figure 6. Using the monodromy, we can bundle the $(10n - 1)$ singular fibers with degenerating cycle b together. Furthermore, we can make some symmetry evident by replacing

a by $a + 4(n - 1)b$. We then obtain the following vanishing cycles

$$\begin{cases} a + (4n - 1)b, \\ a + 4kb, \text{ for } k = n - 1, \dots, 1 - n, \\ a - (4n - 1)b, \\ (10n - 1) \text{ cycles of type } b, \end{cases}$$

arranged as in Figure 8.

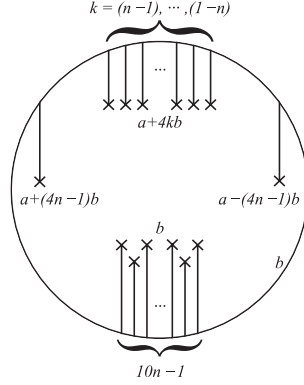

Figure 8: Generalized Lefschetz fibration of $\widehat{E}(n)$ over a closed disk.

The Kirby diagram for $E(n)$ with a regular fiber removed is obtained by attaching -1 framed 2-handles to $T^2 \times D^2$ for each of the nodal fibers. Then $\widehat{E}(n)$, the surgered manifold, is obtained from that diagram by attaching a 0-framed 2-handle corresponding to the cycle in T^2 which is collapsed by the surgery [8]. This diagram is shown in Figure 9, where the 2-handles corresponding to the vanishing cycles $a + (4n - 1)b, a + 4(n - 1)b, \dots, a - 4(n - 1)b, a - (4n - 1)b$ are denoted by $\alpha_n, \alpha_{n-1}, \dots, \alpha_{-n+1}, \alpha_{-n}$, the 2-handles corresponding to the vanishing cycles b are denoted by $\beta_1, \dots, \beta_{10n-1}$ and the 0-framed 2-handle introduced by the surgery is denoted by γ

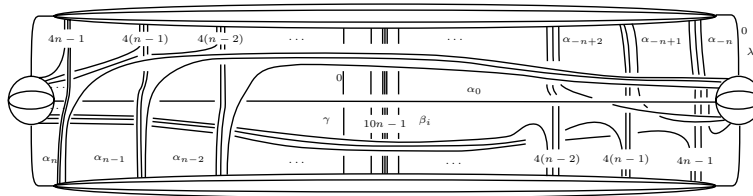

Figure 9: 1 and 2-handles of the Kirby diagram for $\widehat{E}(n)$. All 2-handles are blackboard -1 -framed, except for the outermost, λ , and one of the 2-handles running over the vertical 1-handle, γ . The latter represents the b -cycle on the fibers which collapses on the boundary of the base.

If we slide all the handles represented by β_i (the circles through the vertically symmetric squashed spheres in Figure 9) over the 0-framed 2-handle γ , also representing the b -cycle, we obtain $(10n - 1)$ -1 -framed unknots which split out of the diagram. These are precisely the $(10n - 1)\mathbb{C}P^2$ described in Example 5.3, hence removing them from the diagram corresponds

to blowing down those cycles. We can also slide each of the other -1 -framed 2-handles over a number of copies of γ so that the only 2-handle intersecting the top and bottom spheres is γ itself. Finally, we can cancel the 1-handle representing b with γ . If we let $A(n)$ be the manifold obtained after blowing down, the argument above shows its Kirby diagram is as shown in Figure 10.

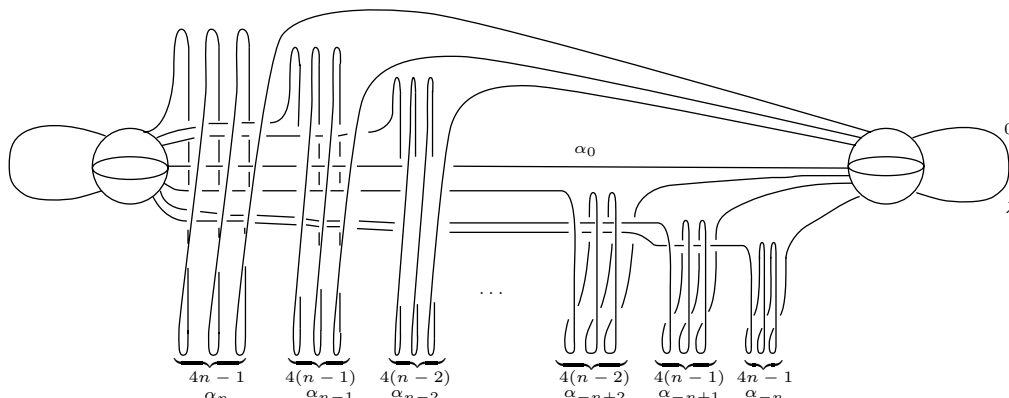

Figure 10: 1 and 2-handles of the Kirby diagram of $A(n)$. All 2-handles are blackboard -1 -framed, except for λ , which is 0-framed.

Now observe that the 2-handle represented by λ can be pushed through the 1-handle and becomes a zero framed unknot disjoint from the rest of the diagram which can therefore be cancelled against a 3-handle.

Then we can slide all the remaining handles through the handle labeled α_0 in Figure 10, so that we can cancel the remaining 1-handle with α_0 and obtain Figure 11 as the Kirby diagram for $A(n)$.

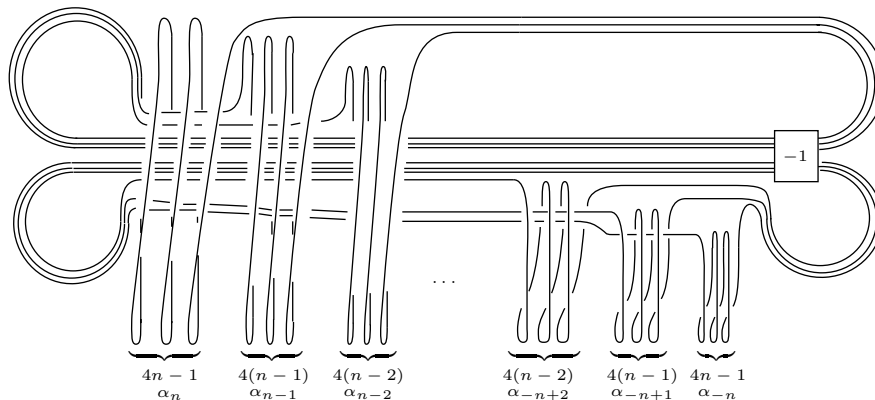

Figure 11: $A(n)$ as a 2-handlebody. All 2-handles are blackboard -1 -framed.

Now that all the 1-handles are gone, we can abandon the blackboard framing and use instead the Seifert framing. Further, we observe that we can move α_n and α_{-n} so that their crossings with the other handles in the diagram are simplified, obtaining Figure 12 as the diagram for $A(n)$.

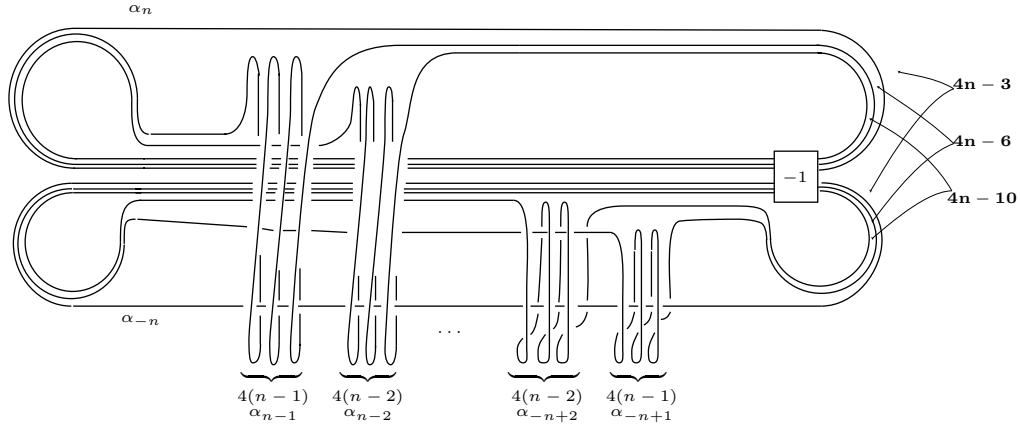

Figure 12: $A(n)$ as a 2-handlebody. The boldfaced numbers indicate the canonical framing of the respective handles.

And then we can move α_{n-1} so that it wraps around α_n and after that move α_{n-2} so that it wraps around α_n and α_{n-1} and so on. This way, the handles α_i with $i > 0$ will only knot with the α_i with $i < 0$ in the -1 box and we obtain the more symmetric Kirby diagram for $A(n)$ shown in Figure 13.

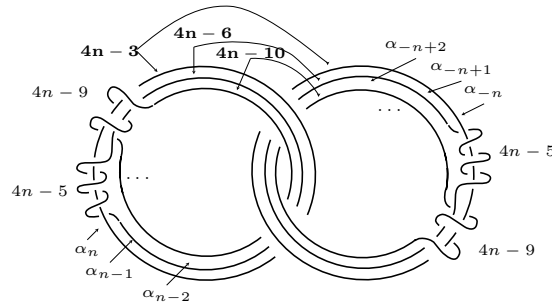

Figure 13: $A(n)$ as a 2-handlebody. The boldfaced numbers indicate the canonical framing of the respective handles.

We now prove by induction that this manifold is $(2n-1)\mathbb{C}P^2$. In the case when $n = 1$, the diagram in Figure 13 becomes a pair of 1-framed 2-handles linked in a Hopf link. A handle slide separates them (see Figure 14), rendering a 1-framed 2-handle and a 0-framed 2-handle. The 0-framed 2-handle cancels with a 3-handle and the result is $\mathbb{C}P^2$, as required.

In the general case, we can slide α_n over α_{n-1} as well as slide α_{-n} over α_{-n+1} , turning them into 1-framed 2-handles knotting only $\alpha_{\pm(n-1)}$. Splitting out the 1-framed 2-handles (see Figure 15), we obtain the diagram for $2\mathbb{C}P^2 \# A(n-1)$, proving the induction step. \square

Acknowledgements. We would like to thank Denis Auroux, Nigel Hitchin, David Martinez and Vicente Muñoz for useful conversations.

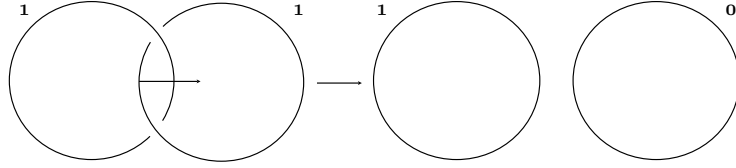

Figure 14: A simple handle slide shows that $A(1) = \mathbb{C}P^2$.

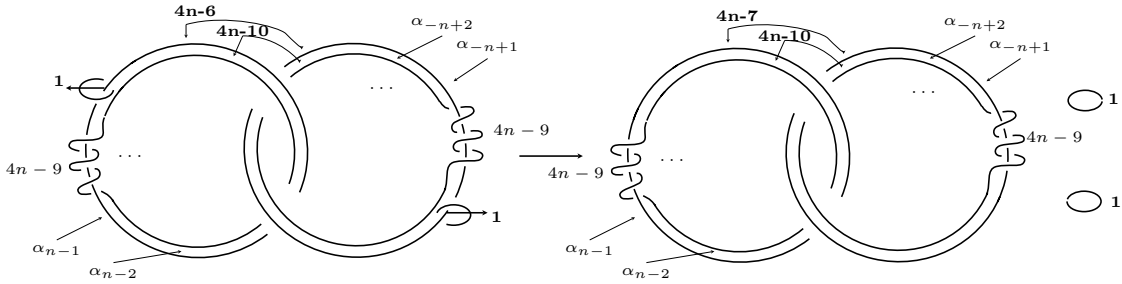

Figure 15: In the general case, two handle slides imply $A(n) = A(n-1) \# 2\mathbb{C}P^2$.

References

- [1] G. CAVALCANTI AND M. GUALTIERI. A surgery for generalized complex structures on 4-manifolds. *J. Differential Geom.*, 76(1):35–43, 2007.
- [2] T. COURANT. Dirac manifolds. *Trans. Amer. Math. Soc.*, 319:631–661, 1990.
- [3] M. CRAINIC. Generalized complex structures and Lie brackets. arXiv:math/0412097v2 [math.DG].
- [4] S. DONALDSON. Lefschetz pencils on symplectic manifolds. *J. Differential Geom.*, 53:205–236, 1999.
- [5] S. DONALDSON AND P. KRONHEIMER. *The geometry of four-manifolds*. Oxford Mathematical Monographs. The Clarendon Press Oxford University Press, New York, 1990. Oxford Science Publications.
- [6] R. GOMPF. *A new construction of symplectic manifolds*, Annals of Mathematics 142 (1995), 527-595
- [7] R. GOMPF AND T. MROWKA. Irreducible 4-manifolds need not be complex. *Ann. of Math.*, 138(1):61–111, 1993.
- [8] R. GOMPF AND A. STIPSICZ *4-manifolds and Kirby calculus*, volume 20 of *Graduate Studies in Mathematics*. American Mathematical Society, Providence, RI, 1999.
- [9] M. GUALTIERI. *Generalized complex geometry*. D.Phil. thesis, Oxford University, 2004. math.DG/0401221.
- [10] M. GUALTIERI. *Generalized complex geometry*. Preprint, 2007. arXiv:math/0703298v2 [math.DG].
- [11] M. GUALTIERI. *Branes on Poisson varieties*. To appear, Proceedings of the Geometry Conference in Honour of Nigel Hitchin. Oxford University Press. arXiv:0710.2719v1 [math.DG].

- [12] F. HIRZEBRUCH AND H. HOPF. Felder von Flächenelementen in 4-dimensionalen Mannigfaltigkeiten. *Math. Ann.*, 136:156–172, 1958.
- [13] N. HITCHIN. Generalized Calabi-Yau manifolds. *Q. J. Math.*, 54(3):281–308, 2003.
- [14] A. KAPUSTIN AND D. ORLOV. Remarks on A-branes, mirror symmetry, and the Fukaya category. *J. Geom. Phys.*, 48, 2003.
- [15] K. KODAIRA. On the structure of compact complex analytic surfaces. I. *Amer. J. Math.*, 86:751–798, 1964.
- [16] J. MILNOR. On simply connected 4-manifolds. In *Symposium internacional de topología algebraica International symposium on algebraic topology*, pages 122–128. Universidad Nacional Autónoma de México and UNESCO, Mexico City, 1958.
- [17] P. ŠEVERA AND A. WEINSTEIN. Poisson geometry with a 3-form background. *Prog. Theo. Phys. Suppl.*, **144**, 145 – 154, 2001.
- [18] C. H. TAUBES. The Seiberg-Witten invariants and symplectic forms. *Math. Res. Lett.*, 1(6):809–822, 1994.
- [19] A. WEINSTEIN. The modular automorphism group of a Poisson manifold. *J. Geom. Phys.*, 23:379–394, 1997.
- [20] J. WHITEHEAD. On simply connected, 4-dimensional polyhedra. *Comment. Math. Helv.*, 22:48–92, 1949.
- [21] E. WITTEN. Monopoles and four-manifolds. *Math. Res. Lett.*, 1(6):769–796, 1994.