

A Temperley–Lieb category for 2-manifolds

Marcos Alvarez and P P Martin

Mathematics Department, City University,
Northampton Square, London EC1V 0HB, UK.

Abstract

Guided by consideration of problems in 2 and 3 dimensional lattice model computation, we are led to define a number of new categories, and functors between these categories and the partition category, culminating in the introduction of two categories generalising the Temperley–Lieb category. We show how to compute practically in these categories, by giving a combinatorial realisation of their (topological) construction.

Contents

1	Introduction	2
1.1	The Potts model/dichromatic polynomial paradigm	3
1.2	Overview	7
1.3	Glossary of terms	8
2	Concrete diagrams	8
2.1	Categories of concrete diagrams	11
2.2	Functors to partition categories	13
3	Isotopy and minimality of concrete diagrams	15
3.1	Isotopy and strong isotopy	16
3.2	Hyperplane isotopy	17
3.3	Representatives of isotopy classes	19
3.4	Handles and minimality	19
3.5	Class compositions: examples and counter examples	20
3.6	Pre-isomorphisms: symmetries of boundary configurations	21
4	Diagrams: classes of concrete diagrams	22
4.1	Non-infinitesimal concrete diagram transformations	23
4.2	Heterotopy and strong heterotopy	25
5	Combinatorial characterisation of diagrams	27

6	The strong heterotopy diagram category	29
7	A heterotopy category	30
7.1	Composition of diagrams in $\mathcal{KS}_{\mathfrak{h}}^3$	30
7.2	Well-definedness Theorem	31
7.3	Properties of the composition $[A]_{\mathfrak{h}} \cdot [B]_{\mathfrak{h}}$	32
8	Practical enumeration of diagrams	33
8.1	Graph basics, tree graphs and $S_{\mathfrak{h}}^2$	34
8.2	Enumerating diagrams in $S_{\mathfrak{sh}}^3$ and $S_{\mathfrak{h}}^3$	35
8.3	Examples	37
9	Discussion	38
A	Rooted tree combinatorics	38
A.1	Ordering rooted trees	39
A.2	Partial orders on the set of rooted trees	40
B	Diagram category representation theory	41
C	Lemmas for proof of associativity: genus counting	44

1 Introduction

This work is motivated, on the one hand, by the need implicit in certain topological models of magnetic charge [32, 12] to understand the construction of space manifolds by gluing bounded manifolds through a common spherical boundary [2], and on the other hand by the idea of generalising the planar diagram calculus [34] of the Temperley-Lieb algebra [33] to higher dimensions.

The Temperley-Lieb algebra crops up in a wide variety of mathematical and physical contexts, from algebraic Lie theory [16, 17], statistical mechanics [7, 21] (and see Section 1.1), knot theory [18], conformal field theory [20] and combinatorics, to colouring problems [30], TQFT, Khovanov homology [19] and C*-algebras [13]. In most of those contexts the planar diagram calculus can be seen as integral to the algebra's involvement. In this calculus the algebra (indeed category) has a basis of diagrams drawn on a rectangular interval of the plane. The rectangle contains non-intersecting lines which end on its upper and lower edges, and two diagrams are equivalent if they differ by an edge-preserving ambient isotopy. Two diagrams A and B may be composed into a third diagram AB if the number of lines in A ending on its lower edge equals the number of lines in B ending on its upper edge.

It is of interest in several of the contexts above to try to generalise this setup to higher dimensions. In particular, several interesting two-dimensional models have been solved in statistical mechanics by algebraic methods [7, 21], but almost none in dimension three, which is the dimension most directly relevant to equilibrium physics (cf. [8, 29]).

There are a number of forms this diagram calculus generalisation might take, and various such have been considered [21, 22]. Perhaps the most superficially obvious generalisation, composition of open m -manifolds embedded in $(m + 1)$ -space¹, has not previously been fully treated from this point of view (although see [21, 4, 5]) for the following reason. Non-intersecting lines intersect the (let's say) upper edge of a Temperley–Lieb diagram A at distinct points, and distinct points on \mathbb{R} have a natural order that is preserved by ambient isotopy. Thus for diagrams to be composable the line counting condition above is sufficient. (This is the same as to say that the object set in the category is the natural numbers \mathbb{N}_0 .) If $m = 2$ then lines become surfaces and intersect the northern and southern plane in loops. Clearly, for two “diagrams” to compose the number of loops in the juxtaposed layers must match, but this embedding does not order the loops, and the matching loop number is not sufficient for two loop configurations to be ambient isotopic and hence for diagrams with these configurations to be composable (cf. cobordism and TQFT [3]). Another associated complication that occurs for $m = 2$ is that some composable diagrams can be composed in more than one way.

More than one formal resolution of these ambiguities is possible. To explain a way to choose a ‘good’ resolution we now recall the framework from Physics which provides the motivating example. An overview of the paper follows in Section 1.2.

1.1 The Potts model/dichromatic polynomial paradigm

The physical setting for the Temperley–Lieb algebra from which we want to generalise is well known [6, 9, 21]. For G a graph with vertex set V_G and edge set E_G we associate a Q -state Potts variable $\sigma_i \in \underline{Q} := \{1, 2, \dots, Q\}$ to each $i \in V_G$. One starts with the Potts Hamiltonian for G

$$H_G = \sum_{\langle ij \rangle \in E_G} \delta_{\sigma_i, \sigma_j} + h \sum_{i \in V_G} \delta_{\sigma_i, 1}$$

We take magnetic field parameter $h = 0$ and form the partition function

$$Z_G(\beta) = \sum_{\{\sigma_i\}} \exp(\beta H_G) = \sum_{\{\sigma_i\}} \prod_{\langle ij \rangle \in E_G} \exp(\beta \delta_{\sigma_i, \sigma_j}) = \sum_{\{\sigma_i\}} \prod_{\langle ij \rangle \in E_G} (1 + v \delta_{\sigma_i, \sigma_j})$$

where $v = \exp(\beta) - 1$. Expanding we have

$$Z_G(\beta) = \sum_{\{\sigma_i\}} \sum_{G' \in \mathcal{P}(E_G)} \prod_{\langle ij \rangle \in G'} v \delta_{\sigma_i, \sigma_j} = \sum_{G' \in \mathcal{P}(E_G)} v^{|G'|} Q^{\#(G')} \quad (1)$$

where $|G'|$ is the number of edges and $\#(G')$ is the number of connected components of G' regarded as a subgraph of G in the obvious way. Example: Figure 1(i) shows a subgraph G' on a square lattice, with $\#(G') = 12$.

¹Actually we will argue elsewhere that m -manifolds in $2m$ -space may be more interesting in the context of statistical mechanics, but this is even harder, so we start here.

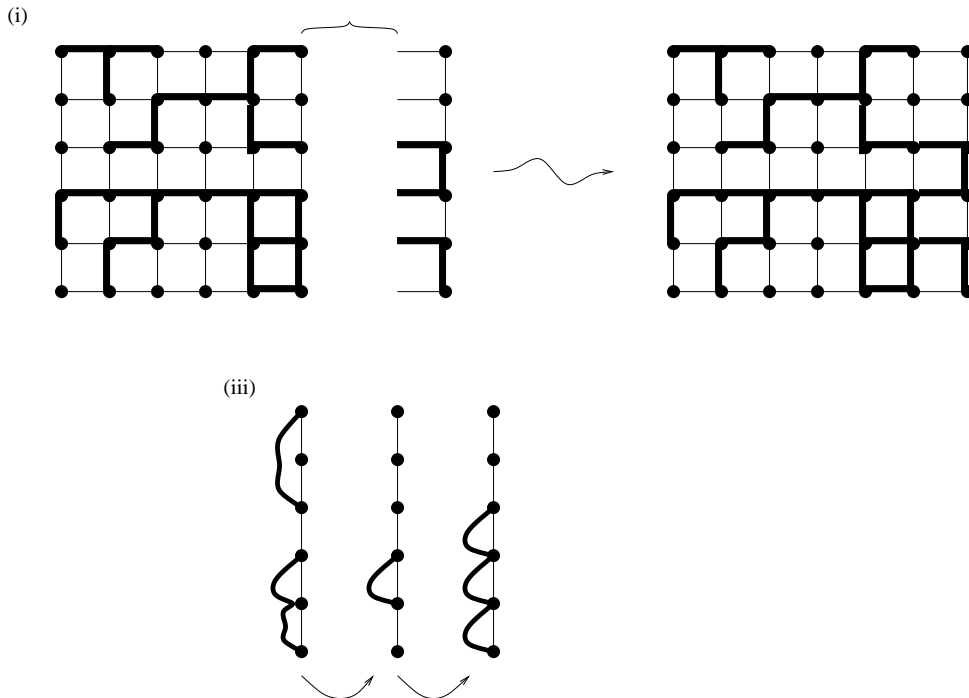

Figure 1: (i) A subgraph of a square lattice and an extra layer. (ii) The corresponding new subgraph. (iii) A sequence showing: the connectivity of the original subgraph (running $\# = 12$); the connectivity after adding the new horizontal edges (running $\# = 12 + 3$); the connectivity after adding the new vertical edges (running $\# = 12 + 3 - 2$).

We can now consider the RHS of (1) in its own right (as a ‘dichromatic’ polynomial in variables v and Q). The exercise is to construct a transfer matrix formulation in which to compute it, in cases where G has (‘time’) translation symmetry. We also require that G embeds in some Euclidean space and that its edges (and hence the Potts interactions) are local. However even this is not enough to make the interactions in the dichromatic polynomial formulation local, since $\#(G')$ is not local. Instead we need to introduce an entirely different state space. Although the restriction is not necessary, for the sake of simplicity we will describe this by considering the example of the n -site wide square lattice.

In adding an extra layer to this lattice we are adding $2n - 1$ edges. As ever in a transfer matrix formalism, the problem is to find a set of states which keep enough information about the old lattice G to determine $\#(G')$ for the new one. It will be evident that each state must record which of the last layer of vertices in G are connected to each other (by some route in G — cf. Figure 1 (i), (ii) and (iii)). Neither the details of the connecting routes nor any other information is needed, thus our state set is simply contained in the set of partitions of the last layer of vertices. It is straightforward to see that (in the square, or otherwise plane, lattice case) precisely the set of ‘plane’ partitions are needed. These are the partitions realisable by noncrossing paths in the interior when the vertices are arranged around the edge

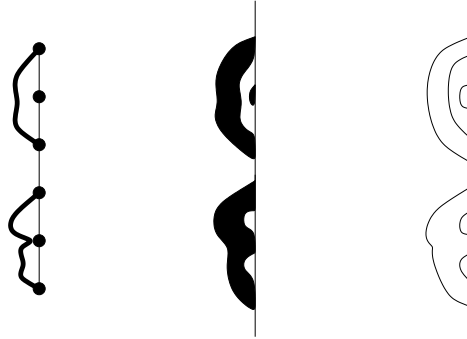

Figure 2: TL diagram.

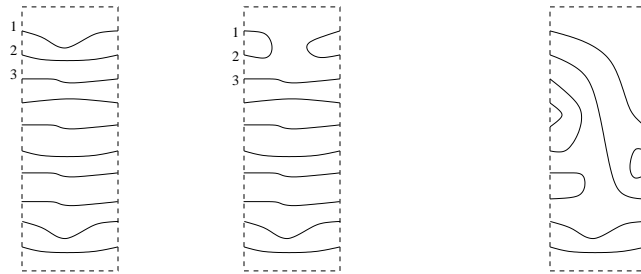

Figure 3: TL identity diagram, diagram D_1 , and a diagram with different numbers of in and out-vertices.

of a disk.

Pictures of such paths are called Whitney diagrams [21]. If instead we represent plane partitions by boundaries of connected regions these diagrams become Temperley–Lieb (or boundary) diagrams on the disk. Note that these are plane *pair* partitions (of double the number of vertices). See Figure 2 for an example. Note that the original lattice itself has all but disappeared from the state space (replaced by a topological/combinatorial construct).

Finally we note that in order to compute correlation functions some further information must be retained (essentially the details of connections also with the vertices on the left-hand side of the graph in Figure 1). This corresponds to Temperley–Lieb diagrams on the rectangle – i.e. with both in-vertices and out-vertices. These diagrams may be composed by juxtaposition at one edge of the rectangle when the number of states agrees. With an appropriate reduction rule for interior loops (replace by a factor \sqrt{Q}) this becomes the Temperley–Lieb algebra (indeed category, indeed monoidal category).

NB, casting the state space in this form is certainly beautiful and computationally convenient (see [23]), but it is not the same as integrability. Since the Potts model is integrable under certain conditions solutions to the Yang–Baxter equations can be constructed using Temperley–Lieb diagrams, but such exercises will not be

our focus in the present paper.

The following set of Temperley–Lieb diagrams generate the Temperley–Lieb algebra on n vertices (i.e. n in- and n out-vertices). The identity diagram is the rectangle in which each in-vertex is connected to the corresponding out-vertex. The diagram D_i is like the unit except that in-vertices i and $i+1$ are connected, and out-vertices i and $i+1$ are connected. (See Figure 3.) The generators are D_1, \dots, D_{n-1} . As already noted, composition $B \circ C$ is by juxtaposition so that the out-vertices of B meet the in-vertices of C (becoming internal points in the new diagram). The state space we have constructed induces a representation R of these elements. The transfer matrix is then

$$T = \prod_i (1 + \frac{v}{\sqrt{Q}} R(D_{2i})) \prod_i (\frac{v}{\sqrt{Q}} + R(D_{2i-1}))$$

and

$$Z(\beta) = \text{Tr}(T^n)$$

Finally, the trace can be decomposed into the irreducible representations in R (amongst other partial diagonalisations). The close relationship this engenders between representation theory and correlation functions (see e.g. [23]) is what we aim to generalise.

We require to generalise this picture in particular to higher dimensions. For the sake of definiteness let us now consider the cubical lattice. The direct generalisation of the Potts model leads us to certain graph Temperley–Lieb algebras – subalgebras of the partition algebra [22]. However these are extremely intractable (see [11]). Here we take a different approach, staying closer to TL diagrams.

Both mathematically and physically it is convenient to assemble the Temperley–Lieb algebras into the Temperley–Lieb category (diagrams with different numbers of in- and out-vertices [21], see later for details). Accordingly we approach the problem of generalisation here by casting the problem in a categorical framework, and defining a number of categories generalising this category. The claim is that this is natural, and ultimately makes the exposition more efficient.

Hereafter we draw and compose diagrams from bottom to top, rather than from left to right (i.e. subsequent pictures are rotated through 90° compared to those above). This is merely a space saving device.

The Temperley–Lieb category $\mathcal{C}_T = (\mathbb{N}, \text{hom}_T(-, -), \circ)$ is monoidal [17, 28] and generated as such by the diagrams

$$\boxed{\begin{array}{c} \text{ } \\ \cup \\ \text{ } \end{array}} \in \text{hom}_T(1, 1) \quad \boxed{\begin{array}{c} \text{ } \\ \cup \\ \text{ } \end{array}} \in \text{hom}_T(2, 0)$$

(cf. the diagrams above) and inversion. In this orientation it is the monoidal composition that is drawn from left to right. For example, if $*$ is the monoidal composition then

$$\boxed{\begin{array}{c} \text{ } \\ \cup \\ \text{ } \end{array}} * \boxed{\begin{array}{c} \text{ } \\ \cup \\ \text{ } \end{array}} * \boxed{\begin{array}{c} \text{ } \\ \cup \\ \text{ } \end{array}} = \boxed{\begin{array}{c} \text{ } \\ \cup \\ \text{ } \end{array}}$$

(Strictly speaking one works in the \mathbb{C} -linear category $\mathcal{C}_{T(\delta)}$ in which

$$\boxed{\bigcirc} \equiv \delta \boxed{} \in \text{hom}_T(0, 0) \quad (2)$$

and, by our loop replacement rule, $\delta = \sqrt{Q} \in \mathbb{C}$.)

As noted, these diagrams are shorthand for plane pair partitions. However for the purposes of generalisation it will be convenient to begin (in Section 2) by treating them more literally as lines embedded in \mathbb{R}^2 .

One can view a curve properly embedded in a frame F (an interval of \mathbb{R}^2) as connecting two points on the boundary (if it is open), or as a separation of F into two connected components. The Jordan curve theorem can be seen as a connection between these views. As we see above, Temperley–Lieb diagrams are generated by such embeddings (eventually one is only interested in the topology rather than the specific embedding). In generalising to higher d the two perspectives suggest distinct generalisations. The Jordan theorem may be generalised to the Jordan–Brouwer theorem [10, 35]:

Theorem 1 *A closed (or properly embedded) $d-1$ -manifold immersed in Euclidean space \mathbb{R}^d ($d > 2$) separates \mathbb{R}^d into two domains of which it is the common boundary.*

And this gives the spirit of the approach we shall adopt here.

Remark: The converse (that a bounded and closed point set that separates, every point of which is accesible from each domain, is a manifold) is not true in general, but our considerations here are limited by what can be built as a limit of lattice objects (or by related physical considerations), so it is safe enough heuristically to consider manifolds and separating sets as interchangeable.

1.2 Overview

Our first task is to give a more precise description of the diagrams from which we shall construct our generalisation.

These diagrams, which we call “concrete diagrams”, form a continuously infinite set. We require that our generalisations of TL algebras retain the property of finite-dimensionality. Accordingly we will partition the continuously infinite set of concrete diagrams into a countably infinite collection of finite sets, each set characterised (in the three-dimensional case) by a configuration of loops in the plane. The elements of these finite sets are the equivalence classes of concrete diagrams of an equivalence relation that we call “heterotopy”, which extends ambient isotopy by allowing and regulating certain topology changes. The next task is to define a notion of composition for these equivalence classes based on the intuitive idea of concatenating concrete diagrams by pasting the bottom of one of them to the top of the other one. Then we can define our category. This category belongs to the beautiful class of diagram categories, having a rich structure in representation theory, beside generalising our physical setting. We conclude with some remarks on the structure of the category (although a detailed investigation of its representation theory will be presented elsewhere).

1.3 Glossary of terms

$b(D)$	number of <i>bubbles</i> in concrete diagram D	§2
\mathcal{C}^d	category of concrete diagrams in dimension d	Prop.2.7
$\mathcal{K}\mathcal{C}^d(\delta)$	\mathcal{K} -linearised \mathcal{C}^d quotient	§2.1
$\mathcal{C}_{\mathbb{P}}$	partition monoid base category	§2.2
$\mathcal{C}_{\mathbb{P}(\delta)}$	partition category with parameter $\delta \in \mathcal{K}$	§2.2
\mathcal{C}_{sh}	strong heterotopy category	§6
$\mathcal{C}_{T(\delta)}$	Temperley–Lieb category	§1.1
$\partial_{\pm}D$	upper/lower concrete boundary of D	Def.2.4
E_t^d	interval of Euclidean d -space	§2
$g(D)$	genus of three-dimensional concrete diagram D	§3.4
I_F	‘straight’ isomorphism in π_F	Def.3.8
$\mathbb{P}(T)$	set of partitions of set T	§2.2
$\mathcal{P}(T)$	power set of set T	§1.3
P_0X	point set of embedded manifold X	§2
P_1X	set of connected components of X	§2
$p(D)$	partition of connected components of ∂D	Def.2.8
π_F	set of pre-isomorphisms in $S^d[F, F]$	Def.3.8
$R(D)$	D with bubbles removed	§2
\mathbb{S}^d	d -sphere	§1.3
S^d	set of concrete diagrams in d dims; lower hyperplane at $t = 0$	Def.2.1
$S^d[F_+, F_-]$	subset of S^d ; $D \in S^d[F_+, F_-]$ implies $\partial_{\pm}D = F_{\pm}$	Def.2.5
S_D^d	set of representatives of isotopy classes of concrete diagrams	Def.3.12
$S_D^d[F_+, F_-]$	set of representatives of isotopy classes in $S^d[F_+, F_-]$	Def.3.12
S_{\parallel}^d	set of concrete ∂ -diagrams of dimension d	Def.2.1
$S_{\parallel}^d(n)$	subset of concrete ∂ -diagrams with n components	Def.2.1
S_{∂}^d	set of isotopy class representatives of S_{\parallel}^d	Def.3.10
S_{min}^d	set of minimal concrete diagrams	Def.3.1
$S_{min}^d[F_+, F_-]$	subset $S_{min}^d \cap S^d[F_+, F_-]$	Def.3.1
$S_{\parallel}^3[F, F']$	set of heterotopy classes of diagrams in $S_{min}^3[F, F']$	Def.4.10
$S_{\text{sh}}^3[F, F']$	set of strong heterotopy classes of diagrams in $S_{min}^3[F, F']$	Def.4.10

2 Concrete diagrams

Fix $d \in \mathbb{N}$. It is convenient to formulate our underlying space \mathbb{R}^d with one preferred direction, called ‘time’ t . Time totally orders spatial hyperplanes (hyperplanes perpendicular to the t -axis) without further coordinatisation. Given a point $(v, t) \in \mathbb{R}^d$ we can associate a projection $v \in \mathbb{R}^{d-1}$. For $t \in \mathbb{R}$ write f_t for the embedding

$$f_t : \mathbb{R}^{d-1} \rightarrow \mathbb{R}^d \quad (3)$$

$$f_t(v) = (v, t)$$

As usual, if M is a manifold with boundary we write ∂M for the boundary. Thus ∂M is a manifold without boundary, of dimension one less than M . (There

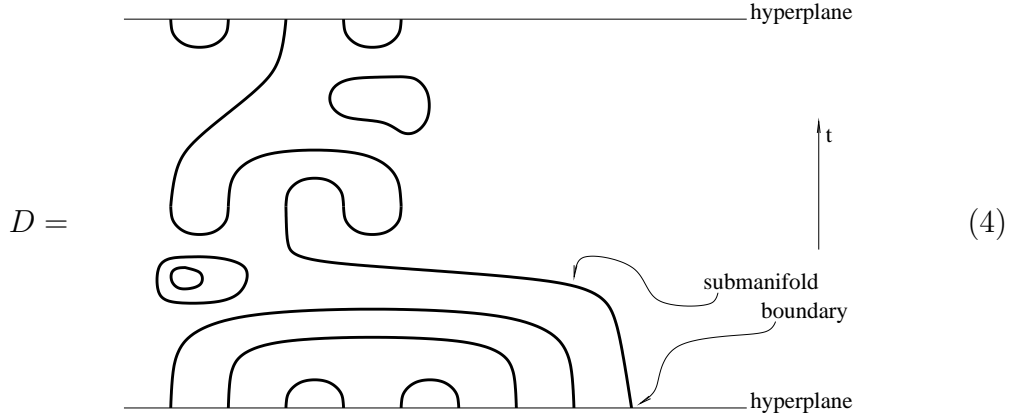

Figure 4: Example concrete diagram in $d = 2$ with $|D| = 10$ and $b(D) = 3$.

is a version of what follows for manifolds ‘with corners’, but we will not treat it here.) For clarity, if we want to treat a manifold embedded in \mathbb{R}^d as a set of points we may write $P_0(M) \subset \mathbb{R}^d$; while $P_1(M)$ will denote the partition of this point set into the connected components $\{M_i\}$ of M . Write $|M|$ for the number of connected components; $b(M)$ for the number with $\partial M_i = \emptyset$; and $R(M)$ for the manifold obtained from M by removing every M_i with $\partial M_i = \emptyset$.

Recall that a manifold embedding $f : X \rightarrow Y$ is *proper* if

$$f(\partial X) = f(X) \cap \partial Y$$

(for smooth manifolds there is also a transversality condition).

Fix $t \geq 0$. Then

$$E_t = E_t^d := \mathbb{R}^{d-1} \times [0, t].$$

The subspaces $\mathbb{R}^{d-1} \times \{0\}$ and $\mathbb{R}^{d-1} \times \{t\}$ are the components of the boundary of E_t^d .

Definition 2.1 A concrete diagram in E_t^d is a collection $D = \{D_i\}$ of connected compact submanifolds (‘components’) of codimension-1, properly embedded in E_t^d , such that

- (i) the submanifolds do not intersect;
- (ii) each boundary component is topologically a $(d - 2)$ -sphere.

Let S_t^d denote the set of concrete diagrams in E_t^d ; and $S^d = \cup_t S_t^d$ — the set of concrete diagrams.

(Note that each D_i is usually a $(d - 1)$ -dimensional manifold. However we include the case S_0^d as a limit, and in this case each D_i is just a $(d - 2)$ -sphere.)

There are examples in Figures 4, 5, 6 and 7. The main property of each D_i , for our purposes, will be that it separates E_t^d into two regions, and is the boundary of both, with every point in it accessible from both.

Definition 2.2 Let E be a Euclidean space and D a subset. Then $C_E(D)$ is the number of connected components of $E \setminus D$.

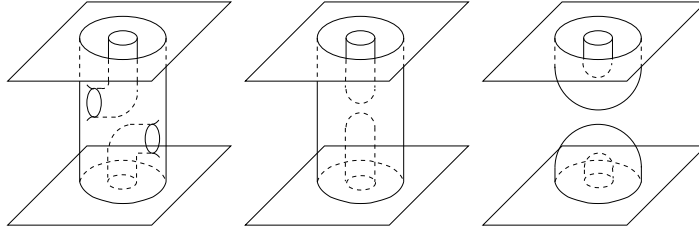

Figure 5: A representation of examples of concrete diagrams in \mathbb{R}^3 whose upper and lower boundary configurations each consist of two concentric loops.

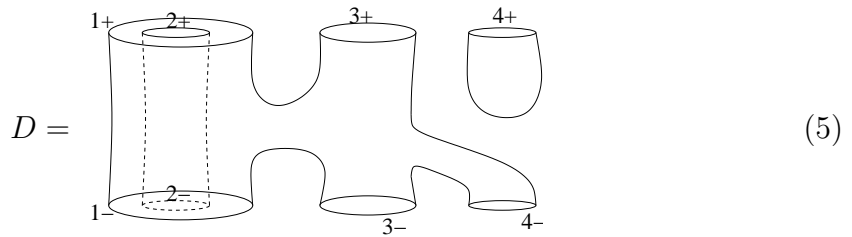

Figure 6: A representation of a concrete diagram with labelled boundary components.

It is assumed that all the components of all concrete diagrams lie within some finite interval of \mathbb{R}^d . So we assume in particular that there is a region of \mathbb{R}^d (or even E_t^d) spatially very far away from the components of any diagram. (This ‘outer’ region is connected unless $d = 2$. In $d = 2$ we will consider the outer region to be the part on the right.)

The set of boundary components contained in the upper (respectively, lower) hyperplane is called the *upper (lower) boundary configuration*.

Definition 2.3 A concrete ∂ -diagram in dimension d is a collection of non-intersecting topological $(d - 1)$ -spheres (i.e. without boundary) embedded in \mathbb{R}^d .

Thus a boundary configuration of a concrete diagram in dimension d is a concrete ∂ -diagram in dimension $d - 1$.

In $d = 2$ the hyperplanes of a concrete diagram are simply two parallel lines (the *edges* of the diagram). The components are one-dimensional submanifolds embedded between the two edges. If a component has a boundary, it consists of exactly two distinct 0-spheres (points) which may be both on the same edge, or one on each edge. Those components without a boundary are homeomorphic to closed loops. The upper (lower) boundary configuration is the set of boundary points in the upper (lower) edge. Thus we see that those concrete diagrams in \mathbb{R}^2 with equal numbers of boundary points in both edges are concrete Temperley–Lieb diagrams.

In $d = 3$ the hyperplanes are two parallel planes and the components are essentially Riemann surfaces with (possibly empty) boundaries attached to the limiting planes. See Figure 5. The boundaries contained in a limiting plane define

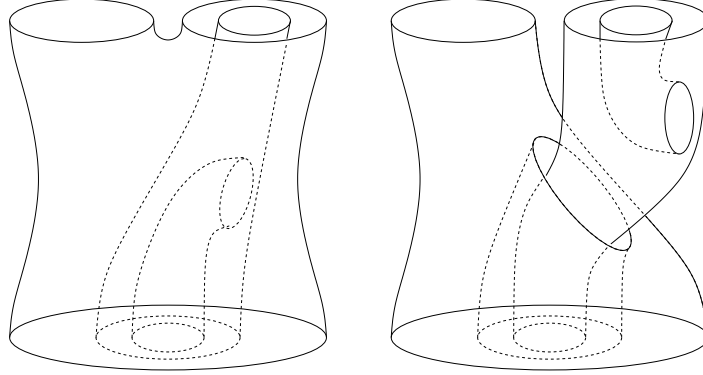

Figure 7: Representations of concrete diagrams in $S^3[F, F'](2)$ with $[F]_i = ()(())$ and $[F']_i = ((()))$ (see (7) for i -class notation).

an arrangement of non-intersecting closed loops in that plane which we call a *loop configuration*.

2.1 Categories of concrete diagrams

Let S_{\parallel}^d denote the set of concrete ∂ -diagrams in dimension d . That is

$$S_{\parallel}^d = S_0^{d+1}$$

Let $S_{\parallel}^d(n)$ be the subset of concrete ∂ -diagrams with n components.

Definition 2.4 Let $D \in S^d$. Then $\partial_{\pm}D$ is its upper (+) or lower (-) concrete boundary configuration (that is, a collection of non-intersecting topological $(d-2)$ -spheres embedded in \mathbb{R}^{d-1}).

We adopt the convention that $\partial_{\pm}D$ does *not* record the t -coordinate of its copy of \mathbb{R}^{d-1} as a hyperplane in \mathbb{R}^d . Thus for $D \in S^d$ we have $\partial_{\pm}D \in S_{\parallel}^{d-1}$.

Example: in $d = 3$, $P_1\partial_{+}D$ is a set of loops.

Definition 2.5 For $F_{\pm} \in S_{\parallel}^{d-1}$, let $S^d[F_{+}, F_{-}]$ be the subset of S^d such that $D \in S^d[F_{+}, F_{-}]$ implies $\partial_{\pm}D = F_{\pm}$. Let $S^d[F_{+}, F_{-}](n)$ be the subset of $S^d[F_{+}, F_{-}]$ with n components. Define $S_{\mathbb{R}}^d[F_{+}, F_{-}] = \mathbb{R}(S^d[F_{+}, F_{-}])$ similarly.

See Figure 7 for examples.

Let $A \in S_{t_1}^d$, $B \in S_{t_2}^d$ be such that $\partial_{-}A = \partial_{+}B$ (i.e. $A \in S^d[F_{+}, F]$, $B \in S^d[F, F_{-}]$ for some F_{+}, F, F_{-}). Write $A \circ B$ for the point set that coincides with B as a point set below and on the upper hyperplane t_2 of B , and with the translate of A above and on t_2 . (Examples are shown in Figure 8.)

Proposition 2.6 Set $A \circ B$ is itself the point set of a concrete diagram² in $S_{t_1+t_2}^d$.

²Remark: the composite embedded manifold will only be smooth if the factors are smooth, and not necessarily smooth if the factors are not transversal, but this need not concern us.

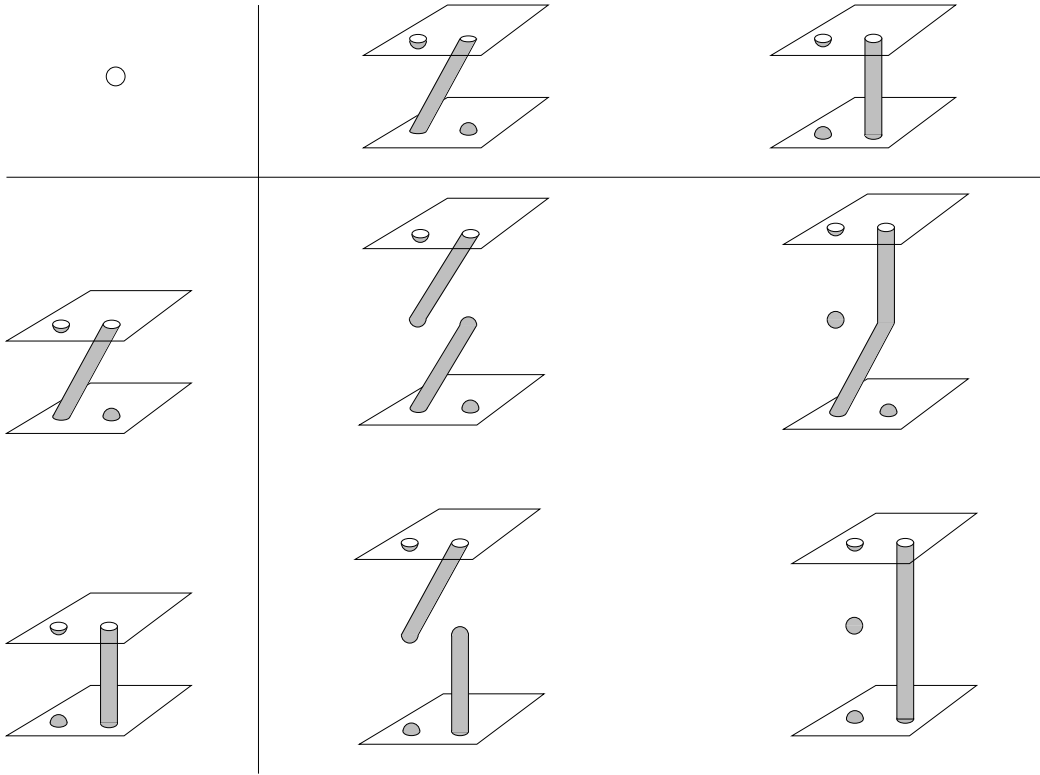

Figure 8: A representation of examples of composition of concrete diagrams in \mathbb{R}^3 .

We now identify $A \circ B$ with this diagram, and hence define

$$\begin{aligned} \circ : S^d[F_+, F] \times S^d[F, F_-] &\rightarrow S^d[F_+, F_-] \\ (A, B) &\mapsto A \circ B \end{aligned} \quad (6)$$

Consider the triple

$$\mathcal{C}^d = (S_{\parallel}^{d-1}, S^d[-, -], \circ)$$

consisting of ‘object’ set the set of concrete boundary configurations; and for each pair of objects $E, F \in S_{\parallel}^{d-1}$ the collection of ‘morphisms’ $\text{Hom}_{\mathcal{C}^d}(E, F) = S^d[E, F]$; and the composition defined above.

Proposition 2.7 *The triple \mathcal{C}^d is a category.*

Proof: Since the construction implied for $(A_1 \circ A_2) \circ A_3$ requires dissection of the same concrete diagram as $A_1 \circ (A_2 \circ A_3)$ it follows that \circ is associative. Each $\text{Hom}(F, F)$ has a unit (the concrete diagram of duration zero). \square

If \mathcal{K} is a ring and C a set (or category) write $\mathcal{K}C$ for the free \mathcal{K} -module with basis C (respectively the \mathcal{K} -linear category extending C , for which the hom-set $\text{hom}_C(F, G)$ is a basis for $\text{hom}_{\mathcal{K}C}(F, G)$).

By a mild abuse of notation we call a complete collection of hom-space bases for a \mathcal{K} -linear category C a basis for C . A basis is *categorical* if it forms a subcategory.

For $\delta \in \mathcal{K}$ we define a category

$$\mathcal{K}\mathcal{C}^d(\delta) = (S_{\mathbb{I}}^{d-1}, \mathcal{K}S_{\mathbb{R}}^d[-, -], \bullet)$$

by $A \bullet B = \delta^{b(A \circ B)} \mathbb{R}(A \circ B)$ on the basis (it is straightforward to check associativity as before). Note that $\mathcal{C}^d(1) = (S_{\mathbb{I}}^{d-1}, S_{\mathbb{R}}^d[-, -], \bullet)$ is a subcategory (with $\delta = 1$ making \bullet close on concrete diagrams in an obvious way).

2.2 Functors to partition categories

For T a set let $\mathbb{P}(T)$ denote the set of partitions of T . For $p \in \mathbb{P}(T)$ we may write $s \sim_p t$ if s, t in the same part in p (acknowledging the natural bijection between partitions and equivalence relations). We may also write $[s]_p$ for the part (or equivalence class) of p containing s . For $n \in \mathbb{N}$ define $\underline{n} = \{1, 2, \dots, n\}$.

The forced disjoint union of two sets is $A \dot{\cup} B = \{(a, 1), (b, 0) | a \in A, b \in B\}$, or for $i \in \mathbb{Z}$, $A \dot{\cup}_i B = \{(a, i+1), (b, i) | a \in A, b \in B\}$. Let ρ be any relation from any set T to \mathbb{R} . Then for each $i \in \mathbb{R}$ define a new relation $v_i(\rho)$ from T to \mathbb{R} by $(s, x) \mapsto (s, x+i)$. For example, $v_i(A \dot{\cup}_j B) = A \dot{\cup}_{i+j} B$.

For $F_{\pm} \in S_{\mathbb{I}}^{d-1}$ in particular then by $F_+ \dot{\cup} F_-$ we will intend the union of the sets $P_1(F_{\pm})$ of connected components.

For example the concrete diagram D in Figure 6 has

$$\partial_+ D \dot{\cup} \partial_- D = \{1+, 2+, 3+, 4+, 1-, 2-, 3-, 4-\}$$

in a notation in which $(1, 1/0) \mapsto 1\pm$ and so on.

Definition 2.8 Fix d . For each pair $F_+, F_- \in S_{\mathbb{I}}^{d-1}$ define

$$p : S^d[F_+, F_-] \rightarrow \mathbb{P}(F_+ \dot{\cup} F_-)$$

as follows. Let D be a concrete diagram. The connectivity $p(D)$ is the partition of $\partial_+ D \dot{\cup} \partial_- D$ each element of which is the set of all topological $(d-2)$ -spheres (loops in $d=3$) bounding a single component in D .

Examples: In $d=2$ every $p(D)$ is a partition of the set of boundary points into pairs. The case in equation (4) has $p(D) = \{\{1+, 2+\}, \{3+, 9-\}, \{4+, 5+\}, \dots\}$ (in the natural labelling scheme).

In $d=3$ the concrete diagram D in Figure 6, with boundary loops labelled as indicated, gives

$$p(D) = \{\{1+, 1-, 3+, 3-, 4-\}, \{2+, 2-\}, \{4+\}\}$$

Definition 2.9 (1) A congruence relation I on a category \mathcal{C} is an equivalence relation on each hom set such that $f' \in [f]_I$ and $g' \in [g]_I$ implies $f' \circ g' \in [f \circ g]_I$ whenever the latter exists.

(2) The quotient category \mathcal{C}/I has the same object class as \mathcal{C} but $\text{hom}_{\mathcal{C}/I}(F, G) = \text{hom}_{\mathcal{C}}(F, G)/I$ with the obvious composition well-defined by congruence.

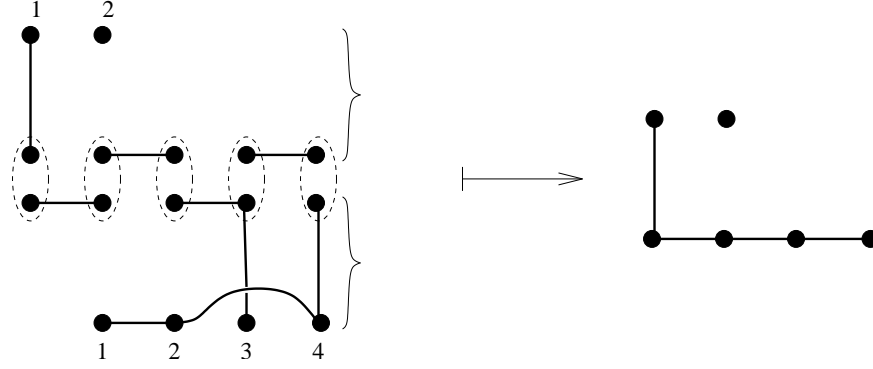

Figure 9: Example of composition in the partition category.

The partition-monoid base category

$$\mathcal{C}_{\mathbb{P}} = (S_{Fin}, \mathbb{P}(- \overset{\bullet}{\cup} -), *)$$

has object class the class S_{Fin} of all finite sets. The composition

$$\begin{aligned} * : \mathbb{P}(S \overset{\bullet}{\cup} T) \times \mathbb{P}(T \overset{\bullet}{\cup} U) &\rightarrow \mathbb{P}(S \overset{\bullet}{\cup} U) \\ (a, b) &\mapsto a * b \end{aligned}$$

has $a * b$ given as follows (see Figure 9 for an example). With $s, s' \in S \overset{\bullet}{\cup} U$ we have $s \sim_{a*b} s'$ if there is a sequence $s_0, s_1, s_2, \dots, s_k$ with $s_0 = s$ (case $s \in \emptyset \overset{\bullet}{\cup} U$) or $s_0 = v_1(s)$ (case $s \in S \overset{\bullet}{\cup} \emptyset$) and $s_k = s'$ or $s_k = v_1(s')$; such that either $s_{2i} \sim_b s_{2i+1}$ and $s_{2i+1} \sim_{v_1(a)} s_{2i+2}$, or $s_{2i} \sim_{v_1(a)} s_{2i+1}$ and $s_{2i+1} \sim_b s_{2i+2}$. (See [22, 24] for a gentler introduction).

Example 2.10 See Figure 9. The upper bracketed part in the figure represents an element a of $hom(\underline{2}, \underline{5}) = \mathbb{P}(\underline{2} \overset{\bullet}{\cup} \underline{5})$; and the lower part is b in $hom(\underline{5}, \underline{4})$. The composite is the partition in $hom(\underline{2}, \underline{4})$ of the upper and lower rows of the composite diagram (ignoring the middle groupings except in so far as the marked identifications engender connections). Note also that over/under information is irrelevant. Specifically we have $(3, 0) \sim_b (3, 1)$, $(3, 0) \sim_a (2, 0)$, $(1, 1) \sim_b (2, 1)$ and so on; so

$$(3, 0) \sim_b (3, 1) \sim_{v_1(a)} (2, 1) \sim_b (1, 1) \sim_{v_1(a)} (1, 2)$$

giving $(3, 0) \sim_{a*b} (1, 1)$, and so on.

We may regard $S_{\mathbb{P}}^{d-1}$ as a subset of S_{Fin} by regarding each object F as a set of components, rather than a point set. Whereupon we may define $\mathcal{C}_{\mathbb{P}}^d$ as the full subcategory of $\mathcal{C}_{\mathbb{P}}$ with object set $S_{\mathbb{P}}^{d-1}$, and

Proposition 2.11 *The inclusion of $S_{\mathbb{1}}^{d-1}$ as a subset of S_{Fin} together with the assignment of partition $p(D)$ to each concrete diagram D defines a functor*

$$\mathcal{F} : \mathcal{C}^d \rightarrow \mathcal{C}_{\mathbb{P}}$$

*Specifically, if A, B composable in the category \mathcal{C}^d then $p(A \circ B) = p(A) * p(B)$.*

Proof: Let $A \in S^d[E, F]$ and $B \in S^d[F, G]$. Then $A \circ B \in S^d[E, G]$ so both partitions are of $E \dot{\cup} G$. But there is a route (a path within a component) from boundary component l to l' in $A \circ B$ iff there is a chain $l = l_1, l_2, l_3, \dots, l_m = l'$ such that there exist routes from l_{2i-1} to l_{2i} in A and from l_{2i} to l_{2i+1} in B (or similarly with the roles of A, B reversed). Map p thus defines a congruence relation on \mathcal{C}^d leading to $\mathcal{C}_{\mathbb{P}}^d$ as quotient. \square

Extending map p \mathcal{K} -linearly, \mathcal{F} extends in an obvious way to a functor

$$\mathcal{F} : \mathcal{K}\mathcal{C}^d(\delta) \rightarrow \mathcal{K}\mathcal{C}_{\mathbb{P}(\delta)}$$

where $\mathcal{K}\mathcal{C}_{\mathbb{P}(\delta)}$ is the usual partition category [22] generalising $\mathcal{K}\mathcal{C}_{T(\delta)}$.

Definition 2.12 *A category is finite if every hom set is finite; or, if it is a K -linear category, if every hom set has a finite basis.*

Category $\mathcal{C}_{\mathbb{P}}$ is finite, so the image category $\mathcal{F}(\mathcal{C}^d)$ is finite. This is certainly an interesting object for study, both from the view of generalisations to Section 1.1, and mathematically. The image category $\mathcal{F}(\mathcal{C}^2)$ is a kind of Temperley–Lieb category (like the ordinary TL category \mathcal{C}_T except that the object set is $S_{\mathbb{1}}^1$ instead of \mathbb{N}). However this is not the only way of thinking of the TL category, so before studying $\mathcal{F}(\mathcal{C}^d)$ we consider the construction using *isotopy* of diagrams.

3 Isotopy and minimality of concrete diagrams

Definition 3.1 *A concrete diagram in S^d will be called minimal if all its components are $(d - 1)$ -spheres with non-empty boundaries. The set of all minimal concrete diagrams in $S^d[F, F']$ is written $S_{min}^d[F, F']$.*

Examples: The concrete diagrams in Figures 5,6,7 (but not 4) are minimal.

One way to characterise the diagram basis of the Temperley–Lieb algebra is as the set of equivalence classes of minimal concrete diagrams in $d = 2$ under *isotopy* [27]. In what follows we show that this construction does not generalise automatically to higher d , and provide a way to resolve this anomaly.

We begin by recalling and extending the definition [27, Ch.11] of isotopy.

3.1 Isotopy and strong isotopy

Definition 3.2 (i) By an isotopy on \mathbb{R}^d we shall mean a one-parameter family j_s , $s \in [0, 1]$, of homeomorphisms of \mathbb{R}^d such that $j_s(x)$ is continuous in s and x and j_0 is the identity homeomorphism.

(ii) If A and B are concrete diagrams we say that A is isotopic to B ($A \sim_i B$, $A \in [B]_i$) if there is an isotopy j_s of \mathbb{R}^d such that:

I1 $j_s(P_0(A))$ is the point set of a concrete diagram in \mathbb{R}^d for all s ;

I2 $j_1(P_0(A)) = P_0(B)$.

We may write just $j(A)$ for concrete diagram B here (and $A = j^{-1}(B)$). Thus each j defines a map $j : S^d \rightarrow S^d$.

We define isotopy of concrete ∂ -diagrams similarly.

(iii) For $A, B \in S^d[F, F']$, we say that A is strongly isotopic to B if $A \sim_i B$ by an isotopy j_s such that $j_s[P_0(A)]$ is the point set of a concrete diagram in $S^d[F, F']$ for all s . If A is strongly isotopic to B we write $A \sim_{\mathbf{si}} B$ or $A \in [B]_{\mathbf{si}}$.

Example 3.3 The following concrete diagrams are all isotopic in $d = 2$. The first two are strongly isotopic.

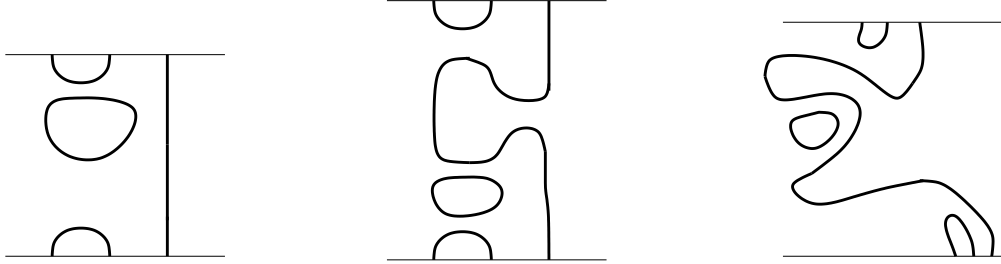

As noted above, these may all be regarded as representations of the same TL diagram.

The two factor diagrams used in Figure 8 are isotopic but not strongly isotopic.

Proposition 3.4 The relations \sim_i , $\sim_{\mathbf{si}}$ are equivalence relations. Bubble number $b(D)$ is an invariant of both. \square

A significant difference between \mathbf{i} and \mathbf{si} is the following.

Proposition 3.5 (i) For $D \in S^d[F, F']$ we have $[D]_{\mathbf{si}} \subset S^d[F, F']$. Let $D_1 \in S^d[F, F']$ and $D_2 \in S^d[F', F'']$, and let $D'_j \sim_{\mathbf{si}} D_j$ ($j = 1, 2$). Then $D'_1 \circ D'_2 \sim_{\mathbf{si}} D_1 \circ D_2$ and we have a well-defined composition on \mathbf{si} -classes. Thus the triple

$$\mathcal{C}_{\mathbf{si}}^d = (S_{\parallel}^d, S^d[-, -]/\mathbf{si}, \circ)$$

is a quotient category of \mathcal{C}^d .

(ii) If two concrete diagrams are strongly isotopic then their connectivities are equal.

Thus the functor \mathcal{F} factors through $\mathcal{C}_{\mathfrak{si}}^d$. That is

$$\begin{array}{ccc} \mathcal{C}^d & \xrightarrow{\mathcal{F}} & \mathcal{C}_{\mathbb{P}} \\ & \searrow I_{\mathfrak{si}} & \nearrow \mathcal{F}_{\mathfrak{si}} \\ & \mathcal{C}_{\mathfrak{si}}^d & \end{array}$$

commutes (with $I_{\mathfrak{si}}$ denoting the \mathfrak{si} -congruence). \square

Equal connectivity does not imply isotopy. For example, see Figure 14. Thus $\mathcal{C}_{\mathfrak{si}}^d$ is not a finite category.

3.2 Hyperplane isotopy

Note that I1 of Definition 3.2 implies that points in a boundary remain cohyperplanar through the continuous transition realising an isotopy. The upper hyperplane may move bodily to a different time as we transform between isotopic concrete diagrams, but it can be followed through the transformation. (Although the limit in which the upper and lower hyperplane coincide is allowed, where this makes sense.) In this sense an isotopy on \mathbb{R}^d restricts to a transformation on a boundary hyperplane, which transforms between isotopic boundary configurations.

We want to address the question of how to define a smaller category from \mathcal{C}^d by replacing concrete diagrams with their \mathfrak{i} -classes, as works for $d = 2$. Two possible ways to go are: (1) try to find candidates for hom classes in $S^d / \sim_{\mathfrak{i}}$ (note that this automatically implies a reduced object set); (2) try to use the $S^d[F, F'] / \sim_{\mathfrak{i}}$ as hom classes.

We shall see that neither of these works directly unless $d = 2$. Shortly we shall study the quotient sets $S^d / \sim_{\mathfrak{i}}$ and $S^d[F, F'] / \sim_{\mathfrak{i}}$. We will need some preparations to deal with the differences between $d = 2$ and $d > 2$.

Proposition 3.6 (1) The set $S_{\mathfrak{i}}^1 / \sim_{\mathfrak{i}}$ may be indexed by the natural numbers.³
 (2) For $d > 2$ the set $S_{\mathfrak{i}}^{d-1} / \sim_{\mathfrak{i}}$ may be indexed by the set of rooted trees (as in Definition 8.5 or, e.g., in [15, 36]). An isotopy class $[F]_{\mathfrak{i}}$ of elements of $S_{\mathfrak{i}}^{d-1}$ can be indicated, non-uniquely, by a bracket notation like

$$[F]_{\mathfrak{i}} \mapsto ()(()). \quad (7)$$

Proof: (1) The set $S_{\mathfrak{i}}^1$ is the set of boundary configurations of S^2 , i.e. points on the line. The intrinsic left-to-right order on a boundary point configuration is preserved by isotopy, even though the precise location of points is not in general. As such there is precisely one isotopy class of point configurations for each number of points.
 4

³(NB, this statement can be brought into line with the sequel by a strict interpretation of the 0-sphere, but this need not concern us here — see [1].)

⁴It is the boundary class in $d = 2$ which is fixed in constructing the diagrams for a specific Temperley–Lieb algebra (see later). Hence there is one Temperley–Lieb algebra for each number of points.

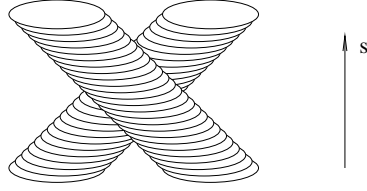

Figure 10: Depiction of a nontrivially permuting self-isotopy j_s in $d = 2$.

(2) For $d > 2$ every sphere partitions \mathbb{R}^d into its interior, its exterior, and the intersection of their closures. *Geometrical duality* [31] places this partition into correspondence with a graph consisting of a point for each open component and an edge between them for the separating sphere. \square

Recall that P_1D is a partition of P_0D into components. However, in writing examples we will usually use number labels for the components, chosen for local convenience (as in (5)).

In as much as an isotopy j_s is continuous we may consider following a particular component through the transformation. (That is, while the point set of a component will change in general under a homeomorphism, we can consider the component's number label to travel with its homeomorphic image.) In this sense the isotopy may be considered to move the component around. Consider an isotopy taking a concrete diagram to *itself* (via some homeomorphisms). In the above sense such an isotopy permutes the components. In particular the homeomorphic image of a component may not be the same component (although in $d = 1$ this permutation is necessarily trivial, by the nonintersection condition).

Consider a concrete ∂ -diagram $F \in S_1^2$ consisting of two loops arranged as $()()$. The example in Figure 10 illustrates (discretely) a continuum of homeomorphisms j_s realising a *self-isotopy* of this concrete ∂ -diagram. This isotopy realises a nontrivial permutation.

Proposition 3.7 *If F is a concrete ∂ -diagram, and j_s an isotopy, in dimension $d - 1$ then (using f_t from (3))*

$$D_F^{j_s} := \cup_{t \in [0,1]} f_t(j_t(P_0(F))) \quad (8)$$

is (the point set of) a concrete diagram in $S^d[F, F']$, with $F' = j_1(F)$.

To see this consider Figure 10 as a single diagram in $d = 3$. \square

Definition 3.8 *Write π_F for the set of concrete diagrams in $S^d[F, F]$ arising as in equation (8). In particular $I_F \in \pi_F$ is given by $I_F = D_F^j$ (as in equation (8)) in case j_u is the identity homeomorphism for all u .*

Proposition 3.9 *In $\mathcal{C}_{\mathbb{P}}$ there is an isomorphism in $\text{hom}(F, F')$ iff $|F| = |F'|$. That is, $\mathcal{C}_{\mathbb{P}}$ has a skeleton with object set \mathbb{N} .*

In $\mathcal{F}(\mathcal{C}^d)$ there is an isomorphism in $\text{hom}(F, F')$ iff $F \sim_i F'$. That is, $\mathcal{F}(\mathcal{C}^d)$ has a skeleton with object set \mathbb{N} (case $d = 2$); or the set of rooted trees ($d > 2$).

Proof: The results on $\mathcal{C}_{\mathbb{P}}$ are elementary. For $\mathcal{F}(\mathcal{C}^d)$ note that the construction $D_F^{j_s}$ is an isomorphism. Then apply Proposition 3.6. \square

3.3 Representatives of isotopy classes

Definition 3.10 Let $S_{\mathfrak{g}}^d \subset S_{\mathbb{I}}^{d-1}$ be any complete set of representatives of classes in $S_{\mathbb{I}}^{d-1} / \sim_{\mathfrak{i}}$ (one per orbit).

Although there is much choice in the preparation of $S_{\mathfrak{g}}^d$, some restriction is convenient.

Proposition 3.11 Within each orbit of $S_{\mathbb{I}}^{d-1} / \sim_{\mathfrak{i}}$ there are representatives in which each component is a perfect $d - 2$ -sphere; and the centres of all these spheres are colinear (let us say, along the x -axis); and the intersections of the components with this line are spaced along the line at unit intervals, with the first intersection at $x = 0$. We may arrange the spheres so that the smallest appear first (reading left to right) and then that those of equal size are ordered by heaviness (as in Definition A.3 in Appendix A.1). \square

(Note that for $d > 2$ the bracket notation of equation (7) may be used here to indicate specific representatives.)

We will consider to be fixed for each $F \in S_{\mathfrak{g}}^d$ an enumeration of its components, to simplify labelling later on. (It does not matter which enumeration is fixed. If we use the x -axial representatives above we can number in order of first intersection of each component with the axis. Thus, for example, $(\cdot)_1(\cdot)_2(((\cdot)_5)_4)_3$.)

Definition 3.12 Given $S_{\mathfrak{g}}^d$, then S_D^d is any set of representatives of classes of concrete diagrams under isotopy (one per orbit), such that $D \in S_D^d$ implies $\partial_{\pm} D \in S_{\mathfrak{g}}^d$. For $F_{\pm} \in S_{\mathfrak{g}}^d$, $S_D^d[F_+, F_-]$ is the subset of S_D^d such that $D \in S_D^d[F_+, F_-]$ implies $\partial_{\pm} D = F_{\pm}$.

Proposition 3.13 Every $D \in S_D^d$ is in some $S_D^d[F_+, F_-]$, thus

$$S_D^d = \cup_{F_{\pm} \in S_{\mathfrak{g}}^d} S_D^d[F_+, F_-]$$

is a partition of S_D^d . \square

3.4 Handles and minimality

A *handle* in $D \in S^3$ is a subset of $P_0(D)$ that forms a closed path in a component, but can be removed without separating the component into two. (Thus no minimal concrete diagram has a handle.) See Figure 11 for an example. The genus $g(D)$ of D is the maximum number of handles that can be removed simultaneously without separating any component.

Proposition 3.14 Minimality, b and g are all \mathfrak{i} -invariants. \square

The \mathfrak{si} -classes in S^d of elements in $S_{min}^d[F, F']$ lie in $S_{min}^d[F, F']$.

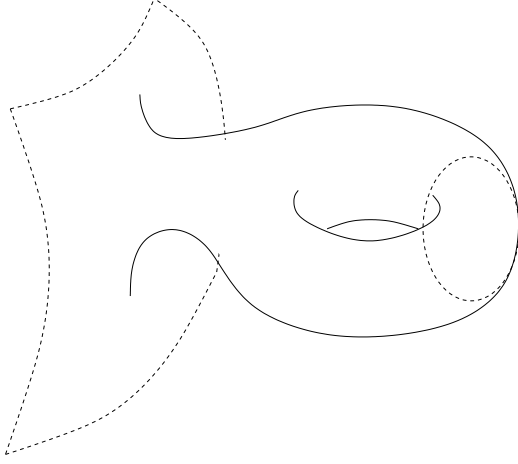

Figure 11: A representation of part of a concrete diagram. The closed path indicated by the dashed loop on the right is a handle.

3.5 Class compositions: examples and counter examples

First we look at $d = 2$ and make contact with the TL category. Then we will look at the new features when $d > 2$.

Noting Proposition 3.6(1), for $m, n \in \mathbb{N}$ let us define

$$S^2[m, n] = \bigcup_{F \in S_{\dagger}^1(m); F' \in S_{\dagger}^1(n)} S^2[F, F'] \quad (9)$$

This argument-dependent notation allows us next to introduce certain triples, $(\mathbb{N}, S^2[-, -]/\mathbf{i}, \circ)$ and $\mathcal{C}_{\dagger}^2 = (S_{\dagger}^1, S^2[-, -]/\mathbf{i}, \circ)$ (that we shall show to be categories); noting from the object sets that the hom sets differ, with the former to be understood as defined by (9).

Proposition 3.15 (i) *Subset $S^2[m, n]$ is a union of \mathbf{i} -classes in S^2 .*

Let $D_1 \in S^2[F, F']$ and $D_2 \in S^2[F', F'']$.

(ii) *If $D'_j \sim_{\mathbf{i}} D_j$ ($j = 1, 2$) in S^2 then D'_1 and D'_2 are not necessarily composable in \mathcal{C}_{\dagger}^2 ; but if they are then $D_1 \circ D_2 \sim_{\mathbf{i}} D'_1 \circ D'_2$. Thus we may define a composition \circ using any such composable representatives which makes $(\mathbb{N}, S^2[-, -]/\mathbf{i}, \circ)$ a category.*

(iii) *If D'_1, D_1 are concrete diagrams in the same \mathbf{i} -class in $S^2[F, F']/\mathbf{i}$, and D'_2, D_2 are concrete diagrams in the same \mathbf{i} -class in $S^2[F', F'']/\mathbf{i}$, then $D_1 \circ D_2 \sim_{\mathbf{i}} D'_1 \circ D'_2$. Thus we may define a composition \circ which makes*

$$\mathcal{C}_{\dagger}^2 = (S_{\dagger}^1, S^2[-, -]/\mathbf{i}, \circ)$$

a category.

(iv) *On ignoring both the position and number of closed loops (so that $D \equiv D'$ if $R(D) = R(D')$) the category in (ii) becomes the TL monoid category $\mathcal{C}_{T(1)}$. The category in (iii) contains an equivalent of this category as a skeleton.*

Proof: (i) Considering the isotopy class in S^2 of an element $D \in S^2[F, F']$ we see that the class extends beyond $S^2[F, F']$ and contains elements in each $S^2[E, E']$ with

$E \sim_i F$ and $E' \sim_i F'$. By Proposition 3.6(1) the appropriate sets are included in $S^2[m, n]$.

(ii) Isotopy in S^2 thus induces an equivalence on boundary configurations so that, cf. \mathcal{C}^2 , the object set of any resultant category is the set of equivalence classes. Again by Proposition 3.6(1), the new object set is \mathbb{N} .

In the plane, the isotopy class of $D \circ D'$ depends only on the isotopy classes of D and D' (so long as D, D' chosen composable).

(iii) The same argument establishes a congruence relation in this case.

(iv) is straightforward. The skeleton uses one object from each $S_1^1(m)$, $m \in \mathbb{N}$. \square

However, now we look at $d = 3$:

Let $D_1, D'_1, D_2, D'_2 \in S_{min}^3[F, F]$. It is easy to see that $D_j \sim_i D'_j$ ($j = 1, 2$) does not imply $D_1 \circ D_2 \sim_i D'_1 \circ D'_2$ in general.

Example 3.16 Suppose F is a concrete boundary configuration of form $(\)(\)$. Let us label the two loops in the $t = 0$ plane as $1-, 2-$, and their translates in the upper plane as $1+, 2+$. Now consider any minimal concrete diagrams $A, B \in S^d[F, F]$ whose components connect these loops as: $p(A) = \{\{1-, 1+\}, \{2-\}, \{2+\}\}$ and $p(B) = \{\{1-, 2+\}, \{2-\}, \{1+\}\}$. Here $A \sim_i B$. Note, however, that $A \circ A \not\sim_i B \circ B$. This example is illustrated on the diagonal in Figure 8.

The above example shows us that, in $d = 3$, composition \circ does not pass to a well defined composition on isotopy classes of concrete diagrams. Thus isotopy classes of concrete diagrams *per se* cannot have quite the same standing in any algebra formulated in $d = 3$ as they do in $d = 2$.

This can be seen from a diagram category point of view. The object set which $d > 2$ diagrams can ‘factor through’ (in the sense of [14]) cannot depend on an arbitrary numbering of components (in $d = 2$ it is not arbitrary – distinct points on a line can be naturally ordered).

Our next objective is to make a generalisation of TL composition which *does* work. We will need a suitable ‘plumbing kit’, which we now construct.

3.6 Pre-isomorphisms: symmetries of boundary configurations

Consider $F \in S_{\partial}^d$. Let j_s be any hyperplane isotopy which fixes P_0F but permutes (possibly trivially) P_1F (such as that illustrated in Figure 10). Let Σ_F be the complete set of permutations of P_1F which can arise in this way.

Example 3.17 Set $d = 3$: Consider $F = \partial_+D$ with D as in (5) above, that is $P_1F = (\)_2(\)_1(\)_3(\)_4$. Then $\Sigma_F = \{(\), (34)\}$, where $(\)$ denotes the trivial perm. In particular the trivial isotopy on F achieves the trivial perm.

Proposition 3.18 *The set Σ_F forms a subgroup of the symmetric group $\Sigma_{|P_1F|}$ under composition of permutations.*

Proof: It is enough to show closure. This can be seen by noting that self-isotopies can be composed (rescaling s). \square

Suppose that j_s achieves the permutation $\sigma \in \Sigma_F$. Then recall that we may associate a concrete diagram $D_F^{j_s} \in S^d$ to it (from equation (8)).

Proposition 3.19 *For given F all concrete diagrams of form D_F^j are isotopic (i.e. irrespective of j or the permutation σ achieved). All D_F^j are minimal.*

Proof: by construction. \square

We write D_σ for a D_F^j whose j achieves the permutation $\sigma \in \Sigma_F$ when the choice of j is irrelevant.

Example 3.20 Set $d = 3$: Suppose F is a concrete loop configuration of form $(\)(\)$, that D_e is a concrete diagram realising the trivial perm (derived from the trivial isotopy on \mathbb{R}^2 , say) and that D_σ realises the other perm (derived from some other isotopy on \mathbb{R}^2 , call it k). Then $D_e \sim_i D_\sigma$. Note that both are of duration 1 (i.e. $t = 1$) by construction. An example of an isotopy j_s realising the equivalence is one which, at each time slice t , evolves linearly with s between the trivial isotopy on \mathbb{R}^2 and the homeomorphism k_t from the family in k .

Definition 3.21 *Let $\Pi_F \subseteq S_{min}^d[F, F]$ be the subset such that $D \in \Pi_F$ implies $p(D)$ an isomorphism in $\mathcal{C}_{\mathbb{P}}$ (cf. Proposition 3.9), i.e. a permutation of $P_1 F$. Thus $\pi_F \subset \Pi_F$.*

A complete subset of Π_F is one in which every $\sigma \in \Sigma_F$ is realised exactly once.

Definition 3.22 *Let Ξ be a complete subset of Π_F . Define*

$$\eta(\Xi) := \frac{1}{|\Sigma_F|} \sum_{X \in \Xi} X, \quad (10)$$

Lemma 3.23 *Let A and A' in Π_F realise permutations σ and σ' respectively. Then $A \circ A'$ realises $\sigma'\sigma$.*

Proof: Follows directly from definition 3.21. \square

4 Diagrams: classes of concrete diagrams

In this section we define an equivalence relation on $S_{min}^3[F, F']$ (called *heterotopy*), whose equivalence classes will become the basis of a finite category generalising \mathcal{C}_T . Note that, with $d > 2$, isotopy classes are no longer big enough:

Proposition 4.1 [1] *For $F \neq \emptyset$, $S_{min}^3[F, F]/\sim_i$ is a countably infinite set.*

Example 4.2 There is an epimorphism from $S_{min}^3[(\), (\)]/\sim_i$ onto the set of knots.

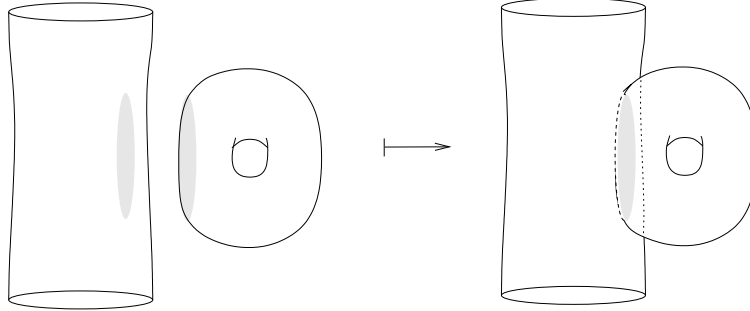

Figure 12: Example of $\overline{\nabla}$ product (on the left the diagrams are drawn slightly separated, so that the intersection is visible as a shaded disk in each).

For $d = 2$ the category $\mathcal{C}_{\text{si}}^d$ essentially coincides with \mathcal{C}_1^2 . Both are infinite categories, but only because homs can contain bubbles, as in Figure 4. For $d > 2$, $\mathcal{C}_{\text{si}}^d$ is an infinite category, both by ‘knotting’ and by the formation of handles and bubbles. Our next objective is to give ways to eliminate these infinities which will both connect with and generalise $\mathcal{F}(\mathcal{C}^d)$. We observe that the case for eliminating each bubble in favour of a scalar, as in Temperley–Lieb (see Section 1.1), is compelling. In Section 4.2 we propose an analogous treatment for ‘handles’ in $d = 3$, which will also take care of knotting. Before that, we must prepare some machinery.

4.1 Non-infinitesimal concrete diagram transformations

As already noted, each concrete diagram $D \in S_t^d$ separates E_t^d into connected components, with the point set $P_0(D)$ of the diagram itself as the boundary. Let us call the connected components of $E_t^d \setminus P_0(D)$ the *alcoves* of D .

Under suitable conditions the symmetric difference of two concrete diagrams $D, D' \in S_t^d$ is again a concrete diagram in S_t^d . This is false if $P_0(D)$ intersects more than one alcove of D' ; and trivially true if the point sets of D and D' do not intersect. It can also be true if the point sets intersect in a disk or disks. There are some potential subtleties to this, but for our purposes the following picture will be adequate.

For T, T' sets, define the *symmetric difference*

$$T \nabla T' := T \cup T' \setminus T \cap T'$$

Definition 4.3 For $D, D' \in S_t^d$ we say they are ∇ -composable (respectively ∇^i -composable) if $D \cap D'$ is a finite (or empty) union of disjoint disks (respectively i disjoint disks). Noting that $D \nabla D'$ may be open due to the removal of these disks we write $D \overline{\nabla} D'$ for the corresponding closure.

See Figure 12 for an example with $i = 1$, and Figure 13 for $i = 2$.

Lemma 4.4 If D, D' are ∇ -composable then $D \overline{\nabla} D' \in S_t^d$.

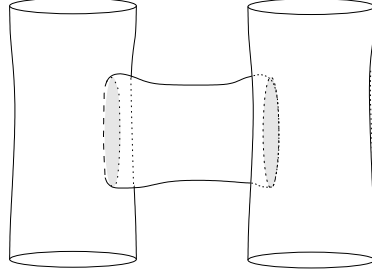

Figure 13: Example of $\overline{\nabla}$ product with $i = 2$, combining a diagram with two cylindrical components with a diagram with one spherical component.

Proof: Since the intersection is made of disks the interior of D' is either entirely in the interior, or the exterior, of D . If it is in the exterior, then $D\overline{\nabla}D'$ separates E_t^d into an interior part which is the union of the interiors and the open disks. If it is in the interior then the exterior of $D\overline{\nabla}D'$ is the union of the exterior of D , the interior of D' , and the open disks. \square

Definition 4.5 For $B \in S_t^d$ define $\text{dom } {}^i B = \{A \in S_t^d \mid A, B \text{ } \nabla^i\text{-composable}\}$ (the superscript i may be omitted as above). Define

$$\begin{aligned} \delta_B^i : \text{dom } {}^i B &\rightarrow S_t^d \\ A &\mapsto A\overline{\nabla}B \end{aligned}$$

(again the superscript may be omitted).

Example 4.6 If T is a 2-torus, and intersects $D \in \text{dom } T \subset S_t^3$ in a single disk, then $\delta_T = \delta_T^1$ has the effect of adding a handle to D . (See Figure 12.)

If s is a 2-sphere, then δ_s^2 has the effect of connecting ('bridging') two components if the two disks ($\overline{D}_1, \overline{D}_2$ say) are in distinct components (see Figure 13); or of introducing a handle if they are not.

Lemma 4.7 (i) If c, d are adjacent components (bounding the same alcove) in concrete diagram A then there is a sphere s such that $\delta_s^2 A$ is a concrete diagram differing from A only in having a single component 'composite' of c and d .

(ii) If s' is a second sphere similarly connecting c and d in A , and not intersecting s , then $\delta_{s'}^2 \delta_s^2 A$ has a handle, and there is a torus T such that

$$\delta_{s'}^2 \delta_s^2 A \sim_{\text{si}} \delta_T^1 \delta_s^2 A$$

\square

Define a relation \mathfrak{r}_1 on S^3 by $A\mathfrak{r}_1 B$ if there is a torus T such that $B = \delta_T^1 A$; and \mathfrak{r} as the transitive closure of \mathfrak{r}_1 .

If $B = \delta_T^1 A$ then $B \cap T$ is a punctured torus (not a disk) so that $B \notin \text{dom } T$ in our definition. But $B \overline{\nabla} T = A$ so we can extend to allow the point-set operation (δ_T^{-1} by a mild abuse of notation) such that $A = \delta_T^{-1} B$.

We have

$$g(\delta_T^1 A) = g(A) + 1 \quad g(\delta_T^{-1} B) = g(B) - 1$$

Proposition 4.8 *If j is an isotopy and $A \in \text{dom } B$ then $j(\delta_B A) = \delta_{j(B)} j(A)$. Similarly $j \delta_T^{-1} B = \delta_{j(T)}^{-1} j(B)$. \square*

4.2 Heterotopy and strong heterotopy

Remark 4.9 There is no equivalent move to δ_T^1 for Temperley–Lieb diagrams, but a generalisation of the move which replaces a closed loop in a Temperley–Lieb diagram with a scalar factor would be to replace both bubbles (as in (2)) and handles similarly. Our next equivalence relation on S^3 will therefore be ‘handle replacement’ — meaning that if $B = \delta_T^1 A$ in S^3 (or \mathcal{KS}^3) then $B \equiv \kappa A$ in a quotient of \mathcal{KS}^3 .

First we construct a move which adds and removes equal numbers of handles (thus generating an equivalence bypassing the issue of scalars for now).

Definition 4.10 *A heterotopy (respectively strong heterotopy) is a transformation on a concrete diagram realised as a specific sequence of $\delta_T^{\pm 1}$ -transformations and isotopies (respectively strong isotopies). That is (noting Proposition 4.8), a heterotopy is a transformation*

$$A \mapsto B = i \prod_{k=n}^1 \delta_{T_k}^{\epsilon_k} A \quad (11)$$

for some n , where i is an (strong) isotopy, $t = (T_1, T_2, \dots, T_n)$ is a suitable set of tori, $\epsilon_k \in \{\pm 1\}$ and the order in the product matters.

If such a transformation exists between $A, B \in S_{min}^3$ we write $A \sim_{\mathfrak{h}} B$ (respectively $A \sim_{\mathfrak{sh}} B$). This relation is an equivalence by construction. For $A \in S_{min}^3[F, F']$ we write $[A]_{\mathfrak{h}}$ (respectively $[A]_{\mathfrak{sh}}$) for the equivalence class of A in $S_{min}^3[F, F']$, and call this class simply a diagram.

The set of heterotopy (respectively strong heterotopy) classes in $S_{min}^3[F, F']$ will be denoted $S_{\mathfrak{h}}^3[F, F']$ (respectively $S_{\mathfrak{sh}}^3[F, F']$).

If such a transformation exists between $A, B \in S^3$ and $\sum_k \epsilon_k = 0$ we write $A \approx_{\mathfrak{h}} B$ (respectively $A \approx_{\mathfrak{sh}} B$). (So $A \sim_{\mathfrak{h}} B$ implies $A \approx_{\mathfrak{sh}} B$.)

Thus comparing (11) with Proposition 4.8 and the definition of \mathfrak{r}_1 :

Proposition 4.11 *The equivalence relation in S_{min}^3 of heterotopy (respectively strong heterotopy) is the restriction of the RST closure of the relations \mathfrak{r}_1 and \mathfrak{i} (respectively \mathfrak{si}) on S^3 to S_{min}^3 . A heterotopy realising $A \sim_{\mathfrak{h}} B$ has $\sum_k \epsilon_k = 0$. \square*

Examples: See Figure 15.

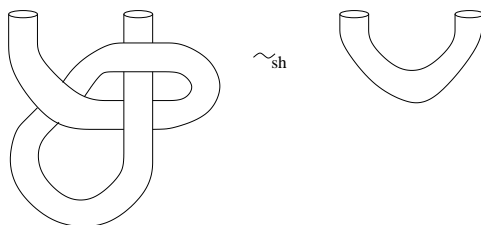

Figure 14: NB, these concrete diagrams are not strongly isotopic, or even isotopic.

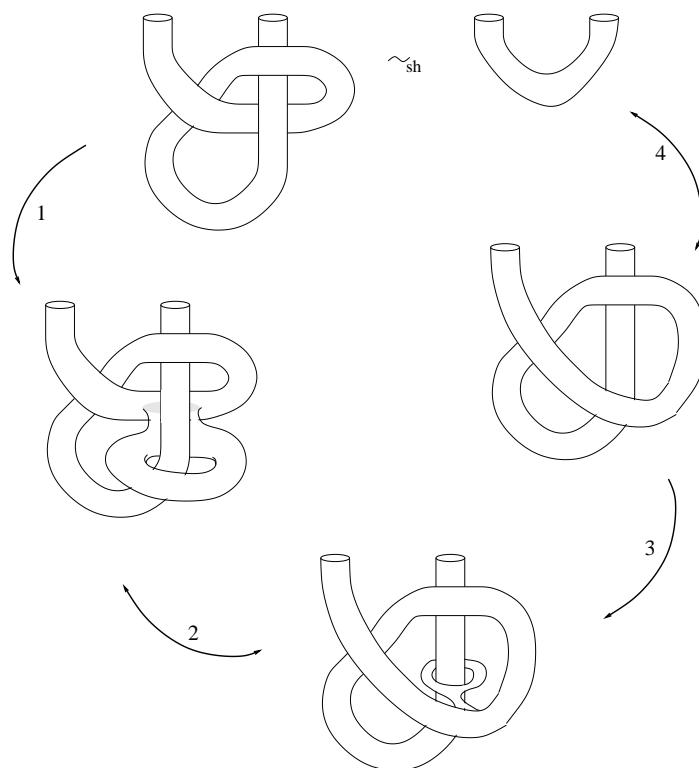

Figure 15: The relation $A \sim_{sh} B$ in Figure 14 is illustrated by the steps:

1. $A \mapsto \delta_T^1 A$;
2. $\delta_T^1 A \mapsto i(\delta_T^1 A) = \delta_T^1 i'(B)$;
3. $i'(B) \mapsto \delta_T^1 i'(B) = i(\delta_T^1 A)$;
4. $B \mapsto i'(B)$.

Lemma 4.12 (i) *If sphere s and torus T do not intersect and $A \in \text{dom}^2 s \cap \text{dom}^1 T$ then $\delta_T^1 A \in \text{dom}^2 s$ and*

$$\delta_s^2 \delta_T^1 A = \delta_T^1 \delta_s^2 A$$

(ii) *Considering (11) with $A \in S_{min}^3$, it is always possible to find a sphere s which bridges any two adjacent components of A but which intersects no torus in t . Thus both A, B in (11) lie in $\text{dom}^2 s$. Further, if i is strong then there is a neighbourhood of both boundary (hyper)planes where it acts trivially, and hence δ_s^2 can be chosen to commute with i also.*

Proof: (i) is trivial. (ii): None of the tori in t touch the boundary (hyper)planes, so there is a neighbourhood of either where s can pass. Since A is minimal every component has a boundary component, and we can bridge close to these (i.e. close to the boundary (hyper)plane). If the bridged components have boundary components on the same boundary we are done; else by compactness we can chose the inter-boundary part of s to be far away from any torus. \square

Remark 4.13 Suppose tori T, T' are isotopic and agree exactly except on a disk $d = A \cap T$. Then $\delta_{T'}^{-1} \delta_T^1 A$ is isotopic to A , differing by the localised isotopy which replaces d with d' from T' . Any isotopy i can be realised by a sequence of such ‘local patch’ moves, but it will be convenient and natural for us to keep isotopy as a move itself.

5 Combinatorial characterisation of diagrams

For Temperley–Lieb diagrams, which are isotopy classes of concrete diagrams in $d = 2$, we know that they can be placed in correspondence with a subset of the set of pair partitions of their endpoints — a finite set. In $d = 3$ we now have an analogous result.

Theorem 5.1 *Let $A, B \in S_{min}^3[F, F']$. Then $A \sim_{\text{sh}} B$ if and only if $p(A) = p(B)$.*

Proof: (Only if:) Strong heterotopy is generated by ‘moves’ none of which changes connectivity, hence if $A \sim_{\text{sh}} B$ then $p(A) = p(B)$.

(If:) We use a descending induction on the number of components of A , with the maximum possible number $|A| = |F| + |F'|$ as base. In this case it is clear that $A \sim_{\text{si}} B$.

Let $P(k)$ be the proposition that if $A, B \in S_{min}^3[F, F'](k)$ (k components), and $p(A) = p(B)$ then $A \sim_{\text{sh}} B$. For the inductive step we require to show that $P(k)$ holds if $P(k + 1)$ does.

The strategy is to construct $A', B' \in S_{min}^3[F, F'](k + 1)$ from A, B (resp.) such that $p(A') = p(B')$, so that there is a heterotopy (I , say) between A' and B' , by the inductive assumption. Then from I to construct a heterotopy between A and B .

Step 1. Construction of A', B'

In A select a non-capped loop (labelled l , say) in F that surrounds no other non-capped loop (note that this is possible in all but the base case). Note that there is

a (kind of singular limit of an isotopy) map which takes the collar to the connected component at l and pinches it, so yielding a cap at l and a nearby patch of a now separate, but *adjacent* component (with no other components affected). We have:

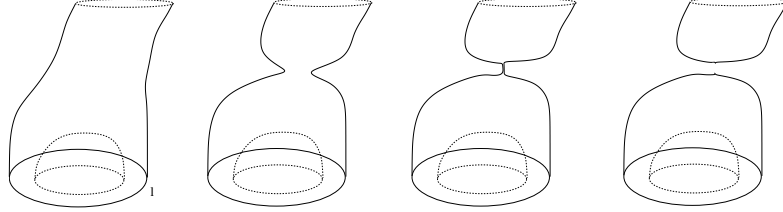

The construct A' may be taken to be any such construct from A . Note that $A' \in S_0^3[F, F'](k+1)$.

Note that in B the loop l is again non-capped, and again surrounds no other non-capped loop. Accordingly construct B' in the same way. Since $p(A) = p(B)$ and on each side all we have done is to move the loop l into a singleton part we have $p(A') = p(B')$ as required.

Let us use the label c_l for the component of B (or A) containing the loop l ; write c'_l for the component of B' (or A') containing the loop l ; and c''_l for the component of B' (or A') containing the other loops connected to l in c_l .

Note that there is a sphere s_A such that we may reconstruct A from A' via

$$A = i_A \delta_{s_A}^2 A' \quad (12)$$

(i_A some isotopy), and similarly a sphere s_B such that

$$B = i'_B \delta_{s_B}^2 B' \quad (13)$$

That is, s_B meets B' in a disk in component c'_l and a disk in component c''_l .

Step 2. Construction of heterotopy between A and B

Since $p(A') = p(B')$, by P($k+1$) we have $A' \sim_{\text{sh}} B'$ (the inductive hypothesis). Let

$$B' = i \prod_{k=n}^1 \delta_{T_k}^{\epsilon_k} A' \quad (14)$$

realize this strong heterotopy, as in (11). (Note that i is a *strong* isotopy here.)

From (13) and (14) we have

$$B = i'_B \delta_{s_B}^2 B' = i'_B \delta_{s_B}^2 i \prod_{k=n}^1 \delta_{T_k}^{\epsilon_k} A'$$

The idea now is somehow to pass the $\delta_{s_B}^2$ through to the right, and to end up with a heterotopy on A . To do this we need a couple of Lemmas.

Lemma 5.2 *Suppose that a sphere s meets a concrete diagram X in a disk in some component c and a disk in some component d . Then for any other sphere s' with the same bridging property $\delta_s^2 X \sim_{\text{sh}} \delta_{s'}^2 X$.*

Proof: We may assume that s does not intersect all paths from c to d in the connected component of $E_t^3 \setminus X$ containing its interior. Thus any such sphere s' can be isotopically deformed so as not to intersect s , whereupon there are tori T, U such that $\delta_T^1 \delta_s^2 X \sim_{\text{si}} \delta_{s'}^2 \delta_s^2 X \sim_{\text{si}} \delta_U^1 \delta_{s'}^2 X$ (T meets $\delta_s^2 X$ in a disk consisting in a patch in c in X ; a strip in s ; and a patch in d in X , and U is constructed similarly). \square

Lemma 5.3 *Let $B = i \prod_{k=n}^1 \delta_{T_k}^{\epsilon_k} A$ as in Definition 4.10, and c, d adjacent components in A (and use the same labels for the corresponding components of B). Then there exists a sphere s connecting c to d such that*

$$\delta_s^2 \prod_{k=n}^1 \delta_{T_k}^{\epsilon_k} A \sim_{\text{si}} \prod_{k=n}^1 \delta_{T_k}^{\epsilon_k} \delta_s^2 A$$

Proof: Noting Lemma 4.12(i), it is enough to show that there is such a sphere which does not intersect any of the tori, but this was established in Lemma 4.12(ii). \square

The sphere s_B in (13) is not necessarily an entirely free choice, but by Lemma 5.2, replacing (13) with $B \sim_{\text{sh}} i' \delta_s^2 B'$ we can choose s as in Lemma 5.3. In particular we can choose s close to a boundary hyperplane, so that it commutes with strong isotopy i also. We have

$$B \sim_{\text{sh}} i' \delta_s^2 i \prod_{k=n}^1 \delta_{T_k}^{\epsilon_k} A' \sim_{\text{si}} i' i \prod_{k=n}^1 \delta_{T_k}^{\epsilon_k} \delta_s^2 A'$$

That is $B \sim_{\text{sh}} \delta_s^2 A'$. But using Lemma 5.2 again $\delta_s^2 A' \sim_{\text{sh}} \delta_{s_A} A' \sim_{\text{si}} A$. We have established that $P(k+1)$ implies $P(k)$ as required. \square

6 The strong heterotopy diagram category

Proposition 6.1 *Fix F, F' . For each $A \in S^3[F, F']$ the set $\{D \in S_{\min}^3 \mid D \mathbf{tr} R(A)\}$ is non-empty and lies within a single strong heterotopy class (and hence also heterotopy class in $S_{\min}^3[F, F']$). Call this class $\mathbb{D}_{\text{sh}}(A)$ (respectively $\mathbb{D}(A)$), then we have a surjective map*

$$\mathbb{D}_{\text{sh}} : S^3 \rightarrow S_{\text{sh}}^3.$$

Proof: Recall that the concrete diagram $R(A)$ has no bubbles. Note also that every concrete diagram with a handle has a neighbourhood (of some such handle) isotopic to that illustrated in Figure 11, and hence has the relation \mathbf{r}_1 with a concrete diagram with one fewer handle. Thus there is a $D \in S_{\min}^3$ satisfying $D \mathbf{tr} R(A)$. The inclusion follows from the various definitions involved (in particular definition 4.10 (of $\sim_{\mathfrak{h}}$ and \sim_{sh})). The final part is clear. \square

Definition 6.2 *Fix \mathcal{K} a field and $\kappa, q \in \mathcal{K}$. Define $\mu = \mu_{\kappa q}$ and μ^{sh} by*

$$\begin{array}{ccc} \mu_{\kappa q} : S^3[F, F'] & \longrightarrow & \mathcal{K} S_{\mathfrak{h}}^3[F, F'] & & \mu^{\text{sh}} : S^3[F, F'] & \longrightarrow & \mathcal{K} S_{\text{sh}}^3[F, F'] \\ A & \mapsto & \kappa^{g(A)} q^{b(A)} \mathbb{D}(A) & & A & \mapsto & \kappa^{g(A)} q^{b(A)} \mathbb{D}_{\text{sh}}(A) \end{array}$$

and extend the domain of μ^{sh} (resp. μ) linearly to $\mathcal{K} S^3[F, F']$.

Proposition 6.3 *If $A, A' \in S_{min}^3$ then $A \sim_{\mathfrak{sh}} A'$ if and only if $\mu^{\mathfrak{sh}}(A) = \mu^{\mathfrak{sh}}(A')$. If $A, A' \in S^3$ then $A \approx_{\mathfrak{sh}} A'$ implies $\mu^{\mathfrak{sh}}(A) = \mu^{\mathfrak{sh}}(A')$.*

Proof: If $A, A' \in S_{min}^3$ then $\mathbb{D}_{\mathfrak{sh}}(A) = [A]_{\mathfrak{sh}}$ and $\mathbb{D}_{\mathfrak{sh}}(A') = [A']_{\mathfrak{sh}}$, and $b(A) = b(A') = g(A) = g(A') = 0$.

For the second case, note that $A \approx_{\mathfrak{sh}} A'$ implies $b(A) = b(A')$, $g(A) = g(A')$. \square

Let $A, A' \in S_{min}^3[F'', F]$ and $B, B' \in S_{min}^3[F, F']$. If $A \sim_{\mathfrak{sh}} A'$ and $B \sim_{\mathfrak{sh}} B'$ then $A \circ B \approx_{\mathfrak{sh}} A' \circ B'$ (stack the transformations just as the concrete diagrams are stacked). It follows that

Proposition 6.4 $\mu^{\mathfrak{sh}}(A \circ B)$ depends on A and B only through their \mathfrak{sh} -classes.

Hence there is a well-defined composition $\circ_{\mathfrak{sh}} : \mathcal{KS}_{\mathfrak{sh}}^3[-, F] \times \mathcal{KS}_{\mathfrak{sh}}^3[F, -] \rightarrow \mathcal{KS}_{\mathfrak{sh}}^3[-, -]$ given by

$$[A]_{\mathfrak{sh}} \circ_{\mathfrak{sh}} [B]_{\mathfrak{sh}} := \mu^{\mathfrak{sh}}(A \circ B) \quad (15)$$

Theorem 6.5 *The triple*

$$\mathcal{KC}_{\mathfrak{sh}} = \mathcal{KC}_{\mathfrak{sh}}(\kappa, q) = (S_{\mathbb{I}}^2, \mathcal{KS}_{\mathfrak{sh}}^3[-, -], \circ_{\mathfrak{sh}})$$

is a category. With $\kappa = 1$ it is isomorphic to a subcategory of $\mathcal{KC}_{\mathbb{P}(q)}$. For general κ it is a deformation of this subcategory.

Proof: The equivalence relation on $\mathcal{KS}^3[-, -]$ given by $\mu^{\mathfrak{sh}}$ agrees with $\sim_{\mathfrak{sh}}$ on S_{min}^3 . The well-defined composition (15) thus extends to a congruence. The new category is a quotient of \mathcal{KC}^3 by this congruence. \square

Proposition 6.6 *The hom set $\mathcal{KS}_{\mathfrak{sh}}^3[F, F']$ contains isomorphisms if and only if $F \sim_i F'$. If j_s is an isotopy and $F' = j_1(F)$ then $[D_F^{j_s}]_{\mathfrak{sh}}$ is an isomorphism in $\mathcal{KS}_{\mathfrak{sh}}^3[F, F']$.*

In consequence a skeleton for $\mathcal{KC}_{\mathfrak{sh}}$ has object set in bijection with the set of rooted trees. The category $\mathcal{KC}_{\mathfrak{sh}}$ has an intriguing representation theory, that we shall return to shortly.

7 A heterotopy category

7.1 Composition of diagrams in $\mathcal{KS}_{\mathfrak{h}}^3$

In this section we introduce a composition \cdot making the triple $\mathcal{C}_{\mathfrak{h}} = (S_{\mathbb{I}}^2, \mathcal{KS}_{\mathfrak{h}}^3[-, -], \cdot)$ a category.

We will show shortly (in Theorem 7.6) the following:

Let $A, A' \in S_{min}^3[F'', F]$ and $B, B' \in S_{min}^3[F, F']$. Let X_F be any complete subset of Π_F . If $A \sim_{\mathfrak{h}} A'$ and $B \sim_{\mathfrak{h}} B'$ then

$$\mu_{\kappa q}(A \circ \eta(X_F) \circ B) = \mu_{\kappa q}(A' \circ \eta(X_F) \circ B').$$

In other words $\mu_{\kappa q}(A \circ \eta(X_F) \circ B)$ depends on A, B only through their \mathfrak{h} -classes. This makes the following construction well defined.

Definition 7.1 Let $[A]_{\mathfrak{h}} \in S_{\mathfrak{h}}^3[F'', F]$ and $[B]_{\mathfrak{h}} \in S_{\mathfrak{h}}^3[F, F']$, and let A, B be any minimal concrete diagrams in $[A]_{\mathfrak{h}}$ and $[B]_{\mathfrak{h}}$ respectively. Let X_F be any complete subset of Π_F . Then

$$[A]_{\mathfrak{h}} \cdot [B]_{\mathfrak{h}} = \mu_{\kappa q}(A \circ \eta(X_F) \circ B) \in \mathcal{KS}_{\mathfrak{h}}^3[F'', F'].$$

In fact we will show (equation (17)) that this composition does not depend on the choice of X_F either. Thus $[A]_{\mathfrak{h}} \cdot [B]_{\mathfrak{h}}$ is natural and well defined in that, for given p and q in field \mathcal{K} , it depends only on $[A]_{\mathfrak{h}}$ and $[B]_{\mathfrak{h}}$.

We next prove the well-definedness theorem; and then turn to study the properties of this composition.

7.2 Well-definedness Theorem

Proposition 7.2 Let A, B in $S_{min}^d[F, F']$. Then $A \sim_{\mathfrak{h}} B$ if and only if there are L in Π_F and R in $\Pi_{F'}$ such that

$$A \sim_{\mathfrak{sh}} L \circ B \circ R.$$

The same holds with \mathfrak{h} replaced by \mathfrak{i} and \mathfrak{sh} by \mathfrak{si} .

Proof: Noting Definition 3.8 we have that A is strongly heterotopic (in fact, strongly isotopic) to $I_F \circ A \circ I_{F'}$. Apply to A the heterotopy that takes it to B and simultaneously change the $I_F, I_{F'}$ by isotopies in a small neighbourhood of A so that the image of $I_F \circ A \circ I_{F'}$ under these operations is a concrete diagram at all times. Under those isotopies, the I_F and $I_{F'}$ become the required L and R respectively. The result is a strong heterotopy from $I_F \circ A \circ I_{F'}$ to $L \circ B \circ R$ and the proposition follows. \square

Lemma 7.3 Let A be in $S^d[F, F']$ (note: not necessarily minimal). For any L in Π_F and R in $\Pi_{F'}$, we have $\mu_{pq}(A) = \mu_{pq}(L \circ A \circ R)$.

Proof: Let $C \in \mathbb{D}(A)$. Then $L \circ C \circ R \in \mathbb{D}(L \circ A \circ R)$. By Proposition 7.2 we have $C \sim_{\mathfrak{h}} L \circ C \circ R$ and hence $\mu_{pq}(C) = \mu_{pq}(L \circ C \circ R)$. By the definition of μ_{pq} ,

$$\begin{aligned} \mu_{pq}(A) &= p^{g(A)} q^{b(A)} \mu_{pq}(C), \\ \mu_{pq}(L \circ A \circ R) &= p^{g(L \circ A \circ R)} q^{b(L \circ A \circ R)} \mu_{pq}(L \circ C \circ R). \end{aligned}$$

But clearly A and $L \circ A \circ R$ have the same number of handles and bubbles. \square

Proposition 7.4 Let $A_i, A'_i \in S_{min}^d[F^i, F^{i+1}]$ for $i = 1, 2, \dots, n$. If $A_i \sim_{\mathfrak{sh}} A'_i$ then

$$\mu_{pq}(A_1 \circ \dots \circ A_n) = \mu_{pq}(A'_1 \circ \dots \circ A'_n). \quad (16)$$

Proof: Let $C \in \mathbb{D}(A_1 \circ A_2)$ and $C' \in \mathbb{D}(A'_1 \circ A'_2)$. By Proposition 2.11 $p(A_1 \circ A_2) = p(A'_1 \circ A'_2)$, therefore $p(C) = p(C')$ and by Theorem 5.1 we have $C \sim_{\mathfrak{sh}} C'$. Now,

$$\begin{aligned} \mu_{pq}(A_1 \circ A_2) &= p^{g(A_1 \circ A_2)} q^{b(A_1 \circ A_2)} \mu_{pq}(C), \\ \mu_{pq}(A'_1 \circ A'_2) &= p^{g(A'_1 \circ A'_2)} q^{b(A'_1 \circ A'_2)} \mu_{pq}(C'). \end{aligned}$$

But $\mu_{pq}(C) = \mu_{pq}(C')$ and the number of bubbles and handles is the same in $A_1 \circ A_2$ and in $A'_1 \circ A'_2$. Now iterate. \square

Proposition 7.5 *If X_F and X'_F are two complete subsets of Π_F , and $\eta(X_F)$, $\eta(X'_F)$ the corresponding idempotents (see definitions 3.21 and 3.22) then for any $A \in S_{min}^d[F'', F]$ and $B \in S_{min}^d[F, F']$,*

$$\mu_{pq}(A \circ \eta(X_F) \circ B) = \mu_{pq}(A \circ \eta(X'_F) \circ B) \quad (17)$$

Proof: For every term in $\eta(X_F)$ there is a term in $\eta(X'_F)$ that realises the same permutation, hence has the same connectivity. By Theorem 5.1 those two terms are strongly heterotopic minimal diagrams. Now apply equation (16) in case $n = 3$, and the linearity of μ_{pq} . \square

Theorem 7.6 *Let $A, A' \in S_{min}^d[F'', F]$ and $B, B' \in S_{min}^d[F, F']$. Let X_F be any complete subset of Π_F . If $A \sim_{\mathfrak{h}} A'$ and $B \sim_{\mathfrak{h}} B'$ then*

$$\mu_{pq}(A \circ \eta(X_F) \circ B) = \mu_{pq}(A' \circ \eta(X_F) \circ B').$$

Proof: By proposition 7.2 there are L_1, R_1, L_2, R_2 in Π_F such that

$$\begin{aligned} A &\sim_{sh} L_1 \circ A' \circ R_1, \\ B &\sim_{sh} L_2 \circ B' \circ R_2. \end{aligned}$$

Therefore, by equation (16),

$$\mu_{pq}(A \circ \eta(X_F) \circ B) = \mu_{pq}(L_1 \circ A' \circ R_1 \circ \eta(X_F) \circ L_2 \circ B' \circ R_2).$$

By lemma 7.3 (which allows L_1 and R_2 to be eliminated),

$$\mu_{pq}(A \circ \eta(X_F) \circ B) = \mu_{pq}(A' \circ R_1 \circ \eta(X_F) \circ L_2 \circ B').$$

But $R_1 \circ \eta(X_F) \circ L_2$ is strongly heterotopic (in the obvious sense) to $\eta(X_F)$, hence applying equation (16) again we are done. \square

7.3 Properties of the composition $[A]_{\mathfrak{h}} \cdot [B]_{\mathfrak{h}}$

Theorem 7.7 *The triple*

$$\mathcal{C}_{\mathfrak{h}} = (S_{\mathfrak{h}}^2, \mathcal{K}S_{\mathfrak{h}}^3[-, -, \cdot])$$

is a category.

Proof: We need to check (i) for identity elements, and (ii) for associativity.

(i) For any $[A]_{\mathfrak{h}} \in S_{\mathfrak{h}}^3[F, F]$, and any X_F a complete subset of Π_F , we have

$$[A]_{\mathfrak{h}} \cdot [I_F]_{\mathfrak{h}} = \mu_{pq}(A \circ \eta(X_F) \circ I_F) = \mu_{pq}(A \circ \eta(X_F)) = \mu_{pq}(A) = [A]_{\mathfrak{h}}.$$

Similarly, $[I_F]_{\mathfrak{h}} \cdot [A]_{\mathfrak{h}} = [A]_{\mathfrak{h}}$.

(ii) It remains to prove associativity:

Lemma 7.8 *For any $[A]_{\mathfrak{h}}, [B]_{\mathfrak{h}}, [C]_{\mathfrak{h}} \in S_{\mathfrak{h}}^3[-, -]$ with A, B, C composable,*

$$([A]_{\mathfrak{h}} \cdot [B]_{\mathfrak{h}}) \cdot [C]_{\mathfrak{h}} = [A]_{\mathfrak{h}} \cdot ([B]_{\mathfrak{h}} \cdot [C]_{\mathfrak{h}}).$$

Proof: Let A, B, C be composable in S_{min}^3 , and $X_F, X_{F'}$ complete. Let $D_X \in \mathbb{D}(A \circ X \circ B)$ for $X \in X_F$, $G_{X'} \in \mathbb{D}(B \circ X' \circ C)$ for $X' \in X_{F'}$, and $E_{XX'} \in \mathbb{D}(D_X \circ X' \circ C)$ and $H_{XX'} \in \mathbb{D}(A \circ X \circ G_{X'})$. Then

$$\begin{aligned} [A]_{\mathfrak{h}} \cdot [B]_{\mathfrak{h}} &= \frac{1}{|\Sigma_F|} \sum_{X \in X_F} \mu_{pq}(A \circ X \circ B) \\ &= \frac{1}{|\Sigma_F|} \sum_{X \in X_F} p^{g(A \circ X \circ B)} q^{b(A \circ X \circ B)} [D_X]_{\mathfrak{h}} \end{aligned}$$

so

$$\begin{aligned} ([A]_{\mathfrak{h}} \cdot [B]_{\mathfrak{h}}) \cdot [C]_{\mathfrak{h}} &= \frac{1}{|\Sigma_F|^2} \sum_{X \in X_F} p^{g(A \circ X \circ B)} q^{b(A \circ X \circ B)} \sum_{X' \in X_{F'}} p^{g(D_X \circ X' \circ C)} q^{b(D_X \circ X' \circ C)} [E_{XX'}]_{\mathfrak{h}}, \\ [A]_{\mathfrak{h}} \cdot ([B]_{\mathfrak{h}} \cdot [C]_{\mathfrak{h}}) &= \frac{1}{|\Sigma_F|^2} \sum_{X \in X_F} p^{g(A \circ X \circ G_{X'})} q^{b(A \circ X \circ G_{X'})} \sum_{X' \in X_{F'}} p^{g(B \circ X' \circ C)} q^{b(B \circ X' \circ C)} [H_{XX'}]_{\mathfrak{h}}, \end{aligned}$$

Note that $H_{XX'}, E_{XX'} \in \mathbb{D}(A \circ X \circ B \circ X' \circ C)$, and hence $[E_{XX'}]_{\mathfrak{h}} = [H_{XX'}]_{\mathfrak{h}}$. It thus suffices to show that for each X, X' in the double sums above:

$$\begin{aligned} g(A \circ X \circ B) + g(D_X \circ X' \circ C) &= g(A \circ X \circ G_{X'}) + g(B \circ X' \circ C), \\ b(A \circ X \circ B) + b(D_X \circ X' \circ C) &= b(A \circ X \circ G_{X'}) + b(B \circ X' \circ C). \end{aligned}$$

This follows from equations (30) and (31) (see Section C) applied to $A \circ X$, B and $X' \circ C$. \square

Having constructed our categories, we now provide the basic tools for practical computation within them.

8 Practical enumeration of diagrams

Embedded manifolds are not easy to manipulate combinatorially in general. However, by Theorem 5.1 we have an injective map $p : S_{\mathfrak{sh}}^3[F, F'] \rightarrow \mathbb{P}(F \dot{\cup} F')$ for any pair F, F' . The combinatorics of set partitions are quite well understood — the elements of $\mathbb{P}(F \dot{\cup} F')$ are enumerated (for any given enumeration of $F \dot{\cup} F'$) in, for example, [21]. Thus to enumerate $S_{\mathfrak{sh}}^3[F, F']$ it is sufficient to describe the subset $p(S_{\mathfrak{sh}}^3[F, F'])$ of $\mathbb{P}(F \dot{\cup} F')$. We do this next. (We then demonstrate the utility of the method by computing some explicit multiplication tables in the heterotopy category. We postpone detailed representation theory to a separate paper.)

In order to give an explicit combinatorial characterisation of diagrams, that is, a condition for a partition in $\mathbb{P}(F \dot{\cup} F')$ to be in the image of the map p above, it will be helpful to recall some graph theory.

8.1 Graph basics, tree graphs and $S_{\mathbb{I}}^2$

Definition 8.1 A (directed) graph G is two sets, V_G, E_G (the set of vertices and the set of edges, respectively), together with two functions $i : E_G \rightarrow V_G$ and $f : E_G \rightarrow V_G$. For each total order $\omega : V_G \rightarrow \mathbb{N}$ there is a matrix $\Omega_\omega(G)$ whose j, k -th entry is the number of edges e such that $\omega(i(e)) = j$ and $\omega(f(e)) = k$.

An undirected graph is a graph G in which for every $e_1 \in E_G$ with $i(e_1) = v_1$ and $f(e_1) = v_2$ there is an e'_1 with $i(e'_1) = v_2$ and $f(e'_1) = v_1$.

Definition 8.2 Graphs G, G' are said to be isomorphic if for any w a total order of V_G there is a total order w' of $V_{G'}$ such that $\Omega_w(G) = \Omega_{w'}(G')$.

Definition 8.3 Let G be an undirected graph and C a set. An edge colouring of G by C is a map from the edge set of G to C . Write G^C for the set of all edge colourings of G by C .

Note that any function f defines a partition of its domain by $x \sim y$ if $f(x) = f(y)$. Thus we have a map from G^C to partitions of E_G . This map is surjective (each perm of the set C defines the same partition).

Definition 8.4 A rooted graph is a pair (G, v) consisting of a graph G and an element of V_G (called the root).

Two rooted graphs $(G, v), (G', v')$ are isomorphic if they are isomorphic as graphs via an isomorphism in which the positions of the roots agree in the respective orders (i.e. $w(v) = w'(v')$).

Write $[G, v]$ for the isomorphism class of rooted graph (G, v) .

Definition 8.5 A rooted tree is a tree graph with a single distinguished vertex (others unlabeled), that is, a class $[G, v]$ where G is a tree graph.

Write \mathcal{T} for the set of rooted trees and \mathcal{T}_n for the set of rooted trees with n vertices.

The association of $[G, v]$ to (G, v) associates a rooted tree to each rooted tree graph by ‘forgetting’ the labels on all the vertices except the root.

For V a set let $\mathcal{H}(V)$ denote the set of graphs with vertex set V . Let $\mathcal{H}_u(V)$ denote the subset of undirected graphs. Write \mathcal{H}_u for the class of all finite undirected graphs; and \mathcal{H}_{ru} for the class of all finite undirected rooted graphs.

Define

$$\mathcal{G} : S_{\mathbb{I}}^2 \rightarrow \mathcal{H}_{ru}$$

as follows: (1) The vertex set of $\mathcal{G}(F)$ is the set of connected components of $\mathbb{R}^2 \setminus F$ (‘regions’); (2) The root is the vertex associated to the unbounded region; (3) There is an undirected edge between v_1 and v_2 in $\mathcal{G}(F)$ if there is a component in F which is a boundary between the corresponding two regions.

It will be evident that this graph $\mathcal{G}(F)$ is a tree graph. (It is not, however, a rooted tree, since its vertices are labeled.)

Proposition 8.6 Boundary configurations $F, F' \in S_{\mathbb{I}}^2$ are isotopic if and only if their tree graphs pass to the same rooted tree, i.e. $[\mathcal{G}(F)] = [\mathcal{G}(F')]$. \square

The passage from boundary configuration to rooted tree is exemplified in Figure 16.

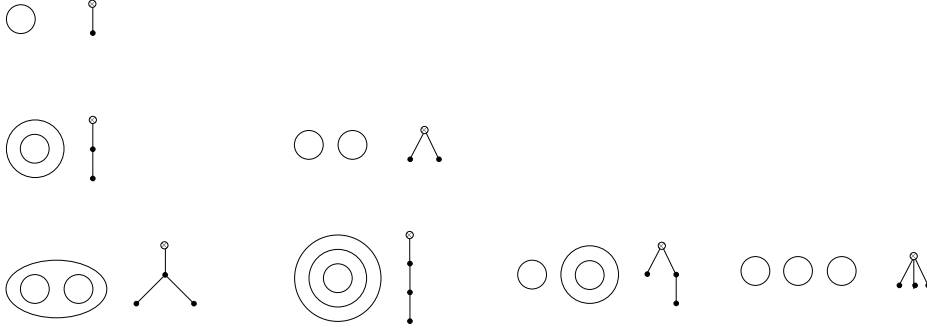

Figure 16: Some boundary configurations in S_1^2 and associated trees.

8.2 Enumerating diagrams in $S_{\mathfrak{sh}}^3$ and $S_{\mathfrak{h}}^3$

Suppose that S is a totally ordered set. The total order on S induces a total order on the parts of any partition of S , which we call *lexicographic* order, as follows. Arrange the elements of each part in the order inherited from S , then arrange the parts in the order of their first elements (this is the order introduced in [21, §8.3.2]).

Let us assume that $S^3[F, F']$ comes equipped with a total order on $F \dot{\cup} F'$. This induces a total order on the components of any diagram D in $S_{\min}^3[F, F']$ as follows. These components are in natural correspondence with the parts of $p(D) \in \mathbb{P}(F \dot{\cup} F')$, and these are ordered by the lexicographic order above as derived from the order on $F \dot{\cup} F'$. We will write f_{lex} for the numbering of components by this total order.

Now consider a concrete diagram $D \in S^3[F, F']$. We may regard the corresponding ordered pair of graphs $(\mathcal{G}(F), \mathcal{G}(F'))$ as a single graph $\mathcal{G}(F \dot{\cup} F')$ by identifying the roots. Suppose that D has m connected components, and let f be a map counting these components (we say component d has ‘colour’ $f(d)$). We may associate the pair (D, f) with a colouring $\phi(D, f)$ of the edges of $\mathcal{G}(F \dot{\cup} F')$ as follows. If boundary loop l belongs to component d in D then the edge associated to loop l is coloured by the colour $f(d)$.

Example 8.7 Consider Figure 6, which is of a diagram with three components, and take f to enumerate these components in order of their leftmost points as drawn. The graph $\mathcal{G}(F \dot{\cup} F')$ is as shown on the left in Figure 17. The colouring $\phi(D, f)$ is as shown on the right.

Note that $D \sim_{\mathfrak{sh}} D'$ implies $\phi(D, f_{lex}) = \phi(D', f_{lex})$. Thus ϕ can be considered as defined on \mathfrak{sh} -classes of diagrams. Indeed it is an injective map from \mathfrak{sh} -classes into $\mathcal{G}(F \dot{\cup} F')^{\{1,2,\dots,n\}}$, the image of which then defines a partition, via the argument following Definition 8.3. Thus we will have the desired characterisation of $S_{\mathfrak{sh}}^3$ if we can describe the image of ϕ .

For any two edges e, e' in a tree let $\text{ch}(e, e')$ denote the chain of edges connecting them in the tree (excluding e and e' themselves).

Definition 8.8 An element of $\mathcal{G}(F \dot{\cup} F')^C$ is said to be *admissible* iff for every pair

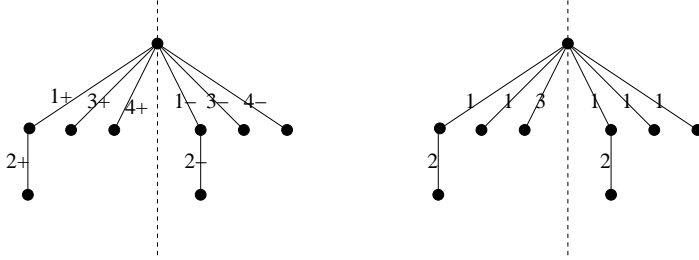

Figure 17: (i) Edge/label correspondence; (ii) colouring.

of same coloured edges e, e' either there is another edge in $ch(e, e')$ also of the same colour, or every colour appearing in $ch(e, e')$ occurs an even number of times.

For example, the colouring on the right in Figure 17 is admissible. The only non-empty chain to check is between the two edges with the colour 2. Here the chain has colour sequence 1,1 (which is an even number of each colour). Meanwhile replacing either 2 with a 3 would make an inadmissible colouring, since then the two edges with colour 3 would define a chain containing a single 1.

Proposition 8.9 *The images under ϕ of coloured concrete diagrams D with n components and $D \in S^3[F, F']$ are precisely the admissible graph colourings in $\mathcal{G}(F \dot{\cup} F')^{\{1,2,\dots,n\}}$.*

Proof: We need to show (I) that every $\phi(D, f)$ is admissible; and (II) that every admissible graph colouring is the image of some D .

(I): Consider any $\phi(D, f)$. We require to show that whenever $f(e) = f(e')$ and no other edge in $ch(e, e')$ has colour $f(e)$, then any given colour occurs an even number of times. But each component d of D partitions the remainder of the universe in to two parts (with every other component entirely on one side or the other). Thus, in passing from e to e' , every time we pass through an edge of some colour we toggle the state of being inside or outside of the corresponding component of D . Since every component lies entirely inside or outside every other in this sense, the fact that e and e' are in the same component implies that any other given colour must appear an even number of times in the chain.

(II) Consider any admissible graph colouring. Note that if there are two edges with the same colour then there are two *adjacent* edges with the same colour. A concrete diagram D_1 in which such adjacent edges are part of the same component can be built by bridging these components in any concrete diagram in which each component of D is a topological disk (with boundary some component of $F \dot{\cup} F'$).

If there are two edges with the same colour that are not adjacent then there are two such separated only by adjacent same-colour pairs. The corresponding loops are in different components in D_1 . However these components can be bridged in D_1 by a route which passes down each of the bridges corresponding to the separating adjacent same-colour pairs.

It is an exercise to show that this procedure can be iterated. \square

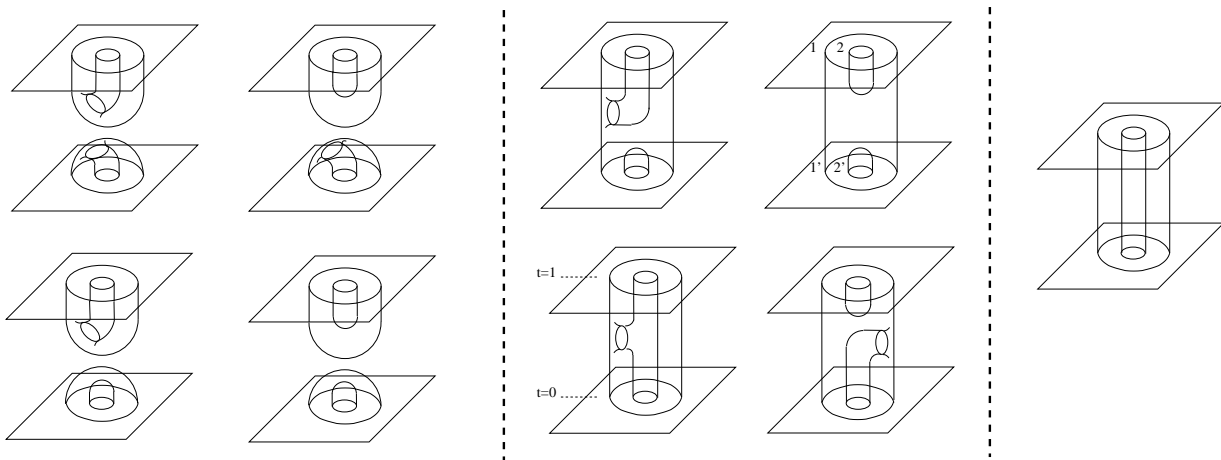

Figure 18: Diagrams organised by increasing number of ‘propagating loops’ (i.e. connected components meeting both boundary hyperplanes).

8.3 Examples

The complete list of diagrams in $S_{\text{sh}}[F, F]$ in case $F = (())$ is given in Figure 18. The best way to organise these is to note that the diagrams not only form a basis for a \mathcal{K} -algebra, but also that this basis reveals a sequence of ideals in the algebra. This follows from the fact that the product of two diagrams can never be a diagram further to the right, as ordered in the figure. (This is the analogue of the propagating line filtration for the Temperley-Lieb algebra [21]. From left to right in the figure we have first the diagrams with no propagating loops; then those with one propagating loop; then those with two.) This means that we do not need to compute the whole 9×9 multiplication table to determine the structure of the algebra. It is enough to compute within the sections of this filtration.

The grouped diagrams are bases for the sections in a sequence of double-sided ideals (i.e. for bimodules). As *left*-modules (i.e. acted on by diagram multiplication from above) these break up further – as a direct sum of isomorphic left-modules with bases given by the rows in each group of diagrams. Let us restrict attention here to representation theory over the complex field. Then over the ring $\mathbb{C}[q, \kappa]$ these modules have an inner product defined on them via duality (diagram inversion) and composition in the algebra. The Gram matrices are

$$M(\emptyset) = \begin{pmatrix} q^2 & q \\ q & q\kappa \end{pmatrix}; \quad M((\)) = \begin{pmatrix} q & 1 \\ 1 & \kappa \end{pmatrix}; \quad M(((\))) = (1)$$

where the argument is the *propagating* loop configuration. By the usual theory of Gram determinants [25] this shows that the algebra is generically semisimple, but non-semisimple when

$$q(q\kappa - 1) = 0.$$

Note that this nicely generalises the 2D case (cf. [21]). This raises many interesting questions (about the connection with quantum groups [17] for example), which will be treated elsewhere.

9 Discussion

Temperley–Lieb representation theory controls the kind of observables and correlations occurring in certain physical models in two-dimensions, as already noted. Via an appropriate limit it is also closely related to associated conformal algebras and their generalisations [20]. At the same time, the category theoretic setting makes Temperley–Lieb representation theory *per se* relatively easy to analyze (see [21]). While the corresponding physical associations in three-dimensions remain an intriguing open question for now, the matching categorical structure (that we have introduced in this paper) does facilitate immediate progress in representation theory. We will compartmentalize the construction (here) and the representation theory (in a separate paper), however, as the representation theory constitutes an interesting (and rather long) story in its own right.

Acknowledgments We thank Anton Cox for helpful discussions, and Steffen Koenig and the organisers of the First (Oxford) Diagram Algebras Conference, for giving MA the opportunity to present these results there.

Appendix

A Rooted tree combinatorics

We have seen in Propositions 8.6 and 6.6 that the object set for our category is given by the set of rooted trees. This set thus takes the role played by the natural numbers in the Temperley–Lieb category. Accordingly it will be useful to enumerate, order, and suitably partially order this set.

The number L_n of isotopy classes of loop configurations with n loops (or equivalently of rooted trees) is given by the generating functional [36, §3.17]

$$\begin{aligned} \sum_{n \geq 0} L_n x^n &= \prod_{k \geq 1} (1 - x^k)^{-L_{k-1}} \\ &= (1-x)^{-1} (1-x^2)^{-1} (1-x^3)^{-2} \dots = (1+x+x^2+x^3+x^4 \dots) (1+x^2+x^4+\dots) (1+2x^3+\dots) \dots \\ &= 1 + x + 2x^2 + 4x^3 + 9x^4 + \dots \end{aligned} \tag{18}$$

In our heuristic bracket notation the first few are: $\emptyset, (), ()(), (()), ()()(), ()()(), ((())), (((()))), ()()()$,

$$()()()(), ()()()(), ()()()(), ()()()(), ()()()(), ()()()(), (((()))), ()()()()$$

(we will give a more usable notation shortly); while the first few loop configurations are given in Figure 19.

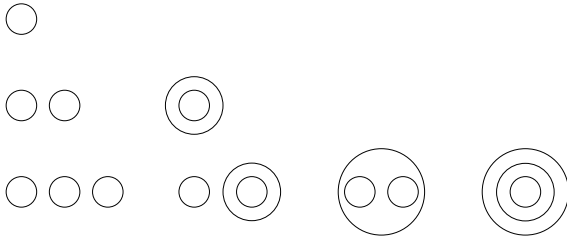

Figure 19: Loop configurations up to $n = 3$.

A.1 Ordering rooted trees

Let S be a set of symbols. The set of all sequences in the set of symbols S is denoted $\langle S \rangle$. Consider the two symbol ‘alphabet’

$$S_2 = \{ \}, \{ \}.$$

Then for example, the sequence $\rangle\rangle\rangle\rangle(\rangle(\rangle(\rangle \in \langle S_2 \rangle$. A properly nested bracket sequence is any such bracket sequence in which the running total of \rangle 's never exceeds that of \langle 's. The set \mathcal{B}_n of nestings of n bracket pairs is the set of properly nested bracket sequences in which there are n of each type of bracket.

A forest is a rooted tree with at least one vertex (the point being that by removing the root we get a collection of rooted trees — each with root a child of the original root).

It will be convenient to be able to totally order \mathcal{T} , and hence the set of forests. To this end we first introduce a larger set of trees, with a natural total order.

Definition A.1 *A rooted plane tree is a rooted tree with an ordering for the children of each vertex.*

Write \mathcal{T}^p for the set of rooted plane trees and \mathcal{T}_n^p for the set of rooted plane trees with n vertices.

The child ordering passes lexicographically to an ordering of all vertices of a rooted plane tree (root first; then the first child of the root; then her first child (else the second child of the root); and so on).

The *depth* of a vertex is the distance from the root.

The set \mathcal{T}^p of rooted plane trees, and the set \mathcal{T}_n^p of rooted plane trees with n vertices, may each be ordered by the lex order on the depth sequences of their elements.

In order to illustrate this order it will be convenient to have an inline representation of rooted plane trees. Let R be any planar representation of $t \in \mathcal{T}^p$ in the upper half-plane, such that the root lies at $(0,0)$, and the children of each vertex appear in clockwise order around it. The *traversal* of R is the sequence of directed edges which must be traversed to move clockwise round the outside of the tree from root back to root. The map τ from R to sequences in the two symbol alphabet $\{ \}, \{ \}$ takes R to the sequence recording \langle for each outward directed edge and \rangle for each directed edge back towards the root. It will be evident that $\tau(R)$ depends only on t .

Proposition A.2 *The map τ defines a bijection $\tau : \mathcal{T}_n^p \rightarrow \mathcal{B}_n$.*

Using the inline representation of rooted plane trees thus provided by bracket sequences (but augmented by an extra outer layer of brackets so that the root may be explicitly given its depth 0 label), the abovementioned order on \mathcal{T}^p begins:

$$\begin{array}{cccccccccc} () & (()) & ((())) & (((()))) & ((()())) & (()()) & (((())()) & (((()()))) & ((((())))) \\ 0 & 01 & 011 & 012 & 0111 & 0112 & \underline{0121} & 0122 & 0123 \end{array}$$

There is a map from rooted plane trees to rooted trees which simply forgets all the child labels.

Definition A.3 *Let T_1, T_2 be two rooted plane trees. If the sequence of depths (of vertices in the traversal – including only the first occurrence of each, as exemplified above) first differ in a vertex of T_1 deeper than one of T_2 we say T_1 is heavier than T_2 [15].*

Among rooted plane trees corresponding to the same rooted tree there is one which is heavier than no other. The set of these *left-light* rooted plane trees thus provides a unique such tree for each rooted tree.

The set of rooted trees (and hence the set of forests) inherits an order from the subset order on the subset of *left-light* rooted plane trees.

A.2 Partial orders on the set of rooted trees

Let t_1, t_2 be bracket sequences such that the concatenation $t_1 t_2$ is a matched bracket sequence (and hence a notation for a rooted plane tree). Then if t is another matched bracket sequence then $t_1 t t_2$ is another (and hence gives another such tree). Note for example that the set of sequences of form (t) has no element in common with the set of form $()t$.

A rooted subtree of a rooted tree is one which can be obtained by (iterated) removal of leaves. We write $a \triangleleft b$ if a is a rooted subtree of b . An important *partial* order on the set of rooted trees (and hence the set of forests) is the rooted-subtree order.

The *fold* operation on a rooted tree is of form

$$(t_1(t_2)) \mapsto (t_1)t_2$$

where t_1 and t_2 are any trees (matched bracket sequences in this notation), and may be applied anywhere in a tree matching this pattern.

Example:

$$((())) \mapsto ()(). \tag{19}$$

A *meld* operation is of form

$$(t_1)(t_2) \mapsto (t_1 t_2)$$

Example: $(())(()) \mapsto ((())())$.

Definition A.4 (*Sub/fold order*) We write $a \triangleleft_f b$ if a may be obtained by b by any sequence of fold and meld operations and leaf removals.

The following figure is the beginning of the Hasse diagram for the sub/fold order:

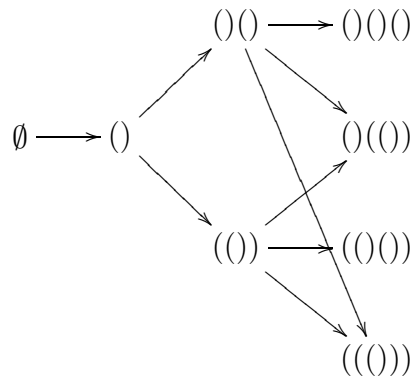

We are describing this order because it turns out to play a big role in the representation theory of our categories (as we outline in section B).

Note that this poset is not a lattice, in particular it does not have a meet: $((()))$ and $()(())$ ‘meet’ at $((())$ and $()()$.

B Diagram category representation theory

Here we give a very brief preview of the organisational scheme now available to us for analysing the reductive representation theory of our diagram categories (i.e. the search for simple modules of the diagram algebras contained therein).

In this section $C = (S_C, \text{hom}_C(-, -), \circ)$ is a category, hom_C denotes the class of all morphisms in C , and 1_F the identity hom in $\text{hom}_C(F, F)$. Here we use the ‘diagram’ notation for homs, meaning that they compose in the order $\text{hom}_C(F', F) \times \text{hom}_C(F, F'') \rightarrow \text{hom}_C(F', F'')$. We assume (merely for notational simplicity) that all our categories are small.

For any poset (T, \leq) and map $f : \text{hom}_C \rightarrow T$ we say that C is filtered by f if for each composable pair of homs D, D' we have $f(D \circ D') \leq f(A)$ for $A \in \{D, D'\}$.

Example B.1 For $D \in S^d$ (any d) the propagating number $\#(D)$ is simply the number of components of D that contain boundary components in both boundaries. We have

$$\#(D \circ D') \leq \min(\#(D), \#(D'))$$

so \mathcal{C}^d is filtered by $\#$.

In a \mathcal{K} -linear category with a given collection of bases we will adopt the convention that such a filter, if defined on the bases, takes the lowest value on linear combination X from the basis elements with finite support in X . Then $\mathcal{F}(\mathcal{C}^d)$ and \mathcal{C}_{sh} and \mathcal{C}_{b} are also filtered by $\#$.

Definition B.2 A morphism D in a category $C = (S_C, \text{hom}_C(-, -), \circ)$ factors through object $F \in S_C$ if $D = D' \circ D''$ with $D' \in \text{hom}_C(-, F)$ and $D'' \in \text{hom}_C(F, -)$. For each partial order \preceq on object set S_C then $\#^{\preceq}(D)$ is the set of \preceq -lowest objects in S_C that D factors through.

Example B.3 Consider the concrete diagrams in Figure 7 as representatives of homs in \mathcal{C}_{sb} . The left diagram (call it $[L]_{\text{sb}}$) factors through objects in the isotopy class (\circ) , and also through objects with more loops, but not through any object in the class $(\circ\circ)$, nor any object with fewer loops. The right diagram factors through $(\circ\circ)$.

Definition B.4 With the setup of Definition B.2, we say category C is filtered by \preceq if $F \in \#^{\preceq}(D \circ D')$ implies $F \preceq F'$ for all $F' \in \#^{\preceq}(D) \cup \#^{\preceq}(D')$.

The point about such a filter, when it exists, is that it leads to a filtration on ideals, and hence to an initial decomposition in representation theory. This raises the question of how to construct such a filter, which in our case has a rather neat answer.

Definition B.5 For each category C define a relation on S_C by $F \geq_p F'$ if the map

$$\text{hom}_C(F', F) \times \text{hom}_C(F, F') \rightarrow \text{hom}_C(F', F') \quad (20)$$

$$(A, B) \mapsto A \circ B \quad (21)$$

is surjective. That is to say, $F \geq_p F'$ if $1_{F'}$ factors through F .

Proposition B.6 The relation \geq_p is reflexive and transitive, for any category, but not in general antisymmetric.

If the relation is antisymmetric we call poset (S_C, \geq_p) the *propagating order* on C .

Example B.7 (i) Any skeleton of the categorical basis $\mathcal{C}_{\text{sb}}(1, 1)$ has a propagating order. (ii) This order is given by the sub/fold order on rooted trees (and hence on objects).

Outline proof: (i) By B.1 $F \geq_p F'$ implies $|F| \geq |F'|$. If $F \geq_p F'$ and $|F| = |F'|$ then there is a factorisation through F of form $1_{F'} = D \circ D'$. But then $D' \circ D$ is an isomorphism, and hence so is D , and $F = F'$ by the skeleton property.

(ii) We need to show that the propagating relation is given by the sub/fold order. It will be clear that the sub order is a subrelation (i.e. that $F \triangleright F'$ implies $F \geq_p F'$). Now suppose that F and F' differ by a fold operation. Locally the propagating condition is satisfied by the following composition, which shows that $1_{F'}$ with $F' \sim$

$()()$ factors with $F \sim (((()))$ in the middle layer (noting that $\kappa = 1$ is a unit):

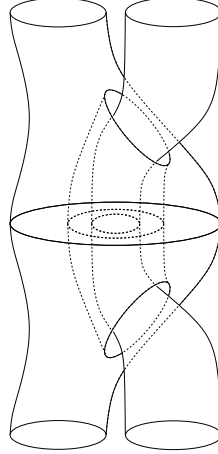

Now compare with equation (19). A similar picture can be drawn for the meld operation. It follows from this that $F \triangleright_f F'$ implies $F \geq_p F'$. (We will complete the argument elsewhere.)

A propagating order has very useful consequences in representation theory. Their specific development depends on whether the category has a \mathcal{K} -linear structure. For the sake of simplicity here we assume it does not. See [24] for the \mathcal{K} -linear case.

Definition B.8 Write $\text{hom}_C^G(F, F')$ for the subset of $\text{hom}_C(F, F')$ of homs that factor through G .

Note that $\text{hom}_C(F, F')$ is an M -set for the monoid $M = \text{hom}_C(F, F)$, by the category composition.

Proposition B.9 If $G \geq_p G'$ then $\text{hom}_C^G(F, F') \supseteq \text{hom}_C^{G'}(F, F')$ is an inclusion of M -sets. \square

Definition B.10 If C has a propagating order then

$$\text{hom}_C^{\overline{G}}(F, F') = \text{hom}_C^G(F, F') \setminus \cup_H \text{hom}_C^H(F, F')$$

where the union is over all H below G in the order.

Note that $\text{hom}_C^{\overline{G}}(F, F')$ is empty unless $F, F' \geq_p G$.

Example B.11 Consider $C = \mathbb{C}_{\text{sf}}(1, 1)$, and $F \sim ()()$. Then $\text{hom}_C(F, F)$ is shown in Figure 18. The set $\text{hom}_C^{\overline{0}}(F, F)$ is the middle group of four diagrams. The set $\text{hom}_C^{\overline{\emptyset}}(F, F)$ is the leftmost group of four, and

$$\text{hom}_C^{\overline{()}}(F, F) = \text{hom}_C^{\overline{0}}(F, F) \cup \text{hom}_C^{\overline{\emptyset}}(F, F)$$

The next question is whether this ideal structure can be further refined. In particular what is the structure of $\text{hom}_C^{\overline{F}}(F, F)$? In our case we already have the $\#$ filtration to hand, so we should next bring the two structures together.

Definition B.12 A concrete diagram $D \in S^d[F, F']$ is full on F (respectively F') if $\#(D) = |F|$ (respectively $\#(D) = |F'|$).
 $S_F^d[F, F']$ (respectively $S_{F'}^d[F, F']$) is the subset full on F (respectively F').

Proposition B.13 Let C be a skeleton of $\mathbb{C}_{\text{sb}}(1, 1)$. If $D \in S^d[F, F']$ full on F then $\#^{\triangleleft f}(D) = \{F\}$. In particular if $\#(D) = |F| = |F'|$ then $F = F'$.

Proof: Let $D = D' \circ D''$ be any factorisation of D , through G say. Then D' is full on F , and $D' \circ \overline{D'}$ ($\overline{D'}$ is the upside-down version of D') is congruent to 1_F , so that $G \geq_p F$. Object F itself is thus uniquely lowest among such G s. \square

The corresponding observation for the TL category determines its representation theory in large part. We will investigate the present case in detail in a separate work.

C Lemmas for proof of associativity: genus counting

If a is a component of $A \in S^3$, then $\chi(a)$, $g(a)$ and $h(a)$ are the Euler number, genus, and number of holes in a . Then

$$\chi(a) = 2 - 2g(a) - h(a). \quad (22)$$

If a_1, \dots, a_n are the components of A , then

$$\chi(A) = \sum_{i=1}^n \chi(a_i), \quad (23)$$

$$g(A) = \sum_{i=1}^n g(a_i). \quad (24)$$

It is clear that, if $A \in S_{\min}^3[F, F']$ then $g(A) = 0$ and $\chi(A) = 2|A| - (|F| + |F'|)$.

Lemma C.1 For $A \in S^3[F', F]$, $B \in S^3[F, F'']$

$$\chi(A \circ B) = \chi(A) + \chi(B). \quad (25)$$

$$g(A \circ B) = g(A) + g(B) + |A \circ B| - |A| - |B| + |F|. \quad (26)$$

Proof: (i) By [26] $\chi(A)$ is the sum of the Morse indices of all the critical points in the components of A , and similarly for $\chi(B)$ and $\chi(A \circ B)$. But the critical points of $A \circ B$ are those of A plus those of B , with the same Morse indices.

(ii) From equations (23) and (24),

$$\begin{aligned} \chi(A) &= 2|A| - 2g(A) - (|F| + |F'|), \\ \chi(B) &= 2|B| - 2g(B) - (|F| + |F''|), \\ \chi(A \circ B) &= 2|A \circ B| - 2g(A \circ B) - (|F'| + |F''|). \end{aligned}$$

Then the Lemma follows immediately. \square

Note also the following generalisation with $C \in S^3[F'', F''']$:

$$g(A \circ B \circ C) = g(A) + g(B) + g(C) + |A \circ B \circ C| - |A| - |B| - |C| + |F| + |F''| \quad (27)$$

for which we make use of associativity of concatenation.

Definition C.2 For A in $S^d[F, F']$, define $\min(A)$ as the set of $B \in S_{\min}^d[F, F']$ having the same connectivity as A :

$$\min(A) = \{B \in S_{\min}^d : p(A) = p(B)\}. \quad (28)$$

Proposition C.3 Let $A, B, C \in S_{\min}^3$ be composable. Let $D \in \min(A \circ B)$ and $G \in \min(B \circ C)$. Then

$$b(A \circ B) = |A \circ B| - |D|, \quad (29)$$

$$|A \circ B| - |D| + |D \circ C| = |B \circ C| - |G| + |A \circ G|, \quad (30)$$

$$g(A \circ B) + g(D \circ C) = g(B \circ C) + g(A \circ G). \quad (31)$$

Proof: (i) $|D| = |p(A \circ B)|$ by definition.

(ii) Let $E \in \min(D \circ C)$. Then E is minimal and has the same connectivity of $D \circ C$. But the connectivity of $D \circ C$ is that of $A \circ B \circ C$, so that $E \in \min(A \circ B \circ C)$. Now, if $H \in \min(A \circ G)$, the same argument shows that $H \in \min(A \circ B \circ C)$. Hence we can take $E = H$ without loss of generality. Now, the total number of bubbles in $A \circ B \circ C$ can be counted as follows: those created in $A \circ B$, plus the new ones created in $(A \circ B) \circ C$. The latter are also those created in the concatenation $D \circ C$, so that

$$b(A \circ B \circ C) = |A \circ B| - |D| + |D \circ C| - |E|.$$

This number can also be counted by first concatenating $B \circ C$, then $A \circ G$, and finally minimising to E . Then

$$b(A \circ B \circ C) = |B \circ C| - |G| + |A \circ G| - |E|,$$

which proves the Proposition part (ii).

(iii) By Lemma C.1

$$g(A \circ B) + g(D \circ C) = |A \circ B| - |A| - |B| + |D \circ C| - |D| - |C| + |F| + |F''|$$

$$g(B \circ C) + g(A \circ G) = |B \circ C| - |B| - |C| + |A \circ G| - |A| - |G| + |F| + |F''|.$$

These expressions are equal by Proposition C.3(ii). \square

This equality may also be understood as two different ways to count the number of handles in $A \circ B \circ C$.

References

- [1] M Alvarez and P P Martin, *On generalised Temperley-Lieb categories*, preprint (2007).
- [2] M Alvarez, *Torsion cycles as non-local magnetic sources in non-orientable spaces*, Commun. Math. Phys. Online First, <http://dx.doi.org/10.1007/s00220-007-0378-0>.
- [3] Michael Francis Atiyah, *The geometry and physics of knots*, CUP, 1990.
- [4] John Baez and James Dolan, *Higher-dimensional algebra and topological quantum field theory*, Jour. Math. Phys. **36** (1995), 6073–6105, q-alg/9503002.
- [5] John C Baez and Laurel Langford, *2-tangles*, preprint (1997).
- [6] R J Baxter, *Asymptotically degenerate maximum eigenvalues of the eight-vertex model transfer matrix and interfacial tension*, J. Stat. Phys. **8** (1973), 25–55.
- [7] ———, *Exactly solved models in statistical mechanics*, Academic Press, New York, 1982.
- [8] V V Bazhanov and R J Baxter, *Star triangle relation for a 3-dimensional model*, J Stat Phys **71** (1994), 839–864.
- [9] H W J Blote and M P Nightingale, *Critical behaviour of the two-dimensional Potts model with a continuous number of states; a finite size scaling analysis*, Physica **112A** (1982), 405–465.
- [10] J E L Brouwer, *Beweis des Jordanschen satzes fur den n-dimensionalen raum*, Mathematische Annalen **71** (1912), 314–327.
- [11] S Dasmahapatra and P P Martin, *On the algebraic approach to cubic lattice Potts models*, J Phys A **29** (1996), 263–278.
- [12] Tammo Diemer and Mark J Hadley, *Charge and the topology of spacetime*, preprint (1999).
- [13] F M Goodman, P de la Harpe, and V F R Jones, *Coxeter graphs and towers of algebras*, Math Sci Research Inst Publications 14, Springer-Verlag, Berlin, 1989.
- [14] R M Green and P P Martin, *Constructing cell data for diagram algebras*, Journal of Pure and Applied Algebra **209** (2007), 551–569, (math.RA/0503751).
- [15] Shin ichi Nakano and Takeaki Uno, *Efficient generation of rooted trees*, NII technical report (2003), <http://research.nii.ac.jp/TechReports/03-005E.pdf>.
- [16] M Jimbo, *A q -difference analogue of $U(g)$ and the Yang-Baxter equation*, Lett Math Phys **10** (1985), 63–69.

- [17] C Kassel, *Quantum groups*, Springer, 1995.
- [18] L H Kauffman, *Knots and physics*, World Scientific, Singapore, 1991.
- [19] M Khovanov and P Seidel, *Quivers, Floer cohomology and braid group actions*, J. Amer. Math. Soc. **15** (2002), 203–271.
- [20] W M Koo and H Saleur, Int J Mod Phys A **8** (1993), 5165–5233.
- [21] P P Martin, *Potts models and related problems in statistical mechanics*, World Scientific, Singapore, 1991.
- [22] ———, *Temperley–Lieb algebras for non–planar statistical mechanics — the partition algebra construction*, Journal of Knot Theory and its Ramifications **3** (1994), no. 1, 51–82.
- [23] ———, *The partition algebra and the Potts model transfer matrix spectrum in high dimensions*, J Phys A **32** (2000), 3669–3695.
- [24] ———, *Notes on diagram categories*, preprint (2007).
- [25] P P Martin and H Saleur, *The blob algebra and the periodic Temperley–Lieb algebra*, Lett. Math. Phys. **30** (1994), 189–206, (hep-th/9302094).
- [26] W Milnor, *Morse theory*, Princeton, 1963.
- [27] E E Moise, *Geometric topology in dimensions 2 and 3*, Graduate Texts in Mathematics 47, Springer-Verlag, New York, 1977.
- [28] M Muger, *Abstract duality theory for symmetric tensor *-categories*, appendix to “algebraic quantum field theory” by Hans Halvorson in Handbook of the Philosophy of Physics (Butterfield and Earman Eds.) (2006).
- [29] T Regge and R Zecchina, *Combinatorial and topological approach to the 3d Ising model*, J Phys A **33** (2000), 741–761.
- [30] H Saleur, *Zeros of chromatic polynomials: A new approach to Beraha conjecture using quantum groups*, Commun. Math. Phys. **132** (1990), 657–679.
- [31] R Savit, *Duality in field theory and statistical systems*, Rev Mod Phys **52** (1980), 453–487.
- [32] R. Sorkin, *On the relation between charge and topology*, Journal of Physics A Mathematical General **10** (1977), 717–725.
- [33] H N V Temperley and E H Lieb, *Relations between percolation and colouring problems and other graph theoretical problems associated with regular planar lattices: some exact results for the percolation problem*, Proceedings of the Royal Society A **322** (1971), 251–280.
- [34] H Weyl, *Classical groups*, Princeton, Princeton, 1946, ch.III–V.

- [35] R. L. Wilder, *A converse of the jordan-brouwer separation theorem in three dimensions*, Transactions of the American Mathematical Society **32** (1930), 632–657.
- [36] H S Wilf, *Generatingfunctionology*, internet edition ed., Academic Press, 1994.