

A single photon emitted by a single particle in free space vacuum modes and its resonant interaction with two- and three-level absorbers

R. N. Shakhmurov,^{1,2,3} J. Odeurs,¹ and Paul Mandel²

¹*Instituut voor Kern- en Stralingsfysica, Katholieke Universiteit Leuven,
Celestijnenlaan 200 D, B-3001 Leuven, Belgium*

²*Optique Nonlinéaire Théorique, Université Libre de Bruxelles,
Campus Plaine CP 231, B-1050 Bruxelles, Belgium*

³*Kazan Physical-Technical Institute, Russian Academy of Sciences,
10/7 Sibirsky Trakt, Kazan 420029 Russia*

(Dated: October 2, 2018)

Abstract

We consider the time-delayed coincidence counting of two photons emitted in a cascade by a single particle (atom, molecule, nucleus, etc). The time-dependence of the probability amplitude of the second photon in the cascade has a sharply rising leading edge due to the detection of the first photon, as results from causality. If a macroscopic ensemble of resonant two-level absorbers is placed in the path of the second photon between the radiation source and the detector, the photon absorption does not follow Beer's law due to the time-asymmetric shape of the photon. For very short delay times almost no absorption takes place, even in an optically dense medium. We analyze the propagation of such a second photon in a thick resonant three-level absorber if a narrow electromagnetically induced transparency (EIT) window is present at the center of the absorption line. It is shown that the EIT medium can change the asymmetric time dependence of the photon probability amplitude to a bell shape (EIT filtering). This bell-shaped photon interacts much more efficiently with an other ensemble of two-level absorbers chosen, for example, to store this photon and the information it carries.

PACS numbers: 42.50.Gy, 42.50.Dv, 76.80.+y

I. INTRODUCTION

In the last decade, there has been a considerable growth of interest in single photon experiments in the visible or near infrared domain, mostly related to information storage, quantum computing and quantum cryptography. An essential element in these experiments is a single photon source named "photon gun". It emits one and only one photon when the experimentalist "pulls the trigger". Faint laser pulses with extremely low mean photon numbers are only an approximation of single photon pulses. Their state is close to a Glauber state also containing two and more photons, and in the semiclassical description the laser pulse is modelled by a Gaussian pulse. Recently, several types of true single-photon sources were reported, which are based on the laser excitation of a single trapped ion or atom [1], a single organic dye molecule in a solvent [2],[3] or a single nitrogen-vacancy color center in a diamond nanocrystal [4]. A single-photon turnstile device that uses a single quantum dot or single quantum well was also proposed [5]. Such a photon is generated spontaneously from a single quantum object (atom, molecule or quantum dot) that is placed at time $t_0 = 0$ in an excited state by a short laser pulse or electronically by injecting a single electron and a single hole to annihilate in a light emitting domain (a central quantum well in a p-n junction).

Single photon sources based on a single emitting particle can be divided in two kinds. A source of the first kind radiates in free space vacuum modes. For example, sources [2],[3] and [4] belong to the first kind. A source of the second kind radiates to a cavity mode. If a high-finesse cavity is used in a regime of strong coupling in cavity quantum electrodynamics, almost all radiation is collected in the active cavity mode and transferred through the cavity mirror (loss channel) in a well defined direction (see proposals [6],[7] based on the Jaynes-Comings model [8]). This process can be made deterministic and it allows the generation of a single photon with a controlled waveform [9],[10],[11]. In a quantum network consisting of spatially separated nodes connected by quantum communication channels it is preferable to operate with photons having a shape symmetric in time [12]. In this paper we show that there is an additional physical argument demanding a time-symmetric photon wave packet if it is supposed to use such a photon in a atom-field interaction protocol for storage and retrieval of the radiation state.

We consider a single photon source of the first kind, which intrinsically produces a photon with asymmetric temporal envelope because of causality. The resonant interaction of such a

photon with an ensemble of two-level absorbers (atoms, molecules, nuclei, etc.), referred to as a macroscopic absorber, is analyzed. We show that multiple scattering of the photon in the forward direction by the resonant particles displays unusual properties. They originate from the knowledge of the instant of time when the source particle was prepared in the excited state and then a photon was emitted, i.e., when the "trigger" of the photon gun was pulled. In the semiclassical language one can say that the photon wave packet has a particular time envelope having properties that are very unusual and different from those known for bell-shaped pulses. We compare the atom-field interaction of such a photon with that for a photon wave packet with a Gaussian time-envelope. Then, for a photon source of the first kind we analyze the possibility to reshape the photon field envelope with the help of electromagnetically induced transparency (EIT). The reshaped photon time envelope is close to the one with a Gaussian envelope and its interaction with another absorber (used, for example, for information storage or quantum computing) becomes the usual one typical for bell-shaped pulses.

The paper is organized as follows. In Sec. II we discuss the influence of causality on the spectrum of the single photon emitted by a source of the first kind and show that it introduces a broad part. In Sec. III we consider the propagation of such a photon in a thick resonant absorber. In Sec. IV we study the photon filtering through a narrow EIT window. We show that the narrow spectrum part of the photon and the broad part are separated in time. Application of single photon filtering for quantum storage is discussed in Sec. V. The conditions for level mixing induced transparency for gamma radiation are considered in Sec. VI.

II. THE INFLUENCE OF CAUSALITY ON THE SPECTRUM OF A SINGLE PHOTON SOURCE OF THE FIRST KIND

Assume that at time $t_0 = 0$ a single particle (generally a quantum object such as an atom, a molecule, a nucleus, etc.) is placed in an excited state e . If the radiation, emitted by this particle, has only natural lifetime broadening due to the coupling with the vacuum modes of free space, the radiation state is described by the usual expression [13]

$$|b\rangle = \sum_{\mathbf{k}} g_{\mathbf{k}} \frac{\exp(-i\mathbf{k} \cdot \mathbf{r}_0)}{\nu_k + i\Delta_{\text{ph}}} |1_{\mathbf{k}}\rangle, \quad (1)$$

where $|1_{\mathbf{k}}\rangle$ is a single-photon Fock state of the mode ω_k with wave vector \mathbf{k} , \mathbf{r}_0 is the location of the particle, $\nu_k = \omega_k - \omega_0$ is the frequency difference of the k -mode and the resonant transition from the excited state e to the ground state g , and $2\Delta_{ph}$ is the decay rate of the excited state e . The coupling parameter of the radiation with the source is $g_{\mathbf{k}}$. This state is actually a wave packet consisting of many Fock states and normalized such that in total it contains a single photon. Let

$$E^{(+)}(\mathbf{r}, t) = \sum_{\mathbf{k}} \hat{\epsilon}_{\mathbf{k}} \mathcal{E}_{\mathbf{k}} a_{\mathbf{k}} e^{-i\nu_k t + i\mathbf{k}\cdot\mathbf{r}}, \quad (2)$$

be the electric field operator containing only the annihilation operators $a_{\mathbf{k}}$, $\hat{\epsilon}_{\mathbf{k}}$ is the unit polarization vector, $\mathcal{E}_{\mathbf{k}}$ is a normalized amplitude of the mode \mathbf{k} . Performing the sum over the wave vector \mathbf{k} in the expression for the single photon field $b(t) = \langle 0 | E^{(+)}(\mathbf{r}, t) | b \rangle$, one obtains [13]

$$b(t) = \frac{\mathcal{E}_0}{d} \Theta(t - d/c) e^{-(i\omega_0 + \Delta_{ph})(t - d/c)}, \quad (3)$$

where $d = |\mathbf{r} - \mathbf{r}_0|$ is the distance from the source, \mathcal{E}_0 is a normalized amplitude and $\Theta(t)$ is the Heaviside step function. This wave packet has a sharply rising leading edge at $t = d/c$ and an exponentially decaying tail. The former is defined by the time $t_0 = 0$ at which the source is placed in the excited state and the latter specifies the coherence time or the mean correlation time of the photon $\tau_{ph} = 1/\Delta_{ph}$ [14]. Such a time dependence of the single-photon field was detected from radiation of a single organic dye molecule in solvents [3], in time delayed coincidence measurements (TDCM) of photons emitted in an atomic cascade (optical domain) [14] and in a nuclear cascade (gamma domain) [15, 16, 17, 18, 19]. A typical energy diagram and a detection scheme of TDCM are shown in Fig. 1(a,b). The delayed coincidence counting technique leads to the detailed observation of the time correlation between successively emitted photons $a(t)$ and $b(t)$ in the $h \rightarrow e \rightarrow g$ cascade. The photons of interest, $a(t)$ and $b(t)$, can be selected by interference filters (optical domain) [14] or these photons can be of very different energies such that different kind of detectors are used to detect them separately (gamma domain) [15, 16, 17, 18, 19]. In the TDCM detection scheme the energy of these photons is converted by high-speed, high-gain photomultipliers to electric pulses, which are then amplified and sent to fast discriminators. A time-to-amplitude convertor is turned on by a pulse due to a $a(t)$ photon and shut off by one due to a $b(t)$ photon.

Actually it is the probability $P(t) = |b(t)|^2$ and not the complex probability amplitude $b(t)$ which is measured. When a photon is detected at time $t = t_n$, we have a collapse of the photon wave function at the detector place, which shows as a single count of the detector. After many events (detector counts), one can reconstruct the actual time distribution of the probability $P(t)$. One can also extract information about the absolute value of the probability amplitude since $|b(t)| = \sqrt{P(t)}$. If we know that at time $t_0 = 0$ the source particle is placed in the excited state e and there is no absorber between the source and the detector, this probability is zero for $t < 0$, it has a maximum, 1, at $t = +0$ and from then on it decreases exponentially. The time resolution of this measurement is defined by the response time of the detector and electronic circuit. Therefore, the stepwise rise of the probability $P(t)$ at $t = 0$ is usually slightly smoothed.

For many applications it is important to know how a single photon field interacts with either a single absorber or an ensemble of quantum absorbers. In the time domain the propagation of such an asymmetric field through a thick absorptive medium was considered quantum mechanically [20] and semiclassically [15] for gamma photons and for small amplitude pulses in quantum optics [21]. It was shown that if the source and the absorber have the same resonant frequency and the same linewidth, the transmitted probability amplitude is $b(T, \tau) = \exp(-i\omega_0\tau)b_0(T, \tau)$, where

$$b_0(T, \tau) = e^{-\Delta_{\text{ph}}\tau} J_0 \left(2\sqrt{T\Delta_{\text{ph}}\tau} \right) \Theta(\tau), \quad (4)$$

is the time envelope normalized to 1 for $T = 0$ and $\tau = 0$, $\tau = t - l/c$ is the local time, l is the physical length of the macroscopic absorber, $T = \alpha_0 l/\gamma$ is its effective thickness, $J_0(x)$ is the zero-order Bessel function, and $\Theta(\tau)$ is the Heaviside step function. In the definition of T the parameter α_0 is the resonant absorption coefficient defined such that $2\alpha_0/\gamma$ is Beer's constant, where γ is the halfwidth of the absorption line for the absorber. For this particular case we take $\gamma = \Delta_{\text{ph}}$. The incident probability amplitude is assumed to be unity at the front face of the absorber ($l = 0$) for $t = 0$. According to Eq. (4) the probability amplitude of the photon leaving a very thick sample ($T \gg 1$) in the forward direction is also close to unity for the leading pulse edge $\tau \approx 0$, the tail of the field being strongly absorbed and displaying an oscillatory behavior. This was experimentally detected for gamma photons in [15, 16, 17, 18, 19]. The process was called speed-up of the initial decay and dynamical beat for longer times (see, for example, the review [22]). Thus, the amplitude damping of the

output radiation with increase of l (or T) does not follow Beer's law and the time integrated intensity of this field decreases as $(2\pi T)^{-1/2}$ [21] instead of exponential decrease e^{-2T} . This is consistent with absorption in frequency domain of gamma quanta in a thick resonant absorber, which is calculated for a radiation source with a Lorentzian power spectrum [23].

We argue below that the lack of absorption at $\tau \approx 0$ results from the stepwise form of the initial part of the probability amplitude, i.e., it results from causality. In a cascade emission of two photons, the time at which the intermediate excited state e of the source particle is populated is known by detecting the first photon. From then on, and not earlier, the second photon can be emitted. Implicit in this scheme is the assumption that the emission of the first photon projects the atom into the intermediate level with absolute certainty. In quantum mechanical language, we project the two-photon state (produced in an atomic or nuclear cascade) onto a single photon state by detecting the first photon. This detection (the measurement) introduces a broad part to the otherwise narrow spectrum of the second photon characterized by the lifetime of the intermediate level $\tau_{\text{ph}}/2$. A similar process in the photon gun of the first kind, i.e., the pumping of a single particle by a short laser pulse to the upper state followed by fast nonradiative decay to a fluorescent state, introduces a broad part to the spectrum of a single photon emitted in free space vacuum modes. This is the price paid for pulling the trigger at a desired time, i.e., for the knowledge of the time at which the excited state is populated. The time distribution of the detection probability of the photon emitted by the photon gun of the first kind looks similar to that observed by TDCM of photons emitted in an atomic or nuclear cascade (compare, for example, the plots for the photon probability presented in [3] and [14, 15]).

III. SPECTRALLY NARROW AND BROAD PARTS OF A SINGLE PHOTON EMITTED BY A SINGLE PARTICLE IN FREE SPACE VACUUM MODES

In this section we give a brief outline of the methods used to treat the propagation of a single photon in a resonant absorber and introduce a decomposition of the photon spectrum (produced by a single particle in free space) in two components, one being a narrow and the other being broad.

For simplicity we consider the probability amplitude of the emitted photon $b(t) = b_0(t) \exp(-i\omega_0 t)$ normalized as $b_0(t) = \exp(-\Delta_{\text{ph}} t) \Theta(t)$. The propagation of a single photon

in a thick absorber consisting of particles with the same resonant frequency ω_0 and the same lifetime of the excited state as in the emitter is described by [15, 20, 21]

$$b_0(l, t) = \frac{1}{2\pi} \int_{-\infty}^{+\infty} b_0(0, \nu) e^{-i\nu(t-l/c) - A_{eg}(\nu)l} d\nu, \quad (5)$$

where

$$b_0(0, \nu) = \frac{1}{\Delta_{ph} - i\nu} \quad (6)$$

is the Fourier transform of the incident photon $b_0(t)$ at the input $l = 0$ and

$$A_{eg}(\nu) = \frac{\alpha_0}{\gamma - i\nu} \quad (7)$$

is the complex spectral function of the absorber. Here γ is a half width of the absorption line of the individual particle and according to the imposed condition we have $\gamma = \Delta_{ph}$. The parameter $\alpha_0 = 2\pi N_c \mu^2 \omega_0 / nc$, defined in the previous section, contains the concentration N_c of the resonant particles in the absorber, the refractive index n of the host in which these particles are incorporated, and the matrix element μ of the radiative transition $e - g$. The expression (5) was derived quantum mechanically by Harris [20], who considered three-dimensional resonant multiple scattering of a gamma photon in the forward direction by nuclei residing in a solid without regular structure of their positions. The same expression, Eq. (5), also follows from the semiclassical approach considering the frequency dependence of the complex dielectric constant of the absorber [15]. Solving the Maxwell-Bloch equations for a small amplitude pulse with envelope $b_0(t) = \exp(-\Delta_{ph}t)\Theta(t)$ also gives the same result [21]. It was shown in Refs. [15, 20, 21] that performing the integral in Eq. (5) leads to Eq. (4).

To clarify the meaning of Eq. (4), we formally represent the Fourier transform of the single photon field, Eq. (6), as $b_0(0, \nu) = b_s(0, \nu) + b_a(0, \nu)$, where

$$b_s(0, \nu) = \frac{\Delta_{ph}}{\Delta_{ph}^2 + \nu^2}, \quad (8)$$

$$b_a(0, \nu) = \frac{i\nu}{\Delta_{ph}^2 + \nu^2}, \quad (9)$$

are symmetric and antisymmetric parts, respectively. The former has a Lorentzian shape and the latter resembles the dispersion part of the atomic response function. Their time domain counterparts are

$$b_s(0, t) = \frac{1}{2} \exp(-\Delta_{ph} |t|), \quad (10)$$

$$b_a(0, t) = \begin{cases} \frac{1}{2} \exp(-\Delta_{\text{ph}} t) & \text{if } t > 0, \\ 0 & \text{if } t = 0, \\ -\frac{1}{2} \exp(\Delta_{\text{ph}} t) & \text{if } t < 0. \end{cases} \quad (11)$$

The time dependence of $b_s(0, t)$ and $b_a(0, t)$ is shown in Fig. 2 by the dashed lines. We calculated the transmission of these components through a thick resonant absorber at the same conditions as for $b_0(T, t)$ with the help of Eq. (5), where the absorber length l is substituted by its effective thickness $T = \alpha_0 l / \gamma$ and $b_0(0, \nu)$ is substituted by $b_s(0, \nu)$ or $b_a(0, \nu)$. The result is

$$b_s(T, \tau) = \begin{cases} \frac{1}{2} e^{-\Delta_{\text{ph}} \tau} F_-(T, \tau) & \text{if } \tau \geq 0, \\ \frac{1}{2} e^{\Delta_{\text{ph}} \tau - T/2} & \text{if } \tau < 0, \end{cases} \quad (12)$$

$$b_a(T, \tau) = \begin{cases} \frac{1}{2} e^{-\Delta_{\text{ph}} \tau} F_+(T, \tau) & \text{if } \tau > 0, \\ \frac{1}{2} (1 - e^{-T/2}) & \text{if } \tau = 0, \\ -\frac{1}{2} e^{\Delta_{\text{ph}} \tau - T/2} & \text{if } \tau < 0, \end{cases} \quad (13)$$

where

$$F_{\pm}(T, \tau) = J_0(2\sqrt{T\Delta_{\text{ph}}\tau}) \pm \frac{1}{2} \int_0^T e^{-(T-x)/2} J_0(2\sqrt{x\Delta_{\text{ph}}\tau}) dx, \quad (14)$$

and $\tau = t - l/c$ is the local time at the output of the absorber of the physical length l . From these expressions one can find that for $\tau = \pm 0$ the probability amplitudes take values $b_s(T, \pm 0) = \exp(-T/2)/2$, $b_a(T, -0) = -\exp(-T/2)/2$, which are much smaller than 1 for large thickness ($T \gg 1$), and $b_a(T, +0) = 1 - \exp(-T/2)/2$, which is almost equal to the probability amplitude of the input radiation. For longer times ($\tau > 0$), the behavior of the probability amplitude of the antisymmetric part $b_a(T, \tau)$ is close to the total amplitude $b_0(T, \tau)$, Eq. (4). The time evolution of the output probability amplitudes $b_s(T, \tau)$ and $b_a(T, \tau)$ for $T = 10$ is shown in Fig. 2 by the solid lines, (a) and (b) respectively. These plots clearly demonstrate that at the output of a thick sample the probability amplitude of the antisymmetric part becomes very close to the total probability amplitude of a single photon $b_0(T, \tau)$. We may conclude, that the narrow spectrum part of the photon is strongly absorbed in a thick sample while the broad component partially passes through and it defines the probability amplitude of the output radiation. The slight deviation of $b_a(T, \tau)$ from $b_0(T, \tau)$ is due to the reduced absorption of the far wings of the symmetric part of the photon spectrum in the case of $\Delta_{\text{ph}} = \gamma$. Its time domain counterpart $b_s(T, \tau)$ shows an

oscillatory deviation from the exponential behavior $\exp(-\Delta_{\text{ph}} |\tau| - T/2)/2$ for $\tau > 0$. To be convinced that this deviation is due to the reduced absorption of the wings of the symmetric part of the photon spectrum, we consider the photon propagation through a medium with particles whose absorption line Γ is much broader than the spectral width of the input photon Δ_{ph} . In this case we expect that the contribution of the symmetric part to the total output amplitude $b_0(T, \tau)$ is negligible since it must be strongly absorbed.

In Ref. [21] it was shown that if, for example, we have inhomogeneous broadening of the absorption line in a macroscopic absorber, the output radiation field is described by Eq. (5) where the spectral function $A_{eg}(\nu)$ is substituted by

$$A_{\Gamma}(\nu) = \frac{\alpha_0}{\Gamma - i\nu} \quad (15)$$

with a total halfwidth $\Gamma = \gamma + \gamma_{inh}$, where γ_{inh} is inhomogeneous halfwidth. Generally, with the help of the linear response approximation, one can derive the same expression for a weak radiation field transmitted through a resonant absorber having an absorption halfwidth Γ (natural, homogeneously or inhomogeneously broadened by the neighbors of the resonant particles in the absorber), which is different from the spectral halfwidth of the incoming radiation Δ_{ph} ($\Delta_{\text{ph}} \ll \Gamma$). We calculated the transmission of the probability amplitudes of the symmetric and antisymmetric parts of incoming radiation for such a sample with spectral function $A_{\Gamma}(\nu)$. The result is

$$b_s(l, \tau) = \begin{cases} \frac{1}{2}e^{-\Delta_{\text{ph}}\tau - T_-} + f_-(l, \tau) & \text{if } \tau \geq 0, \\ \frac{1}{2}e^{\Delta_{\text{ph}}\tau - T_+} & \text{if } \tau < 0, \end{cases} \quad (16)$$

$$b_a(l, \tau) = \begin{cases} \frac{1}{2}e^{-\Delta_{\text{ph}}\tau - T_-} + f_+(l, \tau) & \text{if } \tau > 0, \\ \frac{1}{2}(1 - e^{-T_+}) & \text{if } \tau = 0, \\ -\frac{1}{2}e^{\Delta_{\text{ph}}\tau - T_+} & \text{if } \tau < 0, \end{cases} \quad (17)$$

where

$$f_{\pm}(l, \tau) = \frac{e^{-\Gamma\tau}}{2} [g(T_-, \tau) \pm g(T_+, \tau)], \quad (18)$$

$$g(T_{\pm}, \tau) = \int_0^{T_{\pm}} e^{-(T_{\pm}-x)} J_0(2\sqrt{x(\Gamma \pm \Delta_{\text{ph}})\tau}) dx. \quad (19)$$

Here $T_{\pm} = \alpha_0 l / (\Gamma \pm \Delta_{\text{ph}})$ is the effective thickness of the absorber. Formally, with the decrease of Δ_{ph} ($\Delta_{\text{ph}} \rightarrow 0$) the function $f_-(l, \tau)$ in the solution $b_s(l, \tau)$ tends to zero since

its components $g(T_+, \tau)$ and $g(T_-, \tau)$ nearly cancel each other. However, their difference is larger than the first term $(1/2) \exp(-\Delta_{\text{ph}}\tau - T_-)$ in $b_s(l, \tau)$ for $\tau > 0$, and, hence, we have residual oscillations of the symmetric part of the photon amplitude for $\tau > 0$. In spite of this, for $\tau > 0$, it is the antisymmetric part $b_a(l, \tau)$ that gives the dominant contribution to the total probability amplitude of the output photon. This amplitude, $b_0(l, \tau)$, can be approximated by the two main terms obtained from the successive integration by parts of the integrals in Eqs. (16),(17), which are

$$b_0(l, \tau) = e^{-\Gamma\tau} \left[J_0(2\sqrt{\alpha_0 l \tau}) + (\Gamma - \Delta_{\text{ph}})\tau \frac{J_1(2\sqrt{\alpha_0 l \tau})}{\sqrt{\alpha_0 l \tau}} \right] \Theta(\tau). \quad (20)$$

$J_1(x)$ is the Bessel function of the first order. It is remarkable that the first and also main term of this expression does not depend on the spectral width Δ_{ph} of the incoming photon. Thus, for $\Delta_{\text{ph}} \ll \Gamma$ the amplitude of the output radiation is mainly defined by the parameters of the sample and not those characterizing the input photon.

The symmetric part of the input photon spectrum has a Lorentzian shape with halfwidth Δ_{ph} that is narrow with respect to the absorption linewidth, i.e., $\Delta_{\text{ph}} \ll \Gamma$. Therefore, this part is strongly absorbed in a thick sample. The antisymmetric part partially passes through a thick sample and what comes out is due to the far wings of $b_a(0, \nu)$, which are proportional to $1/\nu$ and independent on Δ_{ph} . This is the reason why the output radiation does not contain information about Δ_{ph} . Therefore, formally we refer to this part of the photon spectrum as broad. Fig. 3(a) shows a comparison of the time dependence of the antisymmetric part $b_a(l, \tau)$ with the numerically calculated integral (5) for the total amplitude $b_0(l, \tau)$, where the spectral function is $A_\Gamma(\nu)$. These plots show that the probability amplitude of the output radiation essentially coincides with the probability amplitude of the antisymmetric part $b_a(l, \tau)$, confirming the heuristic argument that the symmetric part is strongly absorbed.

Another argument supporting the concept of the broad spectrum component of the photon can be given with the help of the time integrated intensity of the output radiation. For a classical field, the total energy transmitted through a unit area at distance l is proportional to

$$U(l) = \int_{-\infty}^{+\infty} b(l, \tau) b^*(l, \tau) d\tau. \quad (21)$$

For a single photon, this value is actually proportional to the number of counts of the second detector in a wide time window obtained without TDCM, i.e., without the first detector in

the scheme Fig. 1(b). Eq. (21) can be transformed as

$$U(l) = \frac{1}{2\pi} \int_{-\infty}^{+\infty} b(l, \nu) b^*(l, \nu) d\nu, \quad (22)$$

where $b(l, \nu) = b(0, \nu) \exp[-A_m(\nu)l]$ and $A_m(\nu)$ is $A_{eg}(\nu)$ or $A_\Gamma(\nu)$.

In the case of a macroscopic absorber with a narrow spectral function $A_{eg}(\nu)$ of halfwidth Δ_{ph} , we have for the symmetric, $b_s(l, \nu)$, and antisymmetric, $b_a(l, \nu)$, parts of the output photon:

$$U_s(T) = e^{-T} [I_0(T) - I_1(T)] U_0(0)/2, \quad (23)$$

$$U_a(T) = e^{-T} [I_0(T) + I_1(T)] U_0(0)/2, \quad (24)$$

where $U_0(0) = \tau_{\text{ph}}/2$ is the time integrated intensity of the input field $b_0(0, \tau)$, $T = \alpha_0 l / \Delta_{\text{ph}}$, $I_0(T)$ and $I_1(T)$ are the modified Bessel functions of zero and first order, respectively. For the time integrated intensity of the total field $b_0(l, \nu) = b_s(l, \nu) + b_a(l, \nu)$, we have the expression $U_0(T) = U_s(T) + U_a(T)$, which is consistent with $U_0(T) = \exp(-T) I_0(T) U_0(0)$ found in Ref. [21].

For an absorber with a broad spectral function $A_\Gamma(\nu)$ with a halfwidth $\Gamma > \Delta_{\text{ph}}$, we have

$$U_s(T_b) = U_+(T_b) - \left(\frac{\Delta_{\text{ph}}}{\Gamma} \right)^3 [U_1(T_b) - U_2(T_b)], \quad (25)$$

$$U_a(T_b) = U_-(T_b) + \frac{\Delta_{\text{ph}}}{\Gamma} U_1(T_b) - \left(\frac{\Delta_{\text{ph}}}{\Gamma} \right)^3 U_2(T_b), \quad (26)$$

where

$$U_\pm(T_b) = e^{-2aT_b} \left[1 \pm 4a^2 \left(\frac{\Delta_{\text{ph}}}{\Gamma} \right)^2 T_b \right] \frac{U_0(0)}{2}, \quad (27)$$

$$U_1(T_b) = 2a^2 U_0(0) \int_0^{T_b} e^{-2a(T_b-x)-x} I_0(x) dx, \quad (28)$$

$$U_2(T_b) = 4a^3 U_0(0) \int_0^{T_b} (T_b - x) e^{-2a(T_b-x)-x} I_0(x) dx, \quad (29)$$

$a = \Gamma^2 / (\Gamma^2 - \Delta_{\text{ph}}^2)$ and $T_b = \alpha_0 l / \Gamma$ is the effective thickness of the absorber at the center of the broad absorption line. Fig. 3(b) shows the thickness dependence of the time integrated intensity of the symmetric, $U_s(T_b)$, (dash-dot line) and antisymmetric, $U_a(T_b)$, (solid line) parts of a single photon. The antisymmetric part does not follow Beer's law, while the

symmetric part follows this law up to a certain thickness ($T_b \lesssim 5$) and its contribution to $U_0(T)$ becomes negligible for $T \gtrsim 1.5$. For an absorber with a narrow absorption line of a halfwidth Δ_{ph} , both parts (not shown on the plots) do not follow Beer's law for any distance and their T -dependence resembles that for $U_a(T_b)$ shown by thick solid line in Fig. 3(b).

If $A_m(\nu) = A_{eg}(\nu)$, Eq. (22) for $U(l)$ coincides with a formula for the transmission of gamma-photons through a thick absorber of length l (exact resonance case if the central frequency of the photon equals the resonant frequency of an absorber), well known in frequency domain Mössbauer spectroscopy [23]. This means that the Lorentzian power spectrum of gamma photons, adopted in the general formula [23], implies causality, since the relevant spectrum of the photon probability amplitude must satisfy Eq. (1) or Eq. (6), both assuming a time-asymmetric photon envelope. If the photon spectrum would be defined only by the symmetric part $b_s(0, \nu)$, Eq. (8), the power spectrum of such a photon is Lorentzian squared and all peculiarities mentioned above (violation of Beer's law etc.) would not be present.

Summarizing we conclude that the spectrum of the photon emitted in free space consists of two parts: a narrow and a broad part. The narrow part comes from the symmetric component $b_s(0, t)$ of the photon probability amplitude. The amplitude of this part decays with propagation distance and its absorption follows Beer's law in a medium with a wide absorption line. In a medium with a narrow absorption line, comparable with the spectral width of the symmetric part, this component is also strongly absorbed. But due to the reduced absorption of its far spectrum wings, the frequency integrated absorption of the symmetric component does not follow Beer's law. The antisymmetric part of the photon always violates Beer's law, its amplitude at $\tau = +0$ is nearly 1 for any thick absorber, then this part decays with the rate defined by the spectral width of the absorber and by its effective thickness.

In the next Section we propose to filter out the broad part of the photon spectrum with the help of electromagnetically induced transparency. The same mechanism can also reduce the intrinsic spectrum width of the source photon, i.e., the width of the narrow part.

IV. PHOTON FILTERING THROUGH THE EIT WINDOW

Electromagnetically induced transparency (EIT) allows transmission of the radiation field through a thick sample without absorption and with appreciable delay due to the reduced group velocity Ref. [24]. Recently it was shown that the EIT window allows also a separation of the narrow and broad components of the radiation field in time [25]. Here we apply these results to separate the narrow and broad components of a single photon emitted in free space. For simplicity we consider a resonant absorber described by a three-level scheme with a DC coupling field shown in Fig. 4. This scheme was experimentally realized for atomic hydrogen whose excited electron states $2p$ and $2s$ (degenerate in energy) are coupled by an electric DC field [26]. State $2s$ is a metastable state with a long lifetime. Therefore, the coupling creates a narrow transparency window at the center of the absorption line.

For a weak input radiation field being in exact resonance with $e - g$ transition, the output field from the absorber with EIT window is described by Eq. (5) with the spectral function $A_{eg}(\nu)$ replaced by [25]

$$A_{\text{eit}}(\nu) = \frac{\alpha_0(\gamma_m - i\nu)}{(\Gamma - i\nu)(\gamma_m - i\nu) + \Omega^2}, \quad (30)$$

where Γ is the halfwidth of the unperturbed absorption line for the transition from the ground state g to the excited state e , Ω is the coupling parameter defined by the strength of the DC field, which couples the excited state e with the metastable state m (see Fig. 4), and γ_m is the half decay rate of the metastable state m . The EIT hole is deep if the coupling parameter satisfies the condition $\Omega^2 \gg \gamma_m \Gamma$ and its halfwidth is approximately $\Delta_{\text{eit}} = \Omega^2/\Gamma$.

Following Ref. [25], we apply the adiabatic expansion of the spectral function $A_{\text{eit}}(\nu)$ near the center of the EIT hole, $\nu = 0$, for the approximate calculation of the integral in Eq. (5) describing the output photon probability amplitude. This method is valid if the EIT hole is present at the line center, i.e., if the condition $\Omega^2 \gtrsim \gamma_m \Gamma$ is satisfied. The method gives a nice approximation of the spectrally narrow, adiabatic part of the output radiation filtered through the EIT window in a thick absorber. The nonadiabatic, spectrally broad part of the output radiation will be treated separately, as in [25]. In the adiabatic expansion it is sufficient to retain the three main terms (see Section III in Ref. [25]):

$$A_{\text{eit}}(\nu)l \approx T_{\text{eit}} - i\nu t_d + \nu^2/\Delta_{\text{eff}}^2, \quad (31)$$

containing three important parameters of the EIT medium, i.e.,

$$T_{\text{eit}} = T_b \frac{\gamma_m \Gamma}{\Omega^2 + \gamma_m \Gamma}, \quad (32)$$

$$t_d = T_b \Gamma \frac{\Omega^2 - \gamma_m^2}{(\Omega^2 + \gamma_m \Gamma)^2}, \quad (33)$$

$$\Delta_{\text{eff}} = \sqrt{\frac{(\Omega^2 + \gamma_m \Gamma)^3}{T_b \Gamma [\Omega^2 (\Gamma + 2\gamma_m) - \gamma_m^3]}}. \quad (34)$$

The first parameter, T_{eit} , is the EIT reduced effective thickness of the absorber, which is defined by the residual absorption at the bottom of the EIT hole ($\nu = 0$). Here, we define the effective thickness T_b with respect to the absorption without the coupling Ω , i.e., $T_b = \alpha_0 l / \Gamma$. We have $T_{\text{eit}} / T_b \approx \gamma_m / \Delta_{\text{eit}} \ll 1$ if $\Omega^2 \gg \gamma_m \Gamma$. The second parameter, t_d , approximated as $t_d \approx T_b / \Delta_{\text{eit}}$, is the delay time of the radiation field associated with the slow group velocity $V_g = c / (1 + ct_d / l)$. It is defined by the slope of the steep dispersion at the center of the EIT window. The third parameter, Δ_{eff} , is the effective width of the EIT window for a thick sample, which narrows with distance as $\sim 1 / \sqrt{T_b}$. This parameter is approximated as $\Delta_{\text{eff}} \approx \Delta_{\text{eit}} / \sqrt{T_b}$ and it is responsible for the pulse broadening in time or its spectrum narrowing with distance. With $A_{\text{eit}}(\nu)$, given by Eq. (31), the integral in Eq.(5), which can be considered as the inverse Fourier transform, is calculated with the help of the convolution theorem. This gives an integral representation of the adiabatic solution for the probability amplitude of the output photon

$$b_{0A}(l, \tau) = \frac{\Delta_{\text{eff}}}{2\sqrt{\pi}} \int_{-\infty}^{+\infty} b_{01}(l, \tau_1 - t_d) e^{-\frac{1}{4}\Delta_{\text{eff}}^2(\tau - \tau_1)^2} d\tau_1. \quad (35)$$

The exponential part of the integrand takes into account the third term of the adiabatic expansion (Eq. (31)). The other part of the integrand, $b_{01}(l, \tau_1 - t_d) = b_0(0, \tau_1 - t_d) \exp(-T_{\text{eit}})$, is the probability amplitude obtained using only the first two terms of the adiabatic expansion, i.e., $A_{\text{eit}}(\nu)l \approx T_{\text{eit}} - i\nu t_d$. Explicitly this function is

$$b_{01}(l, \tau - t_d) = e^{-\Delta_{\text{ph}}(\tau - t_d) - T_{\text{eit}}} \Theta(\tau - t_d). \quad (36)$$

The integral in Eq. (35) can be calculated and gives

$$b_{0A}(l, \tau) = \phi_+(l, \tau) e^{-T_{\text{eit}} - \Delta_{\text{ph}}(\tau - t_d)}, \quad (37)$$

where

$$\phi_{\pm}(l, \tau) = \frac{1}{2} e^{\Delta_{\text{ph}}^2 / \Delta_{\text{eff}}^2} \left[1 \pm \operatorname{erf} \left(\frac{\Delta_{\text{eff}}}{2} (\tau - t_d) \mp \frac{\Delta_{\text{ph}}}{\Delta_{\text{eff}}} \right) \right], \quad (38)$$

$\operatorname{erf}(x)$ is the Error function, which is defined as an odd function, i.e., $\operatorname{erf}(-x) = -\operatorname{erf}(x)$. The function $\phi_{-}(l, \tau)$ will be used to describe the probability amplitude of the symmetric and antisymmetric parts of the photon.

If $\Delta_{\text{ph}} \ll \Delta_{\text{eff}}$, the function $\phi_{+}(l, \tau)$ is almost unity for $\tau \gg t_d + 2\Delta_{\text{eff}}^{-1}$, and it is almost zero if $\tau \ll t_d - 2\Delta_{\text{eff}}^{-1}$. In the transient domain, $t_d - 2\Delta_{\text{eff}}^{-1} \lesssim \tau \lesssim t_d + 2\Delta_{\text{eff}}^{-1}$, the function $\phi_{+}(l, \tau)$ gradually increases from 0 to 1. Fig. 5 shows the time dependence of the function $\phi_{+}(l, \tau)$ for $\Delta_{\text{ph}}/\Delta_{\text{eff}} = 0.1$ (solid line) and for $\Delta_{\text{ph}}/\Delta_{\text{eff}} = 0$ (dotted line). We see that if the spectral width of the narrow part of the photon, $2\Delta_{\text{ph}}$, is much smaller than the effective width, $2\Delta_{\text{eff}}$, of the EIT window for a thick sample ($T_b \gg 1$), the exponential tail of the delayed photon is almost not affected by the EIT hole, while the front edge is smoothed and spread around t_d in the domain $t_d - 2\Delta_{\text{eff}}^{-1} < \tau < t_d + 2\Delta_{\text{eff}}^{-1}$. Thus, the narrow part is not affected in this case while the broad part is filtered out. Actually the broad part is present in the output signal, but it is not delayed, as will be shown below.

If the spectral width of the narrow part of the photon is much larger than the transparency window, $\Delta_{\text{ph}} \gg \Delta_{\text{eff}}$, then the function $b_{01}(l, \tau_1 - t_d)$ in Eq. (35) can be approximated by a delta function, $\delta(\tau_1 - t_d)$, and its convolution with the Gaussian function is $b_{0A}(l, \tau) \sim \exp[-\frac{1}{4}\Delta_{\text{eff}}^2(\tau - t_d)^2]$. Thus, for $\Delta_{\text{ph}} \gg \Delta_{\text{eff}}$ the photon envelope will spread in time and narrow in spectrum acquiring a Gaussian shape with a temporal width $4/\Delta_{\text{eff}}$.

Such time-broadening of the pulse almost conserves its area

$$\theta_A(l) = \int_{-\infty}^{+\infty} 2\mu b_{0A}(l, \tau) dt = \theta_A(0) e^{-T_{\text{eit}}}, \quad (39)$$

whose value is affected only by the residual absorption defined by T_{eit} , which can be very small ($T_{\text{eit}} \ll 1$). Here $\theta_A(0) = 2\mu/\Delta_{\text{ph}}$ is the area of the input pulse $b_0(0, t)$. The pulse area is a quantitative parameter specifying the field interaction with a two-level atom. For example, the probability amplitudes of ground and excited states of a two-level atom interacting with a short resonant pulse (shorter than any relaxation time) are given by $\cos(\theta/2)$ and $i \sin(\theta/2)$ respectively, where θ is a pulse area [27].

The time integrated value of the pulse intensity $\sim |b_{0A}(l, \tau)|^2$, which is essentially the

average detection probability of the photon,

$$U_A(l) = \int_{-\infty}^{+\infty} |b_{0A}(l, \tau)|^2 d\tau \quad (40)$$

reduces with distance due to broadening of its envelope as

$$U_A(l) = U_0(0)e^{-2T_{\text{eit}} + 2\Delta_{\text{ph}}^2/\Delta_{\text{eff}}^2} \left[1 - \text{erf} \left(\sqrt{2}\Delta_{\text{ph}}/\Delta_{\text{eff}} \right) \right]. \quad (41)$$

If $\Delta_{\text{ph}} \ll \Delta_{\text{eff}}/\sqrt{2}$, the output energy does not change appreciably due to the pulse broadening in time. If $\Delta_{\text{ph}} \gg \Delta_{\text{eff}}/\sqrt{2}$, the energy is reduced by a factor that is the ratio of the EIT hole width and the spectral width of the photon $\sim \Delta_{\text{eff}}/\Delta_{\text{ph}}$.

So far, we have discussed the propagation of the adiabatic component of the probability amplitude of the photon whose spectrum is confined in the EIT window. This is the spectrally narrow part. The spectrally broad part is not sensitive to the narrow frequency domain of the absorption spectrum around $\nu = 0$, where the EIT hole is located. The time evolution of this spectrally broad part of the photon in a thick resonant absorber is mostly defined by the far wings of the absorption line, which decrease as $1/\nu^2$, and by the dispersion component, which drops even more slowly $\sim 1/\nu$. Therefore, to describe the propagation of the spectrally broad part we neglect in the function $A(\nu)$ the coupling Ω , which produces the EIT hole and does not affect the wings of the absorption line. Then, the broad, nonadiabatic component of the photon probability amplitude, $b_0(l, \tau)$, is governed by the integral (5) with the spectral function $A_{\Gamma}(\nu)$ given by Eq. (15).

We consider two cases. If $\Delta_{ph} = \Gamma$, we have the case of equal spectral widths of the incoming photon and of the absorption line for a single particle. Then the nonadiabatic broad part is $b_N(l, \tau) = b_{0N}(l, \tau) \exp(-i\omega_0\tau)$, where $b_{0N}(l, \tau)$ is described by Eq. (4). The second case corresponds to the situation where the photon spectral width is smaller than the absorption linewidth ($\Delta_{ph} < \Gamma$). Then $b_{0N}(l, \tau)$ is given by the sum of $b_s(l, \tau)$, Eq. (16), and $b_a(l, \tau)$, Eq. (17), or by the simplified expression (20). In both cases the output probability amplitude of the photon is the sum of the adiabatic (spectrally narrow) and non-adiabatic (spectrally broad) amplitudes

$$b_{\text{tot}}(l, \tau) = b_{0A}(l, \tau) + b_{0N}(l, \tau). \quad (42)$$

First we consider the case $\Delta_{\text{ph}} = \gamma_m$. Then the two terms, $\Delta_{\text{ph}}t_d$ and T_{eit} , are almost equal and they nearly cancel each other in Eq. (37), reducing the adiabatic part of the

photon amplitude $b_{0A}(l, \tau)$ to

$$b_{0A}(l, \tau) \approx \phi_+(l, \tau)e^{-\Delta_{\text{ph}}\tau}. \quad (43)$$

Figure 6(a) shows the time dependence of the photon probability amplitude $b_{\text{tot}}(l, \tau)$ (bold line). This is our analytical solution, Eq. (42). It coincides almost perfectly with the numerical evaluation of Eq. (5) with $A_{\text{eit}}(\nu)$, which is an exact expression. The effective thickness is taken as $T = 30$, the other parameters are $\Gamma = 10\gamma_m$ and $\Omega = 2\Gamma$. The probability amplitude of the photon at the same distance with no resonant absorber between the source and the detector, $b_0(0, \tau)$, is shown for comparison (thin line). The dashed line shows the probability amplitude $b_{01}(l, \tau - t_d)$, Eq. (36), which does not take into account the spectrum narrowing of the photon. The pulse area of $b_{01}(l, \tau - t_d)$ (the area under the dashed line) coincides with the area of the adiabatic part, $b_{0A}(l, \tau)$. Observing only the tail of the photon envelope, one cannot distinguish the delayed photon from the one that would reach the detector without absorber. However, the leading edge of the photon envelope is split in two parts. The non-adiabatic part is fast with a duration proportional to $1/(T_b\Gamma) = 1/(\alpha_0 l)$ and its amplitude equals unity at $\tau = 0$. This part originates from the spectrally broad component of the photon. The thicker the sample, the shorter this part will be. The adiabatic component is slow and propagates with group velocity V_g . Its leading edge is broadened in time from $\tau = t_d - 2\Delta_{\text{eff}}^{-1}$ to $\tau = t_d + 2\Delta_{\text{eff}}^{-1}$. The slow part of the photon does not change appreciably in shape except the smoothening of the leading edge. This is because for the chosen values of the parameters Γ , Ω , and T the effective width of the EIT hole is larger than the width of the photon spectrum, i.e., $\Delta_{\text{eff}} > \Delta_{\text{ph}}$. For our numerical example $\Delta_{\text{eff}}/\Delta_{\text{ph}} = 6.9$. The delay time of the photon, t_d , is 1.4 times longer than the lifetime of the excited state of the source particle $\tau_{\text{life}} = \tau_{\text{ph}}/2$.

Since $\Delta_{\text{eff}} \approx \Omega^2/\Gamma\sqrt{T_b}$, one can decrease the effective width of the hole and make it narrower than the spectral width of the photon, $\Delta_{\text{eff}} < \Delta_{\text{ph}}$, by reducing the coupling Ω or increasing the thickness l of the sample and hence increasing the effective thickness T_b . Then, it can be shown that the shape of the slow photon amplitude reduces to almost a Gaussian. However, its far tail for long times cannot decay more slowly than $\exp(-\gamma_m t)$. Thus, if $\Delta_{\text{ph}} = \gamma_m$ and an EIT hole is present, the far tail of the photon probability amplitude is always indistinguishable from the case without absorber. This is because the induced coherence of the states g and m has the same lifetime as the lifetime of the photon probability

amplitude, both being caused, for example, by the spontaneous decay of the excited (for the source) and metastable (for the absorber) states. The $g-m$ coherence (i.e., an antisymmetric superposition of states g and m) is at the origin of destructive interference. It can be shown that this coherence reduces the absorption and as such supports the photon propagation without absorption.

The indistinguishability of the tails of the slow photon and a photon that does not propagate through an absorber can be removed if $\Delta_{\text{ph}} \gg \gamma$. In this case the slow part of the photon envelope transforms to an almost Gaussian shape. Most part of its amplitude exceeds the probability amplitude of the photon propagating without absorber. The area under its envelope coincides with the area of $b_{01}(l, \tau - t_d)$, i.e., with $\theta_A(l)$ given by Eq. (39). Fig. 6(b) shows the time dependence of the photon probability amplitude $b_{\text{tot}}(l, \tau)$ if $\Delta_{\text{ph}} = \Gamma$ (bold line). The other parameters are the same as for Fig. 6(a). Comparing the fast, nonadiabatic parts of the probability amplitudes in Fig. 6(a) and 6(b), we find that they are almost the same in spite of the difference of the halfwidth of the photon spectrum for (a) and (b), being γ_m and Γ , respectively. This is because the spectrally broad component of the photon, responsible for the nonadiabatic contribution, originates from the stepwise rise of the photon probability amplitude at $t = 0$ and does not depend on the spectral width of the radiation source.

Concluding this section we analyze the evolution of the symmetric and antisymmetric components of the photon spectrum with distance in the EIT medium. Their adiabatic $b_{s(A)}(l, \tau)$, $b_{a(A)}(l, \tau)$ and nonadiabatic $b_{s(N)}(l, \tau)$, $b_{a(N)}(l, \tau)$ counterparts can be calculated similarly to $b_{0A}(l, \tau)$ and $b_{0N}(l, \tau)$. Applying the same procedure as before we obtain

$$b_{s,a(\text{tot})}(l, \tau) = b_{s,a(A)}(l, \tau) + b_{s,a(N)}(l, \tau), \quad (44)$$

where the adiabatic symmetric $b_{s(A)}(l, \tau)$ and antisymmetric $b_{a(A)}(l, \tau)$ counterparts are

$$b_{s(A)}(l, \tau) = [R_+(l, \tau) + R_-(l, \tau)] / 2, \quad (45)$$

$$b_{a(A)}(l, \tau) = [R_+(l, \tau) - R_-(l, \tau)] / 2. \quad (46)$$

The function $R_{\pm}(l, \tau)$ is defined as

$$R_{\pm}(l, \tau) = \phi_{\pm}(l, \tau) \exp[-T_{\text{eit}} \mp \Delta_{\text{ph}}(\tau - t_d)]. \quad (47)$$

The nonadiabatic parts $b_{s(N)}(l, \tau)$, $b_{a(N)}(l, \tau)$ are calculated in Sec. III. They are defined by the output field for the symmetric $b_s(l, \tau)$ and antisymmetric $b_a(l, \tau)$ components given by Eqs. (12),(13) for $\Delta_{\text{ph}} = \Gamma$ and by Eqs. (16),(17) for $\Delta_{\text{ph}} = \gamma_m$. For the latter case, γ is substituted by γ_m in Eqs. (16),(17). Fig. 7 shows the time dependence of the symmetric (a) and antisymmetric (b) components of the photon probability amplitudes with a narrow spectrum, $\Delta_{\text{ph}} = \gamma_m$. These plots clearly demonstrate that the broad component of the photon spectrum is present only in the antisymmetric time domain counterpart. Both counterparts are delayed due to the reduced group velocity and they are smoothed. The discontinuities in the time dependence of the time derivative for the symmetric part and of the amplitude for the antisymmetric part are removed.

V. APPLICATION OF THE EIT FILTERING

The construction of a quantum network, consisting of quantum nodes and interconnecting channels, is a challenge in quantum communication and computation science. It is natural to use as nodes matter in the form of individual atoms or atomic ensembles. Storage of a quantum state of light in an EIT medium [28] or in an extended ensemble of atoms with the photon-echo technique [29] looks very attractive. The experimental realization of such protocols with a classical radiation field [30] and faint laser pulses imitating a single photon radiation field [31] showed the feasibility of storing and retrieval of a radiation field and demonstrated a delayed self-interference for a single photon wave packet in matter. If a single photon source of the first kind is used in these protocols, the fidelity of the mapping of a quantum state of light to matter can be quite low. To show this we introduce two quantum states

$$|b_s\rangle = -i\sqrt{2} \sum_{\mathbf{k}} g_{\mathbf{k}} \frac{\Delta_{ph} \exp(-i\mathbf{k} \cdot \mathbf{r}_0)}{\nu_k^2 + \Delta_{ph}^2} |1_{\mathbf{k}}\rangle, \quad (48)$$

and

$$|b_a\rangle = \sqrt{2} \sum_{\mathbf{k}} g_{\mathbf{k}} \frac{\nu_k \exp(-i\mathbf{k} \cdot \mathbf{r}_0)}{\nu_k^2 + \Delta_{ph}^2} |1_{\mathbf{k}}\rangle, \quad (49)$$

which correspond to the symmetric and antisymmetric parts of the photon emitted in free space. The states are orthogonal and normalized: $\langle b_s | b_s \rangle = \langle b_a | b_a \rangle = 1$; $\langle b_a | b_s \rangle = 0$. This can be easily verified taking into account that the Fock states $|1_{\mathbf{k}}\rangle$ are orthogonal and the sum over \mathbf{k} is replaced by an integral over all frequency modes. The orthogonality of the

states comes from the fact that the symmetric part of a photon, $|b_s\rangle$, is an even function of ν_k while the antisymmetric part, $|b_a\rangle$, is an odd function of ν_k .

Formally we can represent the radiation state $|b\rangle$, emitted by a single quantum particle in free space, [see Eq. (1) in Sec. II] as

$$|b\rangle = \frac{1}{\sqrt{2}} |b_s\rangle + \frac{1}{\sqrt{2}} |b_a\rangle. \quad (50)$$

Such an expression allows us to make a strong statement about a single photon interacting with a single atom or an ensemble of atoms. First, it is evident that the photon emitted by a single particle populates equally both states, $|b_s\rangle$ and $|b_a\rangle$. In Sec. III, we showed that the symmetric, $|b_s\rangle$, and antisymmetric, $|b_a\rangle$, parts of the radiation field interact differently with resonant atoms (quantum absorbers in general). The antisymmetric part almost does not interact with an atom while the symmetric part does. Also, it is known (see, for example, Ref. [27]) that the probability of excitation of an atom by a radiation field with a temporal duration much shorter than the decay time of the atomic coherence is defined by the pulse area. This area is zero for the antisymmetric part of the photon and it has a finite value for the symmetric part. Thus, a photon emitted by a photon gun of the first kind has only a 50% chance to interact with a target atom and 50% chance to miss the target atom. Such a poor score would make the use of a single photon source of the first kind in quantum computing or information storage unreliable. An experimentalist performing a measurement cannot distinguish whether missing a target is the result of quantum statistics (i.e., the result of a small interaction probability) or a purely quantum mechanical result originating from causality (i.e., the result of pulling the trigger, which leads to populating the noninteracting state $|b_a\rangle$). Therefore, a qubit preparation in the form of matter excitation or any other operation with such a qubit using a single photon source of the first kind would become very uncertain and hence unreliable.

However, filtering a single photon through an EIT window may help to make it much more reliable for quantum computing and information storage. At the output of a thick EIT filter, the broadband, $|b_a\rangle$, and narrowband, $|b_s\rangle$, parts of the photon are well separated in time. The broadband part can be removed by time gating or a shutter and, for example, sent to an auxiliary channel. Then, the probability amplitude of the photon at the output of the EIT filter becomes bell-shaped (see Sec. IV). Sending the removed broadband part of the photon to a detector allows to purify the photon state. If the detector does not "click", all

probability amplitude is collected in a state that is a wave packet with a Gaussian envelope

$$|b_{filtered}\rangle \approx \sum_{\mathbf{k}} \frac{g_{\mathbf{k}}\Delta_{ph}}{\Delta_{ph}^2 + \nu_k^2} e^{-i\mathbf{k}\cdot\mathbf{r}_0 + i\nu_k t_d - \nu_k^2/\Delta_{eff}^2} |1_{\mathbf{k}}\rangle. \quad (51)$$

If it clicks, no photon with a Gaussian shape is present. Such a detector in a purification scheme can be omitted, since what comes out of the EIT filter with appropriate time gating is always the pure state (51). However, this auxiliary detector may help to conclude that the photon, emitted on demand, failed to pass through the EIT filter and we have to repeat the operation.

One could argue that filtering the radiation emitted by a single photon source reduces the total probability amplitude of the output photon while the interaction probability of such a photon with a target atom (or atoms) remains almost the same. So, what would be the gain and what would be the advantage of the EIT filtering? The gain comes from the removal of the broadband part, which does not interact with the target atom and hence produces a count at the detector placed behind the target. As such it is a false count carrying no information since the photon is assumed to be "stored" in the atom (atoms), but it escapes the atom-field interaction due to the $|b_a\rangle$ -component. Therefore, the false counts can be considered as noise in an information storage process. When applying filtering, this noise would reduce to zero, while with no filtering we have to compare the atom-field interaction probability with the quite high detection probability ($\sim 50\%$) given by the broad spectral component of the photon $|b_a\rangle$.

A further narrowing of the symmetric part of the photon in the case $\Delta_{ph} > \Delta_{eit}$ works in the same way. We lose the "brightness" of the source or the detection probability, but gain in spectral resolution. Actually we do not lose the "useful" energy if our aim is to improve the spectral resolution by sharpening the line associated to the source photon, i.e., to make it more selective in the excitation of a particular target atom. Selective excitation takes place if the spectral width of the source photon equals the spectral width of the absorption line of the selected atom and if their frequencies are in resonance. If our filter is designed such that these requirements for the output radiation are fulfilled, only the "useful" spectral content of the source photon is transmitted and the rest is suppressed. As a result, the target atom interacts with such a photon with the same probability as in the case of no filter and the "useful" brightness of the source does not change. Otherwise, with no filter the inherent broad part of the photon spectrum not interacting with the target atom (atoms)

would produce a click at the detector placed behind the target showing that the atom-field interaction failed to happen.

To conclude this section, we consider the interaction of a Gaussian shape photon with an ensemble of resonant atoms. We define the Gaussian wave packet as

$$|b_G\rangle = \sum_{\mathbf{k}} \frac{2\sqrt{\pi}g_{\mathbf{k}}}{\Delta_{ph}} e^{-i\mathbf{k}\cdot\mathbf{r}_0 - \nu_{\mathbf{k}}^2/\Delta_{ph}^2} |1_{\mathbf{k}}\rangle, \quad (52)$$

normalized such that it contains only one photon. The associated single photon field $b_G(t) = \langle 0| E^{(+)}(\mathbf{r}, t) |b_G\rangle$ is $b_G(0, t) = b_{0G}(0, t) \exp(-i\omega_0 t)$, where for simplicity its amplitude $b_{0G}(0, t) = \exp(-\Delta_{ph}^2 t^2/4)$ is normalized to unity for $t = 0$. The propagation of such a photon in a thick absorber consisting of particles with the same resonant frequency ω_0 is described by Eq. (5). We consider the case as in Sec. III, if the absorption line in the absorber is inhomogeneously broadened with half width Γ [see Eq. (15)]. To compare the absorption of a single photon emitted by a source of the first kind with that for a photon with a Gaussian envelope, we address the case of a narrow spectral width of a single photon: $\Delta_{ph} \ll \Gamma$. In this case the integral Eq.(5) for a photon with the Gaussian envelope, which describes its transmission through an absorptive medium, can be calculated expanding the function $A_{\Gamma}(\nu)$, Eq. (15), in a power series of ν near $\nu = 0$. Keeping only three terms of the expansion, we have

$$A_{TL}(\nu) \approx \frac{\alpha_0}{\Gamma} \left(1 + i\frac{\nu}{\Gamma} - \frac{\nu^2}{\Gamma^2} \right). \quad (53)$$

Then the integral is calculated analytically, i.e.,

$$b_0(T, \tau) \approx \eta \exp \left[-T - \eta^2 \Delta_{ph}^2 \left(\tau + \frac{T}{\Gamma} \right)^2 \right], \quad (54)$$

where $T = \alpha_0 l / \Gamma$, $\tau = t - l/c$ is the local time, $\eta = 1/\sqrt{1 - fT}$, and $f = (\Delta_{ph}/\Gamma)^2$. This approximation is valid if $fT < 1$. The transmission function for a Gaussian photon, $U_G(T)$, can be easily calculated

$$U(T) = \frac{\sqrt{\pi}\eta}{\Delta_{ph}} e^{-2T}. \quad (55)$$

For $\eta \sim 1$, the deviation from the Beer's law is negligible, which shows a strong atom-field interaction for such a photon. Thus, the state of a single photon with a Gaussian envelope can be mapped into an atomic ensemble. Recently, the mapping and retrieval of a classical field state in an ensemble of resonant impurities in a solid was experimentally demonstrated [32].

VI. LEVEL MIXING INDUCED TRANSPARENCY FOR GAMMA RADIATION

A similar analysis is applicable in the gamma domain, in particular to reexamine the recent level crossing experiments in ^{57}Fe [33, 34]. In these references by means of Mössbauer spectroscopy [23] the absorption of the 14.4 keV photons, emitted by a radioactive single line source ^{57}Co (CoRh), has been experimentally studied in the natural mineral siderite (FeCO_3) containing ^{57}Fe nuclei. At the crossing of two hyperfine levels $m_1 = -3/2$ and $m_2 = +1/2$ in the first excited state of ^{57}Fe [35], an appreciable deficit of gamma-photon absorption was found. The experiments were performed in frequency domain by Doppler shifting the frequency of the radiation source and detecting the 14.4 keV photon, which passed through a thick resonant absorber containing ^{57}Fe . One can expect that time domain experiments with TDCM could show a photon delay at the level crossing of ^{57}Fe . We assume that the fluctuating electron spin of Fe^{2+} in FeCO_3 is the dominant source of the line broadening for the transition $g - e$ in which the ground state level g is $m_g = -1/2$ and the excited state level e is $m_1 = -3/2$. Our assumption is also supported by studies in Ref. [36]. Meanwhile, the transition $g - m$, where m is the excited state level $m_2 = +1/2$ has mostly a natural broadening caused by spontaneous decay via the emission of a gamma photon (into 4π angle) or via electron conversion [36]. If the excited levels $m_1 = -3/2$ and $m_2 = +1/2$ are coupled by symmetry breaking interaction, then we have an EIT scheme with a coupling of two excited levels having different line broadening mechanisms, one is due to the electron spin fluctuations producing the linewidth 2Γ and the other due to natural broadening, $2\gamma_m$, so that $\Gamma > \gamma_m$. This EIT scheme will produce a slow photon shown in Fig. 6(a), where $\Delta_{\text{ph}} = \gamma_m$. Another possibility for EIT is to apply an rf mixing of two levels in the excited state of ^{57}Fe [37].

The group velocity of the single photon wave-packet can be reduced many times inside an absorber due to the steep dispersion in the EIT window. If the propagation time of a slow photon in the absorber is much longer than the mean dwell time between successive photons coming from the source, one can collect several photons in the sample and then release them when required by means of a sudden removal of all nuclei from resonance, producing a short burst of radiation.

VII. DISCUSSION

We have shown that a photon emitted by a single particle in free space contains spectrally narrow and broad components with equal probability amplitudes. The broad component has very low absorption in an ensemble of two-level absorbers or a single atom. Therefore, a mapping of the state of such a photon in the form of matter excitation has $\sim 50\%$ probability, which is low for any realistic protocol of quantum information storage and quantum computing. This is very different from what can be expected for a single photon with a Gaussian time-envelope, which demonstrates a high probability of atom-field interaction.

Filtering out the broad component of the photon with the help of an EIT medium may produce a single photon that is (i) spectrally narrow and (ii) of Gaussian shape (if $\Delta_{\text{ph}} > \Delta_{\text{eit}}$) in spite of an initially highly asymmetric time dependence of the probability amplitude of the photon coming from the source. Photon reshaping can be made at low cost in time and energy. The narrow and broad spectral components of the photon are separated in time and space because of different group velocities. The narrow part is broadened in time (or spectrally narrowed) and delayed, while the broad part transforms into a fast photon with a very short duration. The separation of these components, for example by time gating, may produce a photon with a much narrower spectrum, even with respect to the narrow part Δ_{ph} if $\Delta_{\text{ph}} > \Delta_{\text{eit}}$. The spectrum narrowing of the narrow part takes place without appreciable amplitude probability loss. This is because the time integrated probability amplitude of the photon, which is analogous to the classical pulse area, is conserved and is not affected by the spectrum narrowing of the photon. This area is just a parameter quantifying the atom-field interaction. However, the time integrated probability of the photon (its amplitude squared), which is analogous to the energy of a classical pulse, decreases inversely proportional to the square root of the effective thickness of the absorber. This decrease is much smaller than the value given by Beer's law for monochromatic radiation.

Recently, another type of single photon sources based on spontaneous Raman scattering of a laser field in an extended medium was reported [38]-[42]. They are designed to implement the DLCZ protocol [43] for long-distance quantum communication with atomic ensembles and linear optics. Spontaneous Raman scattering of a low intensity laser field in an extended ensemble of three-level atoms with states $|g\rangle$, $|s\rangle$, $|e\rangle$, is capable to produce a low intensity Stokes field in the forward direction with an average photon number smaller than unity. In

this protocol, the laser field is strongly detuned from the resonant transition $|g\rangle \rightarrow |e\rangle$ to insure low population of the excited state atoms, $|e\rangle$. If the atoms are initially prepared in the ground state $|g\rangle$, which the laser field excites, the spin-wave (coherence of the ground states $|g\rangle$ and $|s\rangle$ distributed wave-like in the ensemble of three-level atoms) is excited along with the scattering of one Raman photon into a wave packet propagating in the forward direction. This event is probabilistic and its success heralds the preparation of one quantum spin-wave excitation stored in the atomic ensemble. It also demands the same detuning of the Stokes photon from resonance as for the laser field such that the Raman resonance condition for the two-quantum process $|g\rangle \rightarrow |e\rangle \rightarrow |s\rangle$ is satisfied, i.e., the frequency difference of the laser field and the scattered radiation equals the frequency of the transition between the ground states $|g\rangle \rightarrow |s\rangle$. If the Raman resonance condition is not satisfied, with high probability no spin-wave but rather the population of the ground state $|s\rangle$ for a single atom (randomly localized spin excitation) in the atomic ensemble is produced after spontaneous Raman scattering on this atom with emission of a photon with a resonant frequency $\omega_{es} = (E_e - E_s)/\hbar$, where E_e and E_s are the energies of states $|e\rangle$ and $|s\rangle$. Therefore, this kind of a single photon source satisfying the Raman resonance condition needs a post-selection procedure. It implies the generation of pairs of single photons, Stokes and anti-Stokes. One photon of the pair (Stokes) is generated by the Raman scattering described above. The laser producing this photon is named a "write laser". It generates the photon and one quantum of the spin wave excitation. Another photon of the pair (anti-Stokes) is generated by a "read laser". Depending on the chosen scheme, it is applied to the transition $|s\rangle \rightarrow |e\rangle$ (in a three-level scheme) or $|s\rangle \rightarrow |e'\rangle$ (in a four-level scheme), where $|e'\rangle$ is an other excited state of the atom. The read laser generates an anti-Stokes photon in a two-quantum process $|s\rangle \rightarrow |e\rangle \rightarrow |g\rangle$ or $|s\rangle \rightarrow |e'\rangle \rightarrow |g\rangle$. Detection of a single anti-Stokes photon after the read laser pulse (post-selection) warrants the presence of a single quantum of a spin-wave created by the write pulse and the generation of a single photon state in the Stokes field satisfying the Raman resonance condition. To reduce two-photon scattering in the Stokes mode, the probability of a single photon emission, n , must be small ($n < 1$). Then the two-photon emission probability of the Stokes field becomes even smaller $\sim n^2$. In this way a correlated pair of single photon Stokes and anti-Stokes fields is created. Stokes field generation in an atomic ensemble has collectively enhanced the coupling to a certain optical mode due to many-atom interference effects [44]. This mode is defined by

Raman photon scattering into a wave packet propagating forward along the write laser field and it is supported by the spin-wave if the Raman resonance condition is satisfied. All Raman scattering trajectories of the Stokes photon interfere constructively in the forward direction. This is very similar to the enhancement of single photon scattering in the forward direction in an ensemble of two-level atoms considered in Sec. II of our paper. The difference comes from the spectral content of the produced photon. Due to the large detuning of the write laser pulse and the post-selection of the Stokes photon satisfying the Raman resonance condition, which warrants a single quantum spin-wave excitation, the time envelope of such a photon is completely defined by the spectral properties of the write pulse and not by the lifetime of the excited state $|e\rangle$. This was clearly shown for the Stokes photon with photon number $n < 1$ by Lukin's group in Ref. [40]. For $n > 1$, the spontaneous generation of the Stokes field changes to stimulated emission, introducing a time-asymmetry of the scattered field envelope. To reduce the spontaneous noise, it is important to work with the write laser producing a Stokes photon with $n \ll 1$ (for example, $n = 0.1 - 0.2$). In Refs. [41],[42] an additional phase matching condition $\mathbf{k}_w + \mathbf{k}_s = \mathbf{k}_r + \mathbf{k}_{as}$, where \mathbf{k}_w , \mathbf{k}_r are wave vectors of the write and read laser fields, and \mathbf{k}_s , \mathbf{k}_{as} are wave vectors of Stokes and anti-Stokes photons, respectively, is applied to make the axis of the write-read laser beams different from the axis of the scattered Stokes-anti-Stokes photons. Any Stokes photon that does not satisfy the condition of Raman resonance (or phase matching condition) and that, on the contrary, has the resonant frequency ω_{es} for the transition $e \rightarrow s$, will be spectrally broadened since it is produced due to spontaneous decay of the excited state $|e\rangle$ of a single particle, and not collectively. In our paper we show that such a photon or a photon produced by a single particle decaying in free space vacuum modes interacts differently with two- and three-level atoms. Therefore, the design of any quantum network should take into account the spectral properties of such a single photon and its interaction with atomic ensembles.

VIII. ACKNOWLEDGEMENTS

This work was supported by the FWO Vlaanderen, FNRS, and the IAP program of the Belgian government. R.N.S. also acknowledges support from Russian Fund for Basic

- [1] D. F. Walls, G. J. Milburn, *Quantum Optics* (Springer, Berlin, 1994).
- [2] T. Basché, W. E. Moerner, M. Orrit, H. Talon, *Phys. Rev. Lett.* **69**, 1516 (1992).
- [3] B. Lounis and W. E. Moerner, *Nature* **407**, 491 (2000).
- [4] C. Kurtsiefer *et al.*, *Phys. Rev. Lett.* **85**, 290 (2000); R. Brouri *et al.*, *Opt. Lett.* **25**, 1294 (2000); A. Beveratos *et al.*, *Phys. Rev. A* **64**, R061802 (2001).
- [5] J. Kim *et al.*, *Nature* **397**, 500 (1999); P. Michler *et al.*, *Science* **290**, 2282 (2000); Z. Yuan *et al.*, *Science* **295**, 102 (2002).
- [6] C. K. Law and J. H. Eberly, *Phys. Rev. Lett.* **76**, 1055 (1996).
- [7] C. K. Law and H. J. Kimble, *J. Mod. Opt.* **44**, 2067 (1997).
- [8] E. T. Jaynes and F. W. Cummings, *IEEE* **51**, 89 (1963); see also P. Meystre, *Progress in Optics* vol. 30, ed. E. Wolf (Amsterdam: Elsevier, 1982), p. 261.
- [9] M. Hennrich, T. Legero, A. Kuhn, and G. Rempe, *Phys. Rev. Lett.* **85**, 4872 (2000).
- [10] J. McKeever, A. Boca, A. D. Boozer, R. Miller, J. R. Buck, A. Kuzmich, H. J. Kimble, *Science* **303**, 1992 (2004).
- [11] M. Keller, B. Lange, K. Hayasaka, W. Lange, H. Walther, *Nature* **431**, 1075 (2004).
- [12] J. I. Cirac, P. Zoller, H. J. Kimble, and H. Mabuchi, *Phys. Rev. Lett.* **78**, 3221 (1997).
- [13] M. O. Scully and M. S. Zubairy, *Quantum Optics* (Cambridge, 1997), p. 208.
- [14] G. H. Nussbaum and F. M. Pipkin, *Phys. Rev. Lett.* **19**, 1089 (1967); R. A. Holt and F. M. Pipkin, *Phys. Rev. A* **9**, 581 (1974); E. S. Fry and R. C. Tompson, *Phys. Rev. Lett.* **37**, 465 (1976).
- [15] F. J. Lynch, R. E. Holland, and M. Hamermesh, *Phys. Rev.* **120**, 513 (1960).
- [16] N. Hayashi, T. Kinoshita, I. Sakamoto, and B. Furubayashi, *Nucl. Instrum. Methods* **134**, 317 (1976).
- [17] E. I. Vapirev, P. S. Kamenov, D. L. Balabansky, S. I. Ormadjiev, and K. Yanakiev, *Journal de Physique* **44**, 675 (1983).
- [18] M. Haas, V. Hizhnyakov, E. Realo, and J. Jögi, *Phys. Status Solidi* **B 149**, 283 (1988).
- [19] W. C. McDermott III and G. R. Hoy, *Hyp. Int.* **107**, 81 (1997).
- [20] S. M. Harris, *Phys. Rev.* **124**, 1178 (1961).

- [21] M. D. Crisp, *Phys. Rev. A* **1**, 1604 (1970).
- [22] U. van Bürck, *Hyperfine Interactions* **123/124**, 483 (1999).
- [23] A. Vértes, L. Korecz, and K. Burger, *Mössbauer Spectroscopy*, (Elsevier, New York 1979).
- [24] S. E. Harris, *Physics Today* **50** (7), 36 (1997).
- [25] R. N. Shakhmuratov and J. Odeurs, *Phys. Rev. A* **71**, 013819 (2005).
- [26] K. Hakuta, L. Marmet, and B. P. Stoicheff, *Phys. Rev. Lett.* **66**, 596 (1991).
- [27] L. Allen and J. H. Eberly, *Optical Resonance and Two-Level Atoms* (Wiley, New York, 1975).
- [28] M. Fleischhauer, and M. D. Lukin, *Phys. Rev. Lett.* **84**, 5094 (2000).
- [29] S. A. Moiseev and S. Kröll, *Phys. Rev. Lett.* **87**, 173601 (2001).
- [30] C. Liu, Z. Dutton, C. H. Behroozi, and L. V. Hau, *Nature* **409**, 490 (2001); D. F. Phillips *et al.*, *Phys. Rev. Lett.* **86**, 783 (2001); A. V. Turukhin *et al.*, *Phys. Rev. Lett.* **88**, 023602 (2001).
- [31] N. Ohlsson, M. Nilsson, and S. Kröll, *Phys. Rev. A* **68**, 063812 (2003).
- [32] A. L. Alexander, J. J. Longdell, M. J. Sellars, and N. B. Manson, *Phys. Rev. Lett.* **96**, 043602 (2006).
- [33] R. Coussement, Y. Rostovtsev, J. Odeurs, G. Neyens, H. Muramatsu, S. Gheysen, R. Callens, K. Vyvey, G. Kozyreff, P. Mandel, R. Shakhmuratov, and O. Kocharovskaya, *Phys. Rev. Lett.* **89**, 107601 (2002).
- [34] J. Odeurs, R. Coussement, K. Vyvey, H. Muramatsu, S. Gheysen, R. Callens, G. Neyens, I. Serdons, R. N. Shakhmuratov, Y. Rostovtsev, and O. Kocharovskaya, *Hyp. Int.* **143**, 97 (2002).
- [35] P. Boolchand, W. Bresser, G. Anaple, Y. Wu, R. N. Enzweiler, R. Coussement, J. Grover, *Phys. Rev. B* **50**, 6833 (1994).
- [36] H. N. Ok, *Phys. Rev.* **185**, 472 (1969).
- [37] R. N. Shakhmuratov and J. Odeurs, *Hyp. Int.* **135**, 215 (2001).
- [38] C. W. Chou, S. V. Polyakov, A. Kuzmich, and H. J. Kimble, *Phys. Rev. Lett.* **92**, 213601 (2004).
- [39] W. Jiang, C. Han, P. Xue, L.-M. Duan, and G.-C. Guo, *Phys. Rev. A* **69**, 043819 (2004).
- [40] M. D. Eisaman, L. Childress, A. André, F. Massou, A. S. Zibrov, and M. D. Lukin, *Phys. Rev. Lett.* **93**, 233602 (2004).
- [41] V. Balić, D. A. Braje, P. Kolchin, G. Y. Yin, and S. E. Harris, *Phys. Rev. Lett.* **94**, 183601

(2005).

- [42] T. Chanelière, D. N. Matsukevich, S. D. Jenkins, S.-Y. Lan, T. A. B. Kennedy, and A. Kuzmich, *Nature* **438**, 833 (2005).
- [43] L.-M. Duan, M. D. Lukin, J. I. Cirac, and P. Zoller, *Nature* 414, 413 (2001).
- [44] L.-M. Duan, J. I. Cirac, and P. Zoller, *Phys. Rev. A* **66**, 023818 (2002).

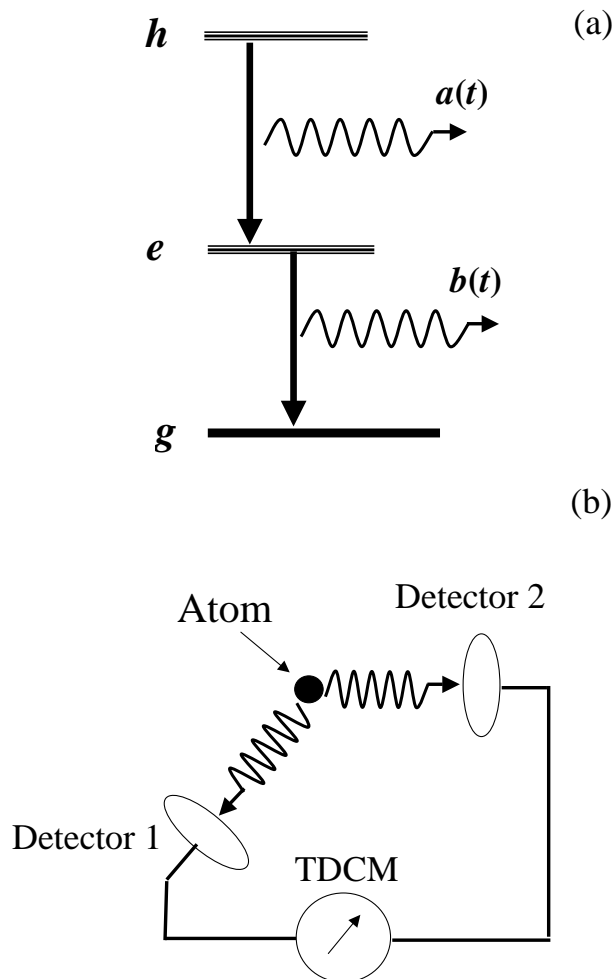

FIG. 1: (a) Decay scheme of the excited particle emitting photons $a(t)$ and $b(t)$ in the cascade $h \rightarrow e \rightarrow g$. (b) Detectors 1 and 2 detect photons $a(t)$ and $b(t)$, respectively. Detector 1 starts the clock when it detects a photon $a(t)$ and detector 2 stops the clock when the photon $b(t)$ is detected. The delay time between the two counts is stored and after many such events the detection probability of the photon $b(t)$ versus time is reconstructed.

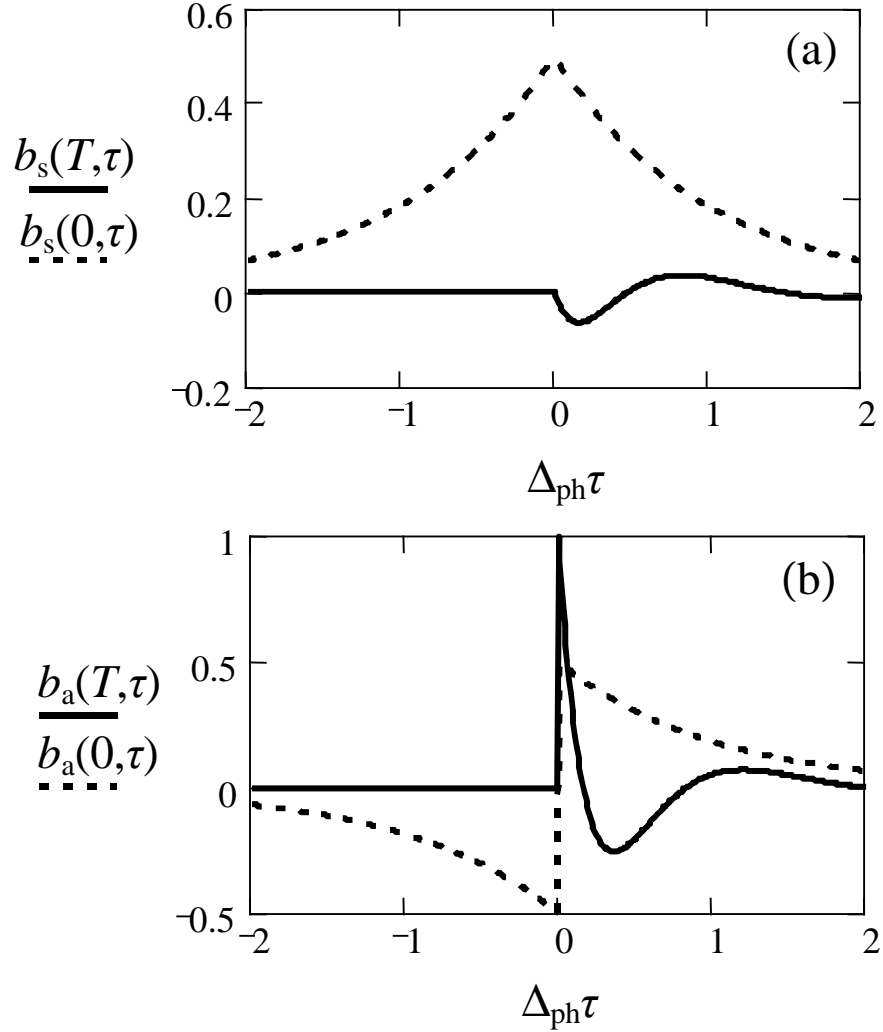

FIG. 2: Time dependence of the probability amplitude of a photon, which is formally presented as a sum of two parts. They are time domain counterparts of the symmetric and antisymmetric components of the photon spectrum (see the text). Plot (a) shows the time dependence of the symmetric component counterpart, and (b) - of the antisymmetric component. Dashed line: no absorber, but a photon is detected at distance l , so t is substituted by $\tau = t - l/c$. Solid line: with absorber of effective thickness $T = 10$.

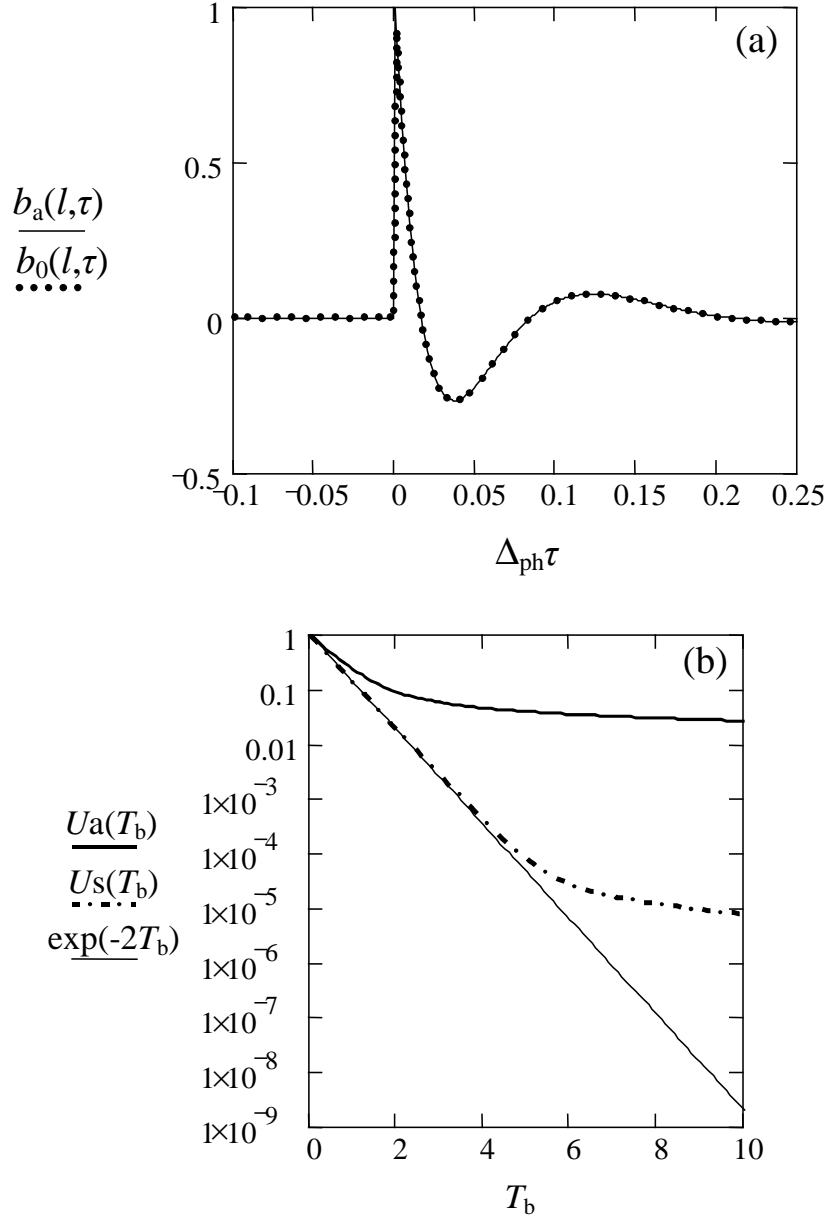

FIG. 3: (a) Time dependence of the probability amplitude of the photon (dots) and its antisymmetric part (solid line) at the output of a thick absorber with optical thickness $\alpha_0 l / \Gamma = 10$. (b) Thickness dependence of the time integrated intensity of the symmetric (dash-dot line) and antisymmetric (thick solid line) parts of the photon. Both are normalized to half of the time integrated intensity of the input photon $U_0(0)/2$. The thin solid line shows the limit of Beer's law $\exp(-2T_b)$.

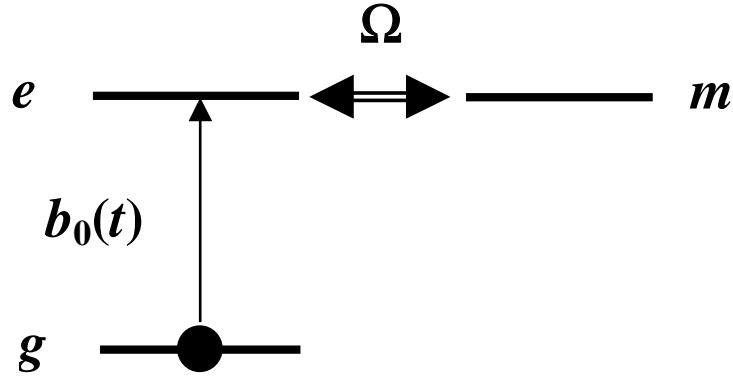

FIG. 4: Energy diagram of the absorber whose excited state e is coupled by Ω to a metastable state m . Initially the particle is in the ground state g and a photon excites the transition $g \rightarrow e$.

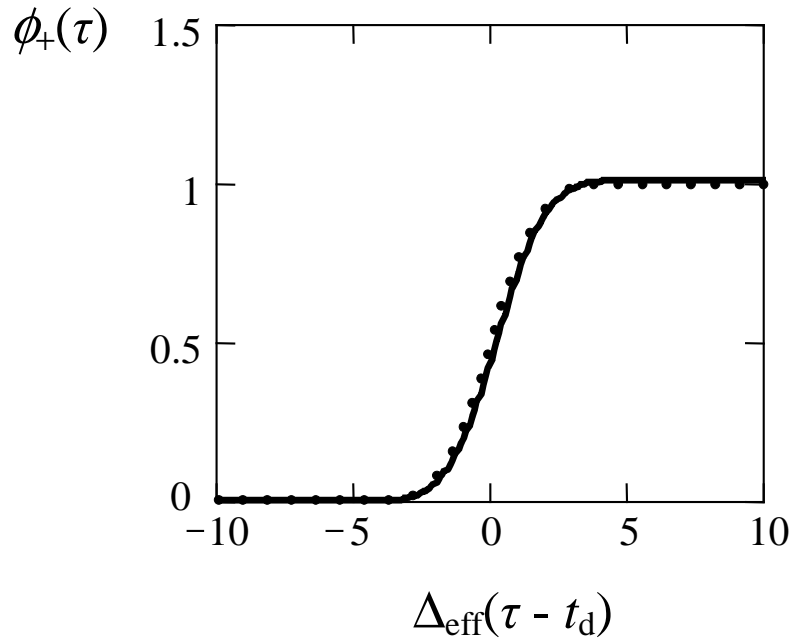

FIG. 5: Time dependence of the function $\phi_+(l, \tau)$ for $\Delta_{ph}/\Delta_{\text{eff}}$ equal to 0.1 (solid line) and 0 (dots).

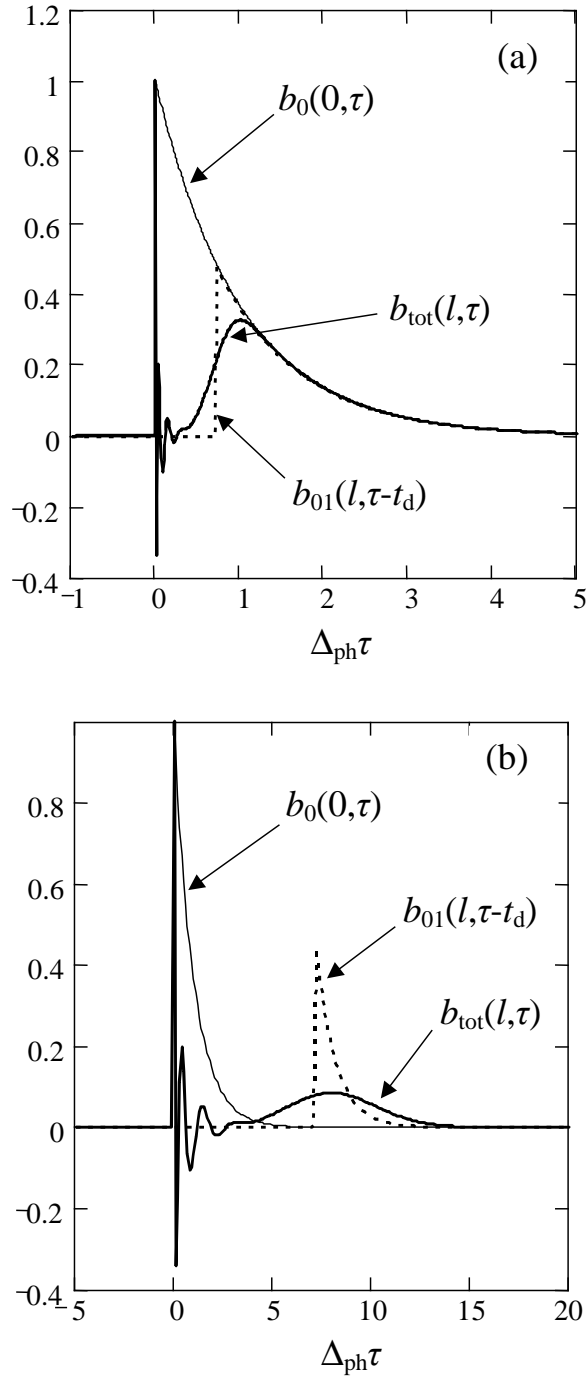

FIG. 6: Time evolution of the probability amplitude of the photon, $b_{\text{tot}}(l, \tau)$, transmitted through a sample of effective thickness $T_b = 30$ (bold line). The thin solid line shows the same evolution with no absorber, $b_0(0, \tau)$. The dashed line shows the probability amplitude, $b_{01}(l, \tau - t_d)$, which does not take into account the spectrum narrowing of the photon. The parameters of the absorber are $\Gamma = 10\gamma_m$ and $\Omega = 2\Gamma$. The spectral halfwidth of the photon Δ_{ph} is γ_m (a) and Γ (b).

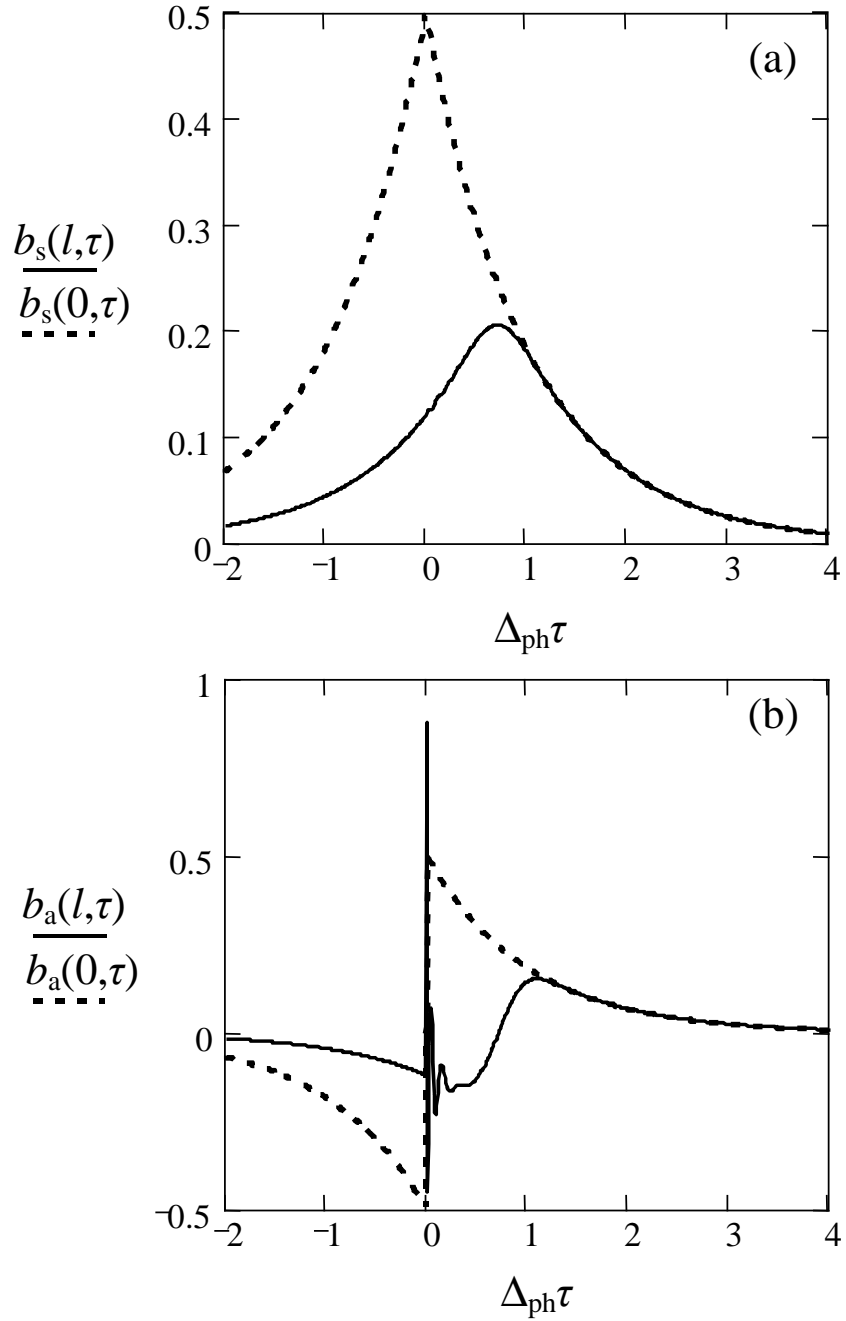

FIG. 7: Time evolution of the probability amplitudes of the symmetric (a) and antisymmetric (b) parts of the photon without absorber, $b_{s,a}(0, \tau)$ (dashed line), and with absorber of effective thickness $T_b = 30$, $b_{s,a}(l, \tau)$ (solid line). The parameters of the absorber and photon are the same as in Fig. 6(a).