

# The role of computation in complex regulatory networks

Pau Fernández<sup>1</sup> and Ricard V. Solé<sup>1,2</sup>

<sup>1</sup>*ICREA-Complex Systems Lab, Universitat Pompeu*

*Fabra (GRIB), Dr Aiguader 80, 08003 Barcelona, Spain*

<sup>2</sup>*Santa Fe Institute, 1399 Hyde Park Road, Santa Fe NM 87501, USA*

Biological phenomena differ significantly from physical phenomena. At the heart of this distinction is the fact that biological entities have computational abilities and thus they are inherently difficult to predict. This is the reason why simplified models that provide the minimal requirements for computation turn out to be very useful to study networks of many components. In this chapter, we briefly review the dynamical aspects of models of regulatory networks, discussing their most salient features, and we also show how these models can give clues about the way in which networks may organize their capacity to evolve, by providing simple examples of the implementation of robustness and modularity.

Keywords: computation, complex networks, regulatory networks, Boolean networks

## INTRODUCTION

As has been highlighted by John Hopfield, several key features of biological systems are not shared by physical systems. The origin of such difference stems from the relevance that information plays in the first, which is not shared by the second [22]. Although living entities follow the laws of physics and chemistry, the fact that organisms adapt and reproduce introduces an essential ingredient that is missing in the physical sciences [19]. Due to this fact, biological structures result from evolutionary pathways and as such they are contingent [18].

Perhaps the most clear consequence of the role of information is the observation that biological entities perform *computations*: there is an evolutionary payoff placed on being able to predict the future. Typically, more complex organisms are better able to cope with environmental uncertainty because they can compute, i.e. they have memory or some form of internal plasticity, and they can also make calculations that determine the appropriate behavior using what they sense from the outside world.

Computation thus becomes a crucial ingredient when dealing with the description of biocomplexity and its evolution, because it turns out to be much more relevant than the underlying physics. Its dynamics is governed mainly by the transmission, storage and manipulation of information, a process which is highly nonlinear. This nonlinearity is well illustrated by the nature of signaling in cells: local events involving a few molecules can produce a propagating cascade of signals through the whole system to yield a global response. If we try to make predictions about the outcomes of these signaling events in general, we are faced with the inherent unpredictability of computational systems [55]. It is at this level where computation becomes central and where idealized models of regulatory networks seem appropriate enough to capture the essential features at the global scale.

Cells are probably the most complete example of this traffic of signals at all levels. They comprise millions of molecules that act coherently persisting far from equilibrium by the exchange of matter, energy and information with the environment. All these molecular processes, ultimately controlled by genes, take place at different points in space and time and involve the leading participation of proteins, which act as the nanomachines that drive cellular dynamics. The cellular network can be divided into three major self-regulated sub-webs:

- the *genome*, in which genes can affect each other's level of expression;
- the *proteome*, defined by the set of proteins and their interactions by physical contact; and

- the metabolic network (or the *metabolome*), integrated by all metabolites and the pathways that link each other.

All these subnetworks are very much intertwined since, for instance, genes can only affect other genes through special proteins, and some metabolic pathways, regulated by proteins themselves, may be the very ones to catalyze the formation of nucleotides, in turn affecting the process of translation.

It is not difficult to appreciate the enormous complexity that these networks can achieve in multicellular organisms, where large genomes have structural genes associated with at least one regulatory element and each regulatory element integrates the activity of at least two other genes. The nature of such networks started to be understood from the analysis of small prokaryotic regulation subsystems and the current picture indicates that even the smallest known webs that shape cellular behavior are indeed very complex [12, 28].

Luckily, all this extraordinary complexity can be abstracted, at least at some levels, to simplified models which can help in the study of the inner-workings of cellular networks. Overall, irrespective of the particular details, biological systems show a common pattern: some low-level units produce complex, high-level dynamics coordinating their activity through local interactions. Thus, despite the many forms of interaction found at the cellular level, all come down to a single fact: the state of the elements in the system is a function of the state of the other elements it interacts with. What models of network functioning try, therefore, is to understand the basic properties of general systems composed of units whose interactions are governed by nonlinear functions. These models, being simplifications, do not allow to make predictions at the level of the precise state of particular units. Their average overall behavior, however, can shed light into the way real cells behave as a system.

On the other hand, whereas the question of how networks of many components can achieve global order is very important, it is no less important to gain an understanding of how such networks could have been assembled step by step throughout the evolutionary process. It seems sensible to expect some properties of these networks to directly influence their capacity to smoothly integrate the changes that can make them fitter in the next generation. In this context, technology should immensely benefit from a deep knowledge of the processes behind biological evolution, since by design, engineered systems are not at all susceptible of blind tinkering. It is interesting, therefore, to explore how the same simplified models used to understand global dynamics can give hints as to how “evolvability” could be put into practice.

In summary, in this chapter we will explore the computational dimension of cellular networks. We will see that biological networks may be computationally *irreducible*, and hence why Boolean units are appropriate to understand their global properties. We will also briefly review the most important features of the Kauffman model, and their implications for computation. Finally, taking advantage of the Boolean approximation, we will show how important aspects of the capacity to evolve such as robustness and innovation could be implemented, through the use of simple, clear examples.

## THE EVIDENCE FOR COMPUTING NETWORKS

Molecules, proteins and genes interact with each other in many ways, and the result of their interactions is the coordinated behavior we observe. The first step is, therefore, to identify the different kinds of elements which make up regulatory networks and to describe their forms of interaction.

Perhaps the most important units in regulatory networks are genes, which interact through gene regulation. Genes are translated into proteins by means of a transcription machinery that

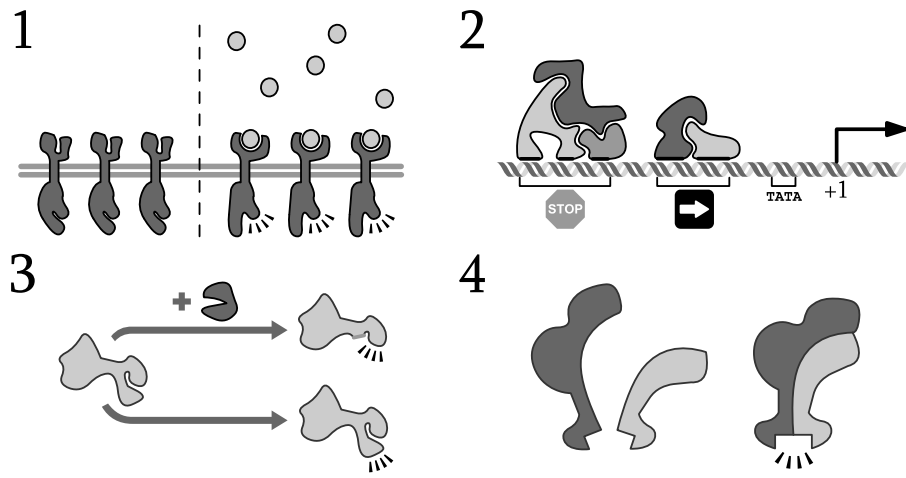

FIG. 1: Several ways in which the units of cellular networks interact. (1) Signal transduction: a membrane protein becomes active if a certain metabolite is present outside the cell. (2) Gene regulation: genes are transcribed starting at the +1 site and are affected positively by an upstream activator sequence and negatively by a silencer sequence. Both sequences can be bound by protein complexes. (3) Postranslational modification: a given protein can be modified after transcription to yield two different forms depending on the presence of other proteins. (4) Complex formation: the union of two proteins exposes a new active site that makes the complex active only then.

is controlled by multiple mechanisms. Interference with this mechanisms allows certain molecules to alter the level of expression of specific genes, as the diagram of figure 1.2 shows. Transcription is basically initiated at the promoter region, which has usually a “TATA” sequence, marking the binding site of TBP (“TATA”-binding protein). This protein is the first of a series of proteins, known as general transcription factors, that help to position the RNA polymerase correctly at the promoter. The most basic regulation, therefore, involves DNA binding proteins, or regular transcription factors, that either block the promoter, obstructing transcription or increase the probability of attachment of the RNA polymerase, enhancing it. These proteins operate in the vicinity of the promoter and in a majority of cases form complexes made of many units that combinatorially bind to DNA.

In addition to the close binding of transcription factors, other mechanisms are known that play a significant role in transcription regulation, including modifications of this basic scheme like downstream and distal enhancers or totally different mechanisms such as insulation[7], alternative splicing or post-transcriptional modification[1]. All this mechanisms affect translation and therefore determine the level of expression of a certain gene at a given instant, given the concentration of its multiple regulators. This level of expression produces a certain concentration of the protein molecules that are the products of translation. Actually, different proteins can be produced from the activation of a certain gene due to post-translational modifications, giving rise to different regulatory elements in the network. Figure 1.3 shows an example in which the direct product of a gene can turn into two different proteins, depending on the presence of another “scissor”-like protein that cleaves the initial molecule.

The concentrations of each protein molecule is, however, not only regulated at the level of transcription. Very many of them have structures that can be greatly modified in the presence of other molecules such as metabolites or other proteins. This requires their separate treatment as regulatory elements, since the different shapes usually carry out different tasks. Figure 1.1 shows a transmembrane protein which, in the presence of some metabolite, changes its conformation and becomes active at another site. These processes are the basis of the functioning of the signaling

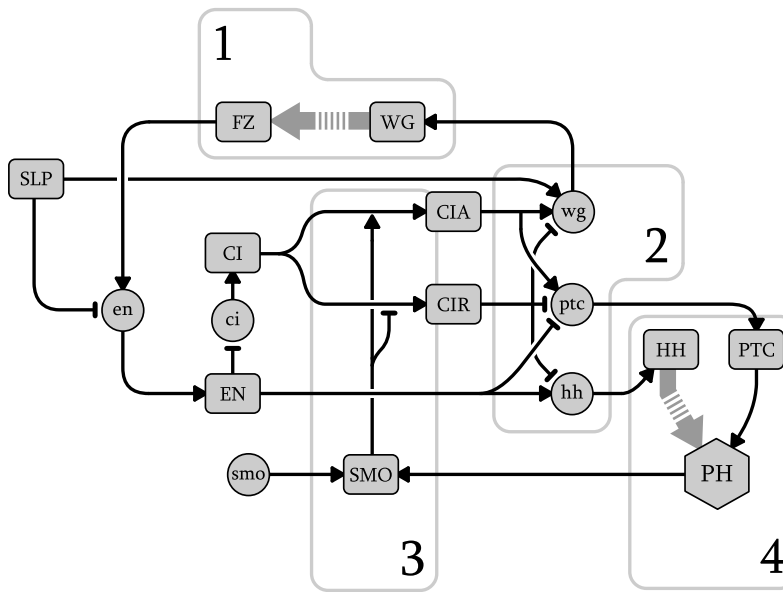

FIG. 2: The network of interactions between the segment polarity genes (modified from [2]). Rectangles represent proteins, circles genes, and hexagons protein complexes, respectively. Special, thick arrows are for transmembrane links. Examples of different types of interaction are numbered from 1 to 4. (1) Signaling network: *WG* protein binds receptor *FZ*. (2) Transcription control: *wg*, *ptc*, and *hh* transcription is controlled by the activation of other genes. (3) Posttranslational control: after translation, *CI* is transformed into *CIR* or *CIA* depending on the presence of *SMO*. (4) Complex formation: the complex *PH* is formed only when *HH* and *PTC* are present.

network, which comprises membrane receptors, intracellular signaling proteins and the receivers of the messages, for instance enzymes and regulatory or cytoskeletal proteins. Many of the components of this network are proteins that can only be in one of two states, active or inactive. Other proteins are inactive alone but active while bound to others in complexes, as shown in figure 1.4, up to very high levels of complication. As regulatory elements in their own right, this complexes also qualify as units in the regulatory network.

To summarize, many entities in cellular networks can be identified as the basic units of regulation, mainly distinguished by their unique roles with respect to interaction with other units. These basic units are genes, each of the proteins that the genes can produce, each of the forms of a protein, protein complexes, and all related metabolites. These units have associated values that either represent concentrations or levels of activation. This values depend on the values of the units that affect them due to the mechanisms discussed, plus some parameters that govern each special form of interaction.

## Modeling

To make the description more concrete, is interesting to look at a complete, real example. In figure 2 the circuit of the segment polarity network of *Drosophila melanogaster* is shown. The genes in this network are expressed throughout the life of the fly, and its pattern defines and, more importantly, maintains the borders of the segments since the first stages of development. This is a network in which all the elements discussed are present, displaying many forms of interaction, and in particular, the same 4 different mechanisms depicted in figure 1 are highlighted by 4 boxes numbered accordingly. For example, *wg* (*wingless*) interacts with *en* (*engrailed*) in the neighboring

cells by secreting a protein, *WG*, that binds to a membrane receptor *FZ* which, when activated, enhances the transcription of *en*. It is perhaps easier, looking at this diagram, to imagine how complex the dancing concentrations of genes, proteins or complexes are, all regulated through their input links and in turn regulating other elements.

Computer modeling of this network, however, has provided insight into various questions. A very important result is the fact that this network seems to be a conserved module. Evidence for this has been obtained by simulations demonstrating its robustness against the change of parameters. If the regulatory elements are modeled using a continuous-valued approach, a set of equations can be defined governing the rates of change in their populations, levels of expression, etc. Altogether, the unknown kinetic constants that have to be specified amounts to 48: half-lives of messenger RNAs and proteins, binding rates, cooperativity coefficients, etc. Surprisingly, from a huge number of possible combinations of parameters, many of them have actually a stable pattern that corresponds to the known pattern of activity of the genes, thus suggesting that the module is very robust [48]. In fact, other work has come to similar conclusions with respect to other mechanisms, such as adaptive responses in bacterial chemotaxis [6]. It seems that the topology of the network plays, in some cases, a more important role than the exact mechanisms at each node.

This is precisely the thesis of another work [2]: “our purpose here is to demonstrate that in one well-characterized system, knowledge of the interactions together with their signatures, by which we mean whether an interaction is activating or inhibiting, is enough to reproduce the main characteristics of the network dynamics”. The Boolean network presented, albeit a simplification, seems to capture the essential features because it matches the patterns of activity not only of the wild-type embryo, but of some known mutants, and it also points to other possible effects of mutations that have not been observed. This is done through an exhaustive analytical treatment of the resulting equations, as well as simulations, that in addition reveal the important roles of some of the genes involved [2]. In addition to this, other work approaches gene networks within the context of the evolution of development [43]. It is true that the network may not be so crucial in other cases, but the results nevertheless suggest the importance of aggregated behavior.

In brief, the modeling of regulatory networks involves different methods that give answers to different questions [20], but ultimately, this methods also illustrate that there is a deep, common pattern: simulation by computer seems to be the key to the solutions. As Venter puts it: “If we hope to understand biology, instead of looking at one little protein at a time, which is not how biology works, we will need to understand the integration of thousands of proteins in a dynamically changing environment. A computer will be the biologist’s number one tool” [58]. A crucial question, then, arises: Why do we need a computer to be able to study biology at all? Some insights into this question are in fact given by the theory of computation.

### **Irreducibility**

One of the most important problems in the theory of computation is the halting problem [39]. It concerns the automatic verification of software in the following terms: one is given a computer program *A* and what the program is supposed to do, and the task is to design an automatic process that verifies the correctness of the program. In other words, another program *B* has to be written that, given a description of *A* and the correct outputs, predicts what are the outputs for each set of inputs, and just checks that the answers are correct. As simple as the problem seems, it is unsolvable: there is no such program *B*. The trap lies in the fact that, to solve it, a computer has to be “smarter” than another computer. Instead of testing the execution of program *A* by explicitly following it through, *B* has to be able to make some kind of shortcut that enables it to predict the outcome without having to follow each step, to avoid, for instance, the fact that *A*

may enter a very long or complicated loop. Since  $B$  cannot exist, there are no such shortcuts to the long-term dynamics of computers, and their step-by-step evolution must be followed perforce. This impossibility to predict is called *irreducibility*, and has been hypothesized to be much more common than usually acknowledged [55].

The fact that regulatory networks may be irreducible seems to be a plausible hypothesis, since computer modeling of regulatory networks seems to be the only way to deal with their complexity. Apart from that, there seems to be some awareness of this fact, since some authors have treated cellular networks with the tools of electronic design [31], and compared molecules with computational elements[9]: “Putting aside for the moment the question of whether it is useful or even sensible to view them in this manner, it is nevertheless true that protein molecules are in principle able to perform a variety of logical or computational tasks”. An additional reason may be seen in the fact that multistability (or bistability) is very often the mechanism behind some genetic circuits [20], and that this switching behavior is the base for computational capabilities. As a consequence, the assumption that computational irreducibility characterizes regulatory networks makes simplified Boolean models sufficient to understand their relevant properties, since they have the minimal, essential ingredients. This is the view that we favor in this work. It is important, nevertheless, to emphasize two important points.

On the one hand, this kind of modeling consciously neglects the details of the precise functioning of particular units, not because they are irrelevant, but because they inherently cannot contribute to the understanding of the whole. The exact strengths of certain interactions are indeed very important to some physiology processes [45], because these processes determine important aspects of cell functioning that need fine tuning. But in general, the details of the switching behavior of networks of many elements do not seem to be crucial to the overall patterns of activity, which otherwise would make the network too sensitive to particular parameters. Furthermore, irreducibility makes impossible to gain any understanding whatsoever of a process which involves big numbers of components: “Even if an ideal parameter set was provided (say, by software for automatic parameter optimization), the numerical solutions churned out by the computer would be just as inscrutable as the cell itself” [47].

On the other hand, in our opinion, no thorough understanding of all the processes in the cell can give hints as to why higher level behavior does occur. After all, understanding means the ability to explain a phenomenon, which is equivalent to be able to predict its behavior in all situations. In the case of the whole network, this seems virtually impossible. Moreover, even if all cell processes were known in detail, the resulting cell map would be useful for many purposes, such as designing very complex and specific drugs, but would otherwise leave open the question of how such a wonderful organization arose through the accumulation of small variations. An evolutionary explanation of the assembly of such a complex structure will surely be aided more by an understanding at the global level of the general dynamics of idealized Boolean networks than by a detailed study of all the real, discovered subnetworks. Essentially, there seems to be two levels of approach in regulatory networks, either at the level of small modules, or at the level of the whole system, with exclusive goals and providing answers to qualitatively different behavior[5]. We will focus on Boolean dynamics as the main tool for whole-system study.

## THE BOOLEAN IDEALIZATION

In order to properly address the role of computation in regulatory networks, an exactly defined model is required. One possible approach is to see the networks as devices performing a definite task in an automatic, orderly manner. Given a set of inputs, such a device would react by performing a number of predefined operations, and yielding some output. If the device, either biological or

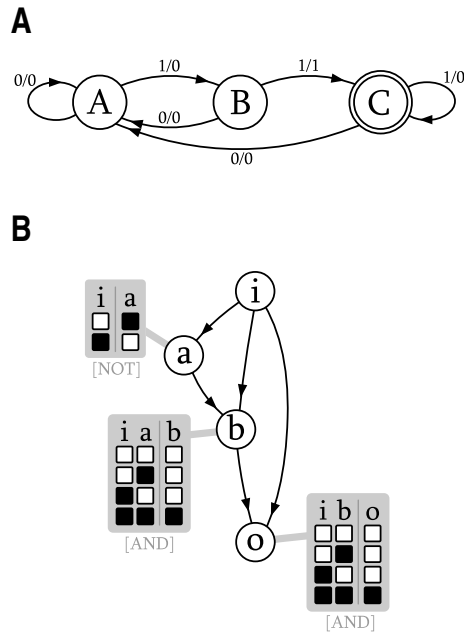

FIG. 3: **A**. State diagram of a DFA (Discrete Finite Automaton) recognizing the sequence “011”. The  $C$  state represents the initial and the final state of the recognition sequence and the labels at the links connecting states represent inputs/outputs of the automaton. **B**. Minimum Boolean network implementing the task defined by the automaton. Each unit in the Boolean network computes its next value using a table that tells, for each input combination, what should be the output.

artificial, has a minimal amount of memory, an appropriate description is provided by the so called discrete finite automata (DFA), a kind of abstract machines commonly used in the theory of computation[39]. These automata are also used in the design of logic circuits because they allow the designer to explicitly state the requirements of a circuit and they serve as the basis for optimization processes that minimize various parameters of it, including wiring and the number of memory units [21].

Figure 3A depicts the state diagram of a DFA, in this simple case an example of a machine that recognizes the pattern “011”. This means that given a string of binary digits as input it will return as output a 1 whenever it detects this pattern, and 0 otherwise. For this purpose, the automaton has three different states  $A$ ,  $B$  and  $C$  and at each time step, it is given an input that makes it jump to another state, and yield some output value. For each state, two possible transitions are possible, denoted with an arrow in the diagram. On each arrow two values  $a/b$  are drawn, representing the input value of the transition,  $a$ , and the resulting value delivered by the machine,  $b$ . In our case, the  $A$  state represents the initial phase of the detection, in which the first 0 is detected. In fact, all states go to  $A$  if a 0 is given. Accordingly,  $B$  represents the middle phase of the detection and  $C$  the final one, being the initial state as well.

In figure 3B the simplest network that performs the task defined by the above automaton is shown. It has one input unit,  $i$ , one output unit,  $o$ , and two internal units,  $a$  and  $b$ . Given an initial state with all units set to 0, at each time step, all units compute their next output as a function of their present inputs, and switch to the new values at once. For units that have no inputs, the next value is assumed to be specified. It is not difficult to trace the values of the units through the detection sequence. First, upon the reception of a 0,  $a$  switches to 1, and the other units remain at 0. The unit  $a$  is then a testimony of a 0 in the input at the last time step. At the next time step, provided then that  $a$  is active,  $b$  turns to 1 only if the input was 1, thus implicitly detecting a

01 by means of the temporary memory of  $a$ . Finally, if  $b$  is 1 and the input is again 1, the output turns to 1, ending the detection process.

This network is a simple example of a general class of networks called Boolean networks, in which inputs perform Boolean functions [4]. The basic ingredients have been used already in the example: Boolean (i.e. on-off) states for the units, discrete time steps (synchrony), and general Boolean functions (a different specified output for each combination of inputs) at each unit. Its introduction was motivated by the questions raised in the modeling of the gene regulatory network by Kauffman [25], although with a somewhat different perspective. In the last section, we have seen examples of the modeling of real networks with the aim of understanding particular parts of the cellular network. Kauffman adopted the complementary perspective of studying Boolean networks wired at random, with the hope of finding properties that would apply to the system in its entirety [24]. As we will see, he mostly succeeded.

Currently known as the Kauffman model, a system composed of  $N$  genes  $g_i$  interacting through Boolean functions  $f_i$ , with discrete time steps, has a dynamics defined by the following equation:

$$g_i^{t+1} = f_i(g_{j_1}^t, \dots, g_{j_K}^t). \quad (1)$$

To fully specify the network, the  $K$  inputs of each node are chosen at random among the  $N$  units of the system, and the functions are chosen so that the outputs have a 1 with probability  $p$  and a 0 with probability  $1 - p$ , with no special units as inputs or outputs. Since it is specified at random, the network only has two parameters of interest:  $K$ , which defines the average connectivity between nodes; and  $p$ , which actually tunes the susceptibility of the function to changes in the input values: the closer  $p$  to 0.5, the easier it is that  $f_i$  changes if input  $k$  is reversed.

The global dynamics of Kauffman networks can be made clearer making the following observation. As already mentioned, at each time step, all nodes are updated synchronously using equation 1 from the values of their inputs. Therefore, we can treat the whole system as having a global state  $S$ , given by the composite state of all the units (or genes), that is,

$$S \equiv (g_1, g_2, \dots, g_N).$$

This global state  $S$  represents a point in the space  $\mathcal{S}$  of all possible states, and at each time step it jumps to a different point following a trajectory given by the network configuration, starting at the chosen initial state.

Eventually, as time goes on, a state will be reached that has already been visited before, closing the trajectory into either a loop or a single state, if this state maps onto itself. To see the dynamics of a Boolean network at a glance, it is useful to examine a graph in which all the possible states of the network are linked to their successors in the dynamics. In such a chart, disjoint subgraphs represent different subsets of states that end in the same loop, called *basins of attraction*. Figure 4 depicts precisely the basin of attraction field of two networks: the example of figure 3 in case A, and a random Boolean network with 9 units and connectivity  $K = 2$  in case B. All points of the dynamics of the network are present, followed by their successors, and all possible trajectories are implicit in them, making the graph a very useful map. Indeed, software tools exist to draw basins of attraction fields for any specified network [56].

Kauffman associated these basins of attraction with the different cell types specified by the underlying gene network, and made some arguments regarding the number of cell types (basins of attraction) present as a function of the network size  $N$  and the average connectivity  $K$  [24]. But the most important finding in relation with our discussion involves the dynamical properties of the system, and in particular, the propagation of errors. An important property of Boolean networks is, in fact, that depending on the connectivity  $K$ , errors have only three possible fates: either they die out, propagate to the whole system, or maintain themselves in the exact border between fading



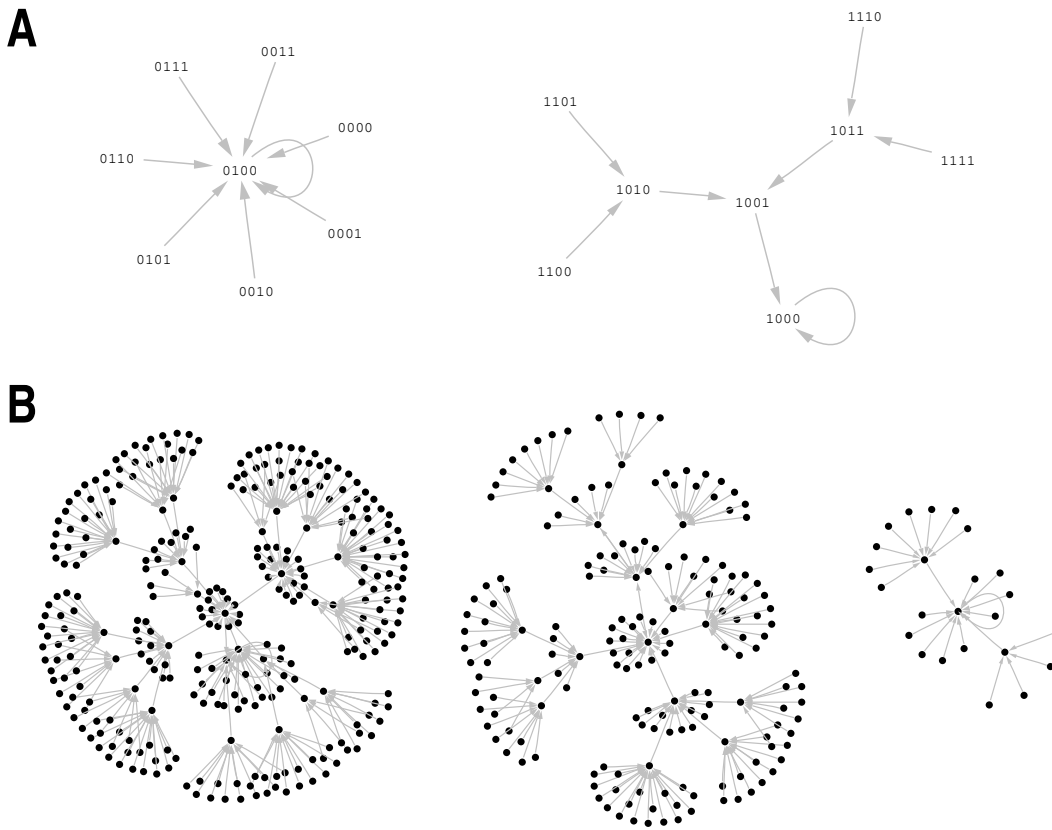

FIG. 4: **A.** Basins of attraction of the circuit shown in figure 3. The nodes in this graph are represented as the corresponding states of the Boolean network. **B.** Examples of the basins of attraction of a randomly generated network with 9 units and average connectivity  $\langle K \rangle = 2$ .

and exploding. This kind of behavior is a good example of a so called critical phase transition, a phenomenon well known in statistical physics [44].

A simple explanation to understand this behavior can be given by means of a percolation argument [29], and is general enough to include networks with a non-uniform distribution of links of average  $\langle K \rangle$ . Consider a given gene  $g_i$  in a Kauffman network of connectivity  $\langle K \rangle$ , and let us assume that the gene is externally flipped to the opposite state. The question asked is: how is this change going to be propagated through the network? Since the connectivity is  $\langle K \rangle$ , the change in  $g_i$  will arrive, on average, at the inputs of its  $\langle K \rangle$  neighbors. It remains to be seen with which probability these nodes will propagate the change, which is the same as asking with what probability a random Boolean function changes its output when a single input is changed. Two possible propagation situations can take place, either the original output was 0 and shifts to 1 or the opposite occurs. Each of these situations has a probability  $P = p(1 - p)$  (given the independence between values in the function  $f_i$ ) and two of them are possible, thus the propagation probability is  $P^* = 2p(1 - p)$ . The average number of changes will be, then,

$$N_{ch} = P^* \langle K \rangle = 2p(1 - p) \langle K \rangle. \quad (2)$$

The three phases of behavior can be understood making the observation that  $N_{ch}$  represents the factor with which errors will multiply. If  $N_{ch} < 1$  then changes will tend to disappear, at each time step the average number of changes diminishes. This is the so-called *ordered phase*, in which

robustness is enough to cancel errors in the long term. If  $N_{ch} > 1$  then errors will multiply and eventually the whole system will be affected by the avalanche. This is the *chaotic phase*, in which the state of the system in the future is governed by the uniform amplification of small events.

At the critical point, that is  $N_{ch} = 1$ , the number of errors does not have a tendency, so it will be impossible to predict what shall happen in the long run. In practice, this means that there will be a mixture of effects: some errors will die out, and some will propagate to the whole system. Using the equation 2, the critical point dictates the critical connectivity,

$$K_c = \frac{1}{2p(1-p)},$$

which simply leads to  $K_c = 2$  for the case  $p = 0.5$ , as considered by Kauffman in its initial formulation. One simple implication of this formula is the fact that connectivity is rather low, i.e. that the network is *sparse*, an observed property in real networks [14]. It is also important to note that the connectivity  $\langle K \rangle$  and the probability  $p$  alone determine the global behavior of the system. Although it does not make much sense to think that evolution can tune  $K$  or  $p$  directly, the accumulation of mutations will surely affect them, in turn affecting its mode of behavior with respect to the phase transition.

The importance of this transition lies in its intimate relationship with computation, and in particular, with the characteristics that computation requires to systems that implement it. These requirements have to do with the ability to process information, or in the words of Langton [27]: “First, the physics must support the *storage* of information, which means that the dynamics must preserve local state information for arbitrarily long times. Second, the physics must support the *transmission* of information, which means that the dynamics must provide for the propagation of information in the form of *signals* over arbitrarily long distances. Third, stored and transmitted information must be able to interact with one another, resulting in a possible modification of one or the other” [59]. In addition, the issue of irreducibility plays an important role, because systems whose behavior can be predicted in the long run may not be able to implement complex tasks.

In the light of these ideas, it does not seem probable that Boolean networks with computational utility could be in the ordered phase. Signals do not seem to be able to travel as far as needed, that is *arbitrarily* long distances. Although the analysis proposed is seen from the viewpoint of errors, a single unit that serves as input to the system and flips its state can be also seen as an external signal rather than an error, and then, the propagation of this error can be regarded as a signaling cascade. If the signal is unable to reach some parts of the system due to the network’s inherent dynamics, many computations cannot be performed. On the other hand, computing Boolean networks do not seem to live in the chaotic phase either. Since regulatory networks are very noisy [30], any computation that did work in the absence of noise would be surely disrupted by a single error. The critical phase, therefore, seems to have the suitable balance: it has the possibility of communicating any pair of units in the system, and it is not too sensitive to the values of all of them [42].

Many authors have drawn attention to the fact that criticality in the dynamics of Boolean networks or cellular automata have desirable properties, and in two cases, properties directly related with computation. The major arguments in favor of criticality are the following:

- the capacity of systems at the critical point to exhibit arbitrarily large correlation lengths in space and time, supporting the basic mechanisms of storage, transmission and modification of information [27];
- the undecidability (or the incapacity to predict without explicitly simulating the system) of the properties of systems in the critical phase as a basic characteristic of systems capable of computation [54]; and,

- that emergence of order “for free” in networks which are critical [24].

There are also some arguments against this hypothesis. In [13], it is demonstrated that many cellular automata (a type of regular Boolean network embedded in space) with computational capabilities exist in the ordered and chaotic regions defined in [54]. Their existence is indeed a significant result, but it does not say anything about the density of automata with computational capabilities in each phase, which may influence drastically the probability of reaching them by an evolutionary process. In [3], it is argued that Boolean networks with a scale-free degree distribution may provide, through their uneven distribution of connectivity, ways of making changes that have a significant impact on function, but allowing the network to remain in the ordered phase at the global scale.

Finally, in [32], an example of simulation of the evolution of cellular automata is shown that does not select automata with critical properties, suggesting that the critical phase does not have a higher density of systems with computational capabilities. In all cases, it is apparent that evolutionary properties are a very important ingredient in addition to dynamics. Overall, however, we are still ignorant about the applicability of these ideas in real regulatory networks, because current information includes more data with regard to the presence or absence of interactions than with their function.

### THE EVOLUTIONARY POINT OF VIEW

To complement current understanding of the dynamics of Boolean networks, we also want to focus on the functional aspects of network evolution, again using Boolean networks. Very little is known about this subject, and yet simple examples can demonstrate the subtle differences in evolvability between variants of the same circuit.

Figure 5A shows a Boolean network implementing the discrete machine shown in 3A. To make drawings simpler, we have chosen to follow the notation used by von Neumann[50], which eliminates the use of Boolean tables. Although this notation also implies losing some richness in the repertoire of Boolean functions, von Neumann proved its completeness in the specification of any computational device, and it is somewhat closer to actual regulation in cells. The new units are also Boolean and synchronous, but determine their output by comparison to a threshold  $h$ . Inputs can either excite or inhibit a given unit, and the output of the unit at the time  $t + 1$  will be in the excited state only if the sum of the number of excitatory inputs minus the number of inhibitory inputs at  $t$  is greater than or equal to  $h$ . This threshold  $h$  is represented as an integer number inside the circle that represents the unit. As usual in diagrams of genetic regulatory circuits, excitation is represented by a black arrowhead and inhibition by a terminating segment.

To complete this rather simple scheme we must augment it with the introduction of a simple unit assumed to be in a permanent excitatory state, denoted by a smaller black circle, to allow the possibility of negation. This is in fact what happens with unit  $a$  in the diagram of figure 5A, to be compared with the circuit of figure 3B. With respect to the new notation, it is not difficult to see how the “AND” gate behavior of units  $b$  and  $o$  is now implemented with units that have two excitatory states and a threshold  $h = 2$ , since “AND” gates are active only if both inputs are active. Conversely, an “OR” unit would be the same as an “AND” but with  $h = 1$ . Finally, before any discussion of the circuit properties we want to introduce a slight modification to the simplest implementation. The modification is shown in figure 5B, and it just adds a delay of one time unit to the prior circuit, needing the introduction of units  $c$  and  $d$  whose role is simply to retransmit the values at their inputs. The behavior of the circuit is thus unaltered except for the one time step delay [60]

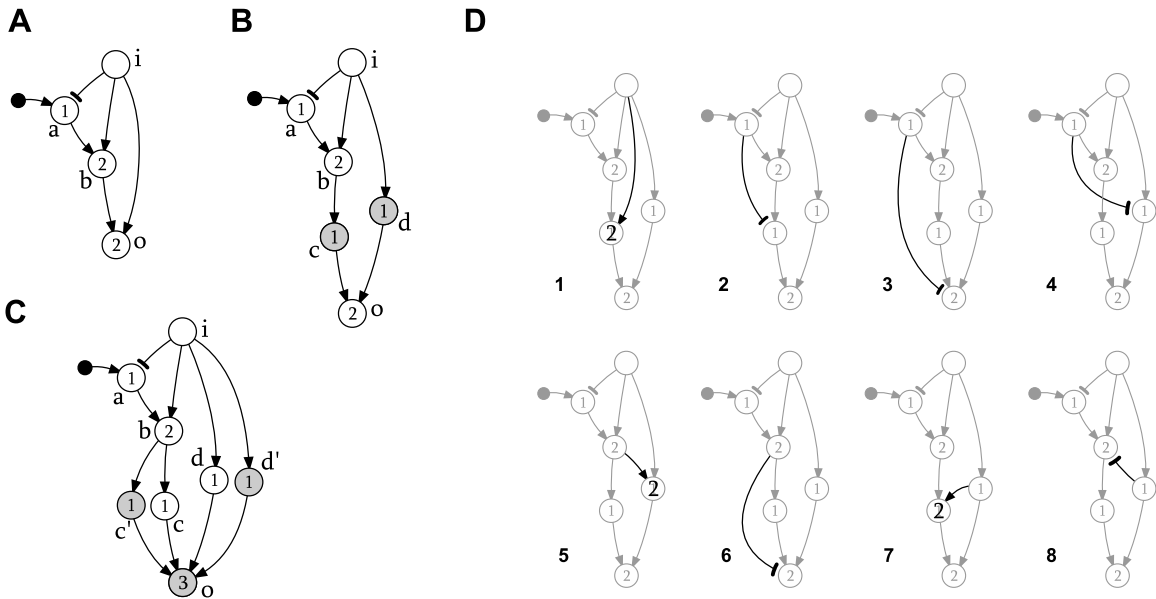

FIG. 5: Several Boolean networks implemented with threshold units. Excitatory inputs end in a black arrow, and inhibitory ones in a terminating segment. The threshold is specified inside each unit, and the units are in gray when they represent changes made to another network. **A.** The equivalent of the network of figure 3B. **B.** The same functional circuit as in **A** with two delay units  $c$  and  $d$  added. **C.** An example of the use of redundancy by the multiplication of lines. **D.** Several modifications to **B** that maintain functionality.

Let us, then, examine this new circuit. One of the first evident properties is its complete lack of robustness: if the link connecting  $c$  and  $o$  happens to fail when transmitting the activation signal at the final steps of the detection process,  $o$  will never activate, and the overall result will be the failure at recognizing the input sequence “011”. So it happens with the link from  $b$  to  $c$ , and many others in the circuit. Boolean logic is unable to cope with the failure of single components provided that the circuit represents a minimal implementation, as is the case the circuits we have seen. This fragility is also displayed by many man-made systems, in which the failure of individual components is assumed to be very infrequent. When a failure finally happens, the system is often not able to function at all. However, natural systems, and in our case cells, do have a great deal of robustness, motivated, basically, by two important sources of distress.

The first is thermal noise: the same process that makes molecules move and wander inside the cytoplasm introduces an inevitable stochasticity in the effects produced by them, for example at the level of gene expression [8, 16]. The second, a byproduct of the first, is mutation: cells inherently accumulate changes in the genome through time, altering at random the networks they code for, a source of “permanent” noise. Despite the existence of these two sources of noise, cells behave in a very deterministic manner, compensating for its presence in some way. Deterministic responses also may include the explicit exploitation of noise to generate phenotypic variation, the only exception to its repression. At the level of molecules, cells have mechanisms to ensure that signals are received at the appropriate places [30]. At the level of genes, for instance, cells of *S. cerevisiae* do not display signs of a decrease in fitness in a 40 percent of null mutations to all genes in chromosome V [40]. The question is: how can cells achieve this powerful buffering?

## Redundancy

A similar question was probably asked by von Neumann, albeit in a more abstract manner. He was searching for a logic system composed of unreliable components which worked in a reliable manner [50]. Many engineered systems require, in fact, high standards of reliability, such as, for instance, computerized bank accounting. The solution proposed by von Neumann, and still used today is to put *redundancy* into the system, or, stated plainly: to put many copies of the same thing. The idea is simple: if anyone of the copies fails, the copies that still work can compensate. In addition, a mechanism is needed to determine which are the copies that behave correctly. In the simplest case, the majority rule can be applied, which von Neumann implemented with his “majority organ” [61]. As the name of the rule implies, in the face of mismatched behavior, the expected correct copies are assumed to be the most numerous, disregarding the others as wrong. In this way the failure of the whole system will happen only when, by chance, a number of copies bigger than half the number of available copies has failed, an event with a probability that can be made arbitrarily small as the number of copies grows, compared to the probability of failure of a single copy.

Figure 5C shows our circuit with redundancy implemented. Nodes  $c$  and  $d$  have been duplicated to create two redundant paths,  $c'$  and  $d'$ , one for each signal. [62]. Upon arrival,  $o$  will activate with only 3 of them, allowing the failure of exactly one. As an example, the probability of failure of the unit  $o$  in this circuit can be calculated if we call  $p$  the probability of failure of its input links. Assuming that failure of links means not carrying a positive signal, three possible events can occur that make  $o$  fail, which are the failure of 2, 3 or 4 links. Weighting by the number of combinations in which they can occur, we have the following equation:

$$p' = \binom{4}{2}p^2(1-p)^2 + \binom{4}{3}p^3(1-p) + \binom{4}{4}p^4. \quad (3)$$

With  $p = 0.1$ , the formula yields  $p' = 0.052$ . To obtain a higher gain, more parallel units could be introduced. It is worth mentioning, nevertheless, that the redundancy introduced is also useful to absorb the changes produced by the removal of units, a situation analogous to the knockout of genes. In the way this circuit is constructed, anyone of  $c$ ,  $c'$ ,  $d$  or  $d'$  could be removed with no functional result whatsoever. In fact, it is clear that many implementations of networks detecting the pattern “011” are possible, each with some degree of redundancy placed in different points of the network. Therefore, it seems that the degree to which redundancy is found in biological systems must be the product of selection, at each generation adding or removing links that contribute positively or negatively to the robustness of the organism.

## Degeneracy

But even if simple redundancy seems to suffice for the buffering of noise or mutation, its utility is of much less relative value than expected when put in an evolutionary context. Certainly, the introduction of duplicates protects organisms from mutation and noise, and studies exist that prove the stability of redundant genes under some conditions [33]. From the perspective of evolution, however, such a simple form of robustness would make organisms much less able to innovate. The reason for this difficulty is that all the copies of subparts that protect redundant systems probably have to be changed if a change in function is needed, making the adaptation process very awkward and frustrating. In fact, similar mechanisms can provide a source of robustness without the drawbacks of redundancy.

Figure 5D shows all possible circuits that are the same as 5B, but in which a single link has been added preserving the global function. In all cases, the new connections added basically crosscheck

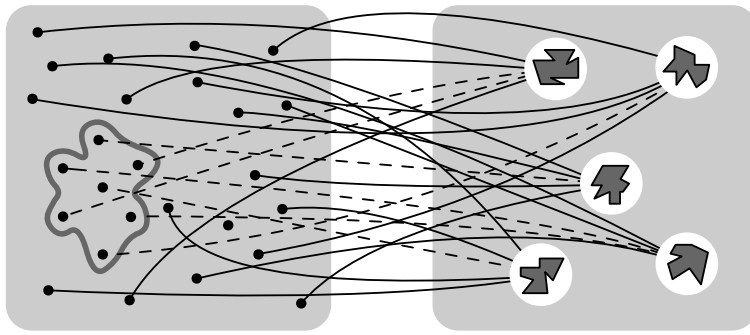

FIG. 6: A diagram showing sequences and their associated shapes connected by a line. At the left, sequence space, at the right, shape space. The neighborhood marked in sequence space has many different sequences mapping into all shapes, as the dashed lines reveal.

the detection sequence of the units in the simplest circuit. For instance, in the fifth one, unit  $d$  is modified to not only make sure that the last value of the input is 1, but also its coincidence in time with the activation of  $b$ , a detector of “01” in the past two values. The path leading from  $b$  to  $o$  is, in a way, duplicated, because the meanings of  $c$  and  $d$  overlap to a certain extent. The other cases involve other parts of the circuit but result in very similar modifications. These changes, in fact, can be seen as “neutral” mutations. Given the simplest, nude circuit, different combinations of this single modifications can provide a great deal of robustness, yet they do so in a different way, taking advantage of the multiple connections available that do not modify the behavior of the system. They also seem a more probable source of robustness, provided that mutation is random in nature.

This mode of robustness has already been defined and has been called *degeneracy*: “the ability of elements that are structurally different to perform the same function or yield the same output” [15]. This applies to our system in the sense that different signaling paths can compute different subparts of the final pattern without being exact copies. Although first defined in the context of the nervous system [46], degeneracy seems a good candidate for the implementation of robustness in biological systems in general. Redundancy, favored initially due to the existence of duplication in the genome, was rendered implausible by studies of duplicated genes showing an immediate and steady divergence of their sequences, implying that the major source of robustness is to be found in unrelated genes [51]. Again, for the same reasons mentioned above, the amount of degeneracy can be tuned by evolution to a suitable degree by making the appropriate changes to the network.

### Evolvability

This brings us to the issue of the capacity to evolve, or *evolvability*. Although mentioned only in the context of redundancy, the inability to innovate is not only related to the duplication of subparts but also with an excessive display of robustness, even if implemented using degeneracy. Evolvability has been discussed by many authors [26, 53], and it is defined as “the capacity to generate heritable, selectable, phenotypic variation”. “This capacity may have two components: (i) to reduce the potential lethality of mutations and (ii) to reduce the number of mutations needed to produce phenotypically novel traits” [26]. In relation to our discussion, it is clear that robustness contributes to the reduction of lethal mutations, but it is still unclear how to reduce the number of mutations needed to produce novelty.

Although in a somewhat different context, the study of the evolution of populations of RNA molecules can provide important insights into this question [37]. In particular, RNA molecules

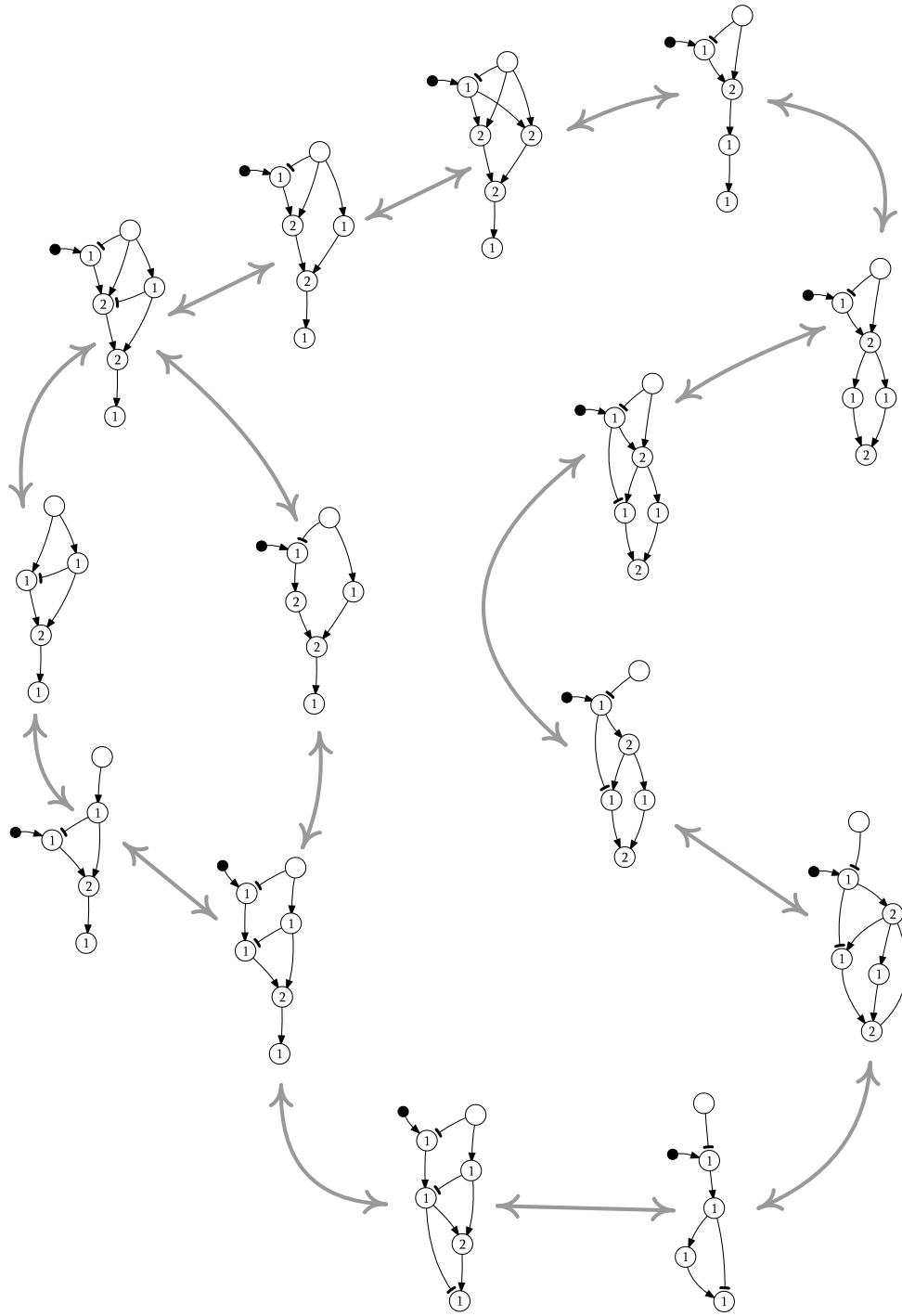

FIG. 7: An example of a neutral network using simple Boolean circuits. All the circuits in the network perform the same task, which is the recognition of the “01” pattern. On each circuit, the input unit is at the top and output is at the bottom. Arrows represent mutations to the circuits, such as duplication or removal of units, and addition or removal of links, as well as changes in the activation thresholds.

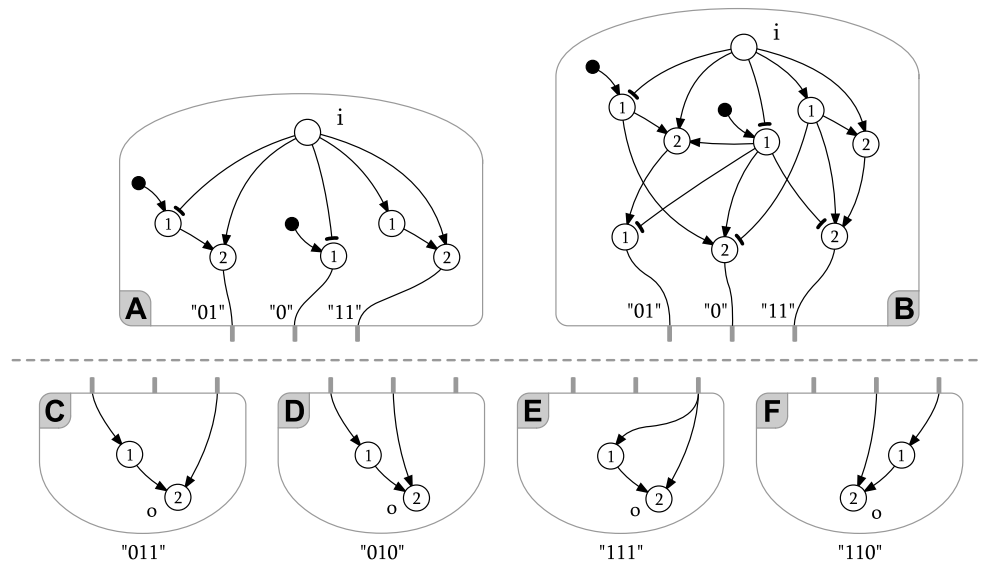

FIG. 8: An example of modularity in Boolean networks. **A** Module that makes useful “pre-detections”. **B** The same module with added robustness. **C, D, E & F**. Various ways to use the basic module to perform different functions.

have the analogs of a genotype and a phenotype in their sequence and folding shape, respectively. Therefore, a genotype space (or sequence space) and a phenotype space (or shape space) can be defined. The studies of the landscapes that appear when linking genotype space with phenotype space tell us that sequence space is completely traversed by the so called *neutral networks* [38]. These networks comprise all sequences sharing a common shape that can be accessed by one point mutations, hence the name. The implications of this fact are more easily understood looking at figure 6, in which sequence space and shape space are next to each other. The links that appear between the two spaces connect sequences with their corresponding shapes. Due to the existence of neutral networks, all shapes have connections from all of sequence space. As is immediately apparent, a very small neighborhood of a given sequence has connections with approximately all shapes, implying that many shapes are a few mutations away. This corresponds precisely to the idea of reaching novel traits through a small number of mutations, our second requirement for evolvability.

Even if the analogy with RNA has some risks, nothing prevents us in principle from applying these ideas to Boolean networks. In our context, sequence space is the analog of our circuit diagram (or genotype), and shape space is our function space (or phenotype). Neutral mutations have already been discussed in the context of degeneracy, where we have seen that many changes to a network do not alter the network’s function. It is therefore a plausible idea that indeed whole networks of circuits with the same function can be accessed by single changes in their wiring, enabling a circuit to traverse circuit space and at the same time undergoing a complete rewiring. This is precisely what figure 7 shows. The example circuit has been reduced to one signaling path that recognizes the subpattern “01”. Following the arrows, at each step a single modification is made to the network that preserves function, including duplications, deletions, and addition or removal of links. Networks separated by many mutations have very few common links, and sometimes “homologous” links are part of functionally different signaling pathways.



## Modularity

From another perspective, modularity also seems to contribute to the successful innovation in organisms. Many examples from evo-devo show that what makes sense is to study groups of genes in subnetworks responsible for traits [36, 41, 49] instead of isolated genes, and from an evolutionary viewpoint, modularity allows the adaptation of different traits with little or no interference with each other [52]. Apart from the separation of functionally distinct traits, modularity also pervades molecular biology, with examples such as the recombination of domains in proteins [34], or the combination of DNA sequences allowing the cis-regulation of genes [10]. In these cases, what matters most is the recombination of basic modules to form new structures in a much more rapid fashion, provided that these modules combinatorially allow any possible higher-level structure to be built. This gain in speed is widely used in engineering, in which often new systems are built using the components developed for their older brothers. Electronics, in particular, is a very good example of this, with the use of integrated circuits as building blocks that facilitate the construction of new, more complex circuits.

In figure 8, an example of modularity is shown, again using the “011” detector circuit. As is implied by the shape of their boxes, any combination of upper and lower modules can be plugged to form a different circuit, with the upper modules performing basic functions, in this case the detection of particular subsequences, and the lower modules recombining the outputs of the upper modules to detect different input patterns. Upper modules perform the same subfunctions, so as to be compatible with the interface with lower modules, but differ in the degree of robustness. This fact illustrates an important point, in relation with the ideas discussed above, which is the following. As we have already seen, the degree of robustness can be tuned by an evolutionary process, giving more or less robustness to selected units in the network by the addition or removal of “degenerate” links. As the construction of the circuit progresses, a subset of units could be found to be useful as building blocks for higher-level processing and thus be made more robust, since the modifications necessary to generate a complete spectrum of behaviors would not involve these building blocks but the use of their precalculations in other parts of the network. Further evolution would be, therefore, speeded up by the finding of these modules. In this sense, the module  $B$  in figure 8 could be one example of that process, resulting in an increased connectivity within the module.

Modularity in the topological sense is, in fact, measured in terms of these uneven patterns of connectivity, which produce clusters of nodes more densely connected. This feature, among others, is what some methods exploit to detect the modular structure of a network [17, 23, 57]. A simple enough picture of this kind of modularity, though, can be obtained by a coefficient  $C_i$  which measures the fraction of neighbors of this node that are neighbors themselves, that is,

$$C_i = \frac{2E_i}{k_i(k_i - 1)}.$$

In this formula,  $E_i$  is the number of edges present between neighbors of  $i$ , and  $k_i$  the actual number of neighbours,  $k_i(k_i - 1)$  being the total number of possible links between neighbors of  $i$ . The average of  $C_i$ , that is,  $\langle C \rangle$ , describes in general the *clustering coefficient* of a network. This measure has been observed to be much higher in real networks than for random graphs in a variety of fields [14], and in particular, it has also been shown to display a scale-free distribution [35]. This last fact demonstrates that modularity is indeed hierarchical, with small, strongly connected modules assembling into less cohesive, bigger modules in the upper level, and so on up to the whole network.

## DISCUSSION

In summary, we are still very much puzzled by the question of how complex regulatory networks are organized. But we think that the study of these networks with Boolean models can help understand the properties of general systems which, on the global scale, behave like real cells. The reasons for the success of this approximation might be found in the unsurmountable irreducibility of cellular processes, which behave in a manner similar to that of a computer. In the case of particular subnetworks, the Boolean approximation is successful in studying those mechanisms that are more “digital”, and do not yield fine, graded responses. In the case of the whole system, these models can give important answers to questions regarding global, average dynamics.

In fact, two important aspects can be readily highlighted about Boolean networks. On the one hand, their dynamics undergoes a phase transition that enables us to classify its modes of behavior in three different zones, depending on a just two global parameters, such as the connectivity and the unit susceptibility. Looking at the properties of such modes of functioning, we find more probable that Boolean networks are in the critical phase, if they are to be capable of computation. As a consequence, networks must be sparse in connectivity, a feature which is present in real networks.

On the other hand, simple models of Boolean functions tell us that the degree of resistance to noise can be varied in a given network, mainly with the use of degeneracy, which adds neutral connections that perform parallel processing of the same information. Through a succession single changes of this kind, a network can be rewired completely preserving its function at all times. This resistance to noise can also be considered as a resistance to mutation, which simply adds a form of coherent noise to the network. Although good for robustness, the resistance to change must not be too strong, because variation is also needed in evolution. Since degeneracy adds connections and their removal is related to sensitivity, an equilibrium between the two tendencies seems also to point to the idea that connectivity in regulatory networks has to be finely tuned to achieve evolvability.

In relation to it, modularity might emerge when parts of the network are found that enable further evolution in a quicker way by reusing their existing computations. If a suitable combination of useful modules is found, degeneracy can add protection to them, increasing connectivity within their subnetworks. This would implicitly direct the effects of mutations to the connections governing the combination of modules, which would avoid trying many worthless mutants. Although these ideas can be presented using simple examples, much work has to be done to thoroughly quantify them in models of networks with many units.

## ACKNOWLEDGEMENTS

The authors would like to thank the members of the complex systems research group for useful discussions. This work was supported by a grant BFM2001-2154 (RVS) and the Generalitat de Catalunya (PFD, 2001FI/00732) and The Santa Fe Institute.

- 
- [1] B. Albert, A. Johnson, J. Lewis, M. Raff, K. Roberts, and P. Walter. *Molecular Biology of the Cell*. Garland Science, New York, 4th edition, 2002.
  - [2] R. Albert and H. G. Othmer. The topology of the regulatory interactions predicts the expression pattern of the *drosophila* segment polarity genes. *J. Theor. Biol.*, 223:1–18, 2003.
  - [3] M. Aldana and P. Cluzel. A natural class of robust networks. *PNAS*, 100:8710–8714, 2003.
  - [4] M. Aldana-González, S. Coppersmith, and L. P. Kadanoff. Boolean dynamics with random couplings. In E. Kaplan, J. E. Marsden, and K. R. Sreenivasan, editors, *Perspectives and Problems in Nonlinear*

- Science. A celebratory volume in honor of Lawrence Sirovich*, Applied Mathematical Sciences. Springer, May 2003.
- [5] P. W. Anderson. More is different. *Science*, 177:393–396, 1972.
  - [6] N. Barkai and S. Leibler. Robustness in simple biochemical networks. *Nature*, 387:913–917, 1997.
  - [7] A. C. Bell, A. G. West, and G. Felsenfeld. Insulators and boundaries: versatile regulatory elements in the eukaryotic genome. *Science*, 291:447–450, 2001.
  - [8] W. J. Blake, M. Kaern, C. R. Cantor, and J. J. Collins. Noise in eukaryotic gene expression. *Nature*, 422:633–637, 2003.
  - [9] D. Bray. Protein molecules as computational elements in living cells. *Nature*, 376:307–312, 1995.
  - [10] N. E. Buchler, U. Gerland, and T. Hwa. On schemes of combinatorial transcription logic. *Proc. Natl. Acad. Sci. USA*, 100:5136–5141, 2003.
  - [11] D. Butler. Computing 2010: from black holes to biology. *Nature*, 402:C67–C70, 1999.
  - [12] Eric H. Davidson *et al.* A genomic regulatory network for development. *Science*, 295:1669–1678, 2002.
  - [13] A. Dhar, P. Lakdawala, G. Mandal, and S. R. Wadia. Role of initial conditions in the classification of the rule space of cellular automata dynamics. *Phys. Rev. E*, 51:3032–3037, 1995.
  - [14] S. N. Dorogovtsev and J. F. F. Mendes. *Evolution of Networks*. Oxford University Press, New York, 2003.
  - [15] Gerald M. Edelman and Joseph A. Gally. Degeneracy and complexity in biological systems. *PNAS*, 98:13763–13768, 2001.
  - [16] M. B. Elowitz, A. J. Levine, E. D. Siggia, and P. S. Swain. Stochastic gene expression in a single cell. *Science*, 297:1183–1186, 2002.
  - [17] M. Girvan and M. E. J. Newman. Community structure in social and biological networks. *PNAS*, 99:8271–8276, 2002.
  - [18] S. J. Gould. *The Structure of Evolutionary Theory*. Belknap, Harvard, 2003.
  - [19] L.H. Hartwell, J.J. Hopfield, S. Leibler, and A.W. Murray. From molecular to modular cell biology. *Nature*, 402:C47–C52, 1999.
  - [20] J. Hasty, D. McMillen, F. Isaacs, and J. J. Collins. Computational studies on gene regulatory networks: in numero molecular biology. *Nature Rev. Gen.*, 2:268–279, 2001.
  - [21] J. P. Hayes. *Principles of Digital Logic Design*. Addison-Wesley, Reading, MA, 1993.
  - [22] J.J. Hopfield. Physics, computation, and why biology looks so different. *J.Theor.Biol.*, 171:53–60, 1994.
  - [23] J. Ihmels, G. Friedlander, S. Bergmann, O. Srig, Y. Ziv, and N. Barkai. Revealing modular organization in the yeast transcriptional network. *Nature Genetics*, 31:370–377, 2002.
  - [24] S. A. Kauffman. *The origins of order*. Oxford U. Press, New York, 1993.
  - [25] S.A. Kauffman. Metabolic stability and epigenesis in randomly constructed genetic nets. *J.Theor.Biol.*, 22:437–467, 1969.
  - [26] Marc Kirschner and John Gerhart. Evolvability. *PNAS*, 95:8420–8427, 1998.
  - [27] C. Langton. Computation at the edge of chaos: phase transitions and emergent computation. *Physica D*, 42:12–37, 1990.
  - [28] Lee, T. I. *et al.* Transcriptional regulatory networks in *saccharomyces cerevisiae*. *Science*, 298(5594):799–804, 2002.
  - [29] B. Luque and R. V. Solé. Phase transitions in random networks: simple analytic determination of critical points. *Phys. Rev. E*, 55:257–260, 1997.
  - [30] H. H. McAdams and A. Arkin. It’s a noisy business! genetic regulation at the nanomolar scale. *Trends Genet.*, 15(2):65–69, 1999.
  - [31] H. H. McAdams and L. Shapiro. Circuit simulation of genetic networks. *Science*, 269:650–656, 1995.
  - [32] M. Mitchell, P. T. Hraber, and J. P. Crutchfield. Revisiting the edge of chaos: Evolving cellular automata to perform computations. *Complex Systems*, 7:89–130, 1993.
  - [33] M. A. Nowak, M. C. Boerlijst, J. Cooke, and J. Maynard Smith. Evolution of genetic redundancy. *Nature*, 388:167–171, 1997.
  - [34] T. Pawson and P. Nash. Assembly of cell regulatory systems through protein interaction domains. *Science*, 300:445–452, 2003.
  - [35] E. Ravasz, A. L. Somera, D. A. Mongru, Z. N. Oltvai, and A.-L. Barabási. Hierarchical organization of modularity in metabolic networks. *Science*, 297:1551–1555, 2002.
  - [36] I. Salazar-Ciudad, S. A. Newman, and R. V. Solé. Phenotypic and dynamical transitions in model genetic networks i: Emergence of patterns and genotype-phenotype relationships. *Evolution and De-*

- velopment*, 3(2):84–94, 2001.
- [37] P. Schuster. How does complexity arise in evolution. *Complexity*, 2:22–30, 1996.
  - [38] P. Schuster, W. Fontana, P. Stadler, and I. Hofacker. From sequences to shapes and back: A case study in RNA secondary structures. *Proc. Roy. Soc. London B*, 255:279–284, 1994.
  - [39] M. Sipser. *Introduction to the Theory of Computation*. PWS Publishing Company, 1997.
  - [40] V. Smith, K. N. Chou, D. Lashkari, D. Botstein, and P. O. Brown. Functional analysis of the genes of yeast chromosome V by genetic footprinting. *Science*, 274:2069–2074, 1996.
  - [41] R. V. Solé, I. Salazar, and J. Garcia-Fernández. Common pattern formation, modularity and phase transitions in a gene network model of morphogenesis. *Physica A*, 305:640–647, 2002.
  - [42] R. V. Solé and J. Delgado. Universal computation in fluid neural networks. *Complexity*, 2(2):49–56, 1996.
  - [43] R. V. Solé, P. Fernández, and S. A. Kauffman. Adaptive walks in a gene network model of morphogenesis: insights into the cambrian explosion. *IJDB*, 2003.
  - [44] H. E. Stanley. *Introduction to Phase Transitions and Critical Phenomena*. Oxford University Press, 1971.
  - [45] A. Sveiczer, A. Csikasz-Nagy, B. Gyorffy, J. J. Tyson, and B. Novak. Modeling the fission yeast cell cycle: Quantized cycle times in *wee1-cdc25delta* mutant cells. *PNAS*, 97:7865–7870, 2000.
  - [46] Giulio Tononi, Olaf Sporns, and Gerald M. Edelman. Measures of degeneracy and redundancy in biological networks. *PNAS*, 96:3257–3262, 1999.
  - [47] J. J. Tyson, K. Chen, and B. Novak. Network dynamics and cell physiology. *Nature Rev. Mol. Cell Biol.*, 2:908–916, 2001.
  - [48] G. von Dassow, E. Meir, E. Munro, and G. M. Odell. The segment polarity network is a robust developmental module. *Nature*, 406:188–192, 2000.
  - [49] G. von Dassow and E. Munro. Modularity in animal development and evolution: elements of a conceptual framework for evodevo. *J. Exp. Zool.*, 406(6792):188–192, 1999.
  - [50] J. von Neumann. Probabilistic logics and the synthesis of reliable organisms from unreliable components. In C. Shannon and J. McCarthy, editors, *Automata Studies*. Princeton University Press, Princeton, 1956.
  - [51] A. Wagner. Robustness against mutations in genetic networks of yeast. *Nature Genetics*, 24:355–361, 2000.
  - [52] G. P. Wagner. Homologues, natural kinds, and the evolution of modularity. *Am. Zool.*, 36:36–43, 1996.
  - [53] G. P. Wagner and L. Altenberg. Complex adaptations and the evolution of evolvability. *Evolution*, 50:967–976, 1996.
  - [54] S. Wolfram. Universality and complexity in cellular automata. *Physica D*, 10:1–35, 1984.
  - [55] S. Wolfram. Undecidability and intractability in theoretical physics. *Phys. Rev. Lett.*, 54:735–738, 1985.
  - [56] A. Wuensche. Genomic regulation modeled as a network with basins of attraction. In R.B. Altman, A.K. Dunker, L. Hunter, and T.E. Klien, editors, *Pacific Symposium on Biocomputing '98*. World Scientific, Singapore, 1998.
  - [57] H. Zhou. Distance, dissimilarity index, and network community structure. *Phys. Rev. E*, 67:061901, 2003.
  - [58] As quoted in [11].
  - [59] Italics from the original.
  - [60] To make the discussion less involved, we have made some appropriate choices. First, to omit the initial state of the network, which might give positive output values in the intermediate steps of the detection. Starting from random values, it is sufficient to neglect the output in the first steps of the process, and after that all of it is correct. Second, we have chosen excitation links with preference, because they make the exposition clearer, although in all circuits the units can be made to function in reverse with a few changes.
  - [61] He called his units “organs”.
  - [62] This duplication can be interpreted, in fact, as the duplication of genes *c* and *d*, a very usual mechanism for the creation of genes in eukaryotes.