

TURAEV-VIRO MODULES OF SATELLITE KNOTS

PATRICK M. GILMER

Louisiana State University

ABSTRACT. Given an oriented knot K in S^3 and a TQFT, Turaev and Viro defined modules somewhat analogous to the Alexander module. We work with the (V_p, Z_p) theories of Blanchet, Habegger, Masbaum and Vogel [BHMV] for $p \geq 3$, and consider the associated modules. In [G], we defined modules which also depend on the extra data of a color c which is assigned to a meridian of the knot in the construction of the module. These modules can be used to calculate the quantum invariants of cyclic branched covers of knots and have other uses.

Suppose now that S is a satellite knot with companion C , and pattern P . We give formulas for the Turaev-Viro modules for S in terms of the Turaev-Viro modules of C and similar data coming from the pattern P . We compute these invariants explicitly in several examples.

This version:(10 /11 /96); First Version: (10 /2 /96)

§1 TURAEV-VIRO MODULES

Let (V, Z) be a Topological Quantum Field Theory over a field f defined on a cobordism category whose morphisms are oriented 3-manifolds perhaps with extra structure. Let (M, χ) be a closed oriented 3-manifold M with this extra structure together with $\chi \in H^1(M)$ where $\chi : H_1(M) \rightarrow \mathbb{Z}$ is onto. Let M_∞ denote the infinite cyclic cover of M given by χ . Consider a fundamental domain E for the action of the integers on M_∞ bounded by lifts of a surface Σ dual to χ , and in general position. E can be viewed as a cobordism from Σ to itself. $Z(E)$ can be viewed as an endomorphism of $V(\Sigma)$.

Let $\mathcal{K}(V)$ be the generalized 0-eigenspace for the action of $Z(E)$ on $V(\Sigma)$, i.e. $\mathcal{K}(V) = \cup_{k \geq 1} \text{Kernel}(Z^k)$. $Z(E)$ induces an automorphism $Z^b(E)$ of $V^b(\Sigma) = V(\Sigma)/\mathcal{K}(V)$. Alternatively \mathcal{V}^b can be defined as $\cap_{k \geq 1} \text{Image}(Z^k)$. The Turaev-Viro module (M, χ) associated to (V, Z) is simply is $V(\Sigma)^b$ viewed as a $f[t, t^{-1}]$ -module where t acts by $Z^b(E)$.

Theorem 1.1 (Turaev-Viro). *This module does not depend on the choice of E .*

Sketch of Proof. A detailed exposition of Turaev-Viro's proof [TV] is given in [G, §1]. Here we give the main idea. Suppose E' is another choice of fundamental domain. Without loss of generality we may assume that E' has been shifted by the covering

1991 *Mathematics Subject Classification.* 57M99.

Key words and phrases. Turaev-Viro module, quantum invariant, companion, pattern, TQFT.
This research was supported by a grant from the Louisiana Education Quality Support Fund

transformation so that E and E' are disjoint. Let W denote the cobordism indicated by the following schematic diagram for the infinite cyclic cover.

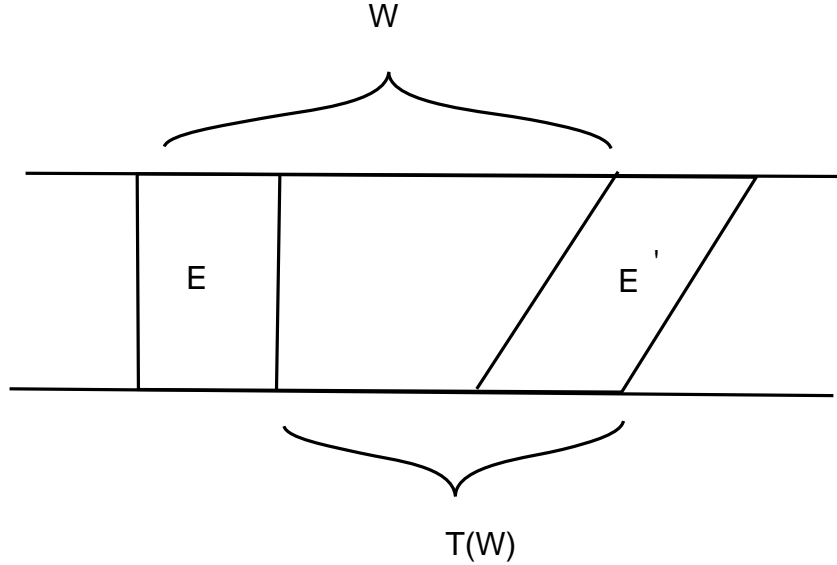

Figure 1

As $E \cup T(W) = W \cup E'$, we have $Z(W) \circ Z(E) = Z(E') \circ Z(W)$ after identifying $V(\Sigma)$ with $V(T(\Sigma))$, and $V(\Sigma')$ with $V(T(\Sigma'))$. After dividing out by $\mathcal{K}(V)$, and $\mathcal{K}(V)'$, Z_W becomes invertible and so provides a similarity between $Z^b(E)$ and $Z^b(E')$. \square

We will now specialize to the case that (V, Z) is the (V_p, Z_p) theory of Blanchet, Habegger, Masbaum and Vogel [BHMV] for $p \geq 3$. These are combinatorial versions of the Witten-Reshetikhin-Turaev TQFTs associated to $SU(2)$ and $SO(3)[W, RT]$. We will work over the field of fractions of k_p , which we denote f_p . A “color” for this theory is a integer from zero to $p/2 - 2$ if p is even. If p is odd, a color is an even positive integer less than or equal to $p - 3$. Here we depart from the usage in [BHMV, G], by assuming that colors are always even, when p is odd. One advantage is that the tensor product axiom will always hold. We let \mathcal{C} denote the set of colors.

A triple of colors $\{i, j, k\}$ is called admissible if $i + j + k \equiv 0 \pmod{2}$, and $i \leq j + k$, $j \leq i + k$, and $k \leq i + k$. Moreover their sum must be small. In particular $i + j + k \leq p - 4$, if p is even. Also $i + j + k \leq 2p - 4$, if p is odd. Let \mathcal{A} denote the set of admissible triples. Let $\mathcal{A}(i, j)$ denote the set of colors k such that $\{i, j, k\} \in \mathcal{A}$. Let $\mathbb{A}(i)$ denote the set of ordered pairs of colors (j, k) such that $\{i, j, k\} \in \mathcal{A}$. We also let $\mathcal{A}(i)$ denote the set of colors j such that $\{i, j, j\} \in \mathcal{A}$.

The objects of our cobordism theory are oriented surfaces with colored banded points and p_1 -structure. A banded point is simply a point with an oriented arc through it. The empty set \emptyset is also an object. $V(\emptyset)$, according to the axioms of for a TQFT, is the scalar field f_p . A morphism is an oriented 3-manifold with p_1 -structure with admissibly colored trivalent banded graphs. A trivalent banded graph is an oriented surface which deformation retracts to a trivalent graph. A coloring is an assignment of colors to the edges of the core graph so that the colors at each vertex are admissible. By closed 3-manifold, from now on we mean a morphism from \emptyset to \emptyset . If M is a closed 3-manifold, then $Z_p(M)$ is multiplication by a scalar which is denoted $\langle M \rangle$.

We let ω denote the linear combination of links in solid torus $\eta \sum_{c \in \mathcal{C}} \Delta_c e_c$, where Δ_c denotes the evaluation of an unknot diagram colored c and e_c denotes the closure of the Jones-Wenzl idempotent of the c -strand Temperley-Lieb algebra. ω is used for the surgery formula [BHMV, §1.C]. See the discussion at the end of the proof of [G, 8.2]. If we have a linear combination admissibly colored trivalent banded graphs in \mathbb{R}^3 , by an evaluation, we mean the scalar obtained as in [KL] with A a primitive $4p$ th root of unity. Thus the empty graph evaluates to one. In general, if M denotes the same graph in S^3 , the one point compactification of \mathbb{R}^3 with p_1 -structure which extends over the 4-ball, then $\langle M \rangle_p$ is η times the evaluation of the graph in \mathbb{R}^3 .

Let K be an oriented knot in S^3 . Let $M(K)$ denote 0-framed surgery to S^3 along K equipped with a p_1 -structure with zero σ -invariant. Let $M(K, c)$ denote $M(K)$ with a meridian colored by a color c . Let χ evaluate to one on a positive meridian of K . A surface dual to χ will be called a splitting surface for $M(K)$. Let $Z_p(K, c)$ denote the Turaev-Viro module of $(M(K, c), \chi)$, thought of as a similarity class of automorphisms for a finite dimensional vector space over f_p . Thus it may be described by a matrix \mathcal{M} with entries in f_p . In this case, we will write $Z_p(K, c) = \mathcal{M}$. Sometimes we may wish to describe $Z_p(K, c)$ with a matrix \mathcal{M} or automorphism \mathcal{Z} which may have a non trivial generalized 0-eigenspace. Then we write $Z_p(K, c) \equiv \mathcal{M}$, or \mathcal{Z} as the case may be, and it is understood that $Z_p(K, c)$ is given by the induced map on the quotient after we divide out by this generalized 0-eigenspace. We let $Z_p(K)$ denote $Z_p(K, 0)$. It is easy to see that $Z_p(K, c)$ is zero if c is odd, and p is even. $Z_p(K, c)$ is undefined if c is odd, and p is odd. It is shown in [G], that $Z_p(K)$ is unchanged if we change the string orientation on K .

As motivation for studying $Z_p(K, c)$, we mention some results of [G].

Theorem 1.2. *If K is a fibered knot in a homology sphere which is a homotopy ribbon knot, then one is an eigenvalue of $Z_p(K)$.*

Let $M(K)_d$ denote the d -fold cyclic cover of $M(K)$ associated to χ with the p_1 -structure induced from $M(K)$ by the projection.

Theorem 1.3. *$\langle M(K)_d \rangle_p$ is the trace of $Z_p(K)^d$. Thus $\langle M(K)_d \rangle_p$ can be computed by a linear recursion formula given by the characteristic polynomial of $Z_p(K)$.*

Let $\sigma_\lambda(K) = \text{Sign}((1 - \lambda)V + (1 - \bar{\lambda})V^t)$, where $\omega \in \mathbb{C}$ with $|\omega| = 1$ and V is a Seifert matrix for K . Following [KM], let $\sigma_d(K) = \sum_{i=1}^{d-1} \sigma_{\lambda_d^i}(K)$, where $\lambda_d = e^{2\pi i/d}$. These are called the total d -signatures of K . The σ invariant of the p_1 -structure on $M(K)_d$ is $3\sigma_d(K)$. Let K_d denote the branched cyclic d -fold cover of S^3 along K with a p_1 -structure with σ -invariant $3\sigma_d(K)$.

Theorem 1.4.

$$\langle K_d \rangle_p = \eta \sum_{c \in \mathcal{C}} \Delta_c \text{Trace}(Z_p(K, c)^k)$$

Note that $\text{Trace}(Z_p(K, c)^k)$ can be computed recursively from the characteristic polynomial of $Z_p(K, c)$.

Let $d_g(p, c)$ denote the dimension of V_p of a surface of genus g with a single point colored c . We have the following theorem of Walker's [Wa1] who proved that the rank of $Z(E)$ is an invariant of the pair (M, χ) . His work stimulated Turaev and Viro to refine his theorem and prove (1.1). Theorem (1.5) may be used to estimate the genus of a knot.

Theorem 1.5 (Walker). *If K has genus g ,*

$$\text{rank}(Z_p(K, c)) \leq d_g(p, c).$$

Perhaps Walker did not consider the case $c \neq 0$. I do not know. *From now on, to cut down on the clutter of subscripts, we will omit the subscript p from Z and $\langle \rangle$.*

§2 SATELLITE KNOTS

Let C be an oriented knot in S^3 , equipped with its standard framing. The pushoff with this framing is a longitude which bounds in the complement. A pattern consists of a oriented link of two components in S^3 . One component A is called the axis and must be unknotted. The other component \mathcal{E} is called the embellishment. Given C and a pattern \mathcal{E} , a satellite knot S is formed with C as its companion. Because C is framed, its tubular neighborhood comes equipped with an identification to a standard solid torus. We give A the standard framing. The exterior of A is also a standard solid torus with a knot \mathcal{E} in it. S is the image of \mathcal{E} if we replace the tubular neighborhood of C by the exterior of A . More precisely, we recover the 3-sphere if we glue the exterior of C to the exterior of A such that the oriented meridian of A goes to the oriented longitude of C , and the oriented longitude of A goes to the oriented meridian of C . Note that this gluing map is orientation reversing. We sometimes denote S by $C \star P$.

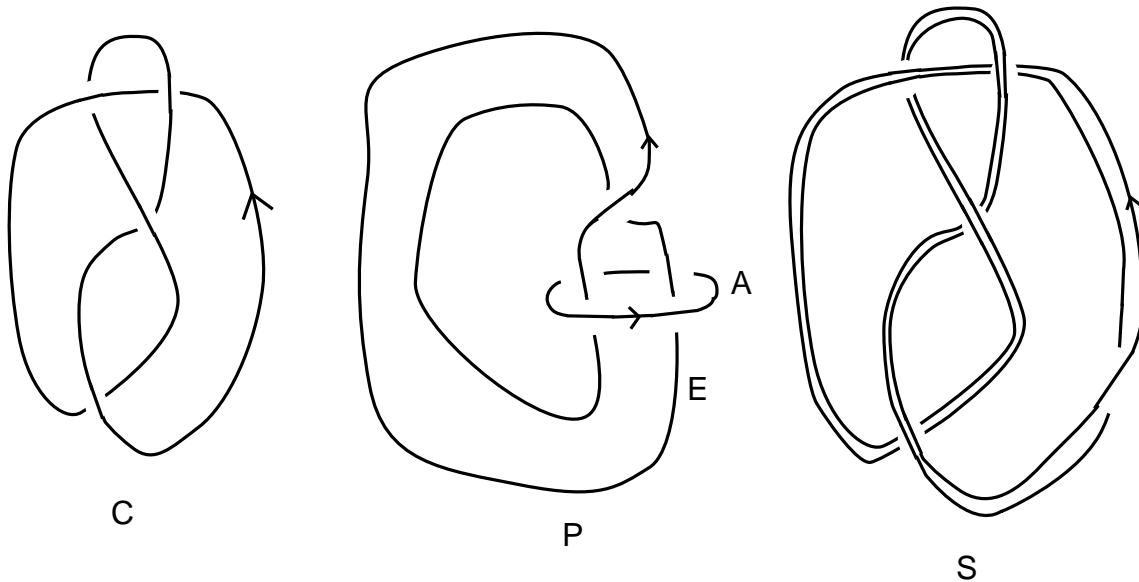

Figure 2

The above example is the (2,1) cable of the figure eight knot. A cable knot is where \mathcal{E} is a torus knot on the boundary of the exterior of A . The winding number of the pattern is the linking number of A and \mathcal{E} . In the above example it is two. Since the invariant we are calculating is actually insensitive to the string orientation of a knot, we assume from now on that the winding number is nonnegative.

There is a long tradition in knot theory for expressing invariants of satellite knots in terms of invariants of the companion and the pattern. See the following papers and the references therein: [ML] for abelian invariants, [Li] for signatures and Casson-Gordon Invariants, and [MS1,MS2] for the Jones polynomial. We mention now some precursor results from [G] on Turaev-Viro modules of satellite knots.

A connected sum of K_1 and K_2 can be viewed as a satellite with companion K_1 and the pattern of winding number one obtained by taking \mathcal{E} to be K_2 and A to be a meridian of K_2 . In [G,(7.4)], we showed

$$(2.1) \quad Z(K_1 \# K_2) = \bigoplus_{c \in \mathcal{C}} Z(K_1, c) \otimes Z(K_2, c).$$

More generally:

$$(2.2) \quad Z(K_1 \# K_2, c) = \bigoplus_{(i,j) \in \mathbb{A}(c)} Z(K_1, i) \otimes Z(K_2, j).$$

Below we will develop a formula which generalizes these. Another important satellite construction is that of the k -twisted double. The winding number is zero. Here is the pattern $D(k)$ (with $k=-1$):

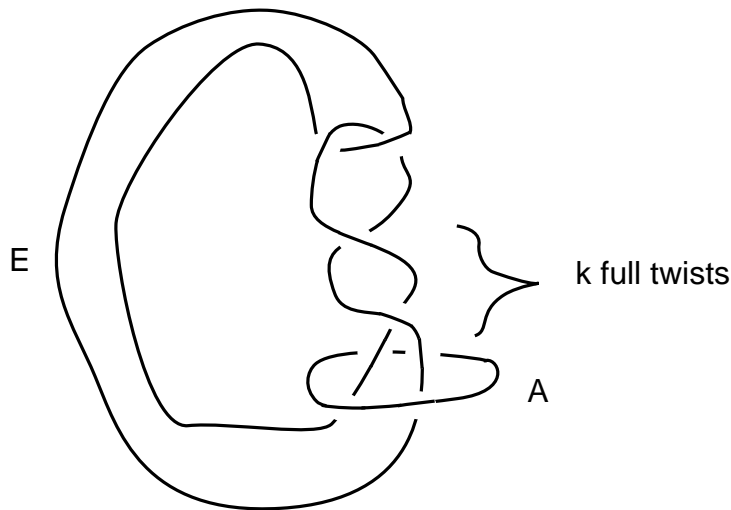

Figure 3

In [G], we derived formulas for $Z(C \star D(k), c)$. The formulas were rather complicated. Let C_s denote the evaluation of a diagram of C with zero writhe colored by s . We will show in §8 how using the methods of [G], one can obtain the following formula under the hypothesis that C_s is nonzero for all colors s :

$$(2.3) \quad Z(C \star D(k)) \equiv \eta \kappa^{-3} \left(\mu_i \sum_{s \in \mathcal{A}(i,j)} \mu_s^k C_s \right)_{i,j \in \mathcal{C}}$$

where $\mu_i = (-1)^i A^{i^2+2i}$ is the contribution of a positive curl colored i . Here we also use the notation that $(a_{ij})_{i,j \in \mathcal{C}}$ denotes the square matrix with entries a_{ij} as i and j range over \mathcal{C} .

j range over \mathcal{I} . More generally, if C_i is nonzero for all $i \in \mathcal{A}(c)$, we will obtain,

$$(2.4) \quad Z(C \star D(k), c) \equiv \eta \kappa^{-3} \left(\frac{\Delta_i \mu_i}{\theta(i, i, c)} \sum_{t \in \mathcal{A}(i, j)} \frac{\mu_t^k C_t}{\theta(i, j, t)} \text{Tet} \begin{bmatrix} t & i & i \\ c & j & j \end{bmatrix} \right)_{i, j \in \mathcal{A}(c)}.$$

Here we adopt some notation from [KL]. $\theta(i, j, k)$ denotes the evaluation of a planar theta curve with edges colored i, j , and k . $\text{Tet} \begin{bmatrix} a_1 & a_2 & a_3 \\ b_1 & b_2 & b_3 \end{bmatrix}$ denotes the evaluation of a planar tetrahedron with edges around some face colored a_1, a_2 , and a_3 , and for each i , the edge opposite the edge colored a_i colored b_i . Note that $\text{Tet} \begin{bmatrix} t & i & i \\ c & j & j \end{bmatrix}$ becomes $\theta(i, j, t)$ when we let $c = 0$. Also $\theta(i, i, c)$ becomes Δ_i . So (2.4) becomes (2.3).

Below we will also give a different formula for $Z(C \star D(k))$ coming from the satellite description. In §8, we also use these other formulas to give a new derivation of (2.4) without the requirement that any C_i be nonzero.

We need to give a slightly different description of the satellite S which will be more suitable for glueing formulas. Let m_C denote a meridian of C in $M(C)$. Now m_C is isotopic in $M(C)$ to core of the solid torus added to the exterior of C in constructing $M(C)$. So the exterior of m_C in $M(C)$ is just the exterior of C in S^3 . But the meridian of m_C is the longitude of C with the opposite orientation and the longitude of m_C using the obvious framing for m_C is a meridian of C . Thus we have that:

Lemma 2.5. *S is the image of \mathcal{E} in the union of the exterior of A with the exterior of m_C in $M(C)$ by an orientation reversing diffeomorphism which preserves the longitudes but reverses the meridians. So $M(S)$ is the union of the exterior of A in $M(\mathcal{E})$ with the exterior of m_C in $M(C)$ by an orientation reversing diffeomorphism which preserves the longitudes but reverses the meridians.*

§3 GLUING FORMULAS

Let \mathcal{T} denote a solid torus $S^1 \times D^2$ with a fixed p_1 -structure. The meridian $m(\mathcal{T})$ is given by $\{1\} \times S^1$. The longitude $l(\mathcal{T})$ is given by $S^1 \times \{1\}$. Let ϵ_i denote the element of $V(\mathcal{T})$ obtained by coloring $S^1 \times \{0\}$ with i .

Let K a framed knot in a closed 3-manifold M . By this we mean a framed knot disjoint from the colored graph. We may then isotope the p_1 -structure on M so that there is an orientation reversing diffeomorphism from a tubular neighborhood of K to \mathcal{T} which preserves p_1 -structure, and meridian, and sends the longitude to minus the longitude. Here the longitude is specified by the framing and the orientation on the knot. The meridian is oriented so that K intersects the meridional disk with intersection number plus one. We assume this has been done. Call a knot K equipped with such a diffeomorphism ϕ_K , a pramed knot. In this situation, let (M, K, a) denote the closed 3-manifold given by M after adjoining K colored a to the graph. Also let $\text{Ext}(K)$, the exterior of K , be the complement the interior of the domain of ϕ_K , with the boundary identified with $\partial\mathcal{T}$ by ϕ_K , which is now orientation preserving. We need the following lemmas.

Lemma 2.1. $\text{Ext}(K) = \sum_{c \in \mathcal{A}(K)} \langle (M, K, c) \rangle \epsilon_c$

Proof. $\text{Ext}(K)$ paired with e_a is given by $\langle (M, K, a) \rangle$ using the pairing Q2 of [BHMV]. $\{e_a\}_{a \in \mathcal{C}}$ is a basis and pairing is nondegenerate. \square

Lemma 3.2. *Suppose K_1 and K_2 are pramed knots in a closed 3-manifolds M_1 , and M_2 . $\langle \text{Ext}(K_1) \cup_s \phi_{K_2}^{-1} \circ \phi_{K_1}(-\text{Ext}(K_2)) \rangle = \sum_{a \in \mathcal{C}} \langle (M, K_1, a) \rangle \langle (M, K_2, a) \rangle$*

Proof. $\langle \text{Ext}(K_1) \cup_{\phi_{K_2}^{-1} \circ \phi_{K_1}} - \text{Ext}(K_2) \rangle = \langle \text{Ext}(K_1), (-\text{Ext}(K_2)) \rangle$. Moreover $\{e_a\}_{a \in \mathcal{C}}$ is orthonormal with respect the Hermitian pairing Q2. \square

Let K^* denote K in M after reversing the orientation on M , but preserving the string orientation on K . Note that by the above construction starting with K^* , we have $\text{Ext}(K^*)$ has boundary identified with $\partial\mathcal{T}$ by ϕ_{K^*} , which is orientation preserving. Also the longitude of K^* is the longitude of K , but the meridian of K^* is oriented opposite to that of K . Consider now $\text{Ext}(K_1) \cup_s \phi_{K_2}^{-1} \circ \phi_{K_1} - \text{Ext}(K_2^*)$, which we denote by $M_{1K_1} \wedge_{K_2} M_2$. This obtained by gluing the exterior of K_1 with the exterior of K_2 by an orientation reversing diffeomorphism which preserves the longitudes but reverses the meridians just as in Lemma(2.5). (3.2) in this situation becomes:

$$(3.3) \quad \langle M_{1K_1} \wedge_{K_2} M_2 \rangle = \sum_{a \in \mathcal{C}} \langle (M, K_1, a) \rangle \langle (M, K_2, a) \rangle$$

Also $M(\mathcal{E})$, and $M(C)$ both bound 4-manifolds: $B(\mathcal{E})$, and $B(C)$ respectively with zero signature such that the inclusions $M(C) \hookrightarrow B(C)$, and $M(\mathcal{E}) \hookrightarrow B(\mathcal{E})$ induce isomorphisms on first homology. This follows from the fact that $\Omega_3(S^1) = 0$. As $M(\mathcal{E})$, $M(C)$ both have a p_1 -structure with trivial σ -invariant, the p_1 -structure extends over $B(\mathcal{E})$, $B(C)$ respectively. Thus the p_1 -structure on $M(\mathcal{E})_A \wedge_{m_C} M(C)$ extends over B obtained by gluing $B(\mathcal{E})$ to $B(C)$ along tubular neighborhoods of \mathcal{E} and C identified by the above identification. Moreover the kernels of the maps on H_1 induced by the inclusions $\text{Ext}(m_C) \hookrightarrow B(C)$, and $\text{Ext}(\mathcal{E}) \hookrightarrow B(\mathcal{E})$ are both generated by the longitudes. Thus the Maslov index of the triple of kernels needed to compute the signature of B is zero. It follows that the σ -invariant of the induced p_1 -structure on $\partial B = M(\mathcal{E})_A \wedge_{m_C} M(C)$ is zero. Thus:

$$(3.4) \quad M(S) = M(\mathcal{E})_A \wedge_{m_C} M(C)$$

Suppose M_2 above is not a closed 3-manifold, but a morphism from Σ to Σ' , and K_2 is in the interior of M_2 . Then one has:

$$(3.5) \quad Z(M_{1K_1} \wedge_{K_2} M_2) = \sum_{a \in \mathcal{C}} \langle (M, K_1, a) \rangle Z(M, K_2, a)$$

We also want to glue morphisms along the exteriors of arcs. Let \mathcal{J} denote the solid tube $I \times D^2$. We equip \mathcal{J} with a fixed p_1 -structure. The meridian $m(\mathcal{J})$ is given by $\{1\} \times S^1$, oriented with the standard orientation on S^1 . The parallel $p(\mathcal{J})$ is given by $I \times \{1\}$, oriented with the orientation on I from zero to one.

Let M be a morphism from Σ to Σ' , and suppose neither of these surfaces are empty. Let γ be a smooth framed arc in M from $p \in \Sigma$ to $q \in \Sigma'$. We may then isotope the p_1 -structure on M so that there is an orientation reversing diffeomorphism ϕ_γ^+ from a tubular neighborhood of γ to \mathcal{J} which preserves p_1 -structure, and parallel, and sends the meridian to minus the meridian. Call an arc γ equipped with such a diffeomorphism, a (+)pramed arc. Here the parallel is an arc in the boundary of the tubular neighborhood and is specified by the framing and the orientation on the knot. The meridian is oriented so that γ intersects the meridional disk with intersection number plus one.

Let $-\mathcal{J}$ denote \mathcal{J} with the same p_1 -structure and with the same parallel but with the opposite ambient orientation and with the oppositely oriented meridian. We may also isotope the p_1 -structure on M so that there is an orientation reversing diffeomorphism ϕ_γ^- from a tubular neighborhood of γ to $-\mathcal{J}$ which preserves p_1 -structure, and parallel, and sends the meridian to minus the meridian. Call an arc γ equipped with such a diffeomorphism, a (-)pramed arc.

In this situation, let (M, γ, a) denote morphism from say (Σ, p, a) to (Σ', q, a) given by M after adjoining γ colored a to the graph. Also let $\text{Ext}(\gamma)$, the exterior of γ , be the complement the interior of the domain of ϕ_γ^\pm , with the boundary identified with $\pm I \times S^1$ by ϕ_γ^\pm , which is now orientation preserving. Suppose γ_1 is a (+)pramed arcs in a morphism M_1 , and γ_2 is a (-)pramed arc in a morphism M_2 . Let $M_{1\gamma_1} \#_{\gamma_2} M_2$ denote $\text{Ext}(\gamma_1) \cup_{(\phi_{\gamma_2^+})^{-1} \circ (\phi_{\gamma_1^-})} (\text{Ext}(\gamma_2))$. $M_{1\gamma_1} \#_{\gamma_2} M_2$ is a morphism from $\Sigma_1 \# \Sigma_2$ to $\Sigma'_1 \# \Sigma'_2$ where the connect sum has been taken by deleting neighborhoods of the endpoints of γ_1 and γ_2 . Let $\Sigma_{1,a}$ denote Σ_1 with the relevant point colored a , etc. The colored splitting theorem [BHMV,1.14] describes an isomorphism $V_p(\Sigma_1 \# \Sigma_2) \approx \bigoplus_{a \in \mathcal{C}} \Sigma_{1,a} \otimes \Sigma_{2,a}$. The following gluing formula follows easily from the description of this isomorphism and the definition of the maps induced by a morphism.

Lemma 3.6. *If γ_1 is a (+)pramed arcs in a morphisms M_1 , and γ_2 is a (-)pramed arc in a morphisms M_2 , then*

$$Z(M_{1\gamma_1} \#_{\gamma_2} M_2) = \bigoplus_{a \in \mathcal{C}} Z(M_1, \gamma_1, a) \otimes Z(M_2, \gamma_2, a)$$

Much more general gluing formulas are described in [Wa2] and the more recent paper [Ge]. The above formulas follow easily from the set-up in [BHMV]. Lemma (3.6) was used implicitly in [G] to prove (2.1) and (2.2) above. Note also that the trace of (3.6) yields a special case of (3.3).

§4 WINDING NUMBER ZERO

The contribution of the companion C to the formulas we derive for $Z(S, c)$ is $\langle (M(C), m_C, a) \rangle$. This may be more convenient than the contribution C_a of C to the formula (2.4) for $Z(C \star D(k), c)$, as $\langle (M(C), m_C, a) \rangle = \text{Trace} Z(C, a)$. For instance, if C itself is a satellite knot, we may use the methods of this paper to get our hands on $Z(C, a)$, and thus $\langle (M(C), m_C, a) \rangle$. We will let $C(a)$ denote $\langle (M(C), m_C, a) \rangle$. The data $(C_a)_{a \in \mathcal{C}}$ and $(C(a))_{a \in \mathcal{C}}$ is equivalent. In (8.1) and (8.2), we will give a change of basis matrix which relates these two vectors. In this way we will rederive (2.4) from (4.4) but without the additional hypothesis, that any C_s be nonzero.

If \mathcal{E} has linking number zero with the axis A , then we may pick a Seifert surface E for \mathcal{E} which misses A . Let $\Sigma_{\mathcal{E}}$ denote E capped off in $M(S)$. We may view A

as a subset of $M(S)$, and Σ_P misses A . Let $E_\mathcal{E}$ be a fundamental domain for the \mathbb{Z} -action on $M(\mathcal{E})_\infty$ with boundary two lifts of Σ , and continue to call the lift of A in $E_\mathcal{E}$, by A .

Let $Z(\Sigma_P; a) = Z((E_\mathcal{E}; a))$ where $(E_\mathcal{E}; a)$ denotes $E_\mathcal{E}$ constructed as above with A colored a . Note that $Z^\flat((E_\mathcal{E}; a))$ represents the Turaev-Viro module of $M(\mathcal{E})$ with A colored a , which we denote $Z(P; a)$.

Similarly let E_S be a fundamental domain for the \mathbb{Z} -action on $M(S)_\infty$ with boundary two lifts of Σ . Then we have $E_S = M(C)_{m_C} \wedge_A E(\mathcal{E})$. So by (3.5) we have

$$(4.1) \quad Z(S) \equiv \sum_{a \in \mathcal{C}} C(a) Z(\Sigma_P; a)$$

However we cannot replace $Z(\Sigma_P; a)$ by $Z(P; a)$, as the summation above requires that the maps $Z(\Sigma_P; a)$ have the same domain for each a . Also of course the sum of singular maps may be nonsingular. At this point we remind the reader that when we write $Z(S) \equiv X$ where X is an endomorphism or a matrix, we mean $Z(S) = X^\flat$, where X^\flat denotes the map after dividing out by the generalized 0-eigenspace.

Similarly let $Z(\Sigma_P; a, c) = Z((E_\mathcal{E}; a, c))$ where $(E_\mathcal{E}; a, c)$ denotes $E_\mathcal{E}$ constructed as above with A colored a , and the inverse image of a meridian for \mathcal{E} colored c . Note that $Z(\Sigma_P; a, c)^\flat$ represents the Turaev-Viro module of $M(\mathcal{E})$ with A colored a , and a meridian for \mathcal{E} colored c . We denote this by $Z(P; a, c)$.

$$(4.2) \quad Z(S, c) \equiv \sum_{a \in \mathcal{C}} C(a) Z(\Sigma_P; a, c)$$

For the pattern $D(k)$ of the k -twisted double we have:

$$(4.3) \quad Z(F_{D(k)}; a) = \eta \kappa^{-3} \left(\mu_i \sum_{t \in \mathcal{A}(i, j)} \mu_t^k (-1)^{a+t} [(a+1)(t+1)] \right)_{i, j \in \mathcal{C}}$$

Here $[n]$ denotes $\frac{A^{2n} - A^{-2n}}{A^2 - A^{-2}}$. We also have that $Z(\Sigma_{D(2)}; a, c)$ is given by:

$$(4.4) \quad \eta \kappa^{-3} \left(\mu_i \frac{\Delta_i}{\theta(i, i, c)} \sum_{t \in \mathcal{A}(i, j)} \frac{\mu_t^k (-1)^{a+t} [(a+1)(t+1)] \text{Tet} \begin{bmatrix} t & i & i \\ c & j & j \end{bmatrix}}{\theta(i, j, t)} \right)_{i, j \in \mathcal{A}(c)}$$

Note that (4.4) becomes (4.3) if $c = 0$. Let U denote the unknot. By [G,7.2], $U(a) = \delta_0^a$. Thus (4.2) shows that $Z(U \star D(k), c) \equiv Z(P, 0, c)$. Similarly $Z(U \star D(k)) \equiv Z(P, 0)$. Thus

$$(4.5) \quad Z(U \star D(k)) \equiv \eta \kappa^{-3} \left(\mu_i \sum_{t \in \mathcal{A}(i, i)} \mu_t^k (-1)^t [(t+1)] \right)$$

(4.6)

$$Z(U \star D(k), c) \equiv \eta \kappa^{-3} \left(\mu_i \frac{\Delta_i}{\theta(i, i, c)} \sum_{t \in \mathcal{A}(i, j)} \frac{\mu_t^k (-1)^t [(t+1)] \text{Tet} \begin{bmatrix} t & i & i \\ c & j & j \end{bmatrix}}{\theta(i, j, t)} \right)_{i, j \in \mathcal{A}(c)}$$

(4.5) becomes especially simple when $k = \pm 1$. $U \star D(1)$ is the figure eight knot, denoted $F8$. $U \star D(-1)$ is the right hand trefoil knot, denoted RT .

$$(4.7) \quad Z(F8) \equiv \eta \kappa^{-3} (\mu_i^2 \mu_j (-1)^{i+j} [(i+1)(j+1)])_{i, j \in \mathcal{E}}$$

$$(4.8) \quad Z(RT) \equiv \eta \kappa^{-3} (\mu_j^{-1} (-1)^{i+j} [(i+1)(j+1)])_{i, j \in \mathcal{E}}$$

These last two formulas, in the case p is even, are very close to the formulas for the maps induced by the monodromies of $F8$ and RT [G,11.1 & 11.2] obtained from [J] after making certain substitutions and some slight corrections. We haven't yet seen directly that they are similar.

The rest of this section contains a derivation of (4.3), and an indication of the proof of (4.4). We will also give the derivation of (4.7) and (4.8) from (4.5). As in [G,§5], we obtain the following description for $E_{\mathcal{E}}$ with the lift of A colored a as surgery on $S^2 \times I$ with a tunnel drilled out from the bottom and a 1-handle added to the top. Here and in later diagrams, the 'slab' $D^2 \times I$ denotes a part of a copy of $S^2 \times I$, the rest of which is left out of the picture but is included in the manifold depicted.

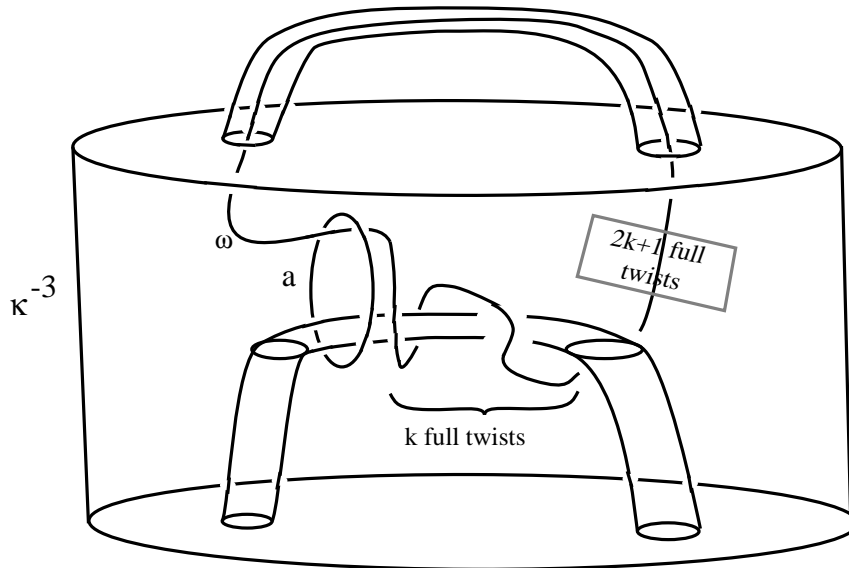

Figure 4

Here the scalar κ^{-3} indicates that we must multiply Z of the manifold pictured by this scalar to correct for a change in κ structure. We may compute the i

entry of the matrix for Z with respect to the basis orthonormal basis $\{e_i\}_{i \in \mathcal{C}}$ by adding a solid torus to bottom with core colored j and a solid torus to the top with core colored i to get a colored link in $S^1 \times S^2$. The invariant of this manifold is the evaluation of the diagram on the left of Figure 4. We expand out the lower $\omega = \eta \sum_{s \in \mathcal{C}} \Delta_s e_s$, and remove the $2k+1$ full twists at the cost of introducing μ_s^{2k+1} . The sum on the right of Figure 5 is over $s \in \mathcal{C}$.

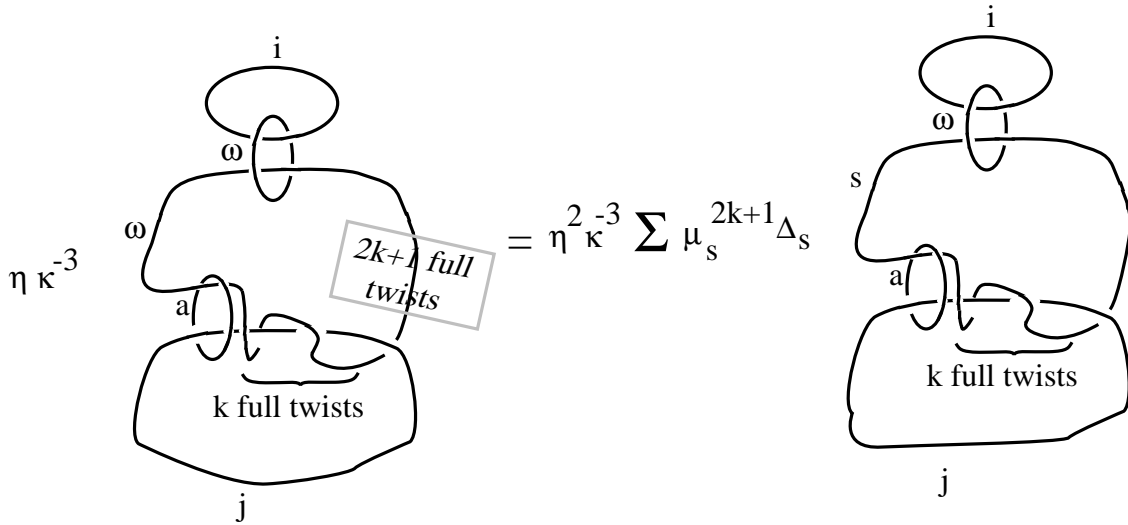

Figure 5

Then we use the following simplification where the sum is over $t \in \mathbb{A}(i, s)$. The second inequality uses [L1, Lemma 6] which is legitimate when p is odd as we have chosen our colors to be even. The sum is over $t \in \mathcal{C}$.

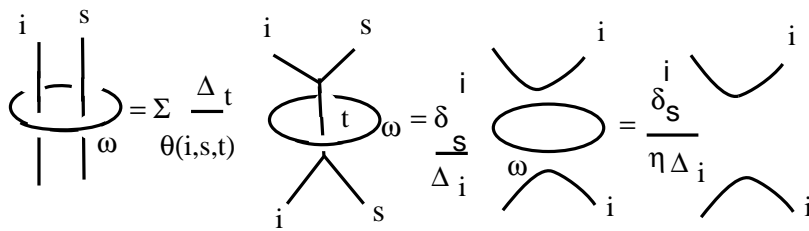

Figure 6

We obtain:

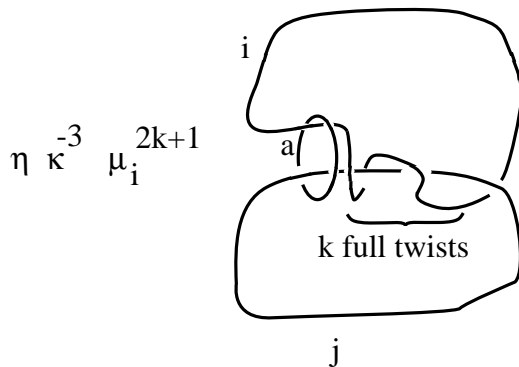

Figure 7

We simplify the two strands with k full twists by repeatedly using:

$$\begin{aligned}
 & \text{Diagram 1} = \frac{\Delta_t}{\theta(i,j,t) \mu_i \mu_j} \text{Diagram 2} \\
 & = \frac{\Delta_t}{\theta(i,j,t) \mu_i \mu_j} \text{Diagram 3} = \frac{\Delta_t \mu_t}{\theta(i,j,t) \mu_i \mu_j} \text{Diagram 4}
 \end{aligned}$$

Figure 8

Here the sum is over $t \in \mathcal{A}(i, j)$. Alternatively, one may use the same trick to take care of all k twists at once. Then one uses, say, [KL9.10(iii)] to collapse forks. The evaluation is seen to be

$$(4.9) \quad \eta \kappa^{-3} \mu_i^{2k+1} \sum_{t \in \mathcal{A}(i,j)} \left(\frac{\mu_t}{\mu_i \mu_j} \right)^k H(a, t) = \left(\frac{\mu_i}{\mu_j} \right)^k \eta \kappa^{-3} \mu_i \sum_{t \in \mathcal{A}(i,j)} \mu_t^k (-1)^{a+t} [(a+1)(t+1)]$$

Here $H(a, t)$ denotes the evaluation on the standard Hopf link with components colored a and t . Morton and Strickland evaluated $H(a, t)$ to be as $(-1)^{a+t} [(a+1)(t+1)]$ in the p even case[MS1,MS2]. However the same argument works in the p odd case. There is shift by one in the index of corresponding colors between this paper and [MS1,MS2]. The matrix on the right of (4.9) is simplified by removing the factor $(\frac{\mu_i}{\mu_j})^k$ by the change of basis $\{\mathbf{e}_j\} \rightarrow \{\mu_j^k \mathbf{e}_j\}$. So we obtain the matrix given on the left hand side of (4.3).

$E_{\mathcal{E}}$ with the lift of A colored a and the inverse image of a meridian of \mathcal{E} colored c can be pictured as in Figure 4 except one must add a single vertical line colored c . Consider the basis $\{\mathbf{f}_i\}$ for the vector space of a boundary of a solid torus with one point colored c , given by the core of the solid torus colored i and an edge joining the core to the point colored c , where $i \in \mathcal{A}(c)$. This basis is orthogonal but not orthonormal. $Z(P; a, c)$ is given by a matrix whose i, j entry is the quotient of the evaluations pictured in Figure 9. Here the indices i and j run over $\mathcal{A}(c)$. The same

methods of evaluation then yield (4.4).

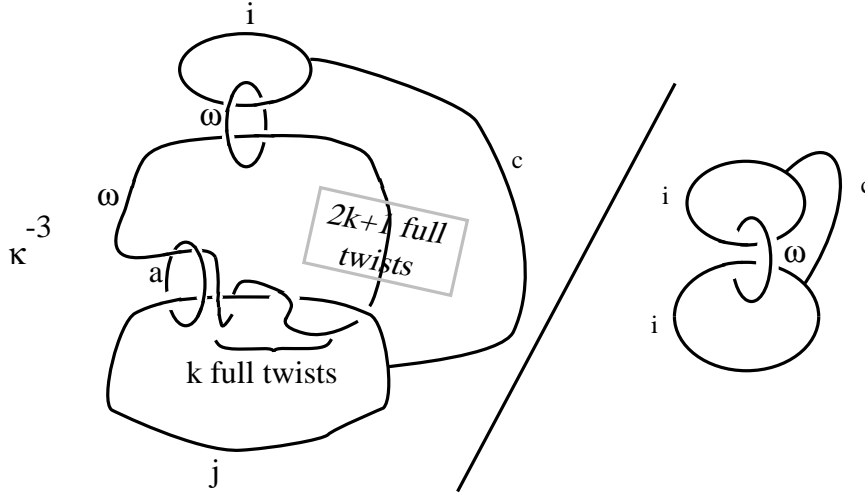

Figure 9

To derive (4.7,) we note that $\mu_i^{-1} \mu_j^{-1} \sum_{t \in \mathcal{A}(i,j)} \mu_t (-1)^t [(t+1)] = H(i, j)$ using Figure 8. Then we make use of the Morton-Strickland formula for $H(i, j)$. (4.8) follows from the conjugate of the above equation.

§5 WINDING NUMBER ONE

We may find a splitting surface Σ_1 in $M(C)$ which meets m_C in a single point x . Note Σ_1 itself may be formed from a Seifert surface for C in S^3 capped off in $M(C)$. If \mathcal{E} has linking number one with the axis A , then we may also pick a Seifert surface F_2 for \mathcal{E} which meets A in a single point say y . Let Σ_2 denote F capped off in $M(\mathcal{E})$. $\Sigma_{1x} \#_y \Sigma_2$ forms a splitting surface Σ in $M(S)$ assuming that the meridian around the point x is glued to the meridian around y as in (2.5). Here $x \#_y$ indicates that the connect summing takes places at the points x and y .

Let E_1 be a fundamental domain for the Z -action on $M(C)_\infty$ with boundary two lifts of Σ_1 . Let γ_1 denote the inverse image of m_C in E_1 . Let E_2 be a fundamental domain for the Z -action on $M(\mathcal{E})_\infty$ with boundary two lifts of Σ_2 . Let γ_2 denote the inverse image of A in E_2 . Similarly let E_S be a fundamental domain for the Z -action on $M(S)_\infty$ with boundary two lifts of Σ . Then we have $E_S = E_{1\gamma_1} \#_{\gamma_2} E_2$. So by (3.6)

$$(5.1) \quad Z(S) = \bigoplus_{a \in \mathcal{C}} Z(C, a) \otimes Z(P, a)$$

Similarly

$$(5.2) \quad Z(S, c) = \bigoplus_{a \in \mathcal{C}} Z(C, a) \otimes Z(P; a, c)$$

Although there is a clear analogy between (5.1) and (5.2) and (4.1) and (4.2), they are really quite different because of the differences between \sum and \oplus . In particular the direct sum of invertible automorphisms is still invertible but their sum need not be. Also \oplus and \otimes are well behaved with respect to the operation $Y \mapsto Y^2$.

The most important example of a winding number one satellite construction is the connect sum of two knots K_1 and K_2 . Here we take C to be K_1 and take E to be K_2 with the axis A , a meridian to K_2 . Then (5.1) yields (2.1). It is less obvious that (5.2) yields (2.2). Note that the meridian to \mathcal{E} and the axis in P are parallel.

Suppose M is a morphism from a surface Σ to itself which contains a framed arc γ going from point x in one copy of Σ to this same point x in the other copy. Suppose γ' is pushoff of γ going from, say, y in one copy of Σ to this same point y in the other copy. Let $\Sigma(b)$ denotes Σ with x colored b . Let $\Sigma(a, c)$ denotes Σ with x and y colored a and c . Let $M(b)$ denote M with γ colored b , $M(a, c)$ denote M with γ and γ' colored a and c . We have an isomorphism from $V(\Sigma(a, c))$ to $\bigoplus_{b \in \mathcal{A}(a, c)} V(\Sigma(b))$. The components of this map are given by Z of a Y graph colored a , b , and c embedded in $\Sigma \times I$. Moreover it is not hard to see that under this isomorphism $Z(M(a, c)) = \bigoplus_{b \in \mathcal{A}(a, c)} Z(M(b))$. The above observation shows that $Z(P, a, c) = \bigoplus_{b \in \mathcal{A}(a, c)} Z(P, b)$. Thus (5.2) implies (2.2).

We calculate now $Z(P, a)$ for certain pattern P . Consider Figure 10a. Here we have drawn \mathcal{E} as unknotted and A as tangled. However one can isotope A into a standard unknot and then \mathcal{E} becomes tangled. The resulting picture is the pattern P we mean to study. However the link we have drawn is actually symmetric so, in this case, P can be obtained by switching the labels of A and \mathcal{E} in Figure 10a.

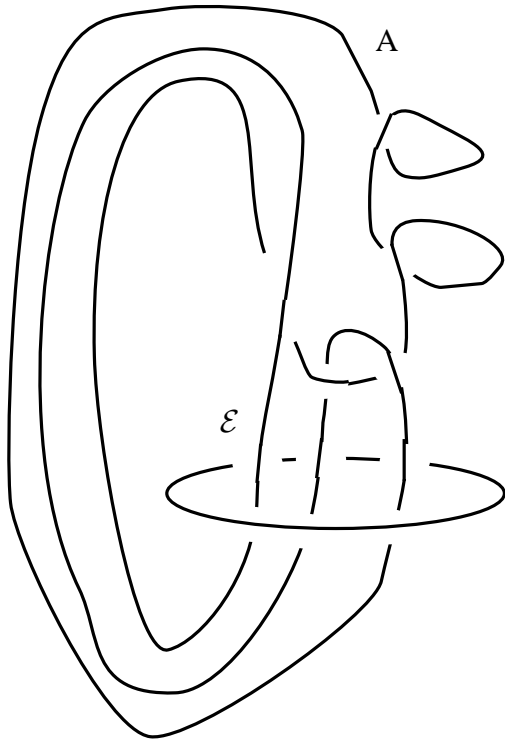

Figure 10a

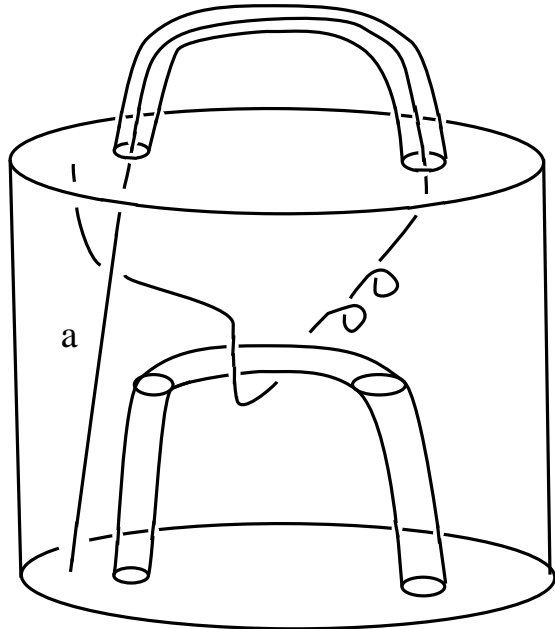

Figure 10b

For a general pattern \mathcal{E} might not be isotopic to the unknot. Then one would have to do surgery to S^3 in the complement of P to unknot \mathcal{E} first. This is Rolfsen's method for calculating the Alexander module of a knot. The resulting Figure which would play the role of Figure 10a then would have some circles labelled with an ω and a scalar correction for the p_1 -structure as in Figure 4. Figure 10b shows E where E is the morphism for which $Z^2(E) = Z(P, c) \cdot Z(E)$ is an endomorphism

of a vector space with the basis: $\{f_i\}$ indexed by $i \in \mathcal{A}(a)$. In fact using methods already developed in §4 we have that $Z(E)f_j = \sum_i z_{i,j}f_i$, where $z_{i,j}$ is the following quotient of two evaluations.

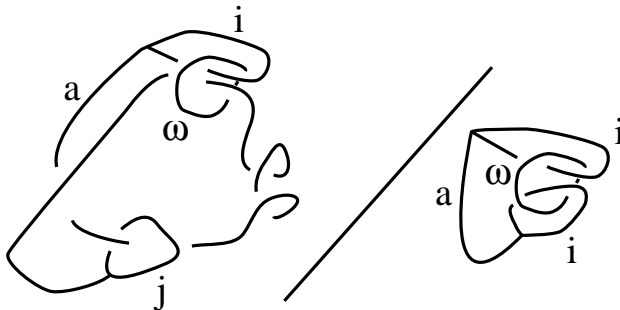

Figure 11

One then calculates that $z_{i,j}$ is zero if $i \neq a$, or if $\{a, a, a\} \notin \mathcal{A}$. Note that if $\{a, a, a\} \in \mathcal{A}$, then a is even. If $\{a, a, a\} \in \mathcal{A}$, we let γ_a denote $z_{a,a}$. We calculate that

$$\gamma_a = \frac{(-1)^{\frac{a}{2}} A^{-\frac{a(a+2)}{2}}}{\theta(a, a, a)} \sum_{t \in \mathcal{A}(a)} \frac{\mu_t \Delta_t}{\theta(a, a, t)} \text{Tet} \begin{bmatrix} t & a & a \\ a & a & a \end{bmatrix}$$

Let \mathcal{T} denote the set of colors c such that $\{c, c, c\}$ is admissible. Then $Z^b(E)$ is zero if $a \notin \mathcal{T}$. If $a \in \mathcal{T}$, then $Z^b(E)$ is multiplication by λ_a on a one dimensional space. Thus by (5.1) we have:

$$Z(S) = \bigoplus_{a \in \mathcal{T}} \gamma_a Z(C, a).$$

One could easily work out $Z(S, c)$ in a similar way, but the answer would be more complicated.

§6 N-WHEELS

The type of data that a pattern with winding number greater than one contributes to our formula for the Turaev-Viro module of a satellite is more complicated than an $f_p[t, t^{-1}]$ module or equivalently, a similarity class of an f_p - automorphism. In this section, we define and study n -wheels. We also construct invariants of any ordered link in S^3 with linking number n with values in n -wheels of isomorphisms. The contributions of a pattern and of a companion to the satellite formula will be n -wheels of isomorphisms.

Let n be a positive integer. An n -wheel U is a sequence of n vector space homomorphisms $u_i : U_i \rightarrow U_{i+1}$ where $i \in \mathbb{Z}_n$. A equivalence from an w -wheel $u_i : U_i \rightarrow U_{i+1}$ to an n -wheel $v_i : V_i \rightarrow V_{i+1}$ is a sequence of isomorphisms $T_i : U_i \rightarrow V_{i+k}$, for some fixed k such that $u_{i+k} \circ T_i = T_{i+1} \circ w_i$ for all i . If U is equivalent to V , we write $U \approx V$. These conditions may be visualized clearly as a commutative diagrams on an annulus. Note that a 1-wheel is simply a vector space endomorphism, and equivalence of 1-wheels is similarity. The dimension of an n -wheel $u_i : U_i \rightarrow U_{i+1}$ is simply $\dim(U_0)$. We also have zero dimensional n -wheels, which we denote as 0. The maps of a 1-dimensional n -wheel will be denoted by scalars.

Let \hat{u}_i denote the endomorphism of U_i given by the composition $u_{i-1} \circ u_{i-2} \cdots u_0 \circ u_{n-1} \cdots u_{i+1} \circ u_i$. Let $\mathcal{K}(U_i) = \cup_{k \geq 1} \text{Kernel}(\hat{u}_i^k)$. Let $U_i^b = U_i / \mathcal{K}(U_i)$. u_i induces a map u_i^b from U_i^b to U_{i+1}^b . In this way we get a new n-wheel of vector space isomorphisms.

If $U = (u_i : U_i \rightarrow U_{i+1})$, and $V = (v_i : V_i \rightarrow V_{i+1})$ are two n-wheels. We may define the tensor product by $U \otimes V = (u_i \otimes v_i : U_i \otimes V_i \rightarrow U_{i+1} \otimes V_{i+1})$. One has the easily proved lemma:

Lemma 6.1. $0 \otimes U = 0$. $U \otimes V \approx V \otimes U$. $U^b \otimes V^b \approx (U \otimes V)^b$. If $U \approx U'$ and $V \approx V'$, then $U \otimes V \approx U' \otimes V'$

Given an n-wheel $U = (u_i : U_i \rightarrow U_{i+1})_i$, we may form a new n-wheel $U(k)$ with by shifting all indices by k , ie. $U(k)_i = U_{k+i}$ and $u(k)_i = u_{k+i}$.

Lemma 6.2. If U is a n-wheel of isomorphisms, then $U \approx U(k)$ for all k .

Proof. The equivalence $U \approx U(1)$ is given by the maps u_i . \square

Given an n-wheel $U = (u_i : U_i \rightarrow U_{i+1})_i$, we may form an endomorphisms $\mathbb{S}(U)$ of the single vector space $\oplus_{i \in \mathbb{Z}_n} U_i$ by

$$\mathbb{S}(u_i)(\alpha_1 \oplus \alpha_2 \oplus \cdots \oplus \alpha_n) = (u_n(\alpha_n) \oplus u_1(\alpha_1) \oplus \cdots \oplus u_{n-1}(\alpha_{n-1})).$$

The similarity class of $\mathbb{S}(U)$ is determined by the equivalence class of U .

Suppose now for each $i \in \mathbb{Z}_n$ we have an endomorphism g_i of a vector space G_i , then we may form an n-wheel denoted by $\mathbb{W}(\{g_i\})$, as follows. Let $\mathbb{W}_i = G_{-i} \otimes G_{-i+1} \otimes \cdots \otimes G_{-i+n-1}$. Define $w_i : \mathbb{W}_i \rightarrow \mathbb{W}_{i+1}$ by $w_i(\alpha_{-i} \otimes \alpha_{-i+1} \otimes \cdots \otimes \alpha_{-i+n-1}) = g_{-i+n-1}(\alpha_{-i+n-1}) \otimes \alpha_{-i} \otimes \cdots \otimes \alpha_{-i+n-2}$. This choice of indexing may seem complicated but: $\mathbb{W}_0 = G_0 \otimes G_1 \otimes \cdots \otimes G_{n-1}$. $\mathbb{W}_1 = G_1 \otimes G_2 \otimes \cdots \otimes G_n$, and $w_0(\alpha_0 \otimes \alpha_1 \otimes \cdots \otimes \alpha_{n-1}) = g_{n-1}(\alpha_{n-1}) \otimes \alpha_0 \otimes \cdots \otimes \alpha_{n-2}$.

Lemma 6.3. $\mathbb{S}(U^b) = \mathbb{S}(U)^b$. Also $\mathbb{W}(\{g_i^b\}) = (\mathbb{W}(\{g_i\}))^b$.

Suppose we have an oriented framed knot K in a closed 3-manifold M and an epimorphism $\chi : H_1(M) \rightarrow \mathbb{Z}$. Assume that $n = \chi([K])$ is greater than one. Let Σ be surface dual to χ which meets K in exactly n points. Pick an arbitrary such point to call x_0 . Now travel along K in the direction of its orientation to the next point. Call this point x_1 . Continuing in this way, we may name all n points: $\{x_0, x_1, \cdots, x_{n-1}\}$. Suppose we are given a ordered w -tuple of colors $\vec{a} = (a_0, a_2, \cdots, a_{n-1})$ in \mathcal{C}^n . Let $F(\vec{a})$ denote F with x_i colored a_i . Let σ denote the transformation which sends $\vec{a} = (a_0, a_2, \cdots, a_{n-1})$ to $\sigma(\vec{a}) = (a_{n-1}, a_0, \cdots, a_{n-2})$. Let $n(\vec{a})$ be the least exponent e such that $\sigma^e(\vec{a}) = \vec{a}$. Let E be a fundamental domain for the \mathbb{Z} action on M_∞ with boundary a copies of $-\Sigma$ and Σ . The inverse image of K consists of n framed arcs. Let $E(\vec{a})$ is obtained by coloring the arc which starts at x_i in $-\Sigma$ and goes to x_{i+1} in F by a_i , for all i . $E(\vec{a})$ is a morphism from $F(\vec{a})$ to $F(\sigma\vec{a})$.

Let $W_p(L; \vec{a})$ denote the $n(\vec{a})$ -wheel given by U^b where U is the wheel given by $U_i = V_p(F(\sigma^i \vec{a}))$, and $u_i = Z(E(\sigma^i \vec{a}))$. We will usually omit the subscript p . By (6.3) $W(L; \vec{a})$ is equivalent to $W(L, \sigma^i \vec{a})$, so the equivalence class of $Z(L; \vec{a})$ only depends on the cyclic ordering of \vec{a} .

The proof of Theorem (1.1) extends to this situation and we have:

Theorem (6.4). *The equivalence class of $W(K; a)$ is an invariant of the isotopy class of K .*

Now suppose L is a link two components K_1 and K_2 with linking number w greater than one. Let M be zero framed surgery along K_1 with p_1 -structure with zero sigma invariant, and let $K = K_2$. Define $W(L; \vec{a})$ to be the $n(\vec{a})$ -wheel $W(K_2; \vec{a})$ defined above. It will also be useful to do all the above with a color c assigned to a meridian of K_2 and the inverse images of this meridian in E . In this way, we obtain an n -wheel $W(L; \vec{a}, c)$ well defined up to equivalence. We will let $U(L; \vec{a}, c)$ denote $U(\vec{a})^b$ in the above construction. Similarly we let $u(L; \vec{a}, c)$ denote the map from $U(\vec{a})$ to $U(\sigma\vec{a})$.

§7 HIGHER WINDING NUMBERS

If view a pattern link P as a link of two components where \mathcal{E} is taken for K_1 and A is taken for K_2 , and P has winding number w , we obtain $n(\vec{a})$ -wheels denoted $Z(P; \vec{a})$, and $Z(P; \vec{a}, c)$, for each \vec{a} in C^w . These only depend on \vec{a} up to cyclic permutation.

The (2,1) cable pattern. We consider the pattern $P(2, 1)$ from Figure 2 with winding number two, and calculate $W(P(2, 1); \vec{a}, c)$. $U(P(2, 1), (a_1, a_2), c)$ is zero if $c \notin \mathcal{A}(a_1, a_2)$. If $c \in \mathcal{A}(a_1, a_2)$, then $U(P(2, 1), (a_1, a_2), c)$ is one dimensional and $u(P(2, 1), (a_1, a_2), c)$ is the map induced by the manifold pictured on the left of Figure 12.

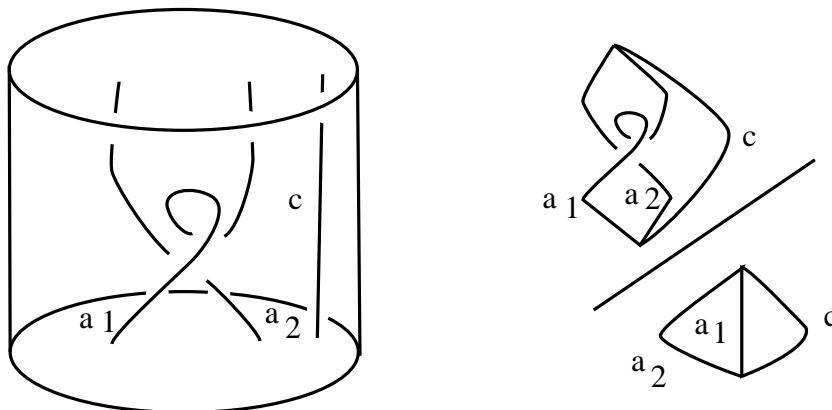

Figure 12

So $u(P(2, 1); (a_1, a_2), c)$ is multiplication given by the quotient of evaluations on the left of Figure 12, which we denote by $\nu_{a_1, a_2, c}$. One easily has $\nu_{a_1, a_2, c} = \mu_{a_1}^{-1}(\lambda_c^{a_1, a_2})^{-1}$. We use the (λ_c^{ab}) notation for the 3-vertex term [KL, 9.9]. Note $(\lambda_0^{ab})^0 = \delta_a^b \mu_a$. See [MV] for a simple derivation of λ_c^{ab} . Of course $u(P(2, 1); (a_2, a_1), c)$ is multiplication by $\nu_{a_2, a_1, c}$.

If we specialize to $p=5$, then $\mathcal{C} = \{0, 2\}$, and $\mathcal{A} = \{\{0, 0, 0\}, \{2, 2, 0\}, \{2, 2, 2\}\}$. We have the following non-zero wheels for this pattern. The one-dimensional 1-wheels $W(P(2, 1); (0, 0), 0) = 1$, $W(P(2, 1); (2, 2), 0) = -\bar{A}$, and $W(P(2, 1); (2, 2); 2) = A^3$. We also have a one dimensional 2-wheel $W(P; (0, 2), 2)$ with $u(P(2, 1); (0, 2), 2) = 1$, and $u(P(2, 1); (2, 0), 2) = A^2$.

The (3,1) cable pattern. Consider now the pattern $P(3, 1)$ of the (3,1) cable

axis A develops two negative twists in the isotopy. $W(P(3, 1); (a, b, c))$ is zero if $\{a, b, c\} \notin \mathcal{A}$. If $\{a, b, c\} \in \mathcal{A}$, $W(P(3, 1); (a, b, c))$ is one dimensional. The maps (with respect to the basis given a ‘T’ diagram with edges labelled a , b , and c) are multiplication by the quotient of the evaluations on the right of Figure 13.

The numerator becomes the denominator after removing the two kinks and two 3-vertex moves. So this quotient is $\mu_a^{-2}(\lambda_c^{ab})^{-1}(\lambda_b^{ac})^{-1} = \mu_a^{-1}$. Thus for each $c \in \mathcal{T}$ we have a one wheel $W(P(1, 3); (c, c, c)) = \mu_c^{-1}$. If $a \neq b$, for each $c \in \mathcal{A}(a, b)$. We have the 3-wheel $W(P(3, 1); (a, b, c))$ with $u(P(3, 1); (a, b, c)) = \mu_a^{-1}$.

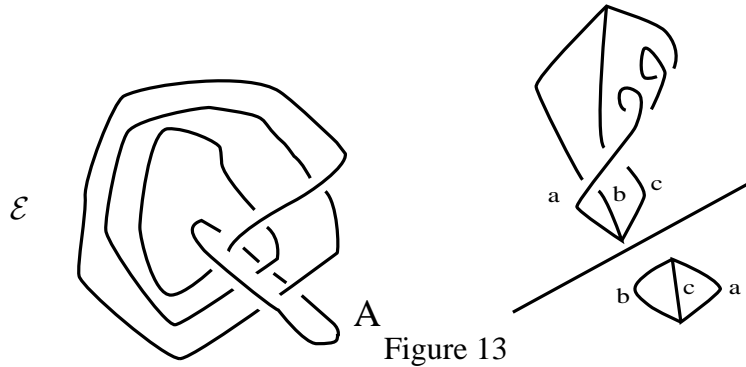

Figure 13

If we specialize to $p=5$, we have the following non-zero wheels for this pattern. We have the following one-dimensional 1-wheels or (simply vector space automorphisms). $W(P(3, 1); (0, 0, 0)) = 1$, and $W(P(3, 1); (2, 2, 2)) = A^2$. We also have two one dimensional 3-wheels: $W(P(3, 1); (0, 0, 2))$ with $u(P(3, 1); (0, 0, 2)) = 1$, $u(P(3, 1); (2, 0, 0)) = A^2$, and $u(P(3, 1); (0, 2, 0)) = 1$. and $W(P(3, 1); (2, 2, 0))$ with $u(P(3, 1); (2, 2, 0)) = A^2$, $u(P(3, 1); (0, 2, 2)) = 1$, and $u(P(3, 1); (2, 0, 2)) = A^2$.

The 3-strand 1-bight turk’s head pattern. Consider now the pattern $T(3, 1)$ shown on the left of Figure 14. This link is symmetric. As the writhe of \mathcal{E} is zero, no twists develop in the framed axis A during the isotopy. $W(T(3, 1); (a, b, c))$ is zero if $\{a, b, c\} \notin \mathcal{A}$. If $\{a, b, c\} \in \mathcal{A}$, $W(T(3, 1); (a, b, c))$ is one dimensional. The maps (with respect to the basis given by a ‘T’ diagram with edges labelled a , b , and c) are multiplication by the quotient of the evaluations on the right of Figure 14.

The numerator becomes the denominator after two 3-vertex moves. So this quotient is $(\lambda_c^{ab})(\lambda_b^{ac})^{-1} = \mu_b\mu_c^{-1}$. Thus for each $c \in \mathcal{T}$, we have a one wheel $W(T(1, 3); (c, c, c)) = 1$. If $a \neq b$, for each $c \in \mathcal{A}(a, b)$, we have the 3-wheel $W(T(1, 3); (a, b, c))$ with $u(T(1, 3), (a, b, c)) = \mu_b\mu_c^{-1}$.

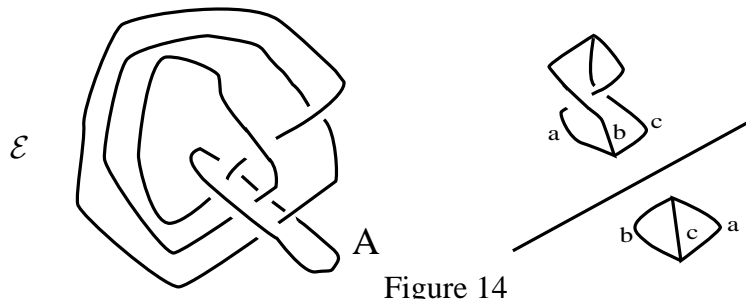

Figure 14

If we specialize to $p=5$, we have the following non-zero wheels for this pattern. We have the following one dimensional 1-wheels. $W(T(3, 1); (0, 0, 0)) = 1$, and

$W(T(3, 1); (2, 2, 2)) = 1$. We also have two one dimensional 3-wheels: $W(T(3, 1); (0, 0, 2))$ with $u(T(3, 1); (0, 0, 2)) = A^2$, $u(T(3, 1); (2, 0, 0)) = 1$, $u(T(3, 1); (0, 2, 0)) = A^8$, and $W(T(3, 1); (2, 2, 0))$ with $u(T(3, 1); (2, 2, 0)) = A^8$, $u(T(3, 1); (0, 2, 2)) = 1$, and $u(T(3, 1); (2, 0, 2)) = A^2$.

Wheels associated to the companion. Again let $\vec{a} = (a_0, a_2, \dots, a_{w-1})$ in \mathcal{C}^w . Then we obtain a sequence of $n(\vec{a})$ isomorphisms $Z_p(C, a_i)$. We may define the $n(\vec{a})$ -wheel of the companion associated to a sequence of colors \vec{a} by $\mathbb{W}_p(C, \vec{a}) = \mathbb{W}(\{Z_p(C, a_i)\})$. We will usually omit the subscript p . Note that the isomorphism class of this $n(\vec{a})$ -wheel also only depends on the cyclic ordering of \vec{a} . We let $\mathfrak{U}(C, (a_1, a_2, \dots, a_{n(\vec{a})}))$ denote the vector space $Z(C, a_1) \otimes Z(C, a_2) \otimes \dots \otimes Z(C, a_{n(\vec{a})})$. Let $\mathfrak{u}(C, (a_1, a_2, \dots, a_{n(\vec{a})}))$ denote associated isomorphism from $\mathfrak{U}(C, (a_1, a_2, \dots, a_{n(\vec{a})}))$ to $\mathfrak{U}(C, (a_{n(\vec{a})}, a_2, \dots, a_{n(\vec{a})-1}))$.

Wheels associated to figure eight companion at $\mathfrak{p}=5$. As an example, suppose C is the figure eight knot F8. This is the 1-twisted double of the unknot. In [G], we calculated that has $Z_5(F8)$ two eigenvectors: e_1 with eigenvalue A , and e_2 with eigenvalue \bar{A} . Also $Z_5(F8, 2)$ is the identity map on a one dimensional space. Let f denote a vector in this space. Of course these calculations also follow from (4.6) and (4.7).

We calculate the nonzero wheels $\mathbb{W}(F8, \vec{a})$ associated to a color vector \vec{a} of length two.

So $\mathbb{W}(F8, (0, 0))$ is a 4-dimensional 1-wheel. $\mathfrak{U}(F8, 0, 0)$ has a basis of elements of the form $e_i \otimes e_j$ ordered lexicographically. With respect to this basis $\mathfrak{u}(F8, (0, 0))$ is given by \mathfrak{G}_1 , the direct sum of the three matrices: (A) , $\begin{pmatrix} 0 & A \\ \bar{A} & 0 \end{pmatrix}$ and (\bar{A}) . \mathfrak{G}_1 has eigenvalues $1, -1, A$, and \bar{A} .

$W(F8, (2, 2))$ is a 1-dimensional 1-wheel given by the identity. $\mathfrak{U}(F8, 0, 2)$ has $e_1 \otimes f, e_2 \otimes f$ as an ordered basis. $\mathfrak{U}(F8, 2, 0)$ has $f \otimes e_1, f \otimes e_2$ as an ordered basis. With respect to these bases $W(F8, (0, 2))$ is a 2-dimensional 2-wheel with $\mathfrak{U}(F8, 0, 2)$ the identity and $\mathfrak{U}(F8, 2, 0)$ given by \mathfrak{G}_2 , the direct sum of the two matrices: (A) , (\bar{A}) .

We calculate now the nonzero wheels $\mathbb{W}(F8, \vec{a})$ associated to a color vector \vec{a} of length three. $\mathbb{W}(F8, (0, 0, 0))$ is a 8-dimensional 1-wheel. $\mathfrak{U}(F8, (0, 0, 0))$ has $e_1 \otimes e_1 \otimes e_1, e_2 \otimes e_2 \otimes e_2, e_1 \otimes e_2 \otimes e_2, e_2 \otimes e_1 \otimes e_2, e_2 \otimes e_2 \otimes e_1, e_1 \otimes e_1 \otimes e_2, e_2 \otimes e_1 \otimes e_1, e_1 \otimes e_2 \otimes e_1$ as ordered basis. With respect to this basis $\mathfrak{u}(F8, (0, 0, 0))$ is given by

\mathfrak{G}_3 the direct sum of the four matrices: (A) , (\bar{A}) , $\begin{pmatrix} 0 & 0 & A \\ \bar{A} & 0 & 0 \\ 0 & \bar{A} & 0 \end{pmatrix}$, $\begin{pmatrix} 0 & 0 & A \\ \bar{A} & 0 & 0 \\ 0 & A & 0 \end{pmatrix}$.

\mathfrak{G}_3 has eigenvalues A , and \bar{A} , the three cube roots A , and the three cube roots of \bar{A} .

$\mathbb{W}(F8, (2, 2, 2))$ is a 1-dimensional 1-wheel given by the identity.

$\mathbb{W}(F8, (0, 0, 2))$ is a 4-dimensional 3-wheel. $\mathfrak{U}(F8, (0, 0, 2))$ has a basis of elements of form $e_i \otimes e_j \otimes f$ ordered lexicographically. $\mathfrak{U}(F8, (2, 0, 0))$ has a basis of elements of form $f \otimes e_i \otimes e_j$ ordered lexicographically. $\mathfrak{U}(F8, (0, 2, 0))$ has a basis of elements of form $e_i \otimes f \otimes e_j$ ordered lexicographically. With respect to these basis $\mathfrak{u}(F8, (0, 0, 2))$ is by the the identity matrix. $\mathfrak{u}(F8, (2, 0, 0))$ and $\mathfrak{u}(F8, (0, 2, 0))$ are both given by \mathfrak{G}_1 .

$\mathbb{W}(F8, (2, 2, 0))$ is a 2-dimensional 3-wheel. $\mathfrak{U}(F8, (2, 2, 0))$ has a basis of elements of form $f \otimes f \otimes e_i$ ordered lexicographically. $\mathfrak{U}(F8, (0, 2, 2))$ has a basis of elements

of form $e_i \otimes f \otimes f$ ordered lexicographically. $\mathfrak{U}(F8, (2, 0, 2))$ has a basis of elements of form $f \otimes e_i \otimes f$ ordered lexicographically. With respect to these basis, $\mathfrak{u}(F8, (2, 2, 0))$ is given by \mathfrak{G}_2 . $\mathfrak{u}(F8, (0, 2, 2))$ and $\mathfrak{u}(F8, (2, 0, 2))$ are given by the the identity matrix.

The main formula. Let \mathcal{O}^w denote a set consisting of a single element from each orbit for the \mathbb{Z}_w cyclic action on \mathcal{C}^w , generated by σ . We have the following generalization of (5.2). Note that it does not apply to winding number zero patterns.

Theorem (7.1). *If $S = C \star P$, and P has winding number w , then:*

$$Z(S, c) = \bigoplus_{\vec{a} \in \mathcal{O}^w} \mathbb{S}(\mathbb{W}(C, \vec{a}) \otimes W(P; \vec{a}, c))$$

Proof. Let Σ_C be a splitting surface for $M(C)$ which meets m_C in a single point x . Let Σ_P be a splitting surface for in $M(\mathcal{E})$, which meets the axis in consecutive (along the axis) points x_0, x_2, \dots, x_{w-1} . Let Σ_S be the connected sum of Σ_P at the points x_0, x_2, \dots, x_{w-1} with w copies of Σ_C at the point x . Σ_P serves as a splitting surface for $M(S)$ in a natural way.

Let E_C be the fundamental domain for the \mathbb{Z} -action on $M(C)_\infty$ with boundary two lifts of Σ_C . Let γ denote the inverse image of m_C in E_C . Let E_P be the fundamental domain for the \mathbb{Z} -action on $M(\mathcal{E})_\infty$ with boundary two lifts of Σ_P . The inverse image of A in E_P consists of w arcs $\gamma_0, \gamma_1 \dots \gamma_{w-1}$ where γ_i goes from x_i in $-\Sigma_P$ to x_{i+1} in $-\Sigma_P$. Let T be $\Sigma_C \times I$, τ be the arc $\{x\} \times I$ in T . Let E_S be the fundamental domain for the \mathbb{Z} -action on $M(S)_\infty$ with boundary two lifts of Σ_P . Then we have:

$$E_S = (\dots((E_{P\gamma_{w-1}} \wedge_\gamma E_C)_{\gamma_0} \wedge_\tau T)_{\gamma_1} \wedge \dots)_{\gamma_{w-2}} \wedge_\tau T$$

The result then follows from (3.6) \square

The (2,1) cable of the figure eight. We consider first the case $p=5$. \mathcal{O} has three elements $(0, 0)$, $(2, 2)$ and $(2, 0)$. We have $Z_5(S)$ is the direct sum of contributions from each element of \mathcal{O} . $(2, 0)$ contributes zero, as $W(P(2, 1); (0, 2)) = 0$. $(2, 2)$ contributes $\mathbb{W}(F8, (2, 2)) \otimes W(P(2, 1); (2, 2))$. This is a one dimensional vector space with eigenvalue $-\bar{A}$. $(0, 0)$ contributes $\mathbb{W}(F8, (0, 0)) \otimes W(P(2, 1); (0, 0))$. This is a 4- dimensional vector space with eigenvalues: $1 -1, A$, and \bar{A} . So the eigenvalues of $Z_5(S)$ are $1, -1, A, \bar{A}$, and $-\bar{A}$.

Consider now just the contribution of $\vec{0} = (0, 0)$ to $Z_p(S)$ $W_p(P(2, 1); \vec{0})$ is the identity map on a one dimensional space. So the contribution is just the 1-wheel $\mathbb{W}_p(F8, (0, 0))$. In general, we know that $Z(F8)$ is a unitary matrix, and so is diagonalizable with eigenvalues all of norm one as F8 is fibered and has genus one. Since $F8$ is amphichiral, the non-real eigenvalues come in conjugate pairs. Consider a pair e_1 and e_2 of eigenvectors with conjugate and therefore inverse eigenvalues. Then the automorphism restricted to the subspace spanned by $e_1 \otimes e_2$ and $e_2 \otimes e_1$ is direct summand with eigenvalues 1 and -1 . Thus in general $Z_p(F8 \star P(2, 1))$ has one and minus one among its eigenvalues.

In his thesis, Miyazaki showed $F8 \star P(2, 1)$ was not a ribbon knot [M]. It is an algebraically slice fibered knot. He showed that the monodromy does not extend over any handlebody. If the knot were ribbon, a theorem of Casson and Gordon

asserts that the closed off monodromy of a fibered homotopy ribbon knot must extend over a handlebody [CG]. This same theorem was used to prove Theorem(1.2). We had hoped to recover Miyazaki's result using Theorem (1.2). So far we have not been able to do this. We working on some refinements of Theorem(1.2). Perhaps using another TQFT would also help.

Two winding number three satellites of the figure eight knot at p=5. These examples will illustrate the operation \mathbb{S} in a nontrivial way. We consider first $Z_5(F8 \star P(3, 1))$. The contribution of $(0, 0, 0)$ is just the 1-wheel $\mathbb{W}(F8, (2, 2, 2))$, given by \mathfrak{G}_3 . The contribution of $(2, 2, 2)$ is just $W(P(3, 1), (2, 2, 2))$, given by (A^2) . The contribution of orbit of $(0, 0, 2)$ is given by the block matrix

$$\begin{pmatrix} 0 & 0 & \mathfrak{G}_1 \\ I_{4 \times 4} & 0 & 0 \\ 0 & A^2 \mathfrak{G}_1 & 0 \end{pmatrix}$$

The contribution of orbit of $(2, 2, 0)$ is given by the block matrix

$$\begin{pmatrix} 0 & 0 & A^2 I_{2 \times 2} \\ A^2 \mathfrak{G}_2 & 0 & 0 \\ 0 & I_{2 \times 2} & 0 \end{pmatrix}.$$

In particular, the characteristic polynomial of $Z_3(F8 \star P(3, 1))$ is: $(x - A)(x - \bar{A})(x^3 - A)(x^3 - \bar{A})(x - A^2)(x^6 + (1 - A^3)x^3 - A^3)(x^{12} - (A^3 + A^2 + A)x^9 + 2(A^3 - 1)x^6 + (A^2 + A + 1)x^3 - A^3)$

$Z_5(F8 \star T(3, 1))$ way be worked out in the same way as $Z_5(F8 \star P(3, 1))$. We will just give its characteristic polynomial: $(x - A)(x - \bar{A})(x^3 - A)(x^3 - \bar{A})(x - 1)(x^{12} - (A^3 + A^2 + A)x^9 + 2(A^3 - 1)x^6 + (A^2 + A + 1)x^3 - A^3)(x^6 + (A^3 - A^2 - 1)x^3 + 1)$

§8 DERIVATIONS OF (2.4)

Derivation along the lines of [G]. We need the hypothesis that C_s are nonzero for $s \in \mathcal{A}(c)$ for this approach. Consider the exterior of the loop labelled i in Figure 8a of that paper. Instead of completing it to a diagram in S^3 , we should instead complete it to a diagram in $S^1 \times S^2$. In this way one may make use of the orthogonality of the bases described in [BHMV,4.11]. The matrix one then needs to invert is then already diagonal. In fact we have the following variant of Theorem (7.7) of [G]. $Z(C \star D(k), c)$ is given by matrix whose i,j entrie is quotient of the evaluations in Figure 15 below. Here i, j range over $\mathcal{A}(c)$

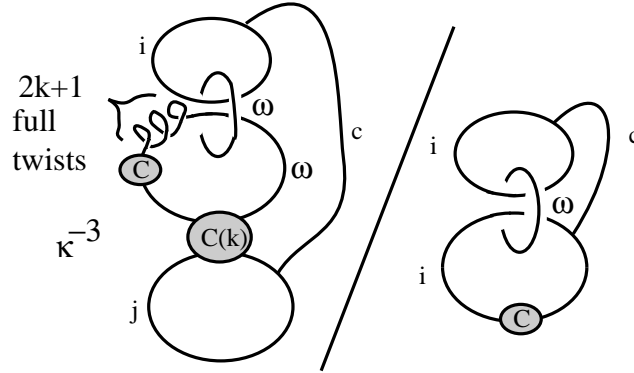

Figure 15

Let $B(c)_{i,j}$ be the evaluation of the numerator and $L(c)_i$ be the evaluation of the denominator. The grey disk labelled C indicates that a string diagram for C with zero writhe should be inserted. The grey disk labelled $C(k)$ stands for two parallel strands along a string diagram for C with zero writhe with k full additional twists between the strands added. κ^{-3} simply means multiply that scalar times the evaluation of the rest of diagram. To evaluate expand the lower loop labelled ω using $\omega = \eta \sum_{s \in c} \Delta_s e_s$. Then we use the simplification of Figure 6.

Now one has a strand colored i with $2k + 1$ full twists and C with zero writhe tied into it. The twists contribute a factor of μ_i^{2k+1} , and C contributes $\frac{C_i}{\Delta_i}$. Thus $B(c)_{i,j} = \kappa^{-3} \mu_i^{2k+1} \frac{C_i}{\Delta_i}$ times the evaluation of:

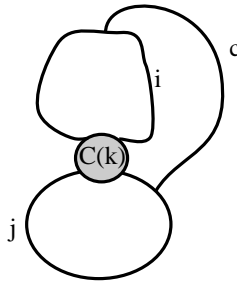

Figure 16

Now we could remove the k full twists embedded in $C(k)$ one at a time using Figure 8. However we can use the same trick moving all of C onto the strand labelled t to show:

$$\begin{array}{c} i \\ \text{---} \\ \text{---} \\ j \end{array} \text{---} \text{C}(k) \text{---} \begin{array}{c} \text{---} \\ \text{---} \\ j \end{array} = \sum_{\theta(i,j,t)} \frac{C_t}{\theta(i,j,t)} \mu_i^{-k} \mu_j^{-k} \mu_t^k \begin{array}{c} i \\ \text{---} \\ \text{---} \\ j \end{array} \text{---} \begin{array}{c} \text{---} \\ \text{---} \\ t \end{array}$$

Figure 17

Thus

$$B(c)_{i,j} = \kappa^{-3} \mu_i^{2k+1} \frac{C_i}{\Delta_i} \sum \frac{C_t}{\theta(i,j,t)} \left(\frac{\mu_t}{\mu_i \mu_j} \right)^k \text{Tet} \begin{bmatrix} t & i & i \\ c & j & j \end{bmatrix}.$$

Similarly

$$L(c)_i = \frac{C_i \theta(i, i, c)}{\eta \Delta_i^2}.$$

Note $L(c)_i$ is invertible if and only iff C_i is invertible. Thus $L(c)^{-1}B(c)$ is given by $(\frac{\mu_i}{\mu_j})^k$ times the left hand side of (2.4). Under the change of basis $\{f_j\} \rightarrow \{\mu_j^k f_j\}$, we obtain the matrix given on the left hand side of (2.4).

A change of basis for the vector space of a torus. Let T^2 be the boundary of a solid torus. Above we have made use of the basis $\{e_i\}_{i \in \mathcal{C}}$ for $V(T^2)$ where e_i given by coloring a framed core for the solid torus i . Consider the basis $\{g_i\}_{i \in \mathcal{C}}$ for $V(T^2)$ where g_i is given by labelling a framed core for the solid torus with ω and coloring the meridian j . Then $\langle g_i, e_j \rangle_{T^2}$ is given by the evaluation of Figure 18. Using Figure 6, this evaluates to $\eta H(i, j) = \eta(-1)^{i+j}[(i+1)(j+1)]$. Thus $g_i = \eta \sum_{j \in \mathcal{C}} (-1)^{i+j} [(i+1)(j+1)] e_j$. Applying this in a tubular neighborhood of a knot C , and recalling that $\eta^2 = \frac{-(A^2 - A^{-2})^2}{p}$, we obtain

$$(8.1) \quad C(i) = \frac{-(A^2 - A^{-2})^2}{p} \sum_{j \in \mathcal{C}} (-1)^{i+j} [(i+1)(j+1)] C_j$$

The extra factor of η comes from the fact that the invariant of S^3 with standard p_1 -structure with C colored j is ηC_j . Now it is shown that $\eta((-1)^{i+j} [(i+1)(j+1)])_{i,j \in \mathcal{C}}$ is equal to its own inverse in [MS2] in the case that p is even. One can check that this is true in general. Actually the symmetry of the above picture shows that $e_j = \eta \sum_{i \in \mathcal{C}} (-1)^{i+j} [(i+1)(j+1)] g_i$. This shows that $\eta((-1)^{i+j} [(i+1)(j+1)])_{i,j \in \mathcal{C}}$ is its own inverse! Inverting the above equation, then yields

$$(8.2) \quad C_t = \sum_{a \in \mathcal{C}} (-1)^{a+t} [(a+1)(t+1)] C(a).$$

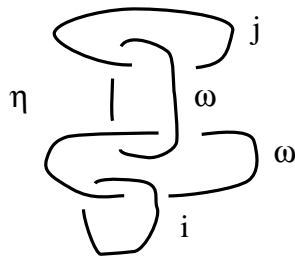

Figure 18

Derivation of (2.4) from (4.2)& (4.4). Substitute (4.4) into (4.2). Interchange the order of summation. Then making use of (8.2), we obtain (2.4) without any hypothesis on C_t .

REFERENCES

[BHMV] C. Blanchet, N. Habegger, G. Masbaum, P. Vogel, *Topological quantum field theories derived from the Kauffman bracket*, *Topology* **34** (1995), 883-927.
 [CG] A. J. Casson, C. McA. Gordon, *A loop theorem for duality spaces and fibred ribbon knots*, *Journal of Mathematical Analysis and Applications* **71** (1982), 119-132.

- [Ge] R. Gelca, *Topological quantum field theory with corners based on the Kauffman bracket*, eprint q-alg/9603002 (1996).
- [G] P. Gilmer, *Invariants for 1-dimensional cohomology classes arising from TQFT*, Top. and its Appl. (to appear).
- [J] L. Jeffrey, *Chern-Simons-Witten invariants of lens spaces and torus bundles, and the Semiclassical Approximation*, Commun. Math. Phys. **147** (1992), 563-604.
- [K] L.H. Kauffman, *State models and the Jones polynomial*, Topology **26** (1987), 395-407.
- [KL] L.H. Kauffman, S. Lins, *Temperley-Lieb Recoupling Theory and Invariants of 3-manifolds*, Annals of Math Studies (1994), Princeton Univ. Press, Princeton N.J.
- [KM] R. Kirby, P. Melvin, *Dedekind sums, μ -invariants, and the signature cocycle*, Math. Ann. **299** (1994), 231-267.
- [L] W.B.R. Lickorish, *The skein method for three manifolds*, J. of Knot Th. and its Ramif. **2** (1993), 171-194.
- [Li] R. A. Litherland, *Cobordism of Satellite Knots*, Contemp. Math. **35** (1984), 327-362.
- [LM] C. Livingston and P. Melvin, *Abelian invariants of satellite knots*, Geometry and topology (College Park, Md., 1983-84), Lecture Notes in Math **1167** (1985), Springer, 217-227.
- [MV] G. Masbaum, P. Vogel, *3-valent graphs and the Kauffman bracket*, Pacific J. Math. **164** (1994), 361-381.
- [M] K. Miyazaki, *Nonsimple ribbon fibered knots*, Trans A.M.S. **341** (1994), 1-44.
- [MS1] H. R. Morton and P. M. Strickland, *Jones polynomial invariants for knots and satellites*, Math. Proc. Cambridge Philos. Soc. **109** (1991), 83-103.
- [MS2] ———, *Satellites and surgery invariants*, Knots 90, de Gruyter, 1992, pp. 798-820.
- [RT] N. Reshetikhin, V. Turaev, *Invariants of 3-manifolds via link-polynomials and quantum groups*, Invent. Math. **103** (1991), 547-597.
- [TV] V. Turaev, O. Viro, Lecture given by Viro at a conference in Manhattan, Kansas March 1993.
- [Wa1] K. Walker, Lecture at Knots 90, Osaka Japan (1990).
- [Wa2] ———, *On Witten's 3-manifold invariants*, preprint (1991).
- [W] E. Witten, *Quantum field theory and the Jones polynomial*, Commun. Math. Phys. **121** (1989), 351-399.

DEPARTMENT OF MATHEMATICS, BATON ROUGE, LA 70803 U.S.A
E-mail address: gilmer@math.lsu.edu