

# ON ASSOCIATORS AND THE GROTHENDIECK-TEICHMULLER GROUP I

DROR BAR-NATAN

*Appeared in Selecta Mathematica, New Series 4 (1998) 183–212*

ABSTRACT. We present a formalism within which the relationship (discovered by Drinfel'd in [Dr1, Dr2]) between associators (for quasi-triangular quasi-Hopf algebras) and (a variant of) the Grothendieck-Teichmuller group becomes simple and natural, leading to a simplification of Drinfel'd's original work. In particular, we reprove that rational associators exist and can be constructed iteratively, though the proof itself still depends on the apriori knowledge that a not-necessarily-rational associator exists.

## CONTENTS

1. Introduction	1
1.1. Reminders about quasi-triangular quasi-Hopf algebras	1
1.2. What we do	2
1.3. Acknowledgement	4
2. The basic definitions	4
2.1. Parenthesized braids and <b>GT</b>	4
2.2. Parenthesized chord diagrams and <b>GRT</b>	8
3. Isomorphisms and associators	11
4. The Main Theorem	15
4.1. The statement, consequences, and first reduction	15
4.2. More on the group $\widehat{\mathbf{GRT}}$	15
4.3. The second reduction	18
4.4. A cohomological interlude	19
4.5. Proof of the semi-classical hexagon equation	20
5. Just for completeness	22
References	24

## 1. INTRODUCTION

1.1. **Reminders about quasi-triangular quasi-Hopf algebras.** A quasi-triangular quasi-Hopf algebra [Dr1] is an algebra  $A$  together with a not-quite-cocommutative and not-quite-coassociative coproduct  $\Delta$ , whose failure to be cocommutative is “controlled” by some element  $R \in A^{\otimes 2}$  and whose failure to be coassociative is “controlled” by some element  $\Phi \in A^{\otimes 3}$

---

*Date:* This edition: Oct. 19, 1998; First edition: June 21, 1996.

This article is available electronically at <http://www.ma.huji.ac.il/~drorbn>, and at <http://xxx.lanl.gov/abs/q-alg/9606021>.

(for more details, see [Dr1] or [Ka, SS]). For the representations of  $A$  to form a tensor category,  $R$  and  $\Phi$  have to obey the so-called “pentagon”  $\diamond$  and “hexagon”  $\circ_{\pm}$  equations (see section 3). In [Dr1] Drinfel’d finds a “universal” formula  $(R_{KZ}, \Phi_{KZ})$  for a solution of  $\diamond$  and  $\circ_{\pm}$  by considering holonomies of the so-called Knizhnik-Zamolodchikov connection. The formula  $R_{KZ}$  is very simple —  $R_{KZ}$  is in a clear sense “an exponential”. The formula  $\Phi_{KZ}$  is somewhat less satisfactory, as it requires analysis — differential equations and/or iterated integrals whose values are most likely transcendental numbers [Dr1, LM1, Za]. In [Dr2] Drinfel’d proves that there is an iterative algebraic procedure for finding a universal formula for a solution  $(R, \Phi)$  of  $\diamond$ ,  $\circ_{\pm}$  (with  $R = R_{KZ}$ ), and that such a universal formula (called *an associator*) can be found iteratively and over the rationals.

Associators (and the iterative procedure for constructing them) are important in the theory of finite-type invariants of knots (Vassiliev invariants) [B-N5, B-N3, Ca, Ka, LM1, Pi] and of 3-manifolds [LMO, Le]. Recently, Etingof and Kazhdan [EK1, EK2] used associators to show that any Lie bialgebra can be quantized. Their results become algorithmically computable once we know that an associator can be found iteratively.<sup>1</sup>

Unfortunately, Drinfel’d’s paper is complicated and hard to read. It involves the introduction, almost “out of thin air”, of two groups,  $\widehat{\mathbf{GT}}$  and  $\widehat{\mathbf{GRT}}$ , that act on the set  $\widehat{\mathbf{ASS}}$  of all associators. Both groups act simply transitively on  $\widehat{\mathbf{ASS}}$ , with  $\widehat{\mathbf{GT}}$  acting on the right and  $\widehat{\mathbf{GRT}}$  on the left, and the two actions commute. He then studies these groups and their actions on  $\widehat{\mathbf{ASS}}$  to deduce the existence of formulae better than  $\Phi_{KZ}$ . Drinfel’d’s “Grothendieck-Teichmüller” group  $\widehat{\mathbf{GT}}$  is closely related to number theory and the group  $\text{Gal}(\bar{\mathbb{Q}}/\mathbb{Q})$ . See [Dr2, Sc].  $\widehat{\mathbf{GRT}}$  is in some sense a “gRaded” version of  $\widehat{\mathbf{GT}}$ , explaining why Drinfel’d inserted an R in the middle of its name.

**1.2. What we do.** The purpose of this paper is to present a framework within which the set of associators  $\widehat{\mathbf{ASS}}$ , the groups  $\widehat{\mathbf{GT}}$  and  $\widehat{\mathbf{GRT}}$ , and the relevant facts about them are natural. In fact, the mere fact that  $\widehat{\mathbf{GT}}$  and  $\widehat{\mathbf{GRT}}$  exist and act simply transitively on the right (for  $\widehat{\mathbf{GT}}$ ) and on the left (for  $\widehat{\mathbf{GRT}}$ ), with the two actions commuting, stems from the following basic principle (which I learned from M. Hutchings):

**Principle 1.** *If  $B$  is a mathematical structure (i.e., a set, a set with a basepoint, an algebra, a category, etc.) and if  $C$  is an isomorphic mathematical structure, then on the set  $A$  of all isomorphisms  $B \rightarrow C$  there are two commuting group actions, with both actions simple and transitive:*

- *The group  $GT$  of (structure-preserving) automorphisms of  $B$  acts on  $A$  by composition on the right.*
- *The group  $GRT$  of (structure-preserving) automorphisms of  $C$  acts on  $A$  by composition on the left.*

We apply this principle to a certain “upgrade” of the Kohno isomorphism [Koh1] (see also [KT]) between the unipotent completion  $\widehat{PB}_n$  of the pure braid group on  $n$  strands and its associated graded algebra, which is a certain completed algebra  $\hat{\mathcal{A}}_n^{pb}$  generated by symbols

---

<sup>1</sup> For most applications of associators to finite-type invariants, it is in fact sufficient to use a weaker but more complicated notion of an associator for which an iterative construction was given in [B-N3].

$t^{ij}$  with  $1 \leq i \neq j \leq n$ .<sup>2</sup> More specifically, in our case,  $B$  will be a certain category  $\mathbf{PaB}$  (defined in section 2.1) of *parenthesized braids*, and  $C$  will be a certain category  $\mathbf{PaCD}$  (defined in section 2.2) of *parenthesized chord diagrams*. On top of the category structure, both  $\mathbf{PaB}$  and  $\mathbf{PaCD}$  are “fibered linear”, have natural “basepoints” (some specific morphisms between some specific objects), natural “coproducts”, and natural “extension”, “cabling”, and “strand removal” operations, all defined in section 2. Furthermore,  $\mathbf{PaB}$  has a natural “filtration”,  $\mathbf{PaCD}$  has a natural “gradation” (which induces a filtration as well), and these filtrations/gradations (also defined in section 2) respect all other structure on  $\mathbf{PaB}$  and  $\mathbf{PaCD}$ . In applying Principle 1, we will only consider isomorphisms/automorphisms that respect all the additional structure on  $\mathbf{PaB}$  and  $\mathbf{PaCD}$ .

To be fair, we apply Principle 1 not to  $B = \mathbf{PaB}$  and  $C = \mathbf{PaCD}$ , but rather to their “quotients”  $\mathbf{PaB}^{(m)} = \mathbf{PaB}/\mathcal{F}_{m+1}\mathbf{PaB}$  and  $\mathbf{PaCD}^{(m)} = \mathbf{PaCD}/\mathcal{F}_{m+1}\mathbf{PaCD}$  by their respective filtrations, or to their “completions”  $\widehat{\mathbf{PaB}} = \varprojlim_{m \rightarrow \infty} \mathbf{PaB}^{(m)}$  and  $\widehat{\mathbf{PaCD}} = \varprojlim_{m \rightarrow \infty} \mathbf{PaCD}^{(m)}$ . In section 3 we show that every isomorphism (invertible structure-preserving functor)  $\widehat{\mathbf{Z}} : \widehat{\mathbf{PaB}} \rightarrow \widehat{\mathbf{PaCD}}$  is determined by its action on some specific morphism  $a$  in  $\widehat{\mathbf{PaB}}$ , and that  $\widehat{\mathbf{Z}}(a)$  can be interpreted as an associator. We will thus identify the set of all such  $\widehat{\mathbf{Z}}$ 's with  $\widehat{\mathbf{ASS}}$ , and get the two groups  $\widehat{\mathbf{GT}}$  and  $\widehat{\mathbf{GRT}}$  (as well as their simple, transitive, and commuting actions) entirely for free from Principle 1. Similarly, using Principle 1 with  $B = \mathbf{PaB}^{(m)}$  and  $C = \mathbf{PaCD}^{(m)}$ , we get groups  $\mathbf{GT}^{(m)}$  and  $\mathbf{GRT}^{(m)}$  that act on the set  $\mathbf{ASS}^{(m)}$  of all “associators up to degree  $m$ ”.

In section 4 we start by explaining why the surjectivity of the natural map  $\pi : \widehat{\mathbf{GRT}}^{(m)} \rightarrow \mathbf{GRT}^{(m-1)}$  implies the surjectivity of the map  $\mathbf{ASS}^{(m)} \rightarrow \mathbf{ASS}^{(m-1)}$ , which implies that there exists an iterative procedure for finding an associator, and that a rational associator exists.

We then turn to the proof of the surjectivity of  $\pi$ . To do this, we first write the relations defining  $\widehat{\mathbf{GRT}}$  explicitly. These turn out to be the “pentagon”, the “classical hexagon”, the “semi-classical hexagon”, and some technical relations of lesser interest. It turns out that the only relation that could challenge the surjectivity of  $\pi$  is the semi-classical hexagon, and so we spend the rest of section 4 proving that the semi-classical hexagon follows from the classical hexagon, the pentagon, and the lesser relations. This is done by using a certain 12-face polyhedron to show that the failure  $\psi$  of the semi-classical hexagon to hold lies in the kernel of some differential, and by studying the relevant cohomology of the corresponding complex.

Just for completeness, in section 5 we display the defining formulas of  $\widehat{\mathbf{GT}}$  and  $\widehat{\mathbf{GRT}}$  that are not needed in the main argument. A future part II of this paper will contain some additional results, following [Dr2, section 6].

It is worthwhile to note that all our arguments depend on the existence of at least one associator. Otherwise, we do not know that  $\widehat{\mathbf{PaB}}$  and  $\widehat{\mathbf{PaCD}}$  are at all isomorphic. So in a sense, all that we do is to take the Knizhnik-Zamolodchikov associator  $\Phi_{KZ}$  (constructed by Drinfel'd) and “improve” it.

---

<sup>2</sup>In the language of Vassiliev invariants, the Kohno isomorphism is a combination of three facts: that the space of Vassiliev invariants of pure braids is the dual of  $\widehat{PB}_n$ , that the associated graded space of Vassiliev invariants of pure braids is dual to the algebra  $\mathcal{A}_n^{pb}$  of “chord diagrams”, and that the maps  $\widehat{PB}_n \rightarrow \widehat{\mathcal{A}}_n^{pb}$  that we consider are “universal Vassiliev invariants”.

Almost everything that we do appears either explicitly or implicitly in Drinfel'd's paper [Dr2]. The presentation of  $\widehat{\mathbf{GT}}$  as a group of automorphisms of some braid-group-like objects is due to Lochak and Schneps [LS1, LS2] (who work with a different completion than ours).

**1.3. Acknowledgement.** This paper grew out of a course I gave at Harvard University in the spring semester of 1995, titled “Knot Theory as an Excuse”. One of the advertised goals of that course was to “attempt to read together two papers by Drinfel'd [[Dr1, Dr2]]”<sup>3</sup>, where I admitted that “I have read about 20% of the material in these papers, understood about 20% of what I read, and got a lot out of it”. The idea was then to have “a discussion group in which everybody holds copies of the papers and we jointly try to understand them”. Courses like that are usually doomed to fail, but due to the amazing group of participants I think we managed to meet the target of “get ourself up to about 50% on both figures [of reading and understanding]”. These participants were: D. D. Ben-Zvi, R. Bott, A. D’Andrea, S. Garoufalidis, D. J. Goldberg, E. Haley, M. Hutchings, D. Kazhdan, A. Kirillov, T. Kubo, S. Majid, A. Polishchuk, S. Sternberg, D. P. Thurston, and H. L. Wolfgang. I wish to thank them all for the part they took in the joint effort that led to this paper. In addition, I’d like to thank P. Deligne, E. de-Shalit, and E. Goren for teaching me some basic facts about algebraic groups, and A. Haviv, Yael K., A. Referee, E. Rips, and J. D. Stasheff for many useful comments.

## 2. THE BASIC DEFINITIONS

In this section we introduce the two mathematical structures **PaB** and **PaCD** on which we will apply Principle 1. Let  $A$  be some fixed commutative associative  $\mathbb{Q}$ -algebra with unit (typically  $\mathbb{C}$  or  $\mathbb{Q}$ ). Most objects that we will define below “have coefficients” in  $A$ . We will mostly suppress  $A$  from the notation, except in the few places where it matters.

**2.1. Parenthesized braids and GT.** A *parenthesized braid* is a braid (whose ends are points ordered along a line) together with a parenthesization of its bottom end (the *domain*) and its top end (the *range*). A *parenthesization* of a sequence of points is a specification of a way of “multiplying” them as if they were elements in a non-associative algebra. Rather than giving a formal definition, Figure 1 contains some examples.

Parenthesized braids form a category in an obvious way. The objects of this category are parenthesizations, the morphisms are the parenthesized braids themselves, and composition is the operation of putting two parenthesized braid on top of each other, as on the right (provided the range of the first is the domain of the second).

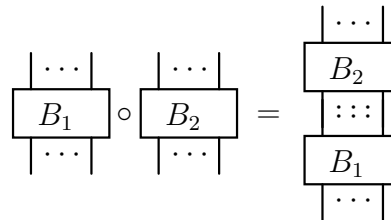

Furthermore, there are some naturally defined operations on parenthesized braids. If  $B$  is such a braid with  $n$  strands, these operations are:

<sup>3</sup>All quotes taken from the official course description.

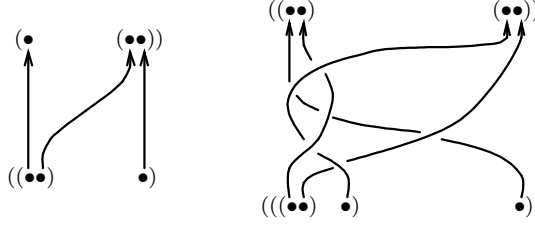

**Figure 1.** A parenthesized braid whose domain is  $((\bullet\bullet)\bullet)$  and whose range is  $(\bullet(\bullet\bullet))$  (left), and a parenthesized braid whose domain is  $((\bullet\bullet)\bullet)\bullet)$  and whose range is  $((\bullet\bullet)(\bullet\bullet))$  (right). Notice that by convention we draw “inner multiplications” as closer endpoints, and “outer multiplications” as farther endpoints. Below we will not bother to specify the parenthesizations at the ends explicitly, as this information can be read from the distance scales appearing in the way we draw the ends.

- *Extension operations:* Let  $d_0B = d_0^n B$  ( $d_{n+1}B = d_{n+1}^n B$ ) be  $B$  with one straight strand added on the left (right), with ends regarded as outer-most:

$$d_0 \left( \begin{array}{c} \uparrow \\ \uparrow \\ \downarrow \\ \downarrow \end{array} \right) = \left| \begin{array}{c} \uparrow \\ \uparrow \\ \downarrow \\ \downarrow \end{array} \right. ; \quad d_3 \left( \begin{array}{c} \uparrow \\ \uparrow \\ \downarrow \\ \downarrow \end{array} \right) = \left. \begin{array}{c} \uparrow \\ \uparrow \\ \downarrow \\ \downarrow \end{array} \right|.$$

- *Cabling operations:* Let  $d_iB = d_i^n B$  for  $1 \leq i \leq n$  be the parenthesized braid obtained from  $B$  by doubling its  $i$ th strand (counting at the bottom), taking the ends of the resulting “daughter strands” as an inner-most product:

$$d_2 \left( \begin{array}{c} \uparrow \\ \uparrow \\ \downarrow \\ \downarrow \end{array} \right) = \left| \begin{array}{c} \uparrow \\ \uparrow \\ \downarrow \\ \downarrow \end{array} \right.$$

- *Strand removal operations*<sup>4</sup>: Let  $s_iB = s_i^n B$  for  $1 \leq i \leq n$  be the parenthesized braid obtained from  $B$  by removing its  $i$ th strand (counting at the bottom):

$$s_2 \left( \begin{array}{c} \uparrow \\ \uparrow \\ \downarrow \\ \downarrow \end{array} \right) = \left. \begin{array}{c} \uparrow \\ \uparrow \\ \downarrow \\ \downarrow \end{array} \right|.$$

The *skeleton*  $\mathbf{S}B$  of a parenthesized braid  $B$  is the map that it induces from the points of its domain to the points of its range, taken together with the domain and range:

$$\mathbf{S} \left( \begin{array}{c} \uparrow \\ \uparrow \\ \downarrow \\ \downarrow \end{array} \right) = \left. \begin{array}{c} \uparrow \\ \uparrow \\ \downarrow \\ \downarrow \end{array} \right| \quad (1)$$

More precisely, the skeleton  $\mathbf{S}$  is a functor on the category of parenthesized braids whose image is in the category  $\mathbf{PaP}$  of parenthesized permutations, whose definition should be clear from its name and a simple inspection of the example in (1). There are naturally defined operations  $d_i$  and  $s_i$  on  $\mathbf{PaP}$  as in the case of parenthesized braids, and the skeleton functor

<sup>4</sup>The strand removal operations (and all other  $s_i$ 's below) are important in the applications, but play no crucial role in this paper and can be systematically removed with no change to the end results.

$\mathbf{S}$  intertwines the  $d_i$ 's and the  $s_i$ 's acting on parenthesized braids and on parenthesized permutations.

The category that we really need is a category of formal linear combinations of parenthesized braids sharing the same skeleton:

**Definition 2.1.** Let  $\mathbf{PaB}(A) = \mathbf{PaB}$  (for **P**arenthesized **B**raids) be the category whose objects are parenthesizations and whose morphisms are pairs  $(P, \sum_{j=1}^k \beta_j B_j)$ , where  $P$  is a morphism in the category of parenthesized permutations, the  $B_j$ 's are parenthesized braids whose skeleton is  $P$ , and the  $\beta_j$ 's are coefficients in the ground algebra  $A$ . The composition law in  $\mathbf{PaB}$  is the bilinear extension of the composition law of parenthesized braids. There is a natural forgetful “skeleton” functor  $\mathbf{S} : \mathbf{PaB} \rightarrow \mathbf{PaP}$ . If the sum  $\sum \beta_j B_j$  is not the empty sum, we usually suppress  $P$  from the notation, as it can be inferred from the  $B_j$ 's. See Figure 2.

$$B = \begin{array}{c} \uparrow \uparrow \\ \diagdown \diagup \\ \uparrow \uparrow \end{array} - \begin{array}{c} \uparrow \uparrow \\ \diagup \diagdown \\ \uparrow \uparrow \end{array} + \frac{22}{7} \begin{array}{c} \uparrow \uparrow \\ \diagdown \diagup \\ \uparrow \uparrow \\ \diagdown \diagup \\ \uparrow \uparrow \end{array} \quad \mathbf{S}(B) = \begin{array}{c} \uparrow \uparrow \\ \diagdown \diagup \\ \uparrow \uparrow \end{array}$$

**Figure 2.** A morphism  $B$  in  $\mathbf{PaB}$  and its skeleton  $\mathbf{S}(B)$  in  $\mathbf{PaP}$ .

2.1.1. *Fibered linear categories.* The category  $\mathbf{PaB}$  together with the functor  $\mathbf{S} : \mathbf{PaB} \rightarrow \mathbf{PaP}$  is an example of a fibered linear category. Let  $\mathbf{P}$  be a category “of skeletons”. A *fibered linear category over  $\mathbf{P}$*  is a pair  $(\mathbf{B}, \mathbf{S} : \mathbf{B} \rightarrow \mathbf{P})$  of the form (category, functor into  $\mathbf{P}$ ), in which  $\mathbf{B}$  has the same objects as  $\mathbf{P}$ , the “skeleton” functor  $\mathbf{S}$  is the identity on objects, the inverse image  $\mathbf{S}^{-1}(P)$  of every morphism  $P$  in  $\mathbf{P}$  is a linear space, and so the composition maps in  $\mathbf{B}$  are bilinear in the natural sense. Many notions from the theory of algebras have analogs for fibered linear categories, with the composition of morphisms replacing the multiplication of elements. Let us list the few such notions that we will use, without giving precise definitions:

- A *subcategory* of a fibered linear category  $(\mathbf{B}, \mathbf{S} : \mathbf{B} \rightarrow \mathbf{P})$  is a choice of a linear subspace in each “space of morphisms with a fixed skeleton”  $\mathbf{S}^{-1}(P)$ , so that the system of subspaces thus chosen is closed under composition.
- An *ideal* in  $(\mathbf{B}, \mathbf{S} : \mathbf{B} \rightarrow \mathbf{P})$  is a subcategory  $\mathbf{I}$  so that if at least one of the two composable morphisms  $B_1$  and  $B_2$  in  $\mathbf{B}$  is actually in  $\mathbf{I}$ , then the composition  $B_1 \circ B_2$  is also in  $\mathbf{I}$ .
- One can take *powers* of ideals — The morphisms of  $\mathbf{I}^m$  will be all the morphisms in  $\mathbf{B}$  that can be presented as compositions of  $m$  morphisms in  $\mathbf{I}$ . The power  $\mathbf{I}^m$  is also an ideal in  $\mathbf{B}$ .
- One can form the *quotient*  $\mathbf{B}/\mathbf{I}$  of a fibered linear category  $\mathbf{B}$  by an ideal  $\mathbf{I}$  in it, and the result is again a fibered linear category.
- *Direct sums* of fibered linear categories that are fibered over the same skeleton category can be formed.
- One can define *filtered* and *graded* fibered linear categories. One can talk about the *associated graded* fibered linear category of a given filtered fibered linear category.
- One can take the *inverse limit* of an inverse system of fibered linear categories (fibered in a compatible way over the same category of skeletons). In particular, if  $\mathbf{I}$  is an ideal

in a fibered linear category  $\mathbf{B}$ , one can form “the  $\mathbf{I}$ -adic completion  $\widehat{\mathbf{B}} = \varprojlim_{m \rightarrow \infty} \mathbf{B}/\mathbf{I}^m$ . The  $\mathbf{I}$ -adic completion is a filtered fibered linear category.

- *Tensor powers* of a fibered linear category  $(\mathbf{B}, \mathbf{S} : \mathbf{B} \rightarrow \mathbf{P})$  can be defined. For example,  $\mathbf{B} \otimes \mathbf{B}$  will have the same set of objects as  $\mathbf{B}$ , and for any two such objects  $O_1$  and  $O_2$ , we set

$$\mathrm{mor}_{\mathbf{B} \otimes \mathbf{B}}(O_1, O_2) = \coprod_{P \in \mathrm{mor}_{\mathbf{P}}(O_1, O_2)} \mathbf{S}^{-1}(P) \otimes \mathbf{S}^{-1}(P).$$

$\mathbf{B} \otimes \mathbf{B}$  is again a fibered linear category.

- The notion of a *coproduct functor*  $\square : \mathbf{B} \rightarrow \mathbf{B} \otimes \mathbf{B}$  makes sense.

2.1.2. *Back to parenthesized braids.* We can now introduce some more structure on  $\mathbf{PaB}$ , and specify completely the mathematical structures that will play the role of  $B$  in Principle 1.

**Definition 2.2.** Let  $\square : \mathbf{PaB} \rightarrow \mathbf{PaB} \otimes \mathbf{PaB}$  be the coproduct functor defined by setting each individual parenthesized braid  $B$  to be *group-like*, that is, by setting  $\square(B) = B \otimes B$ .

Let  $\mathbf{I}$  be the *augmentation ideal* of  $\mathbf{PaB}$ , the ideal of all pairs  $(P, \sum \beta_j B_j)$  in which  $\sum \beta_j = 0$ . Powers of this ideal define the *unipotent filtration* of  $\mathbf{PaB}$ :  $\mathcal{F}_m \mathbf{PaB} = \mathbf{I}^{m+1}$ .

**Definition 2.3.** Let  $\mathbf{PaB}^{(m)} = \mathbf{PaB}/\mathcal{F}_m \mathbf{PaB} = \mathbf{PaB}/\mathbf{I}^{m+1}$  be the  $m$ th *unipotent quotient*<sup>5</sup> of  $\mathbf{PaB}$ , and let  $\widehat{\mathbf{PaB}} = \varprojlim_{m \rightarrow \infty} \mathbf{PaB}^{(m)}$  be the *unipotent completion* of  $\mathbf{PaB}$ .

Let  $\sigma$  be the parenthesized braid .

The fibered linear categories  $\mathbf{PaB}^{(m)}$  and  $\widehat{\mathbf{PaB}}$  inherit the operations  $d_i$  and  $s_i$  from parenthesized braids, and a coproduct  $\square$  and a filtration  $\mathcal{F}_\star$  from  $\mathbf{PaB}$ . The specific parenthesized braid  $\sigma$  can be regarded as a morphism in any of these categories.

**Definition 2.4.** Let  $\mathbf{GT}^{(m)}$  and  $\widehat{\mathbf{GT}}$  (really,  $\mathbf{GT}^{(m)}(A)$  and  $\widehat{\mathbf{GT}}(A)$ ) be the groups of structure preserving automorphisms of  $\mathbf{PaB}^{(m)}$  and  $\widehat{\mathbf{PaB}}$ , respectively. That is, the groups of all functors  $\mathbf{PaB}^{(m)} \rightarrow \mathbf{PaB}^{(m)}$  (or  $\widehat{\mathbf{PaB}} \rightarrow \widehat{\mathbf{PaB}}$ ) that cover the skeleton functor, intertwine  $d_i$ ,  $s_i$  and  $\square$  and fix  $\sigma$ . In short, let

$$\begin{aligned} B^{(m)} &= (\mathbf{PaB}^{(m)}, \mathbf{S} : \mathbf{PaB}^{(m)} \rightarrow \mathbf{PaP}, d_i, s_i, \square, \sigma); \\ \widehat{B} &= (\widehat{\mathbf{PaB}}, \mathbf{S} : \widehat{\mathbf{PaB}} \rightarrow \mathbf{PaP}, d_i, s_i, \square, \sigma); \\ \mathbf{GT}^{(m)} &= \mathrm{Aut} B^{(m)}; \quad \widehat{\mathbf{GT}} = \mathrm{Aut} \widehat{B}. \end{aligned}$$

*Remark 2.5.* One easily sees that elements of  $\mathbf{GT}^{(m)}$  ( $\widehat{\mathbf{GT}}$ ) automatically preserve the filtration  $\mathcal{F}_\star$ .

**Claim 2.6.**  $\mathbf{PaB}$  is generated by  $a^{\pm 1}$ ,  $\sigma^{\pm 1}$ , and their various images by repeated applications of the  $d_i$ 's, where

$$a = \begin{array}{c} \uparrow \\ | \\ \text{---} \\ | \\ \uparrow \end{array}, \quad \sigma = \begin{array}{c} \nearrow \\ \searrow \\ \nearrow \\ \searrow \end{array}.$$

<sup>5</sup>If you are familiar with Vassiliev invariants, notice that  $\mathbf{PaB}^{(m)}$  is simply  $\mathbf{PaB}$  modded out by “ $(m+1)$ -singular parenthesized braids”.

*Proof.* (sketch) The main point is that any of the standard generators of the braid group can be written in terms of  $a^{\pm 1}$  and  $\sigma^{\pm 1}$  and their images. For example,

$$\uparrow \quad \begin{array}{c} \nearrow \\ \searrow \end{array} \uparrow = \uparrow \quad \begin{array}{c} \uparrow \\ \downarrow \end{array} \uparrow = d_0 a^{-1} \circ d_0 d_3 \sigma \circ d_0 a. \quad \square$$

**2.2. Parenthesized chord diagrams and GRT.** The category **PaCD**, the main ingredient of the mathematical object  $C$  on which we will apply Principle 1, can be viewed as natural in two (equivalent) ways. First, **PaCD** is natural because it is the associated graded of **PaB**, as will be proven in section 3. **PaCD** can also be viewed as the category of “chord diagrams for finite-type (Vassiliev) invariants [B-N1, B-N4, Bi, BL, Go1, Go2, Kon, Va1, Va2] of parenthesized braids”, and all the operations that we will define on **PaCD** are inherited from their parallels on parenthesized braids, that were defined in section 2.1. I prefer not to make more than a few comments about the latter viewpoint below. Saying more requires repeating well known facts about finite-type invariants, and these can easily be found in the literature. If you already know about Vassiliev invariants and chord diagrams, you’ll find the relation between them and the definitions below rather clear. Unfortunately, if finite-type invariants are not mentioned, we have to start with some unmotivated definitions.

**Definition 2.7.** Let  $\mathcal{A}_n^{pb} = \mathcal{A}_n^{pb}(A)$  be the algebra (over the ground algebra  $A$ ) generated by symbols  $t^{ij}$  for  $1 \leq i \neq j \leq n$ , subject to the relations  $t^{ij} = t^{ji}$ ,  $[t^{ij}, t^{kl}] = 0$  if  $|\{i, j, k, l\}| = 4$ , and  $[t^{jk}, t^{ij} + t^{ik}] = 0$  if  $|\{i, j, k\}| = 3$ . The algebra  $\mathcal{A}_n^{pb}$  is graded by setting  $\deg t^{ij} = 1$ ; let  $\mathcal{G}_m \mathcal{A}_n^{pb}$  be the degree  $m$  piece of  $\mathcal{A}_n^{pb}$ , let  $\mathcal{F}_* \mathcal{A}_n^{pb}$  be the filtration defined by  $\mathcal{F}_m \mathcal{A}_n^{pb} = \bigoplus_{m' > m} \mathcal{G}_{m'} \mathcal{A}_n^{pb}$ , let  $\mathcal{A}_n^{pb(m)}$  be  $\mathcal{A}_n^{pb} / \mathcal{F}_m \mathcal{A}_n^{pb}$ , and let  $\hat{\mathcal{A}}_n^{pb}$  be the graded completion  $\varprojlim_{m \rightarrow \infty} \mathcal{A}_n^{pb(m)}$  of  $\mathcal{A}_n^{pb}$ . We call elements of  $\mathcal{A}_n^{pb}$  *chord diagrams*, and draw them as in Figure 3. (In the language of finite-type invariants,  $\mathcal{A}_n^{pb}$  is the algebra of chord diagrams for  $n$ -strand pure braids, and the last relation is the “4T” relation.)

$$t^{13}t^{13}t^{12}t^{23} \quad \longleftrightarrow \quad \begin{array}{c} \uparrow \quad \uparrow \quad \uparrow \\ \hline \hline \hline \hline \hline \hline \end{array}; \quad 4T : \quad \begin{array}{c} \uparrow \quad \uparrow \quad \uparrow \\ \hline \hline \hline \hline \hline \hline \end{array} + \begin{array}{c} \uparrow \quad \uparrow \quad \uparrow \\ \hline \hline \hline \hline \hline \hline \end{array} = \begin{array}{c} \uparrow \quad \uparrow \quad \uparrow \\ \hline \hline \hline \hline \hline \hline \end{array} + \begin{array}{c} \uparrow \quad \uparrow \quad \uparrow \\ \hline \hline \hline \hline \hline \hline \end{array}$$

**Figure 3.** Elements of  $\mathcal{A}_3^{pb}$  are presented as chord diagrams made of 3 vertical strands and some number of horizontal chords connecting them. A chord connecting the  $i$ th strand to the  $j$ th strand represents  $t^{ij}$ , and products are read from the bottom to the top of the diagram.

**Definition 2.8.** There is an action of the symmetric group  $\mathcal{S}_n$  on  $\mathcal{A}_n^{pb}$  by “permuting the vertical strands”, denoted by  $(\tau, \Psi) \mapsto \Psi^\tau$ :

$$\Psi = \begin{array}{c} \uparrow \quad \uparrow \quad \uparrow \\ \hline \hline \hline \hline \hline \hline \end{array} \mapsto \Psi^{231} = \begin{array}{c} \uparrow \quad \uparrow \quad \uparrow \\ \hline \hline \hline \hline \hline \hline \end{array}.$$



**Definition 2.9.** Let  $d_i = d_i^n : \mathcal{A}_n^{pb} \rightarrow \mathcal{A}_{n+1}^{pb}$  for  $0 \leq i \leq n+1$  and  $s_i = s_i^n : \mathcal{A}_n^{pb} \rightarrow \mathcal{A}_{n-1}^{pb}$  for  $1 \leq i \leq n$  be the algebra morphisms defined by their action on the generators  $t^{jk}$  (with  $j < k$ ) as follows:

$$d_i t^{jk} = \begin{cases} t^{j+1,k+1} & i < j < k \\ t^{j,k+1} + t^{j+1,k+1} & i = j < k \\ t^{j,k+1} & j < i < k \\ t^{jk} + t^{j,k+1} & j < i = k \\ t^{jk} & j < k < i \end{cases} \quad s_i t^{jk} = \begin{cases} t^{j-1,k-1} & i < j < k \\ 0 & i = j < k \\ t^{j,k-1} & j < i < k \\ 0 & j < i = k \\ t^{jk} & j < k < i. \end{cases}$$

Graphically,  $d_0^n$  ( $d_{n+1}^n$ ) acts by adding a strand on the left (right),  $d_i^n$  for  $1 \leq i \leq n$  acts by doubling the  $i$ th strand and summing all the possible ways of lifting the chords that were connected to the  $i$ th strand to the two daughter strands, and  $s_i^n$  acts by deleting the  $i$ th strand and mapping the chord diagram to 0 if any chord in it was connected to the  $i$ th strand:

$$d_0 \left( \begin{array}{c} \uparrow \\ \uparrow \\ \uparrow \\ \uparrow \\ \uparrow \\ \uparrow \\ \uparrow \\ \uparrow \\ \uparrow \\ \uparrow \end{array} \right) = \uparrow \begin{array}{c} \uparrow \\ \uparrow \\ \uparrow \\ \uparrow \\ \uparrow \\ \uparrow \\ \uparrow \\ \uparrow \\ \uparrow \\ \uparrow \end{array}; \quad d_2 \left( \begin{array}{c} \uparrow \\ \uparrow \\ \uparrow \\ \uparrow \\ \uparrow \\ \uparrow \\ \uparrow \\ \uparrow \\ \uparrow \\ \uparrow \end{array} \right) = \begin{array}{c} \uparrow \\ \uparrow \\ \uparrow \\ \uparrow \\ \uparrow \\ \uparrow \\ \uparrow \\ \uparrow \\ \uparrow \\ \uparrow \end{array} + \begin{array}{c} \uparrow \\ \uparrow \\ \uparrow \\ \uparrow \\ \uparrow \\ \uparrow \\ \uparrow \\ \uparrow \\ \uparrow \\ \uparrow \end{array} + \begin{array}{c} \uparrow \\ \uparrow \\ \uparrow \\ \uparrow \\ \uparrow \\ \uparrow \\ \uparrow \\ \uparrow \\ \uparrow \\ \uparrow \end{array} + \begin{array}{c} \uparrow \\ \uparrow \\ \uparrow \\ \uparrow \\ \uparrow \\ \uparrow \\ \uparrow \\ \uparrow \\ \uparrow \\ \uparrow \end{array};$$

$$s_1 \left( \begin{array}{c} \uparrow \\ \uparrow \\ \uparrow \\ \uparrow \\ \uparrow \\ \uparrow \\ \uparrow \\ \uparrow \\ \uparrow \\ \uparrow \end{array} \right) = \begin{array}{c} \uparrow \\ \uparrow \\ \uparrow \\ \uparrow \\ \uparrow \\ \uparrow \\ \uparrow \\ \uparrow \\ \uparrow \\ \uparrow \end{array}; \quad s_1 \left( \begin{array}{c} \uparrow \\ \uparrow \\ \uparrow \\ \uparrow \\ \uparrow \\ \uparrow \\ \uparrow \\ \uparrow \\ \uparrow \\ \uparrow \end{array} \right) = 0.$$

(Here and below the symbol  $\begin{array}{c} \uparrow \\ \uparrow \\ \uparrow \\ \uparrow \\ \uparrow \\ \uparrow \\ \uparrow \\ \uparrow \\ \uparrow \\ \uparrow \end{array}$  means  $\begin{array}{c} \uparrow \\ \uparrow \\ \uparrow \\ \uparrow \\ \uparrow \\ \uparrow \\ \uparrow \\ \uparrow \\ \uparrow \\ \uparrow \end{array}$ ).

**Definition 2.10.** Let  $\square : \mathcal{A}_n^{pb} \rightarrow \mathcal{A}_n^{pb} \otimes \mathcal{A}_n^{pb}$  be the coproduct defined by declaring the  $t^{ij}$ 's to be primitive:  $\square(t^{ij}) = t^{ij} \otimes 1 + 1 \otimes t^{ij}$ .

**Definition 2.11.**  $\mathbf{PaCD} = \mathbf{PaCD}(A)$  (for **P**arenthesized **C**hord **D**iagrams) is the category whose objects are parenthesizations and whose morphisms are formal products  $D \cdot P$ , where  $P$  is a parenthesized permutation of  $n$  objects (for some  $n$ ) and  $D \in \mathcal{A}_n^{pb}(A)$ . The composition law in  $\mathbf{PaCD}$  is  $D_1 \cdot P_1 \circ D_2 \cdot P_2 = (D_1 \cdot D_2^{P_1}) \cdot (P_1 \circ P_2)$  (whenever  $P_1$  and  $P_2$  are composable), where  $D_2^{P_1}$  denotes the action of the permutation  $P_1$  on  $D_2$  as in Definition 2.8. This composition law is better seen graphically as in Figure 4.  $\mathbf{PaCD}$  inherits a grading  $\mathbf{PaCD} = \bigoplus_m \mathcal{G}_m \mathbf{PaCD}$  from  $\mathcal{A}_*^{pb}$ , and is fibered linear over  $\mathbf{PaP}$  with the skeleton functor  $\mathbf{S} : D \cdot P \mapsto P$ .  $\mathbf{PaCD}$  is also filtered by setting  $\mathcal{F}_m \mathbf{PaCD} = \bigoplus_{m' > m} \mathcal{G}_{m'} \mathbf{PaCD}$ .  $\mathbf{PaCD}$  inherits a coproduct  $\square : \mathbf{PaCD} \rightarrow \mathbf{PaCD} \otimes \mathbf{PaCD}$  from the coproduct  $\square$  of  $\mathcal{A}_n^{pb}$ .

$$(t^{12} \cdot \uparrow \begin{array}{c} \uparrow \\ \uparrow \\ \uparrow \\ \uparrow \\ \uparrow \\ \uparrow \\ \uparrow \\ \uparrow \\ \uparrow \\ \uparrow \end{array}) \circ (t^{23} t^{13} \cdot \uparrow \begin{array}{c} \uparrow \\ \uparrow \\ \uparrow \\ \uparrow \\ \uparrow \\ \uparrow \\ \uparrow \\ \uparrow \\ \uparrow \\ \uparrow \end{array}) \rightarrow \begin{array}{c} \uparrow \\ \uparrow \\ \uparrow \\ \uparrow \\ \uparrow \\ \uparrow \\ \uparrow \\ \uparrow \\ \uparrow \\ \uparrow \end{array} \circ \begin{array}{c} \uparrow \\ \uparrow \\ \uparrow \\ \uparrow \\ \uparrow \\ \uparrow \\ \uparrow \\ \uparrow \\ \uparrow \\ \uparrow \end{array} \rightarrow \begin{array}{c} \uparrow \\ \uparrow \\ \uparrow \\ \uparrow \\ \uparrow \\ \uparrow \\ \uparrow \\ \uparrow \\ \uparrow \\ \uparrow \end{array} \rightarrow \begin{array}{c} \uparrow \\ \uparrow \\ \uparrow \\ \uparrow \\ \uparrow \\ \uparrow \\ \uparrow \\ \uparrow \\ \uparrow \\ \uparrow \end{array} \rightarrow t^{12} t^{23} t^{13} \cdot \uparrow \begin{array}{c} \uparrow \\ \uparrow \\ \uparrow \\ \uparrow \\ \uparrow \\ \uparrow \\ \uparrow \\ \uparrow \\ \uparrow \\ \uparrow \end{array}$$

**Figure 4.** The composition of a morphism in  $\text{mor}_{\mathbf{PaCD}}((\bullet(\bullet\bullet)), (\bullet(\bullet\bullet)))$  with a morphism in  $\text{mor}_{\mathbf{PaCD}}((\bullet(\bullet\bullet)), ((\bullet\bullet)\bullet))$ .

**Definition 2.12.** As in the case of  $\mathbf{PaB}$ , there are some naturally defined operations on  $\mathbf{PaCD}$ . If  $D \cdot P$  is a parenthesized chord diagram on  $n$  strands, set  $d_i(D \cdot P) = d_i^n(D \cdot P) = d_i^n D \cdot d_i^n P$ , and similarly for  $s_i = s_i^n$ . These operations are:

- *Extension operations:*  $d_0$  ( $d_{n+1}$ ) adds a far-away independent strand on the left (right).

- *Cabling operations:*  $d_i B$  with  $1 \leq i \leq n$  doubles the  $i$ th strand and sums all possible ways of lifting the chords that were connected to the  $i$ th strand to the two daughter strands.
- *Strand removal operations:*  $s_i$  removes the  $i$ th strand and maps everything to 0 if there was any chord connected to the  $i$ th strand.

**Definition 2.13.** Let  $\mathbf{PaCD}^{(m)}$  be the category  $\mathbf{PaCD}/\mathcal{F}_m \mathbf{PaCD}$  of parenthesized chord diagrams of degree up to  $m$ , and let  $\widehat{\mathbf{PaCD}}$  be the category  $\varprojlim_{m \rightarrow \infty} \mathbf{PaCD}^{(m)}$  of formal power series of parenthesized chord diagrams. The fibered linear categories  $\mathbf{PaCD}^{(m)}$  and  $\widehat{\mathbf{PaCD}}$  inherit the operations  $d_i$  and  $s_i$ , the coproduct  $\square$  and the filtration  $\mathcal{F}_\star$  from  $\mathbf{PaCD}$ .

Let  $X$  and  $H$  be the parenthesized chord diagrams  $\times$  and  $\updownarrow$  respectively, and let  $\tilde{R}$  be the formal exponential  $\tilde{R} = \exp(\frac{1}{2}H) \cdot X$ , regarded a morphism in  $\mathbf{PaCD}^{(m)}$  or  $\widehat{\mathbf{PaCD}}$ .

**Definition 2.14.** Let  $\mathbf{GRT}^{(m)}$  and  $\widehat{\mathbf{GRT}}$  (really,  $\mathbf{GRT}^{(m)}(A)$  and  $\widehat{\mathbf{GRT}}(A)$ ) be the groups of structure preserving automorphisms of  $\mathbf{PaCD}^{(m)}$  and  $\widehat{\mathbf{PaCD}}$ , respectively. That is, the groups of all functors  $\mathbf{PaCD}^{(m)} \rightarrow \mathbf{PaP}$  (or  $\widehat{\mathbf{PaCD}} \rightarrow \widehat{\mathbf{PaCD}}$ ) that cover the skeleton functor, intertwine  $d_i$ ,  $s_i$  and  $\square$  and fix  $\tilde{R}$ . In short, let

$$\begin{aligned} C^{(m)} &= \left( \mathbf{PaCD}^{(m)}, \mathbf{S} : \mathbf{PaCD}^{(m)} \rightarrow \mathbf{PaP}, d_i, s_i, \square, \tilde{R} \right); \\ \hat{C} &= \left( \widehat{\mathbf{PaCD}}, \mathbf{S} : \widehat{\mathbf{PaCD}} \rightarrow \mathbf{PaP}, d_i, s_i, \square, \tilde{R} \right); \\ \mathbf{GRT}^{(m)} &= \text{Aut } C^{(m)}; \quad \widehat{\mathbf{GRT}} = \text{Aut } \hat{C}. \end{aligned}$$

*Remark 2.15.* Elements of  $\mathbf{GRT}^{(m)}$  ( $\widehat{\mathbf{GRT}}$ ) fix each of  $X$  and  $H$  individually. Indeed,  $\tilde{R}^2 = \exp H$  and hence  $\exp H$  and thus  $H$  are fixed. But then  $X = \exp(-\frac{1}{2}H)\tilde{R}$  is fixed too.

**Claim 2.16.**  $\mathbf{PaCD}$  is generated by  $a^{\pm 1}$ ,  $X$ ,  $H$ , and their various images by repeated applications of the  $d_i$ 's, where

$$a = \left| \begin{array}{c} \uparrow \\ \uparrow \\ \uparrow \end{array} \right|, \quad X = \times, \quad H = \left| \begin{array}{c} \uparrow \\ \text{---} \\ \uparrow \end{array} \right|.$$

(Notice that the symbol “ $a$ ” plays a double role, as a generator of  $\mathbf{PaB}$  and as a generator of  $\mathbf{PaCD}$ ).

*Proof.* (sketch) Perhaps one illustrative example will suffice:

$$\left| \begin{array}{c} \uparrow \\ \uparrow \\ \uparrow \end{array} \right| = \left| \begin{array}{c} \uparrow \\ \uparrow \\ \uparrow \end{array} \right| \left| \begin{array}{c} \uparrow \\ \uparrow \\ \uparrow \end{array} \right| = d_0 X \circ a^{-1} \circ d_3 H \circ a \circ d_0 X. \quad \square$$

*Remark 2.17.* Remark 2.15 and claim 2.16 imply that elements of  $\mathbf{GRT}^{(m)}$  ( $\widehat{\mathbf{GRT}}$ ) automatically preserve the filtration  $\mathcal{F}_\star$ .

## 3. ISOMORPHISMS AND ASSOCIATORS

In this section we make the key observation that makes Principle 1 useful in our case: The fact that the set of all associators à la Drinfel'd [Dr1, Dr2] can be identified with the set of all structure-preserving functors  $\widehat{\mathbf{Z}} : \widehat{B} \rightarrow \widehat{C}$ . Recall that  $A$  is some fixed commutative associative  $\mathbb{Q}$ -algebra with unit.

**Definition 3.1.** An *associator* is an invertible element  $\Phi$  of  $\widehat{\mathcal{A}}_3^{pb}(A)$  satisfying the following axioms:

- The *pentagon* axiom holds in  $\widehat{\mathcal{A}}_4^{pb}$ :

$$d_4\Phi \cdot d_2\Phi \cdot d_0\Phi = d_1\Phi \cdot d_3\Phi. \quad (\diamond)$$

- The *hexagon* axioms hold in  $\widehat{\mathcal{A}}_3^{pb}$ :

$$d_1 \exp\left(\pm \frac{1}{2}t^{12}\right) = \Phi \cdot \exp\left(\pm \frac{1}{2}t^{23}\right) \cdot (\Phi^{-1})^{132} \cdot \exp\left(\pm \frac{1}{2}t^{13}\right) \cdot \Phi^{312}. \quad (\diamond_{\pm})$$

- $\Phi$  is *non-degenerate*:  $s_1\Phi = s_2\Phi = s_3\Phi = 1$ .
- $\Phi$  is *group-like*:  $\square\Phi = \Phi \otimes \Phi$ .

(Apart from the different notation, this definition is equivalent to Drinfel'd's [Dr2] definition of an  $Fr(A, B)$ -valued  $\varphi$ , and practically equivalent to the definition of an  $\mathbf{AP}^{hor}$ -valued  $\Phi$  in [B-N3].)

**Definition 3.2.** Let  $\widehat{\mathbf{ASS}} = \widehat{\mathbf{ASS}}(A)$  be the set of associators  $\Phi \in \widehat{\mathcal{A}}_3^{pb}(A)$ . Similarly, if we mod out by degrees higher than  $m$ , we can define *associators up to degree  $m$*  and the set  $\mathbf{ASS}^{(m)}$ .

*Remark 3.3.* The hexagon axiom for  $\Phi \in \widehat{\mathbf{ASS}}$  or  $\Phi \in \mathbf{ASS}^{(m)}$  implies that  $\Phi = 1 + (\text{higher degree terms})$ .

By the definition of  $\widehat{B}$  and  $\widehat{C}$ , a structure-preserving functor  $\widehat{\mathbf{Z}} : \widehat{B} \rightarrow \widehat{C}$  carries  $\sigma$  to  $\tilde{R}$ , and thus it is determined by its value  $\widehat{\mathbf{Z}}(a)$  on the remaining generator of  $\mathbf{PaB}$ . As  $\widehat{\mathbf{Z}}$  must cover the skeleton functor,  $\widehat{\mathbf{Z}}(a)$  must be of the form  $\Phi_{\widehat{\mathbf{Z}}} \cdot a$ , for some  $\Phi_{\widehat{\mathbf{Z}}} \in \widehat{\mathcal{A}}_3^{pb}$ .

**Proposition 3.4.** If  $\widehat{\mathbf{Z}}$  is a structure preserving functor  $\widehat{B} \rightarrow \widehat{C}$ , then  $\Phi_{\widehat{\mathbf{Z}}}$  is an associator, and the map  $\widehat{\mathbf{Z}} \mapsto \Phi_{\widehat{\mathbf{Z}}}$  is a bijection between the set of all structure-preserving functors  $\widehat{\mathbf{Z}} : \widehat{B} \rightarrow \widehat{C}$  and the set  $\widehat{\mathbf{ASS}}$  of all associators  $\Phi \in \widehat{\mathcal{A}}_3^{pb}$ . A similar construction can be made in the case of  $B^{(m)}$ ,  $C^{(m)}$  and  $\mathbf{ASS}^{(m)}$ , and the same statements hold.

Before we can prove Proposition 3.4, we need a bit more insight about the structure of  $\mathcal{A}_n^{pb}$ .

**Lemma 3.5.** The following two relations hold in  $\mathcal{A}_n^{pb}$ :

1. *Locality in space:* For any  $k \leq n$ , the subalgebra of  $\mathcal{A}_n^{pb}$  generated by  $\{t^{ij} : i, j \leq k\}$  commutes with the subalgebra generated by  $\{t^{ij} : i, j > k\}$ . In pictures, we see that elements that live in “different parts of space” commute:

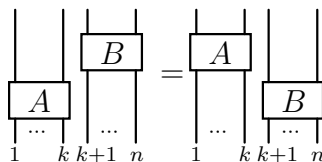

2. Locality in scale *Elements that live in “different scales” commute. This is best explained by a picture, with notation as in Definition 2.9:*

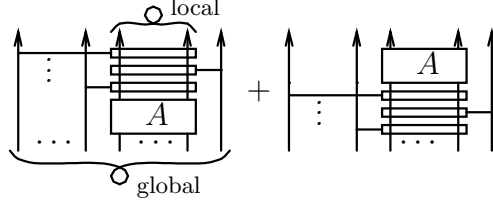

(We think of the part  $A$  as “local”, as it involves only the “local” group of strands, and of the rest as “global”, as it regards the “local” group of strands as “equal”.)

(A similar statement is [B-N3, Lemma 3.4].)

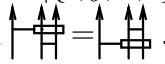
*Proof of Lemma 3.5.* Locality in space follows from repeated application of the relation  $t^{ij}t^{kl} = t^{kl}t^{ij}$  with  $i < j < k < l$ . Locality in scale follows from repeated application of the relation  $t^{ij}t^{kl} = t^{kl}t^{ij}$  with general  $i, j, k, l$  with  $|\{i, j, k, l\}| = 4$ , and the  $4T$  relation, which can be redrawn in the more suggestive form .  $\square$

*Proof of Proposition 3.4.* Let  $\widehat{\mathbf{Z}}$  be a structure preserving functor  $\widehat{B} \rightarrow \widehat{C}$ , and let  $\Phi = \Phi_{\widehat{\mathbf{Z}}}$ . Apply  $\widehat{\mathbf{Z}}$  to the parenthesized braid equality

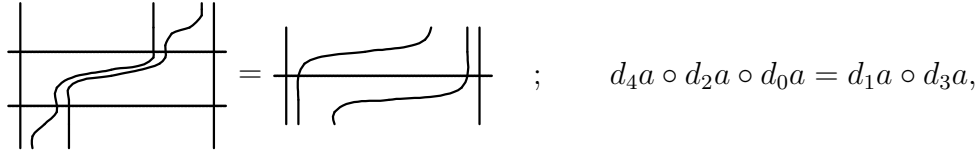

$$d_4 a \circ d_2 a \circ d_0 a = d_1 a \circ d_3 a,$$

and, using  $\widehat{\mathbf{Z}}(a) = \Phi \cdot a$ , get

$$(d_4 \Phi \cdot d_2 \Phi \cdot d_0 \Phi) \cdot (d_4 a \circ d_2 a \circ d_0 a) = (d_1 \Phi \cdot d_3 \Phi) \cdot (d_1 a \circ d_3 a).$$

The  $\widehat{A}^{pb}$  part of this equality is precisely the fact the  $\Phi$  satisfies the pentagon equation.

Similarly, the parenthesized braid equality

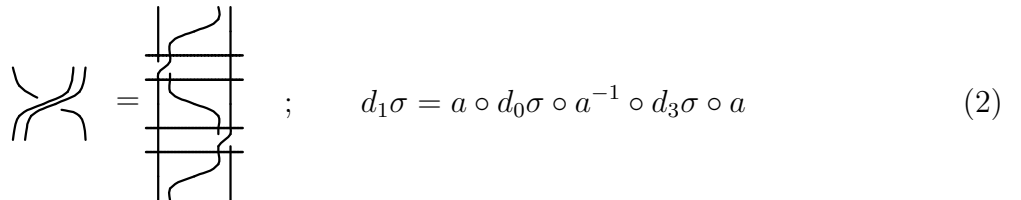

$$d_1 \sigma = a \circ d_0 \sigma \circ a^{-1} \circ d_3 \sigma \circ a \quad (2)$$

together with  $\widehat{\mathbf{Z}}(a) = \Phi \cdot a$  and  $\widehat{\mathbf{Z}}(\sigma) = \tilde{R}$  implies the positive hexagon equation  $\circlearrowright_+$ . Likewise, the same parenthesized braid equality but with  $\sigma$  replaced by  $\sigma^{-1}$  implies  $\circlearrowright_-$ .

$s_1 a = s_2 a = s_3 a$  is the identity morphism in  $\text{mor}((\bullet\bullet), (\bullet\bullet))$ , and after applying  $\widehat{\mathbf{Z}}$  we find that  $\Phi$  is non-degenerate. Finally,  $a$  is group-like in  $\mathbf{PaB}$  and as  $\widehat{\mathbf{Z}}$  preserves the coproduct,  $\Phi$  is also group-like. Hence we have verified that  $\Phi_{\widehat{\mathbf{Z}}} = \Phi$  is an associator.

To show that the map  $\widehat{\mathbf{Z}} \mapsto \Phi_{\widehat{\mathbf{Z}}}$  is a bijection we construct an inverse map. Let  $\Phi$  be an associator. We try to define a functor  $\widehat{\mathbf{Z}} = \widehat{\mathbf{Z}}_{\Phi} : \widehat{\mathbf{PaB}} \rightarrow \widehat{\mathbf{PaCD}}$  by setting  $\widehat{\mathbf{Z}}(a) = a \cdot \Phi$  and  $\widehat{\mathbf{Z}}(\sigma) = \tilde{R}$ , and by extending it to all other generators of  $\mathbf{PaB}$  in a way compatible with the  $d_i$ 's. We need to verify that this extension yields a well-defined functor; that is, that all the relations between the generators of  $\mathbf{PaB}$  get mapped to relations in  $\mathbf{PaCD}$  by  $\widehat{\mathbf{Z}}$ .

One can verify (using the Mac Lane coherence theorem [Ma]) that the relations between the generators of  $\mathbf{PaB}$  are the (repeated)  $d_i$  images of the relations (see also [B-N3]):

- The pentagon  $d_4a \circ d_2a \circ d_0a = d_1a \circ d_3a$ , as above.
- The hexagons  $d_1\sigma^{\pm 1} = a \circ d_0\sigma^{\pm 1} \circ a^{-1} \circ d_3\sigma^{\pm 1} \circ a$ , as above.
- Locality in space: (slashes ( $\chi$ ) indicate bundles of strands)

Here  $A$  and  $B$  can each be either  $a^{\pm 1}$  or  $\sigma^{\pm 1}$ .

- Locality in scale:

Here  $A$ ,  $B$  and  $C$  can each be either  $a^{\pm 1}$  or  $\sigma^{\pm 1}$ .

Clearly,  $\widehat{\mathbf{Z}}$  respects the pentagon and the hexagons because  $\Phi$  satisfies the pentagon and the hexagon axioms in the definition of an associator. By Lemma 3.5,  $\widehat{\mathbf{Z}}$  respects the locality relations. Hence  $\widehat{\mathbf{Z}}$  is well defined on morphisms of  $\mathbf{PaB}$ . One can verify that  $\widehat{\mathbf{Z}}(\mathbf{I}) \subset \widehat{\mathcal{F}}_1\widehat{\mathbf{PaCD}}$ , and hence  $\widehat{\mathbf{Z}}$  makes sense on  $\widehat{\mathbf{PaB}}$ . Finally, the fact that  $\widehat{\mathbf{Z}}$  intertwines the coproduct  $\square$  and the operations  $s_i$  follows from the group-like property and the non-degeneracy of  $\Phi$ , respectively.

The proof in the case of  $B^{(m)}$ ,  $C^{(m)}$  and  $\mathbf{ASS}^{(m)}$  is essentially identical.  $\square$

**Proposition 3.6.** *Every structure preserving functor  $\widehat{\mathbf{Z}} : \widehat{B} \rightarrow \widehat{C}$  or  $\mathbf{Z}^{(m)} : B^{(m)} \rightarrow C^{(m)}$  is invertible.*

*Proof.* The unipotent completion  $\widehat{PB}_n$  of the pure braid group  $PB_n$  on  $n$  strands can be identified with the the ring of morphisms in  $\widehat{\mathbf{PaB}}$  from the  $n$ -point object  $O_r = (\bullet(\bullet \dots (\bullet\bullet) \dots))$  back to itself that cover the identity permutation in  $\mathbf{PaP}$ . Similarly,  $\widehat{A}_n^{pb}$  can be identified with the ring of self-morphisms of  $O_r$  in  $\widehat{\mathbf{PaCD}}$  that cover the identity permutation. Thus, a functor  $\widehat{\mathbf{Z}} : \widehat{B} \rightarrow \widehat{C}$  induces a filtration-preserving ring morphism  $\widehat{Z}_n : \widehat{PB}_n \rightarrow \widehat{A}_n^{pb}$ . In  $\widehat{\mathbf{PaB}}$  ( $\widehat{\mathbf{PaCD}}$ ) every morphism can be written as a composition of invertible morphisms and an element of  $\widehat{PB}_n$  ( $\widehat{A}_n^{pb}$ ), and hence it is enough to prove that  $\widehat{Z}_n$  is an isomorphism for every  $n$ . Finally, it is enough to do that on the level of associated graded spaces. That is, we only need to show that  $\widehat{Z}_n^m : \mathcal{G}_m PB_n = I^m / I^{m+1} \rightarrow \mathcal{G}_m \widehat{A}_n^{pb}$  is an isomorphism for every  $n$  and  $m$ , where  $I$  is the augmentation ideal of  $PB_n$ .

Let  $\sigma^{ij}$  with  $1 \leq i < j \leq n$  be the standard generators of  $PB_n$ :

In **PaB**, the parenthesized braid corresponding to  $\sigma^{ij}$  is a conjugate of an extension of  $\sigma^2$ :

$$\sigma_{13} = \begin{array}{c} \uparrow \quad \uparrow \quad \uparrow \\ \text{---} \quad \text{---} \quad \text{---} \\ \uparrow \quad \uparrow \quad \uparrow \end{array} = \begin{array}{c} \uparrow \quad \uparrow \quad \uparrow \\ \text{---} \quad \text{---} \quad \text{---} \\ \uparrow \quad \uparrow \quad \uparrow \\ \text{---} \quad \text{---} \quad \text{---} \\ \uparrow \quad \uparrow \quad \uparrow \\ \text{---} \quad \text{---} \quad \text{---} \\ \uparrow \quad \uparrow \quad \uparrow \end{array} \begin{array}{l} C \\ C^{-1} \end{array} .$$

As  $\widehat{\mathbf{Z}}(\sigma^2) = \widetilde{R}^2 = \exp H$  and  $\widehat{\mathbf{Z}}$  preserves all structure, we find that

$$\widehat{\mathbf{Z}}(\sigma^{ij} - 1) = \widehat{\mathbf{Z}}(C)^{-1}(\exp t^{ij} - 1)\widehat{\mathbf{Z}}(C) = t^{ij} + (\text{higher terms}).$$

Ergo,

$$\widehat{\mathbf{Z}}((\sigma^{i_1 j_1} - 1)(\sigma^{i_1 j_2} - 1) \cdots (\sigma^{i_k j_k} - 1)) = t^{i_1 j_1} t^{i_1 j_2} \cdots t^{i_k j_k} + (\text{higher terms}), \quad (3)$$

and the maps  $\bar{Z}_n^m$  are surjective. Furthermore, as we mod out by  $I^{m+1}$ , products of the form

$$(\sigma^{i_1 j_1} - 1)(\sigma^{i_1 j_2} - 1) \cdots (\sigma^{i_m j_m} - 1)$$

generate  $\mathcal{G}_m PB_n$ , and hence it is enough to verify the injectivity of  $\bar{Z}_n^m$  on such products.

To do this we attempt to construct an inverse map  $Y_n^m$  by setting

$$Y_n^m(t^{i_1 j_1} t^{i_1 j_2} \cdots t^{i_m j_m}) = (\sigma^{i_1 j_1} - 1)(\sigma^{i_1 j_2} - 1) \cdots (\sigma^{i_m j_m} - 1).$$

We only need to show that  $Y_n^m$  is well defined; i.e., that it carries the relations in  $\mathcal{G}_m \mathcal{A}_n^{pb}$  to relations in  $\mathcal{G}_m PB_n$ . This is a routine verification. For example, if  $i < j < k$ , the braid relation  $[\sigma^{jk}, \sigma^{ij} \sigma^{ik}] = 0$  (“the third Reidemeister move”) implies  $[\sigma^{jk} - 1, (\sigma^{ij} - 1) + (\sigma^{ik} - 1) - (\sigma^{ij} - 1)(\sigma^{ik} - 1)] = 0$ . Notice that the last term in this equality lies in a higher power of the augmentation ideal, and hence it can be ignored. What remains proves that  $Y_n^m$  maps the  $4T$  relation  $[t^{jk}, t^{ij} + t^{ik}]$  to 0 in the case when  $i < j < k$ .  $\square$

*Remark 3.7.* In the language of Vassiliev invariants, the last proof is essentially the identification of the space of weight systems for pure braids with the dual of  $\mathcal{A}^{pb}$ . If you know that language, you may find it amusing to translate the above proof to the Vassiliev setting.

*Remark 3.8.* Implicitly in the proof of Proposition 3.6 we have also proved that  $\hat{C}$  is the “associated graded mathematical structure” of the filtered structure  $\hat{B}$ .

Propositions 3.4 and 3.6 imply the following:

**Theorem 1.** *The set  $\widehat{\mathbf{ASS}}(\mathbf{ASS}^{(m)})$  can be identified with the set of all structure-preserving isomorphisms  $\hat{B} \rightarrow \hat{C}$  ( $B^{(m)} \rightarrow C^{(m)}$ ).*  $\square$

This would not be of much use if it was not for the following theorem, proven by Drinfel’d [Dr1, Dr2] using complex-analytic techniques:

**Theorem 2.** *The set  $\widehat{\mathbf{ASS}}(\mathbb{C})$  (and thus  $\mathbf{ASS}^{(m)}$ ) is non-empty.*  $\square$

This, in turn, allows us to use Principle 1 and get:

**Theorem 3.** *The groups  $\widehat{\mathbf{GT}}(\mathbb{C})$  and  $\widehat{\mathbf{GRT}}(\mathbb{C})$  act simply transitively on  $\widehat{\mathbf{ASS}}(\mathbb{C})$  on the right and on the left respectively, and their actions commute. The same holds for  $\mathbf{GT}^{(m)}(\mathbb{C})$ ,  $\mathbf{GRT}^{(m)}(\mathbb{C})$ , and  $\mathbf{ASS}^{(m)}(\mathbb{C})$ .*  $\square$

It is a consequence (and indeed, the purpose) of our main theorem below, that Theorems 2 and 3 also hold over  $\mathbb{Q}$ .

## 4. THE MAIN THEOREM

4.1. **The statement, consequences, and first reduction.** Our main theorem is:

**Theorem 4.** (*Proof on page 18*) *The natural map  $\mathbf{ASS}^{(m)}(\mathbb{C}) \rightarrow \mathbf{ASS}^{(m-1)}(\mathbb{C})$  is surjective.*

This theorem means that an associator can be constructed degree by degree. Furthermore, if  $\Phi_{m-1} \in \mathbf{ASS}^{(m-1)}$  is an associator up to degree  $m-1$  and  $\Phi_m = \Phi_{m-1} + \varphi_m$ , with  $\deg \varphi_m = m$ , then the equations<sup>6</sup> that  $\varphi_m$  has to satisfy for  $\Phi_m$  to be an associator up to degree  $m$  are non-homogeneous linear, with a constant term determined algebraically from  $\Phi_{m-1}$ . Therefore, if a  $\Phi_{m-1}$  is found over the rationals, then a  $\Phi_m$  can be found over the rationals (i.e., the statement of Theorem 4 also holds over  $\mathbb{Q}$ ). Proceeding using induction, we find that a rational associator exists (and so Theorems 2 and 3 also hold over  $\mathbb{Q}$ ).

**Corollary 4.1.** *Rational associators exist and can be constructed iteratively.*  $\square$

Let  $P$  be the automorphism of  $\mathcal{A}^{pb}$  that sends every generator  $t^{ij}$  to its negative  $-t^{ij}$ . It is clear that  $P$  preserves  $\mathbf{ASS}^{(m)}$  (it simply switches the positive and negative hexagon identities while not touching the pentagon identity). If  $\Phi_{m-1} \in \mathbf{ASS}^{(m-1)}$  is even (i.e., satisfies  $\Phi_{m-1} = P\Phi_{m-1}$ ), it can be lifted to an even  $\Phi_m \in \mathbf{ASS}^{(m)}$ : Simply take any lifting  $\Phi'_m$  and set  $\Phi_m = (\Phi'_m + P\Phi'_m)/2$ . This is an associator because the set of liftings of  $\Phi_{m-1}$  is affine, as it is determined by the solutions of a non-homogeneous linear equation.

**Corollary 4.2.** *Rational even associators exist and can be constructed iteratively.*  $\square$

*Remark 4.3.* Even associators were given a topological interpretation in [LM2], and were used further in [LMO].

**Lemma 4.4.** *To prove Theorem 4 it is enough to prove that the natural homomorphism  $\mathbf{GRT}^{(m)}(\mathbb{C}) \rightarrow \mathbf{GRT}^{(m-1)}(\mathbb{C})$  is surjective.*

*Proof.* By Theorem 2,  $\mathbf{ASS}^{(m)}(\mathbb{C})$  is non-empty, and so there exists at least one  $\Phi_{m-1} \in \mathbf{ASS}^{(m-1)}(\mathbb{C})$  that extends to a  $\Phi_m \in \mathbf{ASS}^{(m)}(\mathbb{C})$ . Take now any other element  $\Phi'_{m-1}$  of  $\mathbf{ASS}^{(m-1)}(\mathbb{C})$ . By Theorem 3, it can be pushed to  $\Phi_{m-1}$  by some  $G_{m-1} \in \mathbf{GRT}^{(m-1)}(\mathbb{C})$ . Take a  $G_m \in \mathbf{GRT}^{(m)}(\mathbb{C})$  that extends  $G_{m-1}$ , and use it to pull  $\Phi_m$  back to become an extension  $G_m^{-1}\Phi_m$  of  $\Phi'_{m-1}$ , as required.  $\square$

4.2. **More on the group  $\widehat{\mathbf{GRT}}$ .** To prove the surjectivity of  $\mathbf{GRT}^{(m)}(A) \rightarrow \mathbf{GRT}^{(m-1)}(A)$  for some ground algebra  $A$ , we need to know some more about  $\mathbf{GRT}^{(m)} = \text{Aut } C^{(m)}$  and about the structure  $C^{(m)}$  itself. Recall that the category **PaCD** is generated by the (repeated)  $d_i$  images of the specific morphisms  $a^{\pm 1}$ ,  $X$  and  $H$ .

**Proposition 4.5.** *The (repeated)  $d_i$  images of the relations below generate all the relations between generators of **PaCD**:*

- $X$  is its own inverse and it commutes with  $H$ .
- The pentagon  $d_4a \circ d_2a \circ d_0a = d_1a \circ d_3a$ , as for the category **PaB**.

<sup>6</sup>More on these equations can be found in Drinfel'd [Dr2] and in [B-N3].

- *The classical hexagon*

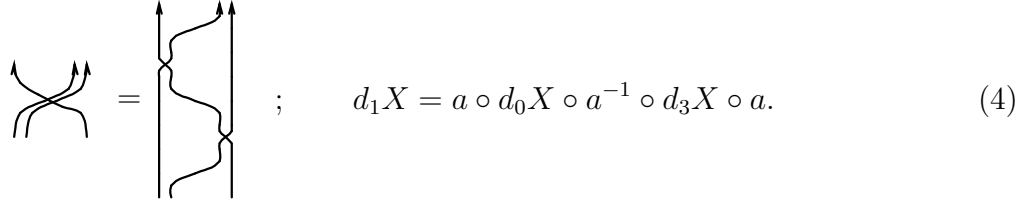

$$d_1 X = a \circ d_0 X \circ a^{-1} \circ d_3 X \circ a. \quad (4)$$

- *The semi-classical hexagon (the name is explained in Remark 4.6)*

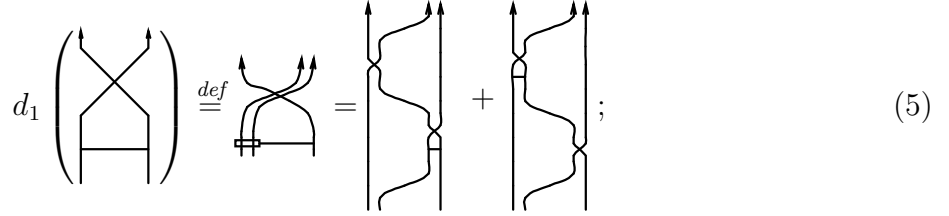

$$d_1 \left( \begin{array}{c} \text{crossing} \\ \text{---} \\ \text{---} \end{array} \right) \stackrel{\text{def}}{=} \begin{array}{c} \text{crossing} \\ \text{---} \\ \text{---} \end{array} = \begin{array}{c} \text{strand 1} \\ \text{---} \\ \text{---} \end{array} + \begin{array}{c} \text{strand 2} \\ \text{---} \\ \text{---} \end{array}; \quad (5)$$

$$d_1 H \circ d_1 X = a \circ d_0 H \circ d_0 X \circ a^{-1} \circ d_3 X \circ a + a \circ d_0 X \circ a^{-1} \circ d_3 H \circ d_3 X \circ a.$$

- *Locality in space as in PaB (but with  $A, B \in \{a^{\pm 1}, X, H\}$ ).*
- *Locality in scale:*

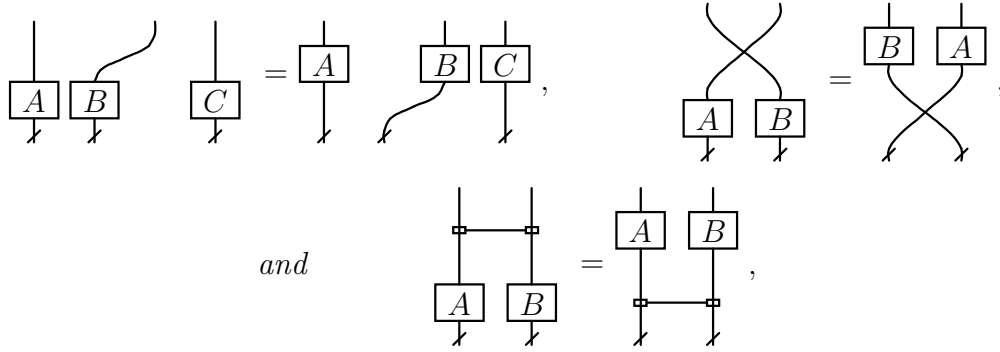

$$\begin{array}{c} \text{---} \\ \text{---} \\ \text{---} \end{array} = \begin{array}{c} \boxed{A} \\ \text{---} \\ \text{---} \end{array} \begin{array}{c} \boxed{B} \\ \text{---} \\ \text{---} \end{array}, \quad \begin{array}{c} \text{---} \\ \text{---} \\ \text{---} \end{array} = \begin{array}{c} \boxed{B} \\ \text{---} \\ \text{---} \end{array} \begin{array}{c} \boxed{A} \\ \text{---} \\ \text{---} \end{array},$$

and

$$\begin{array}{c} \text{---} \\ \text{---} \\ \text{---} \end{array} = \begin{array}{c} \boxed{A} \\ \text{---} \\ \text{---} \end{array} \begin{array}{c} \boxed{B} \\ \text{---} \\ \text{---} \end{array},$$

with  $A, B, C \in \{a^{\pm 1}, X, H\}$ .

*Proof.* (sketch) Let  $\mathbf{TMP}$  be the fibered-linear category freely generated by the repeated  $d_i$  images of  $a^{\pm 1}$ ,  $X$  and  $H$  in  $\mathbf{PaCD}$ , modulo the relations listed above. There is an obvious functor  $\mathbf{F} : \mathbf{TMP} \rightarrow \mathbf{PaCD}$ , which is well defined because the relations above are indeed relations in  $\mathbf{PaCD}$  ( $4T$  is needed to verify the third locality in scale relation with  $A$  or  $B$  equal  $H$ ). The category  $\mathbf{TMP}$  is graded by declaring that  $\deg a = \deg X = 0$ , that  $\deg H = 1$ , and that the operations  $d_i$  preserve degree. Clearly, the functor  $\mathbf{F}$  preserves degrees. We need to show that  $\mathbf{F}$  is invertible, and we do so by constructing an inverse  $\mathbf{G} : \mathbf{PaCD} \rightarrow \mathbf{TMP}$  in steps as follows:

- (1) There is no problem with constructing  $\mathbf{G}$  in degree 0. The relevant generators of  $\mathbf{TMP}$  are commutativities  $X$  and associativities  $a^{\pm 1}$ , and the relevant relations are (some of) the locality relations and the pentagon and the classical hexagon. Thus the existence of  $\mathbf{G}$  in degree 0 is exactly the Mac Lane coherence Theorem [Ma].

Let  $\mathbf{PaCD}_r$  ( $\mathbf{TMP}_r$ ) be the algebra of self-morphisms of the object  $O_r = (\bullet(\bullet \dots (\bullet\bullet) \dots))$  in  $\mathbf{PaCD}$  ( $\mathbf{TMP}$ ) that cover the identity permutation in  $\mathbf{PaP}$ , and let  $\mathbf{F}_r : \mathbf{TMP}_r \rightarrow \mathbf{PaCD}_r$  be the obvious restriction of  $\mathbf{F}$ . Our next objective is to construct  $\mathbf{G}_r$ , an inverse of  $\mathbf{F}_r$ . There is no loss of generality in assuming that all morphisms that we deal with involve



exactly  $n$  strands (for some fixed  $n$ ). With this in mind, the  $\mathbf{PaCD}_r$  can be identified with  $\mathcal{A}_n^{pb}$ .

- (2) Construct  $\mathbf{G}_r$  in degree 1. It is enough to specify the image in  $\mathbf{TMP}_r$  of  $t^{ij} \in \mathcal{A}_n^{pb}$ , and to check that  $\mathbf{G}_r$  is indeed the inverse of  $\mathbf{F}_r$  in degree 1. So for  $i < j$  set  $\mathbf{G}(t^{ij}) = P_{ij}^{-1} \circ H_n \circ P_{ij}$ . Here  $H_n = d_0^{n-1} d_0^{n-2} \cdots d_0^2 H$  is  $H$  extended by adding strands on the left and  $P_{ij} \in \text{mor}_{\mathbf{TMP}}(O_r, O_r)$  with  $\deg P_{ij} = 0$  corresponds to the parenthesized permutation that takes the  $j$ th strand to be the last and the  $i$ th to be the one before the last, while preserving the order of all other strands. (Step (1) implies that it does not matter which particular generator combination we choose for  $P_{ij}$ ). Now  $\mathbf{F}_r \circ \mathbf{G}_r = Id$  is trivial, and  $\mathbf{G}_r \circ \mathbf{F}_r = Id : \mathbf{TMP}_r \rightarrow \mathbf{TMP}_r$  is not hard to check. Indeed, a degree 1 morphism in  $\mathbf{TMP}_r$  contains exactly one (repeated  $d_i$  image of)  $H$ . By the semi-classical hexagon we can replace cabled  $H$ 's by extended ones (terminology as in Definition 2.12), and extended  $H$ 's can be slid right using locality in scale relations:

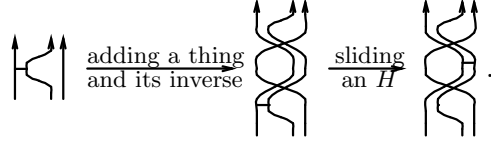

Finally, on “right justified”  $H$ 's there is almost nothing to prove.

- (3) By extending  $\mathbf{G}_r$  multiplicatively to higher degrees, we find that the free algebra  $FT$  generated by  $\mathcal{G}_1 \mathbf{TMP}_r$  is isomorphic to the free algebra  $FA$  generated by  $\mathcal{G}_1 \mathcal{A}_n^{pb}$ . The algebra  $\mathbf{TMP}_r$  is the quotient of  $FT$  by the quadratic locality relations: locality in space with  $A = B = H$ , and the third locality in scale relation with either  $A = H$  or  $B = H$ . The algebra  $\mathcal{G}_1 \mathcal{A}_n^{pb}$  is the quotient of  $FA$  by quadratic relations: the relation  $[t^{ij}, t^{kl}] = 0$  and the  $4T$  relation  $[t^{jk}, t^{ij} + t^{ik}] = 0$ . Quite clearly, these relations correspond under the isomorphisms between  $FT$  and  $FA$ ; the locality relation  $\uparrow \begin{array}{c} \uparrow \uparrow \\ \text{---} \\ \uparrow \uparrow \end{array} = \uparrow \begin{array}{c} \uparrow \uparrow \\ \text{---} \\ \uparrow \uparrow \end{array}$ , for example, is sent to the  $4T$  relation. We conclude that the quotients  $\mathbf{TMP}_r$  and  $\mathcal{A}_n^{pb}$  are isomorphic via  $\mathbf{F}_r$  and  $\mathbf{G}_r$ .

Finally, we get back to constructing  $\mathbf{G}$ :

- (4) Every morphism  $M$  in  $\mathbf{PaCD}$  can be written uniquely as a composition  $P_1 \circ D \circ P_2$  where  $D \in \mathcal{A}_n^{pb} = \mathbf{PaCD}_r$ ,  $P_{1,2}$  are of degree 0, and  $P_1$  induces the identity permutation (between possibly different parenthesizations). Define  $\mathbf{G}(M) = \mathbf{G}(P_1) \circ \mathbf{G}_r(D) \circ \mathbf{G}(P_2)$ . Clearly,  $\mathbf{G}$  is the inverse of  $\mathbf{F}$ .  $\square$

*Remark 4.6.* Let  $\epsilon$  be a formal parameter satisfying  $\epsilon^2 = 0$ , and let  $\mathbf{PaCD}_\epsilon$  be defined as  $\mathbf{PaCD}$ , only with coefficients in the algebra  $A[\epsilon]$  rather than the algebra  $A$ . Let  $R_\epsilon$  be the morphism  $(\exp \epsilon H) \circ X$  in  $\mathbf{PaCD}_\epsilon$ , and consider the “quantum” hexagon relation for  $R_\epsilon$ :

$$d_1 R_\epsilon = a \circ d_0 R_\epsilon \circ a^{-1} \circ d_3 R_\epsilon \circ a.$$

A quick visual inspection of equations (2) (with  $R_\epsilon$  replacing  $\sigma$ ), (4) and (5) reveals that the classical and semi-classical hexagon relations are the degree 0 and 1 parts (in  $\epsilon$ ) of the quantum hexagon relation, explaining their names.

*Remark 4.7.* Modulo the other relations, the semi-classical hexagon is equivalent to the simpler but less conceptual “cabling relation”,  $d_2H = a^{-1} \circ d_3H \circ a + d_0X \circ a^{-1} \circ d_3H \circ a \circ d_0X$ :

$$d_2 \left( \begin{array}{c} \uparrow \quad \uparrow \\ \text{---} \\ \uparrow \quad \uparrow \end{array} \right) \stackrel{\text{def}}{=} \begin{array}{c} \uparrow \quad \uparrow \\ \text{---} \\ \uparrow \quad \uparrow \end{array} + \begin{array}{c} \uparrow \quad \uparrow \\ \text{---} \\ \uparrow \quad \uparrow \end{array}.$$

By Claim 2.16 and Remark 2.15, any  $G \in \mathbf{GRT}^{(m)}$  is determined by its action on the generator  $a$  of  $\mathbf{PaCD}^{(m)}$ , and thus it is determined by the unique  $\Gamma \in \mathcal{A}_3^{pb(m)}$  for which  $G(a) = \Gamma \cdot a$ . Just as in the proof of Proposition 3.4, the relations of Proposition 4.5 impose relations on  $\Gamma$ :

**Proposition 4.8.** *The group  $\mathbf{GRT}^{(m)}(\widehat{\mathbf{GRT}})$  can be identified (as a set) with the set of all group-like non-degenerate  $\Gamma \in \mathcal{A}_3^{pb(m)}$  ( $\Gamma \in \hat{\mathcal{A}}_3^{pb}$ ) satisfying:*

- The pentagon equation  $d_4\Gamma \cdot d_2\Gamma \cdot d_0\Gamma = d_1\Gamma \cdot d_3\Gamma$ .
- The classical hexagon equation  $1 = \Gamma \cdot (\Gamma^{-1})^{132} \cdot \Gamma^{312}$ .
- The semi-classical hexagon equation

$$d_1t^{12} = \Gamma \cdot (t^{23} \cdot (\Gamma^{-1})^{132} + (\Gamma^{-1})^{132} \cdot t^{13}) \cdot \Gamma^{312},$$

or, equivalently, the cabling equation  $d_2t^{12} = \Gamma^{-1} \cdot t^{12} \cdot \Gamma + (\Gamma^{-1} \cdot t^{12} \cdot \Gamma)^{132}$ .

*Proof.* The group-like property and the non-degeneracy of  $\Gamma$  correspond to the fact that  $G$  preserves  $\square$  and the operations  $s_i$ . The pentagon, classical and semi-classical hexagon, and cabling equations correspond to their namesakes in Proposition 4.5. The other relations in Proposition 4.5 impose no further constraints on  $\Gamma$ ; the locality relations follow from Lemma 3.5 and the relations  $X^2 = 1$  and  $XH = HX$  do not involve  $\Gamma$  at all.  $\square$

*Warning 4.9.* The product of  $\mathbf{GRT}^{(m)}(\widehat{\mathbf{GRT}})$  is not the product of  $\mathcal{A}^{pb(m)}(\hat{\mathcal{A}}^{pb})$ . See Proposition 5.1.

*Remark 4.10.* The classical hexagon axiom for  $\Gamma \in \mathbf{GRT}^{(m)}$  implies that  $\Gamma = 1 + (\text{higher degree terms})$ .

*Remark 4.11.* In the spirit of Remark 4.6, the classical and semi-classical hexagon equations can be replaced by a single “quantum hexagon equation” written in  $\mathcal{A}_3^{pb(m)}(A[\epsilon])$ :

$$e^{\epsilon(t^{13}+t^{23})} = \Gamma \cdot e^{\epsilon t^{23}} \cdot (\Gamma^{-1})^{132} \cdot e^{\epsilon t^{13}} \cdot \Gamma^{312}. \quad (6)$$

### 4.3. The second reduction.

**Theorem 5.** *(Proof on page 20) The pentagon and classical hexagon equations for  $\Gamma \in \mathcal{A}_3^{pb(m)}$  imply the semi-classical hexagon equation (and hence the cabling equation).*

Assuming Theorem 5, the proof of Theorem 4 reduces to an easy observation and some standard (but non-trivial) facts from the theory of affine group schemes.

*Proof of Theorem 4.* By Lemma 4.4, it is enough to show that the natural homomorphism  $\pi : \mathbf{GRT}^{(m)}(\mathbb{C}) \rightarrow \mathbf{GRT}^{(m-1)}(\mathbb{C})$  is surjective. In the next paragraph we will show that  $\pi$  is a homomorphism of connected reduced algebraic group schemes. Hence it is enough

to prove this statement at the level of Lie algebras, and the Lie algebras are given by the linearizations near the identity 1 of the defining equations, the pentagon and the classical hexagon. These linearizations are

$$d_4\gamma + d_2\gamma + d_0\gamma = d_1\gamma + d_3\gamma \quad \text{and} \quad 0 = \gamma - \gamma^{132} + \gamma^{312}. \quad (7)$$

Clearly, any solution to degree  $m - 1$  of these equations can be extended to a solution to degree  $m$  (for example, by taking the degree  $m$  piece to be 0). Notice that if the cabling relation was still present, this would not have been so easy: The linearization of the cabling relation is  $0 = [t^{12}, \gamma] + [t^{13}, \gamma^{132}]$ , and this equation at degree  $m$  imposes a (possibly new) condition on the degree  $m - 1$  piece of  $\gamma$ .

All that is left now is some standard algebraic geometry. We defined  $\mathbf{GRT}^{(m)}(A)$  for an arbitrary ground algebra  $A$  in a functorial way, and saw that it is always defined by the same equations (Proposition 4.8). Thus  $\mathbf{GRT}^{(m)}$  (regarded as a functor from the category of  $\mathbb{Q}$ -algebras to the category of groups) is an affine group scheme (see e.g. [Wa, section 1.2]) for any  $m$  (and similarly, the map  $\mathbf{GRT}^{(m)} \rightarrow \mathbf{GRT}^{(m-1)}$  is a homomorphism of affine group schemes).  $\mathbf{GRT}^{(m)}$  has a faithful representation in the vector space  $V$  of parenthesized chord diagrams whose skeleton is  $a$  (already the action of  $G \in \mathbf{GRT}^{(m)}$  on  $a$  itself determines  $G$ ). Thus  $\mathbf{GRT}^{(m)}$  can be regarded as an algebraic matrix group. Notice that for any  $G \in \mathbf{GRT}^{(m)}$ , we have  $G(X) = X$ ,  $G(H) = H$ , and  $G(a) = a + (\text{higher degrees})$ , and hence for any homogeneous  $v \in V$  we have  $G(v) = v + (\text{higher degrees})$ . Hence  $G$  is unipotent, and  $\mathbf{GRT}^{(m)}$  is a unipotent group [Wa, section 8]. As we are working in characteristic 0,  $\mathbf{GRT}^{(m)}$  is reduced [Wa, section 11.4] (and hence (7) defines its Lie algebra) and  $\mathbf{GRT}^{(m-1)}$  is connected [Wa, section 8.5].  $\square$

*Remark 4.12.* Very little additional effort as in the paragraph following Theorem 4 shows that  $\mathbf{GRT}^{(m)}(A) \rightarrow \mathbf{GRT}^{(m-1)}(A)$  is surjective for any  $A$ .

**4.4. A cohomological interlude.** Before we can prove Theorem 5, we need to know a bit about the second cohomology of  $\mathcal{A}_n^{pb}$ . There are two relevant ways of turning the list  $\mathcal{A}_2^{pb}, \mathcal{A}_3^{pb}, \dots$  into a cochain complex. The first is to define  $d = d^n : \mathcal{A}_n^{pb} \rightarrow \mathcal{A}_{n+1}^{pb}$  by  $d^n = \sum_{i=0}^{n+1} (-1)^i d_i^n$ . The second is to define  $\tilde{d} = \tilde{d}^n : \mathcal{A}_{n+1}^{pb} \rightarrow \mathcal{A}_{n+2}^{pb}$  (notice the shift in dimension) by  $\tilde{d}^n = \sum_{i=0}^{n+1} (-1)^i \tilde{d}_i^n$ , where  $\tilde{d}_i = \tilde{d}_i^n = d_i^{n+1}$  for  $i \leq n$ , and  $\tilde{d}_{n+1} = \tilde{d}_{n+1}^n = (d_{n+2}^{n+1})^{12\dots n(n+2)(n+1)}$  is the operation of “adding an empty strand between strands  $n$  and  $n + 1$ ”:

$$\tilde{d}_3 \left( \begin{array}{c} \uparrow \quad \uparrow \quad \uparrow \\ \text{---} \text{---} \text{---} \\ \uparrow \quad \uparrow \quad \uparrow \end{array} \right) = \begin{array}{c} \uparrow \quad \uparrow \quad \uparrow \\ \text{---} \text{---} \text{---} \\ \uparrow \quad \uparrow \quad \uparrow \end{array}.$$

For the purpose of proving Theorem 5, all we need is to understand  $H_{\tilde{d}}^2$ :

**Proposition 4.13.**  $H_{\tilde{d}}^2$  is 2-dimensional and is generated by  $t^{12}$  (in degree 1) and  $[t^{13}, t^{23}]$  (in degree 2).

*Proof.* It is well known (see e.g. [Koh1, Dr2, Hu, B-N4]) that as vector spaces,  $\mathcal{A}_{n+1}^{pb} = \mathcal{A}_n^{pb} \otimes \mathcal{TV}^n$ , where  $\mathcal{TV}^n$  denotes the tensor algebra on the  $n$ -dimensional vector space  $V^n$  generated by  $t^{1(n+1)}, \dots, t^{n(n+1)}$  (as algebras, this is a semi-direct product). Furthermore,  $\tilde{d}_i^n$  and the strand removal operations  $\tilde{s}_i^n \stackrel{\text{def}}{=} s_i^{n+1}$  preserve this decomposition, and define a structure of a cosimplicial vector space on each of  $\mathcal{A}_{n+1}^{pb}$ ,  $\mathcal{A}_n^{pb}$ , and  $V^n$ . The cosimplicial

structure induced on  $\mathcal{A}_n^{pb}$  coincides with the one it already has  $((d_i^n, s_i^n))$ , and hence by the Eilenberg-Zilber theorem and the Künneth formula

$$H_d^* = H_d^* \hat{\otimes} \hat{\mathcal{T}} H^*(V^*). \quad (8)$$

(Here  $\hat{\otimes}$  denotes the  $\mathbb{Z}/2\mathbb{Z}$ -graded tensor product and  $\hat{\mathcal{T}}$  denotes the tensor algebra formed using  $\hat{\otimes}$ ).

*Computing  $H_d^*$ :* The cohomology  $H_d^*$  is very hard to compute. Indeed, if we could compute  $H_d^4$ , we probably needn't have written this paper at all (see [Dr2, B-N4]). But up to  $H_d^2$  there is no difficulty in computing by hand. The algebras  $\mathcal{A}_0^{pb}$  and  $\mathcal{A}_1^{pb}$  contain only multiples of the identity element. The algebra  $\mathcal{A}_2^{pb}$  contains only the powers of  $t^{12}$ . The differential  $d^0 : \mathcal{A}_0^{pb} \rightarrow \mathcal{A}_1^{pb}$  is the zero map, the differential  $d^1 : \mathcal{A}_1^{pb} \rightarrow \mathcal{A}_2^{pb}$  is injective, mapping the identity of  $\mathcal{A}_1^{pb}$  to the identity of  $\mathcal{A}_2^{pb}$ . Finally, let us study  $d^2(t^{12})^m \in \mathcal{A}_3^{pb}$ . Setting  $c = t^{12} + t^{13} + t^{23} \in \mathcal{A}_3^{pb}$ , we get:

$$d^2(t^{12})^m = \sum_{i=0}^3 (-1)^i d_i^2(t^{12})^m = (t^{23})^m - (c - t^{12})^m + (c - t^{23})^m + (t^{12})^m.$$

The relations of Definition 2.7 (in the case  $n = 3$ ) can be rewritten in terms of the new generators  $t^{12}$ ,  $t^{23}$  and  $c$  of  $\mathcal{A}_3^{pb}$ . In these terms, they are equivalent to the statement “ $c$  is central”. Thus  $\mathcal{A}_3^{pb}$  is the central extension by  $c$  of the free algebra in  $t^{12}$  and  $t^{23}$ . Looking at the coefficient of (say)  $c(t^{12})^{(m-1)}$  in  $d^2(t^{12})^m$  as computed above, we find that  $d^2(t^{12})^m \neq 0$  for  $m \geq 2$ . It is easy to verify that  $d^2(t^{12})^m = 0$  for  $m = 0, 1$ . In summary, we found that  $\dim H_d^0 = 1$ , with the generator being the unit of  $\mathcal{A}_0^{pb}$ , that  $\dim H_d^1 = 0$ , and that  $H_d^2$  is one dimensional and is generated by  $t^{12}$ .

*Computing  $H^*(V^*)$ :* By the normalization theorem for simplicial cohomology the complex  $(V^n)$  has the same cohomology as the complex  $(\hat{V}^n)$  defined by  $\hat{C}^n = \bigcap_i \ker \tilde{s}_i^n$ . But it is clear that  $\hat{V}^n = 0$  unless  $n = 1$ , and that  $\hat{C}^1$  is 1-dimensional. Thus  $H^*(V^*)$  has only one generator,  $t^{12}$  in  $H^1(V^*)$ . (The same computation appears in [B-N3, Lemma 4.14]).

*Assembling the results:* Using (8) and the above two cohomology computations, we find that  $H_d^2$  is generated by the class of  $t^{12}$  (coming from  $H_d^2$ ) and a degree 2 class coming from the class  $t^{12} \otimes t^{12}$  in  $H^1(V^*) \hat{\otimes} H^1(V^*)$  via the Künneth map. An explicit computation of the latter (or a direct computation of the cycles and boundaries, which is easy in this low dimension), shows that it is the class of  $[t^{13}, t^{23}]$ .  $\square$

#### 4.5. Proof of the semi-classical hexagon equation.

*Proof of Theorem 5.* Assume that for some  $\Gamma \in \mathcal{A}_3^{pb(m)}$  the pentagon and the classical hexagon hold, but the semi-classical hexagon doesn't. By Remark 4.11, we know that the quantum hexagon (6) has an error proportional to  $\epsilon$ . Let  $\epsilon\psi'$  be that error:

$$1 + \epsilon\psi' = \Gamma \cdot e^{\epsilon t^{23}} \cdot (\Gamma^{-1})^{132} \cdot e^{\epsilon t^{13}} \cdot \Gamma^{312} \cdot e^{-\epsilon(t^{13} + t^{23})}.$$

By assumption,  $\psi' \neq 0$ . Let  $\psi$  be the lowest degree piece of  $\psi'$ , and let  $k = \deg \psi$ . Clearly,  $k \geq 2$ . From this point on, mod out by degrees higher than  $k$ .

We claim that

$$\tilde{d}^2 \psi = 0. \quad (9)$$

The proof of (9) is essentially contained in Figure 5. How polyhedra correspond to identities of this kind was explained in [Dr1], and again in [B-N3], where the very same polyhedron appeared in a very similar context. For completeness, we include the explanation here, in a very concrete form. In Figure 5 every edge is oriented and is labeled by some invertible element of  $\mathcal{A}_4^{pb(m)}(A[\epsilon])$ . There are 12 faces in the figure (including the face at infinity). Each one corresponds to a certain product in  $\mathcal{A}_4^{pb(m)}(A[\epsilon])$  by starting at the  $\clubsuit$  symbol, going counterclockwise, and multiplying the elements seen on the edges (or their inverses depending on the edge orientations). These products turn out to all be locality relations, or pentagons, or quantum hexagons (or a permutation or a cabling/extension operation applied to a pentagon or a quantum hexagon), as marked within each face.

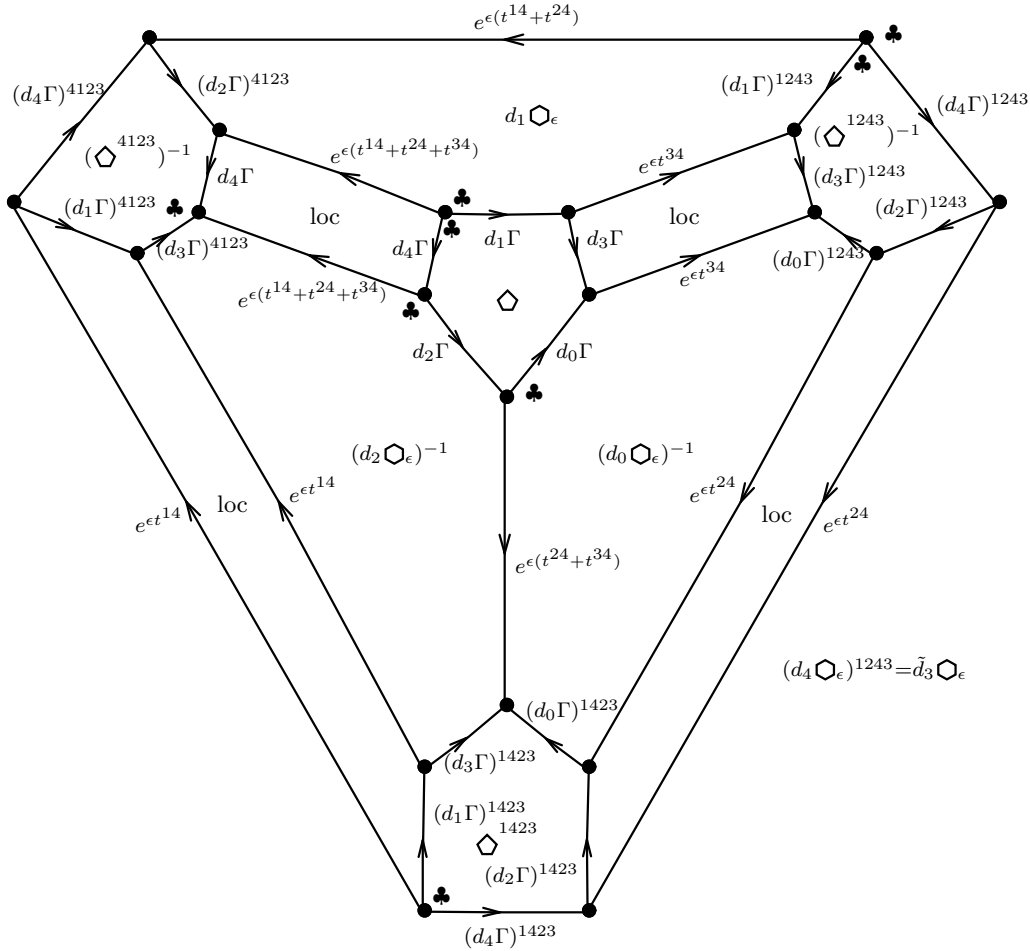
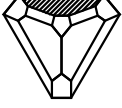

**Figure 5.** The proof of equation (9).

For example (remember that we are ignoring degrees higher than  $k$ ),



$$\rightarrow \quad \diamond: \quad 1 = d_4\Gamma d_2\Gamma d_0\Gamma (d_3\Gamma)^{-1} (d_1\Gamma)^{-1},$$



$$\rightarrow \quad d_1\circlearrowleft_\epsilon: \quad 1 + d_1\psi = d_1\Gamma e^{\epsilon t^{34}} ((d_1\Gamma)^{1243})^{-1} e^{\epsilon(t^{14}+t^{24})} (d_2\Gamma)^{4123} e^{-\epsilon(t^{14}+t^{24}+t^{34})},$$

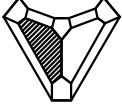

$$\rightarrow \quad d_2\circlearrowleft_\epsilon^{-1}: \quad 1 - d_2\psi = (\text{product around shaded area}).$$

Combining these equations along the common edges we get

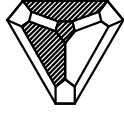

$$\rightarrow 1 + d_1\psi - d_2\psi = (\text{product around shaded area}).$$

Continuing along the same line, we find that the product around the whole figure is  $1 - d_0\psi + d_1\psi - d_2\psi$ . On the other hand, this product is itself a variant of the quantum hexagon —  $(\tilde{d}_3\circlearrowleft_\epsilon)^{-1}$ , as marked on the face at infinity. So we learn that  $1 - d_0\psi + d_1\psi - d_2\psi = 1 - \tilde{d}_3\psi$ . But this is exactly (9).

By (9) and Proposition 4.13, we see that if  $k > 2$  then  $\psi$  must be in  $\tilde{d}^1\mathcal{G}_k\mathcal{A}_2^{pb}$ . That is, it must be a multiple of  $\chi = \tilde{d}^1(t^{12})^k$ . But as  $\Gamma$  is group-like,  $\psi$  must be primitive:  $\square\psi = \psi \otimes 1 + 1 \otimes \psi$ . One easily verifies that  $\chi$  is not primitive, and hence  $\psi = 0$  as required. If  $k = 2$ , equation (9) and Proposition 4.13 tell us that  $\psi$  is of the form  $c_1\tilde{d}^1(t^{12})^2 + c_2[t^{13}, t^{23}]$ . A routine verification shows that if the semi-classical hexagon relation is pre-multiplied by  $d_3X$  and post-multiplied by  $d_0X$ , then modulo the other relations, it does not change. This means that  $\psi^{213} = \psi$  (this identity follows more easily from the cabling relation), and thus  $c_2 = 0$ . But then the primitivity of  $\psi$  implies that  $c_1$  vanishes as well, and thus  $\psi = 0$  as required.  $\square$

## 5. JUST FOR COMPLETENESS

For completeness, this section contains a description of the group law of  $\widehat{\mathbf{GRT}}$ , a description of its action on  $\widehat{\mathbf{ASS}}$ , and similar descriptions for the group  $\widehat{\mathbf{GT}}$ . This information is not needed in the main part of this paper. Throughout this section one can replace unipotent completions by unipotent quotients ( $\mathbf{GRT}^{(m)}$ ,  $\mathbf{ASS}^{(m)}$ ,  $\mathcal{A}^{pb(m)}$ , etc.) with no change to the results.

**Proposition 5.1.** *The group law  $\times$  of  $\widehat{\mathbf{GRT}}$  is expressed in terms of the  $\Gamma$ 's (of Proposition 4.8) as*

$$\Gamma_1 \times \Gamma_2 = \Gamma_1 \cdot \left( \Gamma_2 \Big|_{t^{12} \rightarrow \Gamma_1^{-1} t^{12} \Gamma_1, t^{13} \rightarrow (\Gamma_1^{-1})^{132} t^{13} \Gamma_1^{132}, t^{23} \rightarrow t^{23}} \right), \quad (10)$$

where “.” is the product of  $\hat{\mathcal{A}}^{pb}$ ,  $\Gamma_1^{-1}$  is interpreted in  $\hat{\mathcal{A}}^{pb}$ , and the substitution above means: replace every occurrence of  $t^{12}$  in  $\Gamma_2$  by  $\Gamma_1^{-1} t^{12} \Gamma_1$ , etc. (In particular, we claim that this substitution is well defined on  $\hat{\mathcal{A}}^{pb}$ ).

*Proof.*  $\hat{\mathcal{A}}_3^{pb}$  can be identified with the algebra of self-morphisms in  $\widehat{\mathbf{PaCD}}$  of the object  $(\bullet(\bullet\bullet))$ . Let  $\bar{\Gamma}$  denote the self-morphism corresponding to a  $\Gamma \in \hat{\mathcal{A}}_3^{pb}$ . We have  $\Gamma \cdot a = a \circ \bar{\Gamma}$ , and hence (with  $\Gamma \mapsto G_\Gamma$  denoting the identification in Proposition 4.8)

$$a \circ \overline{\Gamma_1 \times \Gamma_2} = G_{\Gamma_1 \times \Gamma_2}(a) = G_{\Gamma_1}(G_{\Gamma_2}(a)) = G_{\Gamma_1}(a \circ \bar{\Gamma}_2) = G_{\Gamma_1}(a) \circ G_{\Gamma_1}(\bar{\Gamma}_2) = a \circ \bar{\Gamma}_1 \circ G_{\Gamma_1}(\bar{\Gamma}_2). \quad (11)$$

To compute  $G_{\Gamma_1}(\bar{\Gamma}_2)$  we need to write  $\bar{\Gamma}_2$  in terms of the generators of  $\widehat{\mathbf{PaCD}}$ . This we do by replacing every  $t^{12}$  appearing in  $\Gamma_2$  by  $\bar{t}^{12} = a^{-1} \circ d_3 H \circ a$ , every  $t^{13}$  by  $\bar{t}^{13} = d_0 X \circ a^{-1} \circ d_3 H \circ a \circ d_0 X$ , and every  $t^{23}$  by  $\bar{t}^{23} = d_0 H$ . By the definition of the action of  $G_{\Gamma_1}$  on the generators of  $\widehat{\mathbf{PaCD}}$ , we find that it maps  $\bar{t}^{12}$  to  $\overline{\Gamma_1^{-1} t^{12} \Gamma_1}$ ,  $\bar{t}^{13}$  to  $\overline{(\Gamma_1^{-1})^{132} t^{13} \Gamma_1^{132}}$  and  $\bar{t}^{23}$  to  $\bar{t}^{23}$ . Combining this and (11) we get (10).  $\square$

Similar reasoning leads to the following:

**Proposition 5.2.** *The action of  $\widehat{\mathbf{GRT}}$  on  $\widehat{\mathbf{ASS}}$ , written in terms of  $\Gamma$ 's and  $\Phi$ 's, is given by*

$$\Gamma(\Phi) = \Gamma \cdot \left( \Phi \Big|_{t^{12} \rightarrow \Gamma_1^{-1} t^{12} \Gamma_1, t^{13} \rightarrow (\Gamma_1^{-1})^{132} t^{13} \Gamma_1^{132}, t^{23} \rightarrow t^{23}} \right),$$

with products and inverses taken in  $\hat{\mathcal{A}}_3^{pb}$ .  $\square$

The group  $\widehat{\mathbf{GT}}$  admits a similar description. Any element of  $\widehat{\mathbf{GT}}$  maps  $a$  to a limit of formal sums of parenthesized braids whose skeleton is  $a$ . Such a limit is of the form  $a \circ \Sigma$ , where  $\Sigma$  is a self-morphism whose skeleton is the identity of the object  $(\bullet(\bullet\bullet))$  of  $\widehat{\mathbf{PaB}}$ , regarded as an element of  $\widehat{PB}_3$ . Let  $\sigma_1$  and  $\sigma_2$  be the standard generators  $\times \uparrow$  and  $\uparrow \times$  of the (non-pure) braid group  $B_3$  on 3 strands. Every  $\Sigma \in \widehat{PB}_3$  is a limit of formal sums of combinations of  $\sigma_{1,2}$ .

**Proposition 5.3.** 1.  $\widehat{\mathbf{GT}}$  can be identified as the group of all group-like non-degenerate  $\Sigma \in \widehat{PB}_3$  satisfying:

- The pentagon for pure braids, in  $\widehat{PB}_4$ :

$$d_4 \Sigma \cdot d_2 \Sigma \cdot d_0 \Sigma = d_1 \Sigma \cdot d_3 \Sigma$$

(with the obvious interpretation for the  $d_i$ 's).

- The hexagons for pure braids, in  $\hat{B}_3$ , the unipotent completion of  $B_3$ :

$$\sigma_2 \sigma_1 = \Sigma \cdot \sigma_2 \cdot \Sigma^{-1} \cdot \sigma_1 \cdot \Sigma.$$

2. The group law is given by

$$\Sigma_1 \times \Sigma_2 = \Sigma_1 \cdot \left( \Sigma_2 \Big|_{\sigma_1 \rightarrow \Sigma_1^{-1} \sigma_1 \Sigma_1, \sigma_2 \rightarrow \sigma_2} \right),$$

with products and inverses taken in  $\hat{B}_3$ .

3. The action on  $\widehat{\mathbf{ASS}}$  is given by

$$(\Phi, \Sigma) \mapsto \Phi^\Sigma = \Phi \cdot \left( \Sigma \Big|_{\sigma_1 \rightarrow \Phi^{-1} e^{t^{12}/2} X_1 \Phi, \sigma_2 \rightarrow e^{t^{23}/2} X_2} \right).$$

This formula makes sense in  $\hat{\mathcal{A}}_3^{pb} \rtimes S_3$ , with  $X_1 = (12)$  and  $X_2 = (23)$  the standard generators of the permutation group  $S_3$  which acts on  $\hat{\mathcal{A}}_3^{pb}$  as in Definition 2.8. Implicitly we claim that this formula is well defined and valued in  $\hat{\mathcal{A}}_3^{pb} \subset \hat{\mathcal{A}}_3^{pb} \rtimes S_3$ .  $\square$

## REFERENCES

- [B-N1] D. Bar-Natan, *On the Vassiliev knot invariants*, *Topology* **34** 423–472 (1995).
- [B-N2] ———, *Vassiliev homotopy string link invariants*, *Jour. of Knot Theory and its Ramifications* **4** (1995) 13–32.
- [B-N3] ———, *Non-associative tangles*, in *Geometric topology* (proceedings of the Georgia international topology conference), (W. H. Kazez, ed.), 139–183, Amer. Math. Soc. and International Press, Providence, 1997.
- [B-N4] ———, *Vassiliev and quantum invariants of braids*, in *Proc. of Symp. in Appl. Math.* **51** (1996) 129–144 *The interface of knots and physics*, (L. H. Kauffman, ed.), Amer. Math. Soc., Providence.
- [B-N5] ———, *Bibliography of Vassiliev Invariants*, <http://www.ma.huji.ac.il/~drorbn>.
- [Bi] J. S. Birman, *New points of view in knot theory*, *Bull. Amer. Math. Soc.* **28** (1993) 253–287.
- [BL] ——— and X-S. Lin, *Knot polynomials and Vassiliev’s invariants*, *Inv. Math.* **111** (1993) 225–270.
- [Ca] P. Cartier, *Construction combinatoire des invariants de Vassiliev-Kontsevich des nœuds*, *C. R. Acad. Sci. Paris* **316** Série I (1993) 1205–1210.
- [Dr1] V. G. Drinfel’d, *Quasi-Hopf algebras*, *Leningrad Math. J.* **1** (1990) 1419–1457.
- [Dr2] ———, *On quasitriangular Quasi-Hopf algebras and a group closely connected with  $Gal(\bar{\mathbb{Q}}/\mathbb{Q})$* , *Leningrad Math. J.* **2** (1991) 829–860.
- [EK1] P. Etingof and D. Kazhdan, *Quantization of Lie bialgebras, I*, *Selecta Math.* **2-1** (1996) 1–41. See also q-alg/9506005.
- [EK2] ——— and ———, *Quantization of Poisson algebraic groups and Poisson homogeneous spaces*, q-alg/9510020 preprint.
- [Go1] M. Goussarov, *A new form of the Conway-Jones polynomial of oriented links*, in *Topology of manifolds and varieties* (O. Viro, editor), Amer. Math. Soc., Providence 1994, 167–172.
- [Go2] ———, *On  $n$ -equivalence of knots and invariants of finite degree*, in *Topology of manifolds and varieties* (O. Viro, editor), Amer. Math. Soc., Providence 1994, 173–192.
- [Hu] M. Hutchings, *Integration of singular braid invariants and graph cohomology*, Harvard University preprint, April 1995.
- [Ka] C. Kassel, *Quantum groups*, Springer-Verlag GTM **155**, New York 1994.
- [KT] ——— and V. Turaev, *Chord diagram invariants of tangles and graphs*, University of Strasbourg preprint, January 1995.
- [Koh1] T. Kohno, *Monodromy representations of braid groups and Yang-Baxter equations*, *Ann. Inst. Fourier* **37** (1987) 139–160.
- [Koh2] ———, *Vassiliev invariants and de-Rham complex on the space of knots*, *Contemp. Math.* **179** (1994) 123–138.
- [Kon] M. Kontsevich, *Vassiliev’s knot invariants*, *Adv. in Sov. Math.*, **16(2)** (1993) 137–150.
- [Le] T. Q. T. Le, *An invariant of integral homology 3-spheres which is universal for all finite type invariants*, in *Solitons, geometry and topology: on the crossroad*, (V. Buchstaber and S. Novikov, eds.) AMS Translations Series 2, Providence. See also q-alg/9601002.
- [LM1] ——— and J. Murakami, *The universal Vassiliev-Kontsevich invariant for framed oriented links*, *Compositio Math.* **102** (1996), 42–64. See also hep-th/9401016.
- [LM2] ——— and ———, *Parallel version of the universal Vassiliev-Kontsevich invariant*, to appear in *J. Pure and Appl. Algebra*.
- [LMO] ———, ——— and T. Ohtsuki, *On a universal quantum invariant of 3-manifolds*, to appear in *Topology*. See also q-alg/9512002.
- [LS1] P. Lochak and L. Schneps, *The Grothendieck-Teichmüller group and automorphisms of braid groups*, in [Sc], 323–358.
- [LS2] ——— and ———, *The  $k$ -pro-unipotent braid tower and the Grothendieck-Teichmüller group*, preprint.
- [Ma] S. Mac Lane, *Categories for the working mathematician*, Springer-Verlag GTM **5**, New-York 1971.
- [Pi] S. Piunikhin, *Combinatorial expression for universal Vassiliev link invariant*, *Commun. Math. Phys.* **168-1** 1–22.
- [Sc] L. Schneps (ed.), *The Grothendieck theory of dessins d’enfants*, London Math. Soc. Lec. Notes Ser. **200** (1994), Cambridge Univ. Press, Cambridge UK.



- [SS] S. Shnider and S. Sternberg, *Quantum groups — from coalgebras to Drinfel'd algebras*, International Press, Cambridge MA 1994.
- [Va1] V. A. Vassiliev, *Cohomology of knot spaces*, Theory of Singularities and its Applications (Providence) (V. I. Arnold, ed.), Amer. Math. Soc., Providence, 1990.
- [Va2] ———, *Complements of discriminants of smooth maps: topology and applications*, Trans. of Math. Mono. **98**, Amer. Math. Soc., Providence, 1992.
- [Wa] W. C. Waterhouse, *Introduction to affine group schemes*, Springer-Verlag GTM **66**, New-York 1979.
- [Za] D. Zagier, *Values of zeta functions and their applications*, Max-Planck-Institut Bonn preprint.

INSTITUTE OF MATHEMATICS, THE HEBREW UNIVERSITY, GIV'AT-RAM, JERUSALEM 91904, ISRAEL  
*E-mail address:* drorbn@math.huji.ac.il