

# $SL(2, \mathbf{C})$ -TOPOLOGICAL QUANTUM FIELD THEORY WITH CORNERS

Răzvan Gelca

November 6, 2018

## Abstract

We describe the construction of a topological quantum field theory with corners for 3-manifolds, using quantum deformations of  $sl(2, \mathbf{C})$ . In the construction there appears a sign obstruction for some of the Moore-Seiberg equations. We solve this problem by means of the Klein four group.

## 0. INTRODUCTION

This paper contains the basic ideas for the construction of an  $sl(2, \mathbf{C})$  topological quantum field theory for orientable 3-manifolds. The construction is done following ideas originated in [RT], where the authors describe the construction, for any modular Hopf algebra, of a topological quantum field theory that satisfies the Atiyah-Segal axioms (a so called smooth topological quantum field theory), see also [T] and [KM].

In [Wa] it is described a construction of a topological quantum field theory from a modular Hopf algebra, when one allows gluings along surfaces with *boundary* (a topological quantum field theory with corners). Compared to the construction described in [RT], this approach enables us to localize computations, unlike the case of surgery diagrams where computations are global. This also leads to various ways of computing the Jones polynomial ( $[J]$ ) for knots.

The key elements in this construction are the decompositions of surfaces into disks, annuli and pairs of pants, and the moves that transform one decomposition into another. A surface together with such a decomposition is the analogue of a vector space endowed with a basis. For topological quantum field theories with corners this point of view is essential, since in this case the gluings will

occur along whole subsurfaces on the boundary of 3-manifolds. This is also a very useful approach even for smooth topological quantum field theories if one wants to do computations, since the rather complicated mapping class group is replaced with the simpler groupoid of transformations between decompositions.

Unfortunately,  $sl(2, \mathbf{C})$  topological quantum field theory does not fit in this framework, since there appears a sign problem. This sign problem comes from the fact that whenever one moves a coupon of the Weyl element (denoted by  $D$  in [KM] and by  $w_i$  in [T]) over a maximum or a minimum on a strand labeled by an even dimensional representation, the sign of the morphism assigned to the diagram changes. In doing computations with diagrams, this produces an obstruction for some of the Moore-Seiberg equations. The problem is also related to an asymmetry of the skein relation of the Jones polynomial which will be explained in [G]. The case where one restricts to working only with odd-dimensional irreducible representations has been done in [FK].

The sign problem shows that the decompositions into disks, annuli and pairs of pants are not fine enough to make the modular functor be well defined. In the present paper we solve the sign problem simply by adding some extra structure, namely by introducing a family of simple closed curves indexed by the elements of the Klein group on the boundary of the 3-manifold. This approach is similar to that of adding a Lagrangian space ([Wa], [T]) in order to solve the projective ambiguity of the invariants, and fits in the formalism of Chap. III in [T]. We deduce the Moore-Seiberg equations corresponding to our situation and adapt the techniques from [FK] to obtain an  $sl(2, \mathbf{C})$ -topological quantum field theory. The invariants we obtain for closed manifolds are the Reshetikhin-Turaev invariants multiplied by  $X^{-1}$ , where the constant  $X$  is defined in Section 4.

In the case where one wants to avoid the use of Weyl elements, N. Reshetikhin suggested us an approach by using a  $\mathbf{Z}_2$  structure on the boundary of the 3-manifold, similar to our Klein group structure. This is obtained by orienting (or rather coorienting) the circles that decompose the surface into elementary surfaces, which is a natural approach if one notes that the oriented graph that is the core of the surface is the diagram of the associated vector space. In this way the Moore-Seiberg relations that don't work are replaced by their double covers, which clearly hold.

The introduction of Weyl elements makes computations easier and gluings more flexible. It also has the advantage that it attaches the same vector space to homeomorphic surfaces, regardless of the structure, and the same is true about the morphisms.

Regarding the formalism of diagrams, let us mention the following. First, at the level of pairs

of pants, there are two nontrivial relations that have to be satisfied by the modular functor. The first one is the third Reidemeister move. The second one is the one that shows that the cube of the rotation is the identity, and its proof is usually omitted in the literature. We give a short proof of it. The tetrahedron of the 6j-symbols has been altered by means of rotations and a sign change for aesthetic reasons. Also, compared to [FK], our diagrams are defined in such a way that, when doing computations, all tensor contractions are performed at the top, while all twistings and braidings occur at the bottom. This is very well illustrated in the proof we give of the pentagon identity.

The author wants to thank Ch. Frohman for the fruitful discussions.

## 1. COMPLETELY EXTENDED SURFACES

In this section we introduce the Klein group structure that will make the modular functor be well defined. Let  $\Sigma$  be a compact, orientable piecewise linear surface (with boundary).

Definition: A DAP-decomposition of  $\Sigma$  consists of

- a collection  $\alpha$  of disjoint circles in the interior of  $\Sigma$  that cut  $\Sigma$  into a collection of disks, annuli and pairs of pants.
- an ordering of the components of  $\Sigma$  cut along  $\alpha$ .
- if  $\Sigma_0$  is one of these components then the boundary components of  $\Sigma_0$  should be numbered by 1, 2 and 3 if  $\Sigma_0$  is a pair of pants, 1 and 2 if  $\Sigma_0$  is an annulus and 1 if  $\Sigma_0$  is a disk. Each boundary component  $C$  of  $\Sigma_0$  should have a fixed parametrization  $f : S^1 \rightarrow C$ . Fix three disjoint embedded arcs joining  $e^{i\epsilon}$  on the  $j$ -th boundary component to  $e^{-i\epsilon}$  on the  $(j+1)$ -st boundary component (taken modulo the number of components of  $\Sigma_0$ ), where  $0 < \epsilon < \pi$  is fixed. These arcs will be called seams.
- if  $\Sigma_0$  and  $\Sigma_1$  are two of the components of  $\Sigma$  cut along  $\alpha$  and  $C$  is a circle in  $\Sigma_0 \cap \Sigma_1$  then the parametrization of  $C$  in  $\Sigma_0$  should coincide with the complex conjugate of the parametrization of  $C$  in  $\Sigma_1$ .

An example of a DAP-decomposition is given in Fig.1. Two DAP-decompositions that coincide up to isotopy will be considered identical.

Let  $K = \{e, a, b, c\}$  be the Klein four group. Let us recall that the elements of  $K$  satisfy  $a^2 = b^2 = c^2 = e$ ,  $ab = c$ ,  $bc = a$ ,  $ac = b$ .

Definition: A completely extended surface is a triple  $(\Sigma, D, B)$  where

- $\Sigma$  is a compact, oriented, piecewise linear surface,

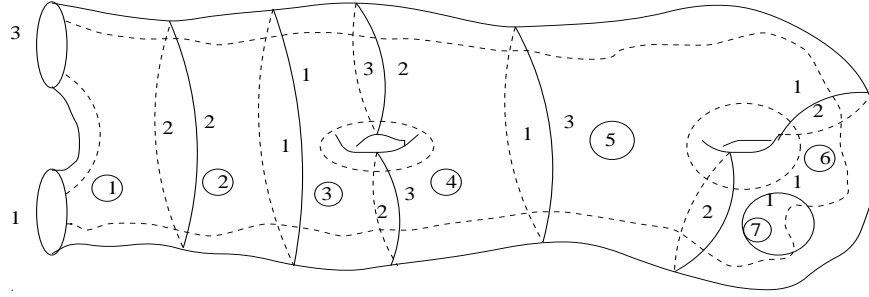

Fig. 1.1.

-  $D$  is a DAP-decomposition,

-  $B$  is a collection of bands (circles) such that for each elementary surface  $\Sigma_0$  in the DAP-decomposition of  $\Sigma$  there is one band parallel to each of the boundary components of  $\Sigma_0$ . The bands are indexed by  $e, a, b$ , or  $c$  according to the following rules:

i) if the two numbers that correspond to the numbering of a decomposition circle in two neighboring elementary surfaces are both 1, or none of them is 1, then the product of the indices of the two bands parallel to that component should have the product equal to  $a$  or  $b$ ;

ii) in the other cases the product of those indices should be  $e$  or  $c$ .

The reason why we have introduced the bands instead of simply indexing the decomposition circles is that we want to make gluings with corners more flexible. An example, with the seams omitted is given in Fig 1.2.

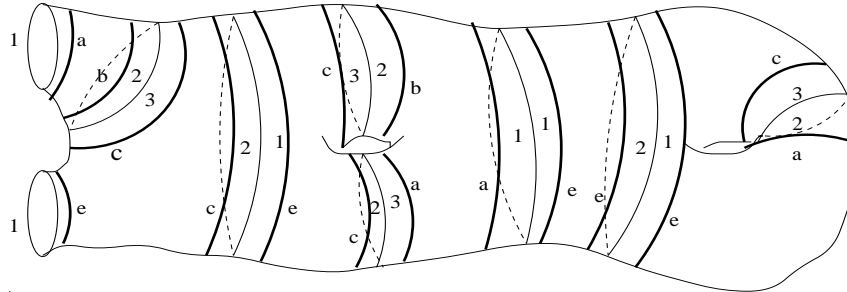

Fig. 1.2.

In the picture above the seams have been omitted. We will do this whenever it will seem unlikely to cause confusion.

For simplicity we will make the notations described in Fig 1.3.

We will factor the set of completely extended surfaces (shortly ce-surfaces) by the following two identifications:

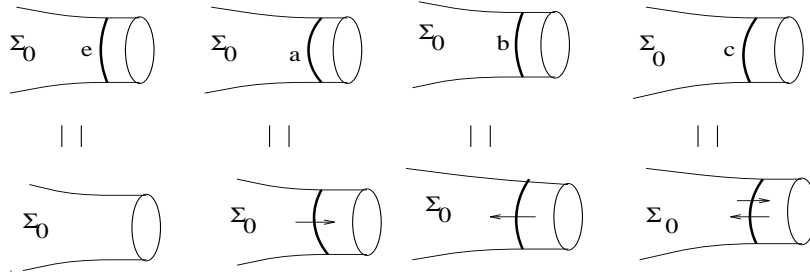

Fig. 1.3.

1. Is described in Fig 1.4, where  $\bar{u} = u$  if  $u = e$  or  $c$  and  $\bar{u} = cu$  if  $u = a$  or  $b$ .



Fig. 1.4.

2. If  $(\Sigma', D', B') \subset (\Sigma, D, B)$  is a subsurface, let us consider the ce-surface obtained from  $(\Sigma, D, B)$  by multiplying all bands along the boundary components of  $\Sigma'$  by  $c$ . Identify the newly obtained ce-surface with  $(\Sigma, D, B)$ .

These identifications can be easily understood in the “arrow” notation. The first one means that we are allowed to slide bands over a decomposition circle, like in Fig. 1.5, while the second means that we are allowed to reverse one arrow on each band along the boundary of a subsurface of  $\Sigma$ .



Fig. 1.5.

For example, the surface in Fig. 1.6 is obtained from Fig. 1.2 by using the first kind of identification. This is further equal to the one from Fig. 1.7 by performing the second kind of identification on the dotted surface.

Remark We do not allow bands to slide from one end of an annulus to the other.

At this point the construction looks very artificial. It will become very natural when we define the functor, the band structure will mimic the behavior of the coupons labeled by  $D$ , the arrows

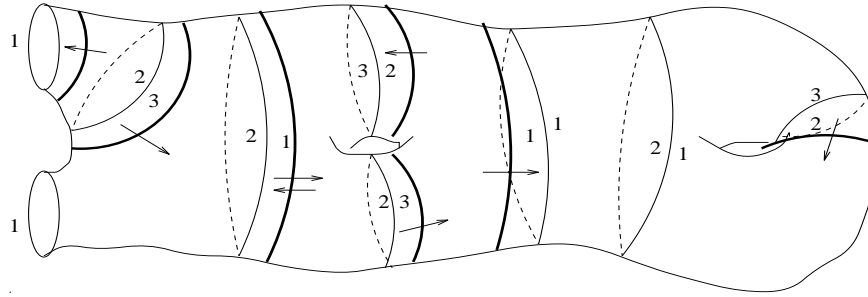

Fig. 1.6.

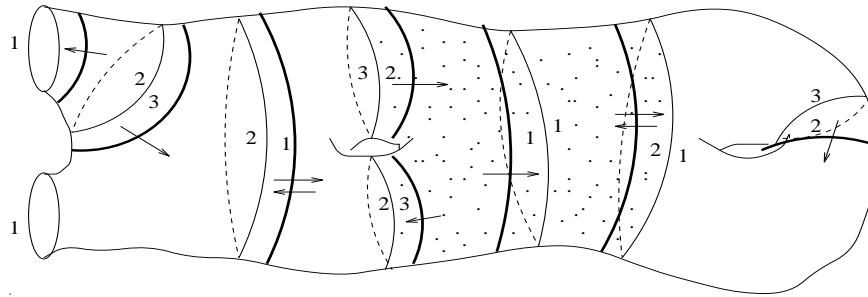

Fig 1.7.

above will reflect the direction of the arrows on a strand over a maximum or a minimum.

From now on the structure on a surface that makes it into a ce-surface will be called a DB-structure. We have come to the point where we introduce a set of elementary moves that transform one DB-structure into another. At the level of the modular functor, they will correspond to changes of basis in the associated vector space. These moves are  $K$ , which is the multiplication by  $c$  on one band (see Fig 1.8),  $T_1$ , which is the twist given in Fig. 1.9, where the band structure is left invariant,  $B_{23}$  described in Fig. 1.10, leaving also the band structure invariant, the rotation  $R$  consisting of the permutation of the numbers 1, 2 and 3, multiplication by  $a$  on the top boundary component, and by  $b$  on the bottom right boundary component (see Fig 1.11.) The moves  $F$ ,  $S$ ,  $A$  and  $D$  are described in the figures next four figures.

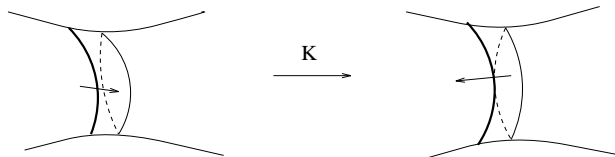

Fig. 1.8.

A composition of the elementary moves described above will be called a move.

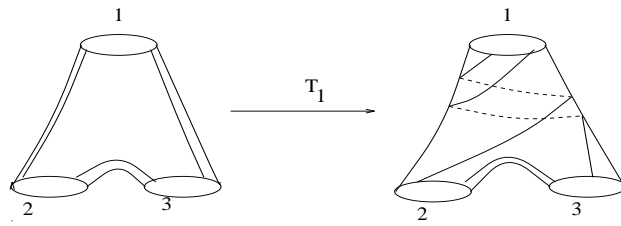

Fig. 1.9.

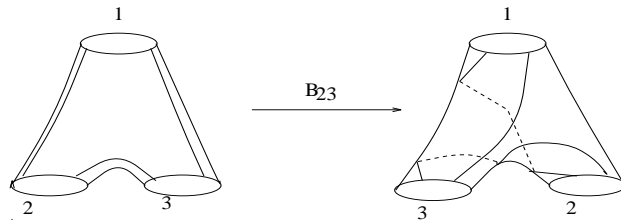

Fig. 1.10.

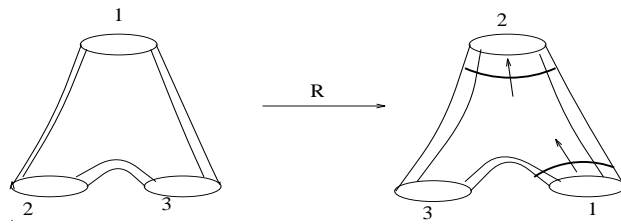

Fig. 1.11.

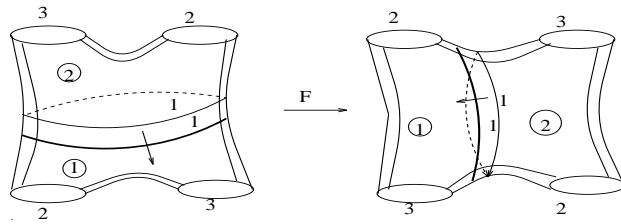

Fig. 1.12.

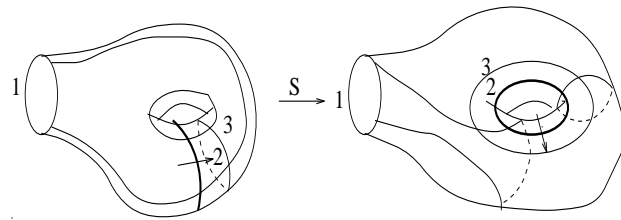

Fig. 1.13.

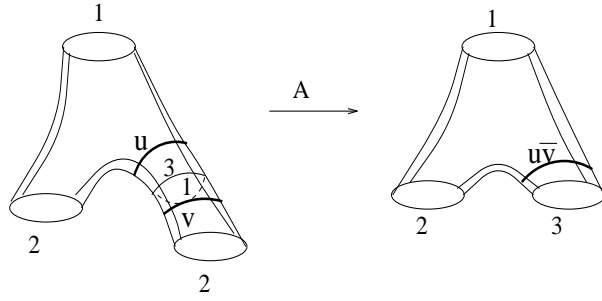

Fig. 1.14.

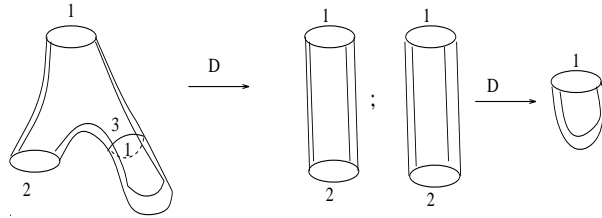

Fig. 1.15.

Notes 1. The moves  $F$  and  $S$  can only be applied when the arrows point in the prescribed direction. As a matter of fact we have no elementary move for the  $S$ -move on the torus, however this can be obtained as a composition of moves as seen in Fig. 1.16.

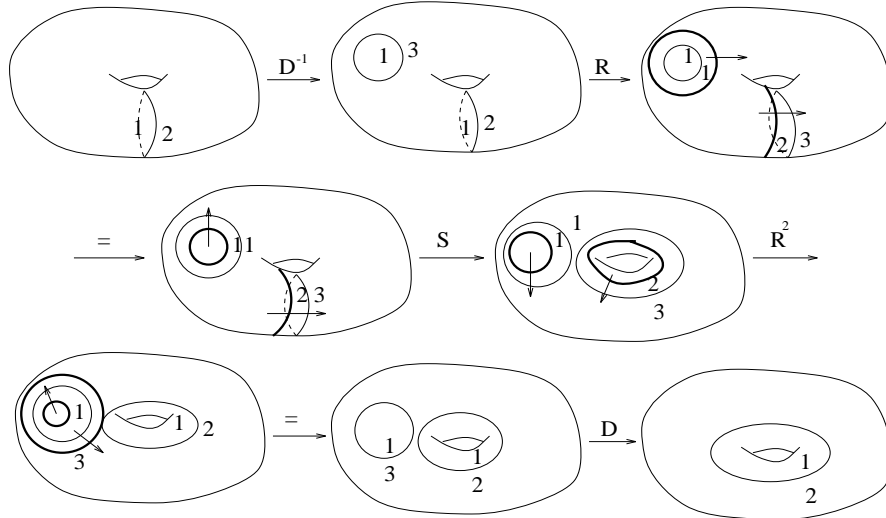

Fig. 1.16.

2. One should not confuse the moves  $T_1, B_{23}, R$  and  $S$  with the corresponding maps between surfaces. Here they only change the DB-structure, their underlying homeomorphism is the identity.

3. We factor everything by the move described in Fig 1.17, so we make the identification from



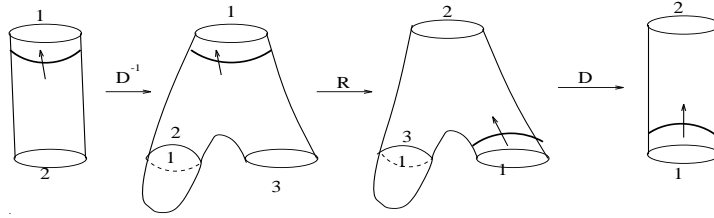

Fig. 1.17.

Fig. 1.18, giving the rule of sliding a band in an annulus.

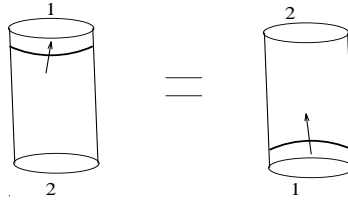

Fig. 1.18.

Let us remark that the image of a DB-structure through any of the elementary moves described above is again a DB-structure, satisfying the conditions from the definition.

Let  $C$  be a boundary component of  $\Sigma$ . We say that  $C$  is of positive type (+) if it is numbered by a 1 and its associated band is indexed by an  $e$  or a  $c$ , or if it is numbered by 2 or 3 and its associated band is indexed by an  $a$  or a  $b$ . In the other cases we say that  $C$  is of negative type (-).

**Definition:** (Gluing ce-surfaces) Let  $(\Sigma, D, B)$  be a completely extended surface. Let  $C_1$  and  $C_2$  be two boundary components of  $\Sigma$  of opposite type and  $f : C_1 \rightarrow C_2$  be the homeomorphism induced by the complex conjugation on  $S^1$ . Define  $(\Sigma_f, D_f, B_f)$  to be the ce-surface with  $\Sigma_f$  the gluing of  $\Sigma$  by  $f$ ,  $D_f$  and  $B_f$  being the DAP-decompositions, respectively band structures induced by  $D$  and  $B$ .

For example the surfaces from Fig. 1.19 can be glued together but the ones from Fig. 1.20 cannot.

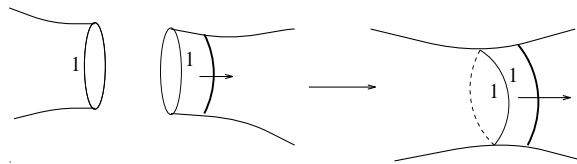

Fig. 1.19.

**Remark** The condition that  $C_1$  and  $C_2$  are of opposite types guarantees that the newly obtained

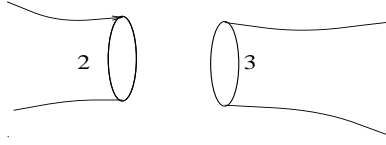

Fig. 1.20.

surface satisfies the conditions from the definition.

Definition: A ce-morphism is a map between two ce-surfaces

$$(f, n) : (\Sigma_1, D_1, B_1) \rightarrow (\Sigma_2, D_2, B_2)$$

where  $f$  is a homeomorphism satisfying the property that for any boundary component  $C$  of  $\Sigma_1$ ,  $C$  and  $f(C)$  are of the same type, and  $n$  is an integer.

Remarks 1. The moves  $K, T_1, B_{23}, R, F, S, A$  and  $D$  will be considered as ce-morphisms with the underlying homeomorphism equal to the identity, and paired with the integer  $n = 0$ .

2. The definition above shows that there is no morphism between the two surfaces in Fig. 1.21.

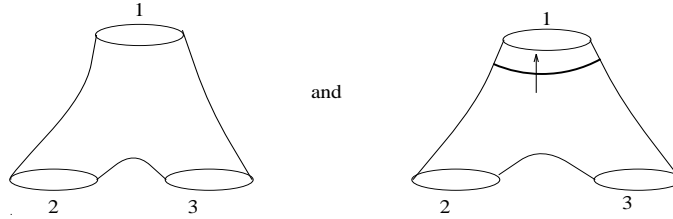

Fig. 1.21.

It follows that the mapping class groupoid of the ce-surfaces having the same underlying surface is not always connected, in fact it has exactly as many components as the number of the boundary components of the surface. However, this produces no restrictions on the gluings along surfaces with boundary, since by an operation of type  $A$  we can always adjust the surface such that the gluing can be done. The groupoid is connected if the surface has no boundary.

Proposition 1.1. If  $(f, n) : (\Sigma_1, D_1, B_1) \rightarrow (\Sigma_2, D_2, B_2)$  is a ce-morphism then there exists a move between  $(\Sigma_2, f(D_1), f(B_1))$  and  $(\Sigma_2, D_2, B_2)$ . In particular  $(id, 0) : (\Sigma, D_1, B_1) \rightarrow (\Sigma, D_2, B_2)$  is just a move.

Proof: Since any two DAP-decompositions can be transformed one into the other by a move, we may assume that  $f(D_1) = D_2$ . From the definition of a ce-surface, the indices of the bands

of  $f(B_1)$  that lie in the interior of  $\Sigma_2$  agree with those of  $B_2$  modulo multiplication by  $c$ , so they can be made to agree by performing some moves of type  $K$ . From the definition of ce-morphisms it follows that the same is true for the bands along the boundary components, and the conclusion follows.  $\square$

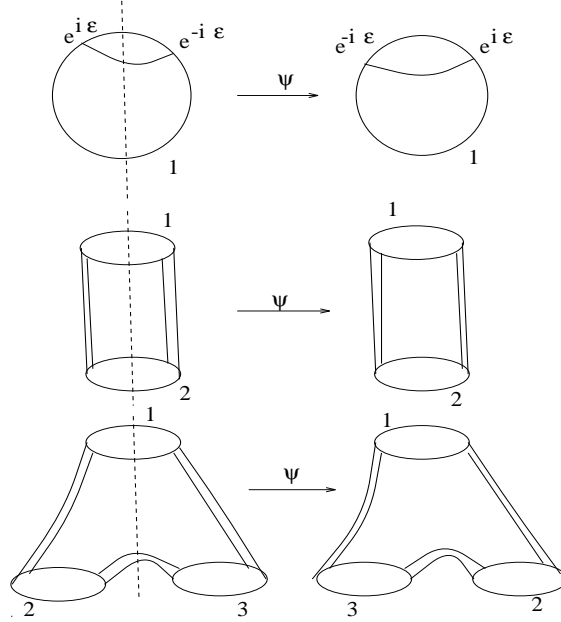

Fig. 1.22.

**Definition:** (Composition of ce-morphisms) If  $(f_1, n_1) : (\Sigma_1, D_1, B_1) \rightarrow (\Sigma_2, D_2, B_2)$  and  $(f_2, n_2) : (\Sigma_2, D_2, B_2) \rightarrow (\Sigma_3, D_3, B_3)$  are two ce-morphisms we define

$$(f_2, n_2)(f_1, n_1) := (f_2 f_1, n_2 + n_1 - \sigma((f_2 f_1)_* L_1, (f_2)_* L_2, L_3))$$

where  $L_i$  is the subspace of  $H_1(\Sigma_i)$  generated by  $D_i$  (including the curves on the boundary),  $i = 1, 2, 3$  and  $\sigma$  is Wall's non-additivity function ([W]).

The negative sign in front of the  $\sigma$  function appears because the cocycle that gives the extension comes from the signature of a 4-manifold, hence is the negative of Wall's  $\sigma$  function.

**Definition:** The dual of a ce-surface  $(\Sigma, D, B)$  is defined to be  $-(\Sigma, D, B) := (-\Sigma, -D, -B)$  where  $-\Sigma := \Sigma$  with opposite orientation,  $-D$  is obtained from  $D$  by applying the orientation reversing moves described in Fig. 1.22 to each of the disks, annuli or pairs of pants from the decomposition of  $\Sigma$  and  $-B$  is defined as follows:

- i) inside  $\Sigma$  the band structure remains unchanged;

ii) we multiply by  $a$  the index of all bands along boundary components of positive type, and by  $b$  the index for boundary components of negative type.

An example is given in Fig. 1.23.

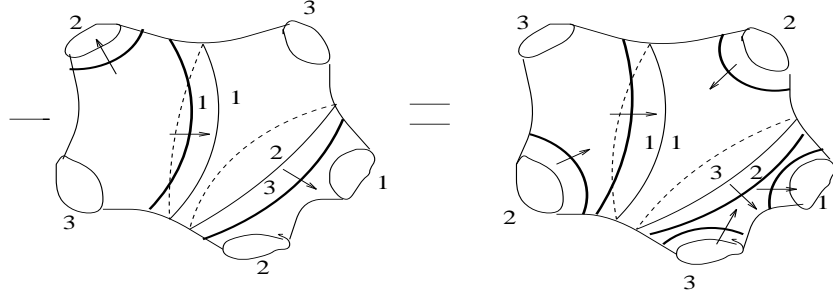

Fig. 1.23.

Proposition 1.2. The operation of taking the dual is natural with respect to morphisms and gluings, and is reflexive.

Proof: Naturality is straightforward. Reflexivity follows from the fact that we identify a ce-surface with the ce-surface obtained by multiplying the indices of all bands along boundary components by  $c$ .

## 2. COMPLETELY EXTENDED 3-MANIFOLDS

In this section we introduce the manifolds whose boundaries are ce-surfaces.

Definition: We say that  $(M, D, B, n)$  is a completely extended 3-manifold (shortly ce-3-manifold) if  $M$  is a compact, oriented, piecewise linear 3-manifold,  $D$  is a DAP-decomposition of the boundary of  $M$ ,  $B$  is a collection of bands indexed by the elements of the Klein group on the boundary of  $M$  such that  $D$  and  $B$  determine a DB-structure on the boundary, and  $n$  is an integer (usually called framing).

Definition: (of the boundary)  $\partial(M, D, B, n) = (\partial M, D, B)$ .

Definition: (disjoint union)  $(M_1, D_1, B_1, n_1) \sqcup (M_2, D_2, B_2, n_2) = (M_1 \sqcup M_2, D_1 \sqcup D_2, B_1 \sqcup B_2, n_1 + n_2)$ .

Definition: (the mapping cylinder) If  $(f, n) : (\Sigma_1, D_1, B_1) \rightarrow (\Sigma_2, D_2, B_2)$  is a ce-morphism, we define the mapping cylinder of  $(f, n)$  to be  $I_{(f,n)} := (M, D, B, n)$  where  $M = I_f$  the mapping

cylinder of  $f$  and  $(\partial M, D, B) = -(\Sigma_1, D_1, B_1) \cup (\Sigma_2, D_2, B_2)$ , where the two surfaces are glued together along the boundary components that are mapped one into the other by  $f$ .

Here we consider the definition of the mapping cylinder in which the boundary of the first surface is identified with the boundary of the second.

**Definition:** (gluing of ce-3-manifolds) Let  $(M, D, B, n)$  be a ce-3-manifold. Let  $(\Sigma_i, D_i, B_i) \subset \partial(M, D, B, n)$ ,  $i = 1, 2$  be two disjoint ce-surfaces. Let  $(f, m) : (\Sigma_1, D_1, B_1) \rightarrow -(\Sigma_2, D_2, B_2)$  be a ce-morphism. Define the gluing of  $(M, D, B, n)$  by  $(f, m)$  to be

$$(M, D, B, n)_{(f,m)} := (M_f, D', B', m + n - \sigma(K, L_1 \oplus L_2, \Delta^-))$$

where

- $M_f$  is the (piecewise linear) gluing of  $M$  by  $f$ ,
- $D'$  is the image of  $D$  under the quotient map  $(\partial M \setminus \text{Int}(\Sigma_1 \cup \Sigma_2)) \rightarrow \partial M_f$ ,
- $B'$  is obtained from  $B$  by only keeping the bands that are contained in the complement of the two surfaces that we glued along,
- $\sigma$  is Wall's non-additivity function (see [W]),
- $K$  is the kernel of  $H_1(\Sigma_1 \cup \Sigma_2) \rightarrow H_1(M)/J$ , where  $J$  is the subspace of  $H_1(\partial M)$  spanned by the decomposition curves lying in the complement of  $\text{int}(\Sigma_1 \cup \Sigma_2)$ ,
- $L_i$  are the subspaces of  $H_1(\Sigma_i)$  generated by  $D_i$ ,  $i = 1, 2$ ,
- $\Delta^- := \{(x, -f_*(x)) \mid x \in H_1(\Sigma_1)\}$ .

For a better understanding let us briefly review the explanation from [Wa] concerning this choice of the framing.

Let  $L$  be the subspace of  $H_1(\partial M)$  generated by  $D$ . Let  $M^+$  be a 3-manifold such that  $\partial M^+ = -\Sigma$  and  $\text{Ker}(H_1(\partial M) \rightarrow H_1(M^+)) = L$ . Let  $W$  be a 4-manifold bounded by  $M \cup M^+$  (glued along  $\partial M$ ) whose signature is  $n$ .

Now let us cap  $\Sigma_1$  and  $\Sigma_2$  with disks along the boundary components, disks lying entirely in  $M^+$ , and obtain two surfaces  $\hat{\Sigma}_1$  and  $\hat{\Sigma}_2$  in  $M^+$ . One can assume that these two surfaces bound two disjoint manifolds in  $M^+$ , say  $N_1$  and  $N_2$  (see Fig. 2.1.)

If we consider  $W'$  the 4-manifold bounded by  $N_1 \cup I_f \cup N_2$ , with signature  $m$ , where  $I_f$  is the mapping cylinder of  $f$  extended to the disks that we capped with, then we see that the framing of  $(M, D, B, n)_{(f,m)}$  is the signature of the 4-manifold obtained by gluing  $W$  and  $W'$ .

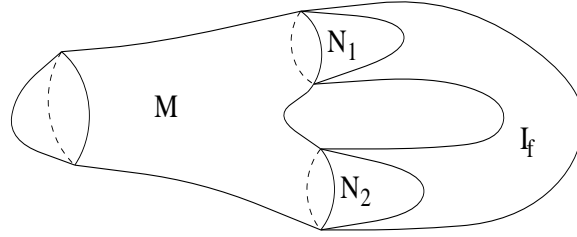

Fig. 2.1.

Remark Since the morphism  $(f, m)$  is defined from one surface to the dual of the other, we see that the boundary of the newly obtained ce-3-manifold satisfies the conditions from the definition of a ce-surface.

Proposition 2.1. The following properties hold:

- 1) the gluing operation is associative,
- 2)  $I_{(g,n)(f,m)} = I_{(g,n)} \cup_{(id,0)} I_{(f,m)}$ ,
- 3)  $(M, D, B, n)_{(f,m)} = (M, D, B, n) \cup_{(id,0)} I_{(f,m)}$ .

Proof: 1) The only thing one has to prove is that the value of the framing does not depend on the order in which we perform the gluings. However, this follows by interpreting the framing as the signature of a 4-manifold as it has been done above, since the gluing of manifolds is associative.

2) and 3) also follow from a similar argument.  $\square$

### 3. THE AXIOMS OF A TOPOLOGICAL QUANTUM FIELD THEORY FOR CE-SURFACES AND 3-MANIFOLDS

In this section we are going to describe the axioms that a topological quantum field theory with corners for ce-surfaces and 3-manifolds should satisfy. They are identical with those introduced by Walker [Wa] for extended manifolds.

A label set is a finite set  $\mathcal{L}$  equipped with an involution  $x \rightarrow \hat{x}$  and a distinguished element  $1 \in \mathcal{L}$ , with  $\hat{1} = 1$ . Define the category of labeled completely extended surfaces (lce-surfaces), whose objects are ce-surfaces with a label attached to each boundary component, and whose morphisms are ce-morphisms which preserve the labeling. From now on we will denote ce-surfaces and ce-3-manifolds by a single letter, usually  $\sigma$  for surfaces and  $\mu$  for 3-manifolds. Thus a lce-surface is a

pair  $(\sigma, l)$  where  $\sigma$  is a ce-surface and  $l$  is a function from the set of boundary components of  $\sigma$  to  $\mathcal{L}$ .

Definition: A topological quantum field theory of label set  $\mathcal{L}$  consists of

i) a functor  $V$  from the category of lce-surfaces to the category of finite dimensional vector spaces and morphisms;

ii) an assignment  $\mu \rightarrow Z(\mu) \in V(\partial\mu)$  for each ce-3-manifold  $\mu$ ;

satisfying the axioms below:

(3.1.) Disjoint union axiom

$$V(\sigma_1 \sqcup \sigma_2, l_1 \sqcup l_2) = V(\sigma_1, l_1) \otimes V(\sigma_2, l_2).$$

(3.2.) Gluing axiom for  $V$

Let  $\sigma$  be a ce-surface,  $C$  and  $C'$  two sets of boundary components of  $\sigma$ ,  $g : C \rightarrow C'$  the parametrization reflecting map. Let  $\sigma_g$  be  $\sigma$  glued by  $g$ . Then

$$V(\sigma_g, l) = \bigoplus_{x \in \mathcal{L}(C)} V(\sigma, (l, x, \hat{x}))$$

where the sum is over all labelings of  $C$ .

(3.3.) Duality axiom

$$V(\sigma, l) = V(-\sigma, \hat{l})^*$$

satisfying the following compatibility conditions

-the identifications

$$V(\sigma, l) = V(-\sigma, \hat{l})^*$$

$$V(-\sigma, \hat{l}) = V(\sigma, l)^*$$

are mutually adjoint;

-if  $\phi = (f, n) : (\sigma_1, l_1) \rightarrow (\sigma_2, l_2)$ , let  $\bar{\phi} = (f, -n) : (-\sigma_1, \hat{l}_1) \rightarrow (-\sigma_2, \hat{l}_2)$ . Then for any  $x \in V(\sigma_1, l_1)$  and  $y \in V(-\sigma_1, \hat{l}_1)$  we have

$$\langle x, y \rangle = \langle V(\phi)x, V(\bar{\phi})y \rangle$$

where  $\langle, \rangle$  is the pairing between the space and its dual. This condition says that  $V(\phi)$  is the adjoint inverse of  $V(\bar{\phi})$ ;

-if  $\alpha_1 \otimes \alpha_2 \in V(\sigma_1 \sqcup \sigma_2) = V(\sigma_1) \otimes V(\sigma_2)$

$$\beta_1 \otimes \beta_2 \in V(-\sigma_1 \sqcup -\sigma_2) = V(-\sigma_1) \otimes V(-\sigma_2)$$

then

$$\langle \alpha_1 \otimes \alpha_2, \beta_1 \otimes \beta_2 \rangle = \langle \alpha_1, \beta_1 \rangle \langle \alpha_2, \beta_2 \rangle;$$

-there is a function  $S : \mathcal{L} \rightarrow \mathbf{C}^*$  such that if

$$\bigoplus_{x \in \mathcal{L}(C)} \alpha_x \in V(\sigma_g, l) = \bigoplus_{x \in \mathcal{L}(C)} V(\sigma, (l, x, \hat{x}))$$

$$\bigoplus_{x \in \mathcal{L}(C)} \beta_x \in V(-\sigma_g, \hat{l}) = \bigoplus_{x \in \mathcal{L}(C)} V(-\sigma, (\hat{l}, \hat{x}, x))$$

then

$$\langle \bigoplus_x \alpha_x, \bigoplus_x \beta_x \rangle = \sum_x S(x) \langle \alpha_x, \beta_x \rangle$$

where  $C \subset \partial\sigma$  consists out of  $n$  circles,  $x = (x_1, x_2, \dots, x_n)$  and  $S(x) = S(x_1)S(x_2) \cdots S(x_n)$ .

(3.4.) Empty surface axiom

$$V(\emptyset) \cong \mathbf{C}.$$

(3.5.) Disk axiom

If  $D$  is a ce-disk we have  $V(D, m) = \mathbf{C}$  if  $m = 1$  and 0 otherwise.

(3.6.) Annulus axiom

If  $A$  is a ce-annulus we have  $V(A, (m, n)) = \mathbf{C}$  if  $m = \hat{n}$  and 0 otherwise.

(3.7.) Disjoint union axiom for  $Z$

$$Z(\mu_1 \sqcup \mu_2) = Z(\mu_1) \otimes Z(\mu_2).$$

(3.8.) Naturality axiom

Let  $(f, m) : (M_1, D_1, B_1, n_1) \rightarrow (M_2, D_2, B_2, n_2)$  be a morphism, and suppose that  $n_2 = n_1 + m + \sigma(K, L_1, L_2)$ , where  $K = \ker(H_1(\partial M_2) \rightarrow H_1(M_2))$ , and  $L_1$  and  $L_2$  are the (Lagrangian) subspaces of  $H_1(\partial M_2)$  generated by  $f(D_1)$  and  $D_2$ . Then

$$V(f|\partial(M_1, D_1, B_1, n), m)Z(M_1, D_1, B_1, n_1) = Z(M_2, D_2, B_2, n_2).$$

(3.9.) Gluing axiom for  $Z$

Let  $\mu$  be a ce-3-manifold,  $\sigma_1, \sigma_2 \subset \partial\mu$  two disjoint ce-surfaces, and suppose that there exists a ce-morphism  $\phi : \sigma_1 \rightarrow -\sigma_2$ . Then one can define  $\mu_\phi$ , the gluing of  $\mu$  by  $\phi$ . We have

$$V(\partial\mu) = \bigoplus_{l_1, l_2} V(\sigma_1, l_1) \otimes V(\sigma_2, l_2) \otimes V(\partial\mu \setminus (\sigma_1 \cup \sigma_2), (\hat{l}_1, \hat{l}_2))$$



where  $l_i$  runs through all labelings of  $\sigma_i$ . Also

$$Z(\mu) = \bigoplus_{l_1, l_2} \sum_j \alpha_{l_1}^j \otimes \beta_{l_2}^j \otimes \gamma_{l_1 l_2}^j.$$

The axiom states that

$$Z(\mu_\phi) = \bigoplus_l \sum_j \langle V(\phi) \alpha_l^j, \beta_l^j \rangle \gamma_{ll}^j$$

where  $l$  runs through all labelings of  $\sigma_1$ .

(3.10.) Mapping cylinder axiom

For  $(id, 0) : \sigma \rightarrow \sigma$  we have

$$V(\partial I_{(id,0)}) = \bigoplus_l V(\sigma, l) \otimes V(\sigma, l)^*.$$

If  $id_l$  is the identity matrix in  $V(\sigma, l) \otimes V(\sigma, l)^*$  then

$$Z(I_{(id,0)}) = \bigoplus_{l \in \mathcal{L}(\sigma)} id_l$$

**Remark** As a consequence of the gluing axiom, the mapping cylinder axiom has the following stronger form. Let  $\phi : \sigma_1 \rightarrow \sigma_2$  be a ce-morphism. Then  $Z(I_\phi) = \bigoplus_{l \in \mathcal{L}(\sigma_1)} V(\phi_l)$  where  $\phi_l : (\sigma_1, l) \rightarrow (\sigma_2, l)$  are the corresponding lce-morphisms.

#### 4. THE CONSTRUCTION OF THE BASIC DATA

A basic data for a topological quantum field theory with label set  $\mathcal{L}$  consists of:

- an assignation of vector spaces to labeled, completely extended disks, annuli and pairs of pants;

- a choice of basis elements in these vector spaces;

- a definition of the morphisms of the vector spaces of lce-disks, annuli and pairs of pants induced by the operation of taking the dual, which identifies each vector space with its dual. This identification should come together with a pairing between the space and its dual;

- a description of the operators that correspond to the moves  $K_i, T_i, R, B_{23}, F, S, P, A, D, C = (id, 1)$  and  $\psi$ ;

- a function  $S : \mathcal{L} \rightarrow \mathbf{C}^*$  (needed in axiom (3.3)).

Using the 10 axioms from the previous section we see that the basic data uniquely defines  $V$  and  $Z$ , provided that some compatibility conditions are satisfied.

We will construct a basic data by means of quantum deformations of the universal enveloping algebra of  $sl(2, \mathbf{C})$ . Let us remind some basic facts about the algebra  $\mathcal{A}_r$  introduced by Reshetikhin and Turaev in [RT] (see also [KM]). Note that this algebra is denoted by  $U_t$  in [RT], our notation is the one from [KM].

Let  $r$  be an integer,  $s = e^{\pi i/r}$  and  $t = e^{\pi i/2r}$ . For an integer  $n$  one defines

$$[n] = \frac{s^n - \bar{s}^n}{s - \bar{s}} = \frac{\sin \frac{\pi n}{r}}{\sin \frac{\pi}{r}}$$

$$[n]! = [1][2] \cdots [n], \quad [0]! = 1,$$

$$\begin{bmatrix} n \\ k \end{bmatrix} = \frac{[n]!}{[k]![n-k]!}, \quad X = \sqrt{\sum_{k=1}^{r-1} [k]^2} = \frac{\sqrt{\frac{r}{2}}}{\sin \frac{\pi}{r}}$$

The number  $X$  is denoted by  $\mathcal{D}$  in [T] and is  $1/b$  in [KM] (one should not confuse this  $X$  with the operator  $X$  defined below).

$\mathcal{A}_r$  is the associative algebra over  $\mathbf{C}$ , with unit, generated by  $X, Y, K$  and  $\bar{K}$  satisfying the following relations:

$$K\bar{K} = \bar{K}K = 1, \quad K^{4r} = 1, \quad X^r = Y^r = 0, \quad KX = sXK, \quad KY = \bar{s}YK, \quad XY - YX = (K^2 - \bar{K}^2)/(s - \bar{s}).$$

Let us recall that  $\mathcal{A}_r$  can be given a Hopf algebra structure (see [RT] or [KM]).

Let  $k$  be an integer  $1 \leq m < r$ , and let  $m = (k-1)/2$ . Let  $\underline{k}$  be the vector space of dimension  $k$ , spanned by the vectors  $\{e_j\}$  where  $j$  runs from  $-m$  to  $m$  with step 1. Consider the action of  $\mathcal{A}_r$  on  $\underline{k}$  defined by

$$\begin{aligned} Xe_j &= [m+j+1]e_{j+1}, \quad j < m, \quad Xe_m = 0, \\ Ye_j &= [m-j+1]e_{j-1}, \quad j > -m, \quad Ye_{-m} = 0, \\ Ke_j &= t^{2j}e_j. \end{aligned}$$

By [RT],  $\underline{k}$  is an irreducible representation of  $\mathcal{A}_r$ .

Let us also recall the definitions of two operators that we need for our construction. The first one is the Weyl element that provides an  $\mathcal{A}_r$ -isomorphism between  $\underline{k}$  and  $\underline{k}^*$ , where  $\underline{k}^*$  is the dual

representation of  $\underline{k}$ , and is given by

$$D(e^j) = \begin{bmatrix} 2m \\ m-j \end{bmatrix} (it)^{2j} e_{-j}$$

where  $\{e^j\}$  is the basis dual to  $\{e_j\}$ . One should note that  $D^*D^{-1} = (-1)^{k-1}K^2$  (see [KM]). The  $(-1)^{k-1}$  that appears in this formula is responsible for the obstruction of constructing the topological quantum field theory, and made the introduction of the bands on the surface necessary.

The second operator is  $\check{R} : \underline{k} \otimes \underline{k}' \rightarrow \underline{k}' \otimes \underline{k}$  given by

$$\check{R}(e_i \otimes e_j) = \sum_{n \geq 0, j+n \leq m, j-n \geq -m'} \frac{(s-\bar{s})^n}{[n]!} \frac{[m+i+n]!}{[m+i]!} \frac{[m'-j+n]!}{[m'-j]!} t^{4ij-2n(i-j)-n(n+1)} e_{j-n} \otimes e_{i+n}.$$

where  $m = (k-1)/2$  and  $m' = (k'-1)/2$

Following [FK] we define a non-degenerate sesquilinear form  $(\ , \ ) : \underline{k} \otimes \underline{k} \rightarrow \mathbf{C}$ . If  $v \in \underline{k}$ ,  $v = \sum a_j e_j$  define  $\bar{v} = \sum \bar{a}_j e_j$ . Then

$$(w, v) = i^{k-1} D^{-1}(w)(\bar{v}).$$

Extend  $(\ , \ )$  to tensor products by

$$(w_1 \otimes w_2, v_1 \otimes v_2) = (w_1, v_1)(w_2, v_2)$$

For  $\alpha$  a map between tensor products of representations, let us denote by  $\alpha^*$  its adjoint with respect to this pairing. If  $\alpha^* \alpha = 1$  we call  $\alpha$  an isometry; an invertible isometry is called unitary. As an example  $\check{R}$  is unitary [FK].

**Definition** [Wa]: A representation  $V$  of  $\mathcal{A}_r$  is *bad* if for any  $\mathcal{A}_r$ -linear map  $\alpha : V \rightarrow V$  the trace of  $K^2 \alpha$  is zero.

By Theorem 8.4.3 in [RT], if  $\underline{m}$  and  $\underline{n}$  are as before

$$\underline{m} \otimes \underline{n} = \bigoplus_p \underline{p} \oplus B \tag{1}$$

where  $B$  is bad, and the sum is taken over all  $p$  with  $|m-n|+1 \leq p \leq \min\{m+n-1, 2r-2-m-n\}$ , and  $m+n+p$  odd, and the decomposition is unique.

As remarked in [Wa], if  $V$  is bad and  $W$  is any representation then  $W \otimes V$  is also bad. This enables us to restrict ourselves only to the part of the tensor product  $\underline{m} \otimes \underline{n}$  which is good, i.e. a

sum of irreducible representations, and from now on, whenever we write  $\underline{m} \otimes \underline{n}$  we will actually mean the good part. It is of no difficulty to check that the tensor product defined this way satisfies all the properties of the usual tensor product. The morphisms also behave nicely under taking the quotient over the bad part.

A class of spaces that will be of interest in the sequel are the spaces of  $\mathcal{A}_r$ -linear maps  $\alpha : \underline{m} \otimes \underline{n} \rightarrow \underline{p}$ , which will be denoted by  $V_p^{mn}$ , where  $\underline{m}, \underline{n}$  and  $\underline{p}$  are irreducible representations. By (1) and Schur's lemma, these spaces are either one or zero dimensional. As an example if  $k$  is an integer and  $m = (k-1)/2$  then  $V_1^{kk}$  is generated by the orthogonal projection  $\psi_k : \underline{k} \otimes \underline{k} \rightarrow \underline{1}$  given by

$$\psi(e_j \otimes e_h) = \delta_{j,-h} \frac{(-1)^{2m}}{\sqrt{[2m+1]}} \begin{bmatrix} 2m \\ m-j \end{bmatrix} (it)^{-2j} e_0$$

where  $\delta$  is the Kronecker symbol. In the future, the  $\mathcal{A}_r$ -linear orthogonal projections will be simply called projections, their adjoints will be called inclusions. This terminology is very natural if one considers relation (1).

Define the (normalized) trace pairing  $\langle \cdot, \cdot \rangle_t : V_p^{mn} \otimes V_p^{mn} \rightarrow \mathbf{C}$  by

$$\langle \alpha, \beta \rangle_t \cdot 1_p = \alpha \circ \beta^*$$

where  $1_p : \underline{p} \rightarrow \underline{p}$  is the identity. Schur's lemma implies that the trace pairing is well defined. In the case when we consider only odd-dimensional representations, it has been proved in [FK] that the trace pairing is positive definite. The proof can be adapted to show that the same is true in the case when we also allow even-dimensional representations. It follows that the trace pairing admits orthogonal projections, namely maps  $\alpha \in V_p^{mn}$  with  $\langle \alpha, \alpha \rangle_t = 1$ .

We assume that the reader is familiar with the formalism of diagrams described in [RT], [KM] and [T], when working with morphisms of  $\mathcal{A}_r$  representations. In addition, the empty coupons will stand for the morphism  $D$  or its inverse. For morphisms  $\alpha : \underline{m} \otimes \underline{n} \rightarrow \underline{p}$  (i.e.  $\alpha \in V_p^{mn}$ ) and  $\beta : \underline{p} \rightarrow \underline{m} \otimes \underline{n}$  we make the notation from Fig. 4.1.

The trace pairing is now described by the diagram in Fig. 4.2.

From now on we won't specify arrows any more, making the convention that they always point downwards at trivalent vertices.

Let us now start defining the basic data. The label set is  $\mathcal{L} = \{m \mid 1 \leq m < r\}$ , the involution on  $\mathcal{L}$  is the identity map, and the distinguished element is 1.

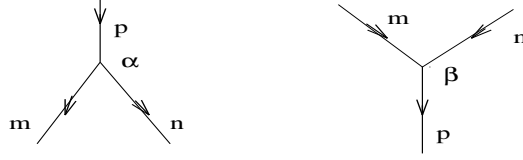

Fig. 4.1.

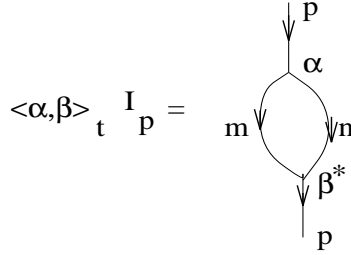

Fig 4.2.

If  $D$  is a ce-disk, define  $V(D, m) = V_m$  where  $V_m$  is the space of module homomorphisms  $\mathbf{C} \rightarrow \underline{m}$ . By Schur's lemma  $V_m = 0$  unless  $m = 1$ , and  $V_1 \cong \mathbf{C}$ . Let  $\beta_1 : \mathbf{C} \rightarrow \underline{1}$  be the isomorphism  $\lambda \rightarrow \lambda e_0$ .

If  $A$  is a ce-annulus,  $V(A, (m, n)) = V_n^m = \{\phi : \underline{m} \rightarrow \underline{n} \mid \phi \text{ module homomorphism}\}$ . Like before,  $V(A, (m, n)) \neq 0$  if and only if  $\underline{m} = \underline{n}$ . In the latter case  $V(A, (m, n)) \cong \mathbf{C}$ . Let  $\beta_m^m$  be the identity operator on  $\underline{m}$ .

If  $P$  is a ce-pair of pants define  $V(P, (p, m, n)) = V_p^{mn}$ . It follows that  $V(P, (p, m, n)) \neq 0$  if and only if  $|m - n| + 1 \leq p \leq \min\{m + n - 1, 2r - 2 - m - n\}$ , in which case the vector space is isomorphic to  $\mathbf{C}$ . An observation that is very useful in computations is the fact that  $V_p^{mn} \neq 0$  implies that  $m + n + p$  is an odd integer, and  $m - 1 + n - 1 + p - 1$  is even. Denote by  $\beta_p^{mn}$  one of the two projections in  $V_p^{mn}$ . One can choose these projections such that  $R\beta_p^{mn} = \beta_n^{pm}$  where  $R$  will be defined below. Choose also  $\beta_1^{mm} = \psi_m$ . Then  $\beta_m^{1m} = R\beta_1^{mm}$  has the property that  $\beta_m^{1m}(x \otimes e_0) = x$ , for any  $x \in \underline{m}$ .

The dual of  $V_p^{mn}$  can be identified with  $V_p^{nm}$ . Let  $\psi : V_p^{mn} \rightarrow V_p^{nm}$  be given by the diagram in Fig. 4.3.

The pairing  $\langle \cdot, \cdot \rangle : V_p^{mn} \otimes V_p^{nm} \rightarrow \mathbf{C}$  is described in Fig. 4.4.

**Remarks 1.**  $\langle \alpha, \beta \rangle = X^2 / (\sqrt{[m]}\sqrt{[n]}\sqrt{[p]}) \langle \alpha, \psi(\beta) \rangle_t$ .

2. The pairing that we have defined is not quite the canonical pairing between a space and its dual, it is rather the canonical pairing multiplied by a constant. We could have included that

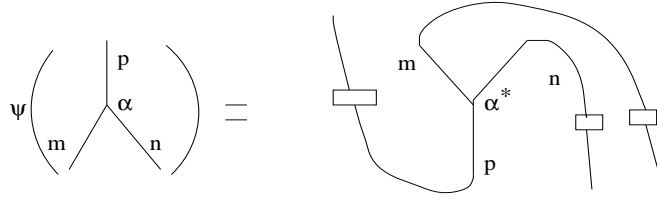

Fig. 4.3.

$$\langle \alpha, \beta \rangle = \frac{X^2}{([m][n][p]^3)^{1/2}}$$

Fig. 4.4.

constant in the definition of  $\psi$ , the way it is done in [FK], but we won't do it since it would complicate some computations.

Proposition 4.1. If  $\alpha \in V_p^{mn}$  and  $\beta \in V_p^{nm}$  then  $\langle \alpha, \beta \rangle = \langle \beta, \alpha \rangle$ .

Proof: Since the space  $V_p^{nm}$  is one dimensional we can assume that  $\beta = c \cdot \alpha \circ \check{R}$ , where  $c$  is some complex number. Using the fact that the operators  $D$  can be pulled through crossings, we get  $\langle \alpha, \beta \rangle = c \langle \alpha, \alpha \circ \check{R} \rangle =$

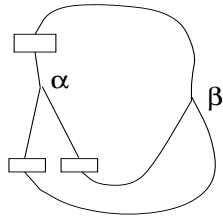
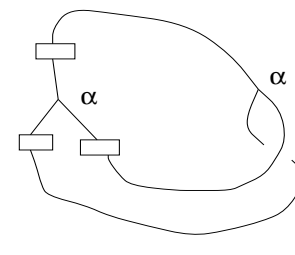
$$\frac{c X^2}{([m][n][p]^3)^{1/2}}$$

$$= \frac{c X^2}{([m][n][p]^3)^{1/2}}$$

Fig. 4.5.

$$= c \langle \alpha \circ \check{R}, \alpha \rangle. \quad \square$$

The dual of  $V_m^m$  is  $V_m^m$ ,  $\psi = id$  and the pairing is given by  $\langle \beta_m^m, \beta_m^m \rangle = X/[m]$ , the dual of  $V_1$  is also  $V_1$ ,  $\psi$  is the identity and the pairing is given by  $\langle \beta_1, \beta_1 \rangle = 1$ .

In what follows, for an lce-morphism  $f$ , we will denote  $V(f)$  also by  $f$  whenever this seems unlikely to cause confusion.

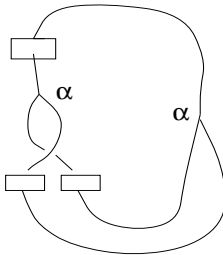
We now define the functor for the elementary moves that transform one  $DB$  structure into

another. Exactly like in the case of vector spaces, instead of describing the isomorphisms between vector spaces one can describe the changes of basis, and then all isomorphisms can be regarded as having the matrix equal to identity, with appropriate basis choice for domain and range. Also in order to get positive crossings for the diagrams of morphisms we have to consider negative crossings in the diagrams below (see the usual connection between changes of basis and isomorphisms).

If  $\sigma$  is an ice-surface and  $K$  is the move defined in the first section applied to a band along a circle labeled by  $m$ , define  $V(K) : V(\sigma) \rightarrow V(\sigma)$  to be the multiplication by  $(-1)^{m-1}$ .

If  $P$  is an ice-pair of pants, with boundary components labeled respectively  $p, m, n$  define  $T_1$ ,  $B_{23}$  and  $R$  like in Fig. 4.6.

$$\begin{array}{l}
T_1 : V_p^{mn} \longrightarrow V_p^{mn} \quad T_1 \left( \begin{array}{c} p \\ \alpha \\ m \quad n \end{array} \right) = \begin{array}{c} p \\ \alpha \\ m \quad n \end{array} \\
B_{23} : V_p^{mn} \longrightarrow V_p^{nm} \quad B_{23} \left( \begin{array}{c} p \\ \alpha \\ m \quad n \end{array} \right) = \begin{array}{c} p \\ \alpha \\ m \quad n \end{array} \\
R : V_p^{mn} \longrightarrow V_n^{pm} \quad R \left( \begin{array}{c} p \\ \alpha \\ m \quad n \end{array} \right) = \frac{[n]^{1/2}}{[p]^{1/2}} \begin{array}{c} \boxed{\phantom{p}} \\ p \\ \alpha \\ m \quad \boxed{\phantom{n}} \end{array}
\end{array}$$

Fig 4.6.

For two pairs of pants glued along a boundary component we let

$$F : \bigoplus_{p \in \mathcal{L}} V_p^{mn} \otimes V_p^{kl} \rightarrow \bigotimes_{q \in \mathcal{L}} V_p^{lm} \otimes V_p^{nk}$$

be defined by the relation in Fig. 4.7.

For an ice-pair of pants, with the bottom boundary components glued together we define  $S : \bigoplus_{m \in \mathcal{L}} V_p^{mm} \rightarrow \bigoplus_{n \in \mathcal{L}} V_p^{nn}$ , by the diagram in Fig. 4.8.

$$\text{Also } P_{12} : V_p^{mn} \otimes V_p^{kl} \rightarrow V_p^{kl} \otimes V_p^{mn}, \quad P(\alpha \otimes \beta) = (\beta \otimes \alpha)$$

$$A : V_p^{mn} \otimes V_m^m \rightarrow V_p^{mn}, \quad A(\beta_p^{mn} \otimes \beta_m^m) = \beta_p^{mn}$$

$$D : V_m^{1m} \otimes V_1^1 \rightarrow V_m^m, \quad D(\beta_m^{1m} \otimes \beta_1^1) = \beta_m^m$$

$$A : V_m^m \otimes V_m^m \rightarrow V_m^m, \quad A(\beta_m^m \otimes \beta_m^m) = \beta_m^m$$

$$D : V_1^1 \otimes V_1^1 \rightarrow V_1^1, \quad D(\beta_1^1 \otimes \beta_1^1) = \beta_1^1$$

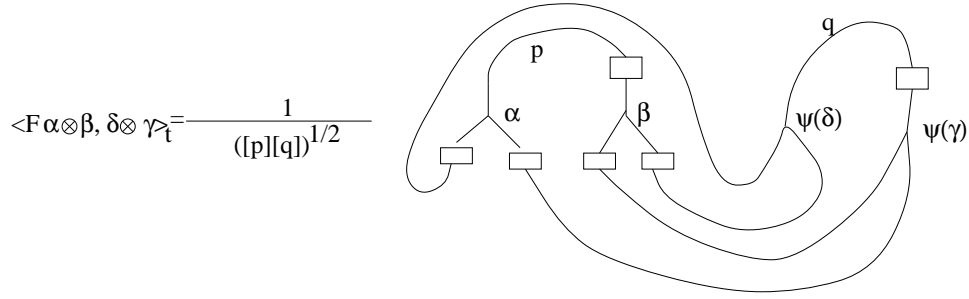

Fig. 4.7.

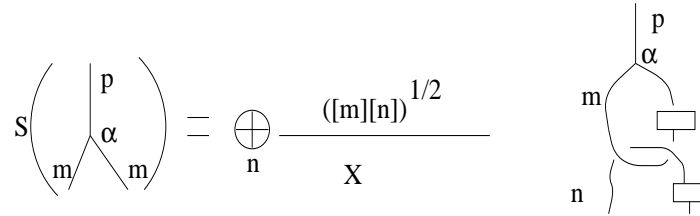

Fig. 4.8.

The map  $C = V((id, 1)) : V(\sigma) \rightarrow V(\sigma)$  is the multiplication by  $\exp(3\pi(r - 2)i/(4r))$ , and finally  $S : \mathcal{L} \rightarrow \mathbf{C}$  is given by  $S(m) = [m]/X$ .

Remark These maps are canonical, and they can be found in [Wa] and [FK]. What is important in our situation is the exact location of the coupons. Let us also note that the elements of the matrix of  $F$  are slight modifications of the  $6j$ -symbols.

## 5. RELATIONS THAT THE BASIC DATA MUST SATISFY

The first result exhibits the Moore-Seiberg equations that a modular functor on the category of ce-surfaces must satisfy. It is the analogue for ce-surfaces of Theorem 6.4 from [Wa].

Theorem 5.1. A basic data determines a modular functor  $V$  satisfying the axioms (3.1)–(3.10) (a modular functor) if and only if the following relations hold:

1. relations at the level of a ce-pair of pants:
  - a)  $T_1 B_{23} = B_{23} T_1$ ,  $T_2 B_{23} = B_{23} T_3$ ,  $T_3 B_{23} = B_{23} T_2$ , where  $T_2 = R T_1 R^{-1}$  and  $T_3 = R^{-1} T_1 R$ .
  - b)  $B_{23}^2 = T_1 T_2^{-1} T_3^{-1}$
  - c)  $R^3 = 1$
  - d)  $R B_{23} R^2 B_{23} R B_{23} R^2 = B_{23} R B_{23} R^2 B_{23}$



e)  $K^2 = 1$

2. relations defining the inverses of  $F$  and  $S$ :

a)  $P_{12}K_1^{(1)}F^2 = 1$

b)  $K_2T_3^{-1}B_{23}^{-1}S^2 = 1$

3. relations coming from “codimension 2 singularities”:

a)  $K_1^{(1)}P_{13}R^{(2)}F^{(12)}K_1^{(1)}R^{(2)}K_1^{(2)}F^{(23)}R^{(2)}F^{(12)}K_1^{(1)}R^{(2)}K_1^{(2)}F^{(23)}R^{(2)}F^{(12)} = 1$

b)  $T_3^{(1)}FB_{23}^{(1)}FB_{23}^{(1)}FB_{23}^{(1)} = 1$

c)  $C^{-1}K_2B_{23}^{-1}T_3^{-2}ST_3^{-1}ST_3^{-1}S = 1$

d)  $R^{(1)}(R^{(2)})^{-1}FS^{(1)}FB_{23}^{(2)}B_{23}^{(1)} = K_1^{(1)}FS^{(2)}T_3^{(2)}(T_1^{(2)})^{-1}B_{23}^{(2)}F$

4. relations involving annuli and disks:

a)  $F(\beta_p^{mn} \otimes \beta_p^{p1}) = \beta_m^{1m} \otimes \beta_m^{np}$

b)  $A_2^{(12)}D_3^{(13)} = D_2D_3^{(13)}$

c)  $A^{(12)}A^{(23)} = A^{(23)}A^{(12)}$

5. relations coming from duality:

– for any elementary move  $f$ , one has  $f^+ = \bar{f}$  where  $f^+$  is the dual of  $f$  with respect to the  $\langle , \rangle$  pairing, and  $\bar{f}$  is the morphism induced by  $f$  on  $-\sigma$ ,

6. relations expressing the compatibility between the pairing, and moves  $A$  and  $D$ :

a)  $\langle \beta_m^m, \beta_m^m \rangle = S(m)^{-1}$

b)  $\langle \beta_m^{m1}, \beta_m^{m1} \rangle = S(1)^{-1}S(m)^{-1}$ .

The theorem needs some clarifications. The first group of relations holds on a lce-pair of pants. For the rest of the relations the superscripts indicate the elementary surfaces to which the move is applied, while the subscripts indicate the number of the boundary component. The surfaces on which these relations hold are the ones in Fig. 5.1, (where we allow the bands along the boundary components to be indexed by any elements of the Klein group).

Remark As the reader can see, there are no listed relations that are to be satisfied at the level of a torus. This is because those relations are redundant, the torus can be obtained by capping the punctured torus with a disk.

Proof of the theorem: It is not hard to see that the theorem is a consequence of Theorem 6.4 in [Wa]. For a better understanding let us start by briefly explaining the origin of the Moore-Seiberg relations.

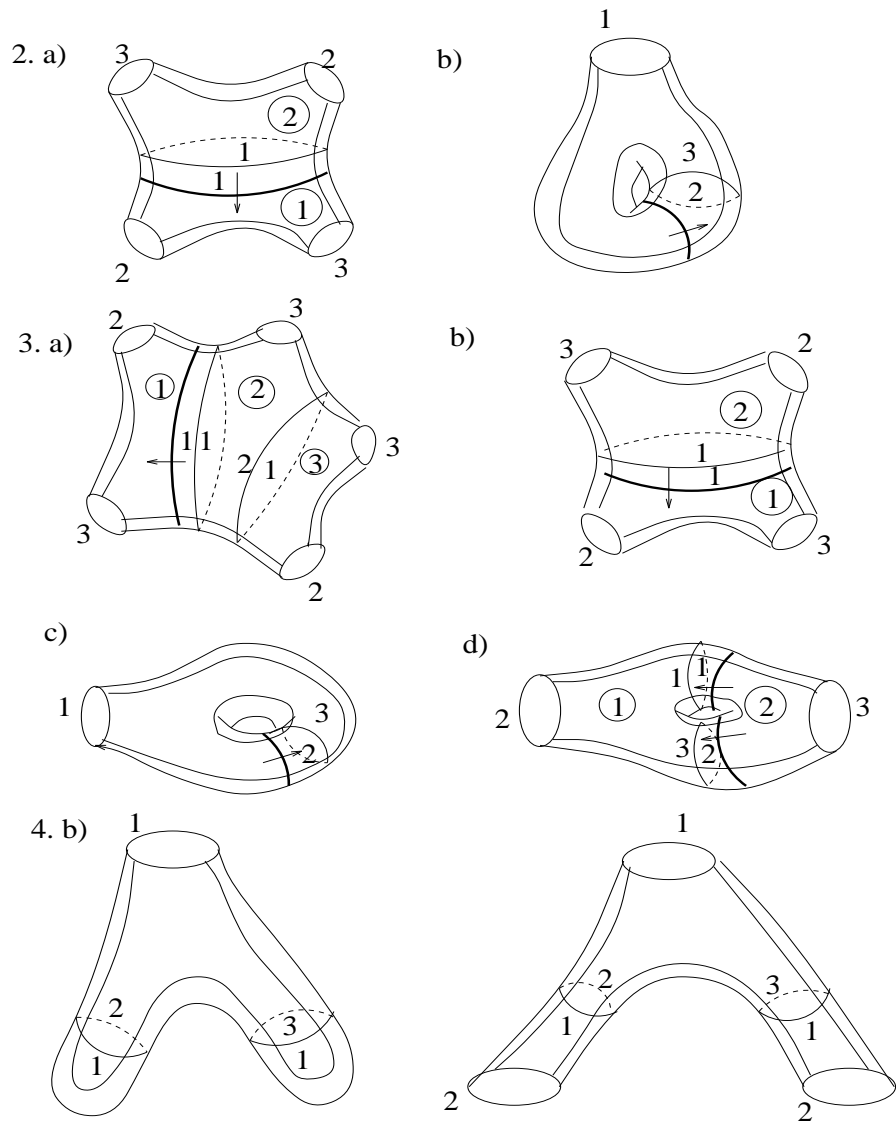

Fig. 5.1.

The first group of relations are satisfied at the level of a pair of pants. If one forgets about the bands, one gets the presentation of the mapping class group of a pair of pants. Since the mapping class group is isomorphic to the group of moves (namely of transformations of seams and numbers), the same relations give a presentation of the latter group. Lifting these relations to ce-pairs of pants one gets 1. a)–e).

The second and the third group of relations can be obtained via Cerf theory [Ce] by using the techniques described in [HT]. The first group comes from cancellations of consecutive crossings in the graph of the height function, and give the inverses of  $F$  and  $S$ . The second group arises from triangle singularities. Actually, the triangle singularities give rise to a larger number of relations, but as remarked in [Wa], they are all consequences of four fundamental ones. These four relations are liftings at the level of ce-surfaces of the following relations: the pentagon, shown in Fig. 5.2, the F-triangle, the S-triangle, both shown in Fig. 5.3 and the  $(FSF)^2$ -cell shown in Fig. 5.4.

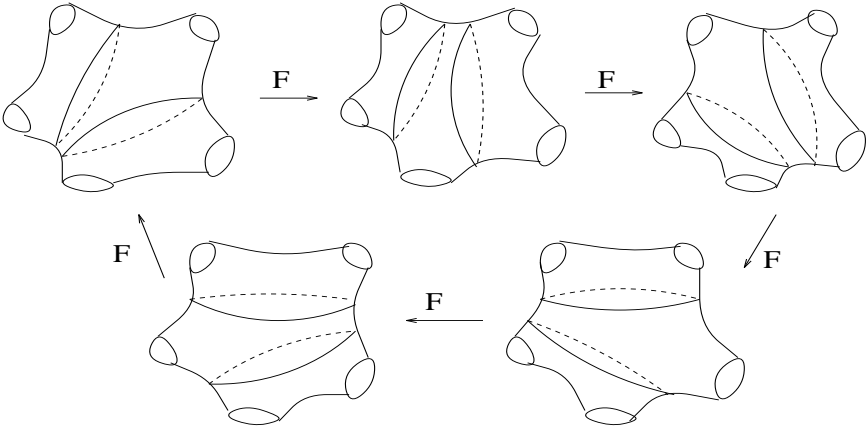

Fig. 5.2.

The fourth group of relations expresses the fact that the operation of cancelling an annulus or a disk is preserved by the functor. Finally, the last two groups of relations must hold in order for the duality axiom to be satisfied.

Let us now proceed to proving that these relations are sufficient in order for the basic data to define a modular functor.

Given a ce-surface  $\sigma$  let us consider the CW complex  $\Lambda$ , whose vertices are all the ce-surfaces that can be obtained from  $\sigma$  by performing some moves; whose edges are elementary moves between these surfaces, and whose 2-cells are the groups of relations 1, 2, 3, 4, together with all the 2-cells which express disjoint commutativity between elementary moves (which are obviously satisfied by

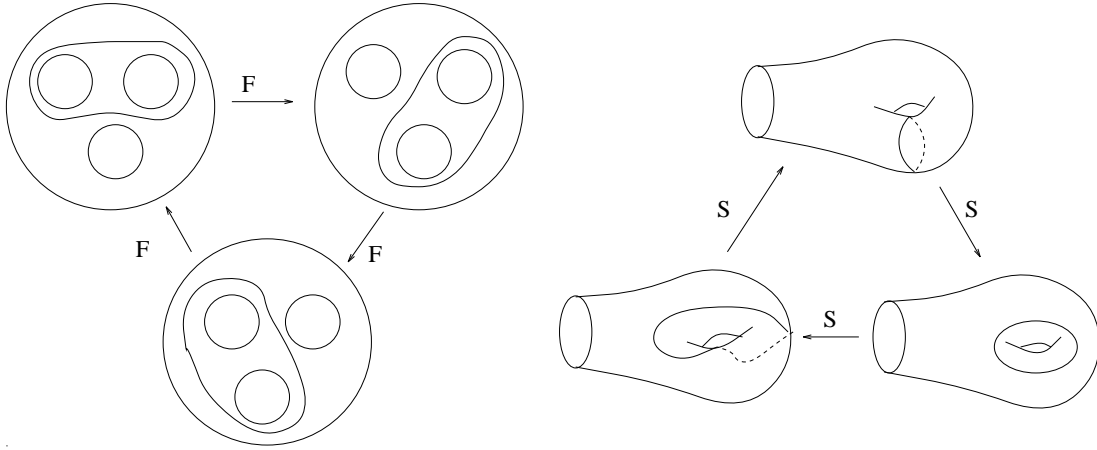

Fig. 5.3.

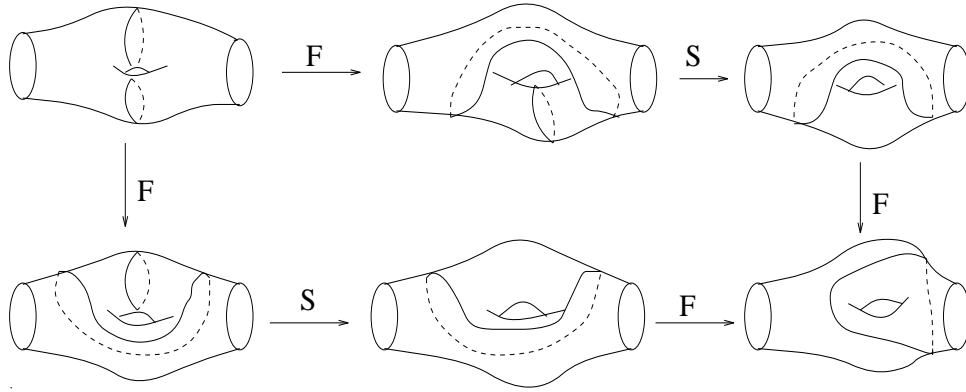

Fig. 5.4.

any basic data). The fact that  $\Lambda$  is connected follows from the construction. Let us prove that it is simply connected.

If we consider the CW complex  $\Gamma$  obtained from  $\Lambda$  by forgetting the bands (i.e. the analogous CW complex for DAP-decompositions), then Theorem 6.4 in [Wa] asserts that  $\Gamma$  is simply connected.

Let  $\phi : \Lambda \rightarrow \Gamma$  be the quotient function. We see that for any 0-cell  $\sigma_0$  of  $\Gamma$ ,  $\phi^{-1}(\phi(\sigma_0))$  consists out of the subcomplex of  $\Lambda$  whose 0-cells are the ce-surfaces that can be obtained from  $\sigma_0$  by performing moves of type  $K$ . Since any two such moves commute,  $\phi^{-1}(\phi(\sigma_0))$  is simply connected. It follows that  $\Lambda$  is also simply connected, hence the relations exhibited in the statement are sufficient for the functor  $V$  to be well defined.

The rest of the relations imply that the duality axiom for  $V$  holds, and the theorem is proved.  $\square$

The next result gives necessary and sufficient conditions for the partition function  $Z$  to be well defined.

**Theorem 5.2.** Given a functor  $V$  that satisfies the relations from Theorem 1 the partition function that it determines is well defined if and only if the following two conditions hold:

$$a) S(m) = S_{1m} \text{ where } [S_{xy}]_{x,y} \text{ is the matrix of move } S,$$

$$b) F(\beta_1^{mm} \otimes \beta_1^{nn}) = \sum_p \frac{(-1)^{n-1} id_{mnp}}{S(m)S(n)}$$

where  $id_{mnp}$  is the identity matrix in  $(V_p^{mn})^* \otimes V_p^{mn}$ .

**Proof:** Let us first convince ourselves that the two relations are necessary.

a) Let us view a ball as the mapping cylinder of the identity map of the disk. Then the invariant of the ce-ball given in Fig. 5.5.

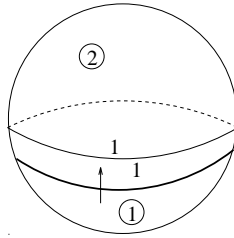

2 Fig. 5.5.

is  $\beta_1 \otimes \beta_1$ , by axiom (3.10). Let us consider the chain of transformations from Fig. 5.6, where we write under each extended ce-3-manifold its invariant.

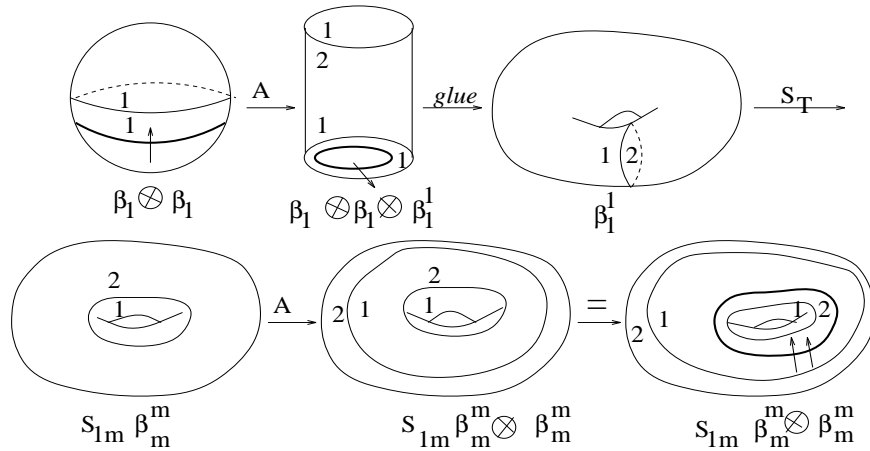

Fig. 5.6.

where  $S_T$  is the composition of elementary moves described in Fig. 1.16 ( the  $S$ -move on a torus).

By the identity described in Fig. 1.18 the latter ce-manifold is equal to the one from

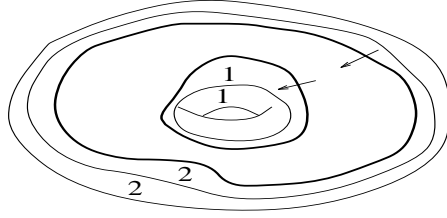

Fig. 5.7.

Fig. 5.7. which is the mapping cylinder of the identity map on a ce-annulus. The invariant of this ce-manifold is  $\bigoplus_m (id : V_m^m \rightarrow V_m^m)$ , and from Theorem 5.1 relation 6. a) it follows that this is equal to  $\bigoplus_m S(m)\beta_m^m \otimes \beta_m^m$ . This gives  $S(m) = S_{1m}, \forall m$ .

b) Similarly we have the following chain of transformations from Fig. 5.8 followed by that from Fig. 5.9.

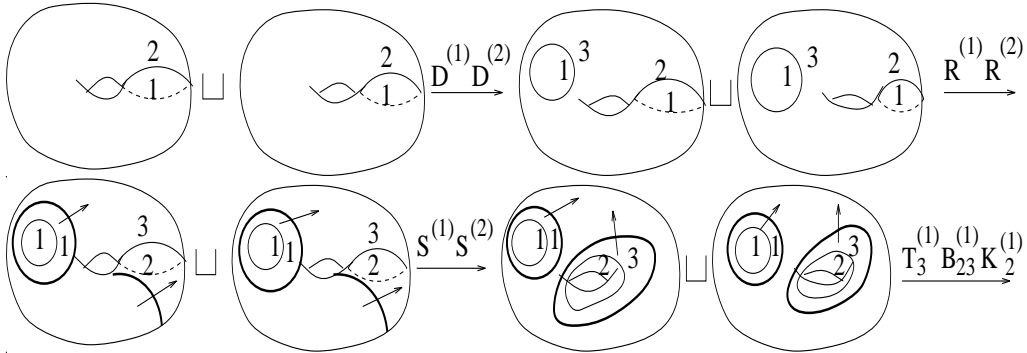

Fig. 5.8.

To it corresponds the following chain of transformations of the invariants:

$$\begin{aligned} & \beta_1^1 \otimes \beta_1^1 \rightarrow \beta_1^{11} \otimes \beta_1 \otimes \beta_1^{11} \otimes \beta_1 \rightarrow \beta_1^{11} \otimes \beta_1 \otimes \beta_1^{11} \otimes \beta_1 \rightarrow \\ & \bigoplus_{m,n} S(m)S(n)\beta_1^{mm} \otimes \beta_1 \otimes \beta_1^{nn} \otimes \beta_1 \rightarrow \bigoplus_{m,n} (-1)^{2m} S(m)S(n)\beta_1^{mm} \otimes \beta_1 \otimes \beta_1^{nn} \otimes \beta_1 \rightarrow \\ & \bigoplus_{m,n} (-1)^{2m} S(m)S(n)\beta_1^{mm} \otimes \beta_1^{nn} \rightarrow \bigoplus_{m,n} (-1)^{2n} S(m)S(n)F(\beta_1^{mm} \otimes \beta_1^{nn}) \end{aligned}$$

This is the mapping cylinder of a ce-pair of pants, so relation b) is implied by the mapping cylinder axiom.

For the proof of sufficiency, let  $\mu = (M, D, B, n)$  be a ce-3-manifold. The manifold  $M$  can be obtained by successively attaching 0, 1, 2 or 3-handles to a ball. By putting DB-structures on the handles, (and eventually performing some moves), we see that one can obtain in this way a ce-3-manifold  $(M, D', B', n')$ . The right choice of framing for the ce-handles gives  $n = n'$ . Since  $\partial M$  is a closed surface, there is a move transforming  $D'$  and  $B'$  into  $D$  and  $B$ . Thus  $\mu$  can be obtained

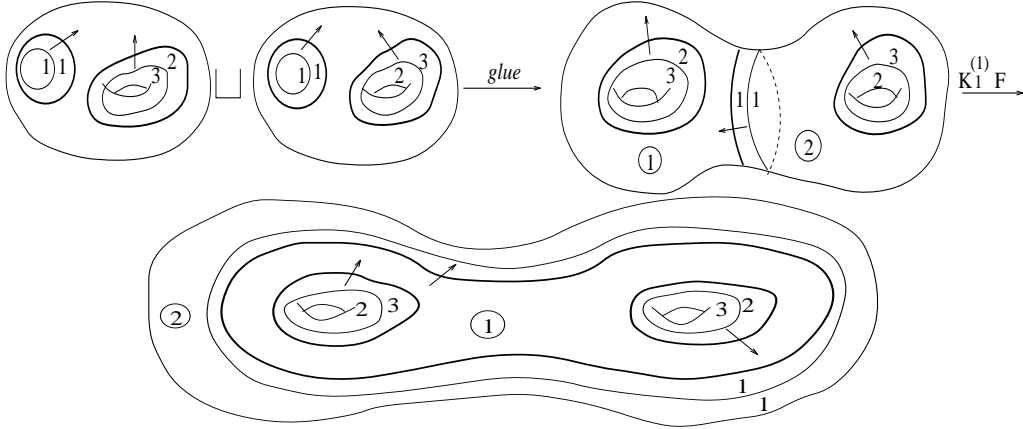

Fig. 5.9.

by successively adding handles to a ce-ball, and eventually performing moves on the boundary.

As a consequence we get that the techniques of Morse theory described in [Wa] work mutatis mutandis to show that the two relations in the statement imply that  $Z$  is well defined.  $\square$

## 6. THE VERIFICATION OF THE COMPATIBILITY CONDITIONS FOR THE BASIC DATA

In this section we will check that our basic data satisfies the conditions from Theorems 5.1 and 5.2. We start with the Moore-Seiberg relations. Since most of the proofs are similar to those from [FK] we will only check one relation from each group, for the rest we refer the reader to [FK]. The first relation we want to check is 1. c).

Lemma 6.1. If  $\alpha \in V_p^{mn}$  and  $\beta \in V_p^{nm}$  then  $\langle R\alpha, \beta \rangle = (-1)^{m-1} \langle \alpha, R\beta \rangle$ .

Proof: The proof is described in Fig. 6.1.  $\square$

Applying the lemma we get that for  $\alpha \in V_p^{mn}$  and  $\beta \in V_p^{nm}$ ,  $\langle \alpha, R^3\beta \rangle = (-1)^{m-1} \langle R\alpha, R^2\beta \rangle$ . From here the proof proceeds like in Fig. 6.2. where the last equality follows from Proposition 4.3.  $\square$

Corollary 6.2. The identities from Fig. 6.3 hold.

Proof: The first identity follows by applying  $\psi^{-1}$  to both terms of the equality  $R^3\alpha = \alpha$ . The second identity follows from the first by taking the adjoint.  $\square$

$$\begin{aligned}
\langle R \alpha, \beta \rangle &= \frac{X^2}{[m][n]^{1/2} [p]} \quad \text{[Diagram 1]} = \\
\frac{(-1)^{m-1} X^2}{[m][n]^{1/2} [p]} \quad \text{[Diagram 2]} &= \frac{(-1)^{m-1} X^2}{[m][n]^{1/2} [p]} \quad \text{[Diagram 3]} = \\
\frac{(-1)^{m-1} X^2}{[m][n]^{1/2} [p]} \quad \text{[Diagram 4]} &= (-1)^{m-1} \langle \alpha, R \beta \rangle.
\end{aligned}$$

Fig. 6.1.

$$\begin{aligned}
\frac{(-1)^{m-1} X^2}{([m][n]^3 [p])^{1/2}} \frac{[n]}{[p]} \quad \text{[Diagram 1]} &= \\
\frac{X^2}{([m][n][p]^3)^{1/2}} \quad \text{[Diagram 2]} &= \langle \beta, \alpha \rangle = \langle \alpha, \beta \rangle
\end{aligned}$$

Fig. 6.2.



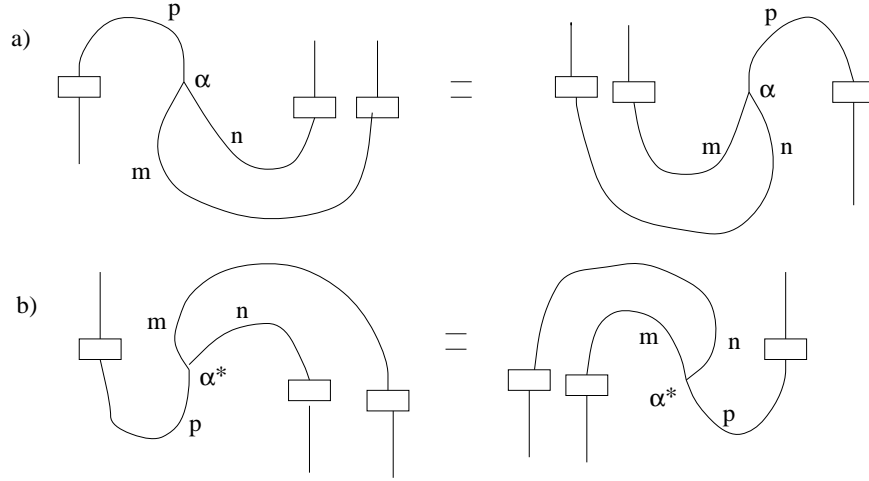

Fig.6.3.

Proposition 6.3. Assume that  $C_i : \underline{1} \rightarrow \underline{m_i} \otimes \underline{n_i} \otimes \underline{m_{i+1}} \otimes \underline{n_{i+1}}$ ,  $i = 1, \dots, N$ ,  $N + 1 = 1$  are morphisms of representations. Let  $\beta_q^i = \beta_q^{m_i n_i}$ ,  $q \in \mathcal{L}$ . Then the identity from Fig. 6.4 holds.

$$\sum_q \frac{1}{[q]^{N-1}} \begin{array}{c} \beta_q^1 \\ \beta_q^2 \\ \beta_q^3 \\ \dots \\ \beta_q^N \end{array} \begin{array}{c} \psi(\beta_q^2) \\ \psi(\beta_q^3) \\ \dots \\ \psi(\beta_q^N) \end{array} \psi(\beta_q^1) = \begin{array}{c} \dots \\ \dots \\ \dots \end{array}$$

Fig. 6.4.

Proof: We proceed by transforming the left hand side like in Fig. 6.5.

Since by Schur's lemma all the factors in the middle are multiples of the identity on  $q$  they can be inserted into the first factor to get the expression from Fig. 6.6, which is further equal to the one in Fig. 6.7 since in the first factor of this latter expression the only thing that matters is the copy of  $q$  in each  $\underline{m_i} \otimes \underline{n_i}$ .

Further, this is equal to the diagram from Fig. 6.8 which by Proposition 7 in [FK] is equal to the desired expression.  $\square$

We are now ready to proceed with the proof of relation 2. a). Write it as  $FP_{12}K_1^{(1)}F = 1$ . Let  $\alpha \otimes \beta \in V_p^{ij} \otimes V_p^{kl}$  and  $\delta \otimes \gamma \in V_q^{ij} \otimes V_q^{kl}$ . Recall that for  $u, v, w \in \mathcal{L}$ ,  $\beta_w^{uv} \in V_w^{uv}$  is the orthogonal

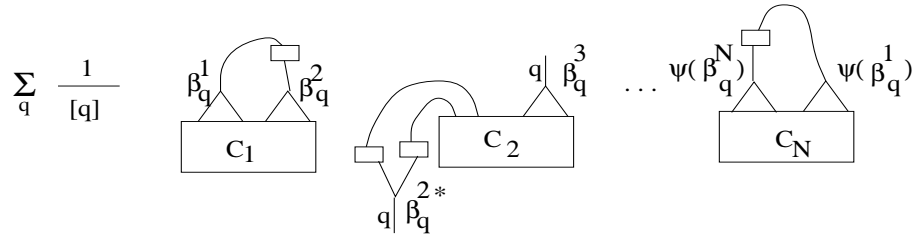
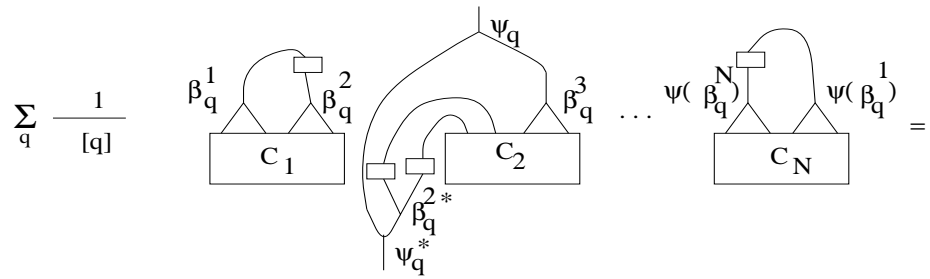

Fig. 6.5.

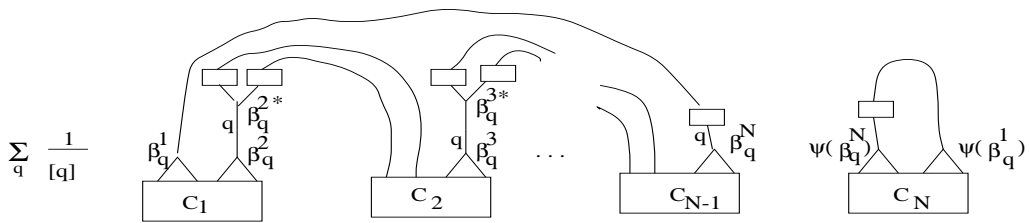

Fig. 6.6

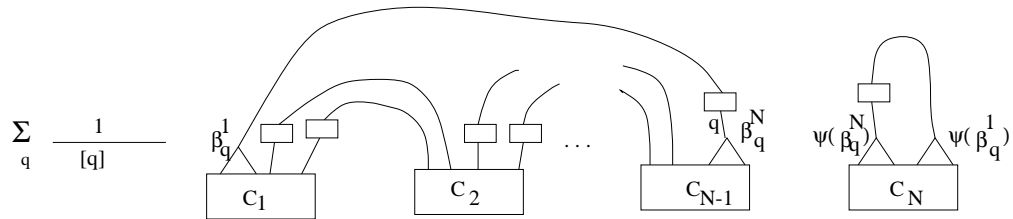

Fig. 6.7.

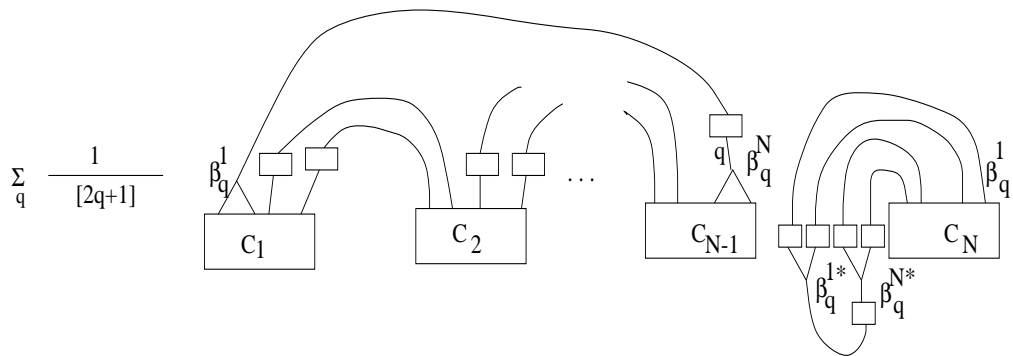

Fig. 6.8.

projection. We have

$$\begin{aligned} & \langle FP_{12}K_1^{(1)}F(\alpha \otimes \beta), \delta \otimes \gamma \rangle_t = \langle F(\alpha \otimes \beta), (FP_{12}K_1^{(1)})^*(\delta \otimes \gamma) \rangle_t = \\ & \sum_r \langle F\alpha \otimes \beta, \beta_r^{li} \otimes \beta_r^{jk} \rangle_t \langle \beta_r^{li} \otimes \beta_r^{jk}, (FP_{12}K_1^{(1)})^*(\delta \otimes \gamma) \rangle_t = \\ & \sum_r \langle F\alpha \otimes \beta, \beta_r^{li} \otimes \beta_r^{jk} \rangle_t \langle FK_1^{(1)}\beta_r^{jk} \otimes \beta_r^{li}, \delta \otimes \gamma \rangle_t. \end{aligned}$$

From here we proceed like in Fig. 6.9. Using Proposition 6.3, we see that we can continue our computation like in Fig. 6.10.

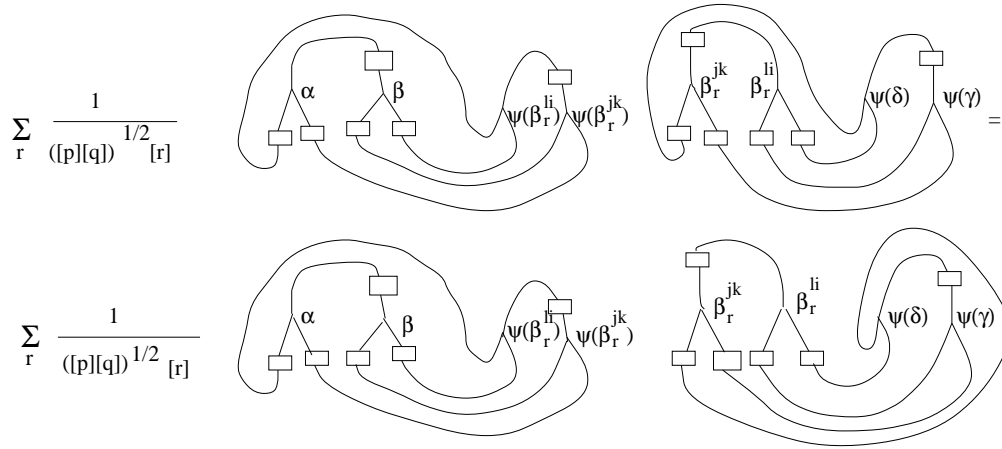

Fig. 6.9.

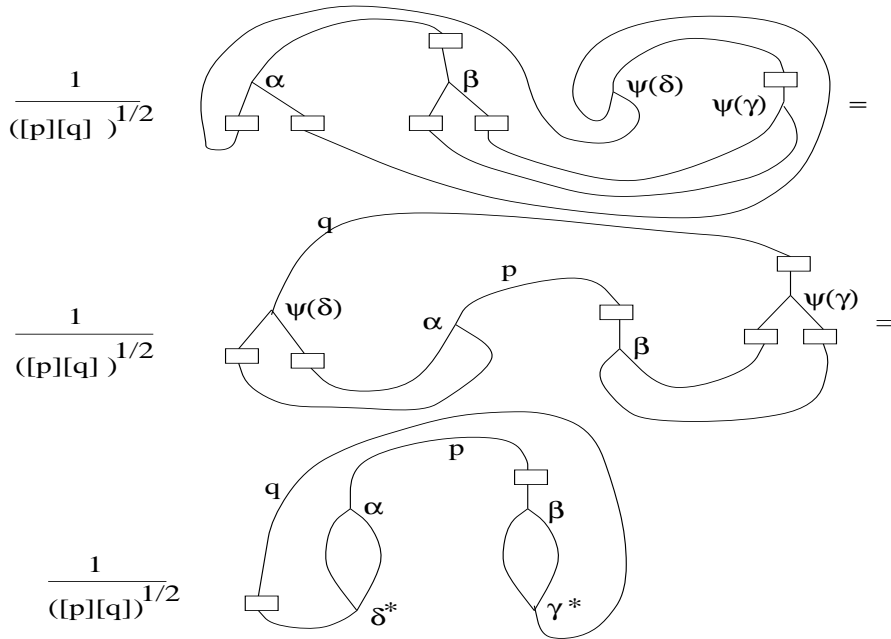

Fig. 6.10.

By Schur's lemma and the definition of the trace pairing this is equal to

$$\frac{1}{\sqrt{[p]}\sqrt{[q]}}\delta_{p,q} \langle \alpha, \delta \rangle_t \langle \beta, \gamma \rangle_t [p]$$

where  $\delta_{p,q}$  is the Kronecker symbol. The latter is equal to  $\delta_{p,q} \langle \alpha, \delta \rangle_t \langle \beta, \gamma \rangle_t$  which shows that the matrix of our morphism is the identity matrix.  $\square$

Let us now prove the pentagon identity. Rewrite it by using 1. c) and 2. a) in the form

$$R^{(2)} F^{(12)} K_1^{(1)} R^{(2)} K_1^{(2)} F^{(23)} R^{(2)} F^{(12)} = F^{(23)} P_{23} P_{12} (R^{(1)})^2 F^{(12)} (R^{(2)})^2 P_{13} K_1^{(1)}.$$

We prove the identity by checking the action on projectors and by using the trace pairing. For the left hand side we have

$$\begin{aligned} & \langle R^{(2)} F^{(12)} K_1^{(1)} R^{(2)} K_1^{(2)} F^{(23)} R^{(2)} F^{(12)} \beta_p^{ij} \otimes \beta_p^{qk} \otimes \beta_q^{lm}, \beta_r^{mk} \otimes \beta_s^{ri} \otimes \beta_s^{jl} \rangle_{t=} \\ & \langle F^{(12)} K_1^{(1)} R^{(2)} K_1^{(2)} F^{(23)} R^{(2)} F^{(12)} \beta_p^{ij} \otimes \beta_p^{qk} \otimes \beta_q^{lm}, \beta_r^{mk} \otimes \beta_r^{is} \otimes \beta_s^{jl} \rangle_{t=} \\ & \sum_t \langle F \beta_p^{ij} \otimes \beta_p^{qk}, \beta_t^{ki} \otimes \beta_t^{jq} \rangle_t \langle F R^{(1)} \beta_t^{jq} \otimes \beta_q^{lm}, \beta_s^{mt} \otimes \beta_s^{jl} \rangle_t \cdot \\ & \langle F K_1^{(1)} R^{(2)} K_1^{(2)} \beta_t^{ki} \otimes \beta_s^{mt}, \beta_r^{mk} \otimes \beta_r^{is} \rangle_{t=} \\ & \sum_t (-1)^{2m} \langle F \beta_p^{ij} \otimes \beta_p^{qk}, \beta_t^{ki} \otimes \beta_t^{jq} \rangle_t \langle F R^{(1)} \beta_t^{jq} \otimes \beta_q^{lm}, \beta_s^{mt} \otimes \beta_s^{jl} \rangle_t \cdot \\ & \langle F K_1^{(1)} R^{(2)} K_1^{(2)} \beta_t^{ki} \otimes \beta_t^{sm}, \beta_r^{mk} \otimes \beta_r^{is} \rangle_t \end{aligned}$$

From here the computation continues like in Fig 6.11.

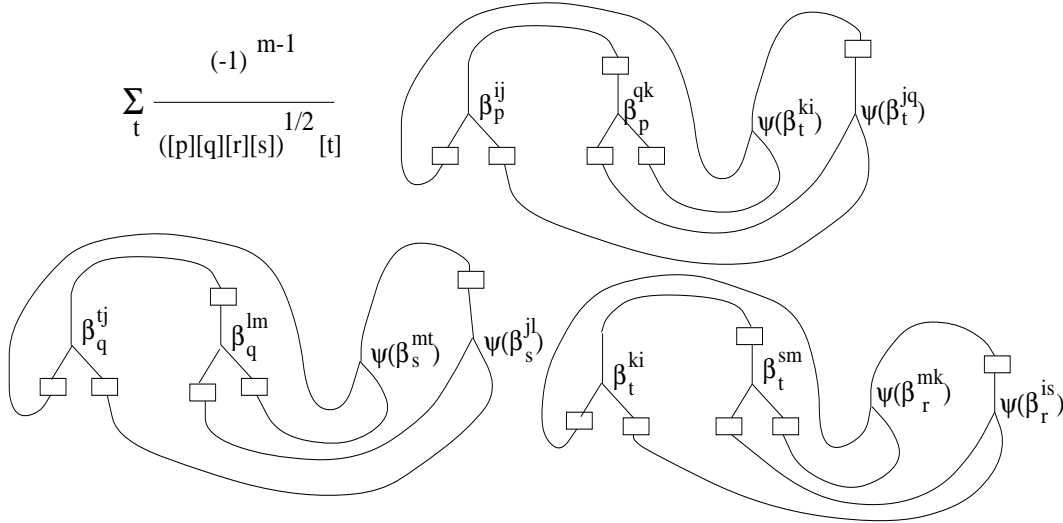

Fig. 6.11.

Further we do two rotations in the second factor and a flip in the third to get the expression

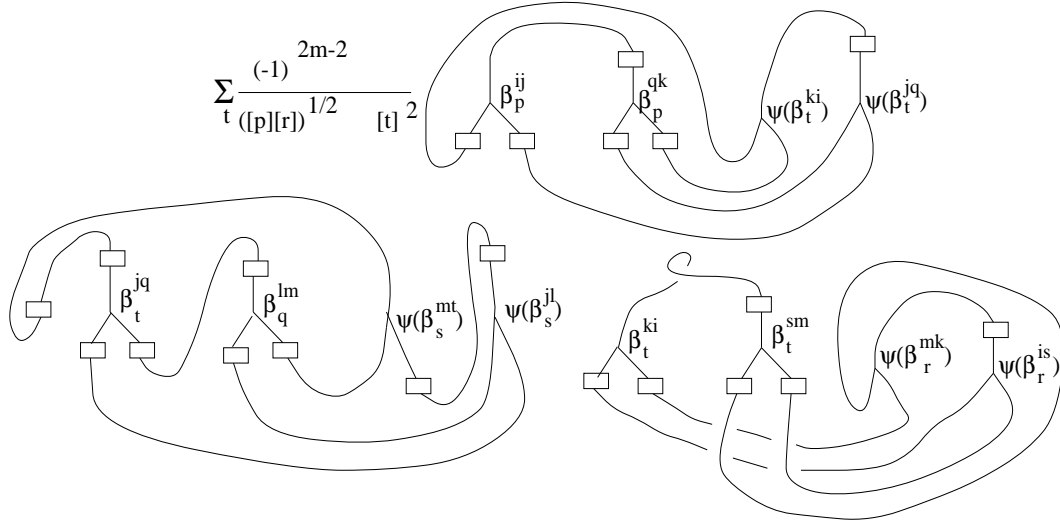

Fig. 6.12.

from Fig. 6.12. By using 1. b) in the third factor we get the diagram from Fig. 6.13. Using Proposition 6.3 we see that we can continue like in Fig. 6.14.

For the right hand side we have

$$\begin{aligned} & \langle F^{(23)} P_{23} P_{12} (R^{(1)})^2 F^{(12)} (R^{(2)})^2 P_{13} K_1^{(1)} \beta_p^{ij} \otimes \beta_p^{qk} \otimes \beta_q^{lm}, \beta_r^{mk} \otimes \beta_s^{ri} \otimes \beta_s^{jl} \rangle_t = \\ & (-1)^{2p} \langle F \beta_q^{lm} \otimes \beta_q^{kp}, \beta_r^{pl} \otimes \beta_r^{mk} \rangle_t \langle F \beta_p^{ij} \otimes \beta_p^{lr}, \beta_s^{ri} \otimes \beta_s^{jl} \rangle_t. \end{aligned}$$

This is equal to the morphism described by the diagram in Fig 6.15.

By applying one rotation in the first factor and other two rotations in the second, we get the expression from Fig. 6.16.

We do a flip in the second factor use 1. c) and continue like in Fig. 6.17.

From here, after using Proposition 7. c) in [FK] we continue with the computations like in Fig. 6.18 to finally get the expression from Fig. 6.19, and the identity is proved.

For the relation 4. a) let us first remark that  $F(\beta_p^{mn} \otimes \beta_p^{p1}) \in V_m^{1m} \otimes V_m^{np}$ , so we only have to compute  $\langle F(\beta_p^{mn} \otimes \beta_p^{p1}), \beta_m^{1m} \otimes \beta_m^{np} \rangle_t$ . This is done in Fig. 6.20.

The fifth group of identities is satisfied because of the following equalities

$$\bar{B}_{23} = B_{23}^{-1}, \bar{K}_i = K_i, \bar{T}_i = T_i^{-1}, \bar{R} = R^{-1} K_1 K_3, \bar{S} = S^{-1} \text{ and } \bar{F} = F^{-1}.$$

The last group of relations is clearly satisfied.  $\square$

Let us proceed in verifying that the two relations from Theorem 5.2 hold. The first one holds by definition. For the second one let us first remark that the identity matrix on  $V_p^{mn}$  has the form

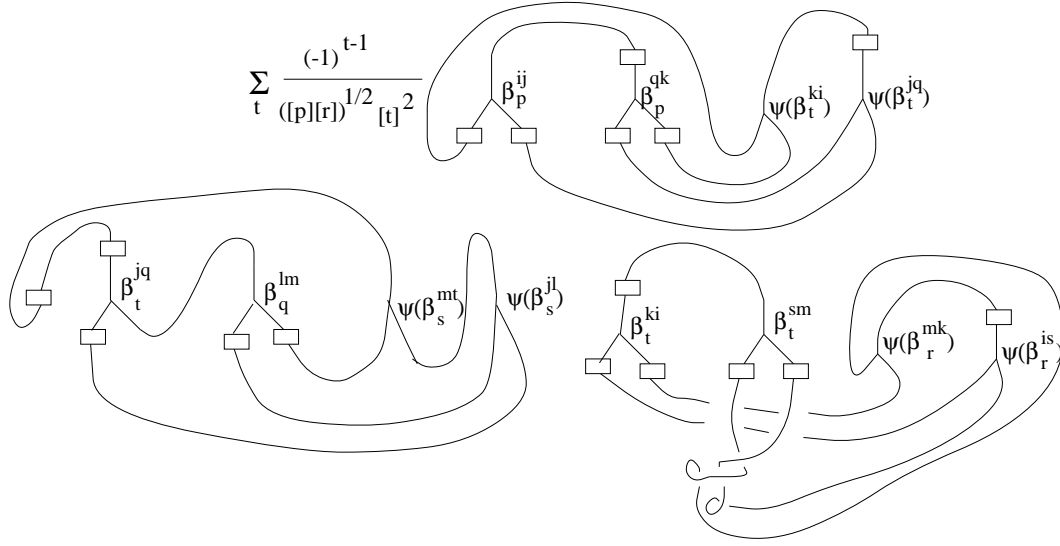

Fig. 6.13.

$\bigoplus_{m,n,p} \beta_p^{\hat{m}n} \otimes \beta_p^{mn}$ , where  $\beta_p^{\hat{m}n} \in V_p^{nm}$  is the base elements dual to  $\beta_p^{mn}$  with respect to the pairing. We only have to check that

$$\langle F\beta_1^{mm} \otimes \beta_1^{nn}, \beta_p^{mn} \otimes \beta_p^{nm} \rangle = \frac{(-1)^{n-1} \langle \beta_p^{mn}, \beta_p^{nm} \rangle}{S(m)S(n)}.$$

We have

$$\langle F\beta_1^{mm} \otimes \beta_1^{nn}, \beta_p^{mn} \otimes \beta_p^{nm} \rangle = \frac{X^4}{[m][n][p]} \langle F\beta_1^{mm} \otimes \beta_1^{nn}, \psi(\beta_p^{mn}) \otimes \psi(\beta_p^{nm}) \rangle_t$$

The value of this expression is given in Fig. 6.21.

By using the identity from Fig. 6.22, we see that we can continue like in Fig. 6.23 to get the desired result.  $\square$

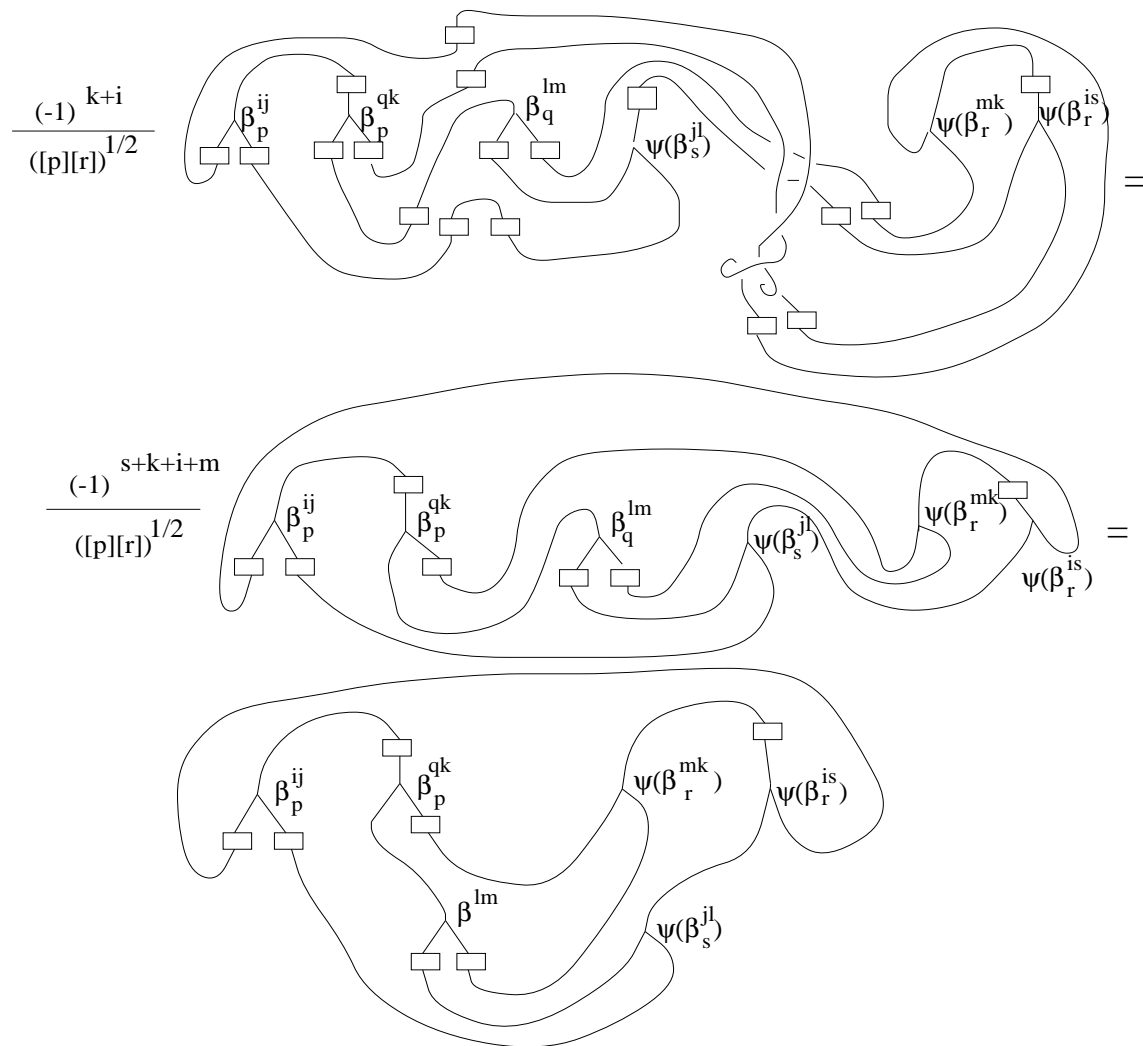

Fig. 6.14.

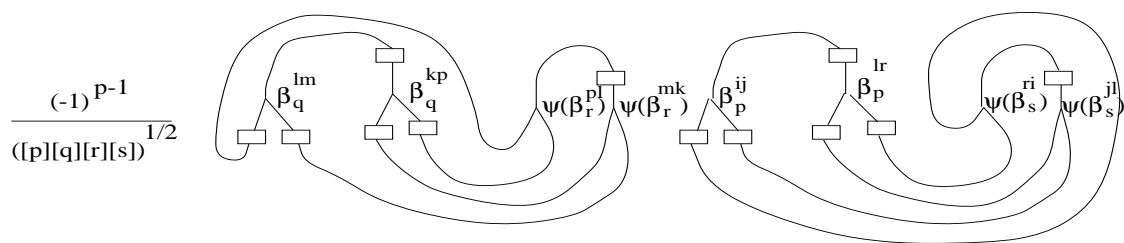

Fig. 6.15.

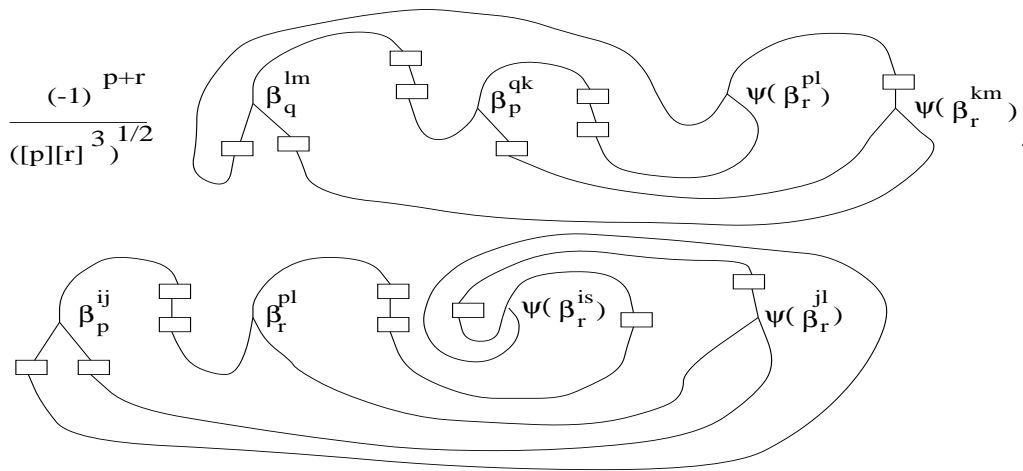

Fig. 6.16.

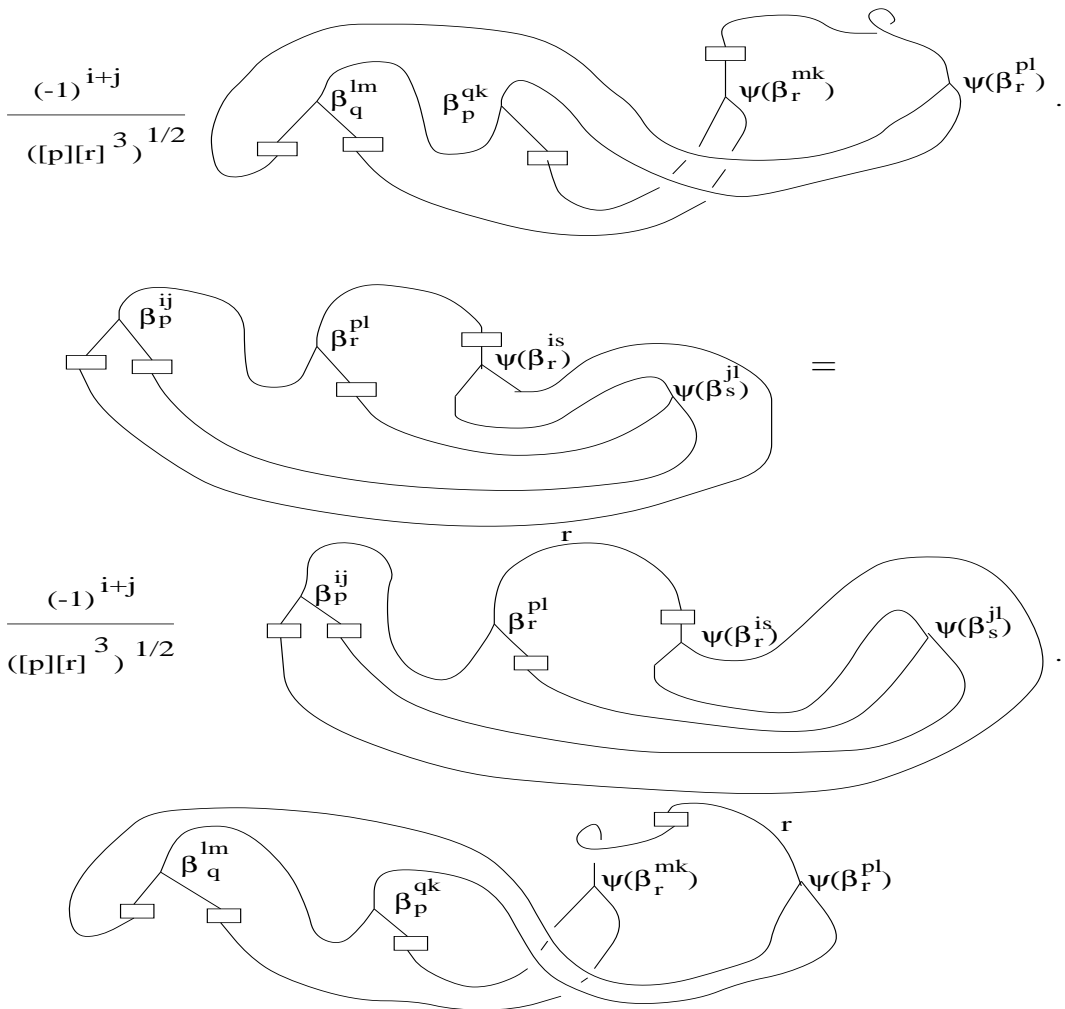

Fig. 6.17.



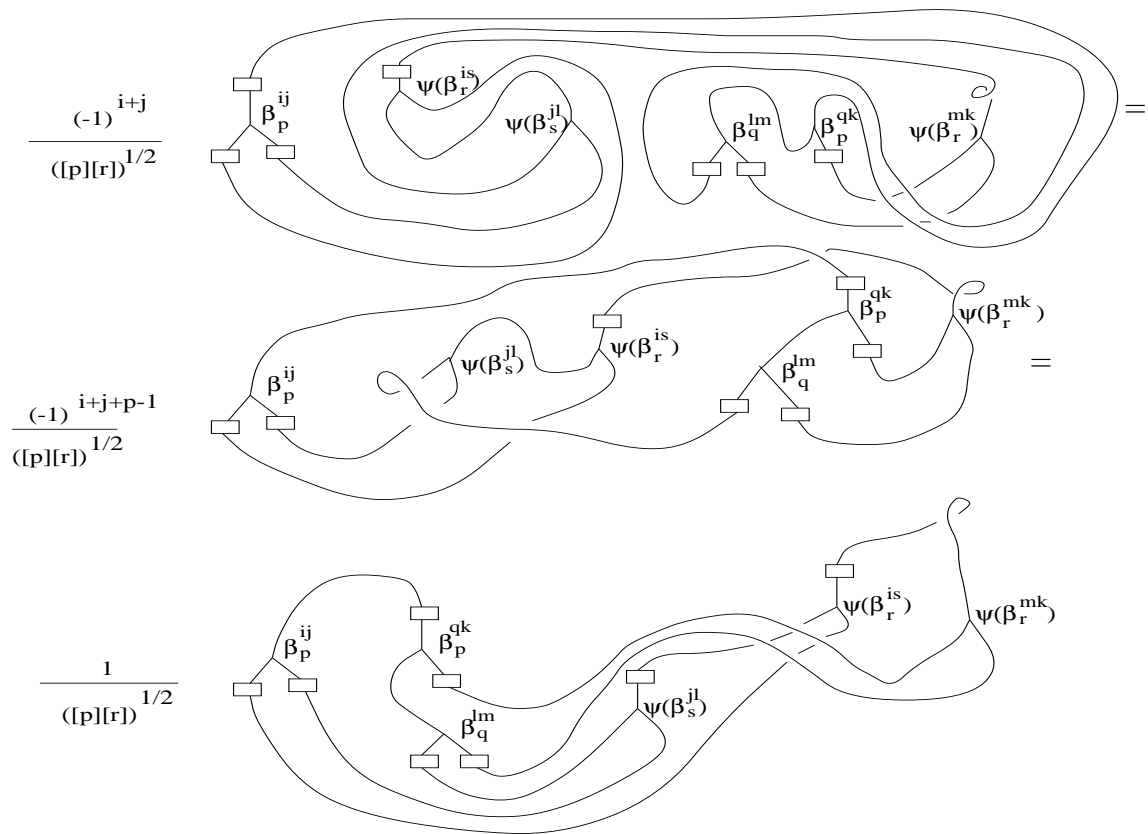

Fig. 6.18.

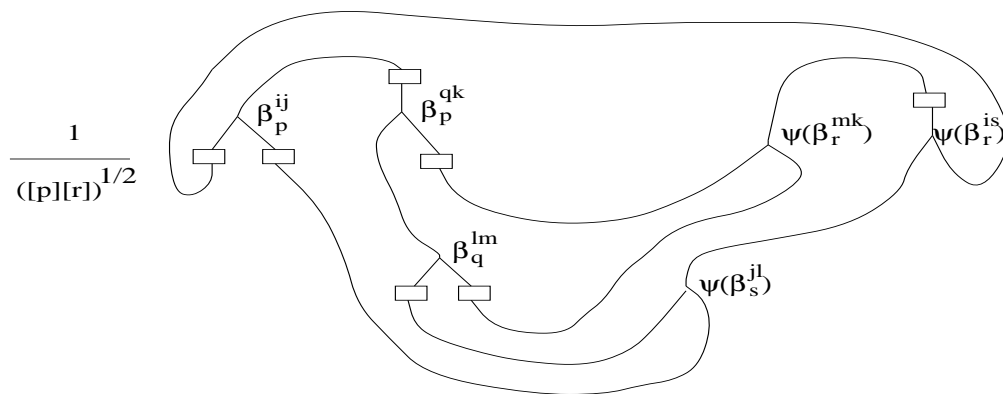

Fig. 6.19.

$$\begin{aligned}
& \frac{1}{([p][m])^{1/2}} \left( \text{Diagram 1} \right) = \\
& \frac{1}{([p][m])^{1/2}} \left( \text{Diagram 2} \right) = \frac{1}{[m]} \left( \text{Diagram 3} \right) = \\
& = \langle \beta_m^{np}, \beta_m^{np} \rangle_t = 1.
\end{aligned}$$

Fig. 6.20.

$$\frac{x^4}{[m][n][p]^{3/2}} \left( \text{Diagram 4} \right)$$

Fig. 6.21.

$$\beta_0^{mm} = \psi_m = \frac{1}{[m]^{1/2}} \left( \text{Diagram 5} \right)$$

Fig. 6.22.

$$\frac{X^4}{([m][n][p])^{3/2}} \text{ (diagram) } = \frac{(-1)^{n-1} X^4}{([m][n][p])^{3/2}} \text{ (diagram) } = \frac{(-1)^{n-1} X^2}{([m][n])} \langle \beta_p^{mn}, \beta_p^{nm} \rangle$$

Fig. 6.23.

## REFERENCES

- [A] Atiyah, M. F., *The Geometry and Physics of knots*, Lezioni Lincee, Accademia Nazionale de Lincei, Cambridge Univ. Press, 1990.
- [Ce] Cerf, J., *La stratification naturelle et le théoreme de la pseudo-isotopie*, Publ. Math. I.H.E.S., **39**(1969), 5–173.
- [FK] Frohman, Ch., Kania-Bartoszynska, J., *SO(3) topological quantum field theory*, preprint, 1994.
- [G] Gelca, R., *The quantum invariant of the complement of a link*, preprint.
- [HT] Hatcher, A., Thurston, W., *A presentation of the mapping class group of a closed orientable surface*, Topology, **19**(1980), 221–237.
- [J] Jones, V., F., R., *Polynomial invariants of knots via von Neumann algebras*, Bull. Amer. Math. Soc., **12**(1998), 103–111.
- [KM] Kirby, R., Melvin, P., *The 3-manifold invariants of Witten and Reshetikhin–Turaev for  $sl(2, \mathbf{C})$* , Inventiones Math., **105**(1991), 547–597.
- [RT] Reshetikhin, N. Yu., Turaev, V. G., *Invariants of 3-manifolds via link polynomials and quantum groups*, Inventiones Math., **103**(1991), 547–597.
- [T] Turaev, V., G., *Quantum invariants of Knots and 3-manifolds*, de Gruyter Studies in Mathematics, de Gruyter, Berlin–New York, 1994.
- [Wa] Walker, K., *On Witten’s 3-manifold invariants*, preprint, 1991.
- [W] Wall, C. T. C., *Non-additivity of the signature*, Inventiones Math., **7**(1969), 269–274.

Department of Mathematics, The University of Iowa, Iowa City, IA 52242 (mailing address)  
*E-mail: rgelca@math.uiowa.edu*

and

Institute of Mathematics of Romanian Academy, P.O.Box 1-764, 70700 Bucharest, Romania.