

Reflection of light from a disordered medium backed by a phase-conjugating mirror

J. C. J. Paasschens,^{a,b} M. J. M. de Jong,^a P. W. Brouwer,^b and C. W. J. Beenakker^b

^a*Philips Research Laboratories, 5656 AA Eindhoven, The Netherlands*

^b*Instituut-Lorentz, Leiden University, P.O. Box 9506, 2300 RA Leiden, The Netherlands*

(March 1, 2022)

Abstract

This is a theoretical study of the interplay of optical phase-conjugation and multiple scattering. We calculate the intensity of light reflected by a phase-conjugating mirror when it is placed behind a disordered medium. We compare the results of a fully phase-coherent theory with those from the theory of radiative transfer. Both methods are equivalent if the dwell time τ_{dwell} of a photon in the disordered medium is much larger than the inverse of the frequency shift $2\Delta\omega$ acquired at the phase-conjugating mirror. When $\tau_{\text{dwell}}\Delta\omega \lesssim 1$, in contrast, phase coherence drastically affects the reflected intensity. In particular, a minimum in the dependence of the reflectance on the disorder strength disappears when $\Delta\omega$ is reduced below $1/\tau_{\text{dwell}}$. The analogies and differences with Andreev reflection of electrons at the interface between a normal metal and a superconductor are discussed.

PACS numbers: 42.65.Hw, 42.68.Ay, 42.25.Bs, 78.20.Ci

physics/9708010

I. INTRODUCTION

Phase conjugation is the reversal of the sign of the phase of a wave function. A phase-conjugated wave retraces the path of the original wave, thereby canceling all accumulated phase shifts. Phase conjugation was first discovered for electronic waves [1], and later for optical waves [2,3]. For electrons, phase conjugation takes place at the interface between a normal metal and a superconductor. An electron at energy E above the Fermi energy E_F is reflected at the angle of incidence (retro-reflected) as a hole at energy E below E_F , a process known as Andreev reflection [4]. A phase-conjugating mirror for light consists of a cell containing a liquid or crystal with a large nonlinear susceptibility, pumped by two counter-propagating beams at frequency ω_0 . A wave incident at frequency $\omega_0 + \Delta\omega$ is then retro-reflected at frequency $\omega_0 - \Delta\omega$, a process known as four-wave mixing [5–7].

The interplay of multiple scattering by disorder and phase conjugation has been studied extensively in the electronic case, both experimentally and theoretically. (See Ref. [8] for a review.) In the optical case the emphasis has been on weakly disordered media, which do not strongly scatter the waves [9]. Complete wave-front reconstruction is possible only if the distorted wave front remains approximately planar, since perfect time reversal upon reflection holds only in a narrow range of angles of incidence for realistic systems. (For the hypothetical case of perfect time-reversal at all angles, see Ref. [10].) McMichael, Ewbank, and Vachss [11] measured the intensity of the reconstructed wave front for a strongly inhomogeneous medium (small transmission probability T_0), and found that it was proportional to T_0^2 — in agreement with the theoretical prediction of Gu and Yeh [12]. If $T_0 \ll 1$, the intensity of the reconstructed wave is much smaller than the total reflected intensity. The total reflected intensity was not studied previously, perhaps because it was believed that the diffusive illumination resulting from a strongly inhomogeneous medium would render the effect of phase conjugation insignificant. In this paper we show that a strongly disordered medium backed by a phase-conjugating mirror has unusual optical properties, different both from the weakly disordered case and from the electronic analogue.

We distinguish two regimes, depending on the relative magnitude of the frequency shift $2\Delta\omega$ acquired at the phase-conjugating mirror and the inverse of the dwell time τ_{dwell} of a photon in the disordered medium. (For a medium of length L and mean free path l , with light velocity c , one has $\tau_{\text{dwell}} \simeq L^2/cl$.) In the *coherent regime*, $\Delta\omega \ll 1/\tau_{\text{dwell}}$, phase conjugation leads to a constructive interference of multiply scattered light in the disordered medium. In the *incoherent regime*, $\Delta\omega \gg 1/\tau_{\text{dwell}}$, interference effects are insignificant. In both regimes we compute the reflectances R_+ and R_- , defined as the reflected power at frequency $\omega_0 \pm \Delta\omega$ divided by the incident power at frequency $\omega_0 + \Delta\omega$. A distinguishing feature of the two regimes is that (in a certain parameter range) the reflectance R_- decreases monotonically as a function of L/l in the coherent regime, while in the incoherent regime it first decreases and then increases.

The outline of this paper is as follows. After having formulated the problem in Sec. II, we discuss in Sec. III its solution using the Boltzmann equation, ignoring phase coherence. This is the theory of radiative transfer [13,14]. A simple result is obtained if we neglect angular correlations between the scattering in the disordered medium and at the phase-conjugating mirror. We compare this approximation with an exact solution of the Boltzmann equation. In Sec. IV the phase-coherent problem is addressed, analytically using random-matrix theory,

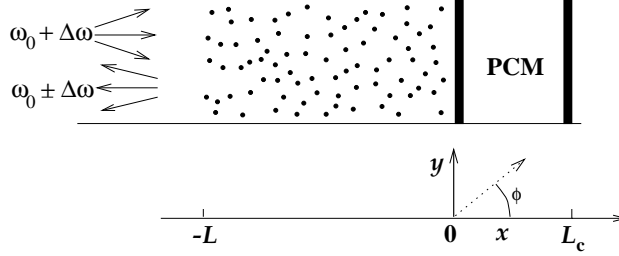

FIG. 1. Schematic drawing of the disordered medium backed by a phase-conjugating mirror (PCM). Light incident at frequency $\omega_0 + \Delta\omega$ is reflected at the two frequencies $\omega_0 \pm \Delta\omega$.

and numerically using the method of recursive Green functions. Results of this section were briefly presented in Ref. [15]. We conclude in Sec. V with a comparison with the electronic analogue of this problem.

II. FORMULATION OF THE PROBLEM

We study the system shown in Fig. 1. It consists of a disordered medium (length L , mean free path l), backed at one end by a phase-conjugating mirror. The other end is illuminated diffusively at frequency $\omega_+ = \omega_0 + \Delta\omega$, where ω_0 is the pump frequency of the mirror. We are interested in the amount of light reflected at frequency ω_+ and $\omega_- = \omega_0 - \Delta\omega$.

To reduce the problem to the scattering of a *scalar* wave, we choose a two-dimensional geometry. The scatterers consist of dielectric rods in the z -direction, randomly placed in the x - y -plane. The electric field points in the z -direction and varies in the x - y -plane only. Two-dimensional scatterers are somewhat artificial, but can be realized experimentally [16]. We believe that our results apply qualitatively to a three-dimensional geometry as well, because the randomization of the polarization by the disorder renders the vector character of the light insignificant.

The z -component of the electric field at the frequencies ω_+ and ω_- is given by

$$E_{\pm}(x, y, t) = \text{Re } \mathcal{E}_{\pm}(x, y) \exp(-i\omega_{\pm}t). \quad (2.1)$$

The phase-conjugating mirror (at $x = L$) couples the two frequencies via the wave equation [5,17,18]

$$\begin{pmatrix} \mathcal{H}_0 & \gamma^* \\ -\gamma & -\mathcal{H}_0 \end{pmatrix} \begin{pmatrix} \mathcal{E}_+ \\ \mathcal{E}_-^* \end{pmatrix} = \frac{2\varepsilon\Delta\omega}{\omega_0} \begin{pmatrix} \mathcal{E}_+ \\ \mathcal{E}_-^* \end{pmatrix}. \quad (2.2)$$

The complex dimensionless coupling constant γ is zero for $x < 0$ and for $x > L_c$, with L_c the length of the nonlinear medium forming the phase-conjugating mirror. For $0 < x < L_c$ it is proportional to the electric fields $\mathcal{E}_1, \mathcal{E}_2$ of the two pump beams and to the third-order nonlinear susceptibility χ_3 :

$$\gamma = -\frac{3}{2\varepsilon_0}\chi_3\mathcal{E}_1^*\mathcal{E}_2^* \equiv \gamma_0 e^{i\psi}, \quad 0 < x < L_c. \quad (2.3)$$

The Helmholtz operator \mathcal{H}_0 at frequency ω_0 is given by

$$\mathcal{H}_0 = -k_0^{-2}\nabla^2 - \varepsilon, \quad (2.4)$$

where $\varepsilon(x, y)$ is the relative dielectric constant of the medium. We take $\varepsilon = 1$ except in the disordered region $-L < x < 0$, where $\varepsilon = 1 + \delta\varepsilon(x, y)$. The fluctuations $\delta\varepsilon$ lead to scattering with mean free path l . We assume $k_0l \gg 1$, where $k_0 = \omega_0/c$ is the wave number of the light (velocity c). The validity of Eq. (2.2) requires $\Delta\omega/\omega_0 \ll 1$ and $|\gamma| \equiv \gamma_0 \ll 1$. The ratio of these two small parameters

$$\delta = \frac{2\Delta\omega}{\gamma_0\omega_0} \quad (2.5)$$

is a measure of the degeneracy of the incident and the reflected wave, and can be chosen freely.

In the absence of disorder, an incoming plane wave in the direction $(\cos \phi, \sin \phi)$ is retro-reflected in the direction $(-\cos \phi, -\sin \phi)$, with a different frequency and amplitude. The scattering matrix for retro-reflection is given by [5,17–20]

$$\begin{pmatrix} \mathcal{E}_+ \\ \mathcal{E}_-^* \end{pmatrix}^{\text{out}} = \begin{pmatrix} 0 & -ia(\phi)e^{-i\psi} \\ ia(\phi)e^{i\psi} & 0 \end{pmatrix} \begin{pmatrix} \mathcal{E}_+ \\ \mathcal{E}_-^* \end{pmatrix}^{\text{in}}, \quad (2.6a)$$

$$a(\phi) = [\sqrt{1 + \delta^2} \cotan(\alpha\sqrt{1 + \delta^2}/\cos \phi) + i\delta]^{-1}, \quad (2.6b)$$

$$\alpha = \frac{1}{2}\gamma_0 k_0 L_c. \quad (2.6c)$$

The crucial difference with Ref. [10] is that the reflectance is angle dependent and that the reflection matrix is non-Hermitian. This implies that not all phases will be canceled in the conjugation process. In Fig. 2 we have plotted the reflectance $|a|^2$ as a function of the angle of incidence ϕ for $\alpha = \pi/4$ and two values of $\delta = 0.75$ and 0.9 . The value $\alpha = \pi/4$ is chosen such that $a = 1$ for normal incidence at frequency ω_0 (i.e. for $\phi = 0$, $\delta = 0$). The two values of δ have been chosen such that the angular average of the reflectance,

$$A = \int_0^{\pi/2} d\phi \cos \phi |a(\phi)|^2, \quad (2.7)$$

is > 1 for $\delta = 0.75$ and < 1 for $\delta = 0.9$. (The $\cos \phi$ weight factor in Eq. (2.7) corresponds to diffusive illumination.) In most of the numerical examples throughout this paper we will use these values of α and δ .

III. PHASE-INCOHERENT SOLUTION

A. Radiative transfer theory

Within the framework of radiative transfer theory [13,14], the stationary distribution $I(x, y, \phi) \propto |\mathcal{E}|^2$ of the light intensity, at frequency ω and wavevector $(k \cos \phi, k \sin \phi)$, is governed by the Boltzmann equation

$$\left(l \cos \phi \frac{\partial}{\partial x} + l \sin \phi \frac{\partial}{\partial y} \right) I(x, y, \phi) = -I(x, y, \phi) + \frac{1}{2\pi} \int_0^{2\pi} d\phi' I(x, y, \phi'). \quad (3.1)$$

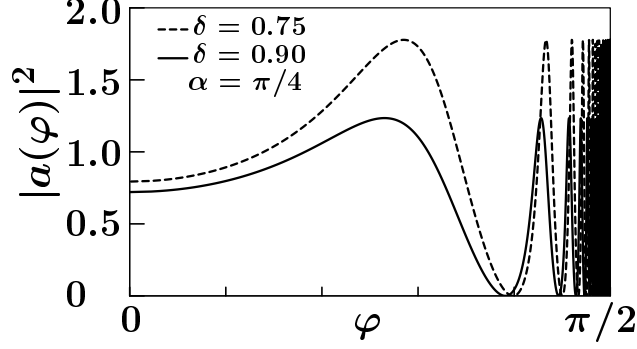

FIG. 2. Reflectance of the phase-conjugating mirror as function of the angle of incidence, computed from Eq. (2.6) for two choices of parameters.

We neglect absorption and assume isotropic scattering in the x - y plane, with mean free path l . The phase-conjugating mirror couples the intensities I_{\pm} of light at the two frequencies $\omega_{\pm} = \omega_0 \pm \Delta\omega$. We assume that l is independent of frequency. The symmetry of the system implies that $I(x, y, \phi) = I(x, |\phi|)$. In this section we take $\phi \in [0, \pi]$. For each frequency the Boltzmann equation takes the form

$$l \cos \phi \frac{\partial I_{\pm}(x, \phi)}{\partial x} = \bar{I}_{\pm}(x) - I_{\pm}(x, \phi), \quad (3.2a)$$

$$\bar{I}_{\pm}(x) = \frac{1}{\pi} \int_0^{\pi} d\phi I_{\pm}(x, \phi). \quad (3.2b)$$

Eq. (3.2) has to be supplemented by boundary conditions at the two ends $x = -L$ and $x = 0$ of the disordered medium. We consider a situation that the system is illuminated at $x = -L$ with diffusive light at frequency ω_+ , hence

$$I_+(-L, \phi) = I_0, \quad \text{for } \cos \phi > 0, \quad (3.3a)$$

$$I_-(-L, \phi) = 0, \quad \text{for } \cos \phi > 0. \quad (3.3b)$$

At $x = 0$ the light is reflected by the phase-conjugating mirror. The intensity is multiplied by

$$|a(\phi)|^2 = \frac{\sin^2(\alpha\sqrt{1+\delta^2}/\cos\phi)}{\delta^2 + \cos^2(\alpha\sqrt{1+\delta^2}/\cos\phi)}, \quad (3.4)$$

according to Eq. (2.6). The reflection is accompanied by a change in frequency $\omega_{\pm} \rightarrow \omega_{\mp}$, so that the boundary condition is

$$I_{\pm}(0, \phi) = |a(\phi)|^2 I_{\mp}(0, \pi - \phi), \quad \text{for } \cos \phi < 0. \quad (3.5)$$

The flux j_{\pm} associated with the intensity I_{\pm} is defined by

$$j_{\pm} = \int_0^{\pi} d\phi \cos \phi I_{\pm}(x, \phi), \quad (3.6)$$

and is independent of x [$\partial j_{\pm}/\partial x = 0$ according to Eq. (3.2)]. The reflectance R_- is defined as the ratio of the outgoing flux at frequency ω_- and the incoming flux at frequency ω_+ ,

$$R_- = -j_-/I_0. \quad (3.7)$$

The total outgoing flux is $(R_- + R_+)I_0$, where

$$R_+ = 1 - j_+/I_0 \quad (3.8)$$

is the ratio of the outgoing flux and the incoming flux at the same frequency ω_+ .

B. Neglect of angular correlations

A simple analytical treatment is possible if the angular correlations between multiple reflections by the disorder and the phase-conjugating mirror are neglected. Here we present this simplified treatment, and in the next subsection we compare with an exact numerical solution of the Boltzmann equation.

We first consider the disordered region by itself. The plane-wave transmission probability $|t(\phi)|^2$ is the ratio of transmitted to incident flux when the incident light is a plane wave in the direction $(\cos \phi, \sin \phi)$. The transmission probability T for diffusive illumination is then given by

$$T = \int_0^{\pi/2} d\phi \cos \phi |t(\phi)|^2, \quad (3.9)$$

such that T is the fraction of the flux incident from a diffusive source which is transmitted through the disordered region. This probability has been calculated in Ref. [21] from the Boltzmann equation (3.2). The result is

$$T = (1 + 2\eta L/\pi l)^{-1}, \quad (3.10)$$

where η is a numerical coefficient which depends weakly on L/l . In the ballistic limit ($L/l \rightarrow 0$) η has the value $\pi^2/8$ and in the diffusive limit ($L/l \rightarrow \infty$) η equals 1. In this subsection (but not in the next) we take $\eta = 1$ for all L/l for simplicity.

We use Eq. (3.10) to obtain the reflectance R_{\pm} for the case that the disordered medium is backed by a phase-conjugating mirror with reflectance

$$A = \int_0^{\pi/2} d\phi \frac{\cos \phi \sin^2(\alpha\sqrt{1 + \delta^2}/\cos \phi)}{\delta^2 + \cos^2(\alpha\sqrt{1 + \delta^2}/\cos \phi)}. \quad (3.11)$$

Since T and A are angular averages, we are neglecting angular correlations. The light that comes out at frequency ω_- has been reflected an odd number of times at the mirror. The light that has been reflected once has traversed the medium twice, which leads to a contribution $T^2 A$ to R_- . Light that has been reflected three times by the mirror contributes $T^2 A^3 (1-T)^2$, since it has been reflected two times by the medium (each time with probability $1 - T$). Summing all contributions, one finds

$$R_- = T^2 A + T^2 A^3 (1 - T)^2 + T^2 A^5 (1 - T)^4 + \dots = \frac{T^2 A}{1 - (1 - T)^2 A^2}. \quad (3.12a)$$

Light that comes out at frequency ω_+ has been reflected an even number of times at the mirror. Zero reflections by the mirror contributes $1 - T$ to R_+ , two reflections contributes $T^2 A^2 (1 - T)$, and four reflections $T^2 A^4 (1 - T)^3$. Summing the series, one finds

$$R_+ = 1 - T + \frac{T^2(1 - T)A^2}{1 - (1 - T)^2 A^2}. \quad (3.12b)$$

The geometric series leading to Eq. (3.12) diverges if $(1 - T)A \geq 1$. This indicates that there is only a stationary solution to the Boltzmann equation if both the gain at the mirror and the scattering in the medium are sufficiently weak. If A is increased at fixed $\alpha = \pi/4$ by reducing δ , the reflectances R_{\pm} diverge when $\delta = \delta_c$. (This divergence is preempted by depletion of the pump beams in the phase-conjugating mirror, which we do not describe.) In the approximation of this subsection, δ_c is determined by $(1 - T)A = 1$, or $L/l = \frac{1}{2}\pi(A - 1)^{-1}$. In the ballistic limit, $T = 1$ and $A < \infty$ for any $\delta > 0$. In the diffusive limit, $T = 0$ and $A = 1$ for $\delta = 0.78$. Hence, δ_c increases from 0 to 0.78 as L/l increases from 0 to ∞ .

C. Exact solution of the Boltzmann equation

The Boltzmann equation (3.2) can be solved exactly, without neglect of angular correlations, by adapting the method of Ref. [21] to an angle-dependent boundary condition. We first rewrite Eq. (3.2) as

$$\frac{\partial}{\partial x} e^{x/l \cos \phi} I_{\pm}(x, \phi) = \frac{1}{l \cos \phi} e^{x/l \cos \phi} \bar{I}_{\pm}(x), \quad (3.13)$$

and then integrate once over x , using the boundary conditions (3.3) and (3.5). The result is

$$I_+(x, \phi) = \int_{-L}^x \frac{dx'}{l \cos \phi} e^{-(x-x')/l \cos \phi} \bar{I}_+(x') + I_0 e^{-(L+x)/l \cos \phi}, \quad \text{for } \cos \phi > 0, \quad (3.14a)$$

$$I_+(x, \phi) = - \int_x^0 \frac{dx'}{l \cos \phi} e^{-(x-x')/l \cos \phi} \bar{I}_+(x') + e^{-x/l \cos \phi} |a(\phi)|^2 I_-(0, \pi - \phi), \quad \text{for } \cos \phi < 0, \quad (3.14b)$$

$$I_-(x, \phi) = \int_{-L}^x \frac{dx'}{l \cos \phi} e^{-(x-x')/l \cos \phi} \bar{I}_-(x'), \quad \text{for } \cos \phi > 0, \quad (3.14c)$$

$$I_-(x, \phi) = - \int_x^0 \frac{dx'}{l \cos \phi} e^{-(x-x')/l \cos \phi} \bar{I}_-(x') + e^{-x/l \cos \phi} |a(\phi)|^2 I_+(0, \pi - \phi), \quad \text{for } \cos \phi < 0. \quad (3.14d)$$

Substitution of Eqs. (3.14c) and (3.14a) into, respectively, Eqs. (3.14b) and (3.14d) yields

$$I_+(x, \phi) = \int_x^0 \frac{dx'}{l |\cos \phi|} e^{-(x'-x)/l |\cos \phi|} \bar{I}_+(x') + e^{x/l |\cos \phi|} |a(\phi)|^2 \times \int_{-L}^0 \frac{dx'}{l |\cos \phi|} e^{x'/l |\cos \phi|} \bar{I}_-(x'), \quad \text{for } \cos \phi < 0, \quad (3.15a)$$

$$I_-(x, \phi) = \int_x^0 \frac{dx'}{l|\cos\phi|} e^{-(x'-x)/l|\cos\phi|} \bar{I}_-(x') + e^{x/l|\cos\phi|} |a(\phi)|^2 \times \left(I_0 e^{-L/l|\cos\phi|} + \int_{-L}^0 \frac{dx'}{l|\cos\phi|} e^{x'/l|\cos\phi|} \bar{I}_+(x') \right), \quad \text{for } \cos\phi < 0. \quad (3.15b)$$

Finally, integration over ϕ leads to two coupled integral equations for the average intensities,

$$\bar{I}_+(x) = \int_{-L}^0 dx' M_1(x, x') \bar{I}_+(x') + \int_{-L}^0 dx' M_2(x, x') \bar{I}_-(x') + Q_1(x) I_0, \quad (3.16a)$$

$$\bar{I}_-(x) = \int_{-L}^0 dx' M_1(x, x') \bar{I}_-(x') + \int_{-L}^0 dx' M_2(x, x') \bar{I}_+(x') + Q_2(x) I_0. \quad (3.16b)$$

We have defined the following kernels and source terms:

$$M_1(x, x') = \frac{1}{\pi} \int_0^{\pi/2} \frac{d\phi}{l \cos\phi} e^{-|x-x'|/l \cos\phi} = \frac{1}{\pi l} K_0(|x-x'|/l), \quad (3.17a)$$

$$M_2(x, x') = \frac{1}{\pi} \int_0^{\pi/2} \frac{d\phi}{l \cos\phi} e^{(x+x')/l \cos\phi} |a(\phi)|^2, \quad (3.17b)$$

$$Q_1(x) = \frac{1}{\pi} \int_0^{\pi/2} d\phi e^{-(L+x)/l \cos\phi}, \quad (3.17c)$$

$$Q_2(x) = \frac{1}{\pi} \int_0^{\pi/2} d\phi e^{-(L-x)/l \cos\phi} |a(\phi)|^2, \quad (3.17d)$$

where K_0 is a Bessel function.

Eq. (3.16) is the analogue for the present problem involving two coupled frequencies of the Schwarzschild-Milne equation in the theory of radiative transfer [13,14]. We have solved it numerically by discretizing with respect to x so that the integral equation becomes a matrix equation. From the average intensities $\bar{I}_\pm(x)$ one finds the intensities $I_\pm(x, \phi)$ using Eqs. (3.14) and (3.15). The reflectances R_\pm then follow from Eqs. (3.6)–(3.8). For numerical stability we have imposed a cut-off on the rapidly oscillating function $a(\phi)$ at grazing incidence, by setting $a(\phi) = 0$ for $0.497\pi < \phi < \frac{1}{2}\pi$.

In Figs. 3 and 4 we show results for $\bar{I}_\pm(x)$ and R_\pm for $\alpha = \pi/4$ and $\delta = 0.75$ and 0.9 . For $\delta = 0.75$ there is an effective gain at the mirror ($A > 1$), while for $\delta = 0.9$ there is an effective loss ($A < 1$). For an ordinary mirror one can show that $\bar{I}_\pm(0) = \frac{1}{2}I_0$. Instead, we find that $\bar{I}_-(0) > \bar{I}_+(0) > \frac{1}{2}I_0$ for $\delta = 0.75$, indicating gain, and $\bar{I}_-(0) < \bar{I}_+(0) < \frac{1}{2}I_0$ for $\delta = 0.9$, indicating loss. In each case the density profiles are approximately linear in the bulk, with some bending near the boundaries at $x = -L$ and $x = 0$. For $\delta = 0.75$, both R_- and R_+ diverge when $L/l = 28$, while for $\delta = 0.9$ no such divergence occurs. As discussed earlier, the divergence indicates that for $\delta = 0.75$ and $L/l > 28$ there is no stationary solution to the Boltzmann equation. For fixed L/l and α , the divergence of R_\pm occurs at a critical value δ_c , such that a stationary solution requires $\delta > \delta_c$. The dependence of δ_c on L/l at fixed $\alpha = \pi/4$ is plotted in Fig. 5.

In Figs. 4 and 5 we also compare the exact numerical solution of the Boltzmann equation of this subsection with the approximate analytical solution (3.12) of the previous subsection. As one can see, the agreement with the exact results is quite good.

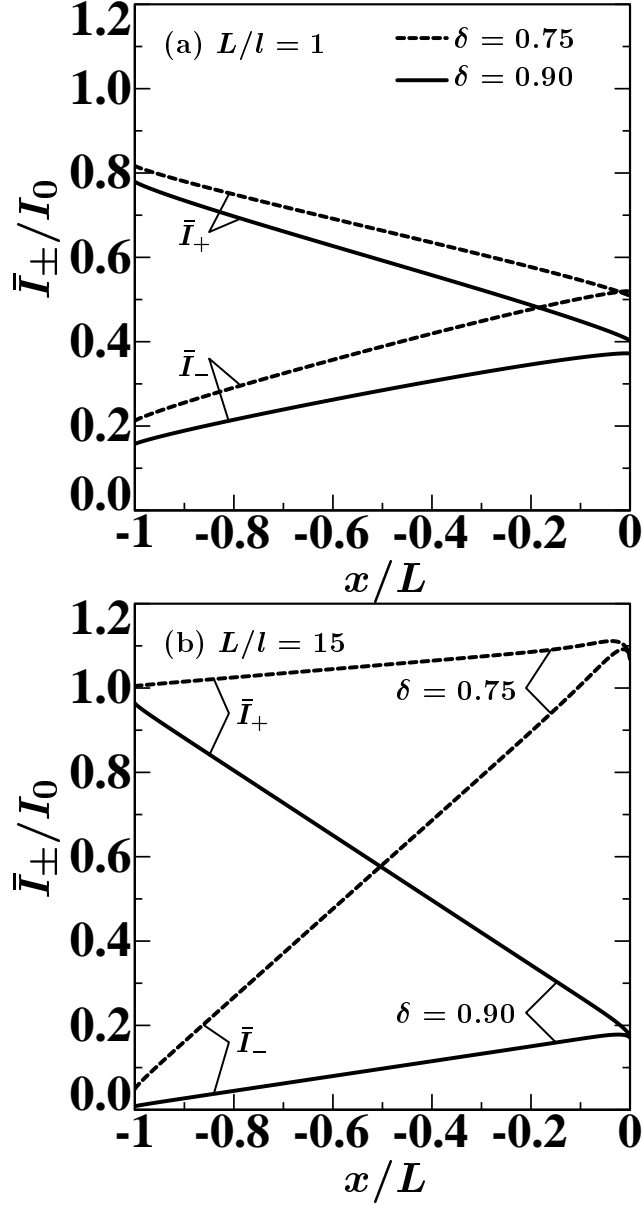

FIG. 3. Intensity profiles in the disordered medium, computed from the exact numerical solution of the Boltzmann equation, for $\alpha = \pi/4$ and two values of δ . (a) is for a nearly ballistic system ($L/l = 1$), (b) is for a diffusive system ($L/l = 15$).

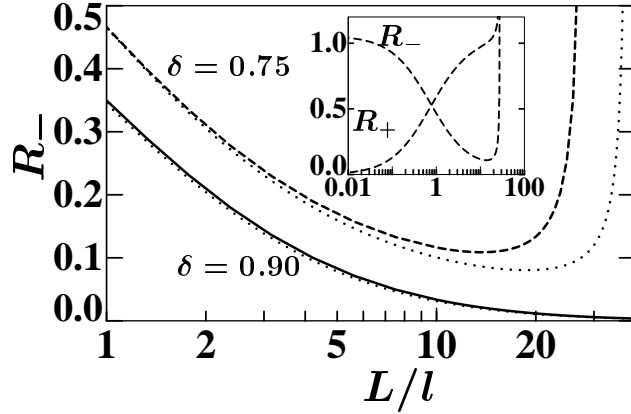

FIG. 4. Reflectance R_- as function of L/l , computed from the exact solution of the Boltzmann equation for $\alpha = \pi/4$ and $\delta = 0.75$ (dashed curve), $\delta = 0.90$ (solid curve). The dotted curves are the approximate result (3.12a), in which angular correlations are neglected. The inset shows the exact reflectances R_{\pm} for $\delta = 0.75$, over a broader range of L/l (logarithmic scale). For $\delta = 0.75$ the reflectances diverge at $L/l = 28$. No divergence occurs for $\delta = 0.90$.

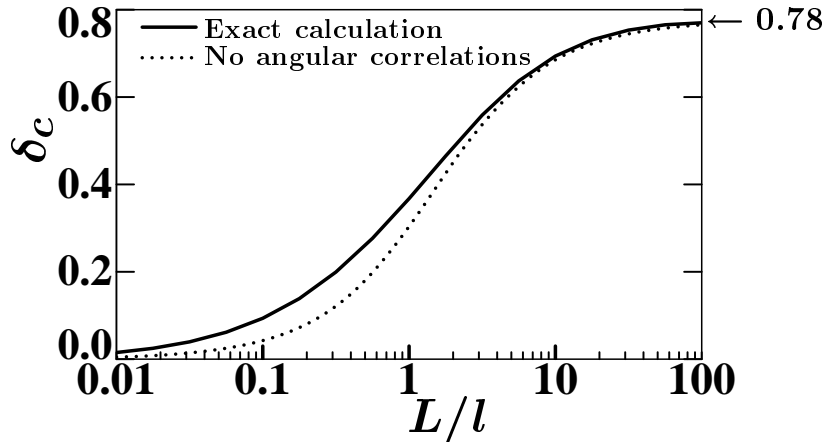

FIG. 5. A stationary solution to the Boltzmann equation requires $\delta > \delta_c$. The solid curve is the exact result for δ_c (at fixed $\alpha = \pi/4$, as function of L/l), the dotted curve follows from Eq. (3.12), obtained by neglecting angular correlations.

IV. PHASE-COHERENT SOLUTION

A. Scattering matrices

We now turn to a phase-coherent description of the scattering problem. To define finite-dimensional scattering matrices we embed the disordered medium in a waveguide (width W), containing $N_{\pm} = \text{Int}(\omega_{\pm}W/c\pi) \gg 1$ propagating modes at frequency ω_{\pm} . A basis of scattering states consists of the complex fields

$$E_{\pm,n}^{>}(x, y, t) = k_{\pm,n}^{-1/2} \sin\left(\frac{n\pi y}{W}\right) \exp(ik_{\pm,n}x - i\omega_{\pm}t), \quad (4.1a)$$

$$E_{\pm,n}^{<}(x, y, t) = k_{\pm,n}^{-1/2} \sin\left(\frac{n\pi y}{W}\right) \exp(-ik_{\pm,n}x - i\omega_{\pm}t). \quad (4.1b)$$

Here $n = 1, 2, \dots, N_{\pm}$ is the mode index and the superscript $>$ ($<$) indicates a wave moving to the right (left), with frequency $\omega_{\pm} = \omega_0 \pm \Delta\omega$ and wavenumber

$$k_{\pm,n} = (\omega_{\pm}^2/c^2 - n^2\pi^2/W^2)^{1/2}. \quad (4.2)$$

The normalization in Eq. (4.1) has been chosen such that each wave carries the same flux.

With respect to the basis (4.1), incoming and outgoing waves are decomposed as

$$E^{\text{in}} = \sum_{n=1}^{N_+} u_{+,n} E_{+,n}^{>} + \sum_{n=1}^{N_-} u_{-,n} E_{-,n}^{>}, \quad (4.3a)$$

$$E^{\text{out}} = \sum_{n=1}^{N_+} v_{+,n} E_{+,n}^{<} + \sum_{n=1}^{N_-} v_{-,n} E_{-,n}^{<}. \quad (4.3b)$$

The complex coefficients are combined into two vectors

$$\mathbf{u} = (u_{+,1}, u_{+,2}, \dots, u_{+,N_+}, u_{-,1}^*, u_{-,2}^*, \dots, u_{-,N_-}^*)^{\text{T}}, \quad (4.4a)$$

$$\mathbf{v} = (v_{+,1}, v_{+,2}, \dots, v_{+,N_+}, v_{-,1}^*, v_{-,2}^*, \dots, v_{-,N_-}^*)^{\text{T}}. \quad (4.4b)$$

The reflection matrix \mathbf{r} relates \mathbf{u} to \mathbf{v} ,

$$\mathbf{v} = \mathbf{r}\mathbf{u}, \quad \mathbf{r} = \begin{pmatrix} \mathbf{r}_{++} & \mathbf{r}_{+-} \\ \mathbf{r}_{-+} & \mathbf{r}_{--} \end{pmatrix}. \quad (4.5)$$

The dimension of \mathbf{r} is $(N_+ + N_-) \times (N_+ + N_-)$, the submatrices $\mathbf{r}_{\pm,\pm}$ have dimensions $N_{\pm} \times N_{\pm}$. For $\Delta\omega \ll \omega_0$ we may neglect the difference between N_+ and N_- and replace both by $N = \text{Int}(k_0W/\pi)$.

In the absence of disorder the reflection matrix is entirely determined by the phase-conjugating mirror,

$$\mathbf{r}_{\text{PCM}} = \begin{pmatrix} 0 & -i\mathbf{a}e^{-i\psi} \\ i\mathbf{a}e^{i\psi} & 0 \end{pmatrix}, \quad (4.6a)$$

$$a_{mn} = a(\phi_n)\delta_{mn}, \quad \phi_n = \arcsin(n\pi/k_0W). \quad (4.6b)$$

The elements of the $N \times N$ diagonal matrix \mathbf{a} are obtained from Eq. (2.6) upon substitution of ϕ by ϕ_n , being the angle of incidence associated with mode n . (The difference in

angle between the two frequencies ω_+ and ω_- can be neglected if $\Delta\omega \ll \omega_0$.) The angular average (2.7) of the reflectance corresponds to the modal average

$$A = \frac{1}{N} \text{Tr } \mathbf{a} \mathbf{a}^\dagger. \quad (4.7)$$

In the limit $N \rightarrow \infty$ the two averages are identical.

The disordered medium in front of the phase-conjugating mirror does not couple ω_+ and ω_- . Its scattering properties at frequency ω are described by two $N \times N$ transmission matrices $\mathbf{t}_{21}(\omega)$ and $\mathbf{t}_{12}(\omega)$ (transmission from left to right and from right to left) plus two $N \times N$ reflection matrices $\mathbf{r}_{11}(\omega)$ and $\mathbf{r}_{22}(\omega)$ (reflection from left to left and from right to right). Taken together, these four matrices constitute a $2N \times 2N$ scattering matrix

$$\mathbf{S}_{\text{disorder}}(\omega) = \begin{pmatrix} \mathbf{r}_{11}(\omega) & \mathbf{t}_{12}(\omega) \\ \mathbf{t}_{21}(\omega) & \mathbf{r}_{22}(\omega) \end{pmatrix}, \quad (4.8)$$

which is unitary (because of flux conservation) and symmetric (because of time-reversal invariance). It is simple algebra to express the scattering matrix \mathbf{r} of the entire system in terms of the scattering matrices \mathbf{r}_{PCM} and $\mathbf{S}_{\text{disorder}}$ of the phase-conjugating mirror and the disordered region separately. The result is

$$\mathbf{r}_{++} = \mathbf{r}_{11}(\omega_+) + \mathbf{t}_{12}(\omega_+) \mathbf{a} \mathbf{r}_{22}^*(\omega_-) \mathbf{a} [1 - \mathbf{r}_{22}(\omega_+) \mathbf{a} \mathbf{r}_{22}^*(\omega_-) \mathbf{a}]^{-1} \mathbf{t}_{21}(\omega_+), \quad (4.9a)$$

$$\mathbf{r}_{--} = \mathbf{r}_{11}^*(\omega_-) + \mathbf{t}_{12}^*(\omega_-) \mathbf{a} \mathbf{r}_{22}(\omega_+) \mathbf{a} [1 - \mathbf{r}_{22}^*(\omega_-) \mathbf{a} \mathbf{r}_{22}(\omega_+) \mathbf{a}]^{-1} \mathbf{t}_{21}^*(\omega_-), \quad (4.9b)$$

$$\mathbf{r}_{-+} = ie^{i\psi} \mathbf{t}_{12}^*(\omega_-) \mathbf{a} [1 - \mathbf{r}_{22}(\omega_+) \mathbf{a} \mathbf{r}_{22}^*(\omega_-) \mathbf{a}]^{-1} \mathbf{t}_{21}(\omega_+), \quad (4.9c)$$

$$\mathbf{r}_{+-} = -ie^{-i\psi} \mathbf{t}_{12}(\omega_+) \mathbf{a} [1 - \mathbf{r}_{22}^*(\omega_-) \mathbf{a} \mathbf{r}_{22}(\omega_+) \mathbf{a}]^{-1} \mathbf{t}_{21}^*(\omega_-). \quad (4.9d)$$

We seek the reflectances

$$R_- = \frac{1}{N_+} \text{Tr } \mathbf{r}_{-+} \mathbf{r}_{-+}^\dagger; \quad R_+ = \frac{1}{N_+} \text{Tr } \mathbf{r}_{++} \mathbf{r}_{++}^\dagger, \quad (4.10)$$

averaged over the disorder. We will do this analytically, using random-matrix theory [22], and numerically, using the recursive Green function technique [23]. We consider two different regimes, depending on the relative magnitude of $\Delta\omega$ and $1/\tau_{\text{dwell}}$, where $\tau_{\text{dwell}} \simeq L^2/cl$ is the mean dwell time of a photon in the disordered medium. If $\tau_{\text{dwell}} \Delta\omega \ll 1$ the difference between $\mathbf{S}_{\text{disorder}}(\omega_+)$ and $\mathbf{S}_{\text{disorder}}(\omega_-)$ is insignificant, because the phase shifts accumulated in a time τ_{dwell} are approximately the same for frequencies ω_+ and ω_- . We call this the *coherent* regime. If $\tau_{\text{dwell}} \Delta\omega \gg 1$, on the contrary, phase shifts at ω_+ and ω_- are essentially uncorrelated, so that $\mathbf{S}_{\text{disorder}}(\omega_+)$ and $\mathbf{S}_{\text{disorder}}(\omega_-)$ are independent. We call this the *incoherent* regime.

B. Random-matrix theory

Without loss of generality the reflection and transmission matrices of the disordered region can be decomposed as [22]

$$\mathbf{r}_{11}(\omega_\pm) = i \mathbf{V}_\pm \sqrt{1 - \mathbf{T}_\pm} \mathbf{V}_\pm^\text{T}, \quad \mathbf{r}_{22}(\omega_\pm) = i \mathbf{U}_\pm \sqrt{1 - \mathbf{T}_\pm} \mathbf{U}_\pm^\text{T}, \quad (4.11a)$$

$$\mathbf{t}_{12}(\omega_\pm) = \mathbf{V}_\pm \sqrt{\mathbf{T}_\pm} \mathbf{U}_\pm^\text{T}, \quad \mathbf{t}_{21}(\omega_\pm) = \mathbf{U}_\pm \sqrt{\mathbf{T}_\pm} \mathbf{V}_\pm^\text{T}. \quad (4.11b)$$

Here \mathbf{U}_\pm and \mathbf{V}_\pm are $N \times N$ unitary matrices (we take $N_+ = N_- = N$ in this subsection) and \mathbf{T}_\pm is a diagonal matrix with the transmission eigenvalues $\tau_{\pm,n} \in [0, 1]$ on the diagonal. The subscript \pm refers to the two frequencies ω_+ and ω_- . In this so-called ‘‘polar decomposition’’ the reflectances R_\pm take the form

$$R_- = \frac{1}{N} \text{Tr} \mathbf{T}_- \mathbf{\Omega} \left(1 - \sqrt{1 - \mathbf{T}_+} \mathbf{\Omega}^T \sqrt{1 - \mathbf{T}_-} \mathbf{\Omega} \right)^{-1} \cdot \mathbf{T}_+ \left(1 - \mathbf{\Omega}^\dagger \sqrt{1 - \mathbf{T}_-} \mathbf{\Omega}^* \sqrt{1 - \mathbf{T}_+} \right)^{-1} \mathbf{\Omega}^\dagger, \quad (4.12a)$$

$$R_+ = \frac{1}{N} \text{Tr} (1 - \mathbf{T}_+) + \frac{1}{N} \text{Tr} \mathbf{T}_+ \mathbf{\Omega}^T \sqrt{1 - \mathbf{T}_-} \mathbf{\Omega} \left(1 - \sqrt{1 - \mathbf{T}_+} \mathbf{\Omega}^T \sqrt{1 - \mathbf{T}_-} \mathbf{\Omega} \right)^{-1} \cdot \mathbf{T}_+ \left(1 - \mathbf{\Omega}^\dagger \sqrt{1 - \mathbf{T}_-} \mathbf{\Omega}^* \sqrt{1 - \mathbf{T}_+} \right)^{-1} \mathbf{\Omega}^\dagger \sqrt{1 - \mathbf{T}_-} \mathbf{\Omega}^* - \frac{1}{N} \text{Tr} \mathbf{T}_+ \sqrt{1 - \mathbf{T}_+} \left(1 - \mathbf{\Omega}^\dagger \sqrt{1 - \mathbf{T}_-} \mathbf{\Omega}^* \sqrt{1 - \mathbf{T}_+} \right)^{-1} \mathbf{\Omega}^\dagger \sqrt{1 - \mathbf{T}_-} \mathbf{\Omega}^* - \frac{1}{N} \text{Tr} \mathbf{T}_+ \sqrt{1 - \mathbf{T}_+} \mathbf{\Omega}^T \sqrt{1 - \mathbf{T}_-} \mathbf{\Omega} \left(1 - \sqrt{1 - \mathbf{T}_+} \mathbf{\Omega}^T \sqrt{1 - \mathbf{T}_-} \mathbf{\Omega} \right)^{-1}, \quad (4.12b)$$

$$\mathbf{\Omega} = \mathbf{U}_-^\dagger \mathbf{a} \mathbf{U}_+. \quad (4.12c)$$

To compute the averages $\langle R_\pm \rangle$ analytically in the large N -limit we make the isotropy approximation [22] that the matrices \mathbf{U}_\pm and \mathbf{V}_\pm are uniformly distributed over the unitary group $\mathcal{U}(N)$. This approximation corresponds to the neglect of angular correlations in the radiative-transfer theory (Sec. III B). For $\tau_{\text{dwell}} \Delta\omega \ll 1$ we may identify $\mathbf{U}_+ = \mathbf{U}_-$ and $\mathbf{V}_+ = \mathbf{V}_-$. For $\tau_{\text{dwell}} \Delta\omega \gg 1$ we may assume that \mathbf{U}_+ , \mathbf{U}_- , \mathbf{V}_+ , and \mathbf{V}_- are all independent. In each case the integration $\int d\mathbf{U} f(\mathbf{U})$ over $\mathcal{U}(N)$ with $N \gg 1$ can be done using the large N -expansion of Ref. [24]. The remaining average over $\tau_{\pm,n}$ can be done using the known density $\rho(\tau)$ of the transmission eigenvalues in a disordered medium [22].

The calculation is easiest in the incoherent regime ($\tau_{\text{dwell}} \Delta\omega \gg 1$). The integration over $\mathcal{U}(N)$ can be carried out using the formula [24]

$$\int d\mathbf{U} \int d\mathbf{V} \frac{1}{N} \text{Tr} (\mathbf{A}_1 \mathbf{U} \mathbf{A}_2 \mathbf{V} \mathbf{A}_3 \mathbf{U} \cdots \mathbf{A}_p) (\mathbf{B}_1 \mathbf{U} \mathbf{B}_2 \mathbf{V} \mathbf{B}_3 \mathbf{U} \cdots \mathbf{B}_q)^\dagger = \delta_{pq} N^{-p} \prod_{i=1}^p \text{Tr} \mathbf{A}_i \mathbf{B}_i^\dagger + \mathcal{O}(N^{-p-1}). \quad (4.13)$$

To apply this formula we expand the inverse matrices in Eq. (4.12) in a power series in \mathbf{U}_\pm and integrate term by term over the independent matrices \mathbf{U}_+ and \mathbf{U}_- . The result is, to leading order in N ,

$$\int d\mathbf{U}_- \int d\mathbf{U}_+ R_- = \sum_{p=0}^{\infty} T_- T_+ A^{2p+1} (1 - T_-)^p (1 - T_+)^p = \frac{T_- T_+ A}{1 - (1 - T_-)(1 - T_+) A^2}, \quad (4.14a)$$

$$\int d\mathbf{U}_- \int d\mathbf{U}_+ R_+ = 1 - T_+ + \frac{T_+^2 (1 - T_-) A^2}{1 - (1 - T_-)(1 - T_+) A^2}, \quad (4.14b)$$

where we have defined the modal average

$$T_{\pm} = \frac{1}{N} \text{Tr } \mathbf{T}_{\pm} = \frac{1}{N} \sum_{n=1}^N \tau_{\pm, n}. \quad (4.15)$$

The modal average A was defined in Eq. (4.7). The quantities T_{\pm} still depend on the configuration of the scatterers, but the fluctuations around the average $\langle T_{\pm} \rangle$ are smaller by an order $1/N$ than the average itself. Moreover, the average $\langle T_{\pm} \rangle$ equals the transmission probability T from radiative transfer theory, Eq. (3.10), again up to corrections of order $1/N$. Replacing T_{\pm} in Eq. (4.14) by T we obtain

$$\langle R_{-} \rangle = \frac{T^2 A}{1 - (1 - T)^2 A^2}, \quad (4.16a)$$

$$\langle R_{+} \rangle = 1 - T + \frac{T^2(1 - T)A^2}{1 - (1 - T)^2 A^2}, \quad (4.16b)$$

which is the result (3.12) of radiative transfer theory with neglect of angular correlations. The conclusion is that in the incoherent regime phase coherence has no effect on the reflectance of the system to leading order in N .

The situation is entirely different in the coherent regime ($\tau_{\text{dwell}} \Delta\omega \ll 1$). To see the difference it is instructive to first consider the simplified model that the matrix $a_{mn} = a_0 \delta_{mn}$ is proportional to the unit matrix (a scalar). Because $\mathbf{U}_{-} = \mathbf{U}_{+}$ for $\tau_{\text{dwell}} \Delta\omega \ll 1$, we then have $\Omega_{mn} = a_0 \delta_{mn}$. There is therefore no average over $\mathcal{U}(N)$ to perform. We only have to average over one set of transmission eigenvalues $\tau_{+, n} = \tau_{-, n} \equiv \tau_n$. This average amounts to the integrals

$$\langle R_{-} \rangle = \frac{1}{N} \int_0^1 d\tau \rho(\tau) \frac{|a_0|^2 \tau^2}{|1 - a_0^2 + a_0^2 \tau|^2}, \quad (4.17a)$$

$$\langle R_{+} \rangle = 1 - \frac{1}{N} \int_0^1 d\tau \rho(\tau) \frac{\tau - |a_0|^4 \tau(1 - \tau)}{|1 - a_0^2 + a_0^2 \tau|^2}. \quad (4.17b)$$

The density $\rho(\tau)$ for $l \lesssim L \ll Nl$ is given by [22]

$$\rho(\tau) = \frac{N}{2(s+1)} \frac{1}{\tau \sqrt{1-\tau}} + \mathcal{O}(s+1)^{-4}, \quad s = \frac{2L}{\pi l}. \quad (4.18)$$

The density has a cut-off for exponentially small τ , which is irrelevant for $\langle R_{\pm} \rangle$ if $a_0^2 \neq 1$. Substitution of Eq. (4.18) into Eq. (4.17) yields the average reflectances

$$\langle R_{-} \rangle = 2T \text{Re} \frac{a_0^*(a_0^2 - 1)}{a_0^2 - a_0^{*2}} \text{artanh } a_0, \quad (4.19a)$$

$$\langle R_{+} \rangle = 1 - 2T \text{Re} \frac{a_0^*(a_0^2 - 1)}{a_0^2 - a_0^{*2}} \text{artanh } a_0^*, \quad (4.19b)$$

where T is again the transmission probability (3.10) from radiative transfer theory. Both quantities have a smooth L -dependence, with $\langle R_{-} \rangle$ decreasing monotonically $\propto 1/L$. In contrast, radiative transfer theory predicts a non-monotonic L -dependence for $A > 1$, leading

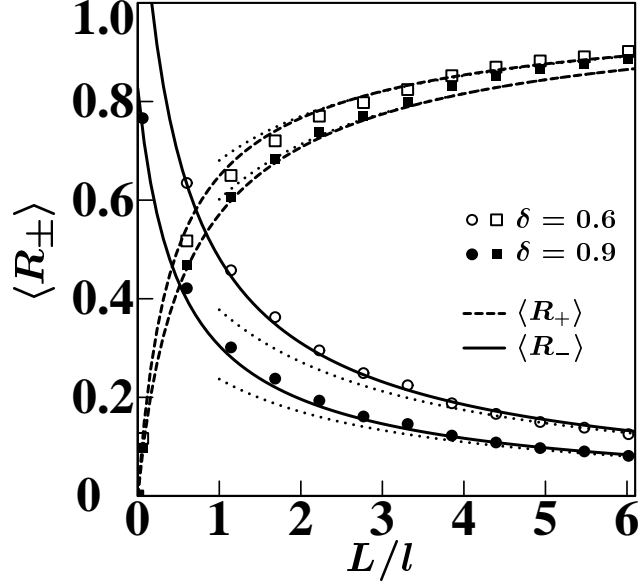

FIG. 6. Average reflectances $\langle R_{\pm} \rangle$ as function of L/l for $\alpha = \pi/4$ and $\delta = 0.6, 0.9$, in the coherent regime. The full curves are the analytical results for $N \gg 1$, computed from Eq. (A18). The dotted curves are the large L/l limit given by Eqs. (4.19) and (4.21). Data points are results from numerical simulations.

to a divergence at some L . For $A < 1$, radiative transfer theory predicts a quadratic decrease of $\langle R_{-} \rangle \propto 1/L^2$, for large L . The conclusion is that, in the coherent regime, phase coherence modifies the reflectance of the phase-conjugating mirror to leading order in N .

The result (4.19) was obtained for the simplified model of a scalar reflection matrix \mathbf{a} . The true \mathbf{a} in Eq. (4.6) is diagonal but not a scalar. This complicates the calculation because $\mathbf{\Omega} = \mathbf{U}^{\dagger} \mathbf{a} \mathbf{U}$ then needs to be averaged over $\mathcal{U}(N)$ even though $\mathbf{U}_{-} = \mathbf{U}_{+}$. The calculation is outlined in App. A. The complete result is a complicated function of L/l (plotted in Fig. 6). For $L/l \gg 1$ the result takes the form of Eq. (4.19), where now a_0 is to be determined from the equation

$$\frac{1}{N} \text{Tr} \frac{\mathbf{a}}{1 - a_0 \mathbf{a}} = \frac{a_0}{1 - a_0^2}. \quad (4.20)$$

In the limit $N \rightarrow \infty$ this becomes an integral equation for a_0 ,

$$\int_0^{\pi/2} d\phi \frac{\cos \phi a(\phi)}{1 - a_0 a(\phi)} = \frac{a_0}{1 - a_0^2}, \quad (4.21)$$

where $a(\phi)$ is given by Eq. (2.6). As shown in Fig. 6, the large- L asymptote (4.19), (4.20) is close to the complete result for $L \gtrsim l$. In the limit $\delta \rightarrow 0$ the solution to Eq. (4.21) is given by $a_0 = 1.284 - 0.0133i$, for $\alpha = \pi/4$. The corresponding reflectances (for $L \gtrsim l$) are $\langle R_{-} \rangle = 61.1 l/L$, and $\langle R_{+} \rangle = 1 + 57.7 l/L$.

To make contact with the work on wave-front reconstruction [11,12], we consider also the case of plane wave — rather than diffusive — illumination. A plane wave incident at frequency ω_{+} in mode n is reflected into modes $m = 1, 2, \dots, N$ at frequency ω_{\pm} with probability $\langle |(\mathbf{r}_{\pm+})_{mn}|^2 \rangle$. The calculation of this probability proceeds similarly as the calculation

of R_- . (See Ref. [25] for the analogous calculation in the case of Andreev reflection.) Using Eqs. (4.9)–(4.12) we can write

$$\mathbf{r}_{-+} = ie^{i\psi} \mathbf{V}_-^* \mathbf{O} \mathbf{V}_+^T, \quad (4.22a)$$

$$\mathbf{O} = \sqrt{\mathbf{T}_- \Omega} (1 - \sqrt{1 - \mathbf{T}_+ \Omega^T} \sqrt{1 - \mathbf{T}_- \Omega})^{-1} \sqrt{\mathbf{T}_+}. \quad (4.22b)$$

For the coherent regime, we may again identify $\mathbf{V}_+ = \mathbf{V}_- = \mathbf{V}$. The integration over $\mathcal{U}(N)$ can be performed using [24]

$$\int d\mathbf{V} V_{nk} V_{mj} V_{ni}^* V_{ml}^* = \frac{1}{N^2 - 1} (\delta_{ik} \delta_{jl} + \delta_{mn} \delta_{kl} \delta_{ji}) - \frac{1}{N^3 - N} (\delta_{kl} \delta_{ji} + \delta_{mn} \delta_{ik} \delta_{jl}). \quad (4.23)$$

We then find

$$\int d\mathbf{V} |(\mathbf{r}_{-+})_{mn}|^2 = \frac{1 + \delta_{mn}}{N + 1} R_- + \frac{N \delta_{mn} - 1}{N^3 - N} \sum_{i \neq j} \mathbf{O}_{ii} \mathbf{O}_{jj}^*. \quad (4.24)$$

In the limit of large N we can write $\sum_{i \neq j} \mathbf{O}_{ii} \mathbf{O}_{jj}^* = |\text{Tr } \mathbf{O}|^2$. In the same way as before, for $L \gg l$, this trace can be expressed in terms of a_0 , where a_0 can be found from Eq. (4.6): $N^{-1} \text{Tr } \mathbf{O} = T \text{artanh } a_0$. The result for the averages is then

$$\langle |(\mathbf{r}_{-+})_{nn}|^2 \rangle = T^2 |\text{artanh } a_0|^2, \quad (4.25a)$$

$$\langle |(\mathbf{r}_{-+})_{mn}|^2 \rangle = N^{-1} \langle R_- \rangle, \quad m \neq n. \quad (4.25b)$$

The incident plane wave is reconstructed with an intensity $\propto T^2$, in agreement with Refs. [11,12]. In the coherent regime, off-diagonal ($m \neq n$) and diagonal ($m = n$) reflection probabilities differ by a large factor of order NT .

In the incoherent regime, the matrices \mathbf{V}_+ and \mathbf{V}_- are independent. Integration over $\mathcal{U}(N)$ results in integrals of the form $\int d\mathbf{V} V_{nk} V_{ni}^* = N^{-1} \delta_{ik}$. Then the off-diagonal and diagonal reflection probabilities are both given by

$$\langle |(\mathbf{r}_{-+})_{mn}|^2 \rangle = N^{-1} \langle R_- \rangle, \quad (4.26)$$

so there is no peak in the reflected intensity at the angle of incidence. This holds for every N and L .

For both the incoherent and the coherent regime we find for the reflection without frequency shift ($\omega_+ \rightarrow \omega_+$) the probability

$$\langle |(\mathbf{r}_{++})_{mn}|^2 \rangle = \frac{1 + \delta_{mn}}{1 + N} \langle R_+ \rangle. \quad (4.27)$$

Here we see a much smaller backscattering peak, where the diagonal reflection probability is only twice as large as the off-diagonal reflection probability [26]. This factor is independent of the phase-conjugating mirror, and exists entirely because of time-reversal symmetry [27].

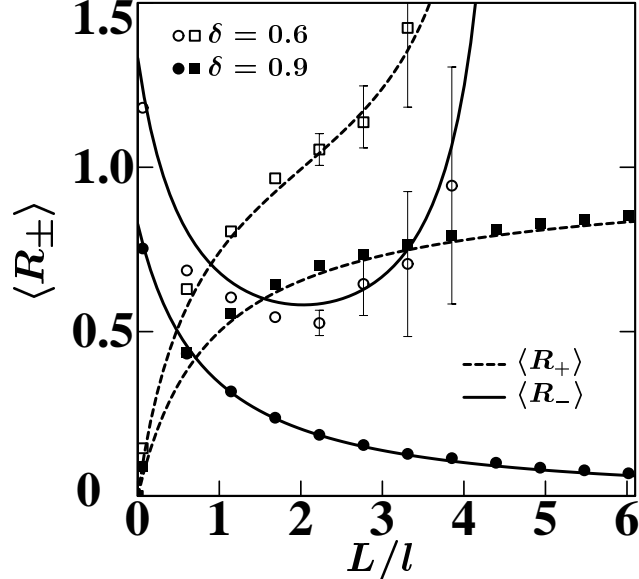

FIG. 7. Average reflectances $\langle R_{\pm} \rangle$ as function of L/l for $\alpha = \pi/4$ and $\delta = 0.6, 0.9$, in the incoherent regime. The curves are the analytical results for $N \gg 1$, computed from Eq. (3.12). Data points are results from numerical simulations. (Statistical error bars are shown when they are larger than the size of the marker.)

C. Numerical simulations

To test the analytical predictions of random-matrix theory we have carried out numerical simulations. The Helmholtz equation,

$$(-\nabla^2 - \varepsilon\omega_{\pm}^2/c^2)\mathcal{E} = 0, \quad (4.28)$$

is discretized on a square lattice (lattice constant d , length L , width W). Disorder is introduced by letting the relative dielectric constant ε fluctuate from site to site between $1 \pm \delta\varepsilon$. Using the method of recursive Green functions [23] we compute the scattering matrix $\mathbf{S}_{\text{disorder}}(\omega)$ of the disordered medium at frequencies ω_+ and ω_- . The reflection matrix \mathbf{r}_{PCM} of the phase-conjugating mirror is calculated by discretizing Eq. (2.2). From $\mathbf{S}_{\text{disorder}}(\omega_{\pm})$ and \mathbf{r}_{PCM} we obtain the reflection matrix \mathbf{r} of the entire system, and hence the reflectances (4.10).

We took $W = 51d$, $\delta\varepsilon = 0.5$, $\alpha = \pi/4$, and varied δ and L . For the coherent case we took $\omega_+ = \omega_- = 1.252c/d$, and for the incoherent case $\omega_+ = 1.252c/d$, $\omega_- = 1.166c/d$. These parameters correspond to $N_+ = 22$, $l_+ = 15.5d$ at frequency ω_+ . The mean free path is determined using Eq. (3.10), which holds up to small corrections of order N^{-1} . In the incoherent case we have $N_- = 20$, $l_- = 20.1d$. This leads to $\Delta\omega = 0.043c/d$ and a dwell time for $L/l \simeq 3$ of $\tau_{\text{dwell}} \simeq L/cl \simeq 150d/c$. Hence we have $\tau_{\text{dwell}}\Delta\omega \simeq 6.5$, which should be well in the incoherent regime. For comparison with random-matrix theory, we take the large N -limit and use the value l_+ for l .

The numerical results are shown in Figs. 6 (coherent regime) and 7 (incoherent regime), for $\delta = 0.6$ and 0.9 . As we can see the agreement with the analytical theory is quite satisfactory. The rapid rise of $\langle R_{\pm} \rangle$ in the incoherent regime for the smallest δ is accompanied by large statistical fluctuations, which make an accurate comparison more difficult. Still, the

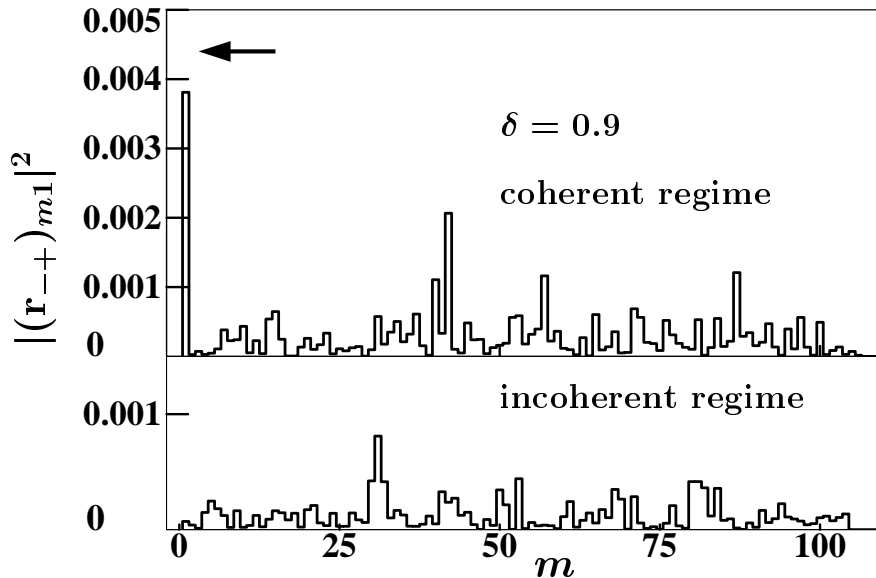

FIG. 8. Histograms for the modal distribution $|(r_{-+})_{m1}|^2$ of the reflection probability with frequency shift for normal incidence. The results are for a single realization of the disorder at $W = L = 251d$ ($L/l = 16.2$), $\alpha = \pi/4$, and $\delta = 0.9$. The arrow indicates the theoretical value $\langle |(r_{-+})_{11}|^2 \rangle$ from Eq. (4.25), representing the ensemble average in the large N -limit.

striking differences between the coherent and incoherent regimes predicted by the random-matrix theory are confirmed by the simulations.

We have also studied the backscattering peak for plane-wave illumination. We considered a square sample ($W = L = 251d$) with $\alpha = \pi/4$, $\delta = 0.9$. We calculated the reflection probabilities $|(r_{-+})_{mn}|^2$ for normal incidence ($n = 1$) in both the coherent and the incoherent regimes. The numerical results for a single realization of the disorder are shown in Fig. 8. The arrow denotes the analytical ensemble average (4.25) of the backscattering peak in the large- N limit, which is consistent with the numerical data. Notice the absence of a backscattering peak in the incoherent regime.

V. COMPARISON WITH ANDREEV REFLECTION

We have studied the reflection of light by a disordered dielectric medium in front of a phase-conjugating mirror. This problem has an electronic analogue [17,18]. The electronic disordered system consists of a metal, in which electron or hole excitations are scattered elastically by randomly placed impurities. Retro-reflection at the phase-conjugating mirror is analogous to Andreev reflection at the interface with a superconductor. The Fermi energy E_F plays the role of the pump frequency ω_0 , while the excitation energy E corresponds to the frequency shift $\Delta\omega$. In spite of these similarities, the optical effects found in this paper have no electronic analogue. It is instructive to see where the analogy breaks down.

To this end we compare the wave equation (2.2) with the Bogoliubov-de Gennes equation [28]

$$\begin{pmatrix} H & \Delta \\ \Delta^* & -H \end{pmatrix} \begin{pmatrix} u \\ v \end{pmatrix} = E \begin{pmatrix} u \\ v \end{pmatrix}, \quad (5.1)$$

which determines the electron and hole wavefunctions u and v . The Hamiltonian

$$H = -\frac{\hbar^2}{2m}\nabla^2 + V - E_F \quad (5.2)$$

contains the electrostatic potential $V(\mathbf{r})$, which plays the role of the dielectric constant. (More precisely, $k_0^2(\varepsilon - 1)$ corresponds to $-(2m/\hbar^2)V$.) The role of the nonlinear susceptibility is played here by the pair potential $\Delta(\mathbf{r})$, which is only nonzero in the superconductor, where it equals $\Delta_0 e^{-i\psi}$. Comparing Eqs. (5.1) and (5.2) for the electronic case with the optical equations (2.2) and (2.4) one notices many similarities, and some differences which amount to a redefinition of quantities. There is however one essential difference: the matrix operator in Eq. (5.1) is Hermitian, while that in Eq. (2.2) is not, because of an extra minus sign in one of the off-diagonal elements. This minus sign is the origin of the difference between Andreev reflection and optical phase conjugation.

In the optical case a disordered medium becomes transparent ($R_- = 1$) [9,10] for unit reflectance at the phase-conjugating mirror ($a = 1$). This does not happen in the electronic case, where R_- is reduced by disorder even for ideal Andreev reflection. The reflection matrix of the normal-metal-superconductor (NS) interface, obtained from Eq. (5.1) for $V \equiv 0$, $E \ll \Delta_0 \ll E_F$, is given by [1]

$$\mathbf{r}_{\text{NS}} = \begin{pmatrix} 0 & -ie^{-i\psi} \\ -ie^{i\psi} & 0 \end{pmatrix}. \quad (5.3)$$

Comparison with Eq. (4.6) for \mathbf{r}_{PCM} shows that Andreev reflection is independent of the angle of incidence; the matrix \mathbf{a} in Eq. (4.6) is replaced by the unit matrix in Eq. (5.3). This is a substantial simplification of the electronic problem, compared with the optical analogue. The matrix \mathbf{r}_{NS} is unitary, in contrast to \mathbf{r}_{PCM} , so that the appearance of gain or loss at the phase-conjugating mirror has no electronic counterpart. The reflectance $R_- = 1 - R_+$ is a monotonically decreasing function of L/l in the electronic case [8], both in the coherent regime,

$$R_- = (2 + 4L/\pi l)^{-1}, \quad \text{if } E \ll \hbar/\tau_{\text{dwell}} \text{ and } L \gtrsim l, \quad (5.4)$$

and in the incoherent regime,

$$R_- = (1 + 4L/\pi l)^{-1}, \quad \text{if } E \gg \hbar/\tau_{\text{dwell}}. \quad (5.5)$$

The result (5.5) is what one obtains from Eq. (3.12) for the case $A = 1$ of unit reflectance at the interface. (The transmittance $T = (1 + 2L/\pi l)^{-1}$ of the disordered medium is the same for electrons and photons.) The result (5.4) however, is *not* what one would expect from the optical analogue. Indeed, Eq. (4.17) with $a_0 = 1$ would give $R_- = 1$ for all L in the case of unit reflectance at the phase-conjugating mirror. The reason that the analogy with Andreev reflection breaks down is the difference of a minus sign in the wave equations (2.2) and (5.1), which reappears in the reflection matrices (4.6) and (5.3) for phase conjugation, and ultimately in the reflectances in the coherent regime:

$$R_- = \frac{1}{N} \text{Tr} \left(\frac{\mathbf{t}\mathbf{t}^\dagger}{1 + \mathbf{r}\mathbf{r}^\dagger} \right)^2 \neq 1 \quad \text{for electrons,} \quad (5.6a)$$

$$R_- = \frac{1}{N} \text{Tr} \left(\frac{\mathbf{t}\mathbf{t}^\dagger}{1 - \mathbf{r}\mathbf{r}^\dagger} \right)^2 = 1 \quad \text{for photons if } \mathbf{a} \equiv 1. \quad (5.6b)$$

Here \mathbf{t} and \mathbf{r} are the transmission and reflection matrices of the disordered medium, which satisfy $\mathbf{t}\mathbf{t}^\dagger + \mathbf{r}\mathbf{r}^\dagger = 1$.

In conclusion, we have shown that the presence of a phase-conjugating mirror behind a random medium drastically changes the total reflected intensity, even when the medium is so disordered that wave-front reconstruction is ineffective. On increasing the frequency difference $\Delta\omega$ between the incident radiation and the pump beams, a *minimum* in the disorder dependence of the reflected intensity appears. In a certain parameter range, the disordered medium reflects less radiation on reducing $\Delta\omega$. Experimental observation of this “darkening” would be a striking demonstration of phase-shift cancellations in a random medium.

ACKNOWLEDGMENTS

This work was supported by the “Stichting voor Fundamenteel Onderzoek der Materie” (FOM) and by the “Nederlandse organisatie voor Wetenschappelijk Onderzoek” (NWO).

APPENDIX A: CALCULATION OF THE REFLECTANCES IN THE COHERENT REGIME

In Sec. IV we computed the average reflectances $\langle R_\pm \rangle$ for the incoherent regime. For the coherent regime we presented only a derivation for scalar reflection matrix \mathbf{a} . This appendix contains the calculation of $\langle R_\pm \rangle$ for arbitrary matrix \mathbf{a} . Our calculation is based on the diagrammatic method for integration over the unitary group of Refs. [29] and [24]. Integrals over the unitary group are needed for the computation of $\langle R_\pm \rangle$ because of the polar decomposition (4.11) of the transmission and reflection matrices. We find it convenient to use a slightly modified version of the diagrammatic technique, in which we apply the diagrammatic rules without making explicit use of the polar decomposition. We first outline the calculation of $\langle R_\pm \rangle$ in which the diagrammatic method is used for the integration of the matrices U and V in Eq. (4.11), and then discuss the modification of the diagrammatic method.

We start the calculation of $\langle R_\pm \rangle$ with the elimination of the reflection matrix $\mathbf{r}_{11}(\omega_0)$ and the transmission matrices $\mathbf{t}_{12}(\omega_0)$ and $\mathbf{t}_{21}(\omega_0)$ from the reflectances R_+ and R_- [cf. Eqs. (4.9) and (4.10)], in favour of the matrix $\mathbf{r} = \mathbf{r}_{22}(\omega_0)$. The result is

$$\langle R_+ \rangle = \frac{1}{N} \text{Tr} [\mathbf{s}'(\mathbf{a}, \mathbf{a}) - \mathbf{s}(1, \mathbf{a}) - \mathbf{s}(\mathbf{a}, 1) + \mathbf{s}'(1, 1) + \mathbf{h}(1) + \mathbf{h}(1)^*], \quad (\text{A1a})$$

$$\langle R_- \rangle = \frac{1}{N} \text{Tr} \{ \mathbf{s}(\mathbf{a}, \mathbf{a}) - \mathbf{s}'(1, \mathbf{a}) - \mathbf{s}'(\mathbf{a}, 1) + \mathbf{s}(1, 1) + \mathbf{a}^{-1} \mathbf{a}^{-1*} [1 - \mathbf{h}(1) - \mathbf{h}(1)^*] \}, \quad (\text{A1b})$$

where we defined

$$\mathbf{s}'(\mathbf{x}, \mathbf{y}) = \langle \mathbf{x}(1 - \mathbf{r}\mathbf{a}\mathbf{r}^*)^{-1} \mathbf{r}\mathbf{y}\mathbf{y}^* \mathbf{r}^* (1 - \mathbf{a}^* \mathbf{r}\mathbf{a}^* \mathbf{r}^*)^{-1} \mathbf{x}^* \rangle, \quad (\text{A2a})$$

$$\mathbf{s}(\mathbf{x}, \mathbf{y}) = \langle \mathbf{x}(1 - \mathbf{r}\mathbf{a}\mathbf{r}^*)^{-1} \mathbf{a}^{-1} \mathbf{y}\mathbf{y}^* \mathbf{a}^{-1*} (1 - \mathbf{a}^* \mathbf{r}\mathbf{a}^* \mathbf{r}^*)^{-1} \mathbf{x}^* \rangle, \quad (\text{A2b})$$

$$\mathbf{h}(\mathbf{x}) = \langle \mathbf{x}(1 - \mathbf{r}\mathbf{a}\mathbf{r}^*)^{-1} \rangle. \quad (\text{A2c})$$

To perform the average over \mathbf{r} , one may use the polar decomposition [cf. Eq. (4.11)]

$$\mathbf{r} = i\mathbf{U}\sqrt{1 - \mathbf{T}\mathbf{U}^T}, \quad (\text{A3})$$

where \mathbf{U} is a unitary matrix and \mathbf{T} is the diagonal matrix containing the N transmission eigenvalues τ_j on the diagonal. The matrix \mathbf{U} is a member of the circular unitary ensemble (CUE), i.e. it is uniformly distributed in the unitary group. The transmission eigenvalues τ_j have density [22]

$$\rho(\tau) = (2N/\pi) \text{Im} U(1/\tau - 1 - i0, s), \quad (\text{A4a})$$

$$U(\zeta, s) = \text{cotanh}[\zeta - sU(\zeta, s)], \quad s = 2L/\pi l. \quad (\text{A4b})$$

To integrate the matrix \mathbf{U} over the unitary group, the matrices \mathbf{s} , \mathbf{s}' , and \mathbf{h} are first expanded as a power series in \mathbf{U} . The integration of \mathbf{U} is then done using the general expression for the average of a polynomial function of \mathbf{U} [30],

$$\langle \mathbf{U}_{a_1 b_1} \dots \mathbf{U}_{a_m b_m} \mathbf{U}_{\alpha_1 \beta_1}^* \dots \mathbf{U}_{\alpha_n \beta_n}^* \rangle = \delta_{m,n} \sum_{P, P'} V_{c_1, \dots, c_k} \prod_{j=1}^n \delta_{a_j, \alpha_{P(j)}} \delta_{b_j, \beta_{P'(j)}}. \quad (\text{A5})$$

Here the summation is over all permutations P and P' of the numbers $1, \dots, n$. The numbers c_1, \dots, c_k denote the *cycle structure* of the permutation $P^{-1}P'$. (The permutation $P^{-1}P'$ can be uniquely written as a product of disjoint cyclic permutations of lengths c_1, \dots, c_k , with $n = \sum_{j=1}^k c_j$.) To compute $\langle R_{\pm} \rangle$ in the limit of large N , it is sufficient to know the coefficients V_{c_1, \dots, c_k} to leading order in N . These are given in Refs. [29] and [24], together with a diagrammatic method which enables one to restrict the summation over P and P' to those permutations P and P' of which the contribution to $\langle R_{\pm} \rangle$ is of maximal order in N .

Although the computation of $\langle R_{\pm} \rangle$ is straightforward now, the actual calculation is rather cumbersome. We find it convenient to modify the approach of Refs. [29] and [24] so that it can be applied directly to the average over the matrix r , without making explicit use of the polar decomposition (A3). This is possible because the general structure (A5) already follows from the invariance of the distribution of \mathbf{U} under transformations

$$\mathbf{U} \rightarrow \mathbf{V}\mathbf{U}\mathbf{V}', \quad (\text{A6})$$

where \mathbf{V} is an arbitrary unitary matrix. The fact that \mathbf{U} itself is unitary is necessary to compute the value of the coefficients V_{c_1, \dots, c_k} , but it is not relevant for the general structure (A5). Since the matrix \mathbf{r} is both unitary and symmetric, its distribution is invariant under transformations

$$\mathbf{r} \rightarrow \mathbf{V}\mathbf{r}\mathbf{V}^T \quad (\text{A7})$$

that respect the symmetry of \mathbf{r} . The same group of transformations leaves invariant the circular orthogonal ensemble (COE), consisting of uniformly distributed unitary and symmetric matrices. A diagrammatic technique for averages over the COE is presented in Ref. [24]. As before, the general structure of the average of a polynomial of a matrix from the COE is entirely determined by the invariance under the transformations (A7), and therefore applies to the reflection matrix \mathbf{r} as well. It reads [24,31]

$$\langle \mathbf{r}_{a_1 a_2} \dots \mathbf{r}_{a_{2n-1} a_{2n}} \mathbf{r}_{\alpha_1 \alpha_2}^* \dots \mathbf{r}_{\alpha_{2m-1} \alpha_{2m}}^* \rangle = \delta_{n,m} \sum_P V_{c_1, \dots, c_k} \prod_{j=1}^{2n} \delta_{a_j, \alpha_{P(j)}}, \quad (\text{A8})$$

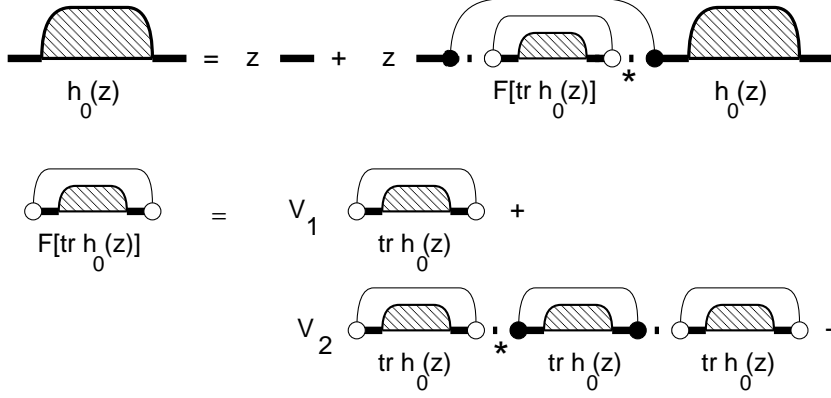

FIG. 9. Diagrams for the calculation of $\mathbf{h}_0(z)$.

where now the summation is over permutations P of the numbers $1, \dots, 2n$. We may write P as

$$P = \left(\prod_{j=1}^n \sigma_j \right) P_e P_o \left(\prod_{j=1}^n \sigma'_j \right), \quad (\text{A9})$$

where the permutations σ_j and σ'_j operate on the numbers $2j-1$ and $2j$, and the permutation P_e (P_o) permutes even (odd) numbers only. The numbers c_1, \dots, c_k in Eq. (A8) are the cycle structure of the permutation $P_e^{-1} P_o$. The specific values of the coefficients V_{c_1, \dots, c_k} for an average of \mathbf{r} are of course different from those for the COE.

Now that we have identified the formal equivalence of an average over the (non-unitary) symmetric reflection matrix r and a unitary symmetric matrix from the COE, we can directly apply the diagrammatic rules of Refs. [29] and [24] to an average over the matrix \mathbf{r} , provided we know the coefficients V_{c_1, \dots, c_k} for the ensemble of reflection matrices r of a disordered waveguide. To find these coefficients, we use the fact that they factorize, to leading order in N ,

$$V_{c_1, \dots, c_k} = \prod_{j=1}^k V_{c_j}, \quad (\text{A10})$$

just as they do for the COE. This follows directly from the fact that, to leading order in N , the average $\langle \prod_j \text{Tr}(\mathbf{r} \mathbf{r}^\dagger)^{c_j} \rangle$ factorizes into $\prod_j \langle \text{Tr}(\mathbf{r} \mathbf{r}^\dagger)^{c_j} \rangle$ [32]. It remains to find the coefficients V_c . Hereto we consider the function

$$\mathbf{h}_0(z) = \left\langle \frac{z}{1 - \mathbf{r} \mathbf{r}^* z^2} \right\rangle. \quad (\text{A11})$$

We first compute $\mathbf{h}_0(z)$ from the diagrammatic technique, with a priori unknown coefficients V_c . We then compare our result with a calculation of $\text{Tr} \mathbf{h}_0(z)$ from the density of transmission eigenvalues (A4). The relevant diagrams for the diagrammatic calculation are shown in Fig. 9 (for a detailed explanation of the diagrammatic notation of Fig. 9, we refer to Ref. [24]). The result is a self-consistency equation for $\mathbf{h}_0(z)$ that involves the generating function F of the coefficients V_c ,

$$\mathbf{h}_0(z) = \frac{z\mathbb{1}}{1 - zF[\text{Tr } \mathbf{h}_0(z)]}, \quad (\text{A12})$$

$$F(x) = \sum_{j=c}^{\infty} V_c x^{2c-1}. \quad (\text{A13})$$

Here $\mathbb{1}$ is the $N \times N$ unit matrix. Direct computation of $\text{Tr } \mathbf{h}_0(z)$ from the density $\rho(\tau)$ of transmission eigenvalues, gives

$$\text{Tr } \mathbf{h}_0(z) = \int_0^1 d\tau \frac{\rho(\tau)z}{1 - z^2(1 - \tau)}. \quad (\text{A14})$$

Together, Eqs. (A10)–(A14) determine the coefficients V_{c_1, \dots, c_k} needed for the diagrammatic evaluation of $\langle R_{\pm} \rangle$. In the limit of $L \rightarrow \infty$, the density of transmission eigenvalues tends to $N\delta(\tau)$. Hence $\mathbf{h}_0(z) = z/(1 - z^2)$ and $F(x) = (\sqrt{N^2 + 4x^2} - N)/2x$. The corresponding coefficients $V_c = c^{-1}N^{1-2c} \binom{2c-2}{c-1}$ are precisely those of the COE [24]. For finite L , the density $\rho(\tau)$ is no longer a delta function, and hence the coefficients V_c deviate from those of the COE.

The fact that we can use the diagrammatic rules directly for the average over r simplifies the calculation considerably. A central role in the calculation is played by the function $\mathbf{h}(\mathbf{x})$ defined in Eq. (A2). The diagrams for the calculation of $\mathbf{h}(\mathbf{x})$ are similar to those of Fig. 9, and the result is a self-consistency equation for $\mathbf{h}(\mathbf{x})$

$$\mathbf{h}(\mathbf{x}) = \mathbf{x}(1 - \mathbf{a}F[\text{Tr } \mathbf{h}(\mathbf{a})])^{-1}, \quad (\text{A15})$$

Notice the formal equivalence with Eq. (A12). The function F was defined in Eq. (A13). Using the diagrammatic technique for the computation of s and s' , we find the linear relations

$$\mathbf{s}(\mathbf{x}, \mathbf{y}) = \mathbf{h}(\mathbf{x}) [\mathbf{a}^{-1}\mathbf{y}\mathbf{y}^*\mathbf{a}^{-1*} + K \text{Tr } \mathbf{s}'(\mathbf{a}, \mathbf{y}) + L \text{Tr } \mathbf{s}(\mathbf{a}, \mathbf{y})] \mathbf{h}(\mathbf{x})^*, \quad (\text{A16a})$$

$$\mathbf{s}'(\mathbf{x}, \mathbf{y}) = \mathbf{h}(\mathbf{x}) [K \text{Tr } \mathbf{s}(\mathbf{a}, \mathbf{y}) + L \text{Tr } \mathbf{s}'(\mathbf{a}, \mathbf{y})] \mathbf{h}(\mathbf{x})^*, \quad (\text{A16b})$$

where we have defined

$$h = \text{Tr } \mathbf{h}(\mathbf{a}), \quad (\text{A17a})$$

$$K = \sum_{i,j=1}^{\infty} V_{i+j-1} h^{2i-2} (h^*)^{2j-2} = \frac{hF(h) - h^*F(h)^*}{h^2 - h^{*2}}, \quad (\text{A17b})$$

$$L = \sum_{i,j=1}^{\infty} V_{i+j} h^{2i-1} (h^*)^{2j-1} = \frac{h^*F(h) - hF(h)^*}{h^2 - h^{*2}}. \quad (\text{A17c})$$

The relevant diagrams leading to Eqs. (A16) and (A17) are shown in Fig. 10. They are similar to those of Ref. [29], where the case of a chaotic cavity was considered, instead of a disordered waveguide. Together, Eqs. (A15)–(A17) form a closed set of equations, from which $\mathbf{s}(\mathbf{x}, \mathbf{y})$, $\mathbf{s}'(\mathbf{x}, \mathbf{y})$, and $\mathbf{h}(\mathbf{x})$ can be calculated. The average reflectances $\langle R_{\pm} \rangle$ are obtained upon substitution of $\mathbf{s}(\mathbf{x}, \mathbf{y})$, $\mathbf{s}'(\mathbf{x}, \mathbf{y})$, and $\mathbf{h}(\mathbf{x})$ into Eq. (A1). The final result is expressed as a function of $h = \text{Tr } \mathbf{h}(\mathbf{a})$,

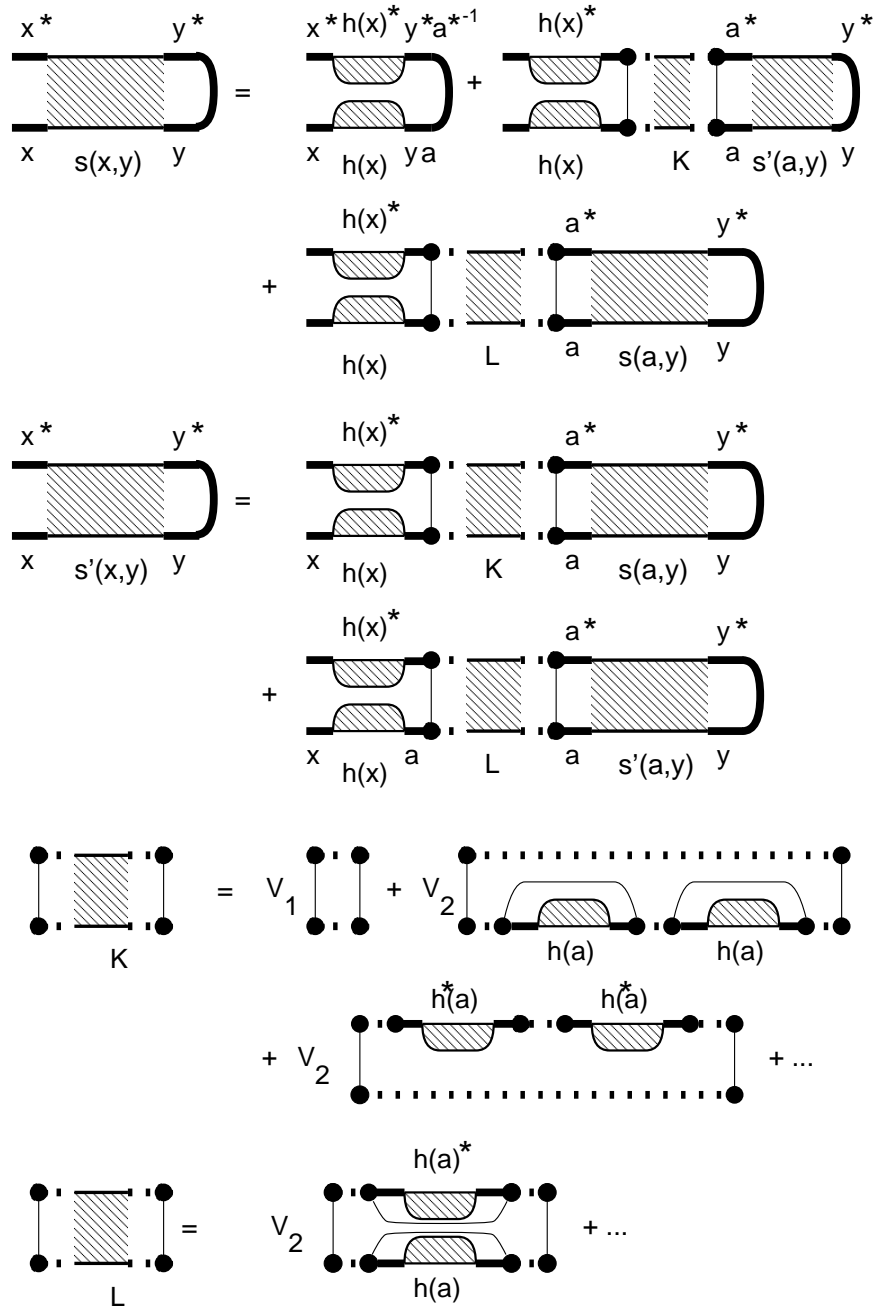

FIG. 10. Diagrams for the calculation of $s(x, y)$ and $s'(x, y)$.

$$N\langle R_+ \rangle = \frac{(I^2 + J^2)K - 2J(1 - IL)}{(1 - IL)^2 - (KI)^2} + 2\text{Re Tr}[1 - \mathbf{a}F(h)]^{-1}, \quad (\text{A18a})$$

$$N\langle R_- \rangle = \frac{(I + LJ^2)(1 - IL) + KIJ(KI - 2)}{(1 - IL)^2 - (KI)^2} + J|F(h)|^2, \quad (\text{A18b})$$

where we defined

$$I = \text{Tr} \mathbf{a}(1 - \mathbf{a}F(h))^{-1}(1 - \mathbf{a}^*F(h)^*)^{-1}\mathbf{a}^*, \quad (\text{A19a})$$

$$J = \text{Tr} (1 - \mathbf{a}F(h))^{-1}(1 - \mathbf{a}^*F(h))^{-1}. \quad (\text{A19b})$$

These expressions simplify in the large L/l -limit, when $\rho(\tau)$ takes the form (4.18). Substitution in Eq. (A14) gives

$$\text{Tr} \mathbf{h}_0(z) = \frac{Nz}{1 - z^2} \left(1 - \frac{z \text{artanh } z}{1 + s} \right) + \mathcal{O}(1 + s)^2, \quad s = 2L/\pi l. \quad (\text{A20})$$

and hence allows us to find $F(z)$ from Eq. (A12). Expanding the expressions (A18) for $\langle R_\pm \rangle$ and the self-consistency equation (A15) to lowest order in $(1 + s)^{-1}$ we find the results (4.19) and (4.20), with the effective reflectance $a_0 = z$.

REFERENCES

- [1] A. F. Andreev, Zh. Eksp. Teor. Fiz. **46**, 1823 (1964); **49**, 655 (1965) [Sov. Phys. JETP **19**, 1228 (1964); **22**, 455 (1966)].
- [2] J. P. Woerdman, Optics Comm. **2**, 212 (1970).
- [3] B. I. Stepanov, E. V. Ivakin, and A. S. Rubanov, Dokl. Akad. Nauk USSR **196**, 567 (1971) [Sov. Phys. Dokl. **16**, 46 (1971)].
- [4] A. A. Abrikosov, *Fundamentals of the Theory of Metals* (North-Holland, Amsterdam, 1988).
- [5] R. A. Fisher, editor, *Optical Phase Conjugation* (Academic, New York, 1983).
- [6] B. Ya. Zel'dovich, N. F. Pilipetskiĭ, and V. V. Shkunov, *Principles of Phase Conjugation* (Springer, Berlin, 1985).
- [7] D. M. Pepper, Sci. Am. **254** (1), 56 (1986).
- [8] C. W. J. Beenakker, in: *Mesoscopic Quantum Physics*, edited by E. Akkermans, G. Montambaux, J.-L. Pichard, and J. Zinn-Justin (North-Holland, Amsterdam, 1995).
- [9] Yu. N. Barabanenkov, Yu. A. Kravtsov, V. D. Ozrin, and A. I. Saichev, in: *Progress in Optics XXIX*, edited by E. Wolf (North-Holland, Amsterdam, 1991).
- [10] R. Mittra and T. M. Habashy, J. Opt. Soc. Am. A **1**, 1103 (1984).
- [11] I. McMichael, M. D. Ewbank, and F. Vachss, Optics Comm. **119**, 13 (1995).
- [12] C. Gu and P. Yeh, Optics Comm. **107**, 353 (1994).
- [13] S. Chandrasekhar, *Radiative Transfer* (Dover, New York, 1960).
- [14] A. Ishimaru, *Wave Propagation and Scattering in Random Media* (Academic, New York, 1978).
- [15] J. C. J. Paasschens, P. W. Brouwer, and C. W. J. Beenakker, Europhys. Lett. (to be published).
- [16] I. Freund, M. Rosenbluh, R. Berkovits, and M. Kaveh, Phys. Rev. Lett. **61**, 1214 (1988); M. I. Mishchenko, J. M. Dlugach, and E. G. Yanovitskij, J. Quant. Spectrosc. Radiat. Transfer **47**, 401 (1992).
- [17] D. Lenstra, in: *Huygens Principle 1690–1990; Theory and Applications*, edited by H. Blok, H. A. Ferweda, and H. K. Kuiken (North-Holland, Amsterdam 1990).
- [18] H. van Houten and C. W. J. Beenakker, Physica B **175**, 187 (1991).
- [19] A. Yariv and D. M. Pepper, Opt. Lett. **1**, 16 (1977).
- [20] H. F. Arnoldus and T. F. George, J. Mod. Opt. **36**, 31 (1989).
- [21] M. J. M. de Jong, Phys. Rev. B **49**, 7778 (1994).
- [22] Two reviews of the random-matrix theory of phase-coherent scattering are: A. D. Stone, P. A. Mello, K. A. Muttalib, and J.-L. Pichard, in: *Mesoscopic Phenomena in Solids*, edited by B. L. Altshuler, P. A. Lee, and R. A. Webb (North-Holland, Amsterdam, 1991); C. W. J. Beenakker, Rev. Mod. Phys., (July, 1997).
- [23] H. U. Baranger, D. P. DiVincenzo, R. A. Jalabert, and A. D. Stone, Phys. Rev. B **44**, 10637 (1991).
- [24] P. W. Brouwer and C. W. J. Beenakker, J. Math. Phys. **37**, 4904 (1996).
- [25] C. W. J. Beenakker, J. A. Melsen, and P. W. Brouwer, Phys. Rev. B **51**, 13882 (1995).
- [26] P. A. Mello, E. Akkermans, and B. Shapiro, Phys. Rev. Lett. **61**, 459 (1988).
- [27] G. Bergmann, Phys. Rep. **107**, 1 (1984).
- [28] P. G. de Gennes, *Superconductivity of Metals and Alloys* (Benjamin, New York, 1966).
- [29] N. Argaman and A. Zee, Phys. Rev. B **54**, 7406 (1996).

- [30] S. Samuel, J. Math. Phys. **21**, 2695 (1980).
- [31] P. A. Mello and T. H. Seligman, Nucl. Phys. A **344**, 489 (1980).
- [32] P. A. Mello and A. D. Stone, Phys. Rev. B **44**, 3559 (1991).