

# The physics of space and time I: The description of rulers and clocks in uniform translational motion by Galilean or Lorentz transformations

**J.H.Field**

Département de Physique Nucléaire et Corpusculaire Université de Genève . 24, quai Ernest-Ansermet CH-1211 Genève 4.

E-mail: john.field@cern.ch

## **Abstract**

A calculus based on pointer-mark coincidences is proposed to define, in a mathematically rigorous way, measurements of space and time intervals. The connection between such measurements in different inertial frames according to the Galilean or Lorentz transformations is then studied using new, simple, and practical clock synchronisation procedures. It is found that measured length intervals are Lorentz invariant, whereas moving clocks show a universal time dilation effect. The ‘relativistic length contraction’ and ‘relativity of simultaneity’ effects of conventional special relativity theory are shown to be the consequence of calculational error. Two derivations of the Lorentz transformation from simple postulates, without reference to electrodynamics or any other dynamical theory, are reviewed in an appendix.

PACS 03.30.+p

# 1 Introduction

The historical development of Special Relativity (SR), which may be defined as the physical theory of space and time, in the absence of gravitational effects, was intimately connected during the second half of the 19th Century with that of classical electrodynamics. The transformation of time and of transverse spatial coordinates was proposed by Voigt [1] in order to leave invariant the form of the wave equation in different inertial frames. Subsequently, first Larmor [2], and later Lorentz proposed [3] a similar transformation of time, as well as a transformation of the longitudinal spatial coordinate, to obtain a similar invariance of the free-space Maxwell Equations<sup>1</sup>. This close connection has persisted in text-book presentations of SR until the present day. An example is the emphasis that is still placed, following Einstein's seminal paper [5], on the space-time properties of 'light signals', 'light waves' and, in particular Einstein's light-signal synchronisation procedure, when deriving or discussing the space-time Lorentz Transformation (LT). The latter, with the aid of the further definitions of relativistic velocity, momentum and energy (see Section 7 below) enable all the kinematical predictions of SR to be derived.

The aim of the present paper is to present the space-time LT—which is the essence of SR—in a completely new light, without any reference to electrodynamics or any other dynamical theory. In particular, two aspects are discussed. The first is the axiomatic basis of the LT. This is done, in a general way, below, in the present section, where some sets of postulates, from which the LT may be derived, are presented and motivated, and in more detail in the Appendix where two previously published [6, 7] derivations of the LT are reviewed. The second and more novel aspect of this paper is a careful application of the Galilean Transformation (GT) or the LT to measurements of space and time intervals performed, with the aid of rulers and clocks, in different inertial frames. Important for this discussion are, firstly, the method by which space and time intervals are experimentally determined, and secondly, synchronisation procedures for spatially separated clocks in the same, or different, inertial frames. The procedures proposed avoid completely the 'conventionality' [12] associated with the Einstein light signal method [5] and the subsequent necessity of postulating, in SR, the spatial isotropy of the speed of light.

The present study provides a simple and clear explanation for the shortcomings in the current physical interpretation of the space-time LT that have been pointed out, from a different point-of-view in a previous paper [8] by the present author. In fact the 'relativity of simultaneity' and 'length contraction' effects of SR, for which, unlike time dilation, no experimental evidence exists [8], are found to be illusory—the consequence of a trivial mathematical error in the description of synchronised clocks by the LT equations.

Since the first version of the present paper was completed, but not released, in late 2005, a number of short papers have been written by the present author explaining in either a logically concise [9] or in a pedagogical [10, 11] manner the conclusions of Ref. [8]

---

<sup>1</sup>It is difficult to understand why Larmor's work, published in 1900, was not cited in Lorentz' 1904 paper where identical transformation equations were given. See Ref. [4] for a discussion of priority issues related to the discovery of the Lorentz Transformation.

and the present paper.

Some postulates which may be used to derive the LT are now presented and briefly discussed. In his original special relativity paper [5], Einstein explicitly stated<sup>2</sup> two postulates, (E1) and (E2) from which he proceeded to his derivation of the space-time LT. These were:

**(E1) The dynamical laws of nature are the same in any inertial frame.**

**(E2) The speed of light is the same in any inertial frame, and is independent of whether the source is stationary or in motion<sup>3</sup>.**

The postulate (E1), the ‘Special Relativity Principle’, was not new. Indeed it is equally valid in pre-relativistic Newtonian mechanics, and had been clearly stated [14] already by Galileo. The second postulate, (E2), is highly counter-intuitive. Common sense would suggest that if light is of a corpuscular nature, as imagined by Newton, the speed of a particle of light would be expected to be greater, if the source moves in the same direction as its motion, and smaller, if it moves in the opposite direction, than light emitted from a source at rest. If, on the other hand, it is supposed that light is some kind of wave motion, as was generally assumed in the second half of the 19th Century, it is expected that some kind of preferred frame will exist—that of the medium supporting the wave motion that is identified with light—the ‘luminiferous aether’. In this case the speed of light is expected to be different for observers with different velocities relative to the aether frame.

However, it was very soon realised that the postulate (E2) is not necessary to derive the LT. Indeed, already as early as 1910, Ignatowsky [15] published a derivation of the LT which (although the postulates on which it is based are not explicitly stated) is similar, in its essential features, to the first derivation of the LT presented in the Appendix of the present paper. That the postulate (E2) is not necessary to derive the LT was pointed out by Pauli in the monograph on relativity [16] that he wrote in 1921. At the time of this writing, the literature on derivations of the LT *not* using postulate (E2) is vast. A partial list up until 1968 can be found in a paper by Berzi and Gorini [13]. A survey of the more recent literature is given in the paper [6] by the present author.

These ‘lightless’ derivations of the LT can be divided into two broad categories:

- (i) Those in which the postulate (E2) is replaced by some other ‘strong’ kinematical consequence of the LT such as conservation of relativistic transverse momentum or relativistic ‘mass increase’.
- (ii) Those in which the minimum number of, and only very weak, postulates are employed.

---

<sup>2</sup>There are also several other postulates that are tacitly assumed, such as linearity of the equations, spatial isotropy and the Reciprocity Principle [13] which is discussed in the Appendix of the present paper. For more details see Reference [6].

<sup>3</sup>Actually, Einstein did not explicitly state in his second postulate that the speed of light is the same in all inertial frames, only that it is independent of the motion of its source. The constancy of the speed of light was considered to be a ‘law of nature’, and so a particular case of the postulate E1.

Examples of derivations of type (ii) may be found in Refs. [17, 18, 19, 20] and Refs. [6, 7] by the present author. For the reader's convenience, the essential features of two latter derivations are recalled in the Appendix of the present paper. The postulates used in these derivations are the following:

**(A) Each Lorentz Transformation equation must be a single-valued function of all its arguments.**

**(B) Reciprocal space-time measurements of similar rulers and clocks at rest in two different inertial frames S, S', by observers at rest in S', S respectively, yield identical results.**

**(C) The equations describing the laws of physics are invariant with respect to the exchange of space and time coordinates or, more generally, with respect to the exchange of spatial and temporal components of 4-vectors.**

The postulate (B) is a generalisation of Pauli's postulate (c)<sup>4</sup> [16].

The derivation of Ref. [6] is based on (A) and (B), that of Ref. [7] on (A) and (C). These postulates alone are sufficient to derive the LT for space and time intervals along the common  $x, x'$  axis of two inertial frames S and S' in relative motion parallel to this axis. The additional postulate of spatial isotropy is needed for the transformation of events lying outside the  $x, x'$  axis.

It is interesting to compare the postulates (A), (B) and (C) with the Einstein postulates (E1) and (E2). (A) and (C) are essentially mathematical statements about the structure of physical equations but make no reference to any dynamical or kinematical laws of physics.

The meaning of postulate (A) is that, if the LT equations are written as

$$f_x(x', x, \tau, v) = 0, \quad f_t(t', x, \tau, v) = 0$$

where  $\tau$  and  $t'$  are times recorded by observers at rest in S of clocks at rest in S and S' respectively, and  $v$  is the velocity of S' relative to S along the  $x, x'$  axis, the solution for  $\alpha_1$ , given  $\alpha_2$  and  $\alpha_3$  must be a single valued function of  $\alpha_2$  and  $\alpha_3$ . Here,  $\alpha_1, \alpha_2$  and  $\alpha_3$  are any permutation of  $x', x$  and  $\tau$  for  $f_x$  and of  $t', x$  and  $\tau$  for  $f_t$ . A sufficient condition for this is that  $f_x$  and  $f_t$  be multilinear functions of their arguments. The physical basis of the postulate (A) is very obvious: One, and only one, event  $(x', t')$  can exist in S' for each event  $(x, \tau)$  in S.

The postulate (C) makes a much more specific and powerful statement about the structure of physical equations but makes no reference, unlike (B), to inertial frames or the results of space-time measurements performed in these frames. Still, in combination with the weaker (but still purely mathematical) postulate (A) it is sufficient to derive the LT.

The postulate (B), which was termed the 'Kinematic Special Relativity Postulate' or

---

<sup>4</sup>This postulate states that, in the notation of the present paper, "the contraction of lengths at rest in S' and observed in S is equal to the contraction of lengths at rest in S and observed in S'".

KSRP in Refs.[6, 7], but would be more properly called the ‘Measurement Reciprocity Postulate’, or MRP, may seem obvious to some readers. Indeed, it is often tacitly assumed to hold in derivations of the LT. This was effectively done in Einstein’s original derivation. However, as will be demonstrated below, only kinematical definitions and pure logic are needed to show that Einstein’s counter-intuitive postulate (E2) is a necessary consequence of the ‘obvious’ postulates (A) and (B).

All of the physical consequences of SR can be derived from the space-time LT, either directly, by applying them to space or time measurements performed in different inertial frames, as discussed in detail below in the present paper, or by using them to define the transformation properties of other quantities of physical interest. However, to *derive* the LT only the weak and ‘self apparent’ postulates (A) and (B) are necessary.

Given the title of Einstein’s original SR paper ‘On the Electrodynamics of Moving Bodies’ and that of Poincaré’s SR paper [21] published in the following year ‘On the Dynamics of the Electron’ what then is the essential connection between electrodynamics and the fundamental physics of SR? The perhaps surprising, but simple, answer is: ‘None’. The properties of space and time (actually because the subject here is physics, those of *measurements* of space and time) underlie and take precedence over any dynamical aspect of physics, with the possible exception of the general relativistic theory of gravitation, which is not considered here. These properties may be compared to a canvas on which the electromagnetic, weak and strong interactions paint the picture that we perceive as the physical world. Paint is not needed to make canvas. The subject of this paper is just the canvas, that is, the physics of space and time intervals as measured in different inertial frames in the absence of gravitational effects.

Spatial intervals are measured by rulers and temporal intervals by clocks. Therefore the subject of the present paper reduces essentially to a study of the *modus operandi* of rulers and clocks as measuring instruments. The important problem of synchronisation of spatially-separated clocks is addressed from scratch. A simple procedure of master clock synchronisation (synchronisation by ‘pointer transport’) is suggested to synchronise an arbitrary number of spatially separated clocks in a given inertial frame. An equally simple method (synchronisation by ‘length transport’) that may be used to synchronise an arbitrary number of spatially separated clocks in the same, or different, inertial frames is also proposed. When this is done, it is seen that measurements of the space intervals between stationary objects, or of objects moving with the same velocity, are the same whether the GT or the LT is used. The measured spatial separation of any two such objects, or equivalently the length of a ruler, is a Lorentz invariant quantity —it is independent of the frame in which it is measured. There is no relativistic ‘length contraction’. Uniformly moving clocks all appear to run slow according to the time dilation factor  $\sqrt{1 - (v/c)^2}$ , but all synchronised clocks in any inertial frame show the same time, as viewed from any other inertial frame —there is no ‘relativity of simultaneity’ in this case.

The structure of this paper is as follows: In the following section the measurement of space and time intervals is discussed at a fundamental level, where each measurement is identified with a spatial pointer-mark coincidence. The equivalence of the physical concept of time with that of uniform motion, or cyclic motion of constant period, is stressed. In Sections 3 and 4 the the pointer transport and length transport synchronisation methods,

respectively, are presented. In Section 5 the relation of space and time measurements in different inertial frames is considered. The different predictions of the GT and the LT are compared and contrasted. Section 6 explains the spurious and unphysical nature of the related ‘relativity of simultaneity’ and ‘relativistic length contraction’ effects of conventional special relativity theory. It is shown in Section 7 how Einstein’s second postulate (E2) is a consequence of indentifying light with massless particles —photons. Section 8 contains a summary and a brief discussion of the impact of the conclusions of the present paper and Ref. [8] on other aspects of SR.

## 2 The measurement of space and time intervals

The equations of physics contain symbols representing quantities at many different levels of mathematical abstraction from those representing the raw data of any experiment. However, in order to provide meaningful predictions for the result of any experiment, the mathematical expression of any physical theory must contain, at least, symbols in exact correspondence with experimental raw data. Only in this way is it possible to compare theory and experiment. Particularly for space and time measurements, great care must be taken to ensure this exact correspondence between raw data and the theoretical symbols that represent them. The raw data itself however has a very simple and universal form. As succinctly stated in Ref. [22]:

However, every experiment in physics in which measurement plays a part reduces essentially to an operation involving the observation of the coincidence of a point or pointer with a mark on some scale, or the comparison of sets of such coincidences; and the symbolic expression of the observation is made by means of numbers associated with the marks.

This procedure evidently applies to the measurement of the length of an object or the distance between two objects, but, as will be seen, it applies equally to the measurement of time intervals —that is the raw data of time measurements can always be expressed in terms of the measurement of some corresponding spatial interval. For time measurements the concept of local Pointer-Mark Coincidences, denoted in the following, for brevity, as PMC, is therefore equally important.

In Einstein’s first paper on special relativity [5] can be found the following important statement concerning the measurement of time:

We have to take into account that all our judgements in which time plays a part are always judgements of *simultaneous events*. If, for instance, I say ‘‘That train arrives here at 7 o’clock’’, I mean something like this: ‘‘The pointing of the small hand of my watch to 7 and the arrival of the train are simultaneous events’’.

Observation of the time of arrival of the train then requires the simultaneous occurrence of the two following PMC:

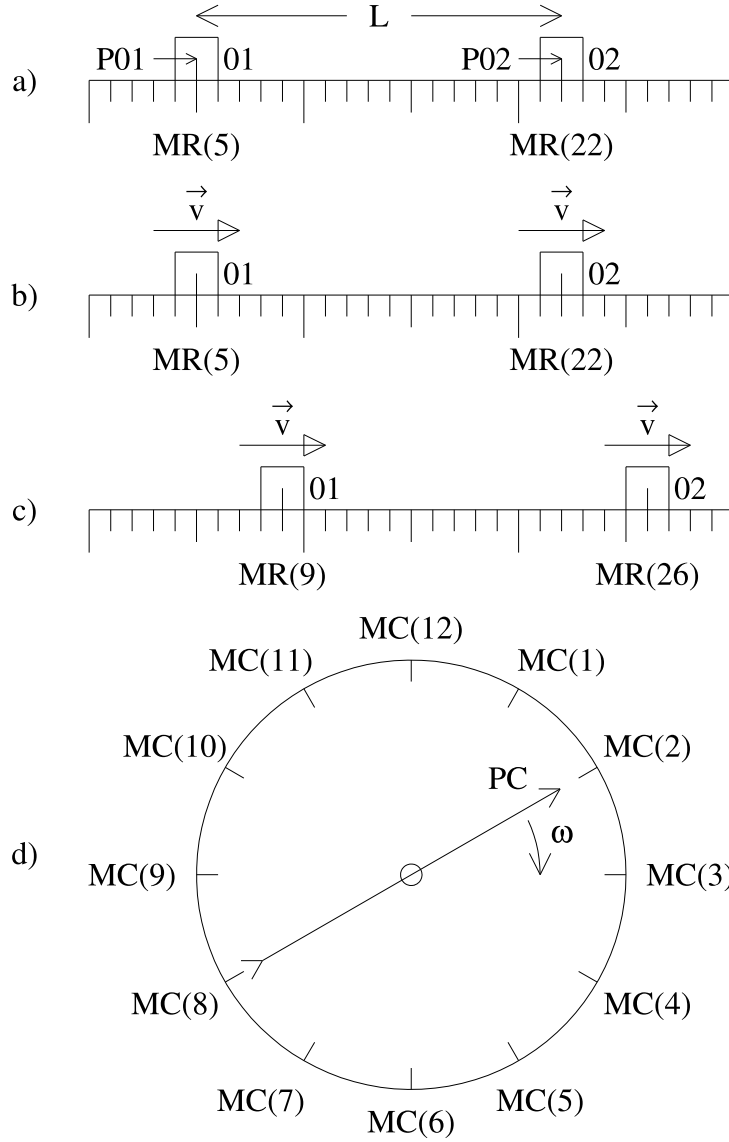

Figure 1: a) Measurement of the distance,  $L$ , between two objects  $O1, O2$ , at rest, by a ruler. The pointers  $P01, P02$  on the objects are in spatial coincidence with the ruler marks  $MR(5)$  and  $MR(22)$ . The times of the corresponding PMC:  $P01@MR(5)$  and  $P02@MR(22)$  are arbitrary. b), c) measurements of the distance between the same two objects when they are both moving parallel to the ruler with the same uniform velocity,  $v$ . The corresponding PMCs:  $P01@MR(5)$  and  $P02@MR(22)$  in b) and  $P01@MR(9)$  and  $P02@MR(26)$  in c) must be simultaneous in each case. d) Time measurement by an analogue clock in terms of the PMC between the hand, constituting a time-dependent pointer  $PC$ , and the uniformly spaced marks  $MC(1) - MC(12)$ . The hand rotates with constant angular velocity  $\omega$ .

- (i) Of a pointer on the train with a mark on the platform at the same position as the observer with the watch.
- (ii) Of the pointer constituted by the small hand of the watch with the mark corresponding to ‘7 hours’ on the dial of the watch.

In order to specify, in a precise mathematical manner, the raw data of space and time measurements in the following (which definitions must be rigorously respected by the symbols of the theory of space and time) a symbolism for pointers, marks and pointer-mark coincidences is now introduced. The spatial coincidence of a pointer, P, with a mark, M, at time, t, defines a PMC at time t :  $PMC(t) \equiv P(t)@M$ . As indicated, pointers are usually (but not necessarily) time dependent whereas marks are time-independent and in one-to-one coincidence, in an obvious way, with numbers that represent Cartesian or angular coordinates. Simple examples are the marks on a ruler or on the dial of an analogue clock.

Einstein’s measurement of the arrival of a train at 7 o’clock at Bern station is then expressed symbolically as follows:

$$PMCT(t_T) \equiv PT(t_T)@MP, \quad PMCWH(t_T) \equiv PWH(t_T)@MWH(7),$$

$$PMCWM(t_T) \equiv PWM(t_T)@MWM(0),$$

$$x_T = x(MP), \quad t_T = t(MWH(7), MWM(0)).$$

Here  $PT$ ,  $PWH$  and  $PWM$  are a pointer (P) on the train (T) and the hour (H) and minute (M) hands of Einstein’s watch respectively.  $MP$  is a mark (M) on the station platform (P) at Bern and  $MWH(7)$ ,  $MWM(0)$ , are the marks for 7 hours and 0 minutes on the watch dial. If Einstein’s watch is correctly synchronised with the Bern master clock then  $t_T = 7\text{h}00\text{min}$  Bern time. If not, the functional dependence of  $t_T = t(MWH(7), MWM(0))$  is more complicated. If Einstein’s watch is in advance or retarded relative to the Bern master clock additional constants must be respectively subtracted from or added to  $t_T$ . A suitable synchronisation procedure based on a master clock is described in the following section.

Some examples of elementary space and time measurements are shown in Fig. 1. In Fig. 1a, the spatial separation between two objects O1 and O2 at rest is measured via the marks (M)  $MR(J)$  on a ruler (R). Here  $J$  is the ordinal number of the ruler mark. To each mark is associated a number specifying a Cartesian coordinate:  $x_J = x[MR(J)]$ . The PMC specifying this measurement are:

$$PMC1(t_1) \equiv PO1(t_1)@MR(5), \quad PMC2(t_2) \equiv PO2(t_2)@MR(22). \quad (2.1)$$

The measured separation of the objects is then:

$$L \equiv L(0) = x[MR(22)] - x[MR(5)]. \quad (2.2)$$

$L(v)$  is the spatial separation of the objects when they are both moving with velocity  $v$  parallel to the ruler. It may be noted that in this case, since the objects are at rest, the times  $t_1$  and  $t_2$  at which  $PMC1$  and  $PMC2$  are established are arbitrary.



In Fig. 1b a similar measurement of the spatial separation of O1 and O2 is made except that both objects now move with uniform speed  $v$  parallel to the ruler. Such a measurement *requires simultaneity* of  $PMC1$  and  $PMC2$ :

$$PMC1(t_1) \equiv PO1(t_1)@MR(5), \quad PMC2(t_1) \equiv PO2(t_1)@MR(22). \quad (2.3)$$

The measured separation,  $L(v, t_1)$  is still given by Eq. (2.2). The measurement may be performed at any other time provided that the condition of simultaneity is respected. For example, as shown in Fig. 1c:

$$PMC1(t_2) \equiv PO1(t_2)@MR(9), \quad PMC2(t_2) \equiv PO2(t_2)@MR(26) \quad (2.4)$$

while

$$L(v, t_2) = x[MR(26)] - x[MR(9)]. \quad (2.5)$$

It is clear from the uniformity of the marks on the ruler that all three measurements of the spatial separation of the objects give the same result:

$$L \equiv L(0) = L(v, t_1) = L(v, t_2). \quad (2.6)$$

The measurement of the spatial separation of two objects with equal uniform motion then evidently, as in the case of the time measurement mentioned by Einstein and quoted above, requires *simultaneous* observation of two distinct  $PMC$ . The simultaneity requirement thus presupposes the existence of synchronised clocks at the spatial locations of the two  $PMC$ . In Section 4 below this relation will be inverted to provide a method to synchronise clocks in the same, or different, inertial frames.

The spatial configurations of the objects and the ruler in Fig. 1a,b,c provide independent and consistent measurements of the spatial separation of the objects, whether they are at rest or in uniform motion. The comparison of the configurations in Fig. 1b and 1c also provides the simplest possible example of the measurement of a time interval. For this it is necessary to associate  $PMC1(t_1)$  with  $PMC1(t_2)$  or  $PMC2(t_1)$  with  $PMC2(t_2)$ . That is to consider the coincidences of a given pointer with two different marks<sup>5</sup>

$$PMC1(t_1) \equiv PO1(t_1)@MR(5), \quad PMC1(t_2) \equiv PO1(t_2)@MR(9), \quad (2.7)$$

$$\Delta t(1) = (t_2 - t_1)_1 = \frac{1}{v} \{x[MR(9)] - x[MR(5)]\} \quad (2.8)$$

or

$$PMC2(t_1) \equiv PO2(t_1)@MR(22), \quad PMC2(t_2) \equiv PO2(t_2)@MR(26), \quad (2.9)$$

$$\Delta t(2) = (t_2 - t_1)_2 = \frac{1}{v} \{x[MR(26)] - x[MR(22)]\}. \quad (2.10)$$

From the uniformity of the ruler marks it is clear that:

$$\Delta t(1) = \Delta t(2) \equiv \Delta t. \quad (2.11)$$

In this example it is evident that the concept of time is inseparable from that of rectilinear motion with the *uniform speed*  $v$ . Comparing Fig1c and 1d it can be seen that the

---

<sup>5</sup>That measurements of length intervals require  $PMC$  between different pointers and different marks, whereas time interval measurements require  $PMC$  between the *same* pointer and the same, or different, marks was previously pointed out by G. Burnison-Brown [23].

measurement of a time interval by an analogue clock is in everyway similar to the example just discussed. The ruler in Fig. 1c is bent into the form of a circle and the objects O1 and O2 moving with uniform speed in a straight line are replaced by the hand of the clock,  $PC$ , rotating with uniform angular velocity  $\omega$ .

An alternative way to introduce the concept of a measurable time into physics is to assume the existence of physical systems with a reproducible periodic motion. In this case, the concept of a measurable time interval is inseparable from that of the existence of physical systems executing cyclic motion with a *constant period*. It is then clear, firstly, that ‘time’ and ‘uniform motion’ are inseparable concepts in physics and, secondly, that time measurements may always be constructed from  $PMC$ , that is from *spatial* pointer-mark coincidences, given the existence of physical systems executing uniform motion, whether rectilinear or periodic. For the case of periodic motion, the  $PMCs$  must contain the *same* pointer and mark. Consider, for example, the analogue clock of Fig. 1c where the pointer (hand)  $PC$  rotates with constant angular velocity  $\omega$ . The period is defined by successive  $PMC$  of the type  $PC@MC(J)$ . The corresponding period is  $\tau = 2\pi/\omega$ .

### 3 Clock synchronisation by pointer transport

As described in the previous section, in order to measure the length interval between two moving objects, two instantaneous  $PMC$  must be recorded. This requires, in turn, that synchronised clocks are placed at each ruler mark. The present section describes how an arbitrary number of clocks, all at rest in a common reference frame, may be synchronised with a master clock, M, also at rest in the same frame.

It is assumed that all clocks may be connected to M by cables C1, C2, ... of identical construction but of different lengths, so as to conveniently link all of the to-be-synchronised clocks to M. The pointer is an electrical signal generated at a known value of the time recorded by the master clock. The slave clocks are stopped at the beginning of the synchronisation procedure and are started by the  $PMC$  corresponding to receipt of the pointer signal from M. One other clock, A, is also equipped with a pointer signal generator similar to that of M. This clock may then be used as a secondary master clock. Three steps are necessary to synchronise an arbitrary clock, C, at some fixed position in the same reference frame, with M:

- (a) The clocks M, A and B, assumed all to run at the same rate, are connected as shown in Fig. 2a. Cables C1 and C2 are of equal, but arbitrary, length (it does not need to be known) whereas C3 is of precisely known length. Simultaneous pointer signals are sent from M along C1 and C2 to A and B. The latter two clocks are initially stopped and set to time zero. On receipt of the pointer signals A and B start and thereafter indicate synchronous times. The start signals are received simultaneously by A and B because the cables C1 and C2 are of equal length, and being of similar construction have the same signal propagation velocity  $u_S$ .
- (b) As shown in Fig. 2b, a pointer signal is now sent, at known time  $t_A$ , from A to B along C3, after these clocks have been synchronised as described in (a). Reception

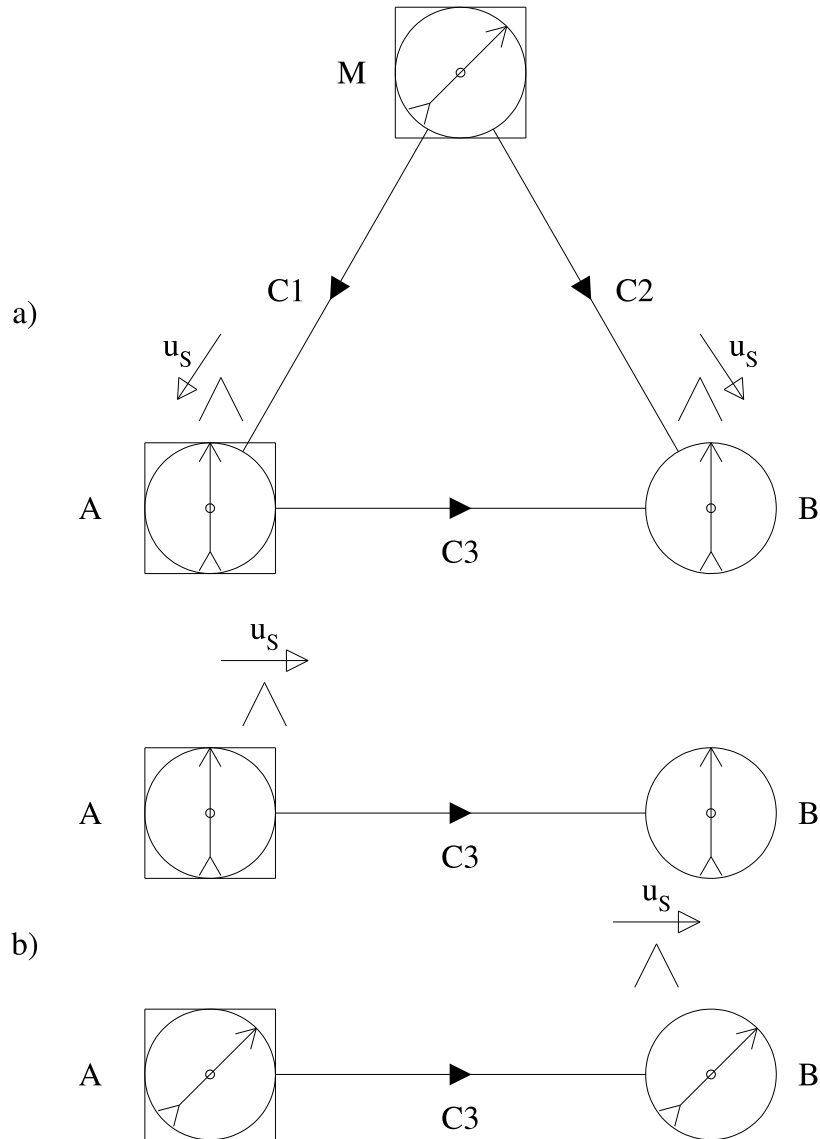

Figure 2: a) A procedure to synchronise two clocks A and B in the same inertial frame by pointer transport using a master clock M (see text). b) Measurement of the signal speed  $u_s$  in the cable C3, of known length, using the synchronised clocks A and B.

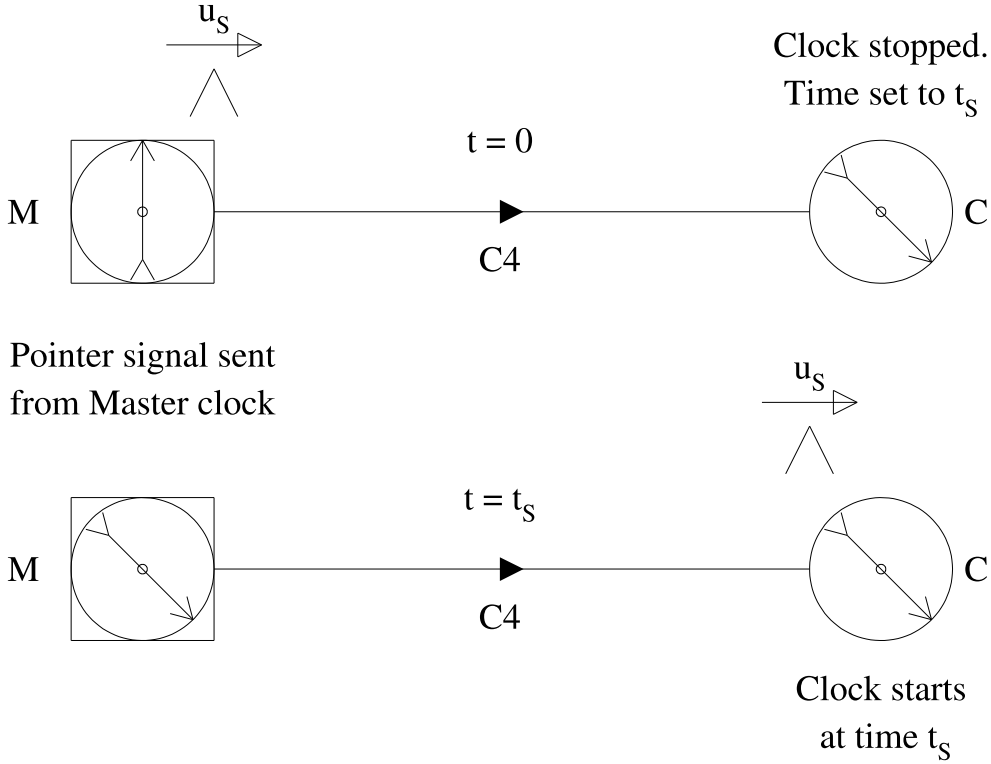

Figure 3: A procedure to synchronise a clock at an arbitrary position in the same frame as the master clock  $M$ . The cable  $C_4$  is of known length,  $\ell_4$  and known signal speed  $u_S$ . When the clock  $C$  starts at the time  $t_S = \ell_4/u_S$  it is synchronous with  $M$ .

of the signal stops B at the time  $t_B$ . If  $\ell_3$  is the length of cable C3 (suitably corrected to take into account signal transit times in A and B) the speed of signal propagation is measured to be:

$$u_S = \frac{\ell_3}{t_B - t_A}. \quad (3.1)$$

- (c) In order to synchronise with  $M$  an arbitrary clock  $C$ , at any distance from  $M$ , it is connected, to  $M$  by a cable,  $C_4$ , of arbitrary but known length,  $\ell_4$ . This cable is of similar construction to  $C_1$ ,  $C_2$  and  $C_3$  and has the same signal propagation speed  $u_S$ . The clock  $C$  is stopped and set to the time  $t = t_S = t_0 + \ell_4/u_S$ . where  $t_0$  is a convenient, pre-determined, time offset, and  $u_S$  has been determined as in (b) above. At time  $t = t_0$  a pointer signal is sent from  $M$  to  $C$ . When the clock  $C$  is started by the pointer signal at  $M$  time  $t_S$  it is synchronous with  $M$ . This synchronisation procedure is illustrated In Fig. 3 for the case  $t_0 = 0$ .

The above method enables synchronised clocks to be placed at arbitrary positions in any given frame of reference, but does not address the problem of synchronisation of clocks in frames in relative motion. A method to synchronise an arbitrary number of clocks in an inertial frame with a similar array of clocks in another inertial frame is described in the following section.

#### 4 Similar motion of two objects in a single inertial frame. Clock synchronisation by length transport. The moving ruler clock

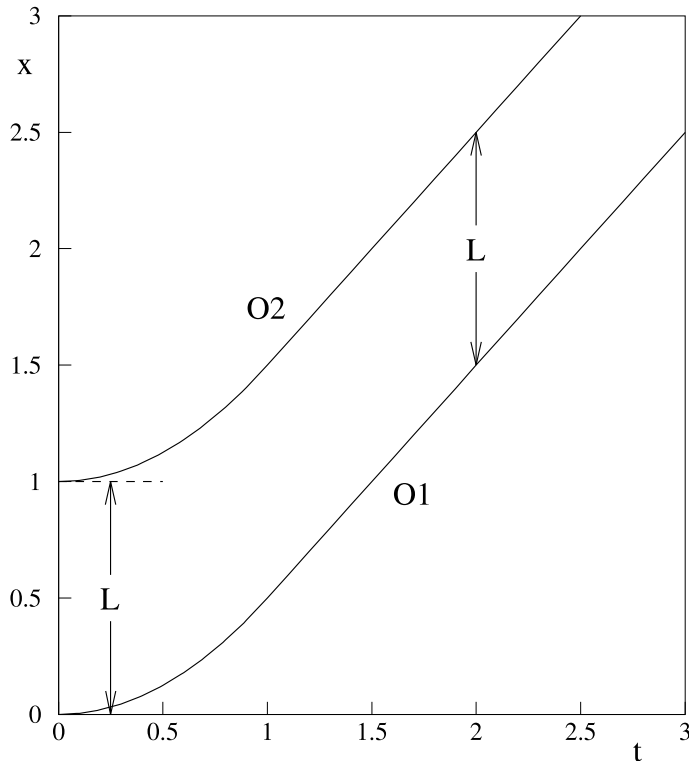

Figure 4: *Space-time trajectories of two objects O1 and O2 undergoing equal uniform acceleration during one unit of time in the inertial frame S. The distance between the objects is L at all times. The distance between the objects is also L at all times in their common, instantaneous, co-moving inertial frame, S'. As the two objects are referred, in both cases, to a single frame of reference, the above statements concerning their separation are valid for a space-time geometry described by either the Galilean or the Lorentz transformation. These transformations relate only space and time measurements, performed in different inertial frames, of a single object.*

The motion along the x-axis of an inertial frame S of two objects O1 and O2 is now considered. At time  $t = 0$  the objects are at rest and separated by the distance  $L$ . Each object is then subjected to an identical acceleration program during the time  $t_{acc}$  in S. The instantaneous co-moving inertial frame of the objects, at any instant, is denoted by S'. For  $t > t_{acc}$ , S' is a fixed inertial frame moving with speed  $v$  relative to S. For definiteness the acceleration program is chosen to correspond to a constant acceleration,  $a$ , in the frame S during the period  $0 < t < t_{acc}$ . In this case the positions of the objects O1, (O2) in S:  $x_1(t)$ ,  $(x_2(t))$  at time  $t$  are given by the equations:

$$0 < t < t_{acc}$$

$$x_1(t) = \frac{1}{2}at^2, \tag{4.1}$$

$$x_2(t) = x_1(t) + L. \tag{4.2}$$

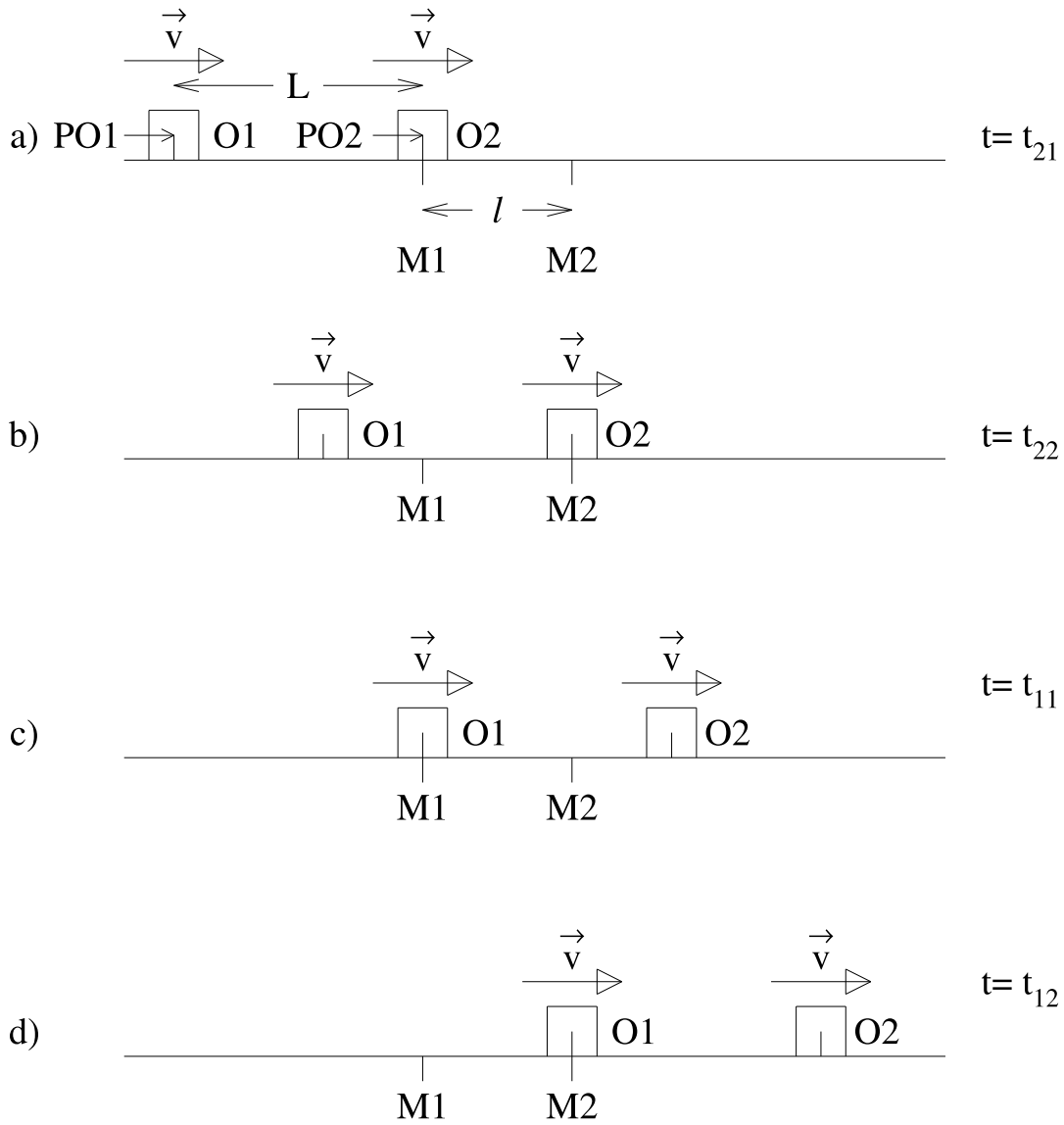

Figure 5: *Definitions of the different PMC used to measure the spatial separation of two objects  $O1$  and  $O2$  moving parallel to the ruler  $M1 - M2$ . See Eq. s(4.5)-(4.10).*

$$t \geq t_{acc}$$

$$x_1(t) = \frac{1}{2}at_{acc}^2 + v(t - t_{acc}), \quad (4.3)$$

$$x_2(t) = x_1(t) + L \quad (4.4)$$

where  $v = at_{acc}$ .

The space-time trajectories of O1 and O2 in S are shown in Fig. 4. At all times, the spatial separation of the objects is equal to their initial separation  $L$ . Because of the symmetry of the acceleration program, the separation of the objects in the co-moving inertial frame S',  $x'_2 - x'_1$ , is also  $L$  at all times.

The objects O1 and O2 may be replaced by clocks initially synchronised in the frame S, by the procedure described in the preceding section. In view of the symmetry of the acceleration program, it is evident that such clocks must remain synchronised at all times, including during the phase of uniform motion when  $t \geq t_{acc}$ . The clocks are then mutually synchronised in the inertial frames S and S' at all times, but they are not necessarily synchronised with a clock at rest in S.

A procedure is now established to synchronise a pair of clocks in S' with a pair of clocks in S at some instant in both S and S', whether or not the latter have been previously mutually synchronised by the procedure described in the previous section. The first step towards this goal is to set up an experiment to measure the distance between O1 and O2 during the phase of uniform motion at speed  $v$  of the two objects. As all such measurements in physics they are constructed from the coordinates corresponding to PMC. The method employed is shown in Fig. 5. A simple ruler with two marks,  $M1$  and  $M2$  separated by the known distance  $l$  is placed along the x-axis and the following PMCs are recorded using synchronised clocks in S at the positions of  $M1$  and  $M2$ :

$$\begin{aligned} PMC2(t_{21}) &\equiv PO2(t_{21})@M1, & PMC2(t_{22}) &\equiv PO2(t_{22})@M2, \\ PMC1(t_{11}) &\equiv PO1(t_{11})@M1, & PMC1(t_{12}) &\equiv PO1(t_{12})@M2. \end{aligned} \quad (4.5)$$

Observation of the times of the four PMC above and knowledge of the ruler mark separation then enables both the spatial separation,  $L$ , of the objects and their speed,  $v$ , to be deduced from the equations derived from the space-time geometry of the four configurations, corresponding to the four *PMC*, shown in Fig. 5:

$$t_{22} - t_{21} = \frac{l}{v}, \quad (4.6)$$

$$t_{11} - t_{22} = \frac{L - l}{v}, \quad (4.7)$$

$$t_{12} - t_{11} = \frac{l}{v}. \quad (4.8)$$

The solution of these equations is:

$$L = l \frac{(t_{12} + t_{11} - t_{22} - t_{21})}{(t_{12} - t_{11} + t_{22} - t_{21})}, \quad (4.9)$$

$$v = \frac{2l}{(t_{12} - t_{11} + t_{22} - t_{21})}. \quad (4.10)$$

Now, in the case that  $t_{11} = t_{22}$ , Eq. (4.9) gives:

$$L = l \frac{(t_{12} - t_{21})}{(t_{12} - t_{21})} = l. \quad (4.11)$$

i.e. the separation of the moving objects is equal to that of the ruler marks  $M1$  and  $M2$ .

Inversely, if it is known in advance that the separation of the ruler marks is equal to that of the objects, observation of  $PMC1(t_{11})$  and  $PMC2(t_{22})$  can be used to synchronise the clocks in  $S$  associated with the ruler marks  $M1$  and  $M2$ . More than this, if the objects  $O1$  and  $O2$  are now replaced by clocks in the frame  $S'$ , the evident symmetry between the marks in  $S$  and pointers in  $S'$  and marks in  $S'$  and pointers in  $S$ , in this case, means that the simultaneity of  $PMC1(t_{11})$  and  $PMC2(t_{22})$  enables all four clocks, two in  $S$ , two in  $S'$  to be mutually synchronised. In practice this can conveniently be done by stopping all four clocks and setting them to a common time. Denote the clocks, in an obvious notation, as  $C1(S), C2(S), C1(S')$  and  $C2(S')$ . The clocks  $C1(S)$  and  $C1(S')$  are started by  $PMC1(t_{11})$  and  $C2(S)$  and  $C2(S')$  by  $PMC2(t_{22})$ . Since  $t_{11} = t_{22}$  all four clocks are then mutually synchronised at a particular instant in both  $S$  and  $S'$ . A possible practical way to implement this simultaneous starting of clocks in the frames  $S$  and  $S'$  using switches constructed from photon sources, photon detectors and screens is sketched in Fig. 6.

This method for synchronising clocks can also be used, instead of the procedure described in the previous section, to synchronise spatially separated clocks in the *same* inertial frame. This method, which may be called *clock synchronisation by length transport* can be graphically illustrated, as in Einstein's example demonstrating the importance of simultaneity in the definition of time measurements, by considering  $PMC$  corresponding to train arrival times. On the platform at Cornavin station in Geneva there are two clocks,  $C1$  and  $C2$  that are unsynchronised but whose corresponding ruler marks  $M1$  and  $M2$  are a known distance apart. A possible way to synchronise these clocks is as follows. They are both stopped and set to the same time, Apparata are set up to start them when suitable pointers are in spatial coincidence with their ruler marks. On the station at Bern there are two ruler marks the same distance apart as the clocks on the platform at Cornavin. Two identical locomotives are lined up so that corresponding points on them,  $P1$  and  $P2$ , are aligned with these marks. The two locomotives then start at the same time and move along world lines of identical shape until they arrive at Cornavin station. When the points  $P1$  and  $P2$  of the locomotives are in spatial coincidence with the marks  $M1$  and  $M2$ :

$$PMC1 \equiv P1@M1, \quad PMC2 \equiv P2@M2$$

the two clocks are started. They are synchronous. It is clear that any pair of clocks along the line from Bern to Geneva, separated by the same distance as those at Cornavin, can be synchronised by the same technique.

The method of clock synchronisation by length transport just described can be generalised to a large array of synchronised digital clocks in a given reference frame. The method is illustrated in Fig. 7. The 'mark ruler'  $MR$  is at rest while the 'pointer ruler'  $PR$  slides along  $MR$  at constant speed  $v$ . Opposite the mark  $JM$  of  $MR$  is a detector of spatial coincidences of  $JM$  with the pointer  $JP$  constituted by the  $JP$ th mark of the moving ruler  $PR$ . Attached to the  $PMC$  detector at  $JM$  is the digital clock  $CJM$ . The configuration shown in Fig. 7a corresponds to the following  $PMC$ , each with the structure



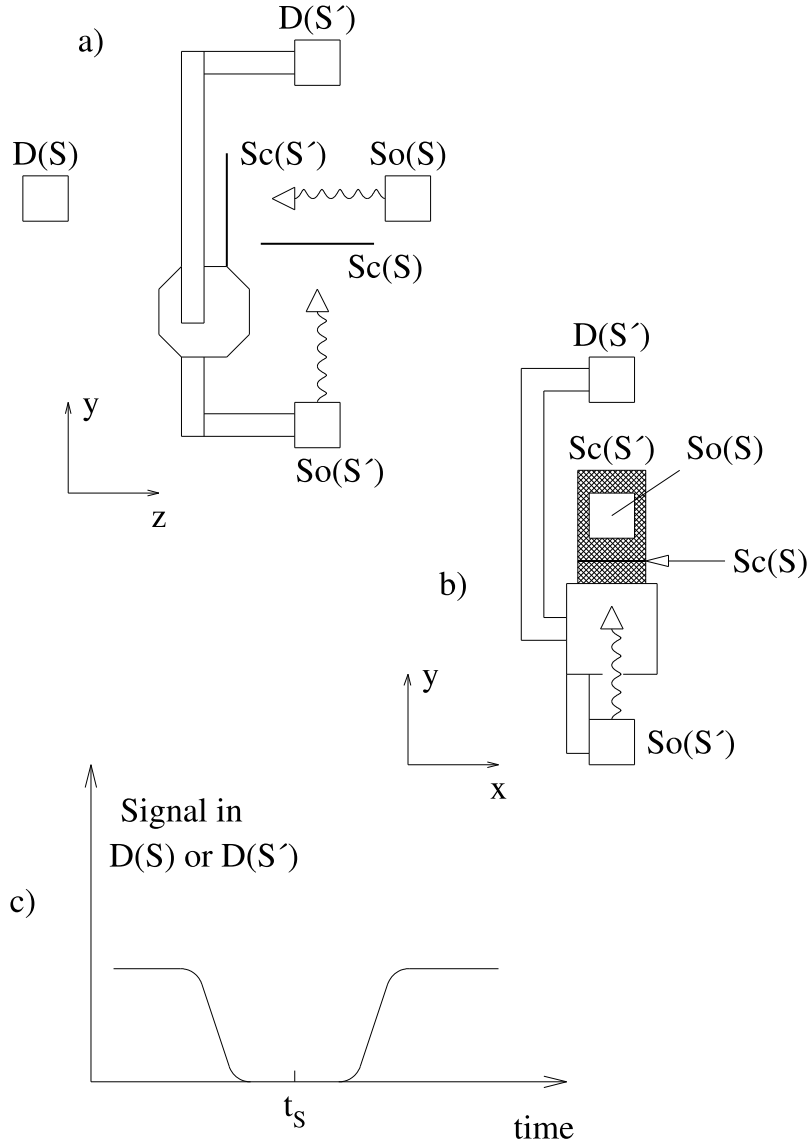

Figure 6: A practical scheme to synchronise clocks at rest in two inertial frames  $S$  and  $S'$  moving with relative velocity  $v$  along their common  $x, x'$  axis. a) shows the  $z$ - $y$ , b) the  $x$ - $y$  projection of the apparatus. In both  $S$  and  $S'$  there are similar photon sources  $So(S)$  and  $So(S')$  and equidistant photon detectors  $D(S)$  and  $D(S')$ . When the clocks (not shown) connected directly to  $D(S)$  and  $D(S')$  are spatially separated the detectors  $D(S)$  and  $D(S')$  count continuously the photons emitted by  $So(S)$  and  $So(S')$ . Identically constructed screens  $Sc(S)$  and  $Sc(S')$  fixed in  $S$  and  $S'$  block both photon beams when source-detector pairs  $So(S)$ - $D(S)$  and  $So(S')$ - $D(S')$  (and hence the connected clocks) have the same  $x$ -coordinate, as shown in b). During the passage of the screens across the photon beams, the signal in  $D(S)$  or  $D(S')$  has the time variation shown in c). Clocks connected to  $D(S)$  and  $D(S')$ , with the same initial settings, when started at the time  $t_s$ , (which can be at any fixed position on the signal curve shown in c)) are then synchronised.

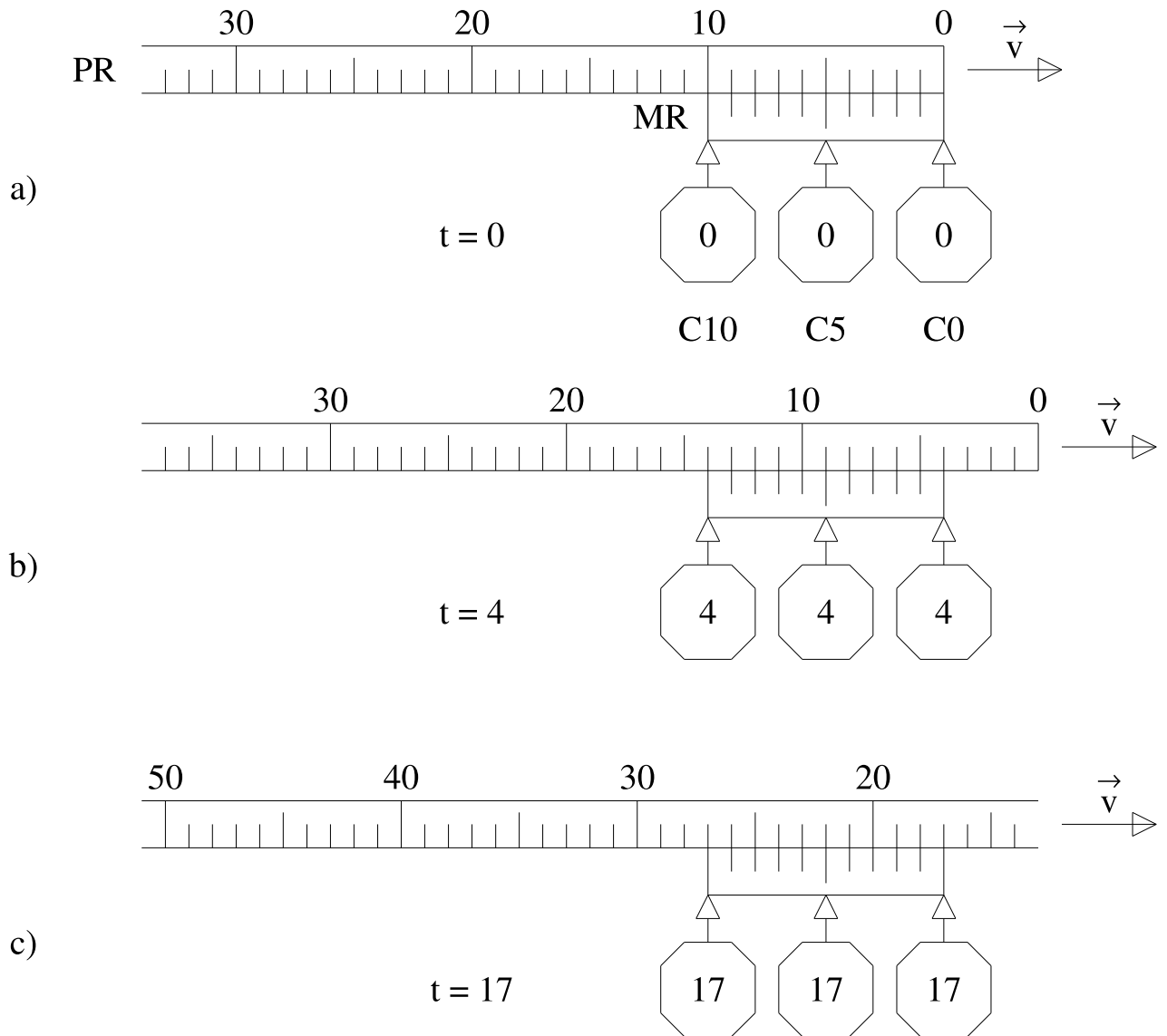

Figure 7: *The moving ruler clock. The ‘pointer ruler’ PR moves with uniform velocity  $v$  parallel to the fixed ‘mark ruler’ MR. The digital clocks C0, C5 and C10 which count the number of pointer coincidences with the marks MR(0), MR(5) and MR(10) respectively constitute an array of spatially separated, synchronised, clocks in the rest frame of MR. a), b) and c) show the relative positions of PR and MR at different times in this frame.*

$PMC(JM) \equiv PR(JP)@MR(JM)$ :

$$PMC(0) \equiv PR(0)@MR(0), \quad PMC(5) \equiv PR(5)@MR(5),$$

$$PMC(10) \equiv PR(10)@MR(10).$$

Each clock CJM contains a simple algorithm to convert the corresponding pointer,  $JP(JM)$  of the ruler PR into a time:

$$t = \frac{d(JP(JM) - JM)}{v} \quad (4.12)$$

where  $d$  is the mark separation of MR or PR. The time  $t$  given by (4.12) is independent of  $JM$ , that is, the whole array of clocks is synchronised. Further examples of the readings of the clocks C0, C5 and C10 are shown in Figs.7b and 7c.

In practice, the  $PMC$  detector does not need to identify  $JP$  in order to construct the time, since the time interval recorded by each each clock after the initial configuration of Fig. 7a is proportional to the number of  $PMC$  recorded. Each clock is then simply a counter of the number of  $PMCs$  with a visual display of its contents. These counters constitute an array of synchronised digital clocks with time resolution  $\simeq d/v$ .

## 5 The relation of measurements of space and time intervals in different inertial frames. The Galilean and Lorentz Transformations

Suppose now that two clocks C1 and C2 are set beside the marks  $M1$  and  $M2$  in Fig. 5. The objects O1 and O2 are replaced by clocks C1' and C2', at rest in S', an inertial frame moving with velocity  $v$  along the positive x-axis in S, and separated by the same distance  $L$  as C1 and C2 in the frame S. The positions of the clocks at rest in S', in S, at time  $\tau$ , are given, in general, by the relations<sup>6</sup>:

$$x(C1') - x_0 = v(\tau - \tau_0), \quad (5.1)$$

$$x(C2') = x(C1') + L, \quad (5.2)$$

$$x(C2) = x(C1) + L. \quad (5.3)$$

Similarly the positions of the clocks at rest in S, in S', at time  $\tau'$ , are:

$$x'(C1) - x'_0 = -v(\tau' - \tau'_0), \quad (5.4)$$

$$x'(C2) = x'(C1) + L, \quad (5.5)$$

$$x'(C2') = x'(C1') + L. \quad (5.6)$$

The equations (5.1)-(5.6) do not assume any particular choice for the origins of spatial or temporal coordinates. The proper times  $\tau$  and  $\tau'$  are those recorded by synchronised

---

<sup>6</sup>In the present and following sections the symbol  $\tau$ ,  $\tau'$  are used consistently to indicate the times of clocks at rest in S and S' as viewed by observers at rest in S and S', respectively, whereas  $t$  and  $t'$  are the times of clocks at rest in S and S' as viewed by observers at rest in S' and S, respectively. The symbols  $t$  and  $t'$  therefore represent the apparent times registered by clocks in uniform motion.

clocks at any position in S and S' respectively. In addition to these 'frame times', the following 'apparent' times may also be defined:

$t'(C1', \tau)$ : The time registered by C1' seen by a local observer in S at time  $\tau$ .

$t'(C2', \tau)$ : The time registered by C2' seen by a local observer in S at time  $\tau$ .

$t(C1, \tau')$ : The time registered by C1 seen by a local observer in S' at time  $\tau'$

$t(C2, \tau')$ : The time registered by C2 seen by a local observer in S' at time  $\tau'$

It is important to point out that (5.1)-(5.6) do not represent events that are connected by a space-time transformation but rather specify kinematical configurations in the frame S of a *primary experiment* and in the frame S' of a physically independent *reciprocal experiment*. Thus different space-time transformations describe the connection between events in the frames S and S', in the primary and reciprocal experiments<sup>7</sup> Hence the time  $t'$  is related to  $\tau$  via a certain space-time LT in the primary experiment and  $t$  to  $\tau'$  by a *different* space-time LT in the reciprocal experiment. The configurations: S' moves with speed  $v$  along the positive  $x$ -axis in S (primary experiment) and S moves with speed  $v$  along the negative  $x'$ -axis in S' (reciprocal experiment) are, however, related by the *kinematical* (velocity) LT between these two frames.

The relations (5.1)-(5.6) may be simplified by a suitable choice of coordinate origins and synchronisation of the frame clocks in S and S'. All four clocks are now synchronised using the length transport procedure described in the previous section. The corresponding pointer-mark coincidences (for simplicity of notation the clock labels are used to denote either pointers or marks) are as follows:

$$\begin{aligned} PMC1'(\tau) &\equiv C1'(\tau)@C1, & PMC2'(\tau) &\equiv C2'(\tau)@C2, \\ PMC1(\tau') &\equiv C1(\tau')@C1', & PMC2(\tau') &\equiv C2(\tau')@C2'. \end{aligned}$$

As shown in Fig. 8a, the choice  $\tau = \tau' = 0$  enables synchronisation of all four clocks at these times. With the choice of coordinate origins shown in Fig. 8 a, (5.1)-(5.6) simplify to:

*primary experiment*

$$x(C1') = v\tau, \tag{5.7}$$

$$x(C2') = x(C1') + L, \tag{5.8}$$

$$x(C1) = 0, \tag{5.9}$$

$$x(C2) = L. \tag{5.10}$$

*reciprocal experiment*

$$x'(C1) = -v\tau', \tag{5.11}$$

$$x'(C2) = x'(C1) + L, \tag{5.12}$$

$$x'(C1') = 0, \tag{5.13}$$

$$x'(C2') = L. \tag{5.14}$$

---

<sup>7</sup>An example of this is given below where the LT (5.17) and (5.18) applies for the primary experiment and the different LT (5.24) and (5.25) applies for the reciprocal one.

As in (5.1)-(5.6) above it is assumed that all clocks are observed to run at the same rate when they are in the same inertial frame. The observed behaviour of the moving clocks in the primary and reciprocal experiments is specified by the four apparent times  $t'(C1', \tau)$ ,  $t'(C2', \tau)$ ,  $t(C1, \tau')$  and  $t(C2, \tau')$  defined above. In the case that all these times are equal to  $\tau$ , which is in turn equal to  $\tau'$ , for all values of  $\tau$ , time is universal, for all inertial observers, as Newton assumed. The GT formulae for the primary experiment are more conventionally written for a single ('stationary') clock in S recording time  $\tau$  and a (uniformly moving, as viewed from S) one, at the origin in S', recording time  $t'$ , as:

*primary experiment*

$$x' = x - v\tau = 0, \quad (5.15)$$

$$t' = \tau. \quad (5.16)$$

The LT of the times and positions of single clocks in S and S' in the primary experiment is written in a similar manner to the GT (5.15), (5.16) as (equations (A.44) and (A.45) in the Appendix):

*primary experiment*

$$x' = \gamma(x - v\tau) = 0, \quad (5.17)$$

$$t'(\tau) = \gamma\left(\tau - \frac{vx}{V^2}\right) \quad (5.18)$$

where

$$\gamma \equiv \frac{1}{\sqrt{1 - \left(\frac{v}{V}\right)^2}}.$$

and  $V$  is the maximum possible relative velocity of the frames S and S'. This particular choice of coordinate origins and time offsets, introduced by Einstein, corresponds to synchronisation of the clocks in S and S' so that  $\tau = t'(\tau) = 0$  when  $x = x' = 0$ . It reduces to the GT (5.15) and (5.16) in the limit  $V \rightarrow \infty$ . LT equations suitable to describe the clocks synchronised as shown in Fig. 8a may be derived by generalising (5.17) and (5.18) to allow an arbitrary choice of coordinate origins and clock-time offsets:

*primary experiment*

$$x' - x'_0 = \gamma(x - x_0 - v(\tau - \tau_0)) = 0, \quad (5.19)$$

$$t'(\tau) - t'_0 = \gamma\left(\tau - \tau_0 - \frac{v(x - x_0)}{V^2}\right). \quad (5.20)$$

The importance of such a generalisation, in order to describe synchronised clocks at different spatial positions, was clearly stated by Einstein in the original paper on SR [5]:

If no assumption whatever be made as to the initial position of the moving system and as the the zero point of  $\tau$ , ( $t'$  in the notation used above)an additive constant is to be placed on the right side of each of these (the LT (5.17)-(5.18)) equations.

This consideration was never, however, to the present writer's best knowledge, taken into account by Einstein, or any later author, before the work presented in Ref. [8]. The

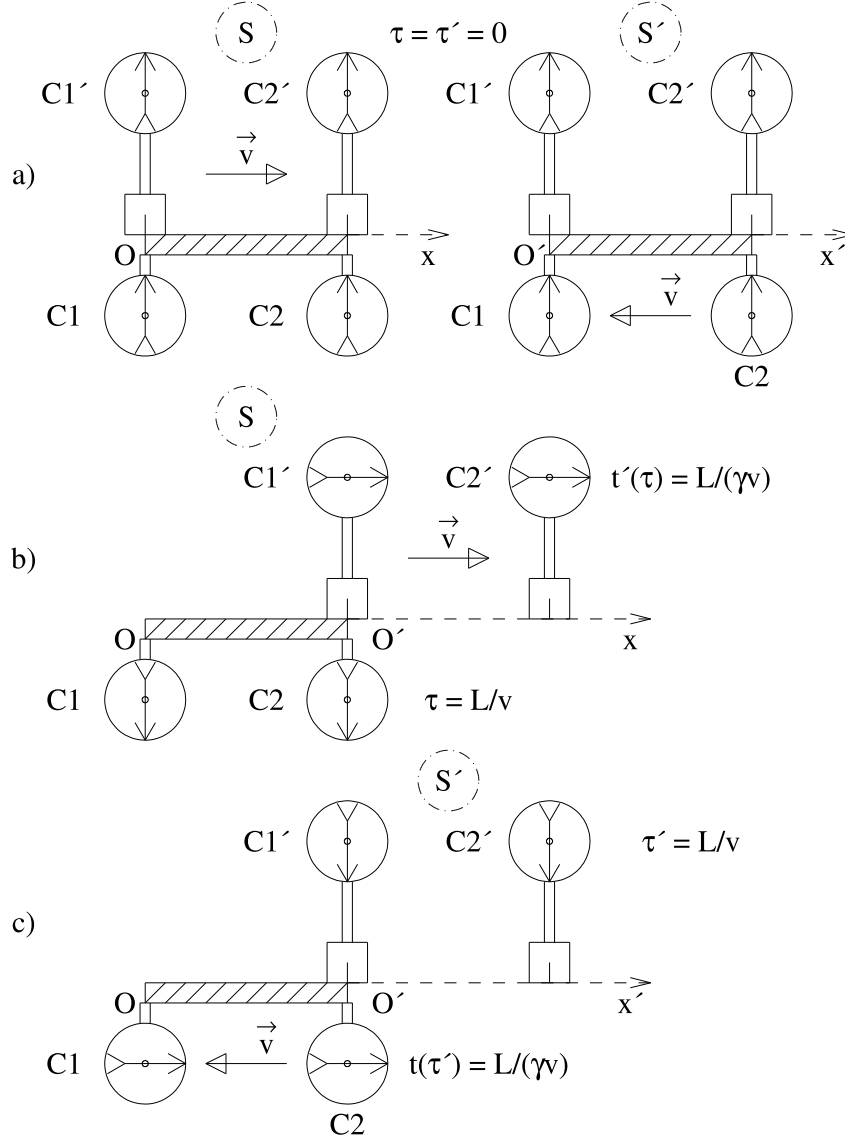

Figure 8: The clocks  $C1$  and  $C2$  are separated by the distance  $L$  in  $S$ ,  $C1'$  and  $C2'$  by the same distance in  $S'$ . a) All four clocks are synchronised by length transport (see text) at the times  $\tau = \tau' = 0$  either in the the frame  $S$  (primary experiment) or in the frame  $S'$  (reciprocal experiment). b) Times seen by an observer at rest in  $S$  in the primary experiment at frame time  $\tau = L/v$ . c) Times seen by an observer at rest in  $S'$  in the reciprocal experiment at frame time  $\tau' = L/v$ .  $\beta = v/V = \sqrt{3}/2$ ,  $\gamma = 2$ . Units of distance and time are chosen so that  $L/V = 3\sqrt{3}$ .

‘standard’ LT (5.17)-(5.18) has always been employed, regardless of the the position of the clock in the frame S’. How this results in the spurious predictions of ‘relativity of simultaneity’ and ‘length contraction’ effects is explained in the following section.

Since (see Fig. 8a),  $\tau(\text{C1}) = t'(\text{C1}') = 0$  when  $x(\text{C1}) = x'(\text{C1}') = 0$  Eq. s(5.17) and (5.18) already correctly describe the synchronisation of C1 and C1'. i.e. in (5.19) and (5.20) the choice  $x_0 = x'_0 = t_0 = t'_0 = 0$  must be made. Substituting the relation:

$$x'(\text{C1}') = 0 = x(\text{C1}') - v\tau$$

into(5.18) gives:

$$t'(\text{C1}', \tau) = \gamma \left( \tau - \left( \frac{v}{V} \right)^2 \tau \right) = \frac{\tau}{\gamma}.$$

The transformation equations for the clock C1' in the primary experiment are then:

*primary experiment*

$$x(\text{C1}') = v\tau, \tag{5.21}$$

$$x'(\text{C1}') = 0, \tag{5.22}$$

$$t'(\text{C1}', \tau) = \frac{\tau}{\gamma}. \tag{5.23}$$

In a similar manner, substituting the relation:

$$x(\text{C1}) = 0 = x'(\text{C1}) + v\tau'$$

into the equations, reciprocal<sup>8</sup> to (5.17) and (5.18):

*reciprocal experiment*

$$x = \gamma(x' + v\tau') = 0, \tag{5.24}$$

$$t(\tau') = \gamma \left( \tau' + \frac{vx'}{V^2} \right) \tag{5.25}$$

gives:

$$t(\text{C1}, \tau') = \gamma \left( \tau' - \left( \frac{v}{V} \right)^2 \tau' \right) = \frac{\tau'}{\gamma}$$

thus yielding for the transformation equations of the clock C1 in the reciprocal experiment:

*reciprocal experiment*

$$x'(\text{C1}) = -v\tau', \tag{5.26}$$

$$x(\text{C1}) = 0, \tag{5.27}$$

$$t(\text{C1}, \tau') = \frac{\tau'}{\gamma}. \tag{5.28}$$

---

<sup>8</sup>Note that (5.24) and (5.25) are reciprocal to, not the inverses, of (5.17) and (5.18), since in (5.17) and (5.18)  $x' = 0$ ,  $x = v\tau$ , while in (5.24) and (5.25)  $x = 0$ ,  $x' = -v\tau'$ . S and S' are therefore related by different space-time LTs in the primary and reciprocal experiments.

Comparing with Eq. s(5.7) and (5.11) it can be seen that the space transformations are the same as for the GT whereas the apparent times  $t'(C1', \tau)$  and  $t(C1, \tau')$  differ from  $\tau$  and  $\tau'$  respectively. Observers in S in the primary experiment and in S' in the reciprocal experiment judge that the clock in the other frame is running slow by the factor  $1/\gamma$ —the time dilation effect first derived as a general consequence of the LT, by Einstein [5].

In order to describe correctly the synchronisation of C2 and C2', a different choice of constants in (5.19) and (5.20) is necessary. Suppose that  $\tau = t' = 0$  when  $x = L$  and  $x' = L'$ . This implies that  $\tau_0 = t'_0 = 0$  and  $x_0 = L$ ,  $x'_0 = L'$  so that:

*primary experiment*

$$x' - L' = \gamma(x - L - v\tau) = 0, \quad (5.29)$$

$$t'(\tau) = \gamma\left(\tau - \frac{v(x - L)}{V^2}\right). \quad (5.30)$$

Since both  $x_0$  and  $x'_0$  are constants, independent of  $v$ , and depending only on the choice of spatial coordinate systems in S and S' respectively, Eq. (5.29) holds for all values of  $v$ ; in particular it holds when  $v \rightarrow 0$ ,  $S \rightarrow S'$ ,  $x \rightarrow x'$  in which case (5.29) gives:

$$x' - L' = x' - L \quad (5.31)$$

or

$$L' = L. \quad (5.32)$$

As previously discussed, from first principles, in Section 4 above the spatial separation of the clocks is a Lorentz invariant quantity—there is no ‘relativistic length contraction’. With (5.32) and defining  $X \equiv x - L$  and  $X' \equiv x' - L$  (5.29) and (5.30) are identical to (5.17) and (5.18) with the replacements  $x \rightarrow X$  and  $x' \rightarrow X'$ . The transformation equations for C2' and C2 are then:

*primary experiment*

$$x(C2') = v\tau + L = x(C1') + L, \quad (5.33)$$

$$x'(C2') = L = x'(C1') + L, \quad (5.34)$$

$$t'(C2', \tau) = \frac{\tau}{\gamma} = t'(C1', \tau). \quad (5.35)$$

A similar calculation for the reciprocal experiment gives:

*reciprocal experiment*

$$x'(C2) = -v\tau' + L = x'(C1) + L, \quad (5.36)$$

$$x(C2) = L = x(C1) + L, \quad (5.37)$$

$$t(C2, \tau') = \frac{\tau'}{\gamma} = t(C1, \tau'). \quad (5.38)$$

Eqs. (5.33),(5.34) and (5.36),(5.37) are the same as the corresponding GT whereas the apparent times of C1' and C2' as viewed from S in the primary experiment are equal, as are the apparent times of C1 and C2 as viewed from S' in the reciprocal experiment.



The value of the coordinate offset,  $x_0 = L$ , necessary to ensure synchronisation of C2 and C2', is equivalent to choosing a LT which is 'local at C2', in the sense that C2' is placed at the origin of spatial coordinates in S'. This is so because  $X' = x' - L$  actually vanishes when  $x'$  specifies the position of C2'. Clearly all such clocks, (i.e., whatever the value of  $L$ ) described by a local LT or, equivalently, by Eq. s(5.29) and (5.30), will be synchronous with C1' at  $\tau = \tau' = 0$  (the instant of synchronisation), as well as at all later times. The necessity to use, in a systematic manner, such 'local' LT to describe clocks in order to avoid causal paradoxes, and to assure unique predictions in special relativity that respect translational invariance, has been previously pointed out and discussed in detail in Reference [8].

The observed behaviour of the clocks C1', (C1) as predicted by Eq. s(5.21)-(5.23), (Eq. s(5.26)-(5.28)) or of C2', (C2) as predicted by Eq. s(5.33)-(5.35), (Eq. s(5.36)-(5.38)) is illustrated in Fig. 8. It is assumed, for purposes of illustration, that  $\beta \equiv v/V = \sqrt{3}/2$ ,  $\gamma = 2$ , so that the apparent rate of the moving clocks is 50% less than that of a similar clock viewed at rest. Units of length and time are chosen such that  $L = 3\sqrt{3}V$ . Twelve units of time then correspond to a  $2\pi$  rotation of the hands of the analogue clocks in Fig. 8. As in Fig. 1d, there are twelve marks on the faces of the clocks. Fig. 8a shows the clocks as viewed from either S in the primary experiment or S' in the reciprocal experiment at the instant,  $\tau = \tau' = 0$ , at which they are synchronised. At time  $\tau = L/v$  the following five *PMC* may be recorded by observers in S (Fig. 8b):

*primary experiment*

- Spatial coincidence of C1' (pointer) with C2 (mark):

$$PMC1 \equiv C1'(L/v)@C2.$$

- Pointer-mark coincidence of clock C1:

$$PMC2 \equiv PC1(L/v)@MC1(6).$$

- Pointer-mark coincidence of clock C2:

$$PMC3 \equiv PC2(L/v)@MC2(6).$$

- Pointer-mark coincidence of clock C1':

$$PMC4 \equiv PC1'(L/v)@MC1'(3).$$

- Pointer-mark coincidence of clock C2':

$$PMC5 \equiv PC2'(L/v)@MC2'(3).$$

The time  $\tau$  of C1 and C2 in S in the primary experiment is given by the marks  $MC1(6)$  or  $MC2(6)$  while the apparent time of C1' or C2' as viewed from S,  $t'(\tau)$ , is given by  $MC1'(3)$  or  $MC2'(3)$ . That is, with the given choice of space and time units:

$$\tau = 6, \quad t'(\tau) = t'(6) = 3. \tag{5.39}$$

The situation at the instant of the same spatial coincidence of C1' and C2, but as viewed from S' in the reciprocal experiment, is shown in Fig. 8c. Again, observations of five distinct *PMC* may be made. They are:

*reciprocal experiment*

- Spatial coincidence of C2 (pointer) with C1' (mark):

$$PMC1' \equiv C2(L/v)@C1'.$$

- Pointer-mark coincidence of clock C1':

$$PMC2' \equiv PC1'(L/v)@MC1'(6).$$

- Pointer-mark coincidence of clock C2':

$$PMC3' \equiv PC2'(L/v)@MC2'(6).$$

- Pointer-mark coincidence of clock C1:

$$PMC4' \equiv PC1(L/v)@MC1(3).$$

- Pointer-mark coincidence of clock C2:

$$PMC5' \equiv PC2(L/v)@MC2(3).$$

The times in S' corresponding to the times in S given by (5.39) are:

$$\tau' = 6, \quad t(\tau') = t(6) = 3. \tag{5.40}$$

The times shown in (5.39) and (5.40) are a perfect exemplification of the measurement reciprocity postulate stated in the Introduction: space-time measurements in reciprocal experiments produce identical results. Observers in both the primary and reciprocal experiments see that the moving clocks in the other frame are running more slowly than similar clocks at rest in their own frames.

## 6 The illusory nature of ‘relativity of simultaneity’ and ‘relativistic length contraction’ of conventional special relativity theory

In the length transport synchronisation of the clocks C1, C2, C1' and C2' in Fig. 8a it was noticed that different values of the constants  $x_0$ ,  $x'_0$ ,  $\tau_0$  and  $t'_0$  in the general LT

		C1				C1'			
Obs	LT	$x$	$x'(\tau')$	$\tau$	$t(\tau')$	$x'$	$x(t)$	$\tau'$	$t'(\tau)$
S	LT(0)	–	–	0	–	0	0	–	0
S'	LT(0)	0	0	–	0	–	–	0	–
S	LT(L)	–	–	0	–	0	$L(\gamma - 1)/\gamma$	–	$vL/V^2$
S'	LT(L)	0	$L(\gamma - 1)/\gamma$	–	$-vL/V^2$	–	–	0	–

Table 1: *Apparent times and positions of the clocks C1, C1' in Fig. 9. LT(0) corresponds to the LT of Eqs. (5.17) and (5.18) (primary experiment) or (5.24) and (5.25) (reciprocal experiment). LT(L) corresponds to the same equations with the replacements:  $x \rightarrow x - L$ ,  $x' \rightarrow x' - L$ . For an observer in S in the primary experiment the values of  $\tau$  and  $x'$  are assigned the values shown while  $x(t)$  and  $t'(\tau)$  are calculated using the LT. For a observer in S' in the reciprocal experiment the values of  $\tau'$  and  $x$  are assigned the values shown while  $x'(t')$  and  $t(\tau')$  are calculated using the LT. See text for discussion.*

		C2				C2'			
Obs	LT	$x$	$x'(t')$	$\tau$	$t(\tau')$	$x'$	$x(t)$	$\tau'$	$t'(\tau)$
S	LT(0)	–	–	0	–	$L$	$L/\gamma$	–	$-vL/V^2$
S'	LT(0)	$L$	$L/\gamma$	–	$vL/V^2$	–	–	0	–
S	LT(L)	–	–	0	–	$L$	$L$	–	0
S'	LT(L)	$L$	$L$	–	0	–	–	0	–

Table 2: *Apparent times and positions of the clocks C2, C2' in Fig. 9. calculated as described in the Caption of Table 1. See text for discussion.*

equations (5.19) and (5.20) were needed to correctly describe the positions and times of the spatially coincident clock pairs C1,C1' and C2,C2'. For C1,C1',  $x_0 = x'_0 = \tau_0 = t'_0 = 0$ , while for C2,C2'  $x_0 = x'_0 = L$ ,  $\tau_0 = t'_0 = 0$ . If it is now attempted to describe the times of the clock pair C2,C2' with the LT appropriate to C1,C1' i.e. by using the standard LT of Eq. s (5.17) and (5.18) in the primary experiment and Eq. s (5.24) and (5.25) in the reciprocal experiment, denoted as LT(0), the frame times  $\tau$  and  $\tau'$  and the apparent times  $t'(\tau)$  and  $t(\tau')$  are those shown in the first and second rows of Table 1 (for C1 and C1') and Table 2 (for C2 and C2')<sup>9</sup>. The first row in each table shows the apparent times  $t'(\tau)$  of the clocks at rest in S' as viewed from S in the primary experiment, whereas the second row contains the apparent times  $t(\tau')$  of the clocks at rest in S as viewed from S' in the reciprocal experiment. Also given in Tables 1 and 2 are the positions of the 'moving' clocks in either 'stationary' frame as derived by applying LT(0), or its inverse, to all the clocks.

For example, application of LT(0) to C1 and C1' at  $t = 0$  gives  $x = x' = 0$  and

<sup>9</sup>Note that in (5.17),  $x' = 0$  and in (5.24)  $x = 0$ . When the coordinates of C2 or C2' are substituted in these equations, these values are replaced by  $x' = L$  and  $x = L$  respectively. That is, a formal coordinate substitution is made in the first members of (5.17) and (5.24) without regard to the physical meaning of these equations, that describe correctly only the clocks C1' and C1 respectively.

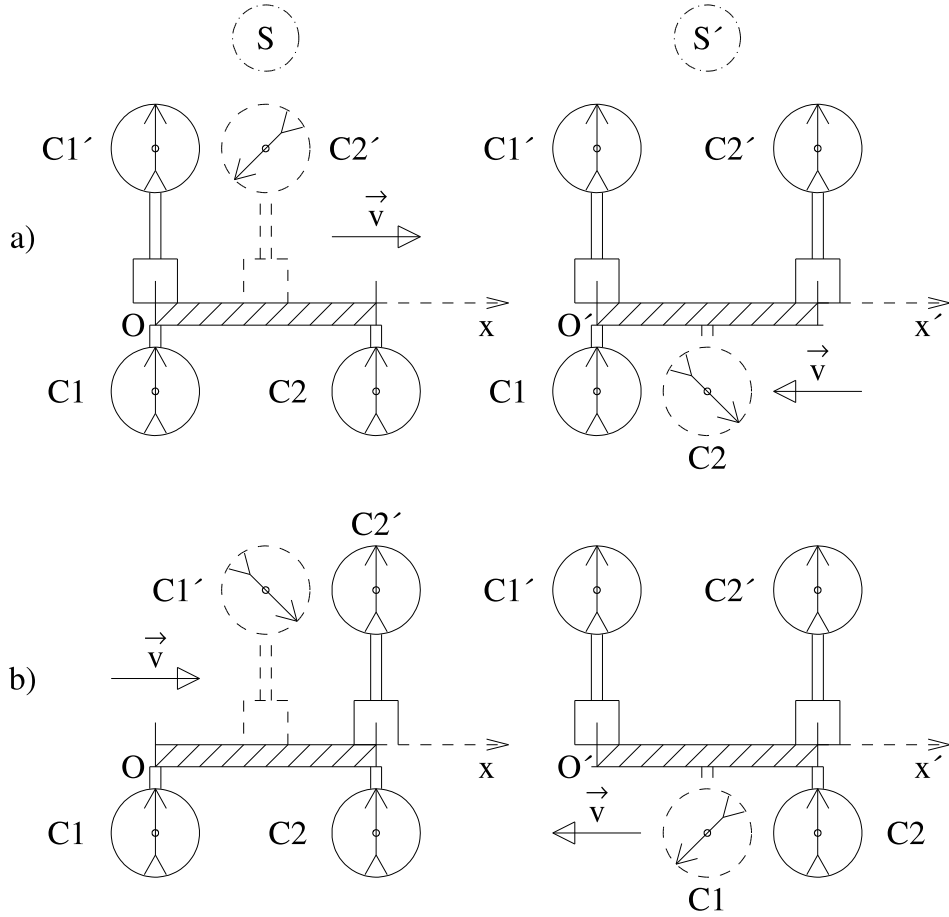

Figure 9: *Examples of misuse of the space-time LT leading to the spurious ‘relativity of simultaneity’ and ‘length contraction’ effects in primary experiment (frame  $S$ ) and in the reciprocal experiment (frame  $S'$ ). The clocks  $C1$ ,  $C2$ ,  $C1'$  and  $C2'$  are assumed to be initially synchronised by length transport as shown in Fig. 8a. In a),  $LT(0)$ , appropriate for  $C1$  and  $C1'$  is applied also to  $C2$  and  $C2'$ . In  $S$ ,  $C1$  and  $C2$  are assumed to be synchronised at  $t = 0$ . Setting  $x' = L$  for  $C2'$  in  $LT(0)$  then gives the apparent position (dashed) and time for  $C2'$  shown. In  $S'$   $C1'$  and  $C2'$  are assumed to be synchronised at  $\tau' = 0$ . Setting  $x = L$  for  $C2$  gives the apparent position (dashed) and time for  $C2$  as shown. The distance between  $C1'$  and the apparent position of  $C2'$  in  $S$  shows the ‘length contraction’ effect. Also the apparent time of  $C2'$  is not synchronous with the frame times of  $C1$  and  $C2$ . This is the ‘relativity of simultaneity’ effect. Reciprocal effects are seen in a) by the observer in  $S'$ . In b) the transformation  $LT(L)$ , appropriate for  $C2$  and  $C2'$  is applied also to  $C1$  and  $C1'$ . As in a), ‘length contraction’ occurs between the pairs  $C1', C2'$  viewed from  $S$  and  $C1, C2$  as viewed from  $S'$ , but now it is  $C1, C1'$  instead of  $C2, C2'$ , as in a) that show ‘relativity of simultaneity’. See the text for further discussion. Parameter values and units as in Fig. 8.*

$t'(t) = 0$ . Setting  $\tau = 0$  and  $x' = L$  in the inverse of (5.18):

$$\tau = \gamma(t'(\tau) + \frac{vx'}{V^2}) \quad (6.1)$$

(i.e. now applying LT(0) to the clock C2') gives  $t'(\tau) = -vL/V^2$ . Substituting this value for  $\tau'$  and  $x' = L$  into the the inverse of (5.17):

$$x = \gamma(x' + v\tau') \quad (6.2)$$

gives the 'apparent' position  $x(t)$  of C2' of

$$x(0) = \gamma L(1 - \frac{v^2}{V^2}) = \frac{L}{\gamma}. \quad (6.3)$$

The difference between the position  $x = 0$  of C1 or C1' and the above apparent position of C2' is then  $L/\gamma$ . This is the well-known relativistic 'length contraction' effect. It is seen to be a spurious consequence of the application of LT(0) appropriate for the synchronised clocks C1 and C1' also to the clocks C2 and C2' for which the synchronous behaviour shown in Fig. 8a requires the LT (5.29) and (5.30) in the primary experiment and corresponding equations in the reciprocal experiment, denoted as LT(L). The entries in the second rows of Tables 1 and 2 are obtained by inverting the roles of the frames S and S' in the calculation just performed, that is, for the primary experiment, by substituting  $\tau' = 0$  and  $x = L$  into LT(0). The entries in the third and fourth rows of Table 1 are the results of performing analogous calculations where the correct transformation for C2 and C2', LT(L), is also applied (incorrectly) to C1 and C1'. The entries of Table 1 and 2 are displayed visually in Fig. 9 where the spurious 'apparent' positions of the moving clocks are indicated by dashed lines.

The so-called 'relativity of simultaneity' effect of Einstein's special relativity theory is apparent in the entries of Table 1 and 2 and in Fig. 9. In Fig. 9a the observer in S in the primary experiment sees that the clocks C1 and C2, at rest in his own frame, are synchronous, but that that the moving clocks C1' and C2' are not. In contrast the observer in S' in the reciprocal experiment judges C1' and C2' to be synchronous, but not C1 and C2 that are in motion relative to him. Thus events that are synchronous in one frame (say, particular times of C1 and C2 as viewed by the observer at rest in S) are not so in another frame (any times indicated by the same two clocks when viewed by an observer at rest in S'). Since an identical and simultaneous synchronisation procedure is applied to the clock pairs C1,C1' and C2,C2' the behaviour shown in Fig. 9a is clearly wrong; it is simply the consequence of using constants in the LT equations for C2 and C2' that do not correctly describe the synchronisation of all four clocks as shown in Fig8a. It is clear from inspection of Eqs(5.23),(5.33) and (5.28) (5.36) that when the constants in the LT are chosen so as to correctly describe the synchronisation procedure, the time ordering of events is the same in any inertial frame –there is, in this case, no 'relativity of simultaneity'. Indeed, this is necessary if causal paradoxes<sup>10</sup> are to be avoided.

In Fig. 9b, are shown the results obtained when the correct LT for the clocks C2, C2', LT(L), is also (incorrectly) applied to the clocks C1 and C1'. In this case C1' is not synchronised with the clocks in S in the primary experiment at  $\tau = 0$ , and C1 is not

---

<sup>10</sup>Some examples are discussed in Reference [26].

synchronised with the clocks in  $S'$  in the reciprocal experiment at  $\tau' = 0$ . Again, the imposed synchronisation of all four clocks in both  $S$  and  $S'$  as shown in Fig. 8a is not respected.

Comparing the apparent times of  $C1'$  and  $C2'$ , as viewed from  $S$ , in Fig. 9a and Fig. 9b, it can be seen that  $C1'$  is in both cases in advance of  $C2'$  by 4.5 time units. However, in Fig. 9a,  $C1'$  shows the same time as  $C1$  and  $C2$ , whereas in Fig. 9b it is  $C2'$  that shows the same time as  $C1$  and  $C2$ . Also, although the apparent distance between  $C1'$  and  $C2'$  is always  $1/\gamma$  times the distance between  $C1$  and  $C2$ , the positions of  $C1'$  and  $C2'$  relative to  $C1$  and  $C2$  are different in the two cases. In Fig. 9a,  $C1$  and  $C1'$  are aligned and  $C2'$  is shifted from  $C2$ , whereas in Fig. 9b,  $C2$  and  $C2'$  are aligned and  $C1'$  is shifted from  $C1$ . So, although the size and sign of the ‘relativity of simultaneity’ effect and the size of the ‘length contraction’ effect are the same in Fig. 9a and Fig. 9b, the observer in  $S$  sees that the clocks  $C1'$  and  $C2'$  are in different positions, and show different times, in the two cases. Applying instead the Lorentz transformation  $LT(L/2)$  to  $C1'$  and  $C2'$  in Fig. 9a instead of  $LT(0)$  results again in the same ‘relativity of simultaneity’ and ‘length contraction’ effects, but the apparent positions of  $C1'$  and  $C2'$  are found to be equidistant from  $C1$  and  $C2$  respectively, and neither  $C1'$  nor  $C2'$  is seen to be synchronous with  $C1$  and  $C2$ . In fact, as shown in Reference [8], by a suitable choice of the value of the parameter  $\alpha$  in  $LT(\alpha L)$  given by Eq. s(5.29) and (5.30) —i.e. a different choice of coordinate origin in  $S$ — the apparent position of, say,  $C2'$  in Fig. 9a, can be situated at *any position* along the x-axis! Since evidently the observed positions of the clocks  $C1'$  and  $C2'$  cannot depend, in this way, on an arbitrary choice of the coordinate origin in  $S$ , all the configurations shown in Fig. 9a as well as those just discussed are spurious and unphysical. The correct physical situation, according to the LT and the defined synchronisation procedure at  $t = 0$  is that shown in Fig. 8a. There are then no ‘relativity of simultaneity’ and ‘length contraction’ effects in this example.

## 7 Light at last

The discussion of the previous sections concerned rigorous definitions of the measurement of space and time intervals and the ways in which the results of such measurements are related via Galilean or Lorentz transformations. There is no overlap, after the important remark, quoted above, concerning the measurement of time and the concept of simultaneity, with the approach of Einstein in his first special relativity paper. Einstein postulated that the speed of light has the same value in any inertial frame and that it does not depend on the motion of its source. This highly counter-intuitive property of light is the crux of the conceptual difficulty of special relativity —the point at which classical ‘commonsense’ breaks down. It may be compared, in this respect, with the superposition principle of quantum mechanics. The reader of the present paper has understood the valid conclusion of Einstein’s paper concerning space-time geometry: the time dilation effect, and also why some other predictions of Einstein’s theory: ‘relativity of simultaneity’ and ‘length contraction’ are incorrect, without having to even encounter a ‘light signal’ of the type crucial for Einstein’s analysis of space and time. In the present section it is demonstrated that the properties of light described in Einstein’s second postulate are in fact necessary consequences of the LT and the physical nature of light, which consists of

massless particles —photons.

In the approach of the present paper there is, so far, no connection between the limiting relative velocity,  $V$ , introduced in the derivations of the LT presented in the Appendix and the speed of light,  $c$ . In order to make this connection it is necessary to consider the relativistic kinematics of some arbitrary physical object of Newtonian mass,  $m$ . This is done by introducing the energy-momentum 4-vector,  $P$ , in the frame S of an object of Newtonian mass  $m$ , at rest in the frame S', according to the definitions:

$$P \equiv (P_t, P_x) \equiv mU \equiv m(\gamma V, \gamma v) \quad (7.1)$$

where

$$U \equiv \frac{dX}{dt'} = \left( V \frac{d\tau}{dt'}, \frac{d\tau}{dt'} \frac{dx}{d\tau} \right) = (\gamma V, \gamma v) \quad (7.2)$$

and where the differential form  $d\tau = \gamma dt'$  of the time dilation relation (5.23) has been used. Here  $X \equiv (V\tau, x)$  is the space-time 4-vector specifying the position of the object in S,  $t'$  is the apparent time in S of a clock in the rest frame, S', of the object, and  $U$  is its 4-vector velocity. The relativistic energy,  $E$ , and momentum,  $p$ , of the object are then defined as:

$$E \equiv VP_t = m\gamma V^2, \quad (7.3)$$

$$p \equiv P_x = m\gamma v. \quad (7.4)$$

These last two equations together with the definition of the parameter  $\gamma$  after Eq. (5.18) above, lead to the important kinematical relations connecting  $m$ ,  $V$ ,  $p$  and  $E$ :

$$E^2 = m^2V^4 + p^2V^2, \quad (7.5)$$

$$v = \frac{pV^2}{E} = \frac{pV^2}{(m^2V^4 + p^2V^2)^{\frac{1}{2}}}. \quad (7.6)$$

It is an immediate consequence of Eq. (7.6) that the speed of a massless physical object, in any inertial frame, is just  $V$ . If light consists of such massless particles it follows that  $c = V = \text{constant}$ . This is the first part of Einstein's second postulate.

To prove the second part of the second postulate: that the speed of light does not depend on that of its source, the parallel velocity addition formula, readily derived from the LT equations (5.17) and (5.18), may be used:

$$w = \frac{u + v}{1 + \frac{uv}{V^2}} = \frac{u + v}{1 + \frac{uv}{c^2}}. \quad (7.7)$$

Here,  $u = dx'/d\tau'$  is the velocity of an object relative to S' and  $w = dx/d\tau$  is the velocity of the same object relative to S. Suppose the the light source is a rest in S'. The velocity of the source for an observer at rest in S is then  $v$ , and, since S' is an inertial frame,  $u = u_\gamma = c$ . The velocity of the photon as observed in S is then given by (7.6) as:

$$w_\gamma = \frac{c + v}{1 + \frac{v}{c}} = c. \quad (7.8)$$

i.e., the speed of the photon in S does not depend on the velocity,  $v$ , of the source in S. This is the second part of the second postulate. It has now been shown that the second

postulate necessarily follows from the space-time LT and the fact that light consists of massless particles.

Einstein had himself discovered, earlier in 1905, that light indeed *does consist* of massless particles: his ‘light quanta’, work for which he was later awarded a Nobel Prize, but did not realise that this together with the space-time LT, derived in his special relativity paper, necessarily implied the correctness of the second postulate. However, in 1905, the relativistic kinematics embodied in Eq. s(7.5) and (7.6) above, although already implicit in formulae given in Ref. [5], had not yet been developed. This was done by Planck in 1907 [27].

Note that a complete understanding of the second postulate does not require the introduction of any concept of classical electromagnetism, or any other dynamical theory. In spite of the title of Einstein’s seminal paper, the fundamental concepts necessary for a complete description of the physics of space and time intervals do not depend, in any way, on those of classical electrodynamics, or of any other specific domain of physics. Since, however, any physical law must, when correctly formulated, respect the space-time geometry embodied in the space-time LT, as well as the kinematical relations (7.5) and (7.6), the study of such laws can be used to derive the LT, i.e. to reveal the nature of the underlying space-time geometry. Thus Einstein’s special relativity paper with its strong emphasis on classical electrodynamics was actually, and in just the same way as the earlier work of Voigt [1], Larmor [2] and Lorentz [3] and the contemporary work of Poincaré [21], of an essentially heuristic nature. Indeed, from the perspective of a later century, much more so, in spite of Einstein’s assertion, than the light quantum paper.

The incorrect conclusions of Einstein’s paper (misinterpretations of the physical meaning of the space-time LT) result from an insufficiently rigorous discussion of actual measurements of space and time intervals and their relation to clock synchronisation procedures. More precisely, they were due to a mismatch between the interpretation given to certain symbols and the actual physical measurements to which they should correspond.

## 8 Summary and Discussion

The aim of the present paper has been to construct the fundamental physics of space and time (in the absence of gravitational effects as described by the general theory of relativity) on a more secure foundation than hitherto. Two aspects are discussed: the axiomatic basis of the space-time LT and the experimental science of the measurement of space and time intervals.

After a brief discussion, in the Introduction, of some initial postulates, two previously published [6, 7] axiomatic derivations of the LT are recalled in the Appendix. Two of the three postulates used are weak, and may even seem to be ‘obvious’. None of the postulates refer to electrodynamics or any other dynamical physical theory. The essential logic of the first derivation, in which a universal parameter,  $V$ , with the dimensions of velocity necessarily appears in the course of the calculation, was already followed in Ignatowsky’s derivation of the LT [15] published in 1910. Einstein’s electrodynamics-based 1905 derivation of the LT is then seen to be of an essentially heuristic nature, since



the simplest logical foundations of space-time geometry, as described by the LT, are quite unrelated to Einstein's postulates.

The remainder of the paper is devoted to an attempt to provide a rigorous mathematical description of the measurement of space and time intervals in terms of 'pointer-mark coincidences' or PMCs. Several authors have suggested that such a concept should form the basis for specifying the results of all experiments in physical science [22, 23], but without developing the idea into a calculus that provides a precise definition of raw experimental data and their relation to the mathematical symbols expressing any theoretical prediction of this data. A proposition for such a 'PMC calculus' is given in Section 2.

Different clock synchronisation procedures are described in Sections 3 and 4. Because of the dependence of Einstein's light signal synchronisation procedure on postulated physical properties of light, and its possible subsequent 'conventionality' [12] new, simple, and 'convention free' methods of clock synchronisation are proposed. The first, by 'pointer transport', is applicable to an arbitrary number of clocks in the same inertial frame. The second method, by 'length transport', is applicable to an arbitrary number of clocks in the same, or two different, inertial frames. A practical device, shown in Fig. 6, to synchronise pairs of clocks, one in each of two different inertial frames, is proposed. The associated PMC in the two frames are constructed with the aid of similar light sources, light detectors and screens, at rest in each of the frames.

In Section 5, the relation of measurements of space and time intervals, provided by two pairs of, spatially separated, synchronised, clocks in two different inertial frames, as predicted by the Galilean or Lorentz transformations, is discussed. The length transport method is used to mutually synchronise the four clocks. Two spatially separated clocks, C1 and C2, are situated in the frame S, while two others, C1' and C2', with the same spatial separation as C1 and C2, are situated in the frame S' moving with a uniform velocity relative to S. It is found that the description of the spatial positions of the clocks is the same for the GT and the LT. The measured clock separations are the same in S and S' and are therefore Lorentz invariant quantities. Relativistic time dilation, as predicted by Einstein, by use of the the LT, is found to exist, but the apparent time is the same for *all* synchronised clocks at rest in a given inertial frame, when they are viewed by an observer in a different inertial frame —there is here no 'relativity of simultaneity' as predicted in Einstein's 1905 paper [5].

In Section 6 it is demonstrated how the spurious 'relativity of simultaneity' and 'length contraction' effects of conventional special relativity theory result from an incorrect assignment of space and time offsets in the LT used to describe observations of synchronised clocks in different inertial frames. As previously pointed out [8], the correct description of several synchronised clocks in a given reference frame requires the use of a 'local' LT at each clock, that is, one in which the clock is situated at the origin of coordinates in its own proper frame. The experimentally well-verified [8] time dilation effect is predicted by the use of just such a local LT.

In Section 7, Einstein's counter-intuitive second postulate stating the constancy of the speed of light in different inertial frames, and its source velocity independence, is demonstrated to be a necessary kinematical consequence of the LT and the identification of light with massless particles —photons. This implies that  $c = V$  where  $c$  is the speed of

light and  $V$  is the maximum relative velocity of two inertial frames whose space and time coordinates are related by the LT.

Further consequences of the restriction, in special relativity, to local LT, have been previously discussed in Reference [8]. The relativistic kinematics of point-like physical objects<sup>11</sup> is the same as in conventional SR, since the position of such objects is typically used as their proper frame origin, corresponding to use of a local LT.

The absence of ‘relativistic length contraction’ indicates that certain calculations in classical electrodynamics, where the existence of such an effect is assumed, are in need of revision. One example is a derivation of the Heaviside formula for the electric field of a uniformly moving charge [28, 29], another is the calculation of the force between long, parallel, conductors in motion [30, 31, 32]. See Refs.[33, 34, 35, 36, 37, 38].

Although it has been argued in the present paper and Reference [8] that the ‘relativity of simultaneity’ effect predicted by Einstein is spurious and unphysical its existence (or absence) can, unlike the ‘length contraction’ effect, be readily established using modern experimental techniques. This is because ‘relativity of simultaneity’ is an  $O(\beta)$  effect whereas ‘length contraction’ is of  $O(\beta^2)$ . Satellite experiments to perform such a test are proposed in Reference [39]. In Reference [8] is proposed a different satellite experiment to test for the existence of an observable  $O(\beta^2)$  effect ‘time contraction’ [40], which is absent when special relativistic predictions are based solely on the use of a local space-time LT.

---

<sup>11</sup>This is also true of an extended object whose position is specified as that of its centroid.

## Appendix

In the following, the main features of two previously published [6, 7] derivations of the space-time Lorentz transformation are described. The derivations are based on the three postulates stated in the Introduction: (A) Uniqueness, (B) the measurement reciprocity postulate and (C) Space-time exchange invariance symmetry. The first derivation [6] is based on postulates (A) and (B), the second [7] on (A) and (C). As throughout the present paper, for simplicity, only space-time events lying along the  $x, x'$  axes of the frames S, S', previously introduced, are considered. The generalisation of the first derivation to events in three spatial dimensions can be found in [6].

Both derivations consider first the transformation of space coordinates between S and S'. With a suitable choice of coordinate origins and time offsets, the transformation may be written, in general, as:

$$f_x(x', x, t, v) = 0. \quad (\text{A.1})$$

The postulate (A) will be satisfied provided that the function  $f_x$  in (A.1) has a multi-linear structure:

$$x' + a_1x + a_2t + b_1xx' + b_2xt + b_3x't + cxx't = 0 \quad (\text{A.2})$$

where the coefficients  $a_i, b_j$  and  $c$  may be functions of  $v$  but are independent of  $x', x$  and  $t$ . The velocity of S' relative to S is:

$$v \equiv \left. \frac{dx}{dt} \right|_{x'=\chi'} \quad (\text{A.3})$$

where  $\chi'$  may take any constant value. Differentiating (A.2) with respect to  $t$  and using (A.3) gives:

$$v = -\frac{a_2 + b_2x + b_3\chi' + c\chi'x}{a_1 + b_1\chi' + b_2' + c\chi't}. \quad (\text{A.4})$$

Since this equation must hold for all values of  $x$  and  $t$  it follows that  $b_2 = c = 0$  so that:

$$v = -\frac{a_2 \left(1 + \frac{b_3\chi'}{a_2}\right)}{a_1 \left(1 + \frac{b_1\chi'}{a_1}\right)}. \quad (\text{A.5})$$

This equation holds for all values of  $\chi'$  provided that:

$$\frac{b_3}{a_2} = \frac{b_1}{a_1} \quad (\text{A.6})$$

in which case:

$$v = -\frac{a_2}{a_1}. \quad (\text{A.7})$$

Substituting the above values of the coefficients into (A.2) gives:

$$x' = \frac{a_1(v)(x - vt)}{\frac{b_1(v)(x-vt)}{a_1(v)} - 1}. \quad (\text{A.8})$$

Making the substitutions  $x \rightarrow -x, x' \rightarrow -x', v \rightarrow -v$ , i.e. inverting the direction of the  $x, x'$  axes, the relation

$$x' = \frac{a_1(-v)(x - vt)}{-\frac{b_1(-v)(x-vt)}{a_1(-v)} - 1} \quad (\text{A.9})$$

is obtained. Consistency with (A.8) requires that:

$$a_1(-v) = a_1(v), \quad b_1(-v) = -b_1(v) \quad (\text{A.10})$$

so that  $a_1$  is an even,  $b_1$  an odd, function of  $v$ . However  $b_1$  has dimension  $[\text{L}^{-1}]$ , and since the only quantities in the problem with this dimension are  $1/x$  and  $1/x'$ , the definitions of the coefficients in (A.2) and dimensional consistency require that  $b_1$  vanishes. In this case (A.8) becomes:

$$x' = \gamma(x - vt) \quad (\text{A.11})$$

where

$$\gamma \equiv -a_1 \quad (\text{A.12})$$

and  $\gamma(v = 0) = 1$ .

Considering now the time transformation equation with the same choice of coordinate origins and time offsets as (A.1):

$$f_t(t', x, t, v) = 0. \quad (\text{A.13})$$

The postulate (A) will be satisfied provided that

$$t' + A_1x + A_2t + B_1xt' + B_2xt + B_3t't + Cxt't = 0. \quad (\text{A.14})$$

Differentiating with respect to  $t$ , using the definition (A.3) and rearranging gives:

$$v = -\frac{[(dt'/dt)[1 + B_1x + (B_3 + Cx)t] + A_2 + B_2x + (B_3 + Cx)t']}{A_1 + B_1t' + (B_2 + Ct')t}. \quad (\text{A.15})$$

Since  $v$  is independent of  $x$ ,  $t$  and  $t'$ ,

$$B_1 = B_2 = B_3 = C = 0 \quad (\text{A.16})$$

so that (A.15) may be written as

$$v = -\frac{[dt'/dt + A_2]}{A_1}. \quad (\text{A.17})$$

Using the conditions (A.16) and (A.17) the time transformation equation simplifies to

$$t' = \gamma^\dagger \left( t - \frac{\delta x}{v} \right) \quad (\text{A.18})$$

where

$$\gamma^\dagger \equiv -A_2, \quad (\text{A.19})$$

$$\delta \equiv \frac{\tilde{\gamma}\gamma^\dagger - 1}{\tilde{\gamma}\gamma^\dagger}, \quad (\text{A.20})$$

$$\frac{1}{\tilde{\gamma}} \equiv \frac{dt'}{dt}. \quad (\text{A.21})$$

Solving (A.11) and (A.18), the inverse transformation equations are:

$$x = \frac{1}{1 - \delta} \left[ \frac{x'}{\gamma} + \frac{vt'}{\gamma^\dagger} \right], \quad (\text{A.22})$$

$$t = \frac{1}{1 - \delta} \left[ \frac{t'}{\gamma^\dagger} + \frac{\delta x'}{\gamma v} \right] \quad (\text{A.23})$$

which may be compared with the same equations given by exchanging primed and unprimed quantities and setting  $v$  equal to  $-v$  in (A.11) and (A.18):

$$x = \gamma(x' + vt'), \quad (\text{A.24})$$

$$t = \gamma^\dagger(t' + \frac{\delta x'}{v}). \quad (\text{A.25})$$

Consistency of (A.22) with (A.24) and of (A.23) with (A.25) requires

$$\gamma = \frac{1}{\gamma(1 - \delta)}, \quad \gamma v = \frac{v}{\gamma^\dagger(1 - \delta)}, \quad (\text{A.26})$$

$$\gamma^\dagger = \frac{1}{\gamma^\dagger(1 - \delta)}, \quad \frac{\gamma^\dagger \delta}{v} = \frac{\delta}{\gamma v(1 - \delta)} \quad (\text{A.27})$$

so that  $\gamma^\dagger \gamma = 1/(1 - \delta) = \gamma^2 = (\gamma^\dagger)^2$ , or  $\gamma^\dagger = \gamma$ . Each equation in (A.26) and (A.27) then gives

$$\delta = \frac{\gamma^2 - 1}{\gamma^2} \quad (\text{A.28})$$

and the time transformation equation is written as<sup>12</sup>

$$t' = \gamma(t - \frac{\delta x}{v}). \quad (\text{A.29})$$

Considering now a clock at rest at  $x' = 0$  and using (A.11) to eliminate  $x$  from (A.29) gives the time dilation relation:

$$t' = \frac{t}{\gamma} \quad (\text{A.30})$$

from which it follows that  $\tilde{\gamma} = \gamma$ . Applying postulate (B) to the reciprocal time dilation experiment gives

$$\gamma'(v') = \gamma(v') = \gamma(v) \quad (\text{A.31})$$

since  $\gamma'$  is the same function of  $v'$  as  $\gamma$  is of  $v$ . (A.31) requires that

$$v' \equiv - \left. \frac{dx'}{dt'} \right|_{x=\chi} = v \equiv \left. \frac{dx}{dt} \right|_{x'=\chi'}. \quad (\text{A.32})$$

Thus in the reciprocal experiment the velocity of an object at rest in the frame S relative to the frame S' is equal and opposite to that of an object at rest in S' relative to the frame S in the primary experiment, described, for example, by (A.11) and (A.29) with  $x' = 0$ <sup>13</sup>. The reciprocity relation (A.32) is now used to complete the derivation of the LT.

---

<sup>12</sup>In Ref. [6], (A.29) was derived directly from the space transformation equation using an argument that did not correctly distinguish a transformation and its inverse from the different transformations describing a primary experiment and its reciprocal, as discussed in Section 5. above. Also the reciprocity relation (A.32) was derived in Ref. [6] by considering the spurious 'length contraction' effect rather than, as here, time dilation.

<sup>13</sup>Notice that (A.32) is essentially a *definition* of the reciprocal experiment as that in which  $v' = v$ , rather than a statement about what would be observed in the frames S and S' in the primary experiment. The relation (A.32) mistakenly interpreted, following Einstein [5], in the latter manner, is usually called the 'Reciprocity Principle' [13] in the literature and text books.

The parameter  $\gamma$  is an even function of  $v$ , the relative velocity of the frames S and S', such that  $\gamma(v=0) = 1$ . There are two possibilities when  $v \neq 0$ ,  $\gamma(v) \geq 1$  or  $\gamma(v) < 1$ . In the former case it follows from (A.28) that: the function  $\delta(v)$  satisfies the inequality:

$$1 \geq \delta(v) \geq 0 \quad (\text{A.33})$$

and in the latter case the inequality:

$$0 > \delta(v) \geq -1. \quad (\text{A.34})$$

Consider now the velocity  $V$ , defined as the solution of the equation  $\delta(V) = 1$  when  $\gamma(v) \geq 1$  and of the equation  $\delta(V) = -1$  when  $\gamma(v) < 1$ . It is clear from the inequalities (A.33) and (A.34), and that in the former (latter) case  $\delta(v)$  is an increasing (decreasing) function of  $v$ , that the meaning of  $V$  is the maximum mathematically allowed relative velocity of any two inertial frames. This is the point at which the universal constant,  $V$ , with dimensions of velocity, makes its entrance into a physical world where space and time measurements in different inertial frames are connected by the Lorentz transformation.

Consider now a massive physical object moving with velocity  $u$  parallel to the positive  $x'$  axis in S'. Its velocity,  $w$ , relative to the positive  $x$ -axis in S may be derived by differentiating (A.11) and (A.29), taking the ratio of the derivatives, making use of the definitions of  $u$  and  $w$ :

$$u \equiv \frac{dx'}{dt'}, \quad (\text{A.35})$$

$$w \equiv \frac{dx}{dt} \quad (\text{A.36})$$

and rearranging the equation so obtained to give:

$$w = \frac{u + v}{1 + \frac{u\delta(v)}{v}}. \quad (\text{A.37})$$

Denoting the frame S by A, S' by B and the proper frame of the physical object introduced above by C, the velocities  $v$ ,  $u$  and  $w$  may be written, in an obvious notation, as relative velocities:

$$v = v_{AB}, \quad u = v_{BC}, \quad w = v_{AC}.$$

So that (A.37) may be written:

$$v_{AC} = \frac{v_{BC} + v_{AB}}{1 + \frac{v_{BC}\delta(v_{AB})}{v_{AB}}}. \quad (\text{A.38})$$

Exchanging the labels A and C in (A.38) gives

$$v_{CA} = \frac{v_{BA} + v_{CB}}{1 + \frac{v_{BA}\delta(v_{CB})}{v_{CB}}}. \quad (\text{A.39})$$

The reciprocity relation (A.32) implies that:

$$v_{CA} = -v_{AC}, \quad v_{BA} = -v_{AB}, \quad v_{CB} = -v_{BC}.$$

Making these substitutions in (A.39) gives:

$$v_{AC} = \frac{v_{BC} + v_{AB}}{1 + \frac{v_{AB}\delta(-v_{BC})}{v_{BC}}}. \quad (\text{A.40})$$

Consistency with (A.38) then requires that

$$\frac{v_{BC}\delta(v_{AB})}{v_{AB}} = \frac{v_{AB}\delta(-v_{BC})}{v_{BC}}. \quad (\text{A.41})$$

which in turn requires (restoring the original notation for the three velocities):

$$\frac{v^2}{\delta(v)} = \frac{u^2}{\delta(-u)} = \frac{V^2}{\delta(V)} = \pm V^2 = \text{constant}. \quad (\text{A.42})$$

The constant in (A.42) is plus or minus the square of the limiting relative velocity  $V$  discussed after Eq. s(A.33) and (A.34) above. The plus sign corresponds to  $\gamma(v) \geq 1$ , the minus sign to  $\gamma(v) < 1$ . Since  $v$  and  $u$  in equation (A.42) are independent quantities the ratios in the first two members of (A.42) must both be equal to the same constant.<sup>14</sup> It is demonstrated in Reference [6] that the choice of a negative constant results in transformation equations that do not respect the Uniqueness postulate (A) and must therefore be discarded in the present derivation. The existence of the universal constant in (A.42) was pointed out already in 1910 by Ignatowsky [15]. Note that setting  $u = v$  in (A.42) implies that  $\delta(v) = \delta(-v)$ , i.e.,  $\delta(v)$  is an even function of  $v$ . Writing  $\beta \equiv v/V$  enables the equation given by the first and fourth members of (A.42) to be written, on taking the plus sign, as  $\delta(v) = \beta^2$ . Substituting this value of  $\delta$  in (A.28) and solving for  $\gamma$  gives:

$$\gamma(\beta)_{\pm} = \pm \frac{1}{\sqrt{1 - \beta^2}}. \quad (\text{A.43})$$

Since (A.11) requires that  $x' \rightarrow x$  when  $v \rightarrow 0$ ,  $\gamma(0)$  must be positive so that the plus sign must be taken in (A.43). The transformation equations relating  $x'$  and  $t'$  to  $x$  and  $t$  are then given by (A.11) and (A.29) as

$$x' = \gamma(\beta)(x - vt), \quad (\text{A.44})$$

$$t' = \gamma(\beta)\left(t - \frac{vx}{V^2}\right) \quad (\text{A.45})$$

where

$$\gamma(\beta) \equiv \gamma(\beta)_+ = \frac{1}{\sqrt{1 - \beta^2}}. \quad (\text{A.46})$$

This completes the first derivation of the space-time Lorentz transformation.

The second derivation [7] follows the same steps as above up to Eq. (A.11). This is the general expression for the space transformation following from the postulate (A). As previously, the parameter  $\gamma$  in (A.9) is (see the first equation in (A.10)) some even function of  $v$ :

$$\gamma(v) = \gamma(-v). \quad (\text{A.47})$$

In order to now apply the constraints of Postulate (C), space-time exchange invariance, to (A.11) it must first be rendered dimensionally homogeneous. This may be achieved by

---

<sup>14</sup>The mathematical situation here is very similar to that of a factorisable solution to a partial differential equation. For example, the Schrödinger equation for an atom with potential depending only on the radial coordinate. The constants relating, in a similar fashion to (A.42), independent terms containing the polar and azimuthal angles and the radial coordinate lead to the conserved angular momentum quantum numbers.

multiplying the time  $t$  by a universal constant  $V$  with the dimensions of velocity. It is clear that this operation may be applied to any quantity with the dimensions of time in any equation of physics. Compensating dimensional changes can always be made in any physical constants appearing in the equation. In this way all space and time coordinates will have the same dimension, [L], and are automatically converted to components of a 4-vector with this dimension. In this way the zeroth components of space-time 4-vectors are defined as:

$$x^0 \equiv Vt, \quad x'^0 \equiv Vt'. \quad (\text{A.48})$$

This enables (A.11) to be written as:

$$x' = \gamma(\beta)(x - \beta x^0). \quad (\text{A.49})$$

Applying the space-time exchange operations [7]  $x \leftrightarrow x^0$  and  $x' \leftrightarrow x'^0$  to (A.49) gives immediately the time transformation equation:

$$x'^0 = \gamma(\beta)(x^0 - \beta x). \quad (\text{A.50})$$

In general the transformation inverse to (A.50) may be written as:

$$x^0 = \gamma(\beta')(x'^0 + \beta' x'). \quad (\text{A.51})$$

The same inverse transformation may be obtained by eliminating  $x$  between (A.49) and (A.50):

$$x^0 = \frac{1}{\gamma(\beta)(1 - \beta^2)}(x'^0 + \beta x'). \quad (\text{A.52})$$

Consistency of (A.51) and (A.52) then requires that:

$$\gamma(\beta') = \frac{1}{\gamma(\beta)(1 - \beta^2)} \quad (\text{A.53})$$

and

$$\beta' = \beta. \quad (\text{A.54})$$

(A.53),(A.54) and the condition that  $\gamma(\beta) \rightarrow 1$  as  $\beta \rightarrow 0$  then gives (A.46) above. On using (A.48) to restore  $t$  and  $t'$  in (A.49) and (A.50) the Lorentz transformation (A.44)-(A.46) is obtained.

It is interesting to note that, in the second derivation, the postulates (A) and (C) necessarily imply the validity of the reciprocity relation (A.54). In the first derivation it is found to be, instead, a necessary consequence of postulates (A) and (B).

In the above derivations, concerning only events lying along the  $x, x'$  axes, no assumption concerning the geometrical properties of space-time, or group-theoretical properties of the transformation, were needed to derive the Lorentz transformation. In the case of events with non-vanishing  $y$  and  $z$  coordinates the additional postulate of spatial isotropy [6] is required to derive the transformation equations of the remaining spatial coordinates:

$$y' = y, \quad (\text{A.55})$$

$$z' = z. \quad (\text{A.56})$$

The derivation of these equations in Reference [6] is very similar to that of Einstein in Reference [5].



## References

- [1] W.Voigt, Goett. Nachr. 1887 p.41.
- [2] J.Larmor, ‘Aether and Matter’, (C.U.P., Cambridge, 1900) Chapter XI.
- [3] H.A.Lorentz, Proc. K. Ak. Amsterdam **6** 809 (1904).
- [4] C.Kittel, Am. J. Phys. **42** 726 (1974).
- [5] A.Einstein, Annalen der Physik **17**, 891 (1905). English translation by W.Perrett and G.B.Jeffery in ‘The Principle of Relativity’ (Dover, New York, 1952) p.37, or in ‘Einstein’s Miraculous Year’ (Princeton University Press, Princeton, New Jersey, 1998) p.123.
- [6] J.H.Field, Helv. Phys. Acta. **70** 542 (1997); arXiv pre-print: <http://xxx.lanl.gov/abs/physics/0410262v1>; Cited 27 Oct 2004.
- [7] J.H.Field, Am. J. Phys. **69**, 569 (2001); arXiv pre-print: <http://arxiv.org/abs/physics/0012011v2>; Cited 10 Jan 2001.
- [8] J.H.Field, ‘The Local Space-Time Lorentz Transformation: a New Formulation of Special Relativity Compatible with Translational Invariance’, arXiv pre-print: <http://xxx.lanl.gov/abs/physics/0501043>. Cited 30 Nov 2007.
- [9] J.H.Field, ‘Spatially-separated synchronised clocks in the same inertial frame: Time dilatation, but no relativity of simultaneity or length contraction, arXiv pre-print: <http://xxx.lanl.gov/abs/0802.3298>; Cited 4 Mar 2008.
- [10] J.H.Field, ‘Clock rates, clock settings and the physics of the space-time Lorentz transformation’, arXiv pre-print: <http://xxx.lanl.gov/abs/physics/0606101>, Cited 4 Dec 2007.
- [11] J.H.Field, ‘Translational invariance and the space-time Lorentz transformation with arbitrary spatial coordinates’, arXiv pre-print: <http://xxx.lanl.gov/abs/physics/0703185v2>, Cited 15 Feb 2008.
- [12] See, for example, P.Anderson, I.Vetharaniam and G.E.Stedman, Physics Reports **295** 93 (1998) and references therein.
- [13] V.Berzi and V.Gorini, Journ. Math. Phys. **10** 1518 (1969).
- [14] Galileo Galilei, ‘Dialogue Concerning the Two Chief World Systems’ English translation, Ed J.A.Green (Greenwood Research, Wichita, Kansas, 2000) p.186.
- [15] W.Ignatowsky, Phys. Zeitschr. **11** 972 (1910).
- [16] W.Pauli, ‘Relativitätstheorie’ (Springer, Berlin 2000). English translation, ‘Theory of Relativity’ (Pergamon Press, Oxford, 1958) Section 4, p.11.
- [17] A.R.Lee and T.M.Kalotas, Am. J. Phys. **43**, 434 (1975).

- [18] J.M.Lévy-Leblond, Am. J. Phys. **44**, 271 (1976).
- [19] N.D.Mermin, Am. J. Phys. **52**, 119 (1984).
- [20] A.Sen, Am. J. Phys. **62**, 157 (1994).
- [21] H.Poincaré, Rend. del Circ. Mat. di Palermo, **21** 129 (1906).
- [22] R.B.Lindsay and H.Margenau, ‘Foundations of Physics’, (Dover, New York, 1957) Section 1.1, P5.
- [23] G.Burniston Brown, Proc. Phys. Soc. Lond.**53** 418 (1941).
- [24] R.P.Feynman. ‘The Character of Physical Law’, (M.I.T. Press, Cambridge, Massachusetts 1986) pps. 130, 145.
- [25] A.Einstein, Annalen der Physik **17** 132 (1905).
- [26] J.H.Field, ‘On the Real and Apparent Positions of Moving Objects in Special Relativity: The Rockets-and-String and Pole-and-Barn Paradoxes Revisited and a New Paradox’, arXiv pre-print: <http://xxx.lanl.gov/abs/physics/0403094v3>. Cited Nov 2007.
- [27] M.Planck, Verh. Deutsch. Phys. Ges. **4** 136 (1906).
- [28] J.D.Jackson, ‘Classical Electrodynamics’, 3rd Ed (Wiley, New York, 1998) pps. 558,560.
- [29] L.D.Landau and E.M.Lifshitz, ‘The Classical Theory of Fields’, 2nd Edition (Pergamon Press, Oxford, 1962) Section 38, p.103.
- [30] R.P.Feynman, The Feynman Lectures in Physics, ‘Electromagnetism I’ (Addison-Wesley, Reading Massachusetts, 1966) Section 13.6.
- [31] W.G.V.Rosser, ‘Introductory Relativity’, (Butterworth, London, 1967) Section 7.2, p.220.
- [32] E.M.Purcell, ‘Electricity and Magnetism’, Berkeley Physics Course Vol II, (McGraw Hill, New York, 1965) Chspter 5.
- [33] J.H.Field, Phys. Scr. **74** 702 (2006); arXiv pre-print: <http://xxx.lanl.gov/abs/physics/0501130v5>; Cited 4 Dec 2006
- [34] J.H.Field, Int. J. Mod. Phys. A Vol 23 No 2 327 (2008); arXiv pre-print: <http://xxx.lanl.gov/abs/physics/0507150v3>; Cited 5 Jul 2007
- [35] J.H.Field, ‘Inter-charge forces in relativistic classical electrodynamics: electromagnetic induction in different reference frames’, arXiv pre-print: <http://xxx.lanl.gov/abs/physics/0511014v4>. Cited 7 Apr 2008
- [36] J.H.Field, ‘Space-time transformation properties of inter-charge forces and dipole radiation: Breakdown of the classical field concept in relativistic electrodynamics’, arXiv pre-print: <http://xxx.lanl.gov/abs/physics/0604089v4>. Cited 4 Apr 2008

- [37] J.H.Field, ‘Retarded electric and magnetic fields of a moving charge: Feynman’s derivation of Liénard-Wiechert potentials revisited’, arXiv pre-print: <http://xxx.lanl.gov/abs/0704.1574v2>. Cited 14 Apr 2008.
- [38] J.H.Field, Phys. Part. Nucl. Lett. **6** 320 (2009); arXiv pre-print: <http://arxiv.org/abs/0706.1661v3>. Cited 17 Jul 2007.
- [39] J.H.Field, ‘Proposals for Two Satellite-Borne Experiments to Test Relativity of Simultaneity in Special Relativity’, arXiv pre-print: <http://xxx.lanl.gov/abs/physics/0509213v4>. Cited 3 Jun 2011.
- [40] J.H.Field, Am. J. Phys. **68** 267 (2000); arXiv pre-print:<http://arxiv.org/abs/physics/0004012v1>. Cited 8 Apr 2000.