

Identifying high power breakdowns in accelerating structures with acoustic sensors

Nicolas Delerue
GLC Group, KEK

Talk given at the 9th Accelerator and Particle Physics Institute

APPI (Japan), February 2004

To increase the energy of Particle Accelerators to reach the requirements of the Linear Collider or of the Super KEK-B factory, new accelerating structures with a higher accelerating gradient need to be developed. These accelerating structures are often affected by high power breakdowns. Knowing the exact location where these breakdowns occurred helps to redesign the structure and improve its performances.

This can be done with acoustic sensors.

1 Accelerating structures R&D

Accelerating structures are used in (mainly in LINACs) to accelerate particles. Usually a very high frequency (Radiofrequency) electromagnetic pulse is fed into the structure. This electromagnetic pulse will create, in the structure, an accelerating gradient that will accelerate the particles beam (see figure 1).

At KEK-B the typical power feed into a structure is 40 MW at 3 GHz (S-band) whereas the structure that should be used in the Linear Collider [1] (if warm technology is chosen) will be fed with 75 MW at a frequency of 11 GHz (X-band). A picture of an X-band accelerating structure is shown

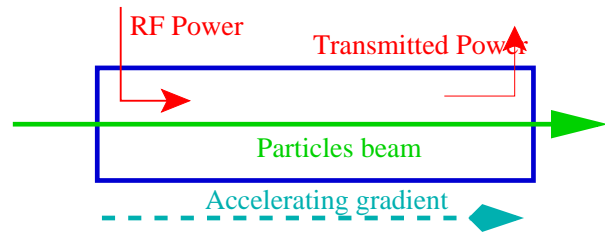

Figure 1: Scheme of an accelerating structure. The electromagnetic wave (red arrows) is inserted at the left of the structure and travels to the right, thus creating an accelerating gradient that will accelerate the particles beam. At the end of the structure the transmitted power is extracted and can be measured.

on figure 2.

As the accelerating gradient depends to the power that was feed into the structure, to increase the accelerating gradient (and reach higher energies) one needs to increase the power of the pulse.

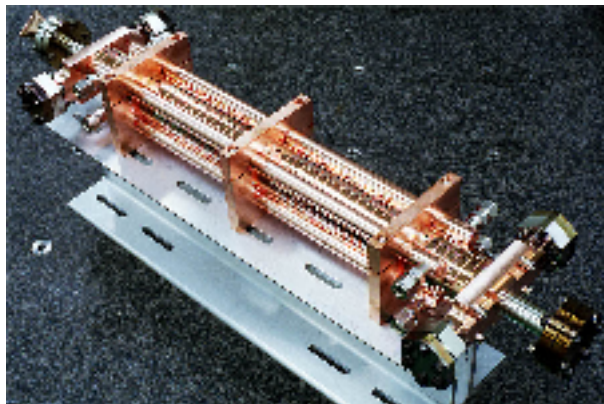

Figure 2: A x-band accelerating structure.

For example, for the upgrade of KEK-B, a higher accelerating gradient is needed as this will allow to reach a higher luminosity. Thus the current S-band accelerating structures will be replaced by C-band (6 MHz) accelerating structures operating with a higher power input (More details on the KEK-B upgrade and the C-band structures R&D can be found in Sugimura Takeshi's contribution to this APPI workshop).

For the Linear Collider the required energy makes it necessary to use X-band structures. Such structures have never been used in an accelerator before before and thus their design is new.

1.1 High power breakdowns

When the energy concentrated on a given point of the structure becomes too high a spark will occur. This can happen at a location where, by design, the energy density is very high, like for example the input coupler of the structure (see figure 3 top) but this can also happen at a location where there is an impurity at the surface of the metal forming the structure (see figure 3 bottom).

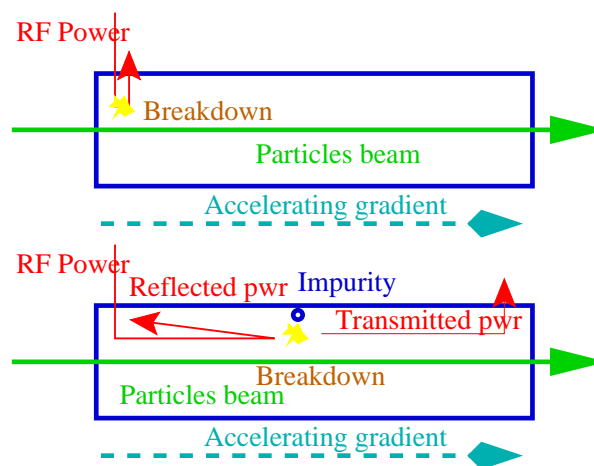

Figure 3: Breakdowns in an accelerating structure. Breakdowns can occur either at the input or output of the structure (top figure) or somewhere else in the structure, for example near an impurity at the surface of the structure (bottom figure). The timing with which power will be transmitted and reflected depends on the location of the breakdown.

A proper identification of the location where the breakdowns occur helps to redesign (in future structures) the location where the power concentrate.

1.2 Breakdowns identification 2 Breakdowns studies for the C-Band structures

There are several different methods to locate where a breakdown occurred.

- As shown on figure 3 when the breakdown occurs the incoming electromagnetic wave is reflected back to the input of the structure. If the breakdown occurs in the middle of the electromagnetic wave, then part of the wave will be reflected whereas the part that had already passed the location of the breakdown will be transmitted. Thus by measuring the shape of the reflected and transmitted waves, it is possible to deduce the location and the time (with respect to the beginning of the wave) at which the breakdown occurred. As the electromagnetic wave is often deformed, this method has a limited precision.
- When the breakdown occurs, noise is produced. By placing acoustic sensors (microphones) near the structure it is possible to detect this noise. If the acoustic sensors are located regularly along the structure it is possible to identify which sensor received the signal first and thus near which sensor the breakdown occurred.
- The breakdowns also produces X-rays that can be detected with conventional X-Ray detectors.
- Other methods exist but are often more expensive or less easy to use than the one mentioned above.

The C-band accelerating structure R&D done at KEK aims to have a suitable structure design for the KEK-B upgrade. This work is conducted by the KEK Linac Upgrade group conducted by Kamitani Takuya (More details on this work can be found in Sugimura Takashi's presentation[2] during this workshop).

There is one accelerating structure currently tested at the KEK main Linac. It has been equipped with 4 acoustic sensors, to which 4 extra sensors were added later as shown on figures 4, 5 and 6. Additionally after each breakdown informations about the RF wave are stored and available for analysis.

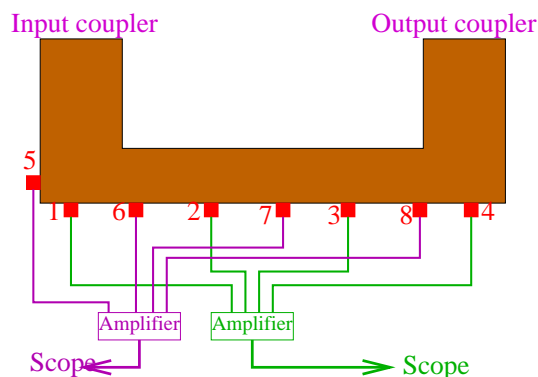

Figure 4: Layout of the 8 acoustic sensors installed on the C-band structure tested at KEK's main Linac.



Figure 5: The C-band structure tested at KEK's main Linac. The acoustic sensors can be seen on top of the structure.



Figure 6: Zoom on 3 sensors installed on top of the C-band structure tested at KEK's main Linac.

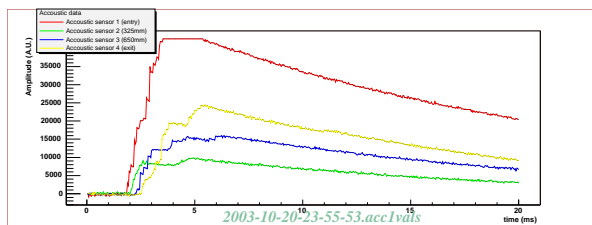

Figure 7: Example of acoustic data recorded during a breakdown at the C-band test stand. Each line corresponds to the noise recorded by a different sensor.

2.1 Acoustic data

On figure 7 one can see an example of breakdown as recorded by the acoustic sensors. The signal is huge and thus easily distinguishable from the background noise. But extracting the breakdown location from this signal is not so easy. One could decide that the sensor the closest from the breakdown will receive the signal earlier (the travel path is shorter) or the more intense (the attenuation should be smaller).

Unfortunately on some events such as the one shown on figure 8 the sensor receiving the signal first is not the one that receives the most intense signal. Furthermore the order in which the sensors receive the signal will not always have a physical interpretation. Thus a double algorithm has been used to locate the breakdown: one is based on the time at which each sensor has received the signal and the other one is based on the intensity of the signal. Attempts to use either intensity or timing information to locate the breakdown between two sensors have not been successful.

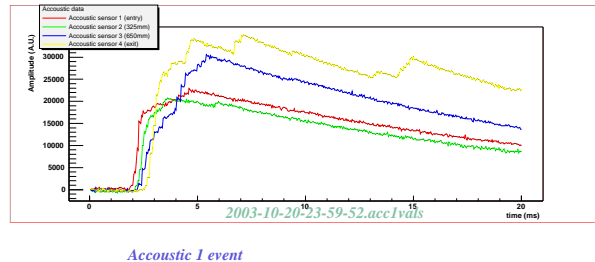
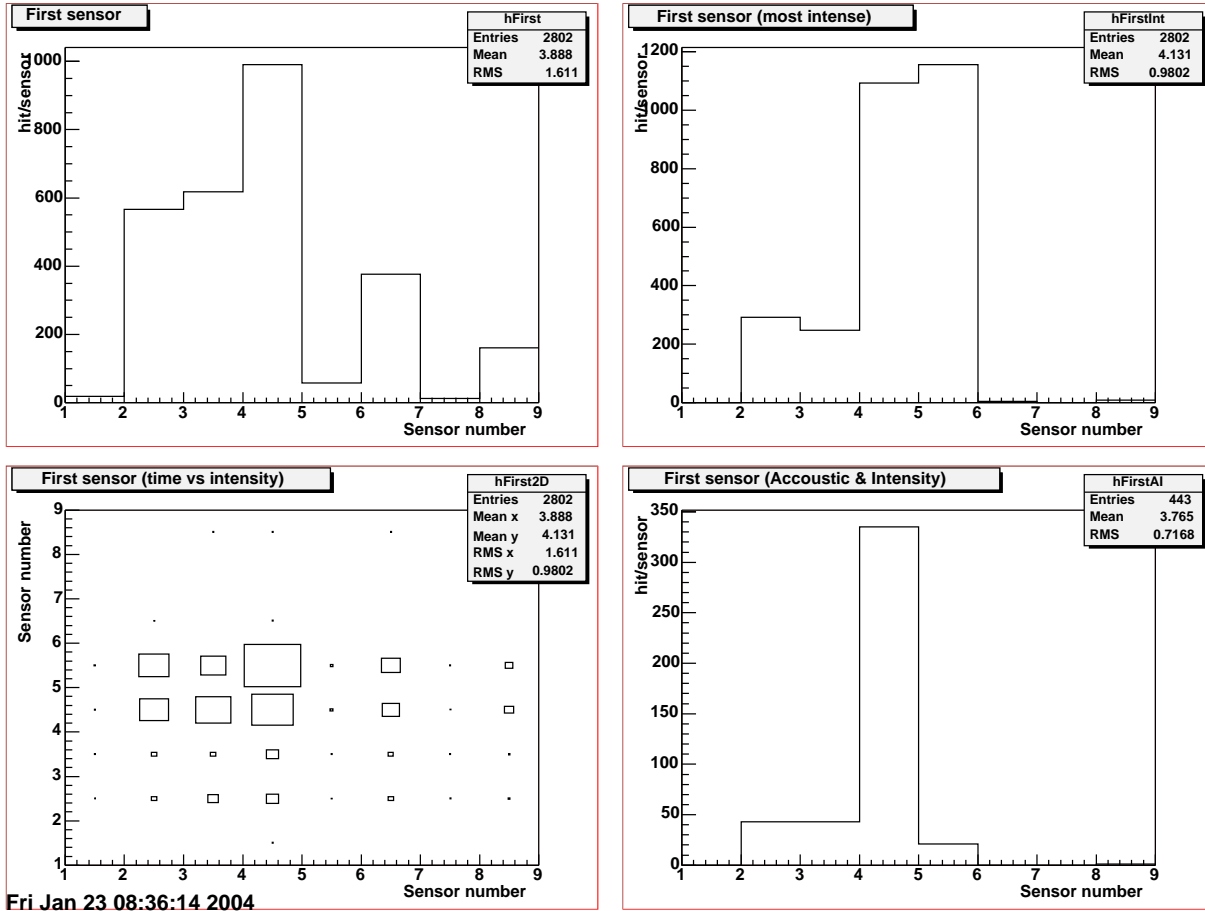

Figure 8: Example of acoustic data recorded during a breakdown. On this event one can see that the sensor receiving the signal first is not the one that receives the most intense signal.



Page 1

Figure 9: Analysis of the breakdowns recorded with the acoustic sensors. The upper left plot shows for each sensor the number of breakdowns where this sensor received the noise first. The upper right plot shows for each sensor the number of breakdowns where this sensor received the most intense signal. The lower left plot shows the correlation between the two upper plots, the horizontal axis corresponding to the sensor that received the noise first and the vertical axis to the sensor that received the most intense signal. The lower right plot shows for each sensor the number of breakdowns where this sensor received the signal first and also received the most intense signal.

The number of breakdowns recorded by each sensor can be seen on figure 9. The upper left plot shows the number of breakdowns that have reached a sensor first, the upper right shows the number of breakdowns that were the most intense for a given sen-

sor. The lower left plot shows the correlations between the two upper plots and the lower right plot shows when the number of breakdowns when timing and intensity information agree (golden events).

From this figure one can see that the breakdowns occur in the forward region of the structure as sensor 2 to 4 record the most intense signal. By looking at the golden events one can see that these events seems to be located inside the structure rather than at its edge as it is sensor 4 that records the more golden events.

2.2 Electromagnetic wave data

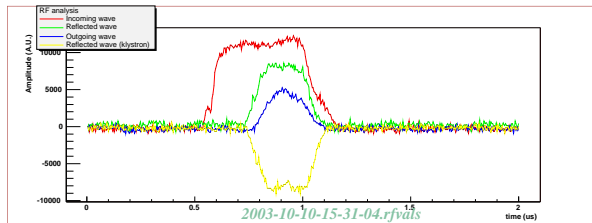

Figure 10: Example of RF data recorded during a breakdown. The red line corresponds to the incoming RF wave, the green line to the reflected RF wave, the blue line to the outgoing wave and the yellow line to the reflected wave at the klystron..

The analysis of the electromagnetic waves is more straightforward. The figure 10 shows an example of electromagnetic wave measurement during an event where a breakdown occurred. The difference between the time at which the outgoing wave (in blue) finishes and the time at which the reflected wave (in green) reaches the input of the structure provides information on the location of the breakdown: if the breakdown occurred close from the output of the structure the outgoing wave will have to

travel a much shorter distance than the reflected wave, thus the time difference between the two will be negative. On the other hand, if the breakdown occurs near the input coupler the reflected wave will have a short travel distance whereas the outgoing wave will have to travel a much longer path, thus the difference will be positive.

The comparison between the length of the incoming electromagnetic wave and the length of the outgoing wave gives the time at which the breakdown occurred.

To measure the resolution of this analysis, it is possible to look at the difference between the time at which the incoming wave is recorded and the time at which the outgoing wave is recorded. This difference corresponds to the time an electromagnetic wave needs to travel the length of the structure and should be constant. The distribution of this variable gives the resolution of the other variables.

The analysis of the electromagnetic waves information is shown on figure 11. From this analysis one can see that there is no specific time at which the breakdown occurs but that almost all breakdowns occur near the input coupler.

2.3 Correlations between electromagnetic and RF wave data

The correlation between the information collected with the acoustic sensors and the electromagnetic waves analysis has been studied. This correlation can be seen on figure 12.

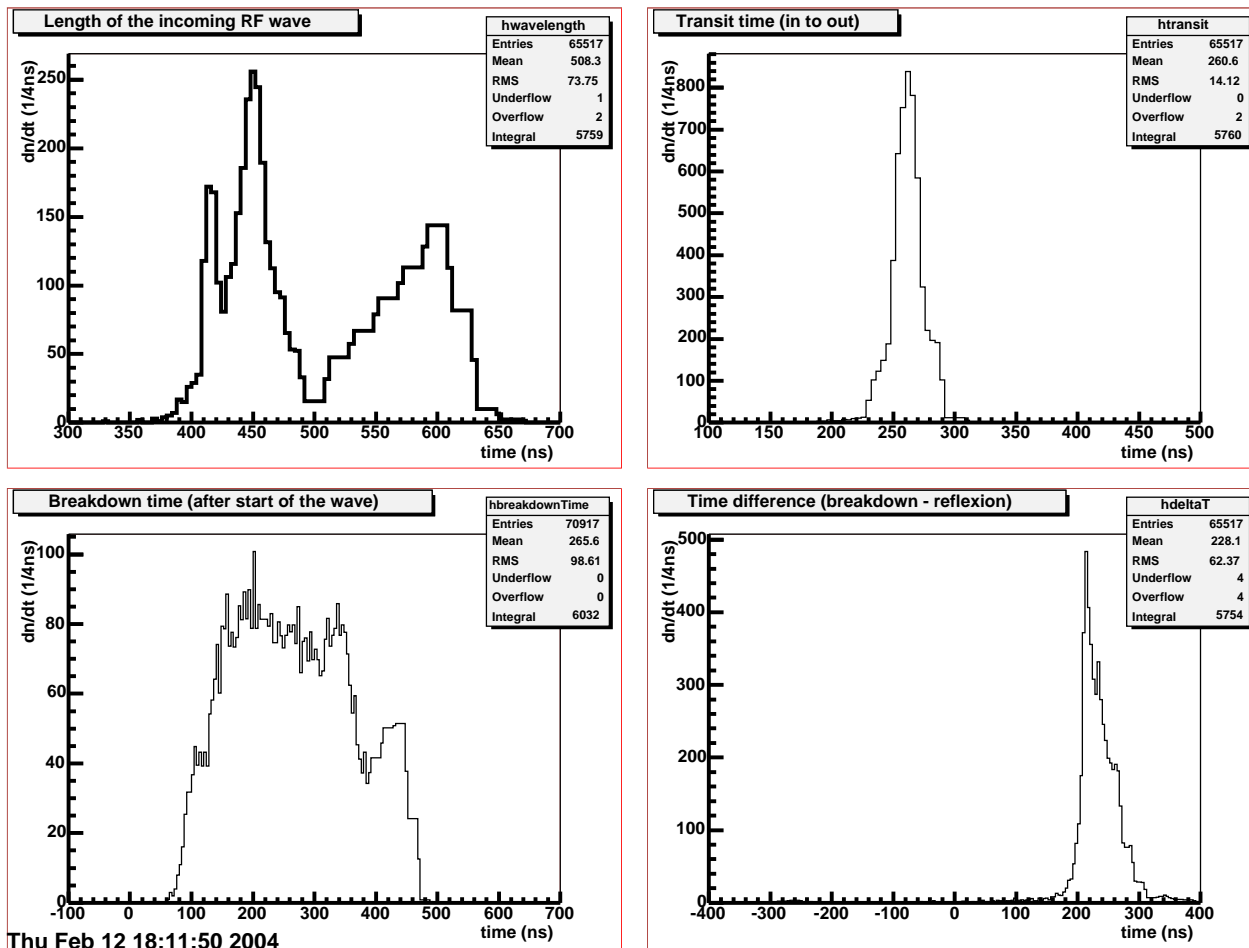

Page 1

Figure 11: Analysis of the electromagnetic waves information recorded with each breakdown. The upper left figure shows the total length of the incoming RF wave. The upper right plot shows the transit time from the input to the output of the coupler. As this time is a constant the width of the peak gives the resolution of our measurement. The lower left plot shows the breakdown time after the start of the wave. The lower right plot gives the difference between the time at which the outgoing and reflected waves were recorded. Positive values correspond to breakdowns near the input kicker.

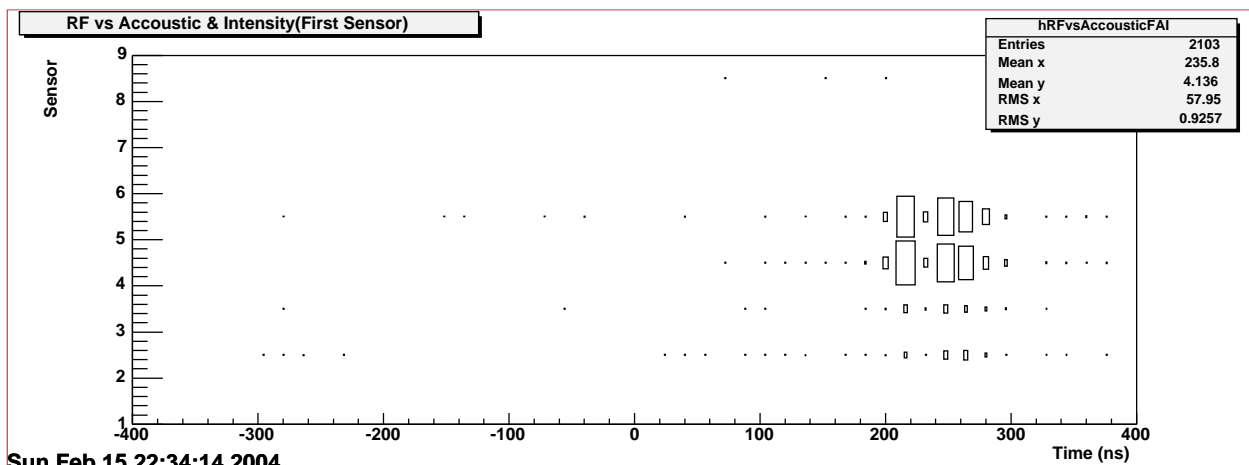
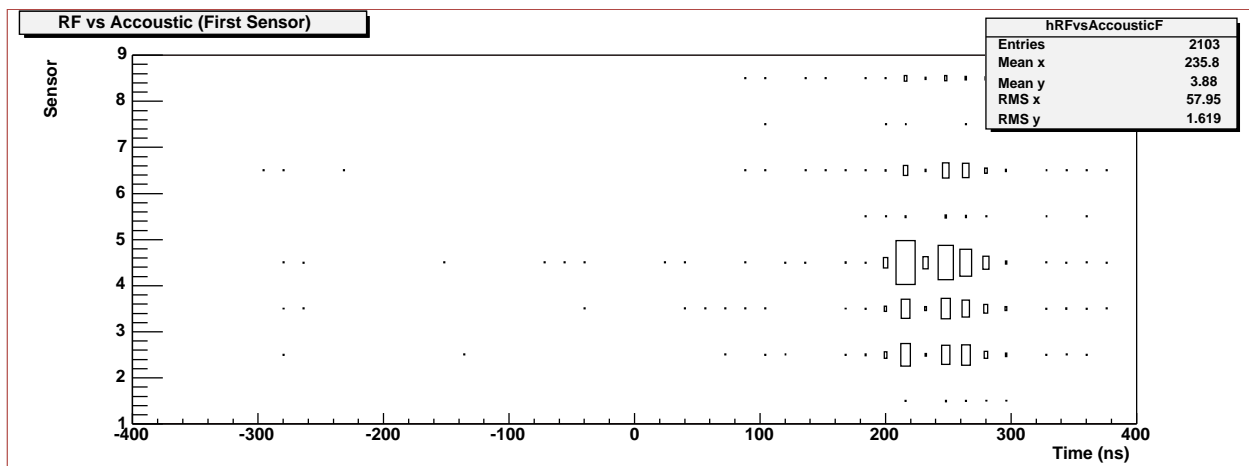

Sun Feb 15 22:34:14 2004

Figure 12: Correlations between the acoustic sensors analysis (vertical scale) and the electromagnetic waves analysis (horizontal scale).

3 Breakdowns studies for the X-Band structures

The X-band accelerating structure R&D done at KEK is part of the worldwide effort to build a X-band Linear Collider (GLC, Global Linear Collider) able to reach a center of mass energy of 1 TeV. This work is conducted at the GLCTA (GLC Test Accelerator) headed by Higo Toshiyasu.

A new test stand has recently been installed at the GLCTA and was under commissioning until March 2004. Thus acoustic sensors were used to detect breakdowns occurring in the waveguide and not in the structure itself. The acoustic sensors used at the GLCTA are read by VME modules. The sensors and the modules have been provided by SLAC where a similar system is already in use[3].

In a first step only 16 sensors have been deployed but in a later step up to 400 sensors will be installed on the structure once the test stand will be fully commissioned.

The VME data acquisition software and the data analysis software have both been written at KEK.

A usual glue was used to stick the acoustic sensors on the waveguides at the location known to be the most likely to produce breakdowns. Acoustic sensors glued on the waveguides can be seen on figures 13 and 14.

3.1 Acoustic data analysis

The figure 15 page 11 (top) shows a typical event as recorded by the acoustic sensors at



Figure 13: A waveguide of the X-band test stand equipped with acoustic sensors.



Figure 14: A piece of waveguide of the X-band test stand with an acoustic sensor.

the X-band test stand.

On this event one can see that even before the breakdown there is a lot of noise recorded by the sensor, especially the klystron noise at the beginning of the record. The figure 15 (bottom) shows an example of non breakdown event with high intensity noise.

Thus to identify a breakdown it is necessary to keep balance between the use of a low threshold which would catch all breakdowns but would also catch non breakdown noise and a higher threshold that would not catch noise but might miss some of the breakdowns.

To address this issue 3 different level of breakdowns have been defined:

- A “simple” level, where all events where the signal passes a given threshold will be considered as a breakdown.
- A “long” level, where all events where the signal passes a given threshold and remains above this threshold for a given time will be considered as a breakdown.
- An “extended” level, where all events where the signal passes a given threshold and remains above this threshold for a given (extended) time will be considered as a breakdown.

Furthermore most of the systematic component of the noise (such as klystron noise) can be removed by subtracting to the recorded noise the average noise recorded during 200 recent events.

The statistical repartition of the breakdowns following this classification can be seen on figures 16 and 17.

These two figures correspond to different configuration of the acoustic sensors. Figure 16 uses data where all sensors were located on the waveguides. Some of them were located on straight section of the pipes whereas some other were located on bends or on a coupler. As one can expect most of the breakdowns were recorded near the bent waveguides and near the coupler. Half of these sensors were moved for the data used by figure 17. Those sensors have been relocated at the end of the accelerating structure, another location where many breakdowns (but also a lot of noise) were expected. The location of the beakdowns on that figure is conform to the expectations.

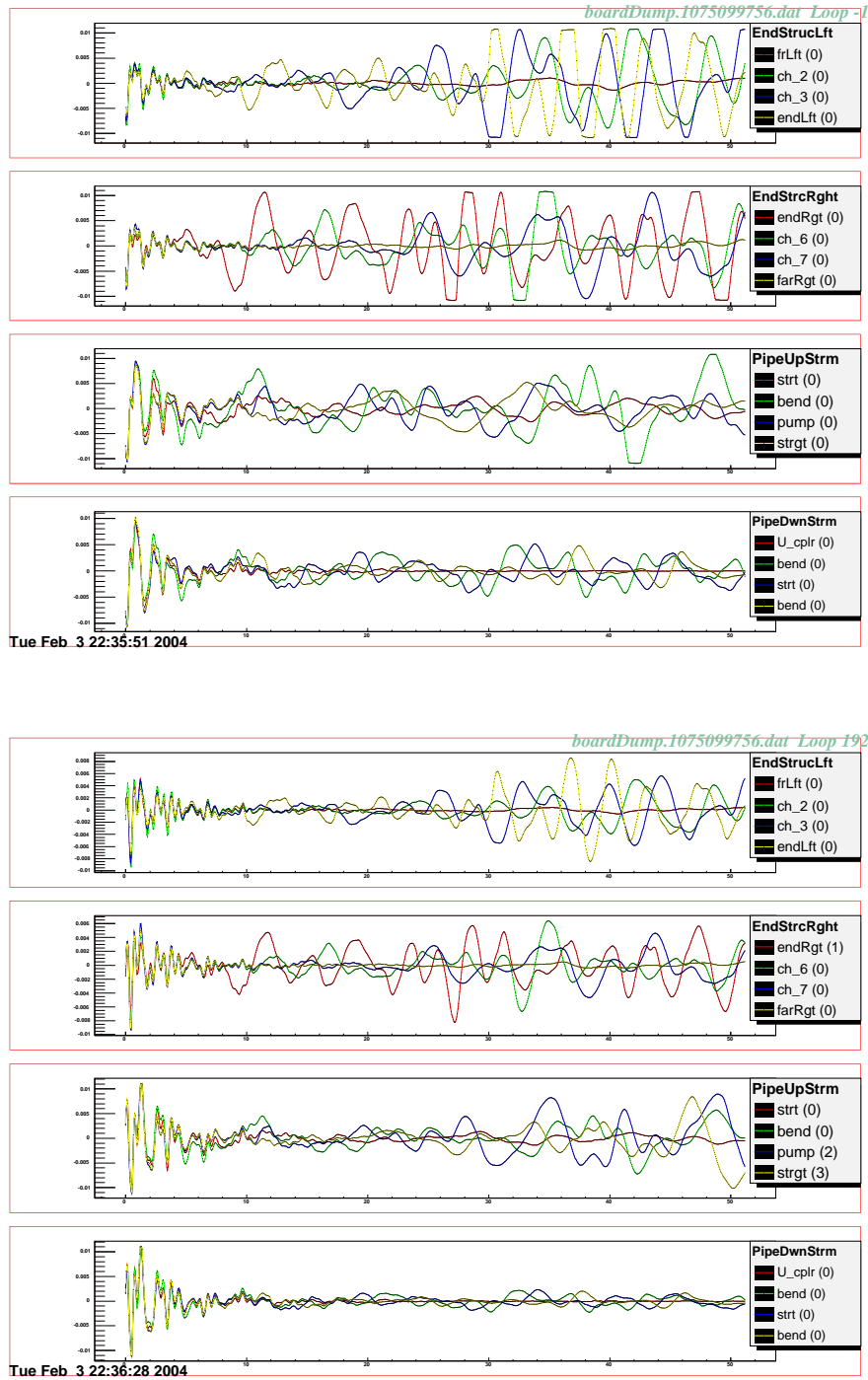
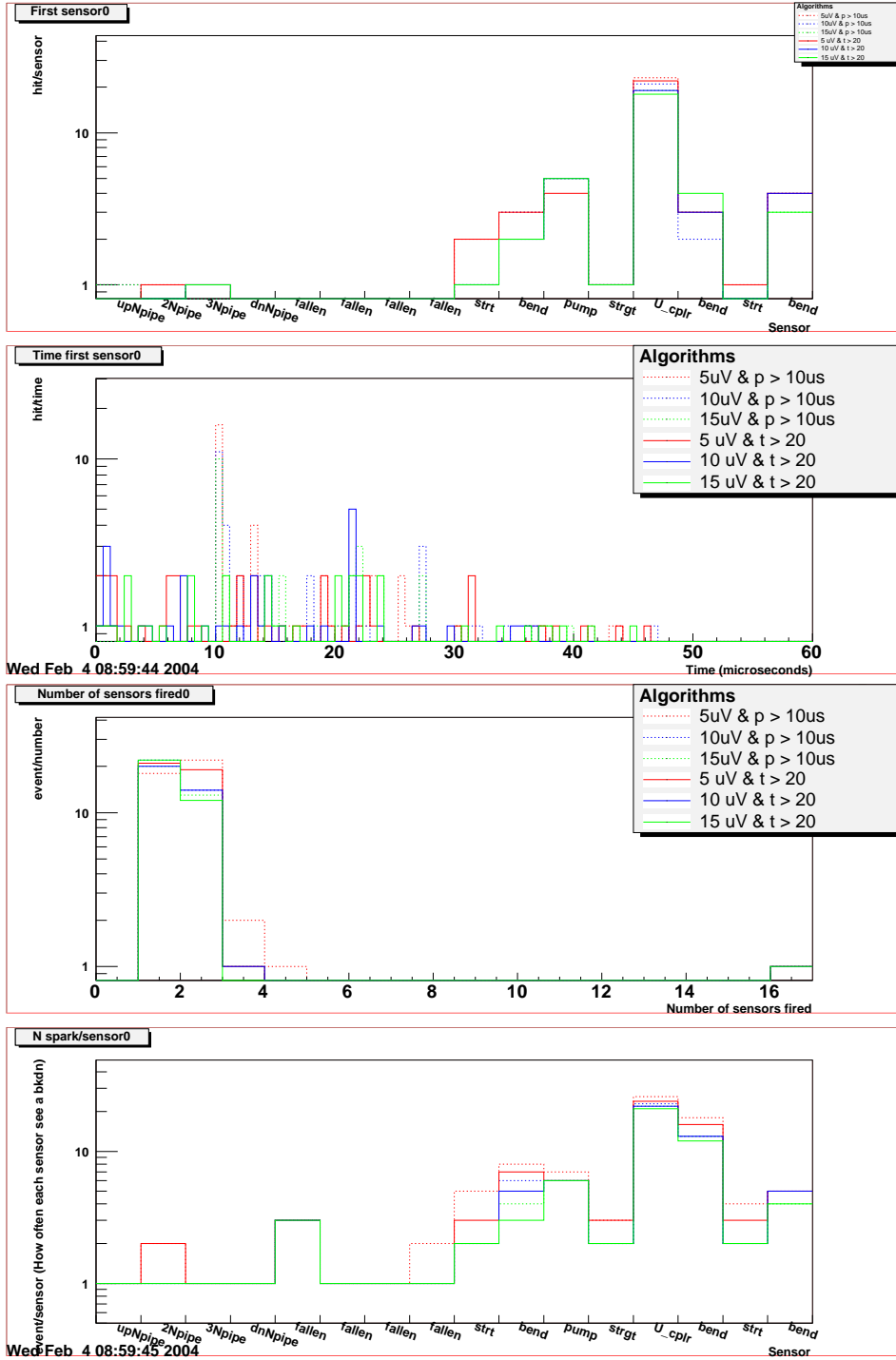
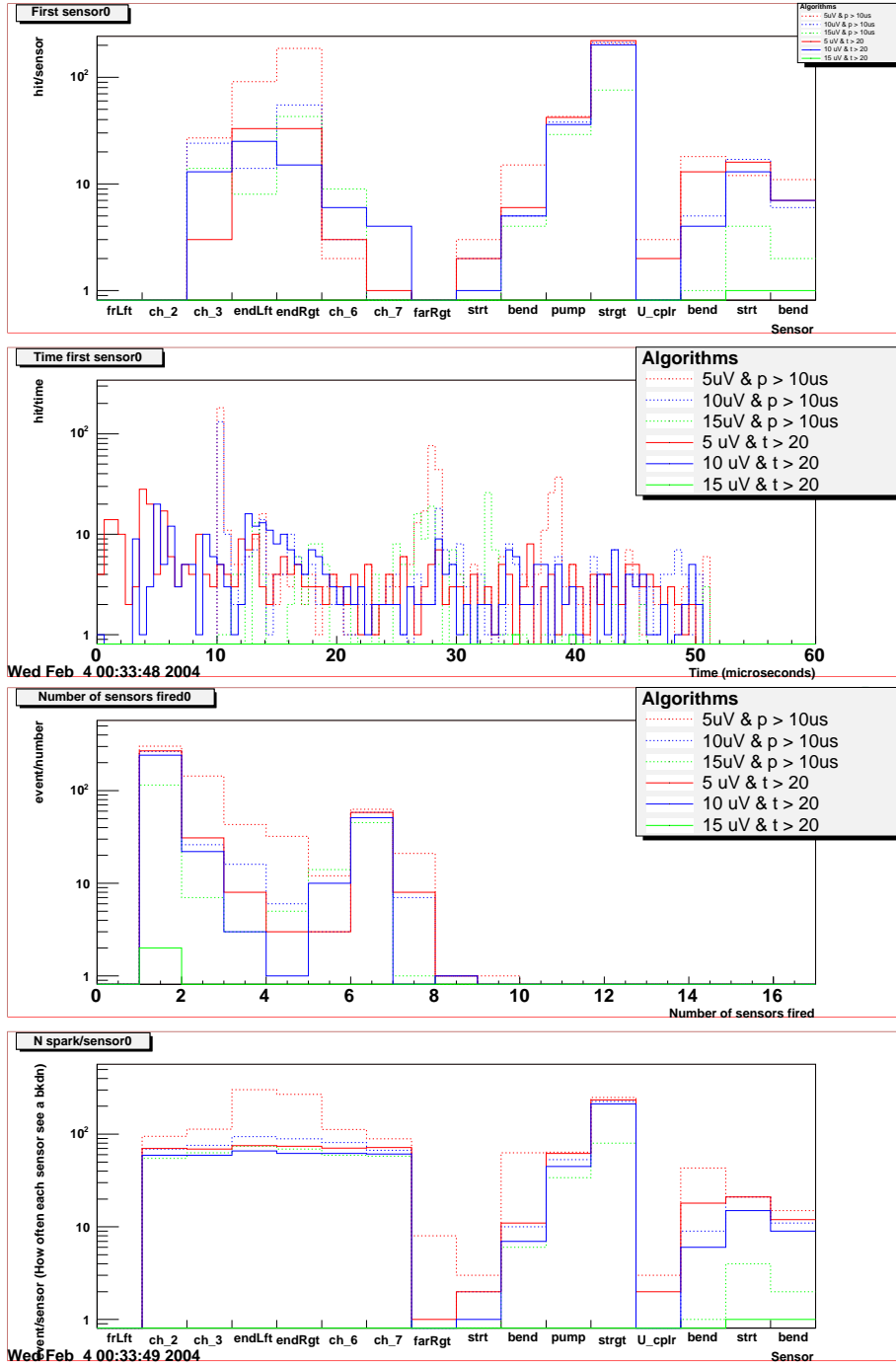

Figure 15: X-band events. On the top figure there is a breakdown on the 4 upper channels (upper plot) whereas on the bottom figure the noise recorded does not correspond to an actual breakdown.



Page 4

Figure 16: X-band analysis. All sensors used for this analysis were installed on waveguide components. The different colors correspond to different breakdown threshold. Dashed line correspond to simple breakdown and plain line to long breakdowns.



Page 4

Figure 17: X-band analysis. Half of this sensors used for this analysis were installed on waveguide components and the other half were installed at the exit of the accelerating structure. The different colors correspond to different breakdown threshold. Dashed line correspond to simple breakdown and plain line to long breakdowns.

4 Conclusion

It has been verified that the information extracted from the acoustic sensors is correlated with the information available from other sources.

Acoustic sensors can provide useful information on the location of breakdowns in an accelerator structure. They are very easy to install and to move to survey different areas of the test stand. The resolution that can be achieved is directly related to the number of sensors available.

References

- [1] GLC project: Linear collider for TeV physics. KEK-REPORT-2003-7.
- [2] Sugimura Takashi. Presentation at the APPI workshop, 2004.
- [3] J. Nelson et al. Use of acoustic emission to diagnose breakdown in accelerator RF structures. Contributed to Particle Accelerator Conference (PAC 03), Portland, Oregon, 12-16 May 2003.