

THE TRIANGULATED HOPF CATEGORY $n_+SL(2)$

VOLODYMYR LYUBASHENKO

ABSTRACT. We discuss an example of a triangulated Hopf category related to $SL(2)$. It is an equivariant derived category equipped with multiplication and comultiplication functors and structure isomorphisms. We prove some coherence equations for structure isomorphisms. In particular, the Hopf category is monoidal.

1. Introduction

Crane and Frenkel proposed a notion of a Hopf category [4]. It was motivated by Lusztig's approach to quantum groups – his theory of canonical bases. In particular, Lusztig obtains braided deformations $U_q\mathfrak{n}_+$ of universal enveloping algebras $U\mathfrak{n}_+$ for some nilpotent Lie algebras \mathfrak{n}_+ together with canonical bases of these braided Hopf algebras [6, 7, 8]. Elements of the canonical basis are identified with isomorphism classes of simple perverse sheaves – certain objects of equivariant derived categories. They are contained in the subcategory of semisimple complexes. One of the proposals of Crane and Frenkel is to study this category rather than its Grothendieck ring $U_q\mathfrak{n}_+$. Conjectural properties of this category were collected into a system of axioms of a Hopf category, equipped with functors of multiplication and comultiplication, isomorphisms of associativity, coassociativity and coherence which satisfy four equations [4]. A mathematical framework and some examples were provided by Neuchl [12].

Crane and Frenkel [4] gave an example of a Hopf category resembling the semisimple category encountered in Lusztig's theory corresponding to one-dimensional Lie algebra \mathfrak{n}_+ – nilpotent subalgebra of $\mathfrak{sl}(2)$. We want to discuss an example of a related notion – triangulated Hopf category – the whole equivariant derived category equipped with multiplication and comultiplication functors and structure isomorphisms. In particular, it is a monoidal category. New feature of coherence is that additive relations of [4] are replaced with distinguished triangles. This new structure does not induce a Hopf category structure of Crane and Frenkel on the subcategory of semi-simple complexes. The missing component is a consistent choice of splitting of splittable triangles. Verification of some of the consistency equations is still an open question.

To give more details let us first recall some braided Hopf algebra H . As an algebra H is the algebra of polynomials of one variable over $R = \mathbb{Z}[q, q^{-1}]$. More precisely, $H \subset \mathbb{Q}(q)[x]$ is an R -submodule spanned by the elements

$$y_n = \frac{x^n}{(n)_{q^{-2}}!}, \quad n \geq 0,$$

$$(n)_{q^{-2}}! = \prod_{m=1}^n (m)_{q^{-2}}, \quad (m)_{q^{-2}} = \frac{1 - q^{-2m}}{1 - q^{-2}}.$$

The basis $(y_n)_{n \geq 0}$ is called a canonical basis.

Date: math.QA/9904108; Edited March 28, 2001; Printed March 29, 2018.

Research was supported in part by National Science Foundation grant 530666.

Multiplication table in this basis is

$$y_k \cdot y_l = \binom{k+l}{k}_{q^{-2}} y_{k+l}, \quad \binom{k+l}{k}_{q^{-2}} = \frac{(k+l)_{q^{-2}}!}{(k)_{q^{-2}}!(l)_{q^{-2}}!} \in R.$$

Comultiplication by definition is

$$y_n = \sum_{k+l=n} y_k \otimes y_l.$$

These operations make H into a \mathbb{Z} -graded R -algebra and coalgebra. We equip the category \mathcal{C} of \mathbb{Z} -graded R -modules with the braiding

$$c : M \otimes_R N \rightarrow N \otimes_R M, \quad c = \sum_{k,l} c_{k,l},$$

$$\begin{array}{c} k \quad l \\ \diagdown \quad / \\ \diagup \quad \diagdown \\ l \quad k \end{array} = c_{k,l} : M_k \otimes N_l \rightarrow N_l \otimes M_k, \quad c_{k,l} = q^{-2kl},$$

where $M = \sum_{k \in \mathbb{Z}} M_k$, $N = \sum_{l \in \mathbb{Z}} N_l$ are graded R -modules. Then H is a Hopf algebra in a braided category \mathcal{C} as defined in [11]. Using graphical notations

$$m = \sum_{k,l} m_{k,l}, \quad \begin{array}{c} k \quad l \\ \diagdown \quad / \\ \diagup \quad \diagdown \\ k+l \end{array} = m_{k,l} : H_k \otimes_R H_l \rightarrow H_{k+l},$$

$$\Delta = \sum_{k,l} \Delta_{k,l}, \quad \begin{array}{c} k+l \\ \diagdown \quad / \\ \diagup \quad \diagdown \\ k \quad l \end{array} = \Delta_{k,l} : H_{k+l} \rightarrow H_k \otimes_R H_l,$$

we can write the coherence axiom as an equation

$$\begin{array}{c} n \quad m \\ \diagdown \quad / \\ \bullet \\ | \\ n+m \\ \bullet \\ | \\ p \quad q \\ \diagup \quad \diagdown \end{array} = \sum_{\substack{i+j=n \\ k+l=m \\ i+k=p \\ j+l=q}} \begin{array}{c} n \quad m \\ \bullet \quad \bullet \\ \diagdown \quad / \quad \diagup \quad \diagdown \\ i \quad j \quad k \quad l \\ \bullet \quad \bullet \\ \diagdown \quad / \quad \diagup \quad \diagdown \\ p \quad q \end{array} : H_n \otimes_R H_m \rightarrow H_p \otimes_R H_q \quad (1)$$

for all $n, m, p, q \in \mathbb{Z}_{\geq 0}$ such that $n + m = p + q$.

This algebra was obtained by Lusztig[8] from the following setup:

$\mathcal{H}_{n_1, \dots, n_k}$ are \mathbb{C} -linear categories, depending symmetrically on parameters $n_1, \dots, n_k \in \mathbb{Z}_{\geq 0}$, $k \in \mathbb{Z}_{\geq 0}$;

$m_{k,l} : \mathcal{H}_{k,l} \rightarrow \mathcal{H}_{k+l}$, $\Delta_{k,l} : \mathcal{H}_{k+l} \rightarrow \mathcal{H}_{k,l}$ are \mathbb{C} -linear functors of multiplication and comultiplication;

$c_{k,l} : \mathcal{H}_{k,l} \rightarrow \mathcal{H}_{l,k}$ are braiding functors;

there are associativity isomorphisms

$$\begin{array}{ccc} \mathcal{H}_{k,l,n} & \xrightarrow{1 \boxtimes m_{l,n}} & \mathcal{H}_{k,l+n} \\ m_{k,l} \boxtimes 1 \downarrow & \simeq & \downarrow m_{k,l+n} \\ \mathcal{H}_{k+l,n} & \xrightarrow{m_{k+l,n}} & \mathcal{H}_{k+l+n} \end{array}$$

where the meaning of \boxtimes will be specified further;

there are similar coassociativity isomorphisms.

The category $\mathcal{H}_{n_1, \dots, n_k}$ is $D_{GL(n_1) \times \dots \times GL(n_k)}^{b,c}(pt)$ – the bounded constructible equivariant derived category of a point. It has a distinguished object Y_{n_1, \dots, n_k} – the constant sheaf, which is the complex

$$\dots \rightarrow 0 \rightarrow 0 \rightarrow \mathbb{C} \rightarrow 0 \rightarrow 0 \rightarrow \dots$$

concentrated in degree 0. It turns out that the collection (Y_{n_1, \dots, n_k}) is closed under multiplication and comultiplication (up to coefficients which are graded vector spaces):

$$m_{k,l}(Y_{k,l}) \simeq H^\bullet(\mathrm{Gr}_k^{k+l}(\mathbb{C}), \mathbb{C}) \otimes_{\mathbb{C}} Y_{k+l}.$$

The coefficient vector space here is de Rham cohomology of the Grassmannian $\mathrm{Gr}_k^{k+l}(\mathbb{C})$ – manifold of k -dimensional subspaces of a $k+l$ -dimensional space. Cohomology is concentrated in even degrees and the Betti numbers

$$\beta_i = \dim_{\mathbb{C}} H^{2i}(\mathrm{Gr}_k^{k+l}(\mathbb{C}), \mathbb{C})$$

are coefficients of the expansion of a q -binomial coefficient in powers of q^{-2} :

$$\binom{k+l}{k}_{q^{-2}} = \sum_{i \geq 0} \beta_i q^{-2i}.$$

Replacing the degree with the power of q we get the multiplication table for the canonical basis (y_k) . Comultiplication law is recovered from

$$\Delta_{k,l}(Y_{k+l}) \simeq Y_{k,l}.$$

The braiding functor

$$c_{k,l} = (D_{GL(k) \times GL(l)}(pt) \simeq D_{GL(l) \times GL(k)}(pt) \xrightarrow{[-2kl]} D_{GL(l) \times GL(k)}(pt))$$

is essentially the degree shift by $-2kl$. It translates into multiplication by q^{-2kl} for the braiding in algebra setting.

In the present paper we shall discuss coherence at the category level. If one replaces linear mappings in equation (1) with functors and \sum with \oplus the equation fails: the left and the right hand side functors $\mathcal{H}_{n,m} \rightarrow \mathcal{H}_{p,q}$ are, in general, not isomorphic. (Restricted to $Y_{n,m}$ they give, however, isomorphic results.) One of the results of the present paper is the following. Value of the left hand side functor on an object X of $\mathcal{H}_{n,m}$ is a repeated extension of values on X of summands in the right hand side in the sense of distinguished triangles. Precise analogy is as follows: a sheaf S on a topological space W is an extension of its quotient-sheaf S_F supported on closed subset F by subsheaf S_U supported on its open complement $U = W - F$.

Technically, this is achieved by introducing new operations-functors with two inputs and two outputs

$$\begin{array}{c} n \\ \diagdown \quad \diagup \\ \quad \mathcal{O} \\ \diagup \quad \diagdown \\ p \quad q \end{array} : D_{GL(n) \times GL(m)}^{b,c}(pt) \rightarrow D_{GL(p) \times GL(q)}^{b,c}(pt),$$

which depend on a parameter \mathcal{O} – a $P_{p,q} \times P_{n,m}$ -invariant subset of $GL(n+m)$, where $p+q = n+m$, the parabolic subgroup $P_{n,m} \subset GL(n+m)$ consists of matrices preserving $\mathbb{C}^n \subset \mathbb{C}^{n+m}$. Minimal such subsets \mathcal{O} are double cosets – points of the double coset space $P_{p,q} \backslash GL(n+m) / P_{n,m}$. This is a finite set, it is in bijection with the set of quadruples (i, j, k, l) , $i, j, k, l \in \mathbb{Z}_{\geq 0}$, which satisfy the equations $i+j = n$, $k+l = m$, $i+k = p$, $j+l = q$. Hence, we may index the $P_{p,q} \times P_{n,m}$ -orbits with these quadruples, say, \mathcal{O}_{ijkl} .

First, we prove that the left and the right hand sides of (1) are isomorphic to the above mentioned operations:

Since $GL(n+m) = \sqcup_{i,j,k,l} \mathcal{O}_{ijkl}$, the former functor above is a repeated extension of the latter functors via distinguished triangles.

This shows usefulness of operations with many inputs and outputs for our purposes. They are also used to prove an equation for associativity isomorphisms which makes $\cup D_{GL(k)}^{b,c}(pt)$ into a monoidal category. Similar equation for coassociativity isomorphisms is proven as well.

Acknowledgements. I am grateful to L. Crane and D. Yetter for fruitful discussions which stimulated this study. Commutative diagrams in this paper are drawn with the help of a package `diagrams` of Paul Taylor.

2. Preliminaries

A definition of equivariant derived categories is given by Bernstein and Lunts [2]. First we explain basic terms. With a topological space X is associated the category $Sh(X)$ of sheaves of topological spaces. Its derived category is denoted $D(X)$. The subcategory consisting of bounded complexes of sheaves is denoted $D^b(X)$. If X is a complex algebraic variety, we call a sheaf *constructible* if it is constructible with respect to some stratification by algebraic submanifolds and stalks are finite-dimensional vector spaces. A complex is cohomologically constructible if its cohomology sheaves are constructible. Subcategory of bounded constructible complexes is denoted $D^{b,c}(X)$.

2.1. Equivariant derived categories

Assume that a complex linear algebraic group G acts algebraically on a complex algebraic variety X . In this setting Bernstein and Lunts [2] define bounded constructible equivariant derived category $D_G^{b,c}(X)$, as a fiber category.

A G -variety P is called free if G acts freely on P and the quotient map $q : P \rightarrow G \backslash P = \overline{P}$ is a locally trivial fibration with the fiber G . A G -resolution of a G -variety X is a G -map $P \rightarrow X$, where the G -variety P is free.

Let $j : \mathcal{J} \rightarrow \text{Res}(X, G)$, $P \mapsto (jP : JP \rightarrow X)$ be a functor to the category of G -resolutions. Let \mathcal{T} denote the category of complex algebraic varieties. Let us denote $\Phi : \text{Res}(X, G) \rightarrow \mathcal{T}$, $(R \rightarrow X) \mapsto \overline{R} = G \backslash R$ quotient functor. Consider the composite functor

$$\Psi : \mathcal{J} \xrightarrow{j} \text{Res}(X, G) \xrightarrow{\Phi} \mathcal{T}, \quad P \mapsto (jP : JP \rightarrow X) \mapsto \overline{JP},$$

and define the fiber-category $D^{b,c}(\Psi)$ as follows.

2.1.1. Definition (Bernstein and Lunts [2]). An object of $D^{b,c}(\Psi)$ is a function $M : \text{Res}(X, G) \ni P \mapsto M(P) \in D^{b,c}(\overline{JP})$ equipped with isomorphisms $\alpha_\nu : (\overline{J\nu})^*(M(R)) \rightarrow M(P)$ given for any $\nu : P \rightarrow R \in \text{Mor } \mathcal{J}$, such that for any pair of composable morphisms $P \xrightarrow{\nu} R \xrightarrow{\mu} S$ we have

$$\alpha_{\mu\nu} = \left[\overline{J(\mu\nu)}^* M(S) \simeq \overline{J\nu}^* \overline{J\mu}^* M(S) \xrightarrow{\overline{J\nu}^* \alpha_\mu} \overline{J\nu}^* M(R) \xrightarrow{\alpha_\nu} M(P) \right].$$

A morphism $\phi : M \rightarrow N$ is a collection $\phi(P) : M(P) \rightarrow N(P)$, $P \in \text{Ob } \mathcal{J}$, compatible with α_ν for any $\nu : P \rightarrow R \in \text{Mor } \mathcal{J}$:

$$\begin{array}{ccc} (\overline{J\nu})^*(M(R)) & \xrightarrow{\alpha_\nu^M} & M(P) \\ (\overline{J\nu})^*\phi(R) \downarrow & = & \downarrow \phi(P) \\ (\overline{J\nu})^*(N(R)) & \xrightarrow{\alpha_\nu^N} & N(P) \end{array}$$

Define *equivariant derived category* as $D_G^{b,c}(X) = D^{b,c}(\Phi)$ in the case of identity functor $j = \text{id} : \mathcal{J} \Longrightarrow \text{Res}(X, G)$.

We shall also use the notation $\frac{X}{G} = D_G^{b,c}(X)$ for equivariant derived category. Notice that, if X is G -free, then $\frac{X}{G}$ is equivalent to $D^{b,c}(G \setminus X)$. Without freeness assumption the former and the latter categories are not equivalent, in general.

Bernstein and Lunts compute the equivariant derived category in the case when X is a point.

2.1.2. Theorem (Bernstein and Lunts [2] Theorem 12.7.2). *Assume that G is a connected linear algebraic group. The triangulated category $D_G^{b,c}(pt)$ is equivalent to the derived category of the category of finitely generated differential graded A -modules, where the graded algebra $A = H^\bullet(BG, \mathbb{C})$ is equipped with zero differential.*

For $G = GL(n, \mathbb{C})$ the algebra A is the algebra of symmetric polynomials of n variables

$$A_n = \mathbb{C}[x_1, \dots, x_n]^{\mathfrak{S}_n} \simeq \mathbb{C}[e_1, \dots, e_n],$$

where $\deg x_i = 2$ and e_j are elementary symmetric functions. For $G = GL(n_1, \mathbb{C}) \times \dots \times GL(n_k, \mathbb{C})$ we have $A = A_{n_1} \otimes_{\mathbb{C}} \dots \otimes_{\mathbb{C}} A_{n_k}$.

2.2. Equivariant derived functors

2.2.1. The inverse image functor. Suppose that $\phi : G \rightarrow H$ is a group homomorphism, and $f : X \rightarrow Y$ is a ϕ -equivariant map. We want to define a functor $f^* = (f, \phi)^* : D_H^{b,c}(Y) \rightarrow D_G^{b,c}(X)$. First, denote $\mathcal{J} = \text{Res}(f, \phi)$ the category, whose objects are ϕ -maps $\underline{f} : P \rightarrow R$ of resolutions, that is,

$$\begin{array}{ccc} P & \xrightarrow{\underline{f}} & R \\ \downarrow & & \downarrow \\ X & \xrightarrow{f} & Y \end{array}$$

commutes. Morphisms $\nu : \underline{f} \rightarrow \underline{f}'$ are pairs of morphisms of resolutions $\nu_1 : P \rightarrow P'$, $\nu_2 : R \rightarrow R'$ such that

$$\begin{array}{ccc} P & \xrightarrow{\underline{f}} & R \\ \nu_1 \downarrow & & \downarrow \nu_2 \\ P' & \xrightarrow{\underline{f}'} & R' \end{array}$$

commutes. Use the functor $j : \text{Res}(f; \phi) \rightarrow \text{Res}(X, G)$, $j(\underline{f} : P \rightarrow R) = P$ and $\Psi = j\Phi$. Bernstein and Lunts [2] have shown that the restriction functor $D_G^{b,c}(X) \rightarrow D^{b,c}(\Psi)$ is an equivalence.

Similarly to Bernstein and Lunts [2] we define the first version of the inverse image functor:

$$f^* : D_H^{b,c}(Y) \rightarrow D^{b,c}(\Psi : \text{Res}(f; \phi) \rightarrow \mathcal{T}),$$

$$\begin{aligned}
f^*(M : R \mapsto M(R) \in D^{b,c}(\overline{R})) \\
= [f^*M : (P \xrightarrow{f} R) \mapsto \underline{f}^*(M(R)) \in D^{b,c}(\overline{P})].
\end{aligned}$$

Next thing is to choose for all (f, ϕ) an equivalence

$$F_{f,\phi} : D^{b,c}(\Psi : \text{Res}(f; \phi) \rightarrow \mathcal{T}) \rightarrow D_G^{b,c}(X)$$

quasi-inverse to the canonical restriction functor

$$\begin{aligned}
\text{Can}_f : D_G^{b,c}(X) &\longrightarrow D^{b,c}(\Psi : \text{Res}(f; \phi) \rightarrow \mathcal{T}), \\
[P \mapsto M(P)] &\longmapsto [(f : P \rightarrow R) \mapsto M(P)].
\end{aligned}$$

The chosen isomorphisms of the composition with the identity functor are denoted

$$\begin{aligned}
\eta_f : [D^{b,c}(\text{Res}(f; \phi) \rightarrow \mathcal{T}) \xrightarrow{F_{f,\phi}} D_G^{b,c}(X) \xrightarrow{\text{Can}_f} D^{b,c}(\text{Res}(f; \phi) \rightarrow \mathcal{T})] \\
\rightarrow \text{Id},
\end{aligned}$$

$$\epsilon_f : \text{Id} \rightarrow [D_G^{b,c}(X) \xrightarrow{\text{Can}_f} D^{b,c}(\text{Res}(f; \phi) \rightarrow \mathcal{T}) \xrightarrow{F_{f,\phi}} D_G^{b,c}(X)].$$

Define the *inverse image functor* of (f, ϕ) as

$$f^* = (f, \phi)^* : D_H^{b,c}(Y) \xrightarrow{f^*} D^{b,c}(\Psi : \text{Res}(f; \phi) \rightarrow \mathcal{T}) \xrightarrow{F_{f,\phi}} D_G^{b,c}(X).$$

For composable maps

$$X \xrightarrow{f} Y \xrightarrow{g} Z \xrightarrow{h} W \quad \text{over} \quad G \xrightarrow{\phi} H \xrightarrow{\psi} K \xrightarrow{\chi} L$$

we define categories $\text{Res}(f, g; \phi, \psi)$ and $\text{Res}(f, g, h; \phi, \psi, \chi)$, whose objects are pairs $(\underline{f}, \underline{g})$ (resp. triples $(\underline{f}, \underline{g}, \underline{h})$) of morphisms of resolutions over (f, g) (resp. (f, g, h))

$$\begin{array}{ccccccc}
P & \xrightarrow{\underline{f}} & R & \xrightarrow{\underline{g}} & S & \xrightarrow{\underline{h}} & Q \\
\downarrow & & \downarrow & & \downarrow & & \downarrow \\
X & \xrightarrow{f} & Y & \xrightarrow{g} & Z & \xrightarrow{h} & W
\end{array}$$

Morphisms are triples $P \rightarrow P', R \rightarrow R', S \rightarrow S'$ (resp. quadruples $\dots, Q \rightarrow Q'$) of morphisms of resolutions compatible with $(\underline{f}, \underline{g}, \underline{h})$ and $(\underline{f}', \underline{g}', \underline{h}')$.

There is an isomorphism $\iota : f^*g^* \simeq (gf)^*$ determined uniquely by the equation

$$\begin{array}{c}
 \begin{array}{ccc}
 & D_H^{b,c}(Y) & \\
 g^* \nearrow & \Downarrow \iota_{g,f} & \searrow f^* \\
 D_K^{b,c}(Z) & \xrightarrow{(gf)^*} & D_G^{b,c}(X)
 \end{array}
 \end{array}
 \begin{array}{c}
 D^{b,c}(\text{Res}(f, g; \phi, \psi) \rightarrow \mathcal{T}) \\
 \uparrow \iota \\
 \sim \\
 D^{b,c}(\text{Res}(f; \phi) \rightarrow \mathcal{T})
 \end{array}
 =
 \begin{array}{c}
 \begin{array}{ccccc}
 D_H^{b,c}(Y) & \xrightarrow{f^*} & D^{b,c}(\text{Res}(f; \phi) \rightarrow \mathcal{T}) & \xrightarrow{F_{f,\phi}} & D_G^{b,c}(X) \\
 \uparrow F_{g,\psi} & \searrow \eta_g & \xrightarrow{\eta_f} & \swarrow \eta_f & \downarrow \\
 D^{b,c}(\text{Res}(g; \psi) \rightarrow \mathcal{T}) & \xrightarrow{i_{g,f}} & D^{b,c}(\text{Res}(g; \psi) \rightarrow \mathcal{T}) & \xrightarrow{f^*} & D^{b,c}(\text{Res}(f; \phi) \rightarrow \mathcal{T}) \\
 \uparrow g^* & \searrow \eta_{gf}^{-1} & \xrightarrow{\eta_{gf}^{-1}} & \swarrow \eta_{gf}^{-1} & \downarrow \\
 D_K^{b,c}(Z) & \xrightarrow{(gf)^*} & D^{b,c}(\text{Res}(gf; \psi\phi) \rightarrow \mathcal{T}) & \xrightarrow{\sim} & D^{b,c}(\text{Res}(f, g; \phi, \psi) \rightarrow \mathcal{T}) \\
 \downarrow (gf)^* & \searrow \eta_{gf}^{-1} & \xrightarrow{\eta_{gf}^{-1}} & \swarrow \eta_{gf}^{-1} & \downarrow \iota \\
 D^{b,c}(\text{Res}(gf; \psi\phi) \rightarrow \mathcal{T}) & \xrightarrow{F_{g,f,\psi\phi}} & D_G^{b,c}(X) & \xrightarrow{\sim} & D^{b,c}(\text{Res}(f; \phi) \rightarrow \mathcal{T})
 \end{array}
 \end{array}
 \quad (2.2.1)$$

2.2.2. The direct image functor. Let $f : X \rightarrow Y$ be a ϕ -map, $\phi : G \rightarrow H$. Assume that X is K -free, where $K = \text{Ker } \phi \subset G$. For our purposes it suffices to define $f_* : D_G^{b,c}(X) \rightarrow D_H^{b,c}(Y)$ as a right adjoint functor to $f^* : D_H^{b,c}(Y) \rightarrow D_G^{b,c}(X)$. Furthermore, we shall use it mainly in the quotient equivalence situation: $H = G/K$, $\phi : G \rightarrow G/K$ is the canonical projection, X is K -free, $Y = K \backslash X$, $f = \pi : X \rightarrow K \backslash X$ is the canonical projection.

2.2.3. Quotient equivalence.

Theorem (Bernstein and Lunts [2]). *Let K be a normal subgroup of G , let X be a G -space which is free as a K -space. Then the quotient map $\pi : X \rightarrow K \backslash X$ gives an equivalence*

$$\pi^* : D_{G/K}^{b,c}(K \backslash X) \rightarrow D_G^{b,c}(X)$$

with a quasi-inverse π_* .

In this situation we shall make a concrete choice of a right adjoint (and quasi-inverse) functor to π^*

$$\pi_* : D_G^{b,c}(X) \rightarrow D_{G/K}^{b,c}(K \backslash X), \quad N \mapsto \pi_* N,$$

$$(\pi_* N)(R \rightarrow K \backslash X) = N(R \times_{K \backslash X} X \rightarrow X)$$

$$\in D^{b,c}(G \backslash (R \times_{K \backslash X} X)) \simeq D^{b,c}((G/K) \backslash R),$$

the equivalence is due to the isomorphism $G \backslash (R \times_{K \backslash X} X) \simeq (G/K) \backslash R$.

2.2.4. Induction equivalence.

Theorem (Bernstein and Lunts [2]). *Let H be a subgroup of G , let X be an H -space. Then the induction map $i : X \rightarrow G \times_H X$, $x \mapsto (1, x)$ gives an equivalence*

$$i^* : D_G(G \times_H X) \rightarrow D_H(X)$$

with a quasi-inverse i_* .

2.2.5. The direct image with proper supports. The following definition belongs to Bernstein and Lunts [2].

2.2.6. Definition. Let $f : X \rightarrow Y$ be a map of G -varieties. For any resolution $\pi : P \rightarrow Y$ there is a pull-back resolution $\bar{\pi}$ of X .

$$\begin{array}{ccc} P \times_Y X & \xrightarrow{\bar{f}} & P \\ \bar{\pi} \downarrow & & \downarrow \pi \\ X & \xrightarrow{f} & Y \end{array}$$

The functor $f_! : D_G^{b,c}(X) \rightarrow D_G^{b,c}(Y)$ maps an object $M : (R \rightarrow X) \mapsto M(R \rightarrow X) \in D^{b,c}(\bar{R})$ to the object $f_! M : (P \rightarrow Y) \mapsto \bar{f}_!(M(P \times_Y X \rightarrow X)) \in D^{b,c}(\bar{P})$ equipped with an isomorphism

$$\alpha_\nu^{f_! M} : \bar{\nu}^* \bar{f}_! M(R \times_Y X \rightarrow X) \xrightarrow[\sim]{\beta} \bar{f}_{P_1} \bar{\nu}^* M(R \times_Y X \rightarrow X) \rightarrow \bar{f}_{P_1} \alpha_\nu^M \bar{f}_{P_1} M(P \times_Y X \rightarrow X)$$

for $\nu : P \rightarrow R$. Here β is a base change isomorphism obtained from the top square of the following prism.

$$\begin{array}{ccccc} & & \overline{R \times_Y X} & \xrightarrow{\bar{f}_R} & \overline{R} \\ & \nearrow \bar{\nu} & \uparrow \bar{f}_P & & \nearrow \bar{\nu} \\ \overline{P \times_Y X} & \xrightarrow{\bar{f}_P} & \overline{P} & & \\ & \searrow \nu & \uparrow f_R & & \\ P \times_Y X & \xrightarrow{f_P} & P & \xrightarrow{\nu} & R \\ & \searrow & \downarrow & & \uparrow \\ & X & & & Y \end{array}$$

Required property of α follows from Lemma B.2.1 (see Appendix).

2.2.7. The equivariant base change isomorphism. Let the pull-back square

$$\begin{array}{ccc} W & \xrightarrow{e} & X \\ h \downarrow & \lrcorner & \downarrow f \\ Z & \xrightarrow{g} & Y \end{array}$$

consist of equivariant maps: h is a G -map, f is an H -map and e, g are ϕ -maps, where $\phi : G \rightarrow H$ is a group homomorphism. There is a commutative cube

$$\begin{array}{ccccc}
P \times_Z W & \xrightarrow{\underline{e}} & R \times_Y X & & \\
\downarrow & \searrow \underline{h} & \downarrow & \searrow \underline{f} & \\
P & \xrightarrow{\underline{g}} & R & & \\
\downarrow & & \downarrow & & \\
W & \xrightarrow{e} & X & & \\
\downarrow & \searrow \underline{i} & \downarrow & \searrow f & \\
Z & \xrightarrow{g} & Y & &
\end{array}$$

where the left and the right walls and the bottom are pull-back squares. It follows that the top is also a pull-back square. We define a version of direct image functor with proper support:

$$\begin{aligned}
h_! : D^{b,c}(\text{Res } e \rightarrow \mathcal{T}) &\rightarrow D^{b,c}(\text{Res } g \rightarrow \mathcal{T}), \quad N \mapsto h_! N, \\
(h_! N)(\underline{g}) &= \bar{h}_!(N(\underline{e})) \in D^{b,c}(\underline{P}),
\end{aligned}$$

where $N(\underline{e}) \in D^{b,c}(\overline{P \times_Z W})$. Notice that the functor $h_!$ depends on f as well, which is not reflected in notation.

The base change isomorphism

$$\begin{array}{ccc}
D^{b,c}(\text{Res } e \rightarrow \mathcal{T}) & \xleftarrow{e^*} & D_H^{b,c}(X) \\
\downarrow h_! & \swarrow \beta & \downarrow f_! \\
D^{b,c}(\text{Res } g \rightarrow \mathcal{T}) & \xleftarrow{g^*} & D_H^{b,c}(Y)
\end{array}$$

comes from the standard one for quotient spaces. The collection

$$(g^* f_! M)(\underline{g}) = \bar{g}^* [(f_! M)(R \rightarrow Y)] = \bar{g}^* \bar{f}_! [M(R \times_Y X \rightarrow X)] \in D^{b,c}(\bar{P})$$

is isomorphic to the collection

$$(h_! e^* M)(\underline{g}) = \bar{h}_! [(e^* M)(\underline{e})] = \bar{h}_! \bar{e}^* [M(R \times_Y X \rightarrow X)] \in D^{b,c}(\bar{P})$$

via base change isomorphism $\beta : \bar{g}^* \bar{f}_! \rightarrow \bar{h}_! \bar{e}^*$.

Finally, we define a full form of base change isomorphism as the following diagram suggests:

$$\begin{array}{ccccc}
D_G^{b,c}(W) & \xleftarrow{F_{f,\phi}} & D^{b,c}(\text{Res } e \rightarrow \mathcal{T}) & \xleftarrow{e^*} & D_H^{b,c}(X) \\
\downarrow h_! & \xrightarrow{\text{Can}_e} & \downarrow h_! & \swarrow \beta & \downarrow f_! \\
D_G^{b,c}(Z) & \xrightarrow{\text{Can}_g} & D^{b,c}(\text{Res } g \rightarrow \mathcal{T}) & \xleftarrow{g^*} & D_H^{b,c}(Y) \\
& \xleftarrow{F_{g,\phi}} & & &
\end{array}$$

Namely, a full base change isomorphism is:

$$\begin{aligned}
\beta : g_{\text{full}}^* f_! &= F_{g,\phi} g^* f_! \xrightarrow{F\beta} F_{g,\phi} h_! e^* \xrightarrow{F h_! \eta_f^{-1}} F_{g,\phi} h_! \text{Can}_e F_{f,\phi} e^* \\
&= F_{g,\phi} \text{Can}_g h_! F_{f,\phi} e^* \xrightarrow{\epsilon_g^{-1}} h_! F_{f,\phi} e^* = h_! e_{\text{full}}^*.
\end{aligned}$$

3. The Hopf category $n_+SL(2)$

3.1. Setup and notations

We partially follow Lusztig [7] and [8], Chapter 9 in notations. Let V be a vector space and

$$G = G_V = GL(V).$$

Let us make the product of $D_G(pt)$ over varying $\dim V$ into a sort of a graded Hopf category.

Assume we are given a decomposition

$$\mathcal{V} : \quad V^1 \oplus V^2 \oplus \dots \oplus V^k = V$$

into vector subspaces. Associate with it a filtration of V

$$0 = V^{(0)} \subset V^{(1)} \subset \dots \subset V^{(n)} = V, \quad V^{(m)} = V^1 \oplus \dots \oplus V^m.$$

$P_{\mathcal{V}}$ is the corresponding parabolic group

$$P_{\mathcal{V}} = \{g \in G_V \mid \forall m \ g(V^{(m)}) \subset V^{(m)}\} = \{g \in G_V \mid \forall m \ g(V^m) \subset V^{(m)}\}$$

and $U_{\mathcal{V}}$ is its unipotent radical. The group

$$L_{\mathcal{V}} = \{g \in G_V \mid \forall m \ g(V^m) \subset V^m\} = \prod_{m=1}^k G_{V^m}$$

is a Levi subgroup of $P_{\mathcal{V}}$.

Notice that $P_{\mathcal{V}}$, $U_{\mathcal{V}}$ need only a filtration to be defined unlike $L_{\mathcal{V}}$, which requires a direct sum decomposition.

3.2. Suggestions for a monoidal 2-category

To provide a final framework for Hopf categories one would be interested to have a symmetric monoidal 2-category of equivariant derived categories. Tensor product of categories would be similar to that of abelian \mathbb{k} -linear categories introduced by Deligne [5]. In particular, $D_G^{b,c}(X) \boxtimes D_H^{b,c}(Y) \simeq D_{G \times H}^{b,c}(X \times Y)$ is desirable. However, this wish does not look realistic. To achieve it, possibly, one has to replace equivariant derived categories with some other kind of categories, so that inverse image functors and direct image functors make sense, and the usual relations still hold.

Let us consider a question of tensor product of functors. Let $f : X \rightarrow Y$, $g : Z \rightarrow W$ be maps of algebraic varieties. Denote by f^* , g^* , $f_!$, $g_!$ the corresponding equivariant derived functors. It is explained in [9] that one choice for $f^* \boxtimes g^*$ is as good as another as long as they are isomorphic. If in the isomorphism class of $f^* \boxtimes g^*$ there is a functor $(f \times g)^*$, we can modify the definition of \boxtimes and set $f^* \boxtimes g^* = (f \times g)^*$. If $f_! \boxtimes g_!$ is isomorphic to $(f \times g)_!$, we can set $f_! \boxtimes g_! = (f \times g)_!$. The isomorphism

$$(\text{Id} \boxtimes g^*) \circ (f_! \boxtimes \text{Id}) \simeq (f_! \boxtimes \text{Id}) \circ (\text{Id} \boxtimes g^*)$$

can be chosen as the base change isomorphism $\beta : (Y \times g)^*(f \times W)_! \rightarrow (f \times Z)_!(X \times g)^*$, constructed for the pull-back square

$$\begin{array}{ccc} X \times Z & \xrightarrow{X \times g} & X \times W \\ f \times Z \downarrow & \lrcorner & \downarrow f \times W \\ Y \times Z & \xrightarrow{Y \times g} & Y \times W \end{array}$$

We stress again that \boxtimes is far from being constructed. Nevertheless, we prove some statements, which can be interpreted as axioms of a Hopf category.

3.3. Braiding

Pretending that the categories $D_{G_{a_1} \times \dots \times G_{a_k}}(pt)$ form a monoidal 2-category, where a_i are some vector spaces, we define a braiding in it via functor

$$c : D_{\prod G_{a_i} \times \prod G_{b_j}}(pt) \xrightarrow{[-2d]} D_{\prod G_{a_i} \times \prod G_{b_j}}(pt) \xrightarrow{\sigma^*} D_{\prod G_{b_j} \times \prod G_{a_i}}(pt),$$

where $d = (\sum_i \dim_{\mathbb{C}} a_i)(\sum_j \dim_{\mathbb{C}} b_j)$ and σ is a permutation isomorphism of groups. The shift functor $K \mapsto K[-2d]$ (the R -matrix) is related to other functors that we are using via the following lemma.

3.3.1. Lemma. *Let $h : E \rightarrow B$ be an affine linear C^∞ -bundle. Then there is a (canonical in B) isomorphism of functors*

$$(D^{b,c}(B) \xrightarrow{h^*} D^{b,c}(E) \xrightarrow{h_!} D^{b,c}(B)) \simeq T^{-2\dim_{\mathbb{C}} h}.$$

Proof. Using Propositions 10.1 and 10.8(2) from [3] we find for any $K \in D^{b,c}(B)$

$$h_! h^* K \simeq h_! h^*(\mathbb{C} \otimes K) \simeq h_!(h^* \mathbb{C} \otimes h^* K) \simeq (h_! h^* \mathbb{C}) \otimes K.$$

Thus we have to prove that $h_! h^* \mathbb{C}_B \simeq h_! \mathbb{C}_E$ is isomorphic to $\mathbb{C}[-2d]$ for $d = \dim_{\mathbb{C}} h$.

Choose a flat connection ∇ on the bundle h . By definition this is a $C^\infty(B)$ -linear homomorphism of Lie algebras of vector fields

$$\nabla : \text{Vect}(B) \rightarrow \text{Vect}(E), \quad \xi \mapsto \nabla_\xi,$$

such that for each point $e \in E$ we have $Th(\nabla_{\xi_e}) = \xi_{h(e)}$, where $Th : T_e E \rightarrow T_{h(e)} B$ is the tangent map to h . The fields ∇_ξ (the horizontal vector fields) form a $2b$ -dimensional (over \mathbb{R}) distribution in E , where $b = \dim_{\mathbb{C}} B$. This distribution is involutive, therefore, by Frobenius theorem, locally there exist coordinates (z_i, u_j) , $i = \overline{1, 2b}$, $j = \overline{1, 2d}$ in E in which leaves of the obtained foliation are described by equations $u_1 = \text{const}, \dots, u_{2d} = \text{const}$. Moreover, z_i can be chosen as $z_i = x_i \circ h$, where x_i are local coordinates on the base B .

The sheaf of differential graded algebras of *fibrewise forms* Ω_{∇}^\bullet is defined as a subsheaf of C^∞ differential forms on E

$$\Omega_{\nabla}^\bullet(U) = \{\omega \in \Omega_E^\bullet(U) \mid \forall \xi \in \text{Vect}(B) \quad i_{\nabla_\xi} \omega = 0 \text{ and } i_{\nabla_\xi} d\omega = 0\}.$$

The second condition may be replaced with $L_{\nabla_\xi} \omega = 0$, since Lie derivative can be computed as $L_{\nabla_\xi} \omega = di_{\nabla_\xi} \omega + i_{\nabla_\xi} d\omega$. Therefore, in local coordinates forms $\omega \in \Omega_{\nabla}^\bullet(U)$ are written as $f(u) du^\beta$. Absence of dz_i is implied by the first condition, and the Lie derivative condition implies independence of the coefficients on z_i coordinates. We conclude that the complex Ω_{∇}^\bullet is a c -soft on fibers of h resolution of the constant sheaf \mathbb{C}_E . Hence, it can be used to compute the complex $h_! \mathbb{C}_E$.

Let V be an open subset of B . Then $h_! \mathbb{C}_E(V)$ is a complex of vector spaces $\Omega_{\nabla,c}^\bullet(h^{-1}(V))$, where c indicates such forms ω that $h^{-1}(K) \cap \text{supp } \omega$ is compact for each compact subset K of B . This complex is exact everywhere except the maximal degree $2d$. It has a map into the algebra of functions on V

$$\alpha(V) : \Omega_{\nabla,c}^{2d}(h^{-1}(V)) \rightarrow C^\infty(V), \quad \omega \mapsto (v \mapsto \int_{h^{-1}(v)} \omega),$$

given by fibrewise integration. Local presentation of ω implies that the function $\alpha(V)(\omega)$ is locally constant, hence, is in $\mathbb{C}_B(V)$. The obtained chain map $\alpha : h_! \mathbb{C}_E \rightarrow \mathbb{C}_B[-2d]$ is a quasi-isomorphism. \square

Another (complex analytic) construction of α will be published elsewhere. It follows the lines of [10], where the case of quasicompact schemes over $\overline{\mathbb{F}_p}$ and ℓ -adic sheaves is considered. In the

analytic setting one can also prove that for any pull-back square

$$\begin{array}{ccc} F & \xrightarrow{j} & A \\ g \downarrow & \lrcorner & \downarrow f \\ E & \xrightarrow{h} & B \end{array}$$

where h is an affine linear bundle (and so is j), we have an equation

$$\begin{array}{ccccc} & & D^{b,c}(E) & & \\ & \nearrow h^* & \downarrow g^* & \searrow h_! & \\ D^{b,c}(B) & & D^{b,c}(F) & & D^{b,c}(B) \\ \downarrow f^* & \nearrow j^* & \Downarrow \alpha_A & \searrow j_! & \downarrow f^* \\ D^{b,c}(A) & \xrightarrow{[-2d]} & D^{b,c}(A) & & \end{array} = \begin{array}{ccccc} & & D^{b,c}(E) & & \\ & \nearrow h^* & \Downarrow \alpha_B & \searrow h_! & \\ D^{b,c}(B) & & D^{b,c}(B) & & D^{b,c}(B) \\ \downarrow f^* & \xrightarrow{[-2d]} & = & \xrightarrow{[-2d]} & \downarrow f^* \\ D^{b,c}(A) & \xrightarrow{[-2d]} & D^{b,c}(A) & & \end{array}$$

This is the precise meaning of canonicity of isomorphism α .

3.3.2. Corollary. *Let $h : E \rightarrow B$ be an affine linear G -bundle (an affine linear bundle equipped with a group homomorphism $G \rightarrow \text{Aut}_{\text{af.lin.bun.}}(h)$). Then there is an isomorphism of functors*

$$(D_G^{b,c}(B) \xrightarrow{h^*} D_G^{b,c}(E) \xrightarrow{h_!} D_G^{b,c}(B)) \simeq T^{-2 \dim_C h}.$$

Proof. The system of isomorphisms α in $D^{b,c}(\overline{P})$ for G -resolutions $P \rightarrow X$ is coherent due to canonicity of α . \square

3.4. Operations

Let two decompositions of V into a direct sum be given:

$$\mathcal{V} : \quad V^1 \oplus V^2 \oplus \dots \oplus V^k = V \quad (3.4.1)$$

$$\mathcal{W} : \quad W^1 \oplus W^2 \oplus \dots \oplus W^l = V. \quad (3.4.2)$$

Let $\mathcal{O} \subset G$ be a left $P_{\mathcal{W}}$ -invariant and right $P_{\mathcal{V}}$ -invariant subset. We associate with it an operation

$$\mathfrak{X}_{\mathcal{W}}^{\mathcal{O}; \mathcal{V}} = \begin{array}{c} V^1 \quad V^2 \quad V^k \\ \diagdown \quad \diagdown \quad \diagdown \\ \mathcal{O} \\ \diagup \quad \diagup \quad \diagup \\ W^1 \quad W^2 \quad W^k \end{array} = \begin{array}{c} V^1 \quad V^2 \quad V^k \\ \diagdown \quad \diagdown \quad \diagdown \\ \mathcal{O} \\ \vdots \\ \diagup \quad \diagup \quad \diagup \\ W^1 \quad W^2 \quad W^k \end{array} = \mathfrak{m}_{\mathcal{W}}^{\mathcal{V}} \circ \Psi_{\mathcal{W}}^{\mathcal{V}}.$$

The components of it are defined below.

Notations. In graphical notations a straight line $\left| X \right.$ labeled by a vector space X denotes category $D_{G_X}(pt)$. A dashed line $\left| \mathcal{X} \right.$ labeled by a filtration \mathcal{X} of a vector space X denotes category $D_{P_{\mathcal{X}}}(pt)$. If a horizontal line crosses a diagram intersecting transversally with several (solid or dashed) open intervals labeled by spaces Y_1, Y_2, \dots and filtrations $\mathcal{X}_1, \mathcal{X}_2$ of spaces X_1, X_2, \dots , this line represents the category $D_{G_{Y_1} \times G_{Y_2} \times \dots \times P_{\mathcal{X}_1} \times P_{\mathcal{X}_2} \times \dots}(pt)$. The order of factors repeats the order of intersection points on the horizontal line.

A vertex (or a horizontal row of vertices) represents a functor from the category, corresponding to horizontal line just above the vertex, to the category represented by a line just below the vertex.

3.4.1. The multiplication. Multiplication operation is

$$\begin{array}{c}
 V^1 \quad V^2 \quad V^k \\
 \diagdown \quad \diagup \quad \diagup \\
 \mathcal{O} \\
 \vdots \\
 \mathcal{W}
 \end{array}
 = \Psi_{\mathcal{W}}^{\mathcal{O}; \mathcal{V}} = \left(D_{L_{\mathcal{V}}}(pt) \xrightarrow{\phi^*} D_{P_{\mathcal{W}} \times L_{\mathcal{V}}}(\mathcal{O}/U_{\mathcal{V}}) \right. \\
 \left. \xrightarrow{\pi_*} D_{P_{\mathcal{W}}}(\mathcal{O}/P_{\mathcal{V}}) \xrightarrow{\alpha_1} D_{P_{\mathcal{W}}}(pt) \right),$$

Here the scheme of multiplication is similar to that in [8]:

$$pt \xleftarrow{\phi} \mathcal{O}/U_{\mathcal{V}} \xrightarrow{\pi} \mathcal{O}/P_{\mathcal{V}} \xrightarrow{\alpha} pt, \quad (3.4.3)$$

where π is a canonical projection. The action of $L_{\mathcal{V}} = P_{\mathcal{V}}/U_{\mathcal{V}}$ in $\mathcal{O}/U_{\mathcal{V}}$ is induced from the action $p.o = op^{-1}$, $p \in P_{\mathcal{V}}$.

In particular, for $l = 1$ we have $P_{\mathcal{W}} = G_V$, $\mathcal{O} = G_V$ and the multiplication operation is

$$\begin{array}{c}
 V^1 \quad V^2 \quad V^k \\
 \diagdown \quad \diagup \quad \diagup \\
 \mathcal{O} \\
 \vdots \\
 \mathcal{W}
 \end{array}
 = \Psi_1^{\mathcal{V}} = \left(D_{L_{\mathcal{V}}}(pt) \xrightarrow{\phi^*} D_{G_V \times L_{\mathcal{V}}}(G_V/U_{\mathcal{V}}) \right. \\
 \left. \xrightarrow{\pi_*} D_{G_V}(G_V/P_{\mathcal{V}}) \xrightarrow{\alpha_1} D_{G_V}(pt) \right),$$

Here the scheme of multiplication is precisely that of Lusztig [8]:

$$pt \xleftarrow{\phi} G_V/U_{\mathcal{V}} \xrightarrow{\pi} G_V/P_{\mathcal{V}} \xrightarrow{\alpha} pt.$$

The particular case $k = 1$, $\mathcal{O} = G_V$ is also important. We have then $L_{\mathcal{V}} = P_{\mathcal{V}} = G_V$, $U_{\mathcal{V}} = 1$, and

$$\Psi_{\mathcal{W}}^1 = \left(D_G(pt) \xrightarrow{\text{pr}_2^*} D_{P_{\mathcal{W}} \times G}(G) \xrightarrow{d_{1*}} D_{P_{\mathcal{W}}}(pt) \right),$$

where $d_1 : G \rightarrow pt$.

3.4.2. Proposition. *The functor $\Psi_{\mathcal{W}}^1$ is isomorphic to the restriction functor $\text{Res}_{P_{\mathcal{W}}, G} : D_G(pt) \rightarrow D_{P_{\mathcal{W}}}(pt)$.*

Proof. A map d_1 is the map $G \twoheadrightarrow pt$. Hence, $d_{1*} : D_{P_{\mathcal{W}} \times G}(G) \rightarrow D_{P_{\mathcal{W}}}(pt)$ is an equivalence with a quasi-inverse $d_1^* : D_{P_{\mathcal{W}}}(pt) \rightarrow D_{P_{\mathcal{W}} \times G}(G)$.

The map $s_0 : pt \rightarrow G$, $s_0(pt) = 1$, is a Δ -map with respect to the homomorphism of groups $\Delta : P_{\mathcal{W}} \rightarrow P_{\mathcal{W}} \times G$, $\Delta(p) = (p, p)$. Furthermore, s_0 is an induction map $pt \xrightarrow{i} (P \times G)/P \xrightarrow{\rho} G$, where $i(pt) = (1, 1)$, $\rho(p, g) = pg^{-1}$ and ρ is a $P \times G$ -map. Therefore, $s_0^* : D_{P_{\mathcal{W}} \times G}(G) \rightarrow D_{P_{\mathcal{W}}}(pt)$ is an induction equivalence. Since $(pt \xrightarrow{s_0} G \xrightarrow{d_1} pt) = \text{id}$, we have

$$(D_{P_{\mathcal{W}}}(pt) \xrightarrow{d_1^*} D_{P_{\mathcal{W}} \times G}(G) \xrightarrow{s_0^*} D_{P_{\mathcal{W}}}(pt)) \simeq \text{Id}.$$

Therefore, $s_0^* \simeq d_{1*}$. Hence,

$$\Psi_{\mathcal{W}}^1 \simeq (D_G(pt) \xrightarrow{\text{pr}_2^*} D_{P_{\mathcal{W}} \times G}(G) \xrightarrow{s_0^*} D_{P_{\mathcal{W}}}(pt)) \simeq \text{Res}_{P_{\mathcal{W}}, G},$$

for $(pt \xrightarrow{s_0} G \twoheadrightarrow pt) = \text{id}$ and $P_{\mathcal{W}} \xrightarrow{\Delta} P_{\mathcal{W}} \times G \xrightarrow{\text{pr}_2} G$ is an inclusion. \square

3.5. Associativity

Assume that besides decomposition (3.4.1) of V into direct sum of V^i we have also decompositions

$$\mathcal{V}^i : \quad V^i = \bigoplus_{m=1}^{m^i} V_m^i.$$

We can produce out of these the decomposition

$$\mathcal{U} : \quad V = \bigoplus_{i,m} V_m^i,$$

$$\begin{array}{ccc}
\frac{pt}{\prod L_{\mathcal{V}^i}} & \xrightarrow{\quad\quad\quad} & \frac{pt}{L_{\mathcal{U}}} \\
\Pi \phi^{i*} \downarrow & & \downarrow \phi_{\mathcal{U}}^* \\
\frac{\prod_i G_{\mathcal{V}^i}/U_{\mathcal{V}^i}}{\prod G_{\mathcal{V}^i} \times L_{\mathcal{V}^i}} & \xrightarrow{\text{pr}_{Y2}^*} \frac{\mathcal{O}/U_{\mathcal{V}} \times \prod_i G_{\mathcal{V}^i}/U_{\mathcal{V}^i}}{P_{\mathcal{W}} \times L_{\mathcal{V}} \times L_{\mathcal{U}}} \xrightarrow{\pi'_*} & \frac{\mathcal{O}/U_{\mathcal{U}}}{P_{\mathcal{W}} \times L_{\mathcal{U}}} \\
\Pi \pi_*^i \downarrow \wr & \pi_*'' \downarrow \wr & \wr \downarrow \pi_{\mathcal{U}*} \\
\frac{\prod_i G_{\mathcal{V}^i}/P_{\mathcal{V}^i}}{\prod G_{\mathcal{V}^i}} & \xrightarrow{\text{pr}_{X2}^*} \frac{\mathcal{O}/U_{\mathcal{V}} \times \prod_i G_{\mathcal{V}^i}/P_{\mathcal{V}^i}}{P_{\mathcal{W}} \times L_{\mathcal{V}}} \xrightarrow{\pi_*'''} & \frac{\mathcal{O}/P_{\mathcal{U}}}{P_{\mathcal{W}}} \\
\Pi \alpha_i^i \downarrow & \text{pr}_{X1} \downarrow & \downarrow \beta_! \\
\frac{pt}{L_{\mathcal{V}}} & \xrightarrow{\phi_{\mathcal{V}}^*} \frac{\mathcal{O}/U_{\mathcal{V}}}{P_{\mathcal{W}} \times L_{\mathcal{V}}} \xrightarrow{\pi_{\mathcal{V}*}} & \frac{\mathcal{O}/P_{\mathcal{V}}}{P_{\mathcal{W}}} \\
& & \downarrow \alpha_{\mathcal{V}!} \\
& & \frac{pt}{P_{\mathcal{W}}}
\end{array}$$

FIGURE 1. Associativity isomorphism

where the lexicographic order of summands is used $V_1^1, \dots, V_{m^1}^1, V_1^2, \dots, V_{m^2}^2, \dots, V_1^l, \dots, V_{m^l}^l$.
An associativity isomorphism is obtained from the isomorphism

$$\begin{array}{ccc}
\begin{array}{c} \nu^1 \downarrow \quad \nu^2 \downarrow \quad \nu^k \downarrow \\ \circ \quad \quad \nu \end{array} & \xrightarrow{\sim} & \begin{array}{c} \text{fan of lines} \\ \downarrow \\ \text{dashed line } u \end{array} = \Psi^{\mathcal{U}}.
\end{array}$$

This isomorphism can be read from the diagram in Figure 1.

The action of $P_{\mathcal{W}} \times L_{\mathcal{V}}$ in $X = \mathcal{O}/U_{\mathcal{V}} \times \prod_i G_{\mathcal{V}^i}/P_{\mathcal{V}^i}$ is the following

$$(p, l).[o \times \prod g_i] = pol^{-1} \times \prod l_i g_i, \quad l = \prod l_i.$$

The map π''' is the quotient map

$$\pi''' : X \rightarrow L_{\mathcal{V}} \backslash X \simeq \mathcal{O}/P_{\mathcal{U}}.$$

The action of $P_{\mathcal{W}} \times L_{\mathcal{V}} \times L_{\mathcal{U}}$ in $Y = \mathcal{O}/U_{\mathcal{V}} \times \prod_i G_{\mathcal{V}^i}/U_{\mathcal{V}^i}$ is the following

$$(p, l, \bar{l}).[o \times \prod g_i] = pol^{-1} \times \prod l_i g_i \bar{l}_i^{-1}, \quad l = \prod l_i, \quad \bar{l} = \prod \bar{l}_i.$$

The maps π' , π'' are the quotient maps

$$\pi' : Y \rightarrow L_{\mathcal{V}} \backslash Y \simeq \mathcal{O}/U_{\mathcal{U}}, \quad \pi'' : Y \rightarrow L_{\mathcal{U}} \backslash Y \simeq X.$$

The canonical projection β comes from the inclusion $P_{\mathcal{U}} \subset P_{\mathcal{V}}$,

$$\beta : \mathcal{O}/P_{\mathcal{U}} \rightarrow \mathcal{O}/P_{\mathcal{V}}.$$

3.6. The associativity equation

Assume that we have the following decompositions of finite-dimensional \mathbb{C} -vector spaces:

$$\begin{aligned} \mathcal{W} : V &= \bigoplus_j W^j, & \mathcal{V} : V &= \bigoplus_i V^i, \\ \mathcal{V}^i : V^i &= \bigoplus_m V_m^i, & \mathcal{V}_m^i : V_m^i &= \bigoplus_p V_{m,p}^i. \end{aligned}$$

These decompositions imply also the following decompositions:

$$\mathcal{U} : V = \bigoplus_{i,m} V_m^i, \quad \mathcal{Y}^i : V^i = \bigoplus_{m,p} V_{m,p}^i, \quad \mathcal{X} : V = \bigoplus_{i,m,p} V_{m,p}^i.$$

Let $\mathcal{O} \subset G_V$ be a left $P_{\mathcal{W}}$ -invariant and right $P_{\mathcal{V}}$ -invariant subset. Associativity isomorphisms give two isomorphisms between the composite operation and the single operation as in diagram

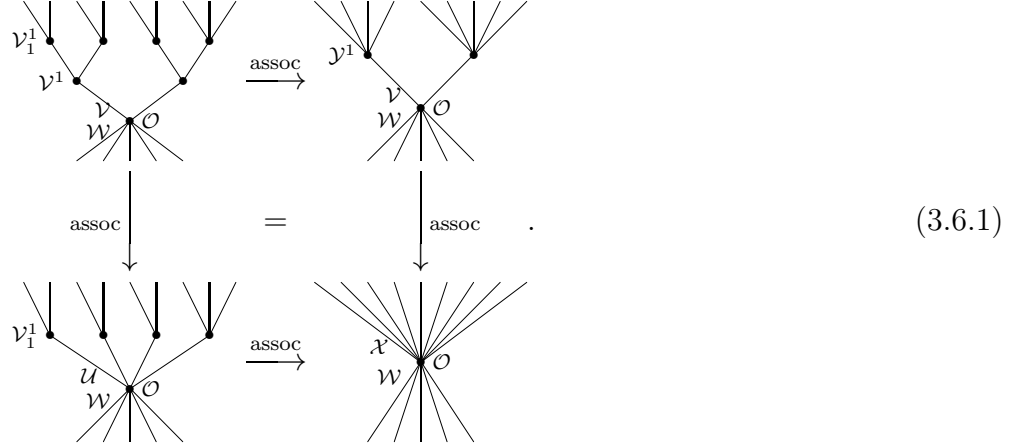

3.6.1. Proposition (Associativity equation). *Diagram (3.6.1) is commutative.*

Proof. The left-lower associativity composition is given on diagram in Figure 2. The right-upper associativity composition is given on diagram in Figure 3. We have to check that isomorphism in this figure equals to the one in Figure 2.

The subdiagram of diagram in Figure 3 between the third and the fourth columns is transformed via Proposition B.2.2 to a 3-column subdiagram. The right part of it coincides with the right subdiagram in Figure 2 between the third and the fourth columns and can be canceled. The left subdiagram of Figure 2 between the first and the third columns is also transformed via Proposition B.2.2. We come to equation between the isomorphisms in Figures 4 and 5.

Figure 4 can be transformed further using Proposition B.2.2 to the form of Figure 6. We have to prove that it equals to isomorphism in Figure 5.

Two lower squares and two rightmost squares in diagrams in Figure 6 and Figure 5 cancel and we have to prove the following equation. We have to show that the isomorphism in Figure 7 is equal to the isomorphism in Figure 8.

Using Proposition B.1.1 we reduce both isomorphisms to the expressions in Figure 9 and Figure 10.

The two upper triangles in Figure 9 and Figure 10 coincide. Due to Proposition B.1.1 the lower parts are equal to isomorphisms in Figure 11.

Finally, the last two isomorphisms are equal to each other due again to Proposition B.1.1. \square

3.7. Comultiplication

The comultiplication functor is

$$\begin{array}{c} \text{---} \\ | \\ \text{---} \\ \diagup \quad \diagdown \\ W^1 \quad W^2 \quad \quad \quad W^l \end{array} \xrightarrow{\quad} \Delta_{\mathcal{W}}^{\mathcal{V}} = \left(\frac{pt}{P_{\mathcal{W}}} \xrightarrow{\text{Res}_{L_{\mathcal{W}}, P_{\mathcal{W}}}} \frac{pt}{L_{\mathcal{W}}} \right) = i_{L_{\mathcal{W}}, P_{\mathcal{W}}}^*.$$

$$\begin{array}{ccccccc}
\frac{pt}{\prod G_{V_m^i}^i} & \xrightarrow{\phi_X^*} & \frac{\mathcal{O}/U_X}{P_W \times L_X} & \xrightarrow[\sim]{\pi_X^*} & \frac{\mathcal{O}/P_X}{P_W} & \xrightarrow{\alpha_X^!} & \frac{pt}{P_Y} \\
\downarrow \prod \phi_m^{i*} & & \uparrow \sim \pi_*' & \nearrow & \downarrow \beta_X^! & \nearrow \alpha_U^! & \uparrow \alpha_Y^! \\
\frac{\prod G_{V_m^i}^i / U_{V_m^i}}{\prod G_{V_m^i}^i / L_{V_m^i}} & \xrightarrow{\text{pr}_2^*} & \frac{\mathcal{O}/U \times \prod G_{V_m^i}^i / U_{V_m^i}}{P_W \times L_U \times L_X} & \xrightarrow[\sim]{\pi_*''} & & & \\
\downarrow \prod \pi_{m^*}^I \wr & & \downarrow \wr \pi_*'' & \nearrow & \downarrow \beta_U^! & \nearrow & \downarrow \beta_Y^! \\
\frac{\prod G_{V_m^i}^i / P_{V_m^i}}{\prod G_{V_m^i}^i} & \xrightarrow{\text{pr}_2^*} & \frac{\mathcal{O}/U \times \prod G_{V_m^i}^i / P_{V_m^i}}{P_W \times L_U} & \xrightarrow[\sim]{\pi_U^*} & \frac{\mathcal{O}/P_U}{P_W} & \xrightarrow{\beta_U^!} & \frac{\mathcal{O}/P_Y}{P_W} \\
\downarrow \prod \alpha_m^{i!} & & \downarrow \text{pr}_{1!} & \nearrow & \downarrow \wr \pi_*''' & \nearrow & \downarrow \wr \pi_{Y^*} \\
& & \frac{\mathcal{O}/U}{P_W \times L_U} & \xrightarrow[\sim]{\pi_U^*} & & & \\
& & \uparrow \wr \pi_*' & \nearrow & \downarrow \wr \pi_*''' & \nearrow & \downarrow \wr \pi_{Y^*} \\
& & \frac{\mathcal{O}/U_Y \times \prod G_{V_i}^i / U_{Y_i}}{P_W \times L_Y \times L_U} & \xrightarrow[\sim]{\pi_*''} & \frac{\mathcal{O}/U_Y \times \prod G_{V_i}^i / P_{Y_i}}{P_W \times L_Y} & \xrightarrow{\text{pr}_{1!}} & \frac{\mathcal{O}/U_Y}{P_W \times L_Y} \\
& & \uparrow \text{pr}_2^* & \nearrow & \uparrow \text{pr}_2^* & \nearrow & \uparrow \phi_Y^* \\
\frac{pt}{\prod G_{V_m^i}^i} & \xrightarrow{\prod \phi^{i*}} & \frac{\prod G_{V_i}^i / U_{Y_i}}{\prod G_{V_i}^i \times L_{Y_i}} & \xrightarrow[\sim]{\prod \pi_*^i} & \frac{\prod G_{V_i}^i / P_{Y_i}}{\prod G_{V_i}^i} & \xrightarrow{\prod \alpha_i^!} & \frac{pt}{L_Y}
\end{array}$$

FIGURE 2. First composition of associativity isomorphisms

$$\begin{array}{ccccccc}
\frac{pt}{\prod G_{V_m^i}^i} & \xrightarrow{\phi_X^*} & \frac{\mathcal{O}/U_X}{P_W \times L_X} & \xrightarrow[\sim]{\pi_X^*} & \frac{\mathcal{O}/P_X}{P_W} & \xrightarrow{\alpha_X^!} & \frac{pt}{P_Y} \\
\downarrow \prod \phi_m^{i*} & & \uparrow \wr \pi_*' & \nearrow & \downarrow \beta_U^! & \nearrow \alpha_Y^! & \uparrow \alpha_Y^! \\
& & \frac{\mathcal{O}/U_Y \times \prod G_{V_i}^i / U_{Y_i}}{P_W \times L_Y \times L_X} & \xrightarrow[\sim]{\pi_*''} & & & \frac{\mathcal{O}/P_Y}{P_W} \\
& & \uparrow \text{pr}_2^* & \nearrow & \downarrow \wr \pi_*''' & \nearrow & \uparrow \wr \pi_{Y^*} \\
& & \frac{\prod G_{V_i}^i / U_{Y_i}}{\prod G_{V_i}^i \times L_{Y_i}} & \xrightarrow[\sim]{\pi_*''} & \frac{\mathcal{O}/U_Y \times \prod G_{V_i}^i / P_{Y_i}}{P_W \times L_Y} & \xrightarrow{\text{pr}_{1!}} & \frac{\mathcal{O}/U_Y}{P_W \times L_Y} \\
& & \uparrow \wr \pi_*' & \nearrow & \uparrow \text{pr}_2^* & \nearrow & \uparrow \phi_Y^* \\
& & \frac{\prod G_{V_i}^i / U_{Y_i} \times \prod G_{V_m^i}^i / U_{V_m^i}}{\prod G_{V_i}^i \times L_{Y_i} \times L_{Y_i}} & \xrightarrow[\sim]{\prod \pi_{Y_i}^*} & & & \\
& & \downarrow \wr \pi_*'' & \nearrow & \downarrow \beta_U^! & \nearrow & \\
& & \frac{\prod G_{V_i}^i / P_{Y_i}}{\prod G_{V_i}^i} & \xrightarrow[\sim]{\pi_*''} & \frac{\prod G_{V_i}^i / P_{Y_i}}{\prod G_{V_i}^i} & \xrightarrow{\prod \beta_i^!} & \frac{\prod G_{V_i}^i / P_{Y_i}}{\prod G_{V_i}^i} \\
& & \downarrow \text{pr}_{1!} & \nearrow & \downarrow \beta_i^! & \nearrow \prod \alpha_{Y_i}^! & \downarrow \beta_i^! \\
\frac{pt}{\prod G_{V_m^i}^i} & \xrightarrow{\prod \phi^{i*}} & \frac{\prod G_{V_i}^i / U_{Y_i}}{\prod G_{V_i}^i \times L_{Y_i}} & \xrightarrow[\sim]{\prod \pi_*^i} & \frac{\prod G_{V_i}^i / P_{Y_i}}{\prod G_{V_i}^i} & \xrightarrow{\prod \alpha_i^!} & \frac{pt}{L_Y}
\end{array}$$

FIGURE 3. Second composition of associativity isomorphisms

FIGURE 4. First isomorphism

Together with multiplication definition of Section 3.4.1 it gives general operation (in the set-up of (3.4.1)–(3.4.2))

$$\begin{aligned}
 \mathfrak{X}_{\mathcal{W}}^{\mathcal{O};\mathcal{V}} &= \begin{array}{c} V^1 \quad V^2 \quad V^k \\ \diagup \quad | \quad \diagdown \\ \mathcal{O} \\ \diagdown \quad | \quad \diagup \\ W^1 \quad W^2 \quad W^l \end{array} = \left(D_{L_{\mathcal{V}}}(pt) \xrightarrow{\phi^*} D_{P_{\mathcal{W}} \times L_{\mathcal{V}}}(\mathcal{O}/U_{\mathcal{V}}) \right. \\
 &\quad \left. \xrightarrow{\pi_*} D_{P_{\mathcal{W}}}(\mathcal{O}/P_{\mathcal{V}}) \xrightarrow{\alpha^i} D_{P_{\mathcal{W}}}(pt) \xrightarrow{\text{Res}_{L_{\mathcal{W}}, P_{\mathcal{W}}}} D_{L_{\mathcal{W}}}(pt) \right) \\
 &\simeq (D_{L_{\mathcal{V}}}(pt) \xrightarrow{\phi^*} D_{L_{\mathcal{W}} \times L_{\mathcal{V}}}(\mathcal{O}/U_{\mathcal{V}}) \xrightarrow{\pi_*} D_{L_{\mathcal{W}}}(\mathcal{O}/P_{\mathcal{V}}) \xrightarrow{\alpha^i} D_{L_{\mathcal{W}}}(pt)).
 \end{aligned}$$

In the particular case $k = 1$ we have $\mathcal{O} = L_{\mathcal{V}} = P_{\mathcal{V}} = G_{\mathcal{V}}$, $U_{\mathcal{V}} = 1$, and the comultiplication operation is isomorphic to

$$\begin{array}{c} \diagup \quad | \quad \diagdown \\ \mathcal{O} \\ \diagdown \quad | \quad \diagup \\ W^1 \quad W^2 \quad W^l \end{array} \simeq (D_{G_{\mathcal{V}}}(pt) \xrightarrow{\text{Res}_{P_{\mathcal{W}}, G_{\mathcal{V}}}} D_{P_{\mathcal{W}}}(pt) \xrightarrow{\text{Res}_{L_{\mathcal{W}}, P_{\mathcal{W}}}} D_{L_{\mathcal{W}}}(pt))$$

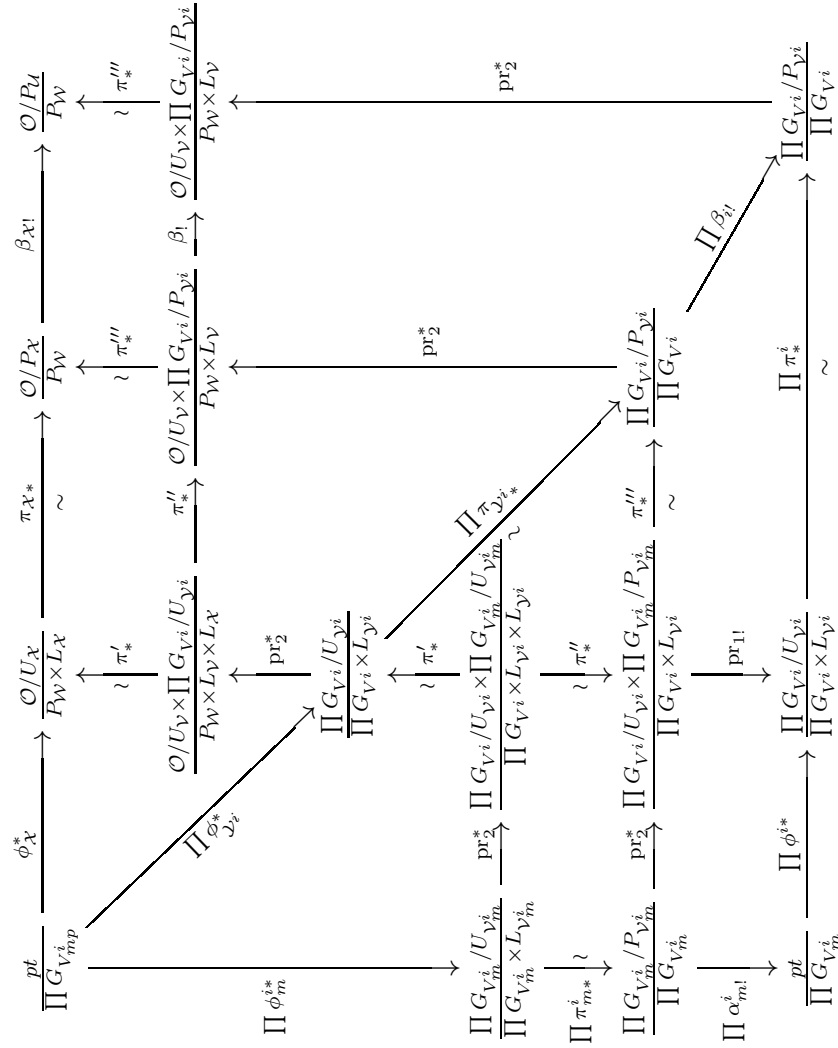

FIGURE 5. Second isomorphism

$$\simeq (D_{G_V}(pt) \xrightarrow{\text{Res}_{L_W, G_V}} D_{L_W}(pt))$$

by Proposition 3.4.2.

3.8. The coassociativity isomorphism

Assume that besides decomposition (3.4.2) of V into direct sum of W^j we have also decompositions

$$\mathcal{W}^j : \quad W^j = \bigoplus_{m=1}^{m^j} W_m^j.$$

We can produce out of these the decomposition

$$\mathcal{U} : \quad V = \bigoplus_{j,m} W_m^j,$$

where the lexicographic order of summands is used $W_1^1, \dots, W_{m^1}^1, W_1^2, \dots, W_{m^2}^2, \dots, W_1^l, \dots, W_{m^l}^l$.

Coassociativity isomorphism $coass : \mathfrak{H}_{\mathcal{U}}^{\mathcal{W}} \circ \mathfrak{K}_{\mathcal{W}}^{\mathcal{V}} \rightarrow \mathfrak{K}_{\mathcal{U}}^{\mathcal{V}}$ between functors

$$\begin{array}{c} \begin{array}{c} \nu \\ \diagup \quad \diagdown \\ \bullet \quad \bullet \quad \bullet \\ \diagup \quad \diagdown \quad \diagup \quad \diagdown \\ \nu^1 \quad \nu^2 \quad \nu^l \end{array} \\ = \left(\frac{pt}{L_V} \xrightarrow{\Psi_{\mathcal{W}}^{\mathcal{V}}} \frac{pt}{P_W} \xrightarrow{i_{L_W, P_W}^*} \frac{pt}{L_W} \xrightarrow{i_{L_U, L_W}^*} \frac{pt}{L_U} \right) \end{array}$$

$$\begin{array}{c}
 \begin{array}{ccccccc}
 \frac{pt}{\prod G_{V_m^i}} & \xrightarrow{\phi_X^*} & \frac{\mathcal{O}/U_X}{P_W \times L_X} & & & & \\
 \downarrow \prod \phi_m^{i*} & & \uparrow \sim \pi_*' & & & & \\
 \frac{\prod G_{V_m^i}/U_{V_m^i}}{\prod G_{V_m^i} \times L_{V_m^i}} & \xrightarrow{\text{pr}_2^*} & \frac{\mathcal{O}/U_U \times \prod G_{V_m^i}/U_{V_m^i}}{P_W \times L_U \times L_X} & \xrightarrow[\sim]{\pi_*''} & \frac{\mathcal{O}/U_U \times \prod G_{V_m^i}/P_{V_m^i}}{P_W \times L_U} & \xrightarrow[\sim]{\pi_*'''} & \frac{\mathcal{O}/P_X}{P_W} \\
 \downarrow \prod \pi_m^{i*} \wr & & \downarrow \wr \pi_*'' & & \uparrow \wr \pi_*' & & \\
 \frac{\prod G_{V_m^i}/P_{V_m^i}}{\prod G_{V_m^i}} & \xrightarrow{\text{pr}_2^*} & \frac{\mathcal{O}/U_U \times \prod G_{V_m^i}/P_{V_m^i}}{P_W \times L_U} & \xrightarrow[\sim]{\pi_*'} & \frac{\mathcal{O}/U_V \times \prod G_{V_i}/U_{V_i} \times \prod G_{V_m^i}/P_{V_m^i}}{P_W \times L_V \times L_U} & \xrightarrow[\sim]{\pi_*} & \frac{\mathcal{O}/P_U}{P_W} \\
 \downarrow \prod \alpha_m^{i*} & & \uparrow \text{pr}_2^* & & \downarrow \pi_* & & \\
 \frac{pt}{\prod G_{V_m^i}} & \xrightarrow{\prod \phi^{i*}} & \frac{\prod G_{V_i}/U_{V_i}}{\prod G_{V_i} \times L_{V_i}} & \xrightarrow[\sim]{\pi_*'''} & \frac{\mathcal{O}/U_V \times \prod G_{V_i}/P_{V_i}}{P_W \times L_V} & \xrightarrow[\sim]{\pi_*'''} & \frac{\mathcal{O}/P_U}{P_W} \\
 & & \downarrow \text{pr}_{1!} & & \uparrow \text{pr}_2^* & & \\
 & & \frac{\prod G_{V_i}/U_{V_i}}{\prod G_{V_i} \times L_{V_i}} & \xrightarrow[\sim]{\pi_*^i} & \frac{\prod G_{V_i}/P_{V_i}}{\prod G_{V_i}} & \xrightarrow[\sim]{\text{pr}_2^*} & \frac{\mathcal{O}/U_V \times \prod G_{V_i}/P_{V_i}}{P_W \times L_V}
 \end{array}
 \end{array}$$

FIGURE 6. Modified first isomorphism

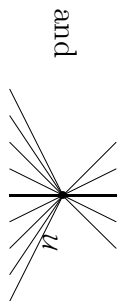

$$= \left(D_{L_V}^{b,c}(pt) \xrightarrow{\psi_{R_U}^{\mathcal{Y}}} D_{R_U}^{b,c}(pt) \xrightarrow{i_{L_U, R_U}^*} D_{L_U}^{b,c}(pt) \right)$$

and

is given by the diagram

$$\begin{array}{ccccccc}
 \frac{pt}{L_V} & \xrightarrow{\phi^*} & \frac{\mathcal{O}/L_Y}{P_W \times L_V} & \xrightarrow{\pi^*} & \frac{\mathcal{O}/R_Y}{R_W} & \xrightarrow{\alpha^i} & \frac{pt}{P_W} \\
 \downarrow i_{R_U \times L_V, R_W \times L_V}^* & & \downarrow i_{R_U, R_W}^* & & \downarrow i_{R_U, R_W}^* & & \downarrow i_{L_W, R_W}^* \\
 \frac{pt}{L_V} & \xrightarrow{\phi^*} & \frac{\mathcal{O}/L_Y}{R_U \times L_V} & \xrightarrow{\pi^*} & \frac{\mathcal{O}/R_Y}{R_U} & \xrightarrow{\alpha^i} & \frac{pt}{P_U} \\
 \downarrow i_{L_U, L_V}^* & & \downarrow i_{L_U, R_U}^* & & \downarrow i_{L_U, R_U}^* & & \downarrow i_{L_U, L_V}^* \\
 \frac{pt}{L_V} & \xrightarrow{\phi^*} & \frac{\mathcal{O}/L_Y}{P_U \times L_V} & \xrightarrow{\pi^*} & \frac{\mathcal{O}/R_Y}{P_U} & \xrightarrow{\alpha^i} & \frac{pt}{L_U}
 \end{array}$$

$$\begin{array}{ccccc}
\frac{pt}{\prod G_{V_{mp}^i}} & \xrightarrow{\phi_{\mathcal{X}}^*} & \frac{\mathcal{O}/U_{\mathcal{X}}}{P_{\mathcal{W}} \times L_{\mathcal{X}}} & \xrightarrow[\sim]{\pi_{\mathcal{X}*}} & \frac{\mathcal{O}/P_{\mathcal{X}}}{P_{\mathcal{W}}} \\
\downarrow \Pi \phi_m^{i*} & & \uparrow \wr \pi'_* & & \uparrow \wr \pi_*''' \\
\frac{\prod G_{V_m^i}/U_{V_m^i}}{\prod G_{V_m^i} \times L_{V_m^i}} & \xrightarrow{\text{pr}_2^*} & \frac{\mathcal{O}/U_U \times \prod G_{V_m^i}/U_{V_m^i}}{P_{\mathcal{W}} \times L_U \times L_{\mathcal{X}}} & \xrightarrow[\sim]{\pi''_*} & \frac{\mathcal{O}/U_U \times \prod G_{V_m^i}/P_{V_m^i}}{P_{\mathcal{W}} \times L_U} \\
\downarrow \Pi \pi_{m*}^i \wr & & \downarrow \wr \pi''_* & \nearrow \wr \pi''_* & \wr \pi_*''' \\
& & \frac{\mathcal{O}/U_U \times \prod G_{V_m^i}/P_{V_m^i}}{P_{\mathcal{W}} \times L_U} & \xrightarrow[\sim]{\pi_*} & \frac{\mathcal{O}/U_V \times \prod G_{V_i}/P_{V_i}}{P_{\mathcal{W}} \times L_V} \\
& \nearrow \text{pr}_2^* & \uparrow \wr \pi'_* & & \uparrow \wr \pi_*''' \\
\frac{\prod G_{V_m^i}/P_{V_m^i}}{\prod G_{V_m^i}} & \xrightarrow{\text{pr}_3^*} & \frac{\mathcal{O}/U_V \times \prod G_{V_i}/U_{V_i} \times \prod G_{V_m^i}/P_{V_m^i}}{P_{\mathcal{W}} \times L_V \times L_U} & \xrightarrow[\sim]{\pi_*} & \frac{\mathcal{O}/U_V \times \prod G_{V_i}/P_{V_i}}{P_{\mathcal{W}} \times L_V} \\
& \searrow \text{pr}_2^* & \uparrow \text{pr}_{23}^* & & \uparrow \text{pr}_2^* \\
& & \frac{\prod G_{V_i}/U_{V_i} \times \prod G_{V_m^i}/P_{V_m^i}}{\prod G_{V_i} \times L_{V_i}} & \xrightarrow[\sim]{\pi_*'''} & \frac{\prod G_{V_i}/P_{V_i}}{\prod G_{V_i}}
\end{array}$$

FIGURE 7. Part of the first isomorphism

$$\begin{array}{ccccc}
\frac{pt}{\prod G_{V_{mp}^i}} & \xrightarrow{\phi_{\mathcal{X}}^*} & \frac{\mathcal{O}/U_{\mathcal{X}}}{P_{\mathcal{W}} \times L_{\mathcal{X}}} & \xrightarrow[\sim]{\pi_{\mathcal{X}*}} & \frac{\mathcal{O}/P_{\mathcal{X}}}{P_{\mathcal{W}}} \\
\downarrow \Pi \phi_m^{i*} & & \uparrow \wr \pi'_* & & \uparrow \wr \pi_*''' \\
& & \frac{\mathcal{O}/U_V \times \prod G_{V_i}/U_{V_i}}{P_{\mathcal{W}} \times L_V \times L_{\mathcal{X}}} & \xrightarrow[\sim]{\pi''_*} & \frac{\mathcal{O}/U_V \times \prod G_{V_i}/P_{V_i}}{P_{\mathcal{W}} \times L_V} \\
& \searrow \Pi \phi_{V_i}^* & \uparrow \text{pr}_2^* & & \uparrow \text{pr}_2^* \\
& & \frac{\prod G_{V_i}/U_{V_i}}{\prod G_{V_i} \times L_{V_i}} & & \\
& \searrow \phi_* & \downarrow \wr \pi'_* & \nearrow \Pi \pi_{V_i}^* & \\
& & \frac{\prod G_{V_i}/U_{V_i} \times \prod G_{V_m^i}/U_{V_m^i}}{\prod G_{V_i} \times L_{V_i} \times L_{V_m^i}} & \xrightarrow[\sim]{\pi_*} & \frac{\prod G_{V_i}/P_{V_i}}{\prod G_{V_i}} \\
& \downarrow \Pi \pi_{m*}^i \wr & \downarrow \wr \pi''_* & & \uparrow \text{pr}_2^* \\
\frac{\prod G_{V_m^i}/P_{V_m^i}}{\prod G_{V_m^i}} & \xrightarrow{\text{pr}_2^*} & \frac{\prod G_{V_i}/U_{V_i} \times \prod G_{V_m^i}/P_{V_m^i}}{\prod G_{V_i} \times L_{V_i}} & \xrightarrow[\sim]{\pi_*'''} & \frac{\prod G_{V_i}/P_{V_i}}{\prod G_{V_i}}
\end{array}$$

FIGURE 8. Part of the second isomorphism

3.9. The coassociativity equation

Assume that we have the following decompositions of finite-dimensional \mathbb{C} -vector spaces:

$$\begin{aligned}
\mathcal{V}: \quad V &= \bigoplus_i V^i, & \mathcal{W}: \quad V &= \bigoplus_j W^j, \\
\mathcal{W}^j: \quad W^j &= \bigoplus_m W_m^j, & \mathcal{W}_m^j: \quad W_m^j &= \bigoplus_p W_{m,p}^j.
\end{aligned}$$

$$\begin{array}{ccccc}
& & \frac{\mathcal{O}/U_{\mathcal{X}}}{P_{\mathcal{W}} \times L_{\mathcal{X}}} & & \\
& \nearrow \phi_{\mathcal{X}}^* & \uparrow \wr \pi_* & \searrow \pi_{\mathcal{X}^*} & \\
\frac{pt}{\prod G_{V_m^i}} & \xrightarrow{\phi^*} & \frac{\mathcal{O}/U_{\mathcal{V}} \times \prod G_{V^i}/U_{\mathcal{V}^i} \times \prod G_{V_m^i}/U_{\mathcal{V}_m^i}}{P_{\mathcal{W}} \times L_{\mathcal{V}} \times L_{\mathcal{U}} \times L_{\mathcal{X}}} & \xrightarrow{\pi_*} & \frac{\mathcal{O}/P_{\mathcal{X}}}{P_{\mathcal{W}}} \\
\downarrow \prod \phi_m^{i*} & \nearrow \text{pr}_3^* & \downarrow \wr \pi_* & \searrow \pi_* & \uparrow \wr \pi_*''' \\
\frac{\prod G_{V_m^i}/U_{\mathcal{V}_m^i}}{\prod G_{V_m^i} \times L_{\mathcal{V}_m^i}} & \xrightarrow{\text{pr}_3^*} & \frac{\mathcal{O}/U_{\mathcal{V}} \times \prod G_{V^i}/U_{\mathcal{V}^i} \times \prod G_{V_m^i}/P_{\mathcal{V}_m^i}}{P_{\mathcal{W}} \times L_{\mathcal{V}} \times L_{\mathcal{U}}} & \xrightarrow{\pi_*} & \frac{\mathcal{O}/U_{\mathcal{V}} \times \prod G_{V^i}/P_{\mathcal{Y}^i}}{P_{\mathcal{W}} \times L_{\mathcal{V}}} \\
\downarrow \prod \pi_{m^*}^i \wr & \nearrow \text{pr}_3^* & \uparrow \text{pr}_{23}^* & \searrow \pi_* & \uparrow \text{pr}_2^* \\
\frac{\prod G_{V_m^i}/P_{\mathcal{V}_m^i}}{\prod G_{V_m^i}} & \xrightarrow{\text{pr}_2^*} & \frac{\prod G_{V^i}/U_{\mathcal{V}^i} \times \prod G_{V_m^i}/P_{\mathcal{V}_m^i}}{\prod G_{V^i} \times L_{\mathcal{V}^i}} & \xrightarrow{\pi_*'''} & \frac{\prod G_{V^i}/P_{\mathcal{Y}^i}}{\prod G_{V^i}}
\end{array}$$

FIGURE 9. First simplified isomorphism

$$\begin{array}{ccccc}
& & \frac{\mathcal{O}/U_{\mathcal{X}}}{P_{\mathcal{W}} \times L_{\mathcal{X}}} & & \\
& \nearrow \phi_{\mathcal{X}}^* & \uparrow \wr \pi_* & \searrow \pi_{\mathcal{X}^*} & \\
\frac{pt}{\prod G_{V_m^i}} & \xrightarrow{\phi^*} & \frac{\mathcal{O}/U_{\mathcal{V}} \times \prod G_{V^i}/U_{\mathcal{V}^i} \times \prod G_{V_m^i}/U_{\mathcal{V}_m^i}}{P_{\mathcal{W}} \times L_{\mathcal{V}} \times L_{\mathcal{U}} \times L_{\mathcal{X}}} & \xrightarrow{\pi_*} & \frac{\mathcal{O}/P_{\mathcal{X}}}{P_{\mathcal{W}}} \\
\downarrow \prod \phi_m^{i*} & \searrow \phi^* & \uparrow \text{pr}_{23}^* & \searrow \pi_* & \uparrow \wr \pi_*''' \\
\frac{\prod G_{V_m^i}/U_{\mathcal{V}_m^i}}{\prod G_{V_m^i} \times L_{\mathcal{V}_m^i}} & \xrightarrow{\text{pr}_2^*} & \frac{\prod G_{V^i}/U_{\mathcal{V}^i} \times \prod G_{V_m^i}/U_{\mathcal{V}_m^i}}{\prod G_{V^i} \times L_{\mathcal{V}^i} \times L_{\mathcal{Y}^i}} & \xrightarrow{\pi_*} & \frac{\mathcal{O}/U_{\mathcal{V}} \times \prod G_{V^i}/P_{\mathcal{Y}^i}}{P_{\mathcal{W}} \times L_{\mathcal{V}}} \\
\downarrow \prod \pi_{m^*}^i \wr & \nearrow \text{pr}_2^* & \downarrow \wr \pi_*'' & \searrow \pi_* & \uparrow \text{pr}_2^* \\
\frac{\prod G_{V_m^i}/P_{\mathcal{V}_m^i}}{\prod G_{V_m^i}} & \xrightarrow{\text{pr}_2^*} & \frac{\prod G_{V^i}/U_{\mathcal{V}^i} \times \prod G_{V_m^i}/P_{\mathcal{V}_m^i}}{\prod G_{V^i} \times L_{\mathcal{V}^i}} & \xrightarrow{\pi_*'''} & \frac{\prod G_{V^i}/P_{\mathcal{Y}^i}}{\prod G_{V^i}}
\end{array}$$

FIGURE 10. Second simplified isomorphism

These decompositions imply also the following decompositions:

$$\mathcal{U} : V = \bigoplus_{j,m} W_m^j, \quad \mathcal{Y}^j : W^j = \bigoplus_{m,p} W_{m,p}^j, \quad \mathcal{X} : V = \bigoplus_{j,m,p} W_{m,p}^j.$$

Let $\mathcal{O} \subset G_{\mathcal{V}}$ be a left $P_{\mathcal{W}}$ -invariant and right $P_{\mathcal{V}}$ -invariant subset. Coassociativity isomorphisms give two isomorphisms between the composite operation and the single operation as in the diagram

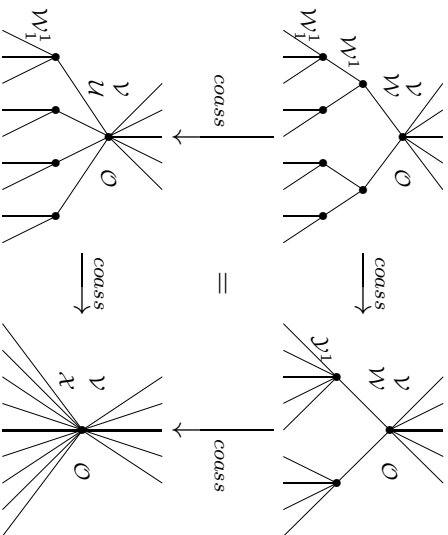

FIGURE 11. Final isomorphisms

$$\begin{array}{ccccc}
 \frac{pt}{\prod G_{V_m^i}^{i*}} & \xrightarrow{\phi^*} & \frac{\mathcal{O}/U_V \times \prod G_{V^i}/U_{V^i} \times \prod G_{V_m^i}/U_{V_m^i}}{P_W \times L_V \times L_U \times L_X} & \xrightarrow{\pi_*} & \frac{\mathcal{O}/P_X}{P_W} \\
 \downarrow \prod \phi_m^{i*} & & \swarrow \text{pr}_3^* \quad \searrow \text{pr}_{23}^* & & \uparrow \pi_*' \\
 \frac{\prod G_{V_m^i}/U_{V_m^i}}{\prod G_{V_m^i} \times L_{V_m^i}} & \xrightarrow{\text{pr}_2^*} & \frac{\prod G_{V^i}/U_{V^i} \times \prod G_{V_m^i}/U_{V_m^i}}{\prod G_{V^i} \times L_{V^i} \times L_{V_m^i}} & \xrightarrow{\pi_*} & \frac{\mathcal{O}/U_V \times \prod G_{V^i}/P_{V_m^i}}{P_W \times L_V} \\
 \downarrow \prod \pi_{m^*}^i \wr & & \searrow \pi_*'' & & \uparrow \pi_*'' \\
 \frac{\prod G_{V_m^i}/P_{V_m^i}}{\prod G_{V_m^i}} & \xrightarrow{\text{pr}_2^*} & \frac{\prod G_{V^i}/U_{V^i} \times \prod G_{V_m^i}/P_{V_m^i}}{\prod G_{V^i} \times L_{V^i}} & \xrightarrow{\pi_*'''} & \frac{\prod G_{V^i}/P_{V_m^i}}{\prod G_{V^i}} \\
 & & \swarrow \text{pr}_{23}^* & & \uparrow \text{pr}_2^* \\
 \frac{pt}{\prod G_{V_m^i}^{i*}} & \xrightarrow{\phi^*} & \frac{\mathcal{O}/U_V \times \prod G_{V^i}/U_{V^i} \times \prod G_{V_m^i}/U_{V_m^i}}{P_W \times L_V \times L_U \times L_X} & \xrightarrow{\pi_*} & \frac{\mathcal{O}/P_X}{P_W} \\
 \downarrow \prod \phi_m^{i*} & & \swarrow \text{pr}_3^* \quad \searrow \text{pr}_{23}^* & & \uparrow \pi_*' \\
 \frac{\prod G_{V_m^i}/U_{V_m^i}}{\prod G_{V_m^i} \times L_{V_m^i}} & \xrightarrow{\text{pr}_2^*} & \frac{\prod G_{V^i}/U_{V^i} \times \prod G_{V_m^i}/U_{V_m^i}}{\prod G_{V^i} \times L_{V^i} \times L_{V_m^i}} & \xrightarrow{\pi_*} & \frac{\mathcal{O}/U_V \times \prod G_{V^i}/P_{V_m^i}}{P_W \times L_V} \\
 \downarrow \prod \pi_{m^*}^i \wr & & \searrow \pi_*'' & & \uparrow \pi_*'' \\
 \frac{\prod G_{V_m^i}/P_{V_m^i}}{\prod G_{V_m^i}} & \xrightarrow{\text{pr}_2^*} & \frac{\prod G_{V^i}/U_{V^i} \times \prod G_{V_m^i}/P_{V_m^i}}{\prod G_{V^i} \times L_{V^i}} & \xrightarrow{\pi_*'''} & \frac{\prod G_{V^i}/P_{V_m^i}}{\prod G_{V^i}} \\
 & & \swarrow \text{pr}_{23}^* & & \uparrow \text{pr}_2^*
 \end{array}$$

(3.9.1)

3.9.1. Proposition (The coassociativity equation). *Diagram (3.9.1) is commutative.*

Proof. The graphically expressed equation means equality of the following two isomorphisms

$$\begin{array}{ccccccc}
\frac{pt}{L_V} & \xrightarrow{\phi^*} & \frac{\mathcal{O}/U_V}{P_W \times L_V} & \xrightarrow{\pi_*} & \frac{\mathcal{O}/P_V}{P_W} & \xrightarrow{\alpha_!} & \frac{pt}{P_W} \xrightarrow{i_{L_W, P_W}^*} \frac{pt}{L_W} \\
\Downarrow & & \downarrow i_{P_U \times L_V, P_W \times L_V}^* & & \downarrow i_{P_U, P_W}^* & & \downarrow i_{P_U, P_W}^* \searrow i_{L_U, P_U}^* \swarrow \\
\frac{pt}{L_V} & \xrightarrow{\phi^*} & \frac{\mathcal{O}/U_V}{P_U \times L_V} & \xrightarrow{\pi_*} & \frac{\mathcal{O}/P_V}{P_U} & \xrightarrow{\alpha_!} & \frac{pt}{P_U} \xrightarrow{i_{L_U, P_U}^*} \frac{pt}{L_U} \\
\Downarrow & & \downarrow i_{P_X \times L_V, P_U \times L_V}^* & & \downarrow i_{P_X, P_U}^* & & \downarrow i_{P_X, P_U}^* \searrow i_{L_X, P_X}^* \swarrow \\
\frac{pt}{L_V} & \xrightarrow{\phi^*} & \frac{\mathcal{O}/U_V}{P_X \times L_V} & \xrightarrow{\pi_*} & \frac{\mathcal{O}/P_V}{P_X} & \xrightarrow{\alpha_!} & \frac{pt}{P_X} \xrightarrow{i_{L_X, P_X}^*} \frac{pt}{L_X}
\end{array}$$

$$\begin{array}{ccccccc}
\frac{pt}{L_V} & \xrightarrow{\phi^*} & \frac{\mathcal{O}/U_V}{P_W \times L_V} & \xrightarrow{\pi_*} & \frac{\mathcal{O}/P_V}{P_W} & \xrightarrow{\alpha_!} & \frac{pt}{P_W} \xrightarrow{i_{L_W, P_W}^*} \frac{pt}{L_W} \\
\Downarrow & & \downarrow i_{P_X \times L_V, P_W \times L_V}^* & & \downarrow i_{P_X, P_W}^* & & \downarrow i_{P_X, P_W}^* \searrow i_{L_X, L_W}^* \swarrow \\
\frac{pt}{L_V} & \xrightarrow{\phi^*} & \frac{\mathcal{O}/U_V}{P_X \times L_V} & \xrightarrow{\pi_*} & \frac{\mathcal{O}/P_V}{P_X} & \xrightarrow{\alpha_!} & \frac{pt}{P_X} \xrightarrow{i_{L_X, P_X}^*} \frac{pt}{L_X}
\end{array}$$

Four triangular prisms, which follow from Proposition B.1.1 and Proposition B.2.2, imply that the above isomorphisms are equal. \square

3.10. The coherence isomorphism

Assume given a vector space decomposition

$$V = \bigoplus_{m=1}^k \bigoplus_{r=1}^l V_r^m.$$

We shall denote it \mathcal{Y} if the summands are ordered as follows

$$V_1^1, V_2^1, \dots, V_l^1, V_1^2, V_2^2, \dots, V_l^2, \dots, V_1^k, V_2^k, \dots, V_l^k.$$

The same decomposition with order of summands

$$V_1^1, V_1^2, \dots, V_1^k, V_2^1, V_2^2, \dots, V_2^k, \dots, V_l^1, V_l^2, \dots, V_l^k$$

will be denoted \mathcal{X} . We also have decompositions

$$\begin{array}{ll}
\mathcal{V}^m : V^m = \bigoplus_{r=1}^l V_r^m & \mathcal{V} : V = \bigoplus_{m=1}^k V^m \\
\mathcal{W}_r : W_r = \bigoplus_{m=1}^k V_r^m & \mathcal{W} : V = \bigoplus_{r=1}^l W_r
\end{array}$$

which produce filtrations $V_{(r)}^m$ of V^m , $V^{(m)}$ of V , $V_r^{(m)}$ of W_r and $W_{(r)}$ of V . We associate with these filtrations parabolic groups $P_{V^m} \subset G_{V^m}$, $P_V \subset G_V$, $P_{W_r} \subset G_{W_r}$ and $P_W \subset G_W$.

Notations. Let A, B be vector spaces. We denote the braiding functor as

$$\times = (D_{G_A \times G_B}(pt) \xrightarrow{\tau} D_{G_A \times G_B}(pt) \xrightarrow{\sigma^*} D_{G_B \times G_A}(pt)),$$

where σ is the permutation isomorphism of groups and modules and the functor τ is the shift $\tau(L) = L[-2 \dim A \dim B]$.

We claim that for any collection of indices and for any collection of bi-invariant locally closed subsets $(\mathcal{O}'_1, \dots, \mathcal{O}'_k, \mathcal{O}''_1, \dots, \mathcal{O}''_l)$, which may occur in the following diagram, there exists a bi-invariant locally closed subset \mathcal{O} and a coherence isomorphism

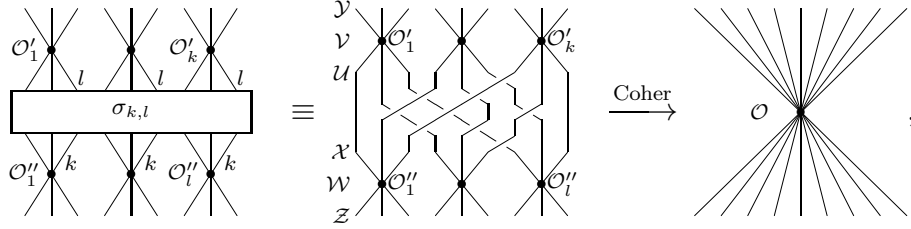

explicitly described below. Here $\sigma_{k,l} = (s_{k,l})_{+}^{\sim}$ is the braid, corresponding to the permutation $s_{k,l}$ of the set $\{1, 2, \dots, kl\}$,

$$s_{k,l}(1 + t + nl) = 1 + n + tk \quad \text{for } 0 \leq t < l, 0 \leq n < k, \quad (3.10.1)$$

under the standard splitting $S_{kl} \rightarrow B_{kl}$, which maps the elementary transpositions to the generators of the braid group. The subset \mathcal{O} is computed as follows.

Bi-invariance of initial parametrising subsets means that

$$\begin{aligned} G_{V^m} \supset \mathcal{O}'_m &\in P_{V^m_-} \text{-sets-} P_{Y^m}, \\ G_{W_r} \supset \mathcal{O}''_r &\in P_{Z_r} \text{-sets-} P_{V_r^-}, \end{aligned}$$

where Y^m is the incoming filtration of V^m , and Z_r is the outgoing filtration of W_r . The subsets

$$\begin{aligned} P_Y \supset \overline{\mathcal{O}} &\stackrel{\text{def}}{=} U_Y \cdot \prod_m \mathcal{O}'_m = \prod_m \mathcal{O}'_m \cdot U_Y \in P_{V^m_-} \text{-sets-} P_Y, \\ P_Y \supset \underline{\mathcal{O}} &\stackrel{\text{def}}{=} U_W \cdot \prod_r \mathcal{O}''_r = \prod_r \mathcal{O}''_r \cdot U_W \in P_{Z_r} \text{-sets-} P_{V^m_-} \end{aligned}$$

are locally closed. The subset

$$G_V \supset \mathcal{O} \stackrel{\text{def}}{=} \underline{\mathcal{O}} \cdot \overline{\mathcal{O}} \in P_{Z_r} \text{-sets-} P_Y, \quad \mathcal{O} = \underline{\mathcal{O}} P_U \times_{P_U} \overline{\mathcal{O}} = \underline{\mathcal{O}} \times_{P_{W \cap P_Y}} \overline{\mathcal{O}},$$

is also locally closed. Indeed, $\underline{\mathcal{O}} \times \overline{\mathcal{O}}$ is locally closed in $P_W \times P_Y$, hence, $\underline{\mathcal{O}} \times_{P_{W \cap P_Y}} \overline{\mathcal{O}}$ is locally closed in $P_W \times_{P_{W \cap P_Y}} P_Y \simeq P_W \cdot P_Y$. The subspace $C = P_W \cdot P_Y$ of G_V is locally closed, since it is an orbit of $P_W \times P_Y$ in G_V , and the number of such orbits is finite. Indeed, C is embedded in its closure as

$$C = \overline{C} - \bigcup \{ \overline{\mathcal{O}}_a \mid \mathcal{O}_a \subset \overline{C} \text{ is an orbit of } P_W \times P_Y, \mathcal{O}_a \neq C \}$$

due to dimension considerations.

Both associativity isomorphism and coassociativity isomorphism are particular cases of the general coherence isomorphism.

In the particular case, when the upper row of operations consists of comultiplications (operations with single input), and the lower row of operations consists of multiplications (operations with single output), we have necessarily $\mathcal{O}'_m = G_{V^m}$ and $\mathcal{O}''_r = G_{W_r}$. In such cases we omit the parametrising

set, since it is unique. Graphical notation here is the following:

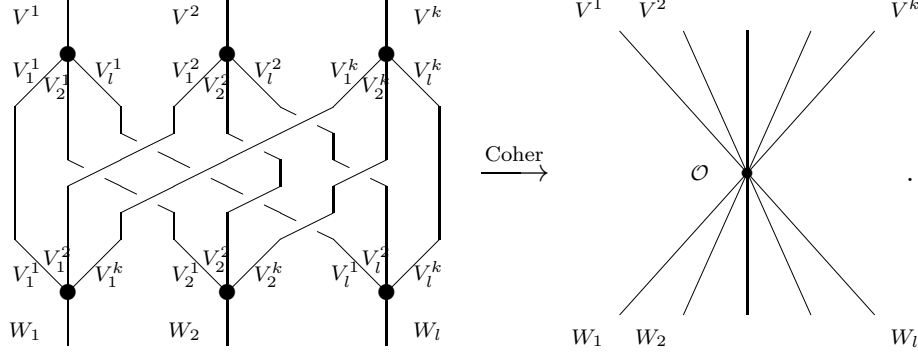

By general formulas we find here $\overline{\mathcal{O}} = P_V$, $\underline{\mathcal{O}} = P_W$, hence, $\mathcal{O} = P_V P_W$.

The general coherence isomorphism is built as the composition

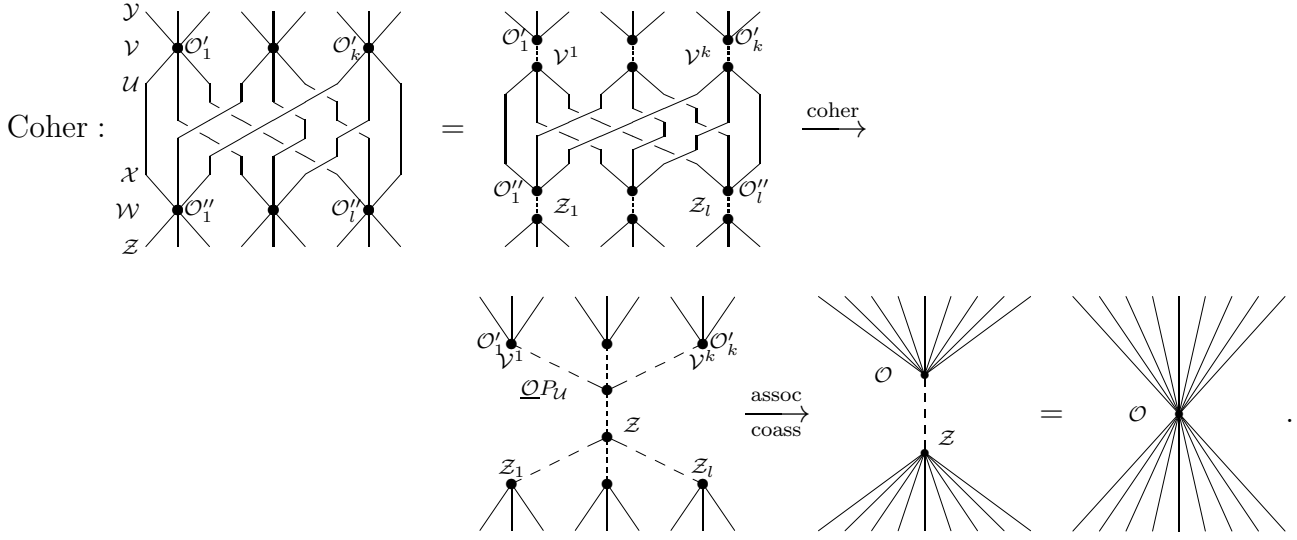

The three components of the coherence isomorphism are defined next.

$$\begin{array}{c}
 \frac{pt}{\prod G_{Y^m}} \xrightarrow{\phi^*} \frac{\prod \mathcal{O}'_m}{\prod P_{Y^m} \times P_{Y^m}} \xrightarrow{\pi_*} \frac{\prod \mathcal{O}'_m / P_{Y^m}}{\prod P_{Y^m}} \xrightarrow{\alpha_1} \frac{pt}{\prod P_{Y^m}} \\
 \downarrow \phi^* \quad \downarrow \phi^* \quad \downarrow \phi^* \quad \downarrow \phi^* \\
 \frac{\mathcal{O}}{P_Z \times P_Y} \xrightarrow{\pi^*} \frac{\underline{\mathcal{O}} P_U \times \overline{\mathcal{O}}}{P_Z \times P_U \times P_Y} \xrightarrow{\pi_*} \frac{\underline{\mathcal{O}} P_U \times \overline{\mathcal{O}} / P_Y}{P_Z \times P_U} \xrightarrow{1 \times \alpha_1} \frac{\underline{\mathcal{O}} P_U}{P_Z \times P_U} \\
 \searrow \text{Id} \quad \downarrow \pi_* \quad \downarrow \pi_* \quad \downarrow \pi_* \\
 \frac{\mathcal{O}}{P_Z \times P_Y} \xrightarrow{\pi_*} \frac{\mathcal{O} / P_Y}{P_Z} \xrightarrow{\beta_1} \frac{\underline{\mathcal{O}} P_U / P_U}{P_Z} \\
 \text{assoc} \quad \downarrow \alpha_1 \\
 \frac{pt}{P_Z}
 \end{array}$$

$$\text{coass} : \left(\frac{pt}{P_Z} \xrightarrow{\iota^*} \frac{pt}{\prod_r P_{Z_r}} \xrightarrow{\iota^*} \frac{pt}{\prod_{n,r} G_{Z_r^n}} \right) \xrightarrow{\sim} \left(\frac{pt}{P_Z} \xrightarrow{\iota^*} \frac{pt}{\prod_{n,r} G_{Z_r^n}} \right).$$

$$\begin{array}{ccccc}
\frac{pt}{\prod_m P_{\mathcal{V}^m}} & \xrightarrow{\iota^*} & \frac{pt}{\prod_{m,r} G_{V_r^m}} & & \\
\downarrow \phi^* & \searrow \text{Id} & \downarrow \phi^* & & \\
\frac{\mathcal{O}P_U}{P_Z \times P_U} & \xrightarrow{i^*} & \frac{\mathcal{O}}{(\prod P_{Z_r}) \times (P_W \cap P_V)} & \xrightarrow{q_*} & \frac{\mathcal{O}/U_W \cap P_V}{\prod_r P_{Z_r} \times P_{W_r}} & \xrightarrow{\rho!} & \frac{\prod_r \mathcal{O}_r''}{\prod_r P_{Z_r} \times P_{W_r}} \\
\downarrow \pi_* & & \downarrow q_* & \searrow q_* & \downarrow \pi_* & & \downarrow \pi_* \\
\frac{\mathcal{O}P_U/P_U}{P_Z} & \xrightarrow{\iota^*} & \frac{\mathcal{O}/P_W \cap P_V}{\prod P_{Z_r}} & \xrightarrow{\rho!} & \frac{\prod_r \mathcal{O}_r''/P_{W_r}}{\prod_r P_{Z_r}} & & \downarrow \alpha! \\
\downarrow \alpha! & & \downarrow \alpha! & \searrow \alpha! & \downarrow \alpha! & & \downarrow \alpha! \\
\frac{pt}{P_Z} & \xrightarrow{\iota^*} & \frac{pt}{\prod_r P_{Z_r}} & \xrightarrow{\iota^*} & \frac{pt}{\prod_r P_{Z_r}} & & \\
\end{array}$$

(1) (2) (3) (4) (5) (6)

FIGURE 12. Coherence isomorphism coher

Coherence isomorphism in Figure 12 is composed of several isomorphisms. Isomorphism (1) exists by Proposition A.1.2. Isomorphism (2) follows from the fact that q_* is an equivalence.

Isomorphism $T^{-2A} \rightarrow \rho! \rho^*$ marked by (3) is obtained from a sequence of affine linear $\prod P_{W_r}$ -bundles

$$\begin{aligned}
U_W/(U_W \cap P_V) &\longrightarrow \dots \longrightarrow U_W/[U_W^{(k+1)}(U_W \cap P_V)] \\
&\longrightarrow U_W/[U_W^{(k)}(U_W \cap P_V)] \longrightarrow \dots \longrightarrow pt,
\end{aligned}$$

where $U = U^{(1)} \supset U^{(2)} \supset \dots \supset U^{(m)} = 1$ is the lower central series of U . The group $\prod P_{W_r}$ acts by conjugation. Pull-back of this sequence along $\prod \mathcal{O}_r'' \times F_{W_r} | \prod P_{Z_r} \times P_{W_r} \rightarrow pt | \prod P_{W_r}$ gives a sequence of affine linear $\prod P_{Z_r} \times P_{W_r}$ -bundles

$$\begin{aligned}
\prod \mathcal{O}_r'' \times U_W/(U_W \cap P_V) &\longrightarrow \dots \longrightarrow \prod \mathcal{O}_r'' \times U_W/[U_W^{(k+1)}(U_W \cap P_V)] \\
&\longrightarrow \prod \mathcal{O}_r'' \times U_W/[U_W^{(k)}(U_W \cap P_V)] \longrightarrow \dots \longrightarrow \prod \mathcal{O}_r''.
\end{aligned}$$

Multiplication map $\prod \mathcal{O}_r'' \times U_{\mathcal{W}} \rightarrow \underline{\mathcal{O}}$ is an isomorphism of $\prod P_{Z_r} \times P_{W_r}$ -spaces, hence, we may replace the first space with the other one. The composition of the above maps equals $\rho : \mathcal{O}/(U_{\mathcal{W}} \cap P_{\mathcal{V}}) \rightarrow \prod_r \mathcal{O}_r''$. The type (3) isomorphism for ρ is a composition of isomorphisms, constructed for each affine bundle of the sequence in Corollary 3.3.2.

Isomorphism (4) is obtained from a commutative square of equivariant maps. Isomorphism (6) is a base change isomorphism. Isomorphism (5) is obtained from a base change isomorphism by inverting q^* and π^* and replacing them with their quasi-inverses q_* and π_* .

We use the facts

$$\begin{aligned} U_{\mathcal{W}} &= 1 + \bigoplus_{m,n;r>s} \text{Hom}(V_r^m, V_s^n), \\ U_{\mathcal{W}} \cap P_{\mathcal{V}} &= 1 + \bigoplus_{m \geq n;r>s} \text{Hom}(V_r^m, V_s^n), \\ U_{\mathcal{W}}/(U_{\mathcal{W}} \cap P_{\mathcal{V}}) &\simeq \bigoplus_{m < n;r>s} \text{Hom}(V_r^m, V_s^n), \end{aligned}$$

The dimension of fiber bundle ρ

$$A \stackrel{\text{def}}{=} \dim_{\mathbb{C}} U_{\mathcal{W}}/(U_{\mathcal{W}} \cap P_{\mathcal{V}}) = \sum_{m < n;r>s} \dim V_r^m \cdot \dim V_s^n$$

multiplied by -2 equals to the total shift, obtained from all braidings in the source functor of coherence isomorphism Coher .

3.11. Distinguished triangles

Consider left $P_{\mathcal{W}}$ -invariant and right $P_{\mathcal{V}}$ -invariant subsets $F \subset Y \subset G_{\mathcal{V}}$, such that F is closed in Y . Denote $S = Y - F$ and consider inclusions

$$\begin{aligned} F/U_{\mathcal{V}} &\xrightarrow{i_U} Y/U_{\mathcal{V}} \xleftarrow{j_U} S/U_{\mathcal{V}}, \\ F/P_{\mathcal{V}} &\xrightarrow{i_P} Y/P_{\mathcal{V}} \xleftarrow{j_P} S/P_{\mathcal{V}}. \end{aligned}$$

Denote ϕ^X, π^X, α^X maps (3.4.3) for $\mathcal{O} = X \in \{Y, F, S\}$. Let $K \in D_{L_{\mathcal{V}}}(pt)$, $K_U = \phi^{Y*}K \in D_{P_{\mathcal{W}} \times L_{\mathcal{V}}}(Y/U_{\mathcal{V}})$, $K_P = \pi_*^Y K_U \in D_{P_{\mathcal{W}}}(Y/P_{\mathcal{V}})$ (see the middle row in the following diagram).

$$\begin{array}{ccccccc} D_{L_{\mathcal{V}}}(pt) & \xrightarrow{\phi^{S*}} & D_{P_{\mathcal{W}} \times L_{\mathcal{V}}}(S/U_{\mathcal{V}}) & \xrightarrow[\sim]{\pi_*^S} & D_{P_{\mathcal{W}}}(S/P_{\mathcal{V}}) & \xrightarrow{\alpha_!^S} & D_{P_{\mathcal{W}}}(pt) \\ \parallel & & \uparrow j_U^* & & \uparrow j_P^* \downarrow j_{P!} & & \parallel \\ D_{L_{\mathcal{V}}}(pt) & \xrightarrow{\phi^{Y*}} & D_{P_{\mathcal{W}} \times L_{\mathcal{V}}}(Y/U_{\mathcal{V}}) & \xrightarrow[\sim]{\pi_*^Y} & D_{P_{\mathcal{W}}}(Y/P_{\mathcal{V}}) & \xrightarrow{\alpha_!^Y} & D_{P_{\mathcal{W}}}(pt) \\ \parallel & & \downarrow i_U^* & & \downarrow i_P^* \uparrow i_{P!} & & \parallel \\ D_{L_{\mathcal{V}}}(pt) & \xrightarrow{\phi^{F*}} & D_{P_{\mathcal{W}} \times L_{\mathcal{V}}}(F/U_{\mathcal{V}}) & \xrightarrow[\sim]{\pi_*^F} & D_{P_{\mathcal{W}}}(F/P_{\mathcal{V}}) & \xrightarrow{\alpha_!^F} & D_{P_{\mathcal{W}}}(pt) \end{array}$$

Applying $\alpha_!^Y$ to a standard triangle for K_P we get a distinguished triangle

$$\alpha_!^Y j_{P!} j_P^* K_P \rightarrow \alpha_!^Y K_P \rightarrow \alpha_!^Y i_{P!} i_P^* K_P \rightarrow$$

The above diagram shows that it is isomorphic to certain following sequences:

$$\begin{aligned} \alpha_!^S p_{2*}^S j_U^* K_U &\rightarrow \alpha_!^Y \pi_*^Y K_U \rightarrow \alpha_!^F \pi_*^F i_U^* K_U \rightarrow \\ \alpha_!^S \pi_*^S \phi^{S*} K &\rightarrow \alpha_!^Y \pi_*^Y \phi^{Y*} K \rightarrow \alpha_!^F \pi_*^F \phi^{F*} K \rightarrow \end{aligned}$$

This is the triangle

$$\Psi_{\mathcal{W}}^{S;\mathcal{V}} K \rightarrow \Psi_{\mathcal{W}}^{Y;\mathcal{V}} K \rightarrow \Psi_{\mathcal{W}}^{F;\mathcal{V}} K \rightarrow$$

from which the structure triangle

$$\mathbb{K}_{\mathcal{W}}^{S;\mathcal{V}} K \xrightarrow{a^{SY}} \mathbb{K}_{\mathcal{W}}^{Y;\mathcal{V}} K \xrightarrow{b^{YF}} \mathbb{K}_{\mathcal{W}}^{F;\mathcal{V}} K \xrightarrow{c^{FS}} \quad (3.11.1)$$

is obtained by application of the exact functor $\mathfrak{h}_{\mathcal{W}}$.

This triangle replaces non-existing isomorphism $\mathbb{K}_{\mathcal{W}}^{Y;\mathcal{V}} K \simeq \mathbb{K}_{\mathcal{W}}^{S;\mathcal{V}} K \oplus \mathbb{K}_{\mathcal{W}}^{F;\mathcal{V}} K$ (this would be too much to ask for).

3.11.1. Proposition. *For any pair of closed embeddings $F \subset Z \subset Y$ set $S = Y - F$, $Q = Z - F$, $R = Y - Z$. The following diagram made with distinguished triangles (3.11.1) is an octahedron.*

That is, the four triangles marked “=” commute, as well as two squares

$$\begin{array}{ccc} \mathbb{K}^Z & \xrightarrow{b^{ZF}} & \mathbb{K}^F \\ c^{ZR} \downarrow & & \downarrow c^{FS} \\ T\mathbb{K}^R & \xrightarrow{Ta^{RS}} & T\mathbb{K}^S \end{array} \quad \begin{array}{ccc} \mathbb{K}^S & \xrightarrow{a^{SY}} & \mathbb{K}^Y \\ b^{SQ} \downarrow & & \downarrow b^{YZ} \\ \mathbb{K}^Q & \xrightarrow{a^{QZ}} & \mathbb{K}^Z \end{array} .$$

The proof follows from Corollary C.2.2.

Appendix A. Technical results

A.1. An equivalence of equivariant derived categories

Let P be a linear complex algebraic group, let U, L be its subgroups such that U is normal in P and the manifold U is an affine space. Assume that P is a semidirect product of U and L , that is, the multiplication map $\cdot : U \times L \rightarrow P$ is an isomorphism of manifolds. Denote by $\iota : L \hookrightarrow P$ and $\kappa : P \rightarrow L$ the natural inclusion and projection. Let Y be a P -variety, let E be an L -variety, let $i : E \rightarrow Y$ be a ι -map and let $p : Y \rightarrow E$ be a κ -map identifying E with the quotient $U \backslash Y$ such that $p \circ i = \text{id}_E$. Consider

$$W = P \times_L E = (P \times E)/L, \quad (p, e).l \stackrel{\text{def}}{=} (pl, l^{-1}e).$$

The variety W is a P -variety via left translations on P . As a P -variety W is isomorphic to $U \times E$, where P acts by

$$(u, l).(v, e) = (u \cdot (lv l^{-1}), l.e).$$

There is a surjective map of P -varieties

$$\pi : W \simeq U \times E \rightarrow Y, \quad (u, e) \mapsto u.i(e).$$

Assume furthermore that π is a locally trivial fibration with affine fibers. Then $\pi : W \rightarrow Y$ is ∞ -acyclic in the sense of [2].

A.1.1. Lemma. *In the above assumptions the functor $\pi^* : D_P^b(Y) \rightarrow D_P^b(W)$ is fully faithful.*

Proof. Choose an interval $I = [a, b] \subset \mathbb{Z}$ and a number $m \geq |I|$. Let $M = M_m$ be an m -acyclic free P -manifold. Then $R = M \times W \xrightarrow{\text{pr}} W$ is a m -acyclic P -resolution of W and $r : R \xrightarrow{\text{pr}_2} W \xrightarrow{\pi} Y$ is such of Y . We know that

$$\pi^* : D^I(Y) \rightarrow D^I(W)$$

is full and faithful, see Proposition 1.9.2 of [2]. Therefore, functor from Section 2.1.6 of [2]

$$\pi^* : D_P^I(Y, R) \rightarrow D_P^I(W, R), \quad (\text{A.1.1})$$

$$\begin{aligned} \pi^*(F_Y, \overline{F}, \beta : r^*F_Y \xrightarrow{\sim} q^*\overline{F}) \\ = (\pi^*F_Y, \overline{F}, \gamma : \text{pr}^*\pi^*F_Y \simeq r^*F_Y \xrightarrow{\sim} q^*\overline{F}), \end{aligned}$$

is also full and faithful, where $q : R \rightarrow \overline{R}$, $r : R \xrightarrow{\text{pr}} W \xrightarrow{\pi} Y$. Indeed, a morphism of $D_P^I(Y, R)$ is a pair $(\alpha_Y : F_Y \rightarrow H_Y, \overline{\alpha} : \overline{F} \rightarrow \overline{H})$, which makes commutative the right square in the following diagram

$$\begin{array}{ccccc} \text{pr}^*\pi^*F_Y & \xrightarrow{\sim} & r^*F_Y & \xrightarrow{\beta} & q^*\overline{F} \\ \text{pr}^*\pi^*\alpha_Y \downarrow & & = r^*\alpha_Y \downarrow & & \downarrow q^*\overline{\alpha} \\ \text{pr}^*\pi^*H_Y & \xrightarrow{\sim} & r^*H_Y & \xrightarrow{\beta} & q^*\overline{H} \end{array} \quad . \quad (\text{A.1.2})$$

The morphism $(\alpha_Y, \overline{\alpha})$ is sent by π^* to a morphism $(\pi^*\alpha_Y, \overline{\alpha})$. This shows faithfulness of functor (A.1.1). This functor is also full because any morphism $(\pi^*F_Y, \overline{F}, \phi) \rightarrow (\pi^*H_Y, \overline{H}, \eta)$ has to be of the form $(\pi^*\alpha_Y, \overline{\alpha})$ for some α_Y . The commutativity of the exterior of diagram (A.1.2) implies that the pair $(\alpha_Y, \overline{\alpha})$ is a morphism.

Assign $D_P^I(Y) = D_P^I(Y, R)$, $D_P^I(W) = D_P^I(W, R)$ and vary $R = M_m \times W$, increasing m . Since $D_P^b(Y)$ (resp. $D_P^b(W)$) is a colimit of a system of fully faithful functors $D_P^J(Y) \rightarrow D_P^I(Y)$, $J \subset I$, (by Definition 2.2.4 of [2]), we see that the colimits are also fully and faithfully embedded. \square

A.1.2. Proposition. *The functors*

$$\begin{aligned} \pi^* : D_P^{b,c}(Y) &\rightarrow D_P^{b,c}(W), \\ p^* : D_L^{b,c}(E) &\rightarrow D_P^{b,c}(Y), \\ i^* : D_P^{b,c}(Y) &\rightarrow D_L^{b,c}(E) \end{aligned}$$

are equivalences, and the last two are quasi-inverse to each other.

Proof. Notice that $W \simeq U \times E$ is a free U -variety. Denote by $\phi : P \twoheadrightarrow L = P/U$ the canonical projection. The ϕ -map $s : W \xrightarrow{\pi} Y \xrightarrow{p} E$ is the projection $W \rightarrow U \setminus W = E$.

Therefore, the functor $s^* : D_L^{b,c}(E) \rightarrow D_P^{b,c}(W)$ is an equivalence by Theorem 2.6.2 of [2]. It decomposes as

$$s^* = (D_L^{b,c}(E) \xrightarrow{p^*} D_P^{b,c}(Y) \xrightarrow{\pi^*} D_P^{b,c}(W)).$$

We conclude that π^* is essentially surjective on objects, hence, an equivalence by Lemma A.1.1. Therefore, p^* is also an equivalence. Since

$$(D_L^{b,c}(E) \xrightarrow{p^*} D_P^{b,c}(Y) \xrightarrow{i^*} D_L^{b,c}(E)) \simeq \text{Id}$$

i^* is a quasi-inverse of p^* (and also an equivalence). \square

Appendix B. Properties of standard isomorphisms

B.1. Inverse image isomorphisms

B.1.1. **Proposition.** *Isomorphisms ι from (2.2.1) satisfy the cocycle condition:*

$$\begin{array}{ccc}
 D_K^{b,c}(Z) & \xrightarrow{g^*} & D_H^{b,c}(Y) \\
 \uparrow h^* & \swarrow \iota_{h,g} & \uparrow \\
 D_L^{b,c}(W) & \xrightarrow{(hg)^*} & D_G^{b,c}(X) \\
 & \searrow \iota_{hg,f} & \downarrow f^*
 \end{array}
 =
 \begin{array}{ccc}
 D_K^{b,c}(Z) & \xrightarrow{g^*} & D_H^{b,c}(Y) \\
 \uparrow h^* & \swarrow \iota_{h,gf} & \uparrow \\
 D_L^{b,c}(W) & \xrightarrow{(hgf)^*} & D_G^{b,c}(X) \\
 & \searrow \iota_{hg,f} & \downarrow f^*
 \end{array}
 \quad (B.1.1)$$

Proof. Compose this equation with the functor

$$D_G^{b,c}(X) \rightarrow D^{b,c}(\text{Res}(f, g, h) \rightarrow \mathcal{T})$$

and substitute the definition of ι . Its interpretation might be the following: ι and i are gauge equivalent via gauge transformation η . The required equation reduces to equality of the following two isomorphisms:

$$\begin{array}{ccccc}
 & & D^{b,c}(\text{Res}(h) \rightarrow \mathcal{T}) & \xrightarrow{g^*} & D^{b,c}(\text{Res}(g, h) \rightarrow \mathcal{T}) \\
 & \nearrow h^* & \downarrow i_{h,g} & \nearrow \sim & \downarrow f^* \\
 D_L^{b,c}(W) & \xrightarrow{(hg)^*} & D^{b,c}(\text{Res}(hg) \rightarrow \mathcal{T}) & = & D^{b,c}(\text{Res}(f, g, h) \rightarrow \mathcal{T}) \\
 \downarrow (hgf)^* & \swarrow \iota_{hg,f} & \downarrow f^* & \nearrow \sim & \\
 D^{b,c}(\text{Res}(hgf) \rightarrow \mathcal{T}) & \xrightarrow{\sim} & D^{b,c}(\text{Res}(f, hg) \rightarrow \mathcal{T}) & &
 \end{array}$$

$$\begin{array}{ccccc}
 & & D^{b,c}(\text{Res}(h) \rightarrow \mathcal{T}) & \xrightarrow{g^*} & D^{b,c}(\text{Res}(g, h) \rightarrow \mathcal{T}) \\
 & \nearrow h^* & \downarrow (gf)^* & \nearrow \iota_{g,f} & \downarrow f^* \\
 D_L^{b,c}(W) & \xrightarrow{(hg)^*} & D^{b,c}(\text{Res}(gf, h) \rightarrow \mathcal{T}) & \xrightarrow{\sim} & D^{b,c}(\text{Res}(f, g, h) \rightarrow \mathcal{T}) \\
 \downarrow (hgf)^* & \swarrow \iota_{hg,f} & \downarrow \sim & \nearrow \sim & \\
 D^{b,c}(\text{Res}(hgf) \rightarrow \mathcal{T}) & \xrightarrow{\sim} & D^{b,c}(\text{Res}(f, hg) \rightarrow \mathcal{T}) & = &
 \end{array}$$

This equation follows from (B.1.1) for $D^{b,c}(T)$, $T \in \mathcal{T}$, which in turn follows from the same equation for $D^b(T)$ and, in turn, for the category of sheaves. \square

B.2. Properties of base change isomorphisms

B.2.1. **Lemma.** *Whenever squares 1 and 2 below are pull-back squares of algebraic varieties*

$$\begin{array}{ccccc}
 X & \xrightarrow{\kappa} & Y & \xrightarrow{\lambda} & Z \\
 f \downarrow & \lrcorner & \downarrow g & \lrcorner & \downarrow h \\
 & 1 & & 2 & \\
 U & \xrightarrow{\nu} & V & \xrightarrow{\mu} & W
 \end{array}
 \quad (B.2.1)$$

the following equation holds

$$\begin{array}{ccc}
 \nu^* \mu^* (Rh_1) & \xrightarrow{\nu^* \beta_2} & \nu^* (Rg_1) \lambda^* \xrightarrow{\beta_1} (Rf_1) \kappa^* \lambda^* \\
 \downarrow i_{\mu, \nu} & = & \downarrow Rf_1 i_{\lambda, \kappa} \\
 (\mu\nu)^* Rh_1 & \xrightarrow{\beta} & (Rf_1) (\lambda \kappa)^*
 \end{array} \quad . \quad (B.2.2)$$

The statement can be reformulated as an equation

$$\begin{array}{ccc}
 \begin{array}{ccc}
 D^{b,c}(X) & \xleftarrow{(\lambda\kappa)^*} & D^{b,c}(Z) \\
 \downarrow Rf_1 & & \downarrow Rh_1 \\
 D^{b,c}(U) & \xleftarrow{(\mu\nu)^*} & D^{b,c}(W) \\
 \swarrow \nu^* & & \searrow \mu^* \\
 & D^{b,c}(V) &
 \end{array} & = & \begin{array}{ccc}
 D^{b,c}(X) & \xleftarrow{(\lambda\kappa)^*} & D^{b,c}(Z) \\
 \downarrow Rf_1 & \swarrow \tau^* & \downarrow Rh_1 \\
 & D^{b,c}(Y) & \\
 \downarrow Rg_1 & & \\
 D^{b,c}(U) & & D^{b,c}(W) \\
 \swarrow \nu^* & & \searrow \mu^* \\
 & D^{b,c}(V) &
 \end{array}
 \end{array}$$

Proof. First we prove analogous to (B.2.2) equation for sheaves. We use the definition of the base change isomorphism of sheaves, corresponding to the pull-back square

$$\begin{array}{ccc}
 & \xrightarrow{e} & \\
 h \downarrow & \lrcorner & \downarrow l \\
 & \xrightarrow{k} &
 \end{array}$$

It is defined as the composition

$$\beta : k^* l_! \xrightarrow{\eta} k^* l_! e_* e^* \hookrightarrow k^* k_* h_1 e^* \xrightarrow{\epsilon} h_1 e^*$$

or as

$$\beta = \begin{array}{ccc}
 & \xleftarrow{e^*} & \\
 h_1 \downarrow & \swarrow e_* & \downarrow \\
 & \xleftarrow{k_*} & \\
 \downarrow \epsilon & & \downarrow l_! \\
 & \xleftarrow{k^*} &
 \end{array} ,$$

where ϵ and η are adjunction maps. Equation (B.2.2) for sheaves which we want to prove becomes an equation between the following two isomorphisms

$$\begin{array}{ccc}
 Sh(X) & \xleftarrow{(\lambda\kappa)^*} & Sh(Z) \\
 f_! \downarrow & \searrow^{(\lambda\kappa)_*} & \xleftarrow{\eta} \Downarrow \\
 Sh(U) & \xleftarrow{\quad} & Sh(Z) \\
 \Downarrow \epsilon & \searrow^{(\mu\nu)_*} & \downarrow h_! \\
 Sh(U) & \xleftarrow{(\mu\nu)^*} & Sh(W) \\
 & \swarrow^{\nu^*} \quad \Downarrow \quad \swarrow^{\mu^*} & \\
 & Sh(V) &
 \end{array} \tag{B.2.3}$$

$$\begin{array}{ccc}
 \begin{array}{ccc}
 Sh(X) & \xleftarrow{(\lambda\kappa)^*} & Sh(Z) \\
 f_! \downarrow & \searrow^{\kappa_*} & \Downarrow \eta \\
 Sh(U) & \xleftarrow{\quad} & Sh(Y) \\
 \Downarrow \epsilon & \searrow^{\nu_*} & \downarrow g_! \\
 Sh(U) & \xleftarrow{\quad} & Sh(V) \\
 \swarrow^{\nu^*} & \Downarrow & \swarrow^{\mu^*} \\
 & Sh(V) &
 \end{array} & = & \begin{array}{ccc}
 Sh(X) & \xleftarrow{(\lambda\kappa)^*} & Sh(Z) \\
 f_! \downarrow & \searrow^{\kappa_*} & \xleftarrow{\eta} \Downarrow \\
 Sh(U) & \xleftarrow{\quad} & Sh(Y) \\
 \Downarrow \epsilon & \searrow^{\nu_*} & \downarrow g_! \\
 Sh(U) & \xleftarrow{\quad} & Sh(V) \\
 \swarrow^{\nu^*} & \Downarrow & \swarrow^{\mu^*} \\
 & Sh(V) &
 \end{array}
 \end{array}$$

The parallelogram in diagram (B.2.3) equals to the parallelogram in the right diagram above since the embedding $h_!(\lambda\kappa)_* \hookrightarrow (\mu\nu)_*f_!$ can be presented as a composition of two embeddings

$$h_!\lambda_*\kappa_* \hookrightarrow \mu_*g_!\kappa_* \hookrightarrow \mu_*\nu_*f_!.$$

Indeed, all these functors are subfunctors of $h_*\lambda_*\kappa_* = \mu_*\nu_*f_*$.

From equation (B.2.2) for sheaves we deduce it for derived functors. \square

B.2.2. Proposition. *Let $f : X \rightarrow U$, $g : Y \rightarrow V$ and $h : Z \rightarrow W$ be G -equivariant, H -equivariant and K -equivariant maps of algebraic varieties. Let $X \xrightarrow{\kappa} Y \xrightarrow{\lambda} Z$ and $U \xrightarrow{\nu} V \xrightarrow{\mu} W$ be $G \xrightarrow{\phi} H \xrightarrow{\psi} K$ -equivariant. Assume that squares 1 and 2 of commutative diagram (B.2.1) are pull-back squares. Then the following equation holds*

$$\begin{array}{ccc}
 \nu^*\mu^*h_! & \xrightarrow{\nu^*\beta_2} & \nu^*g_!\lambda^* & \xrightarrow{\beta_1} & f_!\kappa^*\lambda^* \\
 i_{\mu,\nu} \downarrow & & = & & \downarrow f_!i_{\lambda,\kappa} \\
 (\mu\nu)^*h_! & \xrightarrow{\quad \beta \quad} & & & f_!(\lambda\kappa)^*
 \end{array}$$

The statement can be reformulated as an equation

$$\begin{array}{ccc}
 \begin{array}{ccc}
 D_G^{b,c}(X) & \xleftarrow{(\lambda\kappa)^*} & D_K^{b,c}(Z) \\
 \downarrow f_! & & \downarrow h_! \\
 D_G^{b,c}(U) & \xleftarrow{(\mu\nu)^*} & D_K^{b,c}(W) \\
 \swarrow \nu^* & & \searrow \mu^* \\
 & D_H^{b,c}(V) &
 \end{array} & = &
 \begin{array}{ccc}
 D_G^{b,c}(X) & \xleftarrow{(\lambda\kappa)^*} & D_K^{b,c}(Z) \\
 \downarrow f_! & \swarrow \tau^* & \searrow \tau^* \\
 & D_H^{b,c}(Y) & \\
 \downarrow f_! & \downarrow g_! & \downarrow h_! \\
 D_G^{b,c}(U) & & D_K^{b,c}(W) \\
 \swarrow \nu^* & & \searrow \mu^* \\
 & D_H^{b,c}(V) &
 \end{array}
 \end{array}$$

Proof. The statement reduces to equality between the following two isomorphisms:

$$\begin{array}{ccc}
 D^{b,c}(\text{Res}(\kappa, \lambda; \phi, \psi) \rightarrow \mathcal{T}) & \xleftarrow{\sim} & D^{b,c}(\text{Res}(\lambda\kappa; \psi\phi) \rightarrow \mathcal{T}) \xleftarrow{(\lambda\kappa)^*} D_K^{b,c}(Z) \\
 \downarrow f_! & = & \downarrow f_! \begin{array}{c} \swarrow \beta \\ \searrow \beta \end{array} \downarrow h_! \\
 D^{b,c}(\text{Res}(\nu, \mu; \phi, \psi) \rightarrow \mathcal{T}) & \xleftarrow{\sim} & D^{b,c}(\text{Res}(\mu\nu; \psi\phi) \rightarrow \mathcal{T}) \xleftarrow{(\mu\nu)^*} D_K^{b,c}(W) \\
 & \swarrow \nu^* & \downarrow i \swarrow \mu^* \\
 & D^{b,c}(\text{Res}(\mu, \psi) \rightarrow \mathcal{T}) &
 \end{array}$$

$$\begin{array}{ccc}
 D^{b,c}(\text{Res}(\kappa, \lambda; \phi, \psi) \rightarrow \mathcal{T}) & \xleftarrow{\sim} & D^{b,c}(\text{Res}(\lambda\kappa; \psi\phi) \rightarrow \mathcal{T}) \xleftarrow{(\lambda\kappa)^*} D_K^{b,c}(Z) \\
 \downarrow f_! & \swarrow \kappa^* & \downarrow i \swarrow \lambda^* \downarrow h_! \\
 D^{b,c}(\text{Res}(\nu, \mu; \phi, \psi) \rightarrow \mathcal{T}) & \xleftarrow{\sim} & D^{b,c}(\text{Res}(\lambda, \phi) \rightarrow \mathcal{T}) \xleftarrow{\beta} D_K^{b,c}(W) \\
 & \swarrow \nu^* & \downarrow g_! \swarrow \mu^* \\
 & D^{b,c}(\text{Res}(\mu, \psi) \rightarrow \mathcal{T}) &
 \end{array}$$

Substituting definitions of isomorphisms β from Section 2.2.7 and similar, we see that the equation between the above isomorphisms follows from Lemma B.2.1, that is, from the non-equivariant version. \square

Appendix C. Distinguished triangles and octahedrons

C.1. Standard distinguished triangles.

Let us consider a closed G -invariant subspace $i : X \hookrightarrow Y$ with the complement $S = Y - X$, $j : S \hookrightarrow Y$. Let $P \rightarrow Y$ be a resolution of Y . As explained in [2] resolutions of X of the form $X \times_Y P \rightarrow X$ taken from the pull-back square

$$\begin{array}{ccc}
 X \times_Y P & \xrightarrow{i} & X \\
 \downarrow & \lrcorner & \downarrow \\
 X & \xrightarrow{i} & Y
 \end{array}$$

suffice to determine an object of $D_G^{b,c}(X)$ up to an isomorphism. Therefore, the functor $i_!i^*$ is canonically isomorphic to the functor

$$\begin{aligned} \widetilde{i_!i^*} : D_G^{b,c}(Y) &\longrightarrow D_G^{b,c}(Y) \\ [P \mapsto K(P)] &\longmapsto [P \mapsto \underline{\widetilde{i_!i^*}}(K(P))] \end{aligned}$$

Similarly for $j_!j^*$.

There is a distinguished triangle in $D_G^{b,c}(Y)$ [2]

$$\widetilde{j_!j^*}K \xrightarrow{a} K \xrightarrow{b} \widetilde{i_!i^*}K \xrightarrow{c}$$

given by a collection of standard distinguished triangles [1]

$$\underline{\widetilde{j_!j^*}}(KP) \xrightarrow{a_{KP}} KP \xrightarrow{b_{KP}} \underline{\widetilde{i_!i^*}}(KP) \xrightarrow{c_{KP}}$$

for $P \in \text{Res}(Y, G)$. The canonically isomorphic to it distinguished triangle in $D_G^{b,c}(Y)$ is denoted

$$j_!j^*K \xrightarrow{a_K} K \xrightarrow{b_K} i_!i^*K \xrightarrow{c_K} .$$

C.2. Standard octahedron associated with a triple of spaces.

Suppose that $X \subset Z \subset Y$ are closed embeddings of stratified subspaces of some stratified space and $S = Y - X$, $Q = Z - X$, $R = Y - Z$. With a closed embedding i and the complementary embedding j is associated a standard triangle [1] in $D(X)$

$$j_!j^*K \xrightarrow{a_K} K \xrightarrow{b_K} i_!i^*K \xrightarrow{c_K} .$$

Denote by $i_{YZ}, i_{YX}, i_{ZX}, i_{SQ}$ the closed embeddings and $j_{RY}, j_{QZ}, j_{SY}, j_{RX}$ the open ones. Add corresponding indices to the triangle maps a, b, c .

C.2.1. Proposition. *The obvious identification of vertices makes the following diagram in $D(Y)$ into an octahedron*

$$\begin{array}{ccc} j_{RY}!j_{RY}^*K & \xrightarrow{a^{RY}} & K \\ \uparrow 1 & \swarrow c^{ZR} & \searrow b^{YZ} \\ & = & i_{YZ}!i_{YZ}^*K \\ & \swarrow i_{YZ}!a^{QZ} & \searrow i_{YZ}!b^{ZX} \\ i_{YZ}!j_{QZ}!j_{QZ}^*i_{YZ}^*K & \xleftarrow{i_{YZ}!c^{XQ}} & i_{YZ}!i_{ZX}!i_{ZX}^*i_{YZ}^*K \end{array}$$

$$\begin{array}{ccc} j_{SY}!j_{RS}!j_{RS}^*j_{SY}^*K & \xrightarrow{a^{SY}} & K \\ \uparrow j_{SY}!c^{QR} & \swarrow j_{SY}!a^{RS} & \searrow a^{SY} \\ & = & j_{SY}!j_{SY}^*K \\ & \swarrow j_{SY}!b^{SQ} & \searrow c^{XS} \\ j_{SY}!i_{SQ}!i_{SQ}^*j_{SY}^*K & \xleftarrow{1} & i_{YX}!i_{YX}^*K \end{array}$$

That is, the following “triangles” and “squares” commute.

$$\begin{array}{ccc}
 Tj_{SY!}j_{RS!}j_{RS}^*j_{SY}^*K & \xrightarrow[\sim]{\iota\iota} & Tj_{RY!}j_{RY}^*K \\
 \uparrow j_{SY!}c^{QR} & & \swarrow c^{ZR} \\
 & & i_{YZ!}i_{YZ}^*K \\
 & & \nearrow i_{YZ!}a^{QZ} \\
 j_{SY!}j_{SQ!}j_{SQ}^*j_{SY}^*K & \xrightarrow[\sim]{} & i_{YZ!}j_{QZ!}j_{QZ}^*i_{YZ}^*K
 \end{array}
 \quad 1$$

$$\begin{array}{ccc}
 i_{YZ!}i_{YZ}^*K & \xleftarrow{b^{YZ}} & K \\
 \downarrow i_{YZ!}b^{YZ} & & \downarrow b^{YX} \\
 i_{YZ!}i_{ZX!}i_{ZX}^*i_{YZ}^*K & \xleftarrow[\sim]{\iota\iota} & i_{YX!}i_{YX}^*K
 \end{array}
 \quad 2$$

$$\begin{array}{ccc}
 j_{RY!}j_{RY}^*K & \xrightarrow{a^{RY}} & K \\
 \downarrow \iota\iota & & \uparrow a^{SY} \\
 j_{SY!}j_{RS!}j_{RS}^*j_{SY}^*K & \xrightarrow{j_{SY!}a^{RS}} & j_{SY!}j_{SY}^*K
 \end{array}
 \quad 3$$

$$\begin{array}{ccc}
 & Tj_{SY!}j_{SY}^*K & \\
 \swarrow j_{SY!}b^{SQ} & & \swarrow c^{XS} \\
 Tj_{SY!}i_{SQ!}i_{SQ}^*j_{SY}^*K & & i_{YX!}i_{YX}^*K \\
 \downarrow \wr & & \downarrow \wr \\
 Ti_{YZ!}j_{QZ!}j_{QZ}^*i_{YZ}^*K & \xleftarrow{i_{YZ!}c^{XQ}} & i_{YZ!}i_{ZX!}i_{ZX}^*i_{YZ}^*K
 \end{array}
 \quad 4$$

$$\begin{array}{ccc}
 i_{YZ!}i_{YZ}^*K & \xrightarrow{i_{YZ!}b^{ZX}} & i_{YZ!}i_{ZX!}i_{ZX}^*i_{YZ}^*K & \xrightarrow[\sim]{\iota\iota} & i_{YX!}i_{YX}^*K \\
 \downarrow c^{ZR} & & & & \downarrow c^{XS} \\
 Tj_{RY!}j_{RY}^*K & \xrightarrow[\sim]{\iota\iota} & Tj_{SY!}j_{RS!}j_{RS}^*j_{SY}^*K & \xrightarrow{j_{SY!}a^{RS}} & Tj_{SY!}j_{SY}^*K
 \end{array}
 \quad 5$$

$$\begin{array}{ccc}
 j_{SY!}j_{SY}^*K & \xrightarrow{a^{SY}} & K \\
 \downarrow j_{SY!}b^{SQ} & & \downarrow b^{YZ} \\
 j_{SY!}i_{SQ!}i_{SQ}^*j_{SY}^*K & \xrightarrow[\sim]{} & i_{YZ!}j_{QZ!}j_{QZ}^*i_{YZ}^*K & \xrightarrow{i_{YZ!}a^{QZ}} & i_{YZ!}i_{YZ}^*K
 \end{array}
 \quad 6$$

Proof. This octahedron in a derived category of sheaves follows [1] from the commutative diagram with exact lines in the abelian category of sheaves.

$$\begin{array}{ccccc}
 & & 0 & & 0 \\
 & & \searrow & & \swarrow \\
 & & & k_{QY}!k_{QY}^*\mathcal{F} & \\
 & & \swarrow & & \searrow \\
 0 & & & j_{SY}!j_{SY}^*\mathcal{F} & i_{YZ}!i_{YZ}^*\mathcal{F} & \rightarrow 0 \\
 & & \swarrow & \searrow & \swarrow & \searrow \\
 & & & \mathcal{F} & & \\
 & & \swarrow & & \searrow & \\
 & & & i_{YX}!i_{YX}^*\mathcal{F} & & \rightarrow 0 \\
 & & \swarrow & & \searrow \\
 0 & & & & & 0 \\
 & & \swarrow & & \searrow \\
 & & & j_{RY}!j_{RY}^*\mathcal{F} & & \\
 & & \swarrow & & \searrow \\
 0 & & & & & 0 \\
 & & \swarrow & & \searrow \\
 & & & j_{SY}!j_{RS}^*j_{RS}^*j_{SY}^*\mathcal{F} & & \\
 & & \swarrow & & \searrow \\
 & & & j_{SY}!j_{SY}^*\mathcal{F} & & \\
 & & \swarrow & & \searrow \\
 & & & i_{SY}!i_{SQ}^*i_{SQ}^*j_{SY}^*\mathcal{F} & & \rightarrow 0 \\
 & & \swarrow & & \searrow \\
 & & & i_{YZ}!j_{QZ}^*j_{QZ}^*i_{YZ}^*\mathcal{F} & & \\
 & & \swarrow & & \searrow \\
 & & & i_{YZ}!i_{YZ}^*\mathcal{F} & & \\
 & & \swarrow & & \searrow \\
 & & & i_{YZ}!i_{ZX}^*i_{ZX}^*i_{YZ}^*\mathcal{F} & & \rightarrow 0
 \end{array}
 \tag{C.2.1}$$

Here $k_{QY} : Q \hookrightarrow Y$ denotes the embedding. The ambiguous north-north-east line is isomorphic to the exact sequence

$$0 \rightarrow j_{SY}!j_{RS}^*j_{RS}^*j_{SY}^*\mathcal{F} \xrightarrow{j_{SY}!a_{j^*\mathcal{F}}^{RS}} j_{SY}!j_{SY}^*\mathcal{F} \xrightarrow{j_{SY}!b_{j^*\mathcal{F}}^{SQ}} j_{SY}!i_{SQ}^*i_{SQ}^*j_{SY}^*\mathcal{F} \rightarrow 0.$$

The ambiguous south-south-east line is isomorphic to the exact sequence

$$0 \rightarrow i_{YZ}!j_{QZ}^*j_{QZ}^*i_{YZ}^*\mathcal{F} \xrightarrow{i_{YZ}!a_{i^*\mathcal{F}}^{QZ}} i_{YZ}!i_{YZ}^*\mathcal{F} \xrightarrow{i_{YZ}!b_{i^*\mathcal{F}}^{ZX}} i_{YZ}!i_{ZX}^*i_{ZX}^*i_{YZ}^*\mathcal{F} \rightarrow 0.$$

This shows exactness of the lines of the diagram. It remains to show commutativity of the two triangles and the quadrangle.

Together with a hidden isomorphism the left triangle is square 3:

$$\begin{array}{ccc}
 j_{SY}!j_{RS}^*j_{RS}^*j_{SY}^*\mathcal{F} & \xrightarrow{j_{SY}!a_{j^*\mathcal{F}}^R} & j_{SY}!j_{SY}^*\mathcal{F} \\
 \downarrow \wr & & \downarrow a_{\mathcal{F}}^{SY} \\
 j_{RY}!j_{RY}^*\mathcal{F} & \xrightarrow{a_{\mathcal{F}}^{RY}} & \mathcal{F}
 \end{array}$$

Recall that for any sheaf \mathcal{F} on $Y = S \cup X$ we have $j_{SY}!j_{SY}^*\mathcal{F} = \mathcal{F}_S = (\mathcal{F}|_S)^Y$ and $i_{YX}!i_{YX}^*\mathcal{F} = \mathcal{F}_X = (\mathcal{F}|_X)^Y$, the sheaves extended by 0 from S (resp. from X). The embedding $a_{\mathcal{F}}^{SY} : j_{SY}!j_{SY}^*\mathcal{F} \rightarrow \mathcal{F}$ is the embedding of *espaces étalés* $\mathcal{F}_S \hookrightarrow \mathcal{F}$. Therefore, (C.2) states simply that the triangle of embeddings

$$\begin{array}{ccc}
 & \mathcal{F}_S & \\
 \hookrightarrow & & \hookrightarrow \\
 \mathcal{F}_R & & \mathcal{F}
 \end{array}$$

is commutative, which is obvious.

Similarly, the right triangle of diagram (C.2.1) is square 4.

$$\begin{array}{ccc} \mathcal{F} & \xrightarrow{b_{\mathcal{F}}^{YZ}} & i_{YZ!}i_{YZ}^*\mathcal{F} \\ b_{\mathcal{F}}^{YX} \downarrow & & \downarrow i_{YZ!}b_{i^*}^{ZX} \\ i_{YX!}i_{YX}^*\mathcal{F} & \xrightarrow{\sim} & i_{YZ!}i_{ZX!}i_{ZX}^*i_{YZ}^*\mathcal{F} \end{array}$$

Since the surjection $b_{\mathcal{F}}^{YX} : \mathcal{F} \rightarrow i_{YX!}i_{YX}^*\mathcal{F}$ is interpreted as the projection $\mathcal{F} \twoheadrightarrow \mathcal{F}_X$ of espaces étalés, the commutativity of this square reduces to commutativity of

$$\begin{array}{ccc} & \mathcal{F}_Z & \\ & \nearrow & \searrow \\ \mathcal{F} & \xrightarrow{\quad} & \mathcal{F}_X \end{array}$$

which is obvious.

The quadrangle in diagram (C.2.1) is hexagon 6.

$$\begin{array}{ccccc} j_{SY!}i_{SQ!}i_{SQ}^*j_{SY}^*\mathcal{F} & \xrightarrow{\sim} & k_{QY!}k_{QY}^*\mathcal{F} & \xrightarrow{\sim} & i_{YZ!}j_{QZ!}j_{QZ}^*i_{YZ}^*\mathcal{F} \\ j_{SY!}b_{j^*}^{SQ} \uparrow & & & & \downarrow i_{YZ!}a_{i^*}^{QZ} \\ j_{SY!}j_{SY}^*\mathcal{F} & \xrightarrow{a_{\mathcal{F}}^{SY}} & \mathcal{F} & \xrightarrow{b_{\mathcal{F}}^{YX}} & i_{YZ!}i_{YZ}^*\mathcal{F} \end{array}$$

Due to identifications

$$\begin{aligned} j_{SY!}i_{SQ!}i_{SQ}^*j_{SY}^*\mathcal{F} &= ((\mathcal{F}|_Q)^S)^Y = (\mathcal{F}|_Q)^Y = \mathcal{F}_Q = k_{QY!}k_{QY}^*\mathcal{F}, \\ i_{YZ!}j_{QZ!}j_{QZ}^*i_{YZ}^*\mathcal{F} &= ((\mathcal{F}|_Q)^Z)^Y = (\mathcal{F}|_Q)^Y = \mathcal{F}_Q = k_{QY!}k_{QY}^*\mathcal{F} \end{aligned}$$

this hexagon is in fact the square

$$\begin{array}{ccc} \mathcal{F}_S & \hookrightarrow & \mathcal{F} \\ \downarrow & & \downarrow \\ \mathcal{F}_Q & \hookrightarrow & \mathcal{F}_Z \end{array}$$

Considering mappings of stalks of these sheaves at a point of Y we deduce commutativity of this square. \square

C.2.2. Corollary. *The octahedron of Proposition C.2.1 holds true in G -equivariant case.*

Proof. The octahedron for closed G -subspaces $X \subset Z \subset Y$ in $D_G(Y)$ follows from that for closed subspaces $\overline{X} \times_Y \overline{P} \subset \overline{Z} \times_Y \overline{P} \subset \overline{P}$, where P is a G -resolution of Y , see Section C.1. \square

References

- [1] A. A. Beilinson, J. Bernstein, and P. Deligne: *Faisceaux pervers*, Astérisque. No. 100, (1982) Soc. Math. de France.
- [2] J. Bernstein and V. Lunts: *Equivariant Sheaves and Functors*, Vol. 1578 of *Lecture Notes in Math.* Springer, Berlin, Heidelberg, 1994.
- [3] A. Borel: ‘Sheaf theoretic intersection cohomology’. In: *Intersection Cohomology*, Progress in Mathematics., **50**, Boston: Birkhäuser, 1984, pp. 47–182.
- [4] L. Crane and I. B. Frenkel: Four dimensional topological quantum field theory, Hopf categories, and the canonical bases, *J. Math. Phys.* **35**(10) (1994), 5136–5154.

- [5] P. Deligne: Catégories Tannakiennes, in: *The Grothendieck Festschrift*, Vol. II, Progress in Mathematics, **87**, Birkhäuser, Boston, Basel, Berlin, 1991, 111–195.
- [6] G. Lusztig: Canonical bases arising from quantized enveloping algebras, *J. American Math. Soc.* **3**(2) (1990), 447–498.
- [7] G. Lusztig: Quivers, Perverse Sheaves, and Quantized Enveloping Algebras, *J. American Math. Soc.* **4**(2) (1991), 365–421.
- [8] G. Lusztig: *Introduction to quantum groups*, Birkhäuser, Boston, 1993.
- [9] V. V. Lyubashenko: Squared Hopf Algebras, *Memoirs Amer. Math. Soc.* **142** (1999), no. 677, 184 p.
- [10] V. V. Lyubashenko: ‘On a functorial isomorphism in the derived category of ℓ -adic sheaves’, *Matematychni Studii* **14**(2) (2001), 115–120.
- [11] S. Majid: Braided groups, *J. Pure Appl. Algebra* **86**(2) (1993), 187–221.
- [12] M. Neuchl: Representation theory of Hopf categories, Ph. D. thesis. Available at: <http://www.mathematik.uni-muenchen.de/~neuchl>.

INSTITUTE OF MATHEMATICS, NATIONAL ACADEMY OF SCIENCES OF UKRAINE, 3, TERESHCHENKIVSKA ST.,
KYIV-4, 01601, UKRAINE

E-mail address: `lub@imath.kiev.ua`