

Free genus one knots with large volume

MARK BRITTENHAM

University of North Texas

ABSTRACT. In this paper we construct families of hyperbolic knots with free genus one, whose complements have arbitrarily large volume. This implies that these knots have free genus one but arbitrarily large canonical genus.

§0

INTRODUCTION

A Seifert surface for a knot K in the 3-sphere is an embedded orientable surface Σ , whose boundary equals the knot K . In 1934, Seifert [Se] gave a very simple algorithm for constructing a Seifert surface for a knot, from a diagram, or projection, D of the knot. Thus every knot has a Seifert surface.

Seifert's algorithm always builds a surface whose complement is a handlebody, something which is known as a *free* Seifert surface. The the minimal genus among all free Seifert surfaces for K is called the free genus $g_f(K)$ of K , while the minimal genus of a surface built by Seifert's algorithm applied to a projection of the knot K is called the canonical genus $g_c(K)$ of K . (In keeping with this terminology, we will call a surface built by Seifert's algorithm *canonical*.) The above considerations immediately imply that, for any knot, $g_f(K) \leq g_c(K)$. It was shown by Kobayashi and Kobayashi [KK] that these numbers can be distinct; for K the connected sum of n copies of the double of a trefoil knot, $g_f(K) = 2n$ and $g_c(K) = 3n$.

An unusual feature of these examples is that the free genus minimizing surfaces are all compressible. We were interested in finding examples where the free and canonical genera differ, but the free genus minimizing surfaces were incompressible. In doing so, we were led in a natural way to consider hyperbolic knots, in order to exploit a relationship between canonical genus and volume.

In a previous paper [Br] we showed that hyperbolic knots with bounded canonical genus have complements with bounded volume. The bound on volume can in fact be chose to be linear in the canonical genus. In this paper we show, by contrast, that there is no corresponding bound in terms of the free genus of the knot.

Theorem. *There exist hyperbolic knots with free genus one and arbitrarily large hyperbolic volume.*

These two results together show that there are free genus one hyperbolic knots with arbitrarily large canonical genus. Since a free genus one Seifert surface for a

Key words and phrases. hyperbolic knot, free genus, volume.
Research supported in part by NSF grant # DMS-9704811

non-trivial knot is always incompressible, the knots we build also provide examples of knots with incompressible free Seifert surfaces which cannot be built by applying Seifert's algorithm to a projection of the knot. We should also note that a knot with free genus one has genus one, and so we immediately obtain the following corollary.

Corollary. *There exist hyperbolic knots with genus one and arbitrarily large hyperbolic volume.*

§1

BUILDING FREE GENUS ONE KNOTS

It is easy to build knots with free genus (at most) one, simply by building a genus one surface whose spine is an unknotted graph in the 3-sphere. The complement of the surface is homeomorphic to the complement of the graph, and so is a handlebody. Consequently, the boundary of the surface has a genus 1 free Seifert surface, and so has free genus at most one. The best examples of this (and the starting point for our examples) are the 2-bridge knots (Figure 1) corresponding to the continued fractions $[2u, 2v]$ (see [HT] for notation). These surfaces are in fact isotopic to canonical surfaces for different projections of these knots.

This gives an infinite family of free genus one knots. However, since all of these knots can be built by doing $1/u$ (and $1/v$) Dehn surgeries on two of the unknotted components of a single link (Figure 1), these knots have hyperbolic volume smaller than the hyperbolic volume of the link [Th1], and so have bounded volume.

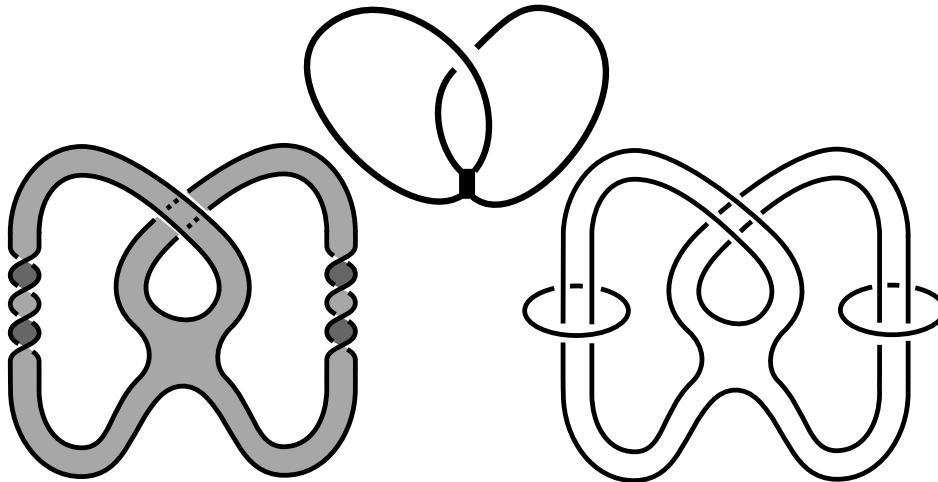

Figure 1

In order to insure that our free genus one knots will have large volume, we will rely on a result of Adams [Ad], which states that a complete hyperbolic manifold with r cusps must have volume at least rV_0 , where V_0 is the volume of a regular ideal tetrahedron. We will therefore build our knots by doing $1/n_i$ Dehn surgeries on the (unknotted) components of a hyperbolic link with r components. By a result of Thurston [Th1], for large values of the n_i , the resulting knots will also be hyperbolic and have volume close to that of the link. What we shall see is that for the particular link we choose, the resulting knots can also be seen to have free genus one Seifert surfaces, and so have free genus (at most) one.

The basic idea is to take one of the knots K in Figure 1 and throw an extra loop K_1 around the ‘waist’ of the Seifert surface F ; see Figure 2. This loop K_1 lies on a 2-sphere S bounding a 3-ball B ; $B \cap F$ is a disk and $S \cap F$ consists of four arcs. If we look at $M_0 = B \setminus \text{int}(N(F))$, it is a genus four handlebody which has the structure of a sutured manifold, where the sutures are the four loops $S \cap \partial(N(F))$. There are four obvious product disks for this sutured manifold (sitting in the plane of the paper, in the figure), so that, as a sutured manifold, M_0 is a product sutured manifold (four-punctured sphere) $\times I$. In particular, the four-punctured sphere $B \cap \partial N(F)$ is isotopic, in M_0 , to $S \setminus \text{int}(N(F))$.

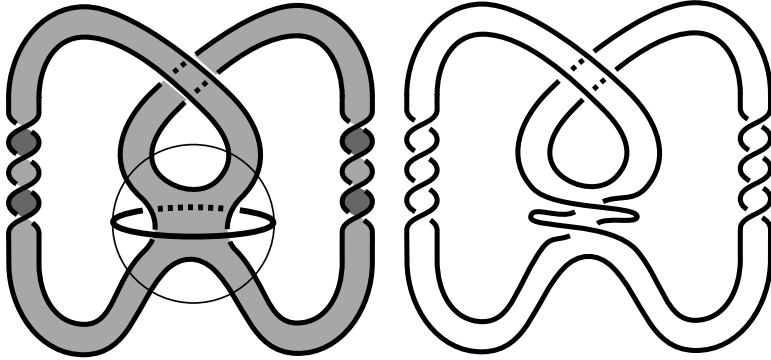

Figure 2

If we now do $1/n$ Dehn surgery on K_1 , then since K_1 is unknotted, the resulting manifold will be a 3-sphere, and so the image of K will be a knot K' in the 3-sphere. By Kirby calculus (see [Ro]), K' can be obtained from K by cutting K along a disk D spanning K_1 , giving the resulting strands n right-handed twists, and regluing. Similarly, the Seifert surface for K gives a Seifert surface F' for K' , by cutting, twisting, and regluing.

However, from the point of view of the ball B (or, more precisely, a ball slightly smaller than B), nothing has really happened; we have cut the ball open along a disk, given one half of it n full twists, and reglued *by the identity map*. Consequently, $B \setminus \text{int}(N(F')) \cong B \setminus \text{int}(N(F))$ is also a product sutured manifold, and so $B \cap \partial N(F')$ is isotopic, in $B \setminus \text{int}(N(F'))$, to $S \setminus \text{int}(N(F')) = S \setminus \text{int}(N(F))$. Therefore, $S^3 \setminus \text{int}(N(F')) \cong S^3 \setminus (\text{int}(B \cup N(F')) = S^3 \setminus (\text{int}(B \cup N(F)) \cong S^3 \setminus \text{int}(N(F))$ is also a handlebody. F' is therefore a free genus one Seifert surface for K' . Note that we could in fact have chosen any loop on S to base this construction on; it would still bound a disk in the 3-ball B , and so the argument above would go through without change. A more complicated loop would, however, unnecessarily complicate our arguments below.

More generally, we can throw many extra loops K_i around F , on concentric 2-spheres, alternating which direction around the waist of F we go (Figure 3), and do $1/n_i$ Dehn surgeries on each of them. Since without K these loops would together form a trivial link - they lie on disjoint 2-spheres - the resulting manifold will again be the 3-sphere, and so K will be taken to a new knot K' in the 3-sphere. By working inductively out from the centermost 2-sphere, cutting along disks, twisting, and regluing, we can also see that our Seifert surface F will be taken to a free Seifert surface for K' ; at each step the argument is identical to the one given above. We therefore can produce knots with free genus at most one by

this iterative construction, as well.

What we do *not* yet know is that these knots K' are hyperbolic, or that they have large volume. What we will show, however, is that the links $L_n = K \cup K_1 \cup \dots \cup K_n$ are all hyperbolic. By the result of Adams, for large n they therefore have large volume, and so when the n_i are all large, K' will have large volume (and, in particular, is therefore non-trivial, hence has free genus exactly one). This will complete the proof of our theorem.

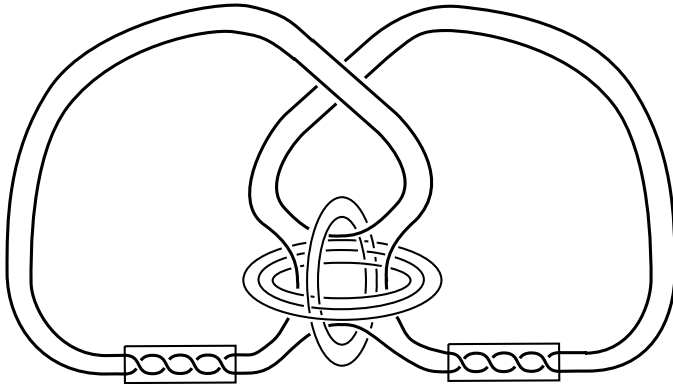

Figure 3

§2

THE LINKS L_n ARE HYPERBOLIC: PRELIMINARIES

We now demonstrate that the links L_n have hyperbolic complement; that is, the compact manifolds $M_n = S^3 \setminus \text{int}(N(L_n))$ have hyperbolic interior. By Thurston's Geometrization Theorem [Th2], we must show that

- (1) $X(L_n) = S^3 \setminus \text{int}N(L_n)$ is irreducible,
- (2) $X(L_n)$ is ∂ -irreducible, i.e., $\partial X(L_n)$ is incompressible in $X(L_n)$,
- (3) $X(L_n)$ is atoroidal, i.e., an incompressible torus T in $X(L_n)$ is parallel to $\partial X(L_n)$, and
- (4) $X(L_n)$ is anannular, i.e., any properly embedded incompressible annulus A in $X(L_n)$ is ∂ -parallel.

In this section we will set up a few additional assumptions and prove some preliminary results, which will allow us to develop the machinery to prove these assertions. The basic idea is that, since this is a proof by construction, we can (and will) make whatever assumptions we feel are necessary to bring a wide array of different tools to bear on the problem, from standard cut and paste arguments to homological intersection numbers to normal forms for words in a free group.

The main assumption we will need to make, in order to prove that the links L_n are hyperbolic, is that our underlying 2-bridge knot K , given by the continued fraction $[2u, 2v]$, lying at the center of the links L_n has $u, v \geq 2$. Experimental evidence (finding hyperbolic structures using SnapPea [We]) suggests that in fact the links are always hyperbolic, without this added assumption, but some of our arguments will not go through in greater generality. We will also assume that $n \geq 3$, since this will, in the end, make the verification of condition (4) almost immediate. Again, experimental evidence suggests that this is not a necessary assumption.

Central to our proof that the knots obtained by $1/n_i$ surgeries have free genus at most one was that the Seifert surface F for the knot K is disjoint from all of the added components K_i . In fact, each loop K_i bounds a disk D_i in S^3 which meets F in an arc α_i (Figure 4). We will assume that we have pushed these disks slightly off of one another, so that if $i - j$ is even, then D_i and D_j are disjoint. When $i - j$ is odd and $j < i$, then $D_j \cap D_i$ consists of an arc β_{ji} contained in the interior of D_i . In particular, $D_j \cap K_i$ is empty, and $D_i \cap K_j$ consists of two points. Also, for each i , $D_i \cap (F \cup D_1 \cup \dots \cup D_{i-1})$ is a finite tree, consisting of parallel arcs β_{ji} each pierced by the arc α_i exactly once (see Figure 4). The surface F is two-sided; we will arbitrarily assign it a normal orientation, and call one side of the surface F_+ and the other side F_- . (Formally, we should think of this as being the two sides of $\partial N(F)$ in $X(L_n)$, but we won't really make such a distinction.)

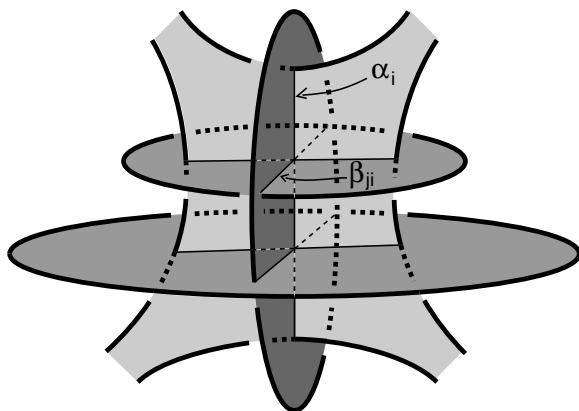

Figure 4

An important point to notice is that not only is $S^3 \setminus F$ a handlebody (of genus 2), since F is a free Seifert surface, but $S^3 \setminus (F \cup D_i \cup \dots \cup D_n)$ is a handlebody (of genus 2), as well. This is because $A_i = D_i \setminus \text{int}N(F \cup D_1 \cup \dots \cup D_{i-1})$ is an annulus. Therefore, $X_i = S^3 \setminus \text{int}N(F \cup D_1 \cup \dots \cup D_i)$ is homeomorphic to $X_{i-1} = S^3 \setminus \text{int}N(F \cup D_1 \cup \dots \cup D_{i-1})$; $X_{i-1} \setminus X_i$ is a solid torus neighborhood of A_i , so X_{i-1} is obtained from X_i by gluing this solid torus to ∂X_i , along an annulus. Pushing ∂X_i to ∂X_{i-1} through this solid torus gives an isotopy in X_{i-1} from X_i to X_{i-1} .

This fact will allow us to take an inductive approach to our proof of property (3). We will start with an alleged essential torus T , and argue that we can find a (possibly different) torus disjoint first from F , and then, inductively, from each of the disks D_i . After we are done we will have an essential torus disjoint from all of them, which therefore sits in a handlebody. But since a handlebody is atoroidal, this will give us our contradiction.

In the rest of this section we collect together several lemmas which will tell us that certain kinds of intersections of a torus with F and with the disks D_i are not possible.

Lemma 1. *For every i , there is no essential embedded annulus A in $S^3 \setminus \text{int}N(F \cup K_i)$ with one ∂ -component on F_\pm and the other ∂ -component on $\partial N(K_i)$.*

Proof. This is easiest to see using a slightly different picture of F (see Figure 5). $\pi_1(F_+)$, $\pi_1(F_-)$, and $\pi_1(S^3 \setminus \text{int}N(F)) = \pi_1(H)$ are all free groups of rank two;

using one of the bases depicted in Figure 5b (depending upon which of F_+ , F_- we work with), we can see that, as subgroups of $\pi_1(H) = F(a, b)$, $\pi_1(F_+)$ is generated by a^u and ab^v , and $\pi_1(F_-)$ is generated by b^v and ba^u . On the other hand, K_i can be represented by either ab or ab^{-1} , depending on the parity of i .

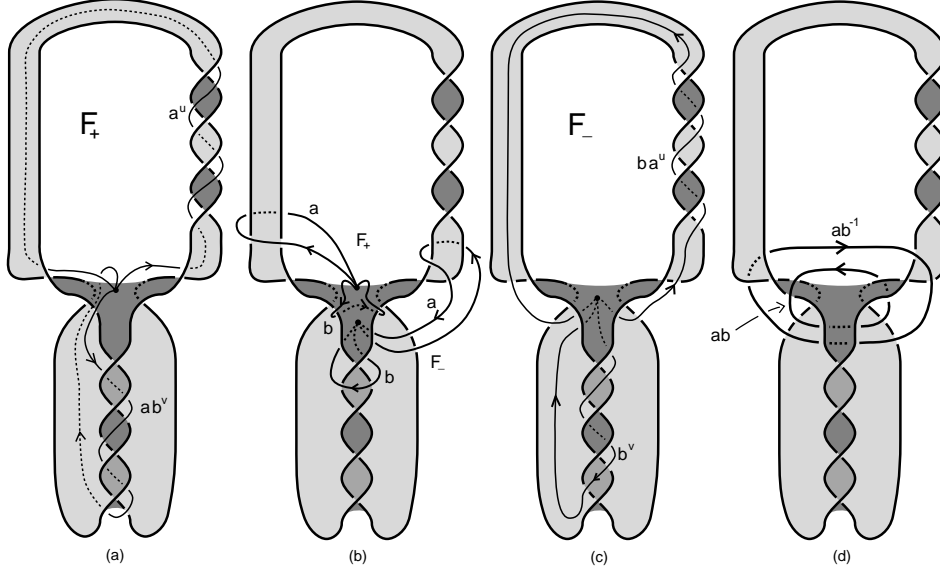

Figure 5

From the point of view of homotopy theory, an annulus described by the theorem gives a free homotopy from a loop representing a power of $ab^{\pm 1}$ to a loop representing an element of $\pi_1(F_{\pm})$, and so from the point of view of fundamental groups, $(ab^{\pm 1})^n$, for some n , is conjugate in $F(a, b)$ to a word in the subgroup generated by $\{a^u, ab^v\}$ or $\{a^ub^{-1}, b^v\}$.

Conjugation preserves exponent sums in a free group, and so in the first case the exponent sum for b will be $\pm n = kv$, so v divides n , while in the second case the exponent sum for a will be $n = k'u$, so u divides n . Since by our earlier hypothesis both u and v are greater than 2, we have $|n| \geq 2$, or $n=0$. (This is essentially the only place in our proofs where these hypotheses on u and v will be used.)

But $n=0$ implies that A meets $\partial N(K_i)$ in a meridian loop (since the boundary is embedded), and so, capping A off with a meridian disk produces a disk D with boundary on F_{\pm} , meeting K_i in a single point. Since F_{\pm} is incompressible, ∂D bounds a disk in F which, together with D forms a 2-sphere in S^3 meeting K_i in a single point, a contradiction (since a 2-sphere separates S^3). Therefore, $|n| \geq 2$.

A word in the free group $F(a, b)$ is said to be in *normal form* [MCS] if the letters a and a^{-1} , and the letters b and b^{-1} , do not occur side by side. Every element of the free group $F(a, b)$ has a unique normal form, which can be obtained by starting with a word representing the element and continually cancelling such adjacent pairs.

But the word $x(ab^{\pm 1})^n x^{-1}$, when put into normal form, must, since $|n| \geq 2$, contain one of the strings

$$abab, baba, ab^{-1}ab^{-1}, b^{-1}ab^{-1}a, \\ b^{-1}a^{-1}b^{-1}a^{-1}, a^{-1}b^{-1}a^{-1}b^{-1}, ba^{-1}ba^{-1}, \text{ or } a^{-1}ba^{-1}b$$

For example, for $x(ab)^n x^{-1}$ with $n \geq 2$, one of the first two strings must appear.

This can be proved by induction on the length of the normal word representing x . If we assume x is written in normal form, the only way the initial string $abab$ of the center word, or the final $abab$, can be altered as we shorten our word to normal form is if x ends in a^{-1} , or x^{-1} begins with b^{-1} . But then either x^{-1} begins with a or x ends with b , and so we can write

$$\begin{aligned} x(ab)^n x^{-1} &= y a^{-1} (ab)^n a y^{-1} = y (ba)^n y^{-1} \text{ or} \\ x(ab)^n x^{-1} &= (z^{-1} b) (ab)^n (b^{-1} z) = z^{-1} (ba)^n z \end{aligned}$$

Then by induction (since the word length of the conjugating element has decreased), we are done; the base case $x=1$ is obvious. The fact that in the inductive step ab became ba is not a problem, since our conclusion is symmetric in a and b ; we simply imagine making our initial statement symmetric in a and b as well. The other pairs of possibilities listed above occur for the other combinations of exponent of b and sign of n . Consequently, the normal form for our word $x(ab^{\pm 1})^n x^{-1}$ contains both an $a^{\pm 1}$ surrounded on both sides by b 's, and a $b^{\pm 1}$ surrounded on both sides by a 's.

This word is, by our argument above, contained in one of the (free) subgroups generated by $\{a^u, ab^v\}$ or $\{ba^u, b^v\}$. But this is impossible, because u and v are both at least 2. In the first case, every occurrence of the letter b will come in the form $(b^v)^k$, since a^u contains no b 's, and so it is impossible to have a single b surrounded by a 's in the normal form for the word. In the second case, every occurrence of the letter a will come in the form $(a^u)^k$, since b^v contains no a 's, and so it is impossible to have a single a surrounded by b 's in the normal form for the word. Consequently, there can be no annulus running from $\partial N(K_i)$ to F_{\pm} . \square

Lemma 2. *For every $i \neq j$, there is no essential annulus properly embedded in $X(L_n)$ with one ∂ -component on $\partial N(K_i)$ and the other ∂ -component on $\partial N(K_j)$*

Proof. Suppose we have such an annulus A ; consider $A \cap F \subseteq A$. Since $F \cap \partial A = \emptyset$ and $A \cap \partial F = \emptyset$, this intersection consists of loops. Since F is incompressible, any loops which are trivial in A can be removed by disk swapping. Any remaining loops must all be parallel to ∂A ; if there are any, then an outermost such loop cuts off an annulus from A with one ∂ -component on $\partial N(K_i)$ or $\partial N(K_j)$ and the other ∂ -component on F_{\pm} , contradicting Lemma 1. So $A \cap F = \emptyset$. There are now two cases to consider:

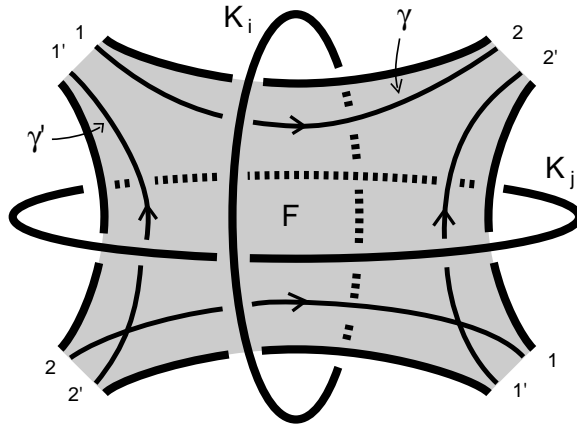

Figure 6

Case 1: $i - j$ is odd.

In this case, F , K_i , and K_j are as in Figure 6. There is a loop γ in F which has homological linking numbers (in S^3) 2 with K_i and 0 with K_j . $\partial A \cap \partial N(K_i)$ is a curve of some slope a_i/b_i on $\partial N(K_i)$, and $\partial A \cap \partial N(K_j)$ is a curve of slope a_j/b_j on $\partial N(K_j)$. But since $A \cap F = \emptyset$, we have $A \cap \gamma = \emptyset$, and so A represents a homology in the complement of γ between its two boundary curves. But these boundary curves represent the homology classes $b_i[K_i] = 2b_i$ and $b_j[K_j] = 0b_j = 0$, and so $b_i = 0$. Similarly, a curve γ' can be found with the appropriate linking numbers, showing that $b_j = 0$. This implies that both ∂ -components of A are meridian loops; capping off with meridian disks gives us a 2-sphere in S^3 meeting each of the loops K_i, K_j exactly once, a contradiction. Therefore, the annulus A cannot exist.

Case 2: $i - j$ is even.

We may assume $j < i$, and so, setting $k = i - 1$, $j < k < i$. We then have a situation like in Figure 7. Consider $A \cap D_j \subseteq D_j$. There is an arc of $F \cap D_j = \alpha_j$ between the two points of $K \cap D_j$, and since A misses F , it misses α_j . $A \cap D_j$ therefore consists of trivial arcs, trivial loops, and loops surrounding the arc α_j . Innermost trivial loops can be removed by disk swapping with the corresponding disk in A , and outermost trivial arcs can be removed since A is ∂ -incompressible. Note that this implies that $A \cap \partial N(K_j)$ misses ∂D_j , and so represents a longitude of $\partial N(K_j)$.

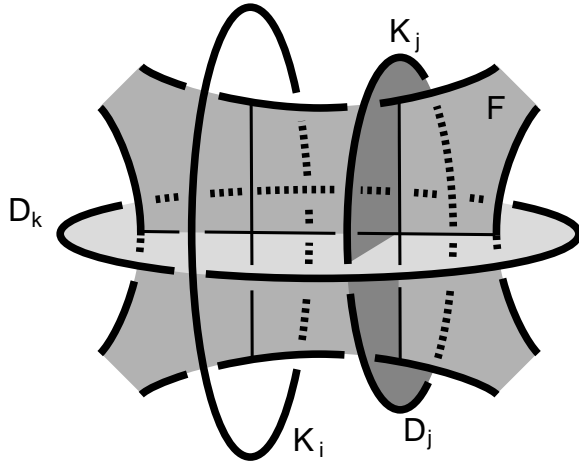

Figure 7

This leaves loops travelling around α_j ; they must all be parallel to $\partial D_j = K_j$, and therefore all parallel to one another. These loops must be non-trivial on A , since otherwise we can use the disk bounded by an innermost trivial loop on A , together with the annulus in D_j that the loop cuts off to build a disk D' disjoint from F with $\partial D' = K_j$. But this contradicts the fact that K_j has homological intersection number 2 with one of the two loops γ, γ' from Figure 6. Then we can use the loop in A closest to the ∂ -component on $\partial N(K_i)$, cutting off an annulus from A , together with the annulus in D_j that it cuts off, to build a new annulus A' between $\partial N(K_i)$ and $\partial N(K_j)$. Since both boundary components are essential, and lie on distinct ∂ -tori, A' is essential. We can then push this annulus off of D_j to make it disjoint. Setting $A = A'$, we can therefore assume that $A \cap D_j = \emptyset$.

Technically, this new annulus might hit some of the loops K_r for $r < j$; what we will actually show, therefore, is that there can be no essential annulus in $X(K \cup K_j \cup K_k \cup K_i) = X$. This will suffice, since our original annulus A would be essential in this manifold, as well; any compressing disk for A in X could be pushed off of F by disk swapping, since $A \cap F = \emptyset$, giving us a disk D' as in the previous paragraph, a contradiction. Since A has its ∂ -components on distinct ∂ -tori, there can be no ∂ -compressing disks, either.

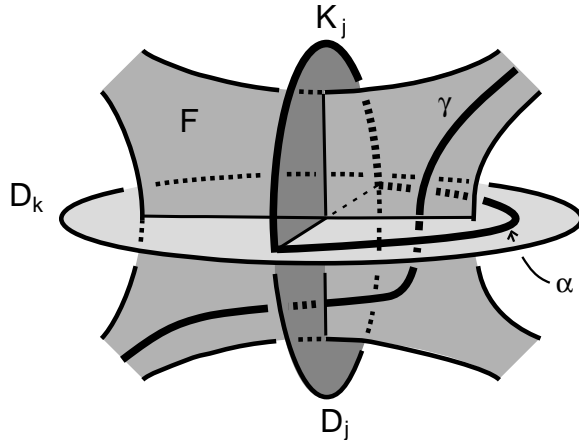

Figure 8

Now consider $A \cap D_k$ (Figure 8). A is disjoint from $\partial D_k = K_k$, and since K_j meets D_k in a pair of points, and $A \cap \partial N(K_j)$ is a longitude, $A \cap D_k$ consists of circles plus a single arc α joining the two points of $K_j \cap D_k$. Thinking of this arc as being in the annulus $D_k \setminus \text{int}N(F \cup D_j)$, it is ∂ -parallel, and so simply goes to the right or left around the tree $D_j \cap (F \cup D_j)$, say right.

But in A , α is ∂ -parallel, since it joins a component of ∂A to itself, and so cuts off a disk Δ from A , which is therefore disjoint from F (since A is). $\Delta \cap \partial N(K_j)$ is an arc of a longitude, running above or below the disk D_k , say above. But from the figure, $\partial \Delta$ has linking number 1 with a loop γ in F ; this loop would therefore have to meet the disk Δ , a contradiction. \square

§3

THE LINKS L_n ARE HYPERBOLIC: PROOFS

We now verify the four properties needed to show that the links L_n are hyperbolic. We work under the assumptions that $n \geq 3$, and the base knot K has $u, v \geq 2$.

Proposition 1. *$X(L_n)$ is irreducible: every embedded 2-sphere bounds a 3-ball.*

Proof. Suppose S is a reducing sphere for $X(L_n)$. $S \subseteq X(L_n) \subseteq S^3$, and in S^3 , S bounds a 3-ball B_1, B_2 on each side. So we must have $L_n \cap B_i \neq \emptyset$ for each i , otherwise $B_i \subseteq X(L_n)$. One of these 3-balls contains K , say B_1 .

$F \subseteq X(L_n)$ is incompressible, since a compressing disk for F in $X(L_n)$ would be a compressing disk in $X(K)$. By a standard argument, we can then make S disjoint from F : for any innermost loop of $S \cap F$ in F , we can surger S along the corresponding disk in F , creating a pair of 2-spheres, at least one of which

must still be a reducing sphere for $X(L_n)$, with fewer circles of intersection with F . Therefore, $F \subseteq B_1$, since $\partial F = K \subseteq B_1$. But each component K_i of L_n has non-zero linking number with some loop γ on F (Figure 8); in particular, $K_i \cup \gamma$ is a nonsplit link. But $K_i \cup \gamma$ is disjoint from S , and so is completely contained in either B_1 or B_2 . Since $\gamma \subseteq F \subseteq B_1$, we have $K_i \subseteq B_1$ for each i . Therefore, $L_n \subseteq B_1$, and so $L_n \cap B_2 = \emptyset$, a contradiction. So no reducing spheres exist. \square

Proposition 2. $X(L_n)$ is ∂ -irreducible: $\partial X(L_n)$ is incompressible in $X(L_n)$.

Proof. Suppose D is a compressing disk for $\partial X(L_n)$. Since $\partial X(K)$ is incompressible in $X(K)$ - K is a non-trivial knot - ∂D must lie on $\partial N(K_i)$ for some i . It therefore represents a curve of slope a_i/b_i on $\partial N(K_i)$. Since F is incompressible and disjoint from $N(K_i)$, D and F meet in loops trivial on both, and so we can make D and F disjoint by disk swapping. But then D is disjoint from the loop γ of the previous proof, and so ∂D is null-homologous in the complement of γ . Since ∂D represents $b_i[K_i] = b_i$ in $H_1(X(\gamma))$, we have $b_i = 0$, so ∂D is a meridian loop on $\partial N(K_i)$. Capping off with a meridian disk, we get a 2-sphere in S^3 meeting K_i in a single point, a contradiction. So D does not exist. \square

Proposition 3. $X(L_n)$ is atoroidal: every incompressible torus in $X(L_n)$ is ∂ -parallel.

Proof. Suppose T is an incompressible torus in $X(L_n)$, and suppose, by way of contradiction, that it is not ∂ -parallel. Since F is incompressible in $X(K)$ and disjoint from L_n , it is also incompressible in $X(L_n)$, and by a standard disk swapping argument we can make $T \cap F$ consist of loops that are essential on both T and F .

Consider $T \cap F \subseteq F$. The loops fall into two types: those that are parallel to ∂F , and those that are not (which are all parallel to one another, however, since F is a once-punctured torus). We begin by showing that we can use T to find a different, essential, torus disjoint from F .

Of the ∂ -parallel loops, the outermost (i.e., ∂F -most) loop cobounds an annulus A with ∂F , and we can use this annulus to isotope T (in S^3 ; in fact, in $X(L_n \setminus K)$) across $\partial F = K$ to a torus $T' \subseteq X(L_n)$ (see Figure 9).

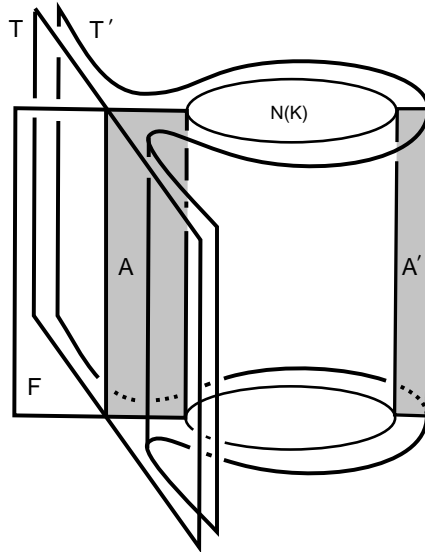

Figure 9

Lemma 3. T' is incompressible and not ∂ -parallel in $X(L_n)$.

Proof. If this is not the case, then one of two things is true:

(1) T' is ∂ -parallel.

In this case, if T' is parallel to $\partial N(K)$, then the ‘dual’ annulus joining T' to $\partial N(K)$ (Figure 9) would cut the product region between T' and $\partial N(K)$ into a solid torus. By pushing T' back across K using A' , we can then see that our original T bounds a solid torus, a contradiction. But if T' is parallel to $\partial N(K_i)$, then A' lies outside of the product region, and the annulus A' together with an annulus in $\partial N(K)$ and an annulus in the product region between T' and $\partial N(K_i)$ can be stitched together to form an annulus between $\partial N(K)$ and F , contradicting Lemma 1. So this case cannot occur.

(2) T' is compressible in $X(L_n)$, via a compressing disk D .

Compressing T' along D produces a 2-sphere $S \subseteq X(L_n)$. Since $X(L_n)$ is irreducible by Proposition 1, S bounds a 3-ball in $X(L_n)$. This 3-ball either contains T' , or its interior is disjoint from T' . Therefore, T' either lies in a 3-ball B_0 containing D , or bounds a solid torus M_0 containing D (Figure 10). Also, since $T' \subseteq X(L_n) \subseteq S^3$, T' separates $X(L_n)$.

The dual annulus A' is incompressible in $X(L_n)|T'$, since $\partial A' \cap \partial N(K)$ is an essential loop in $\partial N(K)$, hence in $X(L_n)$. If D and A' lie on the same side of T' , then $D \cap A' \subseteq A'$ consists of loops and arcs. Since A' is incompressible, all of the loops are trivial, and since D is disjoint from $\partial N(K)$, no arc joins the two ∂ -components of A' , and so all are ∂ -parallel. By disk-swapping, we can remove the loops of intersection, and by using the disk cut off by an outermost arc, we can ∂ -compress D to two disks, at least one of which must still be a compressing disk. After replacing D by one of these disks and continuing, we can eventually find a compressing disk disjoint from A' , which we will still call D .

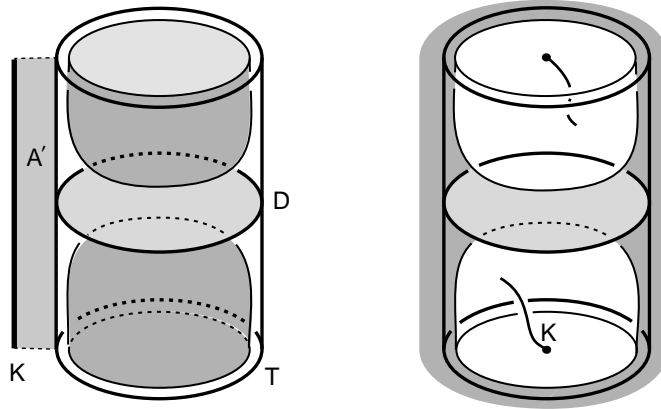

Figure 10

If T' bounds M_0 , then since M_0 must be disjoint from K it is also disjoint from the interior of A' (Figure 10), i.e., A' lies outside of M_0 . The loop $\partial A' \cap T'$ must represent a generator of $\pi_1(M_0)$; otherwise the loop is meridional and so A' together with a meridian disk of M_0 form a compressing disk for $\partial N(K)$ in $X(L_n)$, a contradiction, or the loop represents a non-trivial multiple of the generator, and

so A' represents an isotopy of K to a non-trivial cable of the core of the solid torus M_0 , contradicting the fact [HT] that, for $|u|, |v| \geq 2$, the 2-bridge knots with continued fraction $[2u, 2v]$ are hyperbolic. Therefore, when we push T' back to T along A' , we see that T is parallel to $\partial N(K)$, a contradiction.

If T' is contained in a 3-ball B_0 , then since K is disjoint from B_0 , D and A' lie on the same side of T' , and so we may assume, by the above argument, that they are disjoint. But then when we push T' back across $\partial N(K)$ via A' , the compressing disk D persists, so T is compressible, a contradiction. So this case also cannot occur. \square

Therefore, pushing T across A to T' will always result in another incompressible, non- ∂ -parallel torus in $X(L_n)$. Continuing for all of the ∂ -parallel loops of $T \cap F$, we arrive at a new essential torus, which we will still call T , having no loops of intersection with F parallel to ∂F , i.e., all loops of intersection are non-separating on F . These loops cut T into annuli, and F into annuli and a once-punctured annulus. Since T is separating, none of the annuli in F run from one side of T to the other. One of the boundary components of the once-punctured annulus is the longitude of $\partial N(K)$. Note that F and T cannot meet in a single loop γ ; since such a loop is non-separating on F , a loop in F meeting γ in a single point is a loop meeting T in a single point, implying that T is not separating. In fact, this implies that F and T meet in an even number of loops, since otherwise the same loop will meet T in an odd number of points, implying they have non-zero homological intersection number, so T is non-trivial in $H_2(S^3)$, a contradiction. $F|T$ therefore consists of an odd number of annuli and a once-punctured annulus.

Because $X(K)$ is hyperbolic, T , thought of as sitting in $X(K)$, must be either compressible or ∂ -parallel. It cannot be ∂ -parallel, however, since then the once-punctured annulus component P of $F|T$ would have to live in the product region $T \times I$ between T and $\partial N(K)$. P must therefore be compressible in $T \times I$ (since its fundamental group, being non-abelian, cannot inject), implying that F is compressible in $X(K)$, a contradiction.

We also know that since $T \subseteq X(L_n) \subseteq X(K) \subseteq S^3$, T bounds a solid torus M_0 in S^3 . In fact, T must either bound a solid torus in $X(K)$, or K must lie in a 3-ball in a solid torus with boundary T . For if not, then T cannot bound a solid torus on both sides (K would be disjoint from one of them). T is therefore the boundary of a neighborhood of a non-trivial knot, and so is incompressible on the side away from M_0 . Therefore K lies in M_0 and T is incompressible on the side away from K . But K is not isotopic in M_0 to the core C of M_0 , since T is not ∂ -parallel in $X(K)$, and C is a non-trivial knot (since T is the incompressible boundary of $X(C)$). So either T is incompressible in $X(K) \cap M_0 = M_0 \setminus \text{int}N(K)$, so K is a satellite knot (and therefore not hyperbolic, a contradiction), or T is compressible in $X(K) \cap M_0$, and so K misses a meridian disk for M_0 (the only compressing disk we could have). So either $M_0 \subseteq X(K)$, or $K \subseteq M_0$ and misses a meridian disk for M_0 .

If $M_0 \subseteq X(K)$ and $T \cap F \neq \emptyset$, then there must be at least one annulus of $F|T$ in M_0 , so there exists an outermost such annulus A . If we split T open along A and glue two parallel copies of A onto the resulting annuli, we obtain two new tori T_1 and T_2 in $X(L_n)$, each bounding a solid sub-torus in $X(K)$ (see Figure 11), and joined to F by ‘dual’ annuli A_1 and A_2 . Neither of these tori can be ∂ -parallel in $X(L_n)$, otherwise the argument of Lemma 3 will find an annulus contradicting Lemma 1. If T_1 is compressible, by a compressing disk D_1 , then since T_1 is disjoint

from F we can by the usual disk-swapping process make D_1 disjoint from F as well. If D_1 and A_1 lie on the same side of T_1 , then $D_1 \cap A_1 \subseteq A_1$ does not contain an essential loop, since otherwise the sub-annulus cut off in A_1 parallel to F together with the the subdisk cut off in D_1 would give a (singular) compressing disk for F , a contradiction. Therefore by the same process used in the proof of Lemma 3, we can make D_1 disjoint from A_1 as well.

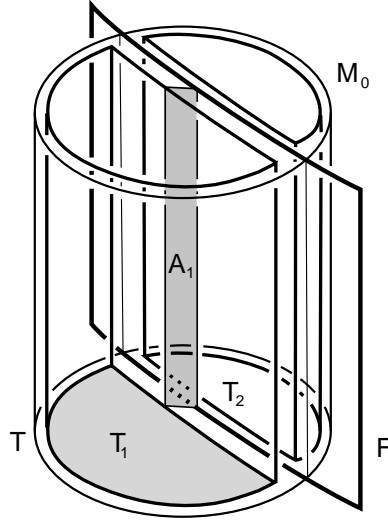

Figure 11

But then, as in Lemma 3, either T_1 bounds a solid torus M_1 in $X(L_n)$, and A_1 lies on the opposite side of T_1 (since F does), or T_1 lies in a 3-ball B_1 , and D_1 and A_1 lie on the same side of T_1 . But in the first case, this solid torus must then be identical to the one we see inside of M_0 in Figure 11, and so we can use this solid torus to isotope the annulus of $T|F$ in T_1 across F , reducing the number of components of $T \cap F$. In the second case, since D_1 and A_1 are disjoint, D_1 , A_1 , and an annulus in T_1 between their ∂ -components together form a compressing disk for F , a contradiction. In this case, therefore, we can always reduce the number of components of $T \cap F$.

If $K \subseteq M_0$ and misses a meridian disk D for M_0 , and $T \cap F \neq \emptyset$, then by the incompressibility of F and the irreducibility of $X(K)$ we can isotope D rel ∂D to remove any circles of intersection with F . $D \cap F$ must still then be non-empty, since otherwise D together with an annulus in T between ∂D and a component of $T \cap F$ gives a compressing disk (in $X(K)$) for F . In particular, the loops of $T \cap F$ are not meridians for M_0 ; otherwise, by isotopy we could make ∂D (and therefore D) disjoint from F . By an isotopy of F in $X(L_n)$, we can assume that these loops meet ∂D minimally.

If $T \cap F$ has only two components, then $F \cap M_0$ consists of a once-punctured annulus P , with two ∂ -components on ∂M_0 , and the other ∂ -component equal to K . Loops of $P \cap D \subseteq D$ can be removed by disk swapping, since $P \subseteq F$ is incompressible in $X(K) \cap M_0$; $P \cap \partial M_0$ consists of loops essential in F . Then $P \cap D$ consists of arcs; an outermost such arc α must join distinct ∂ -components of P together, since $T|P$ consists of a pair of annuli, each of whose ∂ -components come from distinct components of ∂P . But then the outermost disk this arc cuts off,

together with the annulus in T , can be used to build a disk D' with $\partial D' \subseteq F$ (Figure 12). Since F is incompressible, $\partial D'$ bounds a disk in F . But since α joins distinct components of ∂P , α cuts P into an annulus, one of whose ∂ -components is $\partial D'$, implying that F is a disk, a contradiction. So $T \cap F$ must have more than two components.

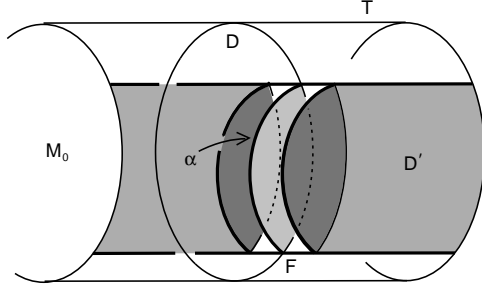

Figure 12

If $T \cap F$ consists of more than two components, then there is at least one annulus component of $F \cap M_0$. An outermost such annulus cuts a solid torus M_1 off from M_0 . If M_1 does not contain K , then we can apply the argument given above for the case that $M_0 \subseteq X(K)$ to show that we can reduce the number of components of $T \cap F$ by an isotopy of T . If M_1 does contain K , then it also contains P , and so we have a situation identical to the one in the previous two paragraphs; the meridian disk for M_1 is a sub-disk of D , and so misses K . This will lead us to the same contradiction.

Therefore, we can either replace T with an essential torus T_1 disjoint from F , or reduce the number of components of $T \cap F$ by an isotopy of T in $X(L_n)$. Eventually, therefore, we can find an essential torus T with $T \cap F = \emptyset$.

Once we have found an essential torus T with $T \cap F = \emptyset$, we turn our attention to $T \cap D_1$, where D_1 is the disk of Section 1 bounding $K_1 \subseteq L_n$. Since T is disjoint from F and K_1 , after removing trivial circles of intersection in D_1 , which are therefore trivial on T , as well, $T \cap D_1$ consists of loops which miss the arc $F \cap D_1$, so all of the loops are parallel, in D_1 , to $\partial D_1 = K_1$. The outermost such loop cuts off an annulus A_1 from D_1 (Figure 13), which we use as in Lemma 3 to push T across K_1 to a new torus T' in $X(L_n)$.

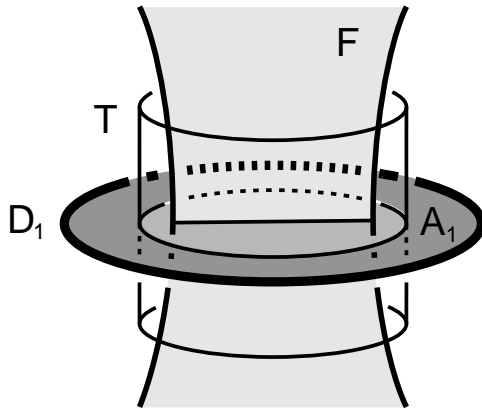

Figure 13

Lemma 4. *T' is incompressible and not ∂ -parallel in $X(L_n)$.*

Proof. Most of our arguments follow the same line as the proof of Lemma 3. If T' is parallel to $\partial N(K_i)$, then if $i \neq 1$, we can use the dual annulus A'_1 from T' to ∂K_1 together with an annulus in the product region to build an annulus in $X(L_n)$ between $\partial N(K_1)$ and $\partial N(K_i)$, contradicting Lemma 2. If T' is parallel to $\partial N(K)$, then A'_1 together with an annulus in the product region and an annulus in $\partial N(K)$ gives an annulus in $X(L_n)$ between $\partial X(K_1)$ and F , contradicting Lemma 1. And if T' is parallel to $\partial N(K_1)$, then the dual annulus A'_1 splits the product region into a solid torus; pushing T' back to T along A'_1 essentially preserves this solid torus, implying that T bounds a solid torus in $X(L_n)$, a contradiction. So T' is not ∂ -parallel.

If T' is compressible, then either T' bounds a solid torus M_1 , or T' is contained in a 3-ball B_1 in $X(L_n)$. If T' bounds M_1 , then as before M_1 is disjoint from the interior of A'_1 . Note also that M_1 is disjoint from F , since $T \cap F = \emptyset$ and M_1 does not meet $\partial F = K$. As before, $\partial A'_1 \cap M_0 = \gamma_1$ must represent a generator of $\pi_1(M_1)$. Otherwise, either γ is a meridian M_1 , and a meridian disk together with A'_1 gives a disk with boundary K_1 disjoint from F , implying that K_1 has linking number zero with every loop in F , a contradiction, or γ_1 represents a non-trivial multiple of the core C of M_1 , so γ_1 , and therefore K_1 , is homologous to a multiple r of C in the complement of F , implying that K_1 has linking number a multiple of r with every loop in F , contradicting the fact that it has linking number one with some loops (e.g., the γ of Figure 8 above). But now when we push T' back to T using A'_1 , K_1 is pushed to the core of the solid torus M_1 , implying that T is ∂ -parallel, a contradiction.

Finally, if T' and its compressing disk D lie in a 3-ball B_1 (the only remaining possibility), then D and A'_1 lie on the same side of T' , and so, as in Lemma 3, we can make D disjoint from A'_1 . Then when we push T' back to T across A'_1 , the compressing disk persists, so T is compressible, a contradiction. So T' must be incompressible and not ∂ -parallel. \square

We can apply this argument to each loop of $T \cap D_1$ in turn, pushing them across K_1 to obtain a new essential torus. After carrying this out for all loops of intersection, we can then assume that $T \cap F$ and $T \cap D_1$ are both empty. We then turn our attention to $T \cap D_2$, which as before consists of loops in D_2 parallel to $\partial D_2 = K_2$. By the same process as in Lemma 4, we remove these loops of intersection as well. Continuing, we eventually find an essential torus T which is disjoint from F and all of the disks D_i , $i = 1, \dots, n$. T therefore lives in $S^3 \setminus \text{int}(F \cup D_1 \cup \dots \cup D_n)$, which as we remarked in Section 2, is a handlebody H . But every torus in a handlebody is compressible ($\pi_1(T)$ is not free, so it cannot inject into $\pi_1(H)$). This compressing disk misses F and all of the D_i , and so it lives in $X(L_n)$. Therefore T is compressible in $X(L_n)$, a contradiction. So no such (original) torus can exist; $X(L_n)$ is atoroidal. \square

Proposition 4. *For $n \geq 3$, $X(L_n)$ is anannular: every incompressible annulus is ∂ -parallel.*

Proof. The argument here is standard, we simply use the facts that $X(L_n)$ is irreducible and atoroidal, and has at least four ∂ -components (since $n \geq 3$).

If A is an incompressible annulus, then if A runs between distinct ∂ -components T_1, T_2 , then $T = \partial N(A \cup T_1 \cup T_2) \setminus (T_1 \cup T_2)$ is a torus which separates pairs of ∂ -components of $X(L_n)$, so cannot be ∂ -parallel, and must therefore be compressible. But a compressing disk will split T into a 2-sphere which also separates components of L_n , implying that $X(L_n)$ is reducible, a contradiction. So ∂A is contained in a single ∂ -component T_1 . Then $T = \partial N(A \cup T_1) \setminus T_1$ is a torus which separates T_1 from at least three other ∂ -components. So if T is ∂ -parallel, it is parallel to T_1 , so A lives in a product $T \times I$, and so is ∂ -parallel. If T is compressible, then the compressing disk splits T into a 2-sphere separating T_1 from at least three other ∂ -components, giving a reducing sphere for $X(L_n)$, a contradiction.

The only possibility which does not lead to a contradiction, therefore, is that A is ∂ -parallel. Therefore, $X(L_n)$ is anannular. \square

§4

CONCLUDING REMARKS

With this we have finished our proof that the links L_n are hyperbolic. By applying the construction of Section 1, we can therefore build infinitely many (distinct) knots with free genus one and volume larger than any fixed constant. We find it both amusing and embarrassing to note that we can, however, not exhibit a single explicit example of this phenomenon, for any fixed constant. Existence of our examples is guaranteed only by Thurston's hyperbolic Dehn surgery theorem, which provides no explicit estimate the sizes of coefficients n_i sufficient to guarantee hyperbolicity of the knots we build. And while there are estimates of the volume of a hyperbolic manifold after Dehn filling (see, e.g., [NZ]), these are asymptotic estimates, giving no explicit lower bounds in terms of the n_i .

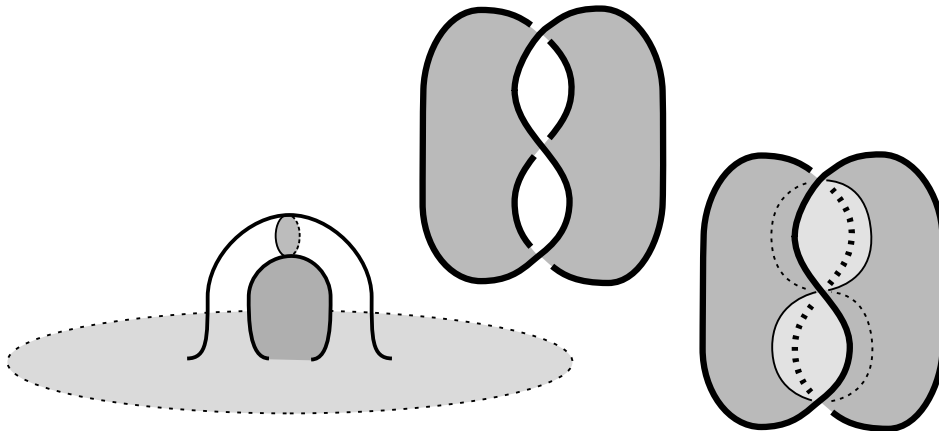

Figure 14

It is clear that similar constructions can be carried out starting with free genus one knots other than the $[2u, 2v]$ 2-bridge knots. All that is really needed to carry over our proofs is an analogue to Lemma 1. Our interest here was in finding hyperbolic knots with free genus one; we should note that Ozawa [Oz] has, on the other hand, determined all of the satellite knots with free genus one. In that paper, he conjectures that any free genus one knot whose exterior contains an essential closed surface must also have tunnel number one. His paper essentially consists of a

proof of this conjecture when the exterior contains an essential torus. This, together with a result of Goda and Teragaito [GT], gives the required characterization.

A free Seifert surface remains free after stabilization, i.e., after adding a trivial 1-handle to the surface (see Figure 14). It is easy to see that a canonical surface stabilizes to a canonical one; stabilization can be thought of as boundary connected sum with a canonical surface for the unknot (Figure 14), and the connected sum of a diagram for K and a diagram for the unknot is a diagram for K . It would be interesting to determine whether or not any two free Seifert surfaces are stably equivalent, i.e., they become isotopic after a sufficient number of stabilizations. (Since the effect, on the complement, of a stabilization is to boundary-connect sum with two solid tori, you need to start with handlebody complement in order to get handlebody complement.) This is probably not unreasonable, since this operation is very similar to the stabilization of Heegaard decompositions (see, e.g., [AM]), where stable equivalence is known.

This stabilization process raises several further interesting possibilities. Can every free Seifert surface be stabilized to a canonical one? In particular, might it be the case that any free Seifert surface, if it is stabilized to have genus equal to (or greater than) the canonical genus, must then always be canonical? This would imply that if the free genus equals the canonical genus, then every free Seifert surface is canonical. The standard conjecture in the theory of Heegaard decompositions (see, e.g., [Ki, Problem 3.89]) seems to be that for any pair of Heegaard decompositions of a 3-manifold, they are equivalent after stabilizing to a genus one higher than the larger of the two. Perhaps a similar result is true for free Seifert surfaces, as well.

Acknowledgements

The author wishes to thank Jeff Weeks for many helpful conversations during the course of this work, and Tsuyoshi Kobayashi and Nara Women's University for providing the setting in which these conversations took place. The author also wishes to thank Susan Hermiller for help in deciphering normal forms in free groups.

REFERENCES

- [Ad] C. Adams, *Volumes of N -cusped hyperbolic 3-manifolds*, J. London Math. Soc. **38** (1988), 555-565.
- [AM] S. Akbulut and J. McCarthy, *Casson's invariant for oriented homology 3-spheres* *Mathematical Notes*, 36., Princeton University Press, 1990.
- [Br] M. Brittenham, *Bounding canonical genus bounds volume*, preprint.
- [GT] H. Goda and M. Teragaito, *Tunnel number one genus one non-simple knots*, to appear in Tokyo J. Math..
- [HT] A. Hatcher and W. Thurston, *Incompressible surfaces in 2-bridge knot complements*, *Inventiones Math.* **79** (1985), 225-246.
- [Ki] R. Kirby, *Problems in low-dimensional topology*, Geometric topology (Athens, GA, 1993), Studies in Advanced Mathematics, vol. 2, Amer. Math. Soc., Providence, RI, 1997, pp. 35-473.
- [KK] M. Kobayashi and T. Kobayashi, *On canonical genus and free genus of a knot*, J. Knot Thy. Ram. **5** (1996), 77-85.
- [MCS] W. Magnus, A. Karrass, and D. Solitar, *Combinatorial group theory*, John Wiley and Sons, Inc., 1966.
- [NZ] W. Neumann and D. Zagier, *Volumes of hyperbolic three-manifolds*, *Topology* **24** (1985), 307-332.
- [Oz] M. Ozawa, *Satellite knots of free genus one*, preprint.
- [Ro] D. Rolfsen, *Knots and Links*, Publish or Perish Press, 1976.
- [Se] H. Seifert, *Über das Geschlecht von Knoten*, Math Annalen **110** (1934), 571-592.

- [Th1] W. Thurston, *The Geometry and Topology of 3-manifolds*, notes from lectures at Princeton University, 1978-80.
- [Th2] ———, *Three-dimensional manifolds, Kleinian groups and hyperbolic geometry*, Bull. Amer. Math. Soc. **6** (1982), 357-381.
- [We] J. Weeks, *SnapPea, a program for creating and studying hyperbolic 3-manifolds*, available for download from www.geom.umn.edu.

DEPARTMENT OF MATHEMATICS, UNIVERSITY OF NORTH TEXAS, DENTON, TX 76203
E-mail address: britten@unt.edu