

# Finite type invariants of 3-manifolds

Tim D. Cochran<sup>\*†</sup>      Paul Melvin<sup>†</sup>

This Version: 8/1/99    First version: 11/15/97

## Contents

<b>1</b>	<b>Introduction</b>	<b>2</b>
<b>2</b>	<b>Finiteness</b>	<b>13</b>
<b>3</b>	<b>The Conway polynomial</b>	<b>20</b>
<b>4</b>	<b>Finite type invariants from quantum invariants</b>	<b>30</b>
<b>5</b>	<b>Combinatorial structure of finite type invariants</b>	<b>47</b>
<b>6</b>	<b>Finite type invariants for spin manifolds</b>	<b>58</b>
<b>7</b>	<b>Finite type invariants for bounded manifolds</b>	<b>61</b>
<b>8</b>	<b>Finite type invariants for marked manifolds</b>	<b>62</b>
<b>9</b>	<b>Further generalizations</b>	<b>65</b>
<b>10</b>	<b>Relationships with other theories and other results</b>	<b>68</b>

---

<sup>\*</sup>partially supported by the National Science Foundation DMS-9400224

<sup>†</sup>both authors gratefully acknowledge the support of Research Professorships of the Mathematical Sciences Research Institute, Berkeley, California

# 1 Introduction

The primary objective of this paper is to propose a theory of invariants of *finite type* for arbitrary compact oriented 3-manifolds. We shall also give many examples of such invariants, including some “new” 3-manifold invariants, and investigate the algebraic and combinatorial structure of the set of all finite type invariants.

At the most naive level, invariants of finite type should be thought of as the *polynomials* among all invariants. As such, they should be computable (at least in theory) in polynomial time in the complexity of the objects being studied. In recent years, a number of different theories of finite type invariants have evolved in a variety of topological settings, with their origins in fields as diverse as singularity theory and perturbative Chern-Simons theory. Perhaps the best known of these is the theory for knots in the 3-sphere, which was initiated by V. Vassiliev [Va] and M. Gusarov [Gu], and developed by many other authors (in particular see [BL] [Ba] and [Ko]). Importing some of the key notions from this theory, T. Ohtsuki [O2] developed an analogous theory for homology 3-spheres which has been further studied by S. Garoufalidis, M. Greenwood, N. Habegger, A. Kricker, T. Le, J. Levine, X.S. Lin, H. Murakami, J. Murakami, L. Rozansky, B. Spence, E. Witten, and others (see references). An extension to rational homology 3-spheres was proposed by Garoufalidis and Ohtsuki [GO1] (see §10 for a discussion of an apparent flaw in this theory). Attempts to extend beyond the set of rational homology spheres, however, have failed. Indeed several authors have proved *non-existence* theorems for such extensions [GO1] [H1]. Moreover the most celebrated extensions of specific finite type invariants for rational homology spheres, namely C. Lescop’s extension of the Casson-Walker invariant and the “universal” finite type invariant of Le-Murakami-Ohtsuki, vanish identically for manifolds  $M$  with first betti number  $b_1(M)$  greater than three [Ls] [LMO] [H2]. Our work seems to overcome these difficulties.

The theory proposed here extends Ohtsuki’s theory for integral homology spheres, and is highly non-trivial for 3-manifolds of arbitrarily large betti number. Indeed much of the complexity of Ohtsuki’s theory embeds in our theory for manifolds of high betti number. It is shown here that the

coefficients of the Conway polynomial of a manifold with first betti number one, as well as coefficients of the Witten-Reshetikhin-Turaev quantum invariants for a general 3-manifold, are of finite type. This provides evidence that the theory is a rich one.

There were several principles that guided us in formulating our theory:

1) (*polynomial nature*) An invariant of finite type should be a polynomial in some natural sense, preferably defined — as in Vassiliev’s original viewpoint for knots — as a function with vanishing derivative of some order on a stratified space  $X$ . The “chambers” of  $X$  (components of the non-singular part) should correspond to 3-manifolds, and the “walls” between chambers correspond to certain singularities, perhaps singular 3-manifolds, representing elementary transitions from one 3-manifold to another. Some interesting work from this viewpoint has been done by N. Shirokova [Sh].

2) (*finiteness*) The set of all finite type invariants should have an algebraic structure, graded by degree, which when properly interpreted is finite dimensional in each degree.

3) (*non-triviality*) There should exist many independent invariants in all degrees, including at least the more robust algebraic topological invariants coming from (co)homology theory.

4) (*combinatorics*) There should be a combinatorial model for the set of all finite type invariants, as there is for knots and links [Ko] and homology spheres [GO1] [Le].

We begin with a heuristic definition of finite type invariants in which their polynomial nature is evident. This requires the notion of a “combinatorial tangent bundle” for the set  $\mathcal{S}$  of 3-manifolds. This point of view will also make it clear how our definition differs from some previous attempts.

For motivation, first reconsider Ohtsuki’s notion of finite type invariants for homology 3-spheres from this point of view. The basic idea is that the homology spheres which are to be viewed as “closest” to  $S^3$ , say, are those which are obtained from  $S^3$  by  $\pm 1$  surgery on a knot in  $S^3$ , denoted  $S_K^3$ . To this end, construct a cubical complex  $X(S^3)$  whose vertices are (oriented homeomorphism classes of) oriented homology spheres  $\Sigma$  and whose edges represent “elemental cobordisms” between  $\Sigma$  and  $\Sigma_K$  (the result of surgery

on  $K$  in  $\Sigma$ ), i.e.  $\Sigma \times I$  with a 2-handle attached along a  $+1$  (or  $-1$ ) framed knot  $K$  in  $\Sigma$ . The edges emanating from  $\Sigma$  are the “tangent vectors” at  $\Sigma$  to the set of all homology spheres. They are parametrized by  $\pm 1$ -framed knots  $K$  in  $\Sigma$ . For  $n > 1$ , the  $n$ -dimensional cubes are parametrized by  $\pm 1$ -framed  $n$ -component links  $L$  in  $\Sigma$  which have zero linking numbers. Note that  $X$  is connected. If  $\phi$  is an invariant of homology spheres then the (combinatorial) derivative of  $\phi$  at  $\Sigma$ , in the direction of  $K$ , is  $\partial_K \phi = \phi(\Sigma_K) - \phi(\Sigma)$ . If two such framed knots  $\{K_1, K_2\}$  are disjoint and have linking number zero in  $\Sigma$ , then one defines the second derivative at  $\Sigma$ ,  $\partial_{K_2} \partial_{K_1} \phi = \phi(\Sigma_{K_1 \cup K_2}) - \phi(\Sigma_{K_1}) - \phi(\Sigma_{K_2}) + \phi(\Sigma)$ , etc.. Given this notion of the tangent space and given this combinatorial derivative, Ohtsuki’s finite type invariants of degree  $n$  (for homology 3-spheres) are precisely the  $n^{\text{th}}$  degree polynomials. For example, a degree zero invariant must have vanishing first derivative, that is  $\phi(\Sigma) = \phi(\Sigma_K)$  for each  $\Sigma$  and  $K$ , and so is constant.

Now in extending this definition to all closed 3-manifolds the crucial question is what should be the “tangent vectors” to  $\mathcal{S}$  i.e. what are the allowable “infinitesimal deformations”? In brief, previous attempts allowed 0-surgery on a knot in  $M$  as a deformation, and we do not. Clearly allowing more tangent vectors imposes more conditions and increases the chances that the theory becomes vacuous. For our theory, an admissible “infinitesimal deformation” of  $M$  is  $M_K$  where  $K$  is a  $\pm 1$  framed *null-homologous* knot in  $M$ . This corresponds to a cubical complex  $X$  which is disconnected, where a single path component has as vertices all those 3-manifolds which can be obtained (one from another) by a sequence of such “deformations”. In particular all such 3-manifolds have isomorphic homology groups. The component containing  $S^3$  is  $X(S^3)$  as above. Once having stipulated this set of deformations, we define a *polynomial invariant* of degree at most  $n$  to be one whose  $(n + 1)$ -st order mixed partial derivatives vanish. The mixed partial is defined only in restricted cases as above. We shall not make this precise. The reader can extract it from our precise definition of finite type which follows below. But, in summary, there is a natural sense in which our finite type invariants are polynomials, and there is a space  $X$  whose vertices (chambers) are 3-manifolds and whose edges (walls between

chambers) are elementary cobordisms (“singular 3-manifolds”), as in the approach of Vassiliev.

We shall now give our definition for 3-manifolds, which can be seen to be formally identical to that of Ohtsuki for homology 3-spheres, and then discuss the elements of the definition which distinguish it from other attempts. In section 9 we give several significant generalizations of our definition.

Let  $\mathcal{S}$  be a set of equivalence classes of 3-manifolds  $(M, \sigma)$  with some additional “structure”  $\sigma$ , modulo “structure-preserving” homeomorphisms. Examples of the structures which may be considered are: orientation, spin structure, a marking of  $\partial M$  (i.e. a homeomorphism from  $\partial M$  to a fixed abstract surface), an element of  $H^1(M; \mathbb{Z}_n)$ , a marking of  $H_1(M)$  (i.e. an isomorphism from  $H_1(M)$  to a fixed abstract abelian group). In fact all of these theories are discussed herein, but a unified definition is given below. The type of structure and the set  $\mathcal{S}$  may *not* be chosen entirely arbitrarily; there is a mild restriction discussed below.

Let  $\mathcal{M}$  be the free abelian group on the set  $\mathcal{S}$ . We define a decreasing filtration of subgroups  $\mathcal{M} = \mathcal{M}_0 \supset \mathcal{M}_1 \supset \mathcal{M}_2 \supset \dots$  below, and with respect to this filtration and some fixed Noetherian ring  $A$  we stipulate:

**Definition 1.1.** A function  $\phi : \mathcal{S} \rightarrow A$  is *finite type of degree  $\ell$*  if its linear extension to  $\mathcal{M}$  vanishes on  $\mathcal{M}_{\ell+1}$ , but not identically on  $\mathcal{M}_\ell$ . Let  $\mathcal{O}_\ell^A$ , or often merely  $\mathcal{O}_\ell$ , denote the  $A$ -module of all finite type invariants of degree *at most*  $\ell$ , i.e.  $\text{Hom}(\mathcal{M}/\mathcal{M}_{\ell+1}, A)$ , and let  $\mathcal{O}$  denote the union of all  $\mathcal{O}_\ell$ .

The filtration we use is defined as follows.

**Definition 1.2.** The framed link  $L = \{L_1, \dots, L_\ell\}$  in  $M$  is *admissible* if

- a) each  $L_i$  is null-homologous in  $M$
- b) the pairwise linking numbers of  $L$  (measured in  $M$ ) are zero
- c) the framings are  $\pm 1$  with respect to the longitude guaranteed by (1).

Such a link in  $S^3$  has been called *unit-framed, algebraically split* by some other authors. Clearly any sublink of an admissible link is itself admissible.

If  $L$  is a framed link in  $M$  then  $M_L$  will denote the result of Dehn surgery on  $M$  along  $L$  [Ro]. If  $L$  is an admissible link in  $M$  then  $[M, L]$  will denote the element of  $\mathcal{M}$  represented by the (formal) alternating sum of manifolds  $M_S$  over all sublinks  $S$  of  $L$  (including  $S = \phi$  and  $S = L$ ),

$$[M, L] = \sum_{S < L} (-1)^s M_S.$$

Here the number of components of a link ( $S$  or  $L$ , for example) is denoted by the corresponding lower case letter ( $s$  or  $\ell$ ). If  $L$  is empty then  $[M, L]$  is the class of  $M$  itself.

It is also sometimes convenient to use the notation  $M_{\delta L}$  for  $[M, L]$  where  $\delta$  is the operator which sends a framed link to the alternating sum of its sublinks,

$$\delta L = \sum_{S < L} (-1)^s S.$$

Note that  $\delta$  is an involution on the free abelian group  $\mathcal{L}$  generated by framed links [CM1].

**Definition 1.3.** Let  $\mathcal{M}_\ell$  be the span of the set  $\mathcal{S}_\ell$  of all  $[M, L]$ , where  $M$  is an element of  $\mathcal{S}$  and  $L$  is an admissible link of  $\ell$  components in  $M$ . As will be seen below, this defines a filtration

$$\mathcal{M} = \mathcal{M}_0 \supset \mathcal{M}_1 \supset \mathcal{M}_2 \supset \dots$$

with intersection  $\mathcal{M}_\infty = \bigcap_{\ell=0}^{\infty} \mathcal{M}_\ell$ . The quotients  $\mathcal{M}_\ell / \mathcal{M}_{\ell+1}$  will be denoted by  $\mathcal{G}_\ell$ , and so  $\mathcal{G} = \mathcal{G}_0 \oplus \mathcal{G}_1 \oplus \mathcal{G}_2 \oplus \dots$  is the associated graded group.

One can think of  $\mathcal{S}_1$  as the set of unit tangent vectors to  $\mathcal{S}$ , of  $\mathcal{M}_1$  as the tangent bundle of  $\mathcal{S}$ , and inductively, of  $\mathcal{S}_{\ell+1}$  as the set of unit tangent vectors to  $\mathcal{S}_\ell$  and  $\mathcal{M}_{\ell+1}$  its tangent bundle.

The reader should note that the definitions above are incomplete. If  $M$  is a manifold with structure  $\sigma$  and  $S$  is an admissible link in  $M$  then we must specify how the structure  $\sigma$  is “propagated” to a structure  $\sigma_S$  on  $M_S$  in order that the symbol  $[M, L]$  be defined. This functor must be invariant under structure-preserving homeomorphisms of the pair  $(M, S)$ . When the structure is an orientation or a marking of  $\partial M$  then this propagation is

obvious, but when the structure is a spin structure or a marking of  $H_1$  then more must be said (later). This problem restricts the type of structures which may be considered under this definition. It is now evident that the set  $\mathcal{S}$  must have the following closure property: if  $(M, \sigma) \in \mathcal{S}$  then, for any admissible link  $S$  in  $M$ ,  $(M_S, \sigma_S) \in \mathcal{S}$ . With these mild restrictions, Definitions 1.1–1.3 suffice to define a theory of finite type invariants for many categories of 3-manifolds. For simplicity of exposition we shall henceforth restrict attention to *compact orientable 3-manifolds* and to *structures which include an orientation*.

The following combinatorial identity holds and shows immediately that  $\mathcal{M}_{\ell+1} \subset \mathcal{M}_\ell$ .

**Lemma 1.4.** *If  $L \cup K$  is an admissible link in  $M$  and  $K$  is a knot, then  $L$  is admissible in  $M_K$  and  $[M, L \cup K] = [M, L] - [M_K, L]$ . More generally, if  $K$  is a link then  $[M_K, L] = [M, L \cup \delta K]$  (where the latter is defined linearly for arguments in  $\mathcal{L}$ ).*

*Proof.*  $[M_K, L] = M_{\delta L \cup K} = M_{\delta(L \cup \delta K)} = [M, L \cup \delta K]$ , since  $\delta^2 = \text{id}$ .  $\square$

Definition 1.1, when restricted to the subgroup of  $\mathcal{M}$  spanned by the set of oriented homology 3-spheres is precisely that of Ohtsuki. It differs from the definition of Garoufalidis–Ohtsuki on the span of the set of rational homology 3-spheres ([GO1, Definition 1.2]; see §10).

In general the key difference in our proposed extension lies in the definition of an admissible link. Note that if  $L$  is admissible in  $M$  then  $H_1(M_L) \cong H_1(M)$ . Moreover if one considers the cobordism  $W$  from  $M$  to  $M_L$ , given by attaching 2-handles to  $M \times [0, 1]$  along the components of  $L$ , then  $H_1(M) \cong H_1(W) \cong H_1(M_L)$ . We say that  $M_0$  and  $M_1$  are  *$H_1$ -bordant* if there exists an oriented cobordism between them which is a product on  $H_1$ . Thus one sees that each term  $M_S$  of  $[M, L]$  is  $H_1$ -bordant to  $M$  and consequently the partition of  $\mathcal{S}$  into  $H_1$ -bordism classes is respected by the filtration. It follows that the study of invariants of finite type, in our sense, largely reduces to the study of such on each fixed  $H_1$ -bordism class.

More precisely, for any fixed 3-manifold  $M$  let  $\mathcal{S}(M)$  denote the set of all 3-manifolds  $H_1$ -bordant to  $M$ , and  $\mathcal{M}(M)$  denote its span in  $\mathcal{M}$ . For

example  $\mathcal{M}(S^3)$  is precisely the group studied by Ohtsuki. One sees that  $\mathcal{S}(M)$  satisfies the required closure property.

Now for each non-negative integer  $\ell$ , let  $\mathcal{M}_\ell(M)$  be the subgroup of  $\mathcal{M}_\ell$  spanned by all  $[M', L]$  with  $M' \in \mathcal{S}(M)$ . Then by the above remark and Lemma 1.4, there is a decreasing filtration

$$\mathcal{M}(M) = \mathcal{M}_0(M) \supset \mathcal{M}_1(M) \supset \mathcal{M}_2(M) \supset \dots$$

and we can define a function  $\phi : \mathcal{S}(M) \rightarrow A$  to be finite type of degree  $\ell$  if its extension to  $\mathcal{M}_{\ell+1}(M)$  is zero and its extension to  $\mathcal{M}_\ell(M)$  is not identically zero. As above, set  $\mathcal{G}_\ell(M) = \mathcal{M}_\ell(M)/\mathcal{M}_{\ell+1}(M)$ , also denoted  $(\mathcal{M}_\ell/\mathcal{M}_{\ell+1})(M)$ , and  $\mathcal{O}_\ell(M) = \text{Hom}((\mathcal{M}/\mathcal{M}_{\ell+1})(M), A)$ . Then the following are trivial consequences of the definitions.

**Proposition 1.5.** *Suppose  $\mathcal{H}$  is the set of  $H_1$ -bordism classes of elements of  $\mathcal{S}$ . Choose a representative  $M_i$  for each class  $i \in \mathcal{H}$ . Then for each  $\ell \geq 0$ ,*

$$\begin{array}{ll} \text{a) } \mathcal{M} = \bigoplus_{\mathcal{H}} \mathcal{M}(M_i) & \text{b) } \mathcal{M}_\ell = \bigoplus_{\mathcal{H}} \mathcal{M}_\ell(M_i) \\ \text{c) } \mathcal{G}_\ell = \bigoplus_{\mathcal{H}} \mathcal{G}_\ell(M_i) & \text{d) } \mathcal{O}_\ell \cong \prod_{\mathcal{H}} \mathcal{O}_\ell(M_i) \end{array}$$

*Proof.* The partition of  $\mathcal{S}$  into  $H_1$ -cobordism classes clearly induces a direct sum decomposition on free abelian groups on the sets, establishing 1.5a. Since every element in the sum  $[M, L]$  is  $H_1$ -cobordant to  $M$ , 1.5b follows easily. Then 1.5c is an easy algebraic consequence of 1.5b. Finally  $\mathcal{O}_\ell = \text{Hom}(\mathcal{M}/\mathcal{M}_{\ell+1}, A) \cong \prod_{\mathcal{H}} \text{Hom}((\mathcal{M}/\mathcal{M}_{\ell+1})(M_i), A) \cong \prod_{\mathcal{H}} \mathcal{O}_\ell(M_i)$ .  $\square$

The last isomorphism in Proposition 1.5 makes it clear that invariants of finite type, in our sense, are constructed from invariants of finite type on each  $H_1$ -bordism class. In fact the degree 0 finite type invariants are precisely those which are constant on  $H_1$ -bordism classes, i.e. the “locally constant” functions on  $\mathcal{S}$ . For example it is easy to see that the function  $\phi : \mathcal{S} \rightarrow \mathbb{Z}$  given by the first betti number is finite type of degree 0, being constant on each  $\mathcal{S}(M_i)$ . Similarly the function which assigns  $|H_1(M)|$  to  $M$  if  $H_1(M)$  is finite, and 0 otherwise, is of degree zero.

Our point of view is that we have “split” the classification problem for 3-manifolds into two parts. First, the problem of determining if  $M_0$  and  $M_1$



lie in the same  $H_1$ -bordism class. Second, if they lie in the same  $H_1$ -bordism class, can they be distinguished by invariants of finite type? Some recent work of A. Gerges, K. Orr and the first author suggests that this may be a good strategy because  $H_1$ -bordism is determined by the most understood 3-manifold invariants, namely the cohomology ring and the torsion linking form.

**Theorem 1.6.** (Amir Gerges [Ge]; see [CGO] for d). *Suppose  $M_0$  and  $M_1$  are closed, connected oriented 3-manifolds. The following are equivalent.*

- a)  $M_0$  is  $H_1$ -bordant to  $M_1$ .
- b)  $M_1$  is obtained from  $M_0$  by surgery on an admissible framed link  $L$  in  $M_0$ . (In fact  $L$  may be chosen to be a boundary link [CGO, §3.17]).
- c) There exist 3-manifolds  $M_0 = X_1, X_2, \dots, X_n = M_1$  such that  $X_{i+1}$  is obtained by  $\pm 1$  surgery on a null-homologous knot in  $X_i$ .
- d) There is an isomorphism  $\phi : H_1(M_1) \rightarrow H_1(M_0)$  which induces isomorphisms between the  $\mathbb{Q}/\mathbb{Z}$  linking forms and between triple cup product forms  $\bigotimes^3 H^1(M_i; \mathbb{Z}_n) \rightarrow H^3(M_i; \mathbb{Z}_n)$  for  $n = 0$  and each  $n = p^r$  ( $p$  prime) where  $p^r$  is the exponent of the  $p$ -torsion subgroup of  $H_1(M_i)$ .
- e) There are isomorphisms  $\phi_i : H_1(M_i) \rightarrow G$  (a fixed abelian group) such that  $(\phi_0)_*([M_0]) = (\phi_1)_*([M_1])$  in  $H_3(G)$ .

For example, note that 1.6e shows that for 3-manifolds with  $H_1$  isomorphic to  $0$ ,  $\mathbb{Z}$  or  $\mathbb{Z}^2$ , there is only one  $H_1$ -bordism class. For  $H_1 \cong \mathbb{Z}^3$  the non-negative integer  $|H^3(M_0)/(H^1(M_0) \cup H^1(M_0) \cup H^1(M_0))|$  is a complete invariant. For  $H_1 \cong \mathbb{Z}_p$  ( $p$  prime) there are two equivalence classes, represented by  $L(p, 1)$  and  $L(p, q)$  for any mod  $p$  quadratic non-residue  $q$ . For details and more examples see [CGO].

Recall that the linking form can be computed directly from the linking matrix associated to a surgery description of  $M$  and that such linking forms have been completely classified [KK]. The triple cup product forms can be calculated from the triple Milnor invariants  $\bar{\mu}(123)$  of 3-component sublinks of a surgery presentation of  $M$  ([Tu]; Lemma 4.2). Hence, since  $H_1$ -bordism

is related to classical computable invariants, it makes sense to separate the classification problem along these lines. Although one *need* not speak about invariants of finite type for specific  $H_1$ -bordism classes, Proposition 1.5d makes it clear that it would be more honest to do so.

One now sees that the degree zero finite type invariants are precisely those which are invariants of the isomorphism class of the triple  $(H_1, \text{linking form, triple cup product forms})$ .

Our first major result, proved in section 2, is the finite generation of the summands in the graded group  $\mathcal{G}(M)$  for any  $M$ ; the analogous theorem for spin manifolds is proved in §6. In case  $M$  is a homology sphere this was proved by Ohtsuki [O2]. Henceforth,  $\mathcal{M}$  will denote the (usual) theory of compact oriented 3-manifolds (possibly with boundary), while other theories will carry an adornment (such as  $\mathcal{M}^{\text{Spin}}$  for spin manifolds).

**Theorem 2.1.** (finiteness theorem) *For any compact oriented 3-manifold  $M$  and any non-negative integer  $\ell$ , the group  $\mathcal{G}_\ell(M) = (\mathcal{M}_\ell/\mathcal{M}_{\ell+1})(M)$  is finitely generated. Therefore  $\mathcal{O}_\ell^A(M)$  is a finitely generated  $A$ -module.*

These finiteness results are directly related to the complexity of calculation of invariants of finite type. Given any degree  $n$ , there is a finite set  $\{x_1, \dots, x_k\} \subset \mathcal{M}(M)$ , consisting of the union of generating sets for  $\mathcal{G}_\ell$  for  $0 \leq \ell \leq n$ , such that any  $\phi \in \mathcal{O}_n(M)$  is completely determined by its values on  $\{x_i\}$ , since any  $\alpha \in (\mathcal{M}/\mathcal{M}_{n+1})(M)$  is a linear combination of  $\{x_i\}$ . The techniques of section 2 suggest a reasonable “algorithm” to calculate the coefficients.

In section 3 we show that the coefficients of the “Conway Polynomial” of a 3-manifold  $M$  with  $\mathfrak{b}_1(M) = 1$  are non-trivial invariants of finite type, implying that  $\mathcal{G}_{2\ell}(M)$  has rank at least 1. We also show that these invariants generate a polynomial subalgebra of  $\mathcal{O}(M)$ .

In section 4 we demonstrate that our theory is highly non-trivial, even for manifolds with large first betti number, by exploiting the  $\mathbb{Z}_{p^k}$ -valued invariants  $\tau_p^d$  recently introduced by the authors [CM1]. These invariants were extracted from the quantum  $\text{SO}(3)$ -invariants  $\tau_p$  (for odd primes  $p$ ). Here it is shown that they are of finite type and that they determine the quantum  $\text{SO}(3)$ -invariants. This result appears to be new, even for homology

spheres. In fact we show the stronger fact that  $\tau_p$  is *analytic*, which, loosely speaking, means that it is equal to the “Taylor series” constructed from its approximating “polynomials”  $\tau_p^d$ . In this regard  $\tau_p$  is similar to the Jones and Conway polynomials for knots.

By considering sequences of these invariants we establish *rational* non-triviality of the filtration on  $\mathcal{M}(M)$  for “most” 3-manifolds  $M$ . We also provide strong evidence that Ohtsuki’s theory for homology spheres actually embeds in the theory for manifolds  $H_1$ -bordant to  $M$ .

The strongest results are for  $H_1$ -bordism classes containing a *robust* manifold (see 4.9). The list of robust manifolds includes all rational homology spheres and the 3-torus  $T = S^1 \times S^1 \times S^1$ , and is closed under connected sum. Therefore for any abelian group  $A$  whose rank is a multiple of 3 there exists a robust 3-manifold  $M$  with  $H_1(M) \cong A$ .

**Corollary 4.15.** (part c) *If  $M$  is robust, then each  $\mathcal{G}_{3k}(M)$  has positive rank, and so  $\mathcal{G}(M)$  and  $\mathcal{O}^A(M)$  (with  $A = \mathbb{Z}$  or  $\mathbb{Q}$ ) are of infinite rank.*

The reader should note that  $\mathcal{M}/\mathcal{M}_{\ell+1} \otimes \mathbb{Q} \cong \bigoplus_{i=0}^{\ell} (\mathcal{G}_i \otimes \mathbb{Q})$  and so the non-triviality of  $\mathcal{G}_i$  for  $i \leq \ell$  is directly related to the existence of invariants of degree  $\ell$  (since  $\mathcal{O}_{\ell}$  with  $\mathbb{Q}$  coefficients is  $\text{Hom}(\mathcal{M}/\mathcal{M}_{n+1}, \mathbb{Q})$ ). For example, this result is used to prove the existence of a finite type lift of the Casson invariant to arbitrary 3-manifolds that can detect homology sphere summands in 3-manifolds (Theorem 4.19).

For  $H_1$ -bordism classes  $\mathcal{S}(M)$  which are not robust we can still show that the filtration  $\mathcal{M}_{\ell}(M)$  strictly descends as long as some  $\tau_p$  does not vanish identically on  $\mathcal{S}(M)$ . If one assumes that  $M$  is *normal*, defined by the condition that  $\tau_p(M) \neq 0$  for infinitely many  $p$ , then stronger results can be obtained. There exist normal manifolds with any prescribed homology; in fact it is conceivable that all manifolds satisfy this condition.

**Corollary 4.15.** (parts a,b) *If  $\tau_p(M) \neq 0$  for some prime  $p > 3$ , then:*

- a) *For every positive integer  $n$ , there exists  $m < \infty$  such that each  $(\mathcal{M}_{\ell}/\mathcal{M}_{\ell+m})(M)$  has an element of order at least  $n$ .*
- b) *Each  $(\mathcal{M}_{\ell}/\mathcal{M}_{\infty})(M)$  is of rank at least  $p-1$ , and thus of infinite rank if  $M$  is normal.*

Finally we state the result which explains in what sense the complexity of Ohtsuki’s theory for homology spheres embeds in the general theory for manifolds of high betti number. In particular we paraphrase the part of this result which relates to Ohtsuki’s rational valued finite type invariants of homology spheres.

**Corollary 4.16.** (parts b,c)

- b) *If  $\tau_p(M) \neq 0$  for some prime  $p$ , then the mod  $p$  reduction of any of Ohtsuki’s invariants is a linear combination of invariants of the form  $i^*(\phi)$  for  $\phi \in \mathcal{O}(M)$ , where by definition  $i^*(\phi)(x) = \phi(M\#x)$  (and  $M$  is assumed to be of “minimal  $p$ -order” in its  $H_1$ -bordism class).*
- c) *If  $M$  is normal and  $\Sigma_1$  and  $\Sigma_2$  are homology spheres that can be distinguished by Ohtsuki’s invariants, then  $M\#\Sigma_1$  and  $M\#\Sigma_2$  can be distinguished by the finite type invariants  $\tau_p^d$ .*

In section 5 we describe an epimorphism from a finitely generated group of “Feynman diagrams” to the graded group  $\mathcal{G}_\ell(M)$ . This is used to evaluate a few examples for small values of  $\ell$ . The “standard” IHX and AS relations lie in the kernel but we show that for some  $M$  the kernel of this epimorphism is not completely captured by these relations as is the case for homology spheres [GO2] [Le].

In section 6 we show that our theory for spin manifolds  $\mathcal{O}^{\text{Spin}}$  contains all of  $\mathcal{O}$  as well as the Rochlin invariant, which is shown to be a degree three  $\mathbb{Z}_{16}$ -valued finite type invariant.

In section 7 we briefly discuss several theories for 3-manifolds with non-empty boundary.

In section 8 we investigate the category of oriented 3-manifolds with marked  $H_1$ . We show that the coefficients of the “Conway polynomial” of the manifold are of finite type. We claim, but postpone to a future paper, that Reidemeister torsion for 3-manifolds with  $H_1 \cong \mathbb{Z}_{p^k}$  is analytic, in particular determined by finite type invariants.

In section 9 we sketch generalizations of our theory, in particular, to a family of theories related to the lower-central-series.

In section 10 we note connections to the theories of [GO1] for rational homology spheres. We show that the invariant of Lescop (including that of Casson-Walker) is of finite type (see also §8). We also indicate a relationship between our approach and a possible approach to a theory of finite type invariants based on Heegard splittings and the mapping class group, whose analogue for homology spheres was introduced and investigated in [GL3].

## 2 Finiteness

In this section we prove the main finiteness result in the oriented category. We also show that the group of finite type invariants forms a filtered commutative algebra.

**Theorem 2.1.** (finiteness theorem) *For any compact oriented 3-manifold  $M$  and any integer  $\ell$ , the group  $\mathcal{G}_\ell(M) = (\mathcal{M}_\ell/\mathcal{M}_{\ell+1})(M)$  is finitely generated. Therefore  $\mathcal{O}_\ell^A(M)$  is a finitely generated  $A$ -module.*

The proof is very similar to that of the corresponding result of Ohtsuki [O2], except that one must deal with admissible links in  $M$  rather than  $S^3$ . Philosophically, all of Ohtsuki’s local lemmas work except that the ones whose proofs involve “blowing up or down” can only be applied to  $\pm 1$  framed circles. Hence the “braiding lemma” and the “framing lemma” do not hold in full generality, and in particular, most of the properties of [GO1] do not hold.

*Proof of 2.1.* Fix  $M$  and a non-negative integer  $\ell$ . Following [O2] we write  $\sim$  for the equivalence relation on  $\mathcal{M}_\ell(M)$  induced by the projection to  $\mathcal{G}_\ell(M)$ . Our basic tool is Ohtsuki’s “fundamental lemma” ([O2], Lemma 2.2) which generalizes to the present setting.

**Lemma 2.2.** (fundamental lemma) *If  $L \cup K$  is an admissible link in  $M$  then  $[M, L] \sim [M_K, L]$  where  $M_K$  is surgery on  $K$  and the latter  $L$  is the image of  $L$  in  $M_K$ . (Note that  $K$  may have more than one component).*

*Proof.* Since  $L$  has  $\ell$  components,  $[M, L] \sim [M, L \cup \delta K]$ , because each of the non-empty terms in  $\delta K = \sum_{S < K} (-1)^s S$  gives rise to an element of  $\mathcal{M}_{\ell+1}$ . But  $[M, L \cup \delta K] = [M_K, L]$  by Lemma 1.4.  $\square$

Recall that by definition  $\mathcal{M}_\ell(M)$  is spanned by elements of the form  $[M', L']$ , where  $M'$  is  $H_1$ -bordant to  $M$  and  $L'$  is an admissible  $\ell$ -component link in  $M'$ . If we work modulo  $\mathcal{M}_{\ell+1}(M)$ , however, we need only consider the case  $M' = M$ . In other words  $\mathcal{G}_\ell(M)$  is generated by elements of the form  $[M, L]$ , where  $M$  is any chosen “basepoint” in the  $H_1$ -bordism class and  $L$  has  $\ell$  components (cf. [O2] Lemma 2.3).

**Lemma 2.3.** (basepoint lemma) *Suppose  $M$  and  $M'$  are  $H_1$ -bordant and  $L'$  is an admissible link of  $\ell$  components in  $M'$ . Then there exists an admissible link  $L$  in  $M$  with  $\ell$  components such that  $[M', L'] \sim [M, L]$ .*

*Proof.* By Theorem 1.6b we may assume  $M \cong M'_K$ , where  $K$  is an admissible link in  $M'$ .  $K$  may be varied by an isotopy in  $M'$  until  $L' \cup K$  is admissible in  $M'$ . It then follows from the fundamental lemma (2.2) that  $[M', L'] \sim [M'_K, L'] = [M, L]$  where  $L$  is the image of  $L'$  in  $M$ .  $\square$

The next result, generalizing Lemma 2.5 of [O2], shows how to arrange that all framings be  $+1$ .

**Lemma 2.4.** (framing lemma) *Suppose  $L$  is an  $\ell$ -component admissible link in  $M$  with framing  $-1$  on the component  $K$ . Let  $L'$  be the link  $L$  with the framing on  $K$  changed to  $+1$ . Then  $[M, L] \sim -[M, L']$ .*

*Proof.* Let  $K'$  be a  $+1$ -framed parallel of  $K$  with  $\ell k(K, K') = 0$ . Set  $J = L - K$ , so  $L' = J \cup K'$ . Observe that the pairs  $(M, J)$  and  $(M_{K \cup K'}, J)$  are homeomorphic, since doing  $+1$  and  $-1$  surgery on parallels of the core of a solid torus  $T$  yields a manifold diffeomorphic to  $T$  fixing  $\partial T$ , and so  $[M, J] = [M_{K \cup K'}, J]$ . Now by the fundamental lemma,  $[M, L] \sim [M_{K'}, L] = [M_{K'}, J] - [M_{K \cup K'}, J] = [M_{K'}, J] - [M, J] = -[M, L']$ .  $\square$

The “braiding lemma” of Ohtsuki also generalizes to the present context. The key proviso is that the unknotted component  $K$  (in the statement below) is  $\pm 1$ -framed. The analogous result of ([GO1, Fig.1]) without this proviso, is false. In the following, non-integral framings are allowed on  $J$ . For convenience we now assume that  $M$  is closed. The modifications necessary in the case of non-empty boundary are discussed in section 7.

**Lemma 2.5.** (braiding lemma) *Suppose  $J \cup L$  is a framed link in  $S^3$  such that  $L$  (with  $\ell$  components) is admissible in  $M = S^3_J$ , and such that each component of  $J$  has zero linking number with each component of  $L$ . In addition suppose that  $L$  has an unknotted component  $K$ , and that the components of  $J \cup L$  which pierce a disk  $D$  spanned by  $K$  have been divided into  $m$  groups of strands, represented by “bands” in Figure 2.6a, in such a way that each component passes algebraically zero times through each band. Number the bands, and for each increasing sequence  $1 \leq i_1 < \dots < i_k \leq m$ , let  $L_{i_1 \dots i_k}$  be the framed link obtained from  $L$  by replacing  $K$  with a curve  $K_{i_1 \dots i_k}$  in  $D$  (with the same framing as  $K$ ) which encircles the bands  $i_1, \dots, i_k$  while passing in front of the other bands. Then*

$$[M, L] \sim \sum_{i,j=1}^m [M, L_{ij}] - (m-2) \sum_{i=1}^m [M, L_i].$$

The case  $m = 3$  is illustrated in Figure 2.6.

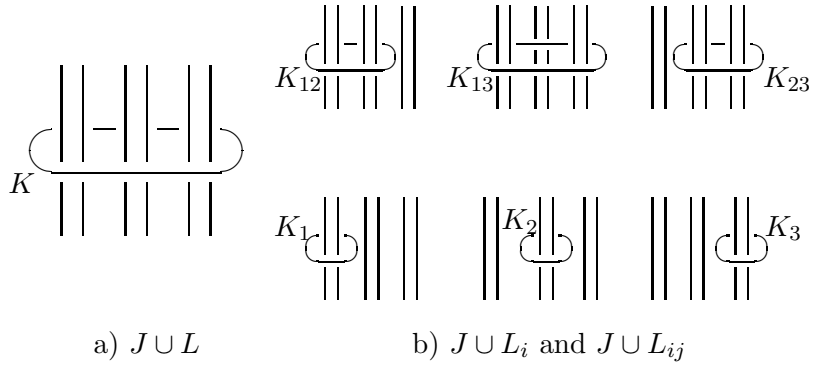

Figure 2.6

*Proof.* Following [GL1] we give an “algebraic” proof. Assume that the framing on  $K$  is  $+1$ ; the other case then follows from the framing lemma (2.4). Let  $q = [M, L]$  and  $x = [M, \hat{L}]$ , where  $\hat{L}$  is obtained by “blowing down”  $K$ , that is removing  $K$  and putting a full left twist in all the bands. Note that  $q \in \mathcal{M}_\ell$  and  $x \in \mathcal{M}_{\ell-1}$ . Furthermore, if we set  $1 = [M, L - K]$  then  $q = 1 - x$  by Lemma 1.4. In a completely analogous way, we define  $q_{i_1 \dots i_k}$

and  $x_{i_1 \dots i_k}$  with  $q_{i_1 \dots i_k} = 1 - x_{i_1 \dots i_k}$  (note that  $q = q_{1 \dots m}$  and  $x = x_{1 \dots m}$ ), and with this notation, the lemma states that  $q \sim \sum q_{ij} - (m-2) \sum q_i$ .

Now the key to the proof is the elementary observation that a full left twist in a collection of bands is a product of left twist in pairs of bands and in the individual bands. Explicitly

$$x = \prod_{i,j=1}^m x_{ij} \prod_i^m x_i^{2-m}$$

with lexicographic ordering in the first product. Here the product (left to right) corresponds to the stacking (bottom to top) of the associated tangles, and  $x_i^{-1} = 1 + q_i + q_i^2 + \dots$  is a right handed twist in the  $i$ th band. Substituting the  $q$ 's for the  $x$ 's and expanding the right hand side, we obtain  $1 - q = 1 - \sum q_{ij} + (m-2) \sum q_i +$  quadratic terms (which vanish in  $\mathcal{G}_\ell$ ), and the result follows.  $\square$

Another useful local result which generalizes to our setting is Ohtsuki's "half-twist lemma" (stated incorrectly in Figure 4.3 of [O2], but later corrected in Figure 5 of [GO2]).

**Lemma 2.7.** (half-twist lemma) *Assume the hypotheses of the braiding lemma (2.5) with  $m = 2$ , and suppose that  $L'$  is obtained from  $L$  by replacing  $K$  by a half-twisted unknot  $K'$ , as shown in Figure 2.8. Then*

$$[M, L'] \sim -[M, L] + 2[M, L_1] + 2[M, L_2].$$

(Recall that  $L_1$  and  $L_2$  are obtained from  $L$  by replacing  $K$  with unknots encircling the first and second bands, respectively.)

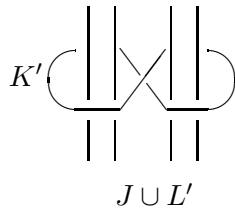

Figure 2.8



*Proof.* Adopting the notation of the preceding proof, and letting  $q' = 1 - x' = [M, L']$ , we must show  $q' \sim -q + 2q_1 + 2q_2$ . By Lemma 1.4 we compute  $q' = 1 - x^{-1}x_1^2x_2^2 = 1 - (1 + q + q^2 + \dots)(1 - q_1)^2(1 - q_2)^2 \sim -q + 2q_1 + 2q_2$ .  $\square$

Recall, following Levine, that the ordered oriented links  $L$  and  $L'$  in  $S^3$  are said to be *surgery equivalent* if  $L \cong L_0 \sim L_1 \sim \dots \sim L_k \cong L'$  where  $L_i \sim L_{i+1}$  means that there is a 2-disk  $D_i$  in  $S^3$  such that  $\partial D_i$  is disjoint from and has zero linking number with each component of  $L_i$  and such that  $\pm 1$  surgery on  $\partial D_i$  transforms  $L_i$  to  $L_{i+1}$  [L1].

**Lemma 2.9.** (surgery lemma) *Assume the hypotheses of the braiding lemma (2.5). If  $J \cup L$  is surgery equivalent to  $J \cup L'$  then  $[M, L] \sim [M, L']$ , where  $M = S_J^3$  and the framings on  $L'$  are taken equal to the corresponding framings on  $L$ .*

*Proof.* It suffices to assume the weaker condition that there is a  $\pm 1$ -framed knot  $K$  in  $S^3 - (J \cup L)$  having zero linking number with the components of  $J \cup L$  such that the pair  $(S_K^3, J \cup L)$  is homeomorphic to  $(S^3, J \cup L')$ . Hence  $(S_{J \cup K}^3, L) = (M_K, L)$  is homeomorphic to  $(S_J^3, L') = (M, L')$ , and so by the fundamental lemma  $[M, L] \sim [M_K, L] = [M, L']$ .  $\square$

We now continue with the proof of Theorem 2.1, using Levine's surgery equivalence classification for *arbitrary* links in  $S^3$  [L1]. Consider, as above,  $M = S_J^3$ . (What follows is all fairly easy if  $J$  has zero linking numbers — and in this case was done by Ohtsuki without Levine's theorem — but this is not always possible to assume.<sup>†</sup>)

Fix an orientation and an ordering for the components of  $J$ , and choose a family of *base paths*, i.e. disjoint paths from a chosen basepoint in  $S^3 - J$  to each of the components of  $J$ . (In general we shall refer to any oriented, ordered, based link simply as a *based link*.)

Consider the family of based links  $J \cup L$ , where  $L$  has  $\ell$  components. For later notational convenience, assume that the ordering index for  $J \cup L$  runs from 1 to  $\ell + m$  (so  $m$  is the number of components in  $J$ ) with  $L$  corresponding to  $1, \dots, \ell$ . Of particular interest is the case when  $L = T$ , where  $T$  is a *trivial* link lying in in a ball disjoint from  $J$  (and its base paths). We shall define a “special” class of based links related to  $J \cup T$ .

---

<sup>†</sup>although it is, for example, if  $H_1(M)$  has no 2-torsion

**Definition 2.10.** A based link  $J \cup L$  in  $S^3$  is *special* if it is obtained from  $J \cup T$  by replacing some number of disjoint 3-string trivial tangles  $(B^3, \gamma_i \cup \gamma_j \cup \gamma_k)$ , by (one of 2 possible) “Borromean tangle(s)”  $(B^3, \gamma'_i \cup \gamma'_j \cup \gamma'_k)$  subject to the condition that  $\{\gamma_i, \gamma_j, \gamma_k\}$  are arcs of 3 *distinct* components of  $J \cup T$  with at least one being a component of  $T$ . Such a replacement is called a *Borromean replacement* of type  $(i, j, k)$ . The geometric number of such is denoted  $n_{ijk}$ .

Let  $[M, L]$  be an arbitrary generator of  $\mathcal{G}_\ell(M)$ . By the framing lemma (2.4) we may assume that all components of  $L$  have framing  $+1$ . Isotope  $L$  in  $M$  so that  $L \subset S^3_J$  is disjoint from the surgery tori and each component of  $L$  has zero linking with each component of  $J$ .

Now consider the link  $J \cup L$  in  $S^3$ . Order and orient the components the components of  $L$  arbitrarily, and choose base paths which extend the basing of  $J$ . Thus  $J \cup L$  becomes a *based* link in the sense defined above. By [L1, p.51] there is a set  $\{\mu_{ij}, a_{ijk}\} = \mu(J \cup L)$  of integers associated to this based link. The  $\mu_{ij}$  are the linking numbers and the  $a_{ijk}$  are “lifts” of Milnor’s triple  $\bar{\mu}$ -invariants. Compare these to  $\mu(J \cup T)$ . Clearly the linking numbers agree. Moreover  $a_{ijk}$  depends only on the 3-component based sublinks [L1, p.54, paragraph 3]. A 3-component sublink  $\{J_i, J_j, J_k\}$  is independent of  $L$  and hence the corresponding  $a_{ijk}$  for  $J \cup L$  and  $J \cup T$  agree. Thus, in the following discussion we restrict to those  $(i, j, k)$  corresponding to a 3-component sublink containing at least one component of  $L$  or  $T$  (so  $i \leq \ell$  by our ordering conventions). These may be altered by Borromean replacements. By the proof of Theorem C of [L1], there exists a *special* link  $J \cup L_s$  such that  $\mu(J \cup L_s) = \mu(J \cup L)$  where each Borromean replacement involves at least one component from  $T$ . By Theorem D of that paper,  $J \cup L_s$  is surgery equivalent to  $J \cup L$ . By the surgery lemma (2.9)  $[M, L] \sim [M, L_s]$ . Therefore we have shown that  $\mathcal{G}_\ell(M)$  is spanned by elements of the form  $[S^3_J, L]$  where  $J \cup L$  is special and all framings are  $+1$ .

By the proof of Theorem C of [L1] the invariants  $a_{ijk}$  of a special link differ from those of  $J \cup T$  by precisely the algebraic number of Borromean replacements of type  $(i, j, k)$ . Therefore two special links are surgery equivalent if and only if the *algebraic* number of tangle replacements of type  $(i, j, k)$

is the same for each triple  $i < j < k$ . Consequently we need only consider *one* special link for each possible value of the collections  $\{a_{ijk} \mid i < j < k\}$  (with all indices between 1 and  $\ell + m$ , and  $i \leq \ell$  as usual). The corresponding set of  $[S_j^3, L]$  (using  $+1$  framings) forms a spanning set for  $\mathcal{G}_\ell(M)$ , which is still *infinite* since the  $a_{ijk}$  can be arbitrary.

Choose such a set for which the *actual* number  $n_{ijk}$  of replacements of type  $(i, j, k)$  is equal to  $|a_{ijk}|$ , for each  $i, j, k$ . Now apply the braiding lemma (2.5), noting that the links on the right hand side are all special if the one on the left is special, to show that one need only consider special links for which there are at most *two* replacements involving each component of  $L$ . This then yields a *finite* spanning set for  $\mathcal{G}_\ell(M)$ , corresponding to collections  $\{a_{ijk} \mid i < j < k\}$  for which each of the indices  $1, \dots, \ell$  appears in at most two non-zero  $a_{ijk}$ 's. This completes the proof of Theorem 2.1.  $\square$

**Remark 2.11.** With a little more work it can be seen that only links with each non-zero  $a_{ijk}$  equal to  $+1$  are needed in the generating set: Consider a special link representing one of the generators. Fix  $i < j < k$  and consider the number of replacements  $n_{ijk}$  of type  $(i, j, k)$ . This number is either 0, 1 or 2 (according to the construction above) and we are only interested in the latter two cases.

If  $n_{ijk} = 1$  then  $a_{ijk} = \pm 1$ . In case  $a_{ijk} = -1$  and  $L_k$  is not involved in any other replacements then simply change the orientation of  $L_k$  to get  $a_{ijk} = +1$ . In case  $L_k$  is involved in one other replacement, apply the half-twist lemma (2.7) to reduce to situations in which it is involved in only one replacement or the  $a_{ijk}$  is changed to  $+1$ .

If  $n_{ijk} = 2$  then  $a_{ijk} = \pm 2$ , and changing the orientation on  $L_k$  if necessary gives  $a_{ijk} = 2$ . Now apply 2.7 again to reduce to cases in which  $a_{ijk} = 0$  (for which we can substitute a simpler special link) or  $n_{ijk} = 1$ . Thus we obtain a spanning set with each  $a_{ijk}$  equal to 0 or 1 and  $n_{ijk} = a_{ijk}$ .

In summary, if we think of  $L = \{L_1, \dots, L_\ell\}$  and  $J = \{J_1, \dots, J_m\}$ , then we have found a spanning set in one-to-one correspondence with the *subsets* of the index set  $U = \{(i, j, k) \mid 1 \leq i < j < k \leq \ell + m, i \leq \ell\}$  in which each of the indices  $1, \dots, \ell$  appears at most twice.

We now prove that  $\mathcal{O}$ , the group of all finite type invariants, and  $\mathcal{O}(M)$ , the group of all finite type invariants for manifolds in the  $H_1$ -bordism class of  $M$ , have the structure of algebras. As usual, one must be careful to define  $\lambda\lambda'$  as the *linear extension* to  $\mathcal{M}$  of the usual product of functions on  $\mathcal{S}$ . So for example if  $M$  and  $N$  are manifolds,  $\lambda\lambda'(M+N) = \lambda(M)\lambda'(M) + \lambda(N)\lambda'(N)$ .

**Proposition 2.12.** *If  $\lambda \in \mathcal{O}_p$ ,  $\lambda' \in \mathcal{O}_q$  then  $\lambda\lambda' \in \mathcal{O}_{p+q}$ .*

*Proof.* We shall show that

$$\lambda\lambda'([M, L]) = \sum_{S < L} \lambda([M, S])\lambda'([M_S, L - S])$$

which will complete the proof since if  $\ell > p+q$  then either  $s > p$  or  $\ell - s > q$ . Rewrite  $\lambda'([M_S, L - S])$  as  $\sum_{T > S} (-1)^{t-s} \lambda'(M_T)$ . Then the right hand side above can be expressed as

$$\sum_{S < L} \left[ \sum_{R < S} (-1)^r \lambda(M_R) \sum_{T > S} (-1)^{t-s} \lambda'(M_T) \right].$$

Rearranging the order of summation gives

$$\sum_{R < T < L} [(-1)^{r+t} \lambda(M_R) \lambda'(M_T) \sum_{R < S < T} (-1)^s]$$

The inner sum vanishes unless  $R = T$ , since it is an alternating sum of binomial coefficients. For  $R = T$  we get  $(-1)^t \lambda(M_T) \lambda'(M_T)$ , and summing over  $T < L$  gives  $\lambda\lambda'([M, L])$  as desired.  $\square$

Thus if  $A$  is a commutative ring then  $\mathcal{O}$  is a filtered commutative ring in which  $A$  occurs naturally as the subring of constant functions. The multiplication then makes  $\mathcal{O}$  a filtered commutative  $A$ -algebra and  $\mathcal{O}(M)$ , for any  $M$ , a subalgebra.

### 3 The Conway polynomial

In this section we will show that  $\mathcal{G}_{2n} = \mathcal{M}_{2n}/\mathcal{M}_{2n+1}$  is infinite for each  $n \geq 0$  by exhibiting specific finite type invariants  $C_{2n}$  of degree  $2n$ . The invariant  $C_{2n}(M)$  will be defined to be the coefficient of  $z^{2n}$  in the ‘‘Conway polynomial’’ of  $M$  if  $\mathfrak{b}_1(M) = 1$ , and zero otherwise. Since C. Lescop’s invariant

[Ls] is  $C_2(M) - \frac{1}{12}|\text{Tor}H_1(M)|$  for manifolds with  $\mathfrak{b}_1 = 1$ , this shows that her invariant is finite type of degree 2 on this  $H_1$ -bordism class. Moreover we show that the set  $\{C_2, C_4, \dots\}$  is a basis of a polynomial subalgebra of  $\mathcal{O}$ . (Note that  $C_0$  is excluded since it is identically equal to 1 on manifolds of first betti number one, whence  $C_0^2 = C_0$  is a polynomial relation in  $\mathcal{O}$ .)

A closed oriented 3-manifold  $M$  with  $\mathfrak{b}_1(M) = 1$  has a unique Conway polynomial  $\nabla_M(z) = 1 + a_2z^2 + a_4z^4 + \dots$  defined as follows. Let  $\widetilde{M}$  denote the infinite cyclic cover of  $M$ . Evidently  $H_1(\widetilde{M})$  has two  $\mathbb{Z}[t, t^{-1}]$  module structures, differing by  $t \mapsto t^{-1}$ . The *Alexander polynomial* of  $M$  is defined to be the order of (either of) these torsion modules divided by  $|\text{Tor}(H_1(M))|$ . It can also be identified with the Alexander polynomial of a suitable knot. Indeed  $M$  can be constructed by 0-framed surgery  $\Sigma_K$  on a null-homologous knot  $K$  in a rational homology sphere  $\Sigma$  ([Ls, §5.1.1]), and it is an easy exercise to see that the Alexander module  $H_1(\widetilde{\Sigma - K})$  of  $K$  is isomorphic to  $H_1(\widetilde{M})$  (where the module structure is determined by a choice of orientation on  $K$ ). Now recall that the Alexander polynomial of  $K$  in  $\Sigma$  is defined to be the order of this torsion module divided by  $|H_1(\Sigma)|$ , and may be computed as  $\det(tV - V^T)$  where  $V$  is any (rational) Seifert matrix for  $K$  in  $\Sigma$  ([Ls, §2.3.12–13]). Since  $|H_1(\Sigma)| = |\text{Tor}(H_1(M))|$ , this coincides with the Alexander polynomial of  $M$ . Of course this polynomial is only defined up to a unit  $\pm t^n$  in  $\mathbb{Q}[t, t^{-1}]$ , but it can be normalized by setting  $\Delta_M(t) = \Delta_{K, \Sigma}(t) = \det(t^{1/2}V - t^{-1/2}V^T)$  so that  $\Delta_M(t^{-1}) = \Delta_M(t)$  and  $\Delta_M(1) = 1$ . This yields a uniquely defined Alexander polynomial, a Laurent polynomial in  $t^{1/2}$  with rational coefficients, which can be shown to be an honest polynomial in  $(t^{1/2} - t^{-1/2})^2$  ([Ls, §2.3.14–15]). Substituting  $z$  for  $t^{1/2} - t^{-1/2}$  then yields the *Conway polynomial*  $\nabla_M(z)$  of  $M$ , or equivalently  $\nabla_{K, \Sigma}(z)$  of  $K$  in  $\Sigma$ , an element of  $\mathbb{Q}[z^2]$ .<sup>†</sup> Extending linearly by setting  $\nabla_M = 0$  if  $\mathfrak{b}_1(M) \neq 1$  yields a polynomial valued invariant  $\nabla : \mathcal{M} \rightarrow \mathbb{Q}[z^2]$ .

We shall also need the fact that the Conway polynomial can be defined for *links* in rational homology spheres (see e.g. [BoL]). In particular if  $K$  is a  $k$ -component null-homologous *oriented* link in a rational homology sphere  $\Sigma$ , then  $\nabla_{K, \Sigma}(z)$  is of the form  $z^{k-1}(a_0 + a_1z^2 + \dots)$ . The crucial fact needed

<sup>†</sup> $\nabla_{K, \Sigma}(s^{-1} - s)$  coincides with the polynomial defined by Boyer and Lines [BoL].

here, due to Boyer and Lines, is that  $\nabla_K = \nabla_{K,\Sigma}$  satisfies the familiar recursion formula  $\nabla_{K^+} - \nabla_{K^-} = -z\nabla_{K^0}$  (see [Ls, §2.3.16]).

The main result of this section is the following.

**Theorem 3.1.** *Let  $n$  be a nonnegative integer and  $M$  be a closed, oriented 3-manifold. Consider the 3-manifold invariant  $C_{2n} : \mathcal{M} \rightarrow \mathbb{Q}$  which assigns to  $M$  the coefficient of  $z^{2n}$  in the Conway polynomial  $\nabla_M$  if  $\mathfrak{b}_1(M) = 1$ , and zero otherwise. Then  $C_{2n}$  is finite type of degree  $2n$ .*

**Remark.** If the domain of  $C_{2n}$  is restricted to integral homology  $S^1 \times S^2$ 's then  $C_{2n}$  is an integral invariant.

The theorem will follow easily from Theorem 3.2 below concerning the divisibility of the alternating sum of Conway polynomials of links in a rational homology sphere. A realization result, Proposition 3.6, is then also needed to show that  $C_{2n}$  has degree precisely  $2n$ .

Suppose  $K$  is a null-homologous oriented link in a rational homology sphere  $\Sigma$ , and  $L = \{L_1, \dots, L_\ell\}$  is an admissible framed link in  $\Sigma$  (see 1.2). We say that  $L$  is *admissible in*  $(\Sigma, K)$  if  $K$  bounds a Seifert surface in  $\Sigma - L$ , or equivalently  $L$  is disjoint from  $K$  and  $\ell k(K, L_i) = 0$  for all  $i$ . If  $S$  is a sublink of such an  $L$  then  $\Sigma_S$  is again a rational homology sphere in which the image of  $K$  remains a link. For brevity we continue to denote this image by  $K$  whenever possible. We shall also use the abbreviation  $\nabla_K(S)$  for the Conway polynomial of  $K$  in  $\Sigma_S$  for any sublink  $S$  of  $L$ ,

$$\nabla_K(S) = \nabla_{K,\Sigma_S} ,$$

and  $\nabla_K(\delta L)$  for  $\sum_{S < L} (-1)^s \nabla_K(S)$ .

**Theorem 3.2.** *If  $K$  is a null-homologous oriented link in a rational homology sphere  $\Sigma$  and  $L$  is an admissible link of  $\ell$  components in  $(\Sigma, K)$  then  $z^\ell$  divides  $\nabla_K(\delta L)$ .*

The proof will be given later in this section.

**Example 3.3.** Suppose  $K$  is the trivial knot in  $\Sigma = S^3$  (with either orientation) and  $L = K_1 \cup K_2$  is the +1-framed 2-component link shown in Figure 3.4. Then  $(\Sigma_{K_1}, K) \cong (\Sigma_{K_2}, K) \cong (\Sigma, K) \cong (\Sigma, \text{unknot})$ , whereas  $(\Sigma_L, K)$  is the right-handed trefoil knot (most easily seen by “blowing-down”  $L$  [Ki]). Thus  $\nabla_K(\delta L) = 1 - 1 - 1 + (1 + z^2) = z^2$ , which is divisible by  $z^2$  as predicted by Theorem 3.2.

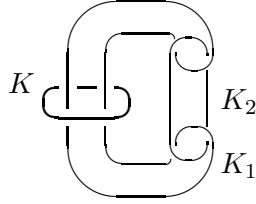

Figure 3.4:  $L = K_1 \cup K_2$

This example can be generalized by taking “parallel” copies to obtain the +1-framed  $2n$ -component link  $L_{2n}$  shown in Figure 3.5.

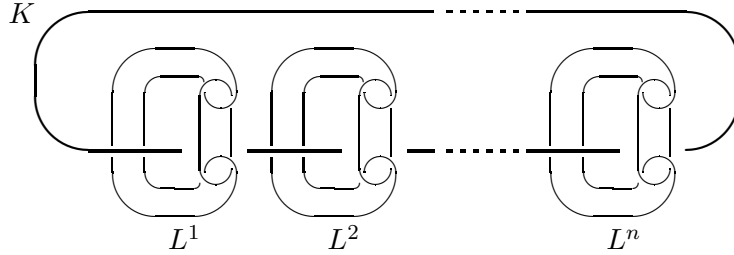

Figure 3.5:  $L_{2n} = L^1 \cup \dots \cup L^n$

**Proposition 3.6.** Let  $K$  be an unknot in  $\Sigma = S^3$  (with either orientation) and  $L_{2n}$  be the +1-framed  $2n$ -component link shown in Figure 3.5, where each  $L^i$  is a copy of the 2-component link  $L$  in Figure 3.4. Set  $\lambda_{2n} = [\Sigma_K, L_{2n}]$ , where  $K$  is given the zero framing. (Note that  $\Sigma_K = S^1 \times S^2$  since  $K$  is unknotted.) Then

- a)  $\nabla_K(\delta L_{2n}) = z^{2n}$ .
- b)  $C_{2k}(\lambda_{2n}) = \delta_{kn}$  (the Kronecker delta). In particular  $C_{2n}(\lambda_{2n}) = 1$  and so  $\deg(C_{2n}) \geq 2n$ .

*Proof.* By definition  $\nabla_K(\delta L_{2n}) = \sum_{S < L_{2n}} (-1)^s \nabla_K(S)$ . Each  $S$  is a union  $\cup S_i$  of sublinks  $S^i$  of  $L^i$  with  $s_i \leq 2$  components. Since the  $S^i$  lie in disjoint balls,  $\nabla_K(S) = \nabla_K(S^1) \dots \nabla_K(S^n)$ , and so  $\nabla_K(\delta L_{2n})$  is a sum of products, which can be rewritten as the product of sums  $\prod_{i=1}^n \sum_{S^i < L^i} (-1)^{s_i} \nabla_K(S^i) = \prod_{i=1}^n \nabla_K(\delta L^i) = (\nabla_K(\delta L))^n = z^{2n}$  by Example 3.3. This completes the proof of a), and b) follows since  $\nabla_{\lambda_{2n}} = \nabla_K(\delta L_{2n})$ .  $\square$

**Remark 3.7.** This proposition can also be proved by expanding  $\lambda_{2n}$  as a linear combination of manifolds, and then evaluating  $C_{2k}$ . This approach, although longer, facilitates the computation of *products* of Conway coefficients and can be used to establish lower bounds for the ranks of the groups  $\mathcal{G}_{2n}(S^1 \times S^2)$  (see §5).

We indicate how this is done. Write  $\tau$  for 0-surgery on the right-handed trefoil  $T$ , and more generally  $\tau^n$  for 0-surgery on a connected sum of  $n$  copies of  $T$ . Then it is readily seen that  $\lambda_{2n} = (\tau - 1)^n$ , where the right hand side is expanded using the binomial theorem and “1” is to be interpreted as  $S^1 \times S^2$ . Since  $\nabla_{\tau^j} = (1 + z^2)^j$ , it follows that  $C_{2k}(\tau^j)$  is equal to the binomial coefficient  $\binom{j}{k}$ , and so

$$C_{2k}(\lambda_{2n}) = \sum_{j=0}^n (-1)^{n-j} \binom{n}{j} \binom{j}{k}.$$

Observe that in this formula,  $k$  can be a multi-index  $(k_1, \dots, k_m)$ , in which case  $C_{2k} = \prod C_{2k_i}$  and  $\binom{j}{k} = \prod \binom{j}{k_i}$ . If  $m = 1$  then this reduces to the formula in 3.6b by a well known combinatorial identity. The case  $m = n$  with  $k = (1, \dots, 1)$  gives the formula

$$C_2^n(\lambda_{2n}) = \sum_{j=1}^n (-1)^{n-j} \binom{n}{j} j^n.$$

In particular for  $n = 2$  we see that  $(C_4, C_2^2)(\lambda_4) = (1, 2)$ . A similar calculation shows that  $(C_4, C_2^2)(\hat{\lambda}_4) = (0, 4)$  for  $\hat{\lambda}_4 = [\Sigma_K, \hat{L}_4] \in \mathcal{M}_4(S^1 \times S^2)$ , where  $\hat{L}_4$  is the 4-component “circular link” obtained from  $L_8$  by banding together pairs of components, as shown in Figure 3.8.



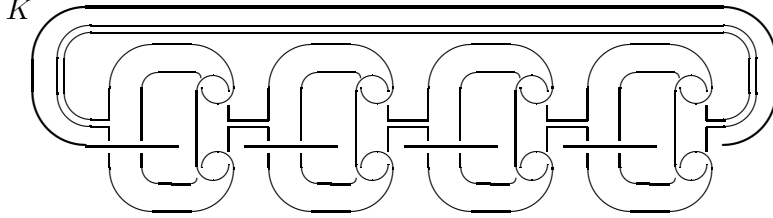

Figure 3.8:  $\hat{L}_4$

It follows that  $\mathcal{G}_4(S^1 \times S^2)$  has rank at least two, detected by the degree 4 linearly independent finite type invariants  $C_4$  and  $C_2^2$ . In §5 it will be shown to have rank exactly two.

We now return to the proof of the main theorem (3.1).

*Proof that 3.2 and 3.6  $\Rightarrow$  3.1:* Suppose  $\mathfrak{b}_1(M) = 1$  and  $L$  is a  $(2n + 1)$ -component admissible link in  $M$ . To show that  $C_{2n}$  is finite type of degree at most  $2n$  it suffices to show that  $C_{2n}([M, L]) = 0$ , that is that  $z^{2n+1}$  divides  $\nabla_{[M, L]}$  (the latter is an abbreviation for  $\sum_{S < L} (-1)^s \nabla_{M_S}$ ). As mentioned above,  $M = \Sigma_K$  for some rational homology sphere  $\Sigma$  and some 0-framed null-homologous knot  $K$  in  $\Sigma$ . By general position we may assume  $L \subseteq \Sigma - K$ . The epimorphism  $H_1(\Sigma - K) \cong H_1(M) \rightarrow \mathbb{Z}$  is given by linking number with  $K$ . Since each component of  $L$  is null-homologous in  $M$ , it must have zero linking number with  $K$ . Thus  $L$  is admissible in  $(\Sigma, K)$ . Now  $M_S = \Sigma_{S \cup K} = (\Sigma_S)_K$  so  $\nabla_{M_S} = \nabla_{K, \Sigma_S} = \nabla_K(S)$ , by definition. Therefore  $\nabla_{[M, L]} = \sum_{S < L} (-1)^s \nabla_K(S) = \nabla_K(\delta L)$  which is divisible by  $z^{2n+1}$  by 3.2. Hence  $C_{2n}$  is finite type of degree at most  $2n$ , and so in fact of degree exactly  $2n$  by 3.6.  $\square$

It follows immediately from Theorem 3.1 and the previous proposition that  $\mathcal{G}_{2n}$  is infinite for all  $n$ .

**Corollary 3.9.** *The element  $\lambda_{2n}$  (in 3.6) is of infinite order in  $\mathcal{G}_{2n}(S^1 \times S^2)$ .*

*Proof.* If  $\lambda_{2n}$  or some non-zero multiple lay in  $\mathcal{M}_{2n+1}$  then  $C_{2n}(\lambda_{2n})$  would vanish by Theorem 3.1, contradicting Proposition 3.6.  $\square$

More generally, if the knot  $K$  of Figure 3.5 is replaced by an arbitrary null-homologous knot  $K^*$  in a rational homology sphere  $\Sigma$ , with the link  $L$  living in a small ball, then  $\nabla_{K^*}(\delta L) = \nabla_K(\delta L) \cdot \nabla_{K^*,\Sigma} = z^{2n}(1 + \dots)$ . Thus we have

**Corollary 3.10.** *For any 3-manifold  $M$  with  $\mathfrak{b}_1(M) = 1$  and any  $n \geq 0$ , the group  $\mathcal{G}_{2n}(M)$  is of positive rank. Thus  $\mathcal{O}_{2n}(M)$ , the group of rational valued finite type invariants on  $\mathcal{M}(M)$  of degree at most  $2n$ , has rank greater than  $n$ .*

*Proof.* Any such  $M$  equals  $\Sigma_{K^*}$  for some 0-framed null-homologous knot  $K^*$  in a rational homology sphere  $\Sigma$ . The construction of  $L$  above yields a  $2n$ -component link such that  $\nabla_{[M,L]} = \nabla_{K^*}(\delta L) = z^{2n} + \text{higher order terms}$  so  $C_{2n}([M,L]) = 1$ . Thus  $C_{2n}$  is of infinite order in  $\mathcal{O}_{2n}(M)$ . The last statement follows since  $\mathcal{O}_{2n} = \mathcal{G}_0 \oplus \dots \oplus \mathcal{G}_{2n}$ .  $\square$

In fact much larger bounds for the ranks of these groups can be deduced from the algebraic independence of the Conway polynomial coefficients (as functions on the set of knots in  $S^3$ ).

**Corollary 3.11.** *Suppose  $\mathfrak{b}_1(M) = 1$ . Then the Conway invariants freely generate a polynomial algebra  $P[C_2, C_4, \dots]$  in  $\mathcal{O}(M)$ .<sup>†</sup> Therefore the rank of  $\mathcal{O}_{2n}(M)$  is at least  $p(0) + \dots + p(n)$ , where  $p(k)$  is the number of unordered partitions of  $k$ .*

*Proof.* Assume to the contrary that there is a non-zero rational polynomial  $p(x_1, \dots, x_m)$  such that  $p(C_2, \dots, C_{2m})$  is identically zero on  $\mathcal{M}(M)$ . Since  $p \neq 0$ , there exist integers  $n_i$  for which  $p(n_1, \dots, n_m) \neq 0$ . Let  $K$  be a knot in  $S^3$  whose Conway polynomial is  $1 + n_1 z^2 + \dots + n_m z^{2m}$ ; it is well known that such knots exist.

Now recall that  $M$  can be described as 0-framed surgery on a suitable null-homologous knot  $J$  in a rational homology sphere  $\Sigma$ . Moreover all such manifolds, for varying  $J$ , are  $H_1$ -bordant since any Seifert surface for  $J$  can be “unknotted” by  $\pm 1$ -framed surgeries on small circles that link

---

<sup>†</sup>Coefficients are in  $\mathbb{Q}$ , but can be taken in  $\mathbb{Z}$  if  $H_1(M)$  is torsion free.

the bands of the surface. In particular, the manifold  $M_0$  obtained by 0-surgery on  $K$  in  $\Sigma$  (i.e. put  $K$  inside a small ball in  $\Sigma$ ) lies in  $\mathcal{M}(M)$ . But  $p(C_2, \dots, C_{2m})(M_0) = p(n_1, \dots, n_m) \neq 0$ , a contradiction.

Finally observe that for every  $k$ , the degree  $2k$  part of  $P[C_2, C_4, \dots]$  lies in  $\mathcal{O}_{2k}(M)$ , by Proposition 2.12, and is of rank  $p(k)$ . The stated bound on  $\text{rk}(\mathcal{O}_{2n}(M))$  follows.  $\square$

**Remark.** It is not being claimed in 3.11 that the grading on  $P[C_2, C_4, \dots]$  is preserved under its embedding in  $\mathcal{O}(M)$ . Showing this would require more work. However Remark 3.7 establishes this for the elements of degree 4 or less, i.e. any non-trivial linear combination of  $C_4$  and  $C_2^2$  is of degree 4.

We now proceed with the proof of Theorem 3.2, which will be based on the following result.

**Theorem 3.12.** *Suppose  $\Sigma$ ,  $K$  and  $L$  are as in the hypothesis of 3.2 with  $\ell \geq 1$ . Let  $J$  be a component of  $L$  and let  $L' = L - J$ . Then there exist oriented links  $K_i$  in  $\Sigma - L'$  and signs  $\varepsilon_i = \pm 1$  such that  $L'$  is admissible in  $(\Sigma, K_i)$  for each  $i$ , and*

$$\nabla_K(S) - \nabla_K(S \cup J) = z \sum \varepsilon_i \nabla_{K_i}(S)$$

for every sublink  $S$  of  $L'$ .

To understand this theorem, the reader should think of the simplest case when  $J$  bounds an embedded disk in  $\Sigma$  which is punctured twice by  $K$  and not at all by  $L'$ . Then the difference between performing  $\pm 1$  surgery on  $J$  or not doing so is a local “crossing change” of  $K$ . If we let  $K_0$  denote the usual “smoothing” of  $K$  then  $\nabla_K(S \cup J) - \nabla_K(S) = \varepsilon_0 z \nabla_{K_0}(S)$  where  $\varepsilon_0$  is the framing on  $J$ , and clearly  $L'$  remains admissible in  $(\Sigma, K_0)$ . In general  $J$  might be knotted and might have a more complicated interaction with  $K$  and  $L'$ . Thus the strategy of the proof is to show that the general case reduces to this simple case, and that the effect on the Conway polynomial of surgery on  $J$  is to add or subtract terms of the form  $z$  times the Conway polynomial of a smoothing. It is crucial, however, that these smoothings  $K_i$  (as well as the signs  $\varepsilon_i$ ) be *independent of  $S$* . By this we mean that  $K_i$  is disjoint from  $L$  so that for any sublink  $S$  of  $L$  we may use the symbol  $K_i$  to denote the image of this single link in  $\Sigma_S$ .

*Proof that 3.12  $\Rightarrow$  3.2.* We induct on  $\ell$ , assuming  $\ell \geq 1$  since the case  $\ell = 0$  is trivial. Choose a component  $J$  of  $L$  and set  $L' = L - J$ . Then  $\nabla_K(\delta L) = \sum_{S < L'} (-1)^s (\nabla_K(S) - \nabla_K(S \cup J)) = z \sum_{S < L'} (-1)^s \sum \varepsilon_i \nabla_{K_i}(S)$  by 3.12. Reversing the order of summation, using that  $\varepsilon_i$  and  $K_i$  are independent of  $S$ , this gives  $z \sum_{i=1}^r \varepsilon_i \nabla_{K_i}(\delta L')$ , and by induction each  $\nabla_{K_i}(\delta L')$  is divisible by  $z^{\ell-1}$ . Hence  $\nabla_K(L)$  is divisible by  $z^\ell$ .  $\square$

*Proof of 3.12.* Let  $\varepsilon_J$  denote the framing of  $J$ . A knot in  $\Sigma - (K \cup L')$  will be called *simple* if it bounds an embedded disk  $D$  in  $\Sigma - L'$  which intersects  $K$  transversely in algebraically zero points. Clearly  $J' \cup L'$  is admissible in  $(\Sigma, K)$  if  $J'$  is simple.

First assume that  $J$  is simple. Then surgery on  $J$  puts a full  $(-\varepsilon_J)$ -twist in all the strands of  $K$  passing through  $D$  – this can be seen by “blowing down”  $J$  [Ki]. What results is an oriented link  $K'$  in  $\Sigma - L'$  with  $\nabla_{K'}(S) = \nabla_K(S \cup J)$  for all  $S < L'$ . This link can also be obtained from  $K$  by a finite sequence of crossing changes, which we assume have been specified. Let  $K^i$  be the link obtained by changing the first  $i$  crossings of  $K$ , and  $K_i$  be the link obtained from  $K^i$  by smoothing the  $i$ th crossing. Then

$$\nabla_K(S) - \nabla_K(S \cup J) = \sum (\nabla_{K^{i-1}}(S) - \nabla_{K^i}(S)) = z \sum \varepsilon_i \nabla_{K_i}(S)$$

where  $\varepsilon_i$  is the sign of the  $i$ th crossing (*after* it is changed). Note that  $L'$  is admissible in  $(\Sigma, K_i)$  since changing or smoothing a self-crossing of a link does not change its linking numbers with other knots.

Now assume that  $J$  is not simple. We claim that there exists a simple knot  $J'$  with  $d_J(S) = d_{J'}(S)$  for all  $S < L'$ , where by definition  $d_*(S) = \nabla_K(S) - \nabla_K(S \cup *)$ . The theorem would then follow from the simple case.

To establish the claim, we appeal to a well known fact about the behavior of linking numbers under surgery (cf. [Ho2]).

**Lemma 3.13.** *Let  $A, B$  be disjoint null-homologous knots in a rational homology sphere  $\Sigma$  and  $J$  be a knot in  $\Sigma - (A \cup B)$  with framing  $\varepsilon_J = \pm 1$ . Then*

$$\ell k_J(A, B) = \ell k(A, B) - \varepsilon_J \ell k(A, J) \ell k(J, B)$$

where  $\ell k$  and  $\ell k_J$  denote linking numbers in  $\Sigma$  and  $\Sigma_J$  respectively.

*Proof.* Set  $\lambda = lk(A, B)$ ,  $\lambda_J = lk_J(A, B)$ ,  $\alpha = lk(A, J)$  and  $\beta = lk(J, B)$ . Let  $m_B, \ell_B$  be a meridian and longitude of  $B$  in  $\Sigma$ , and similarly define  $m_J, \ell_J$ . Then  $A$  is homologous in  $\Sigma - (B \cup J)$  to  $\lambda m_B + \alpha m_J$ . But  $m_J$  is homologous in the surgery torus to  $-\varepsilon_J \ell_J$ , and so  $A$  is homologous in  $\Sigma_J - B$  to  $\lambda m_B - \varepsilon_J \alpha \ell_J = (\lambda - \varepsilon_J \alpha \beta) m_B$ . Thus  $\lambda_J = \lambda - \varepsilon_J \alpha \beta$ .  $\square$

Using this result, it is easy to compare the Seifert form of  $K$  (which determines its Conway polynomial) in  $\Sigma_S$  and  $\Sigma_{S \cup J}$  as follows. Choose a connected Seifert surface  $F \subseteq \Sigma - L$  for  $K$  (it is often helpful to view  $F$  as a disk with one-handles attached), and for each sublink  $S$  of  $L'$ , let  $V_S$  denote the corresponding Seifert form for  $K$  in  $\Sigma_S$ . In other words  $V_S(a, b) = lk_S(a, b^+)$  for  $a, b \in H_1(F)$ , where  $lk_S$  denotes linking number in  $\Sigma_S$ . Now consider the symmetric bilinear form

$$\Lambda_J : H_1(F) \times H_1(F) \rightarrow \mathbb{Z}$$

sending  $(a, b)$  to  $lk(a, J)lk(J, b)$ , where  $lk$  is the linking number in  $\Sigma$ . We will call this the *linking form* of  $K$  associated to  $J$ .<sup>†</sup> Then

$$V_{S \cup J} = V_S - \varepsilon_J \Lambda_J.$$

Indeed the lemma applied to knots  $A$  and  $B$  representing  $a$  and  $b^+$  in  $\Sigma_S$ , for  $a, b \in H_1(F)$ , shows that  $V_{S \cup J}(a, b) = V_S(a, b) - \varepsilon_J lk_S(a, J)lk_S(J, b)$ , but linking numbers with  $J$  in  $\Sigma$  and  $\Sigma_S$  coincide since  $J$  bounds a surface in  $\Sigma - S$  (or by repeated application of the lemma).

It follows that if  $J'$  is any oriented knot in  $\Sigma - (F \cup L')$  which has the same framing and linking form as  $J$  (the latter holds for example if  $J'$  has the same linking number as  $J$  has with each one-handle of  $F$ ) and zero linking numbers with the components of  $L'$ , then  $d_J(S) = d_{J'}(S)$  for all  $S < L'$ . But it is obvious that there exists such a knot  $J'$  which is simple, chosen for example to lie in a neighborhood of the zero-handle of  $F$ . This establishes the claim, and thus completes the proof of Theorem 3.12.  $\square$

We conclude this section with a conjectured generalization of Theorem 3.2 to links which can be used to study the ‘‘Conway polynomials’’ of manifolds of higher first betti number (see §8).

---

<sup>†</sup>Note that this form is well defined, independent of a choice of orientation on  $J$ .

**Conjecture 3.14.** *If  $K$  is a null-homologous oriented  $k$ -component link with zero pairwise linking numbers in a rational homology sphere  $\Sigma$  and  $L$  is an admissible link of  $\ell$  components in  $(\Sigma, K)$  then  $z^{2k-2+\ell}$  divides  $\nabla_K([\Sigma, L])$ .*

**Remarks.** The case  $\ell = 0$  was recently proved by Levine [L2]. The case  $k = 1$  is covered by Theorem 3.2, and the case  $k = 2$  follows from the methods of §5 (the proof is sketched in Remark 8.3). Added in proof: The full conjecture has now been established by Amy Lampazzi.

## 4 Finite type invariants from quantum invariants

In this section it is shown that the theory of finite type invariants is highly non-trivial, even for 3-manifolds with large first betti number<sup>†</sup>. To accomplish this, we use the  $\mathbb{Z}_{p^k}$ -valued invariants  $\tau_p^d$  introduced by the authors in [CM1], that are extracted from the quantum  $\mathrm{SO}(3)$ -invariants. By studying these invariants as  $p$  and  $d$  approach infinity, we establish the *rational* non-triviality of the theory and provide strong evidence that much of Ohtsuki’s theory  $\mathcal{O}(S^3)$  of finite type invariants of homology 3-spheres embeds in  $\mathcal{O}(M)$  for any  $M$ . In addition, it is shown that for arbitrarily high betti number, the theory exhibits all of the complexity of finite type invariants of homology spheres which “come from  $\mathfrak{sl}(2)$ -weight systems” — namely Ohtsuki’s rational valued invariants of homology spheres.

Recall the *quantum invariants*  $\tau_p^G$  of 3-manifolds associated with a compact *gauge group*  $G$  and a positive integer *level*  $p$ . They were first discovered in a physical context by Witten [Wi], and developed mathematically by Reshetikhin and Turaev for  $G = \mathrm{SU}(2)$  [RT], and by Kirby and Melvin for  $G = \mathrm{SO}(3)$  [KM]. Following the notation of [CM1] (rather than [KM]) we will use the abbreviation  $\tau_p$  for the  $\mathrm{SO}(3)$ -invariant  $\tau_p^{\mathrm{SO}(3)}$  (denoted  $\tau'_p$  in [KM]), which can be viewed either as a function on  $\mathcal{S}$  or as a *linear* function on  $\mathcal{M}$ . This invariant is defined for all odd levels  $p$  and, when normalized as in our discussion of the proof of Lemma 4.7 at the end of this section,

---

<sup>†</sup>By contrast the [LMO] invariant, which provides a universal finite type invariant for homology 3-spheres [Le], gives quite restricted information for manifolds with first betti number  $\mathfrak{b}_1 > 0$ , and is in fact identically zero if  $\mathfrak{b}_1 > 3$  [H2].

takes values in the cyclotomic field  $Q_p = \mathbb{Q}(q)$  where  $q$  is a fixed primitive  $p^{\text{th}}$  root of unity. In fact, Hitoshi Murakami [M2] has shown that for *prime*  $p$ , it takes values in the ring of integers  $\Lambda_p = \mathbb{Z}[q]$  in  $Q_p$  (see also [MR]), and so in this case we have a  $\mathbb{Z}$ -linear map

$$\tau_p : \mathcal{M} \rightarrow \Lambda_p.$$

Furthermore,  $\tau_p$  is an  $\mathbb{Z}$ -algebra homomorphism with respect to the connected sum operation  $\# : \mathcal{M} \times \mathcal{M} \rightarrow \mathcal{M}$  (the bilinear extension of the corresponding operation on  $\mathcal{S}$ ), i.e.  $\tau_p(x\#y) = \tau_p(x)\tau_p(y)$ .

Henceforth we assume that  $p$  is an odd prime. Then  $\Lambda_p$  (as an abelian group) is free on  $h^j$  for  $0 \leq j \leq p-2$ , where  $h = q-1$ , and so any element  $a \in \Lambda_p$  can be written uniquely as  $a = a_0 + a_1h + \cdots + a_{p-2}h^{p-2}$ . Consider the projection  $\pi^{j+(k-1)(p-1)} : \Lambda_p \rightarrow \mathbb{Z}_{p^k}$ , for  $0 \leq j \leq p-2$  and  $k \geq 1$ , which maps  $a$  to  $a_j \pmod{p^k}$ . Clearly any  $a \in \Lambda_p$  is determined by the sequence  $\pi^d(a)$  for  $d \geq 0$ . Now define

$$\tau_p^d : \mathcal{M} \rightarrow \mathbb{Z}_{p^k}$$

to be the composition  $\tau_p^d = \pi^d \circ \tau_p$ . Then the following is obvious but stated for emphasis.

**Proposition 4.1.** *For any odd prime  $p$ , the sequence of invariants  $\tau_p^d$  for  $d \geq 0$  determines and is determined by the quantum  $\text{SO}(3)$ -invariant  $\tau_p$ .*

The main result of this section is:

**Theorem 4.2.** *For any odd prime  $p = 2n + 3$  and any integer  $d \geq 0$ , the closed oriented 3-manifold invariant  $\tau_p^d$  is a finite type invariant of degree at most  $3d$ , in fact of degree at most  $3d - n\mathfrak{b}_p(M)$  when restricted to  $\mathcal{M}(M)$ , where  $\mathfrak{b}_p(M) = \text{rk}(H_1(M; \mathbb{Z}_p))$ .*

Before giving the proof, we discuss a number of applications.

It is known that the full quantum invariant  $\tau_p$  is not of finite type for  $p > 3$  [CM1, §4] (note that  $\tau_3 \equiv 1$ ), but Theorem 4.2 shows that it is nevertheless a limit of finite type invariants in the same sense that an analytic function is the limit of its Taylor polynomials. The Conway and Jones

polynomials for knots are also of this nature. If one pursues the analogy that finite type invariants are the “polynomials”, then such limits of finite type invariants should be called “analytic” invariants.

We make this more precise. An invariant  $\phi : \mathcal{M} \rightarrow A$  is *weakly analytic* if  $\phi(\mathcal{M}_\infty) = 0$ .<sup>†</sup> The reader can check that this is equivalent to the statement that  $\phi$  is *dominated* by finite type invariants, in the sense that any classes in  $\mathcal{M}$  which can be distinguished by  $\phi$  can be distinguished by a finite type invariant (namely one of the projections  $\mathcal{M} \rightarrow \mathcal{M}/\mathcal{M}_\ell$ ).

We say that  $\phi$  is *analytic* if there is an inverse system  $\{A_k\}$  of abelian groups and finite type invariants  $\phi_k : \mathcal{M} \rightarrow A_k$  such that  $A \subset \varprojlim A_k$  and  $\pi_k \circ \phi = \phi_k$  for all  $k$ . Here  $\pi_k : A \rightarrow A_k$  are the restrictions of the natural projections.

Observe that finite type  $\Rightarrow$  analytic (take  $A_k = A$  and  $\phi_k = \phi$  for all  $k$ ) while the reverse implication fails; for example the projection  $\mathcal{M} \rightarrow \mathcal{M}/\mathcal{M}_\infty$  is analytic but not of finite type (also see below). Similarly analytic  $\Rightarrow$  weakly analytic (since  $x \in \mathcal{M}_\infty \Rightarrow \pi_k \phi(x) = \phi_k(x) = 0$  for all  $k$ , and so  $\phi(x) = 0$ ) while the converse presumably fails (although we do not know an example).

In this language, we have the following consequence of Theorem 4.2, which seems to be new even for homology spheres.

**Corollary 4.3.** *If  $p$  is an odd prime, then  $\tau_p$  is analytic, and therefore dominated by finite type invariants.*

*Proof.* Let  $A = \Lambda_p$ ,  $A_k = \oplus_{j=0}^{p-1} \mathbb{Z}_{p^k}$ ,  $\phi = \tau_p$  and  $\phi_k = \oplus_{j=0}^{p-2} \tau_p^{j+k(p-1)}$ . Then the  $\phi_k$  are of finite type (by Theorem 4.2),  $\Lambda_p \cong \oplus_{j=0}^{p-1} \mathbb{Z} \subset \varprojlim A_k = \oplus_{j=0}^{p-1} \mathbb{Z}_{(p)}$  (where  $\mathbb{Z}_{(p)}$  is the  $p$ -adic integers) and  $\pi_k \circ \phi = \phi_k$  for all  $k$ . Thus  $\tau_p$  is analytic.  $\square$

As another consequence of Theorem 4.2, we have:

**Corollary 4.4.** *If  $\text{rk } H_1(M; \mathbb{Z}_p) \equiv 0 \pmod{3}$  for some odd prime  $p = 2n + 3$ , then the invariant  $\tau_p^{nb_p/3}$  is constant on the entire  $H_1$ -bordism class of  $M$ .*

---

<sup>†</sup>Thus the set  $\mathcal{O}_\infty^A$  of  $A$ -valued weakly analytic invariants is the dual space  $\text{Hom}(\mathcal{M}/\mathcal{M}_\infty, A)$ , in analogy with the corresponding sets  $\mathcal{O}_\ell^A = \text{Hom}(\mathcal{M}/\mathcal{M}_{\ell+1}, A)$  of finite type invariants.



*Proof.* Degree zero invariants are constant on the  $H_1$ -bordism classes.  $\square$

This is interesting since  $H_1$ -bordism is fairly well understood in terms of triple cup products and linking forms [CGO]. Therefore it should be possible to calculate the precise topological meaning of these invariants. For example among manifolds with  $H_1 \cong \mathbb{Z}^3$ , the invariant  $\tau_p^n$  is completely determined by its values on the family of manifolds  $M_k$  given by 0-surgery on the links obtained from the Borromean rings by cabling one component  $(1, k)$  times, for  $k \geq 0$ . (These manifolds represent all the  $H_1$ -bordism classes [CGO].) One has the strong feeling that there should be a single integral invariant which determines the  $\tau_p^n$  for a fixed surgery equivalence class and varying  $p$ . Lescop's invariant for  $M_k$  is  $k^2$  since it is given by the coefficient of  $z^3$  in the Conway polynomial (§5 [Ls]) (§5 [Co]).

Note that  $\tau_p^n$  is not degree zero on  $\mathcal{M}(\#^2 S^1 \times S^2)$ , since it is zero for  $\#^2 S^1 \times S^2$  but non-zero for zero surgery on a Whitehead link [CM1], and any two manifolds with  $H_1 \cong \mathbb{Z}^2$  are  $H_1$ -bordant.

We now head towards a proof of the main theorem (4.2), discussing along the way its applications to the study of the structure of the filtered group  $\mathcal{M}$ . The proof we give follows from a divisibility result for  $\tau_p$  which extends the work of [CM1]. Our measure of divisibility is the *p-order*

$$\mathfrak{o}_p : \mathcal{M} \rightarrow \mathbb{Z} \cup \{\infty\}$$

defined by  $\mathfrak{o}_p(x) = v_h(\tau_p(x))$ , where  $v_h$  is the  $h$ -adic valuation on  $\Lambda_p$ . Thus  $\mathfrak{o}_p(x) = m$  if  $\tau_p(x)$  is written as  $c_m h^m + O(h^{m+1})$  with  $(c_m, p) = 1$  (see [CM1]). Equivalently,  $\mathfrak{o}_p(x)$  can be defined to be the minimum  $d$  for which  $\tau_p^d(x) \neq 0$ , or the maximum  $d$  for which  $h^d$  divides  $\tau_p(x)$  in  $\Lambda_p$ .

Observe that  $\mathfrak{o}_p(x)$  is infinite if and only if  $\tau_p(x) = 0$ , and so it is only by means of elements of *finite p-order* that  $\tau_p$  can be brought to bear on the study of the filtration of  $\mathcal{M}$ .

**Definition 4.5.** An element  $x$  in  $\mathcal{M}$  is *normal* if  $\mathfrak{o}_p(x)$  is finite (i.e.  $\tau_p(x)$  is non-zero) for arbitrarily large  $p$ . Let  $\mathcal{N}$  denote the set of all normal elements, and  $\mathcal{A}$  denote its complement, the set of all *abnormal* elements.

Evidently  $\mathcal{M}_\infty \subset \mathcal{A}$ . (In fact the inclusion is proper: the difference of any two manifolds with equal quantum invariants clearly lies in  $\mathcal{A}$ , but if carefully chosen can be shown not to lie in  $\mathcal{M}_\infty$  [CM2].) It is not known, however, whether there exist any abnormal *manifolds*.<sup>†</sup>

The collection of normal manifolds includes examples with any prescribed  $H_1$  (e.g. connected sums of rational homology spheres with copies of  $S^1 \times S^2$ ); it is conceivable that every 3-manifold is normal, or at least  $H_1$ -bordant to a normal manifold. For normal manifolds  $M$  it will be seen that the filtration of  $\mathcal{M}(M)$  is very rich.

**Remark 4.6.** The reader is warned that  $\mathfrak{o}_p$  is highly non-linear. Indeed it follows from properties of valuations and the multiplicativity of  $\tau_p$  that

- a)  $\mathfrak{o}_p(x + y) \geq \min\{\mathfrak{o}_p(x), \mathfrak{o}_p(y)\}$
- b)  $\mathfrak{o}_p(mx) = \mathfrak{o}_p(x) + v_p(m) = \mathfrak{o}_p(x) + (p-1)v_p(m)$   
(where  $v_p$  is the  $p$ -adic valuation on  $\mathbb{Z}$ )
- c)  $\mathfrak{o}_p(x \# y) = \mathfrak{o}_p(x) + \mathfrak{o}_p(y)$ .

The mod  $p$  first betti number  $\mathfrak{b}_p = \text{rk}H_1(-, \mathbb{Z}_p)$  similarly extends from  $\mathcal{S}$  to  $\mathcal{M}$  in a non-linear fashion by setting  $\mathfrak{b}_p(\sum m_i M_i) = \min(\mathfrak{b}_p(M_i))$ . The main result of [CM1] gives a lower bound for  $\mathfrak{o}_p$  in terms of  $\mathfrak{b}_p$ , namely

$$3\mathfrak{o}_p(x) \geq n\mathfrak{b}_p(x)$$

for all  $x \in \mathcal{M}$ , where  $n = (p-3)/2$ . (See Theorem 4.3 in [CM1] where this is proved for manifolds; the result extends to linear combinations of manifolds by Remark 4.6 and the definition of  $\mathfrak{b}_p$ .) Here we refine this result, taking into account where  $x$  lies in the filtration of  $\mathcal{M}$ .

**Lemma 4.7.** (*p*-order bound) *If  $x \in \mathcal{M}_\ell$ , then  $3\mathfrak{o}_p(x) \geq n\mathfrak{b}_p(x) + \ell$  for any odd prime  $p = 2n + 3$ .*

The proof of this lemma, which is quite technical, is postponed until the end of the section. Meanwhile we explore its many consequences. First observe that Theorem 4.2 follows easily.

---

<sup>†</sup>i.e. manifolds with  $\tau_p = 0$  for all but finitely many  $p$ ; manifolds with  $\tau_p = 0$  for infinitely many  $p$  are known to exist, for example 0-surgery on the trefoil [CM1, §5].

*Proof of 4.2.* If  $x = M_{\delta L}$  where  $L$  is a link with  $\ell > 3d - n\mathfrak{b}_p(x)$  components, then  $\mathfrak{o}_p(x) > d$  by the lemma, and so  $\tau_p^d(x) = 0$  by definition of  $\mathfrak{o}_p$ . Therefore  $\tau_p^d$  is finite type of degree at most  $3d - n\mathfrak{b}_p(M)$  on  $\mathcal{M}(M)$ .  $\square$

We now wish to use these results to investigate the structure of the filtered group  $\mathcal{M}$ . For conceptual reasons, it is convenient first to reformulate Lemma 4.7. This lemma relates the  $p$ -order of  $x \in \mathcal{M}$  to where  $x$  lies in the filtration. In particular, if we define the *depth* of  $x$  to be

$$d(x) = \max\{\ell \mid x \in \mathcal{M}_\ell\}$$

(a non-negative integer or  $\infty$ ), then the lemma can be viewed as giving an upper bound for  $d(x)$  based on information garnered from  $\tau_p(x)$ . This upper bound, called the  *$p$ -depth* of  $x$ , is given by

$$d_p(x) = 3\mathfrak{o}_p(x) - n\mathfrak{b}_p(x).$$

It should be thought of as a (quantum) measure of the depth of  $x$ , and so  $1/d_p(x - y)$  is a measure of the difference between  $x$  and  $y$ .

The basic properties of the  $p$ -depth function  $d_p : \mathcal{M} \rightarrow \mathbb{Z} \cup \{\infty\}$  are collected in the following lemma. The first property is just a restatement of Lemma 4.7, and the last three follow from Remark 4.6 and the definition and elementary properties of  $\mathfrak{b}_p$ .

**Lemma 4.8.** ( *$p$ -depth properties*) For any odd prime  $p$  and  $x, y \in \mathcal{M}$ ,

- a)  $d_p(x) \geq d(x)$
- b)  $d_p(x + y) \geq \min\{d_p(x), d_p(y)\}$
- c)  $d_p(mx) = d_p(x) + 3(p - 1)v_p(m)$  (for any integer  $m$ )
- d)  $d_p(x \# y) = d_p(x) + d_p(y)$ .  $\square$

Of particular interest are the elements in  $\mathcal{M}$  for which the bound in Lemma 4.8.1 is sharp.

**Definition 4.9.** An element  $x$  of finite depth in  $\mathcal{M}$  is *robust* if  $d_p(x) = d(x)$  for all sufficiently large primes  $p$  (and *strongly robust* if this equality holds for all  $p > 3$ ). In particular, a manifold  $M$  is robust if and only if  $d_p(M) = 0$  for all large  $p$ .

Robust elements are clearly normal (4.5) but not conversely (see below). They enjoy a number of other special properties, including the following.

**Proposition 4.10.** (properties of robust elements)

- a) *If  $x$  and  $y$  are robust, then  $x\#y$  is robust with  $d(x\#y) = d(x) + d(y)$ .*
- b) *If  $M$  and  $N$  are  $H_1$ -bordant 3-manifolds, then  $M$  is robust if and only if  $N$  is robust. Thus one may speak of robust or nonrobust bordism classes.*

*Proof.* For a) we have  $d(x\#y) \geq d(x) + d_p(y) = d_p(x) + d_p(y) = d_p(x\#y)$  (by 4.8.4). Since  $d_p(x\#y) \geq d(x\#y)$  for large  $p$  (by 4.8a) this implies  $d(x\#y) = d_p(x\#y) = d(x) + d(y)$ . For 2) assume  $M$  is robust, so  $d_p(M) = 0$ . But  $d_p(M) \geq \min(d_p(M - N), d_p(N))$  (by 4.8b) and  $d_p(M - N) \geq 1$  (since  $M$  and  $N$  are  $H_1$ -bordant) so  $d_p(N) = 0$ .<sup>†</sup>  $\square$

**Example 4.11.** A manifold  $M$  is robust if and only if  $3\mathfrak{o}_p(M) = n\mathfrak{b}_p(M)$  for all large  $p$ , and this forces the first betti number  $\mathfrak{b}_1(M)$  to be a multiple of 3 (since  $n = (p - 3)/2$  is not). In fact all rational homology spheres (the case  $\mathfrak{b}_1 = 0$ ) are robust by a result of Murakami [M2], and it is well known that the 3-torus  $T$  (with  $\mathfrak{b}_1 = 3$ ) is robust (see e.g. [CM1, §5]). It follows from 4.10a that for any  $b \equiv 0 \pmod{3}$  and any finite abelian group  $A$ , there is a robust 3-manifold with  $H_1 \cong \mathbb{Z}^b \times A$ , obtained by connected summing  $b/3$  copies of  $T$  with a suitable rational homology sphere.

On the other hand, the connected sum of manifolds one of which is non-robust is itself non-robust, as the reader may easily check. Thus for example  $M_0 = \#^3(S^1 \times S^2)$  is not robust even though  $\mathfrak{b}_1(M_0) = 3$ . In fact, for manifolds with betti number 3 and torsion free homology, it is expected that the set of non-robust manifolds is precisely the  $H_1$ -bordism class of this manifold. The other bordism classes are represented by the 3-manifolds  $M_k$  (for  $k > 0$ ) given by 0-surgery on the link obtained from the Borromean rings

---

<sup>†</sup>For a slightly different point of view, one can prove b) using the invariant  $\tau = \tau_p^{\mathfrak{o}_p(M)}$ , where  $p$  is chosen large enough so that  $d_p(M) = 0$ . Indeed  $\tau$  is constant by Corollary 4.4. Hence  $\tau(N) = \tau(M) \neq 0$ , and so  $\mathfrak{o}_p(N) \leq \mathfrak{o}_p(M)$ . Since  $\mathfrak{b}_p(M) = \mathfrak{b}_p(N)$ , it follows that  $d_p(N) \leq d_p(M) = 0$  and so  $d_p(N) = 0$ .

by performing a  $(1, k)$ -cable on one component, and it has been confirmed that these are robust classes at least for  $k = 1$  (since  $M_1 = T$ ) and  $k = 2$  [CM1, §5.4].

**Example 4.12.** An example of a (strongly) robust element of positive depth is the difference

$$\Delta = S^3 - P$$

where  $P$  is the Poincaré homology sphere. To see this, recall that  $\Delta = S_{\delta L}^3$  where  $L$  is  $+1$  surgery on the Borromean rings, and so  $d(\Delta) \geq 3$ . But Murakami has shown that  $\tau_p(\Delta) = -6\lambda(P)h + O(h^2)$ , where  $\lambda$  is Casson's invariant, and so  $\mathfrak{o}_p(\Delta) = 1$  for  $p > 3$ . Thus  $d_p(\Delta) = d(\Delta) = 3$  for all  $p > 3$ . More generally, for each  $k > 0$  the connected sum

$$\Delta_k = \Delta \# \cdots \# \Delta \quad (k \text{ copies})$$

is (strongly) robust of depth  $3k$  by Proposition 4.10a.

We now return to the investigation of the filtration on  $\mathcal{M}$ . As an immediate consequence of Lemma 4.8 we have the following estimates for the orders of an element of finite  $p$ -depth in the filtered quotients of  $\mathcal{M}$ .

**Theorem 4.13.** (order) *Any  $x \in \mathcal{M}$  of finite  $p$ -depth (i.e.  $\tau_p(x) \neq 0$ ) has order at least  $p^r$  in  $\mathcal{M}/\mathcal{M}_s$  for all  $s > d_p(x) + 3(p-1)(r-1)$ . In particular  $x$  has infinite order in  $\mathcal{M}/\mathcal{M}_\infty$ . Furthermore, if  $x$  is robust of depth  $d$ , then it has infinite order in the graded summand  $\mathcal{G}_d = \mathcal{M}_d/\mathcal{M}_{d+1}$ .*

*Proof.* Suppose that  $mx = 0$  in  $\mathcal{M}/\mathcal{M}_s$ . This means that  $mx \in \mathcal{M}_s$  and so  $s \leq d(mx) \leq d_p(mx) = d_p(x) + 3(p-1)v_p(m)$  by properties a) and c) in Lemma 4.8. This leads to a contradiction unless  $m$  is divisible by  $p^r$ . The last statement follows from the first by taking  $r = 1$  and  $p \rightarrow \infty$ .  $\square$

From this theorem, it is apparent that non-triviality results for the filtration on  $\mathcal{M}(M)$  will follow from the existence of suitable elements of finite  $p$ -depth. This existence is guaranteed, at least for  $M$  of finite  $p$ -depth, by the following

**Theorem 4.14.** (existence) *For any 3-manifold  $M$ , there exist elements  $x_k$  in  $\mathcal{M}_{3k}(M)$  for each positive  $k$  such that  $d_p(x_k) = d_p(M) + 3k$  for every prime  $p > 3$ . In particular the  $x_k$  are (strongly) robust if  $M$  is.*

*Proof.* For  $M = S^3$  the elements  $\Delta_k$  constructed in Example 4.12 will do, and for general  $M$ , set  $x_k = M \# \Delta_k$  and apply Lemma 4.8d.  $\square$

One can now deduce a variety of non-triviality results for the filtered group  $\mathcal{M}(M)$  under the mild (and perhaps vacuous) condition that  $M$  — or some manifold  $H_1$ -bordant to  $M$  — have finite  $p$ -depth for some  $p > 3$ . At the least, one would hope that the filtration does not stabilize, or equivalently that  $(\mathcal{M}_\ell/\mathcal{M}_\infty)(M) \neq 0$  for all  $\ell \geq 0$ . In fact it turns out that these groups are all of positive rank (for  $M$  as above), and in fact of infinite rank if  $M$  is normal (i.e. of finite  $p$ -depth for arbitrarily large  $p$ ); this establishes a kind of *rational non-triviality* of the theory for normal manifolds.

One can also investigate how *fast* the filtration descends, measured by the sizes of the associated graded summands  $\mathcal{G}_\ell(M) = (\mathcal{M}_\ell/\mathcal{M}_{\ell+1})(M)$ , and more generally  $(\mathcal{M}_\ell/\mathcal{M}_{\ell+m})(M)$  for a fixed  $m > 0$ . The best results are obtained for robust  $M$ , in which case the associated graded group  $\mathcal{G}(M)$  is of infinite rank; this is a stronger form of rational non-triviality establishing the strict descent of the filtration over the rationals.

These results are summarized in the following

**Corollary 4.15.** (non-triviality) *Let  $M$  be a 3-manifold of finite  $p$ -depth (i.e.  $\tau_p(M) \neq 0$ ) for some prime  $p > 3$ . Then:*

- a) *For every positive integer  $n$ , there exists  $m < \infty$  such that each  $(\mathcal{M}_\ell/\mathcal{M}_{\ell+m})(M)$  has an element of order at least  $n$ .*
- b) *Each  $(\mathcal{M}_\ell/\mathcal{M}_\infty)(M)$  is of rank at least  $p-1$ , and thus of infinite rank if  $M$  is normal.*
- c) *If  $M$  is robust, then each  $\mathcal{G}_{3k}(M)$  has positive rank, and so  $\mathcal{G}(M)$  and  $\mathcal{O}^A(M)$  (with  $A = \mathbb{Z}$  or  $\mathbb{Q}$ ) are of infinite rank.<sup>†</sup>*

---

<sup>†</sup>To prove that  $\text{rk}(\mathcal{G}(M))$  is infinite, it is only necessary to assume  $d_p(M)$  is uniformly bounded for infinitely many  $p$ , but we do not know any examples of this which do not also satisfy the stronger condition of robustness.

*Proof.* For a), choose  $r$  and  $k$  with  $p^r \geq n$  and  $3k \geq \ell$ . Then the element  $x_k$  from Theorem 4.14 lies in  $\mathcal{M}_{3k}(M) \subseteq \mathcal{M}_\ell(M)$  and is of  $p$ -depth  $d_p(M) + 3k \geq d_p(M) + \ell$ . By Theorem 4.13,  $x_k$  has order at least  $n$  in  $(\mathcal{M}_\ell/\mathcal{M}_s)(M)$  for any  $s > d_p(M) + \ell + 3(p-1)(r-1)$ , so any  $m > d_p(M) + 3(p-1)(r-1)$  will satisfy the required condition.

For b), it suffices to show that  $x_\ell, \dots, x_{\ell+p-2}$  (provided by 4.14) are linearly independent in  $(\mathcal{M}_\ell/\mathcal{M}_\infty)(M)$ , or equivalently that any nontrivial integer linear combination  $c = \sum a_k x_k$  (summed over  $\ell \leq k \leq \ell + p - 2$ ) does *not* lie in  $\mathcal{M}_\infty(M)$ . Since  $\tau_p$  is analytic (4.3), it is enough to show that  $\tau_p(c) = \sum a_k \tau_p(x_k)$  is a non-zero element in the cyclotomic ring  $\Lambda_p$ .

It can be assumed that the coefficients  $a_k$  have no common factor. Choose the first one  $a_m$  which is prime to  $p$ . Now observe that each  $x_k$  has  $p$ -order  $k + n$ , where  $n = \mathfrak{o}_p(M)$ , and so can be written in the form  $b_k h^{k+n} + O(h^{k+n+1})$  with  $b_k$  prime to  $p$ . Since  $p$  is divisible by  $h^{p-1}$  in  $\Lambda_p$ ,  $\tau_p(c)$  can be written in the form  $a_m b_m h^{m+n} + O(h^{m+n+1})$ . Thus  $\tau(c)$  has  $p$ -order  $m + n$ , since  $a_m b_m$  is prime to  $p$ , and so in particular is non-zero.

For c), note that  $x_k$  is robust (by 4.14) and so of infinite order in  $\mathcal{G}_{3k}(M)$  (by 4.13). Thus  $\text{rk}(\mathcal{G}_{3k}(M)) > 0$ , and so  $\mathcal{G}(M) = \bigoplus \mathcal{G}_\ell(M)$  and  $\mathcal{O}^A(M) \cong \text{Hom}(\mathcal{G}(M), A)$  (since  $A = \mathbb{Z}$  or  $\mathbb{Q}$ ) both have infinite rank.  $\square$

In the preceding proof, a key role is played by the connected sum of  $M$  with elements in  $\mathcal{M}(S^3)$ . There is a convenient way to formalize this which sheds light on the relationship between the theory of finite type invariants for homology spheres and the theory for manifolds which are  $H_1$ -bordant to  $M$ . Indeed, it will be shown below that for “most”  $M$ , this theory exhibits all of the complexity of finite type invariants of homology spheres which come from “sl(2)-weight systems”, namely Ohtsuki’s rational valued invariants  $\lambda_0, \lambda_1, \lambda_2, \dots$  [O1].

For a fixed 3-manifold  $M$ , consider the embedding

$$i : \mathcal{M}(S^3) \hookrightarrow \mathcal{M}(M)$$

given by  $i(\Sigma) = M \# \Sigma$ . Clearly  $i$  respects the filtration on  $\mathcal{M}$ ,<sup>†</sup> and therefore

<sup>†</sup>This means that  $i$  does not decrease depth; however in some instances  $i$  may increase depth. For example for  $M = S^1 \times S^2$ , the depth of  $i(2\Delta) = 2((S^1 \times S^2) - (S^1 \times S^2) \# P)$  is at least 4 (but no greater than 5 by Lemma 4.8), while  $2\Delta$  has depth 3. Indeed it is shown in §5 that  $\mathcal{M}(S^1 \times S^2)$  has *no* (even) elements of depth 3.

induces a map

$$i_* : (\mathcal{M}/\mathcal{M}_\infty)(S^3) \rightarrow (\mathcal{M}/\mathcal{M}_\infty)(M)$$

and  $A$ -module maps

$$i^* : \mathcal{O}^A(M) \rightarrow \mathcal{O}^A(S^3)$$

for each ring  $A$ . Explicitly  $i_*[x] = [M\#x]$  (where  $[x]$  denotes the coset  $x + \mathcal{M}_\infty$ ) and  $i^*(\phi)(x) = \phi(M\#x)$ .

It is an interesting (and presumably difficult) problem to determine when  $i_*$  is injective, and when  $i^*$  is surjective. Injectivity of  $i_*$  would mean that elements of finite depth in  $\mathcal{M}(S^3)$  are never mapped to elements of infinite depth in  $\mathcal{M}(M)$ . In particular if two homology spheres were distinguished by some finite type invariant (say with values in  $A$ ) then some other finite type invariant (possibly with different values) would distinguish their connected sums with  $M$ . The surjectivity of  $i^*$  would show that the latter could be chosen with values in  $A$ . Also, if surjectivity were known for  $A = \mathbb{Z}$  and all prime power cyclic groups, then the injectivity of  $i_*$  would follow.

Now observe that if  $\tau_p(M) \neq 0$ , then  $i$  maps elements of finite  $p$ -depth in  $\mathcal{M}(S^3)$  to elements of finite  $p$ -depth (and therefore finite depth) in  $\mathcal{M}(M)$  (by Lemma 4.8d), or put differently, if a pair of (linear combinations of) homology spheres can be distinguished by  $\tau_p^d$  for some  $d$  then so can their connected sums with  $M$ , using a possibly larger choice for  $d$ . It follows that  $\ker(i_*)$  lies in the set  $\mathcal{Q}_p$  of all classes in  $(\mathcal{M}/\mathcal{M}_\infty)(S^3)$  of *infinite  $p$ -depth*, that is

$$\mathcal{Q}_p \equiv \{[x] \mid d_p(x) = \infty\},$$

and this can be used to show that if  $M$  is *normal* then  $\ker(i_*)$  lies in the set  $\mathcal{Q}$  of all classes of *infinite Ohtsuki depth*,

$$\mathcal{Q} \equiv \{[x] \mid \lambda_j(x) = 0 \text{ for all } j \geq 0\}.$$

With a little more work, one can show (for suitable  $M$ ) that  $\text{im}(i^*)$  contains the subspace  $\mathcal{O}^p$  of  $\mathbb{Z}_p$ -valued homology sphere invariants generated by the mod  $p$  reductions of the first  $(p-1)/2$  Ohtsuki invariants,

$$\mathcal{O}^p \equiv \text{span}\{\lambda_j \bmod p \mid j = 0, \dots, n\}$$

where  $n = (p-3)/2$ . These results, summarized below, provide evidence for the injectivity of  $i_*$  and the surjectivity of  $i^*$ .



**Corollary 4.16.** *Let  $M$  be a 3-manifold of finite  $p$ -depth, and consider the maps  $i_*$  and  $i^*$  (as above) induced by taking connected sums with  $M$ . Then:*

- a)  $\ker(i_*) \subseteq \mathcal{Q}_p$ , the set of classes of infinite  $p$ -depth (defined above).
- b)  $\text{im}(i^*) \supseteq \mathcal{O}^p$  provided  $M$  is of minimal  $p$ -depth in its  $H_1$ -bordism class.
- c) *If  $M$  is normal then  $\ker(i_*) \subseteq \mathcal{Q}$ , the set of classes of infinite Ohtsuki depth (defined above). In particular, if  $\Sigma_1$  and  $\Sigma_2$  are homology spheres that can be distinguished by the (rational valued) Ohtsuki invariants, then  $M\#\Sigma_1$  and  $M\#\Sigma_2$  can be distinguished by the invariants  $\tau_p^d$  for some  $p$ .<sup>†</sup>*

*Proof.* As remarked above a) is immediate from the additivity of  $p$ -depth (Lemma 4.8d), and c) follows since  $\mathcal{Q} \supseteq \cap \mathcal{Q}_p$  (where the intersection is over all  $p$  for which  $\tau_p(M) \neq 0$ ) when  $M$  is normal. To see this, recall that  $\tau_p^d(x) \equiv \lambda_d(x) \pmod{p}$  for large  $p$  [O1]. Now if  $[x] \in \cap \mathcal{Q}_p$ , then  $\tau_p(x) = 0$  for arbitrarily large  $p$  (since  $M$  is normal) and so all the Ohtsuki invariants of  $x$  vanish. For the last statement in c), consider the difference  $\Sigma_1 - \Sigma_2$ .

It remains to prove b). Let  $m = \mathfrak{o}_p(M)$ , the  $p$ -order of  $M$ . Then  $\mathfrak{o}_p(N) \geq m$  for every manifold  $N \in \mathcal{S}(M)$ , the bordism class of  $M$ , since  $\mathfrak{b}_p$  is constant on  $\mathcal{S}(M)$ . It follows that  $\tau_p(N)$  can be expressed *uniquely* as a polynomial  $\sum_{j=0}^{p-2} c_j(N)h^{m+j}$  with integer coefficients. Reducing mod  $p$  gives a family of invariants

$$t^j : \mathcal{S}(M) \rightarrow \mathbb{Z}_p$$

defined by  $t^j(N) = c_j(N) \pmod{p}$ . Observe that  $t^j$  can be identified with the invariant  $\tau_p^{m+j}$  under the natural inclusion  $\mathbb{Z}_p \hookrightarrow \mathbb{Z}_{p^k}$  (where  $k = \lfloor (m+j)/(p-1) \rfloor + 1$ ) and so is of finite type by Theorem 4.2. One specific case is for  $M = S^3$  and  $m = 0$ , and then the  $t^j$  are the just the mod  $p$  reductions of Ohtsuki's invariants  $\lambda_j$  for  $0 \leq j \leq n$  [O1]. Let us continue to use  $\lambda_j$  to denote these so as to avoid confusion. Then it suffices to show that  $\{\lambda_j\}$  lie in the span of  $\{i^*t^j\}$  for  $0 \leq j \leq n$ .

We compute  $i^*(t^k)(x) = t^k(M\#x) = \sum_{j=0}^{p-2} t^j(M)\lambda_{k-j}(x)$ . Since  $p$  and  $M$  are fixed, the constants  $c^j = t^j(M)$  satisfy  $i^*(t^k) = \sum_{j=0}^{p-2} c^j \lambda_{k-j}$  for

<sup>†</sup>By contrast, the [LMO] invariant, which includes the Lescop invariant as its degree 1 term, cannot distinguish any  $M\#\Sigma_1$  from  $M\#\Sigma_2$  if  $\mathfrak{b}_1(M)$  is positive.

$0 \leq k \leq n$ . Since  $\mathfrak{o}_p(M) = m$ , the lowest order coefficient  $c^0$  is invertible in  $\mathbb{Z}_p$ . It follows that this system of equations can be inverted, and so  $\{\lambda_j\}$  lie in the span of  $\{i^*t^j\}$ .  $\square$

The theory  $\mathcal{O}(M)$  of finite type invariants on certain  $H_1$ -bordism classes  $\mathcal{S}(M)$  also has connections with theory of Vassiliev invariants of knots. We illustrate this for  $M = S^1 \times S^2$ . Consider the set  $\mathcal{K}$  of isotopy classes of knots in  $S^3$  and the map  $\mathcal{K} \xrightarrow{\psi} \mathcal{S}(S^1 \times S^2)$  which sends a knot  $K$  to the homology  $S^1 \times S^2$  obtained by performing 0-surgery on  $K$ . Composition with any invariant of homology  $S^1 \times S^2$ 's yields an (unoriented) knot invariant. In fact we have:

**Proposition 4.17.** *The map  $\psi : \mathcal{K} \rightarrow \mathcal{S}(S^1 \times S^2)$  given by 0-surgery induces an algebra homomorphism*

$$\psi^* : \mathcal{O}_\ell(S^1 \times S^2) \rightarrow \mathcal{V}_\ell$$

*from finite type invariants for homology  $S^1 \times S^2$ 's to Vassiliev invariants of degree at most  $\ell$  (both with values in a fixed ring  $A$ ).*

*Proof.* Crossing changes on a knot  $K$  may be achieved by performing  $\pm 1$  surgery on circles (trivial in  $S^3$ ) which link  $K$  zero times. The collection of  $\ell + 1$  “crossing change circles” forms an admissible link in the 0-surgered manifold.  $\square$

It is an interesting question to characterize the image of  $\psi^*$ .

**Proposition 4.18.** *The image of  $\psi^*$  contains all of the Vassiliev invariants arising from the coefficients of the Conway polynomial. Moreover, the  $\mathbb{Z}_5$  invariants  $\psi^*(\tau_5^d)$  distinguish the right and left-handed trefoil knots, and so the image of  $\psi^*$  is not just the algebra generated by the Conway coefficients.*

*Proof.* The first statement is obvious given the definition of the Conway polynomial of a manifold as in section 3. The second statement is a calculation done in [KM].  $\square$

We conclude with an application of the basic properties of robust elements to show how to construct “interesting” degree 3 lifts of the Casson-Walker invariant  $\lambda$ .

**Theorem 4.19.** *Fix a “base manifold” in each robust  $H_1$ -bordism class of 3-manifolds of positive first betti number. Then there exists a finite type invariant  $\tilde{\lambda} : \mathcal{M} \rightarrow \mathbb{Q}$  of degree 3 which satisfies*

- a)  $\tilde{\lambda}$  is a “lift” of the Casson-Walker invariant, that is  $\tilde{\lambda}(\Sigma) = \lambda(\Sigma)$  for any rational homology sphere, and
- b)  $\tilde{\lambda}$  detects homology sphere summands in all other robust  $H_1$ -bordism classes, that is  $\tilde{\lambda}(M\#\Sigma) = \lambda(\Sigma)$  for each chosen base manifold  $M$  and (integral) homology sphere  $\Sigma$ .

*Proof.* Set  $\tilde{\lambda} = \lambda$  on all  $H_1$ -bordism classes of rational homology spheres, and  $\tilde{\lambda} = 0$  on all non robust classes. Now consider a robust class of positive first betti number, with chosen base manifold  $M$ . It suffices to construct a map  $\tilde{\lambda} : (\mathcal{M}/\mathcal{M}_4)(M) \otimes \mathbb{Q} \rightarrow \mathbb{Q}$  satisfying b). To do this, we choose a basis for  $(\mathcal{M}/\mathcal{M}_4)(M) \otimes \mathbb{Q} \cong \bigoplus_{i=0}^3 (\mathcal{G}_i(M) \otimes \mathbb{Q})$  containing  $M$  (which generates  $\mathcal{G}_0$ ) and  $M\#\Delta$  (which represents a non-zero element in  $\mathcal{G}_3$  by 4.13); here  $\Delta$  is the robust element  $S^3 - P$  in  $\mathcal{M}(S^3)$  of depth 3 discussed in Example 4.12, and so  $M\#\Delta$  is also robust of depth 3 by 4.10a. Now define  $\tilde{\lambda}(M\#\Delta) = -1$ , and  $\tilde{\lambda} = 0$  on all other basis elements (including  $M$ ). Then  $\tilde{\lambda}(M\#\Sigma) = \tilde{\lambda}(M\#(\Sigma - S^3))$  for any integral homology sphere  $\Sigma$ . But  $\Sigma - S^3$  is known to be of depth at least 3, and in fact  $\Sigma - S^3 = \lambda(\Sigma) \cdot (P - S^3) = -\lambda(\Sigma)\Delta$  in  $\mathcal{G}_3$  [O2]. Hence  $\tilde{\lambda}(M\#\Sigma) = -\lambda(\Sigma)\tilde{\lambda}(M\#\Delta) = \lambda(\Sigma)$  as desired.  $\square$

We now return to the key result:

**Lemma 4.7.** (*p*-order bound) *If  $x \in \mathcal{M}_\ell$ , then  $3\mathfrak{o}_p(x) \geq n\mathfrak{b}_p(x) + \ell$  for any odd prime  $p = 2n + 3$ .*

Before giving the proof, it is useful to review the definition of the quantum  $\mathrm{SO}(3)$  invariant  $\tau_p$ . Recall from [KM] the *p*-bracket  $\langle L \rangle = \sum [k] J_{L,k}$  of a framed link  $L$  in  $S^3$ , a certain linear combination of colored Jones polynomials which is invariant under “handle-slides” [Ki]. It is a priori an integral Laurent polynomials in an indeterminate  $t$ , but is to be viewed as an element of the cyclotomic ring  $\mathbb{Z}(q)$  (where  $q$  is a primitive  $p^{\mathrm{th}}$  root of unity) by identifying  $t$  with  $q^{4^*}$  where  $4^*$  is any mod  $p$  inverse of 4. The *p*-bracket

can also be written in terms of Ohtsuki's version  $\phi$  of the Jones polynomial as

$$\langle L \rangle = \sum_{c=0}^n (a|c) \phi_{L^c}$$

(see Proposition 1.5 in [CM1]). Here  $a = (a_1, \dots, a_\ell)$  is a multi-index of integers recording the framings of the components of  $L$ ,  $c = (c_1, \dots, c_\ell)$  is a multi-index cabling for  $L$  with associated cable  $L^c$ , obtained by replacing each component  $L_i$  of  $L$  with  $c_i$  zero-framed push-offs, and the sum is over all cables with  $0 \leq c_i \leq n$ . The reader is referred to [CM1] for the precise definition of  $\phi$  and the coefficients  $(a|c) = \prod_{i=1}^{\ell} (a_i|c_i)$ , which are all to be viewed as elements of  $\Lambda_p$ .

Now to obtain a 3-manifold invariant, one must normalize the  $p$ -bracket to make it invariant under ‘‘blow-ups’’ [Ki]. This is achieved by dividing by a factor which depends only on the linking matrix of  $L$ . In fact there is some flexibility in the choice of this factor according to what properties one wishes the quantum invariant to have. The most common choice is  $b_{+1}^{\ell_+} b_{-1}^{\ell_-} b_0^{\ell_0/2}$ , where  $b_a$  is the  $p$ -bracket of the  $a$ -framed unknot,  $\ell_+$  and  $\ell_-$  are the number of positive and negative eigenvalues of the linking matrix of  $L$ , and  $\ell_0$  is its nullity (or equivalently the first betti number of  $S_L^3$ ). This leads to an invariant  $\tau'_p$  which is *multiplicative* under connected sums and *involution* (with respect to  $t \mapsto \bar{t} = t^{-1}$ ) under orientation reversal [KM]. However because of the square root  $b_0^{1/2}$  this invariant does not in general take values in  $\Lambda_p$  but rather in  $\Lambda_{4p} = \Lambda_p[i]$  where  $i^2 = -1$ , and this obscures some of its number theoretic properties. For the present purposes it is more convenient to define the  $p$ -norm of  $L$  to be

$$|L| = b_{+1}^{\ell_+} b_{-1}^{\ell_-} b_0^{\ell_0} / h^{n\ell_0}$$

where  $h = q - 1 = t^4 - 1$  (in contrast with [CM1] where  $h = t - 1$ ). We will need the fact that

$$|L| = (a|0) \quad \text{if } M \text{ is admissible.} \tag{1}$$

This is an easy consequence of the definitions in [CM1].

Now set

$$\tau_p(S_L^3) = \langle L \rangle / |L|.$$

It is easily seen, using the well known fact that  $b_0$  is a unit times  $h^{2n}$ , that  $|L|$  is an element of  $\Lambda_p$ . In fact  $|L|$  is a divisor of  $\langle L \rangle$  [M2] [MR] (see also [CM1] where a stronger result is proved) and so  $\tau_p$  takes values in  $\Lambda_p$ . Evidently  $\tau_p$  is multiplicative under connected sums, and with this normalization  $\tau_p(S^3) = 1$  and  $\tau_p(S^2 \times S^1) = h^n$ . Unfortunately  $\tau_p$  is no longer involutive; indeed  $S^2 \times S^1$  is amphicheiral, while  $h^n \neq \bar{h}^n$  is not real. (Note that  $\tau_p$  and  $\tau'_p$  differ by a unit in  $\Lambda_{4p}$ . In particular they have the same  $p$ -order, cf. the discussion in [CM1].)

*Proof of Lemma 4.7.* First observe that it suffices to prove the result for generators  $M_{\delta L}$  ( $= [M, L]$ ) where  $L$  is an  $\ell$ -component admissible link in  $M$ . Indeed any  $x \in \mathcal{M}_\ell$  can be written as a sum  $\sum n_i x_i$  where  $x_i = [M_i, L_i]$  and  $L_i$  has  $\ell$  components. Suppose that we proved the lemma for the generators  $x_i$ , that is to say  $3\mathfrak{o}_p(x_i) - n\mathfrak{b}_p(x_i) \geq \ell$  for all  $i$ . Since  $\mathfrak{o}_p(x)$  is the minimum  $d$  for which  $\tau_p^d(x) \neq 0$ , some  $\tau_p^{\mathfrak{o}_p(x)}(x_i) \neq 0$ , which implies  $\mathfrak{o}_p(x_i) \leq \mathfrak{o}_p(x)$  for some  $i$ . Hence  $d_p(x) \geq 3\mathfrak{o}_p(x_i) - n\mathfrak{b}_p(x_i)$  for some  $i$ . But  $\mathfrak{b}_p(x) \leq \mathfrak{b}_p(x_i)$  for all  $i$  so  $d_p(x) \geq 3\mathfrak{o}_p(x_i) - n\mathfrak{b}_p(x_i) \geq \ell$ . It follows that  $d_p(x) \geq d(x)$ . So we may assume that  $x = M_{\delta L}$ .

*Case 1:* Suppose that  $M = S^3_J$  for some *diagonal* framed link  $J$  (i.e. all pairwise linking numbers vanish). Then  $\mathfrak{b}_p(M) = j_p$ , the number of components in the sublink  $J_p$  of  $J$  consisting of all  $J_i$  with framings  $a_i$  divisible by  $p$ . We must show that

$$3\mathfrak{o}_p(S^3_{J \cup \delta L}) \geq nj_p + \ell. \quad (2)$$

By definition  $\mathfrak{o}_p(S^3_{J \cup \delta L})$  is the  $p$ -order of

$$\begin{aligned} \tau_p(S^3_{J \cup \delta L}) &= \sum_{S < L} (-1)^s \tau_p(S^3_{J \cup S}) \\ &= \sum_{S < L} (-1)^s \sum_{c, c_{L-S}=0} (a_{J \cup S} | c_{J \cup S}) \phi_{(J \cup S)^{c_{J \cup S}}} / |J \cup S| \end{aligned}$$

where  $a_T$  and  $c_T$  denote the restrictions of (multi-index) framings  $a$  and cablings  $c$  of  $J \cup L$  to a sublink  $T$  of  $J \cup L$ . (Thus the inner sum is over all cablings  $c$  of  $J \cup L$  with  $c_{L-S} = 0$ , or effectively cablings of  $J \cup S$ .) But

if  $c_{L-S} = 0$ , then  $(a_{J \cup S} | c_{J \cup S}) = (a|c)/(a_{L-S}|0) = (a|c)/|L-S|$ , by (1). Substituting this into the last displayed expression gives

$$\sum_{S < L} (-1)^s \sum_{c, c_{L-S}=0} (a|c) \phi_{(J \cup S)^c} / |J \cup L| \quad (3)$$

since clearly  $|J \cup S||L-S| = |J \cup L|$ . Now this sum can be rewritten as a sum over *all* cablings  $c$  of  $J \cup L$ ,

$$\sum_c (-1)^{\#c_L} \left( \sum_{k=0}^m (-1)^k \binom{m}{k} \right) (a|c) \phi_{(J \cup L)^c} / |J \cup L|$$

where  $\#c_L$  is the number of components of  $L$  whose cabling index is positive (the *support* of  $c_L$ ) and  $m = \ell - \#c_L$ . Indeed the number of times  $(J \cup L)^c$  occurs in (3) is computed by fixing  $c$  and counting how many  $S$ 's there are which contain the support of  $c_L$ , and the number of such  $S$ 's with  $\#c_L + k$  components is clearly  $\binom{m}{k}$ . Finally, noting that the inner sum of signed binomial coefficients vanishes unless  $m = 0$  (i.e.  $\ell = \#c_L$ , whence  $c_L \geq 1$ ) we have

$$\tau_p(S_{J \cup \delta L}^3) = \sum_{c, c_L \geq 1} (-1)^\ell (a|c) \phi_{(J \cup L)^c} / |J \cup L|. \quad (4)$$

A lower bound for the  $p$ -order of  $\tau_p(S_{J \cup \delta L}^3)$  can now be obtained easily from the results of [CM1]. It is shown there (Propositions 3.6 and 3.7) that  $\mathfrak{o}_p(a|c) \geq n(j + j_p + \ell) - |c| - |c|_p$ , where  $|c| = \sum c_i$  is the total number of cables of  $c$ , and  $|c|_p$  is the total number of cables of the sublink  $J_p$  (of components of  $J$  with framings divisible by  $p$ ). Also  $\mathfrak{o}_p(\phi_{(J \cup L)^c}) \geq 4|c|/3$  (Theorem 3.5, which follows from a result of Kricker and Spence [KS]), and  $\mathfrak{o}_p|J \cup L| = n(j + \ell)$  (Proposition 3.11). Hence any term in the sum (4) has order at least  $nj_p + |c|/3 - |c|_p$ . This clearly achieves its minimum value when  $c_{J_p} = n$ ,  $c_{J-J_p} = 0$  and  $c_L = 1$ , and this value is then  $nj_p + (nj_p + \ell)/3 - nj_p = (nj_p + \ell)/3$ . This proves (2).

*Case 2:* Consider an arbitrary  $M_{\delta L}$ . We must show  $3\mathfrak{o}_p(M_{\delta L}) \geq n\mathfrak{b}_p(M) + \ell$ . By Corollary 2.3 of [M2], there exists a  $\mathbb{Z}/p\mathbb{Z}$ -homology sphere  $\Sigma$  such that  $M \# \Sigma$  can be obtained by surgery on a diagonal link, and so  $3\mathfrak{o}_p(M_{\delta L} \# \Sigma) \geq n\mathfrak{b}_p(M) + \ell$  by the previous case. But  $\mathfrak{o}_p$  is additive under connected sums, since  $\tau_p$  is multiplicative, and the main theorem of [M2] shows that  $\mathfrak{o}_p(\Sigma) = 0$ . Thus  $\mathfrak{o}_p(M_{\delta L}) = \mathfrak{o}_p(M_{\delta L} \# \Sigma)$  and the lemma is proved.  $\square$

## 5 Combinatorial structure of finite type invariants

In this section we describe an epimorphism from a finitely generated group of *Feynman diagrams* (trivalent graphs/relations) to the graded group  $\mathcal{G}_\ell(M)$ . We then use this to evaluate a few examples for small values of  $\ell$ . We show that for many  $M$ , the kernel of this epimorphism is larger than one might naively predict based on the theory for homology spheres [GO2], that is, there are relations in the group of graphs which are not captured by the “standard” IHX and AS relations.

For each  $m \geq 0$ , we describe a set  $G^m$  of admissible abstract graphs. Feynman diagrams will be defined below as certain equivalence classes of linear combinations of elements of  $G^m$ .

**Definition 5.1.** An  $m$ -admissible graph  $\Gamma$  is a finite 1-dimensional cell complex whose edge set is partitioned into the *colored* edges  $\mathcal{J} = \mathcal{J}_1 \cup \dots \cup \mathcal{J}_m$  (where each  $\mathcal{J}_i$  is nonempty with edges colored by the number  $i$ ) and the *white* edges  $\mathcal{L}$ , and whose trivalent vertices are equipped with a vertex *orientation* (an ordering of its incident edges up to cyclic permutation), subject to the following conditions:

- a) Each vertex is of valence 1 or 3.
- b) Each edge has distinct vertices.
- c) Each trivalent vertex is incident to at least one white edge, and to at most one colored edge of any given color.
- d) Each colored edge has at least one univalent vertex, and if it has two such vertices (i.e. if it is *isolated*), then it is the only edge of that color.

The edges with at least one univalent vertex will be called *external*, while those with none will be called *internal*. The graph is said to be *closed* if all of its white edges are internal.

**Definition 5.2.** Let  $G^m$  be the set of all  $m$ -admissible graphs, and  $\mathcal{D}^m$  be the free abelian group on  $G^m$ . The *degree* of  $\Gamma \in G^m$  is the number of white edges in  $\Gamma$ , that is, the cardinality of  $\mathcal{L}$ . Let  $\mathcal{D}_\ell^m$  be free abelian group on the degree  $\ell$  elements  $G_\ell^m$  of  $G^m$ . Note that  $G_\ell^m$  is a finite set. Finally let  $\mathcal{C}_\ell^m$  denote the subgroup of  $\mathcal{D}_\ell^m$  spanned by all closed graphs of degree  $\ell$ .

Choose a base manifold  $M$  in each  $H_1$ -bordism class and choose a framed link description  $M = S_J^3$  where  $m$  (for *manifold*) denotes the number of components of  $J$ . Rational surgery framings are allowed. We note in passing that  $J$  may be chosen to be fairly simple. For example, if  $H_1(M)$  is torsion-free then  $J$  can be chosen to be 0-framed and “special” (in the sense of 2.10) in that it can be obtained from a trivial link by “Borromean replacements” [CGO]. We define a map  $\psi_J$  below and observe that the proof of 2.1 shows it is a surjection.

**Theorem 5.3.** *For any (rationally) framed  $m$ -component link  $J$  for which  $M = S_J^3$ , as above, there is an associated epimorphism  $\psi_J : \mathcal{D}_\ell^m \rightarrow \mathcal{G}_\ell(M)$ .*

*Proof.* For each  $\Gamma \in G_\ell^m$ , choose an immersion  $\Gamma \looparrowright D^2$  whose double points avoid vertices (for a slight technical advantage we choose an over-crossing edge at each double point) and such that each colored edge has one of its vertices on  $\partial D^2$ . Associate to this an unoriented tangle  $T(\Gamma)$  in a 3-ball  $B_1$  by the rules shown in Figure 5.4 (as in [O2]) in such a way that each edge of  $\Gamma$  corresponds to a single component of the tangle with corresponding color when appropriate. This must be done in such a way that the local orientations at the trivalent vertices can be extended to a global orientation of the tangle. This explains the choice 5.4a or b.

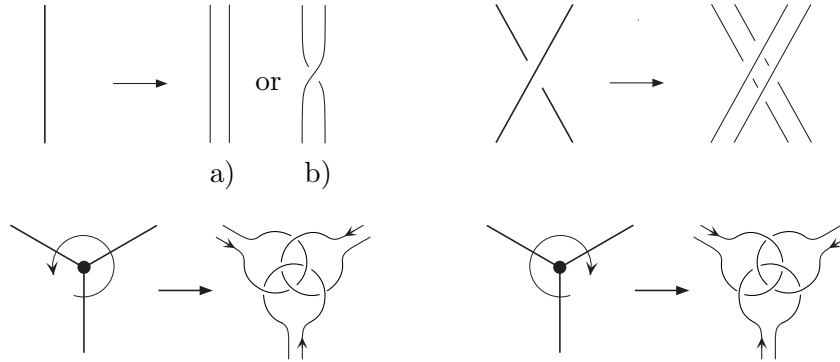

Figure 5.4:  $\Gamma \rightarrow L(\Gamma)$

Give each white component of  $L(\Gamma)$  a +1 framing. Let  $b_i$  be the cardinality of  $\mathcal{J}_i$ . Choose a 3-ball  $B_2$  in  $S^3$  for which the complementary tangle



$(S^3 - \text{int}B_2, (S^3 - \text{int}B_2) \cap J)$  is trivial and contains  $b_i$  subarcs from the single link component  $J_i$ . Then  $(B_1, T(\Gamma))$  may be glued to  $(B_2, B_2 \cap J)$  to form an unordered, unoriented framed link  $J \cup L(\Gamma)$  in  $S^3$  which contains the link  $J$  as sublink. This gluing is not unique.

Now define  $\psi_J : \mathcal{D}_\ell^m \rightarrow \mathcal{G}_\ell(M)$  to be the composition of the homomorphism  $\mathcal{D}_\ell^m \rightarrow \mathcal{M}_\ell(M)$ , which sends  $\Gamma$  to  $M_{J \cup \delta L(\Gamma)}$ , with the natural projection  $\mathcal{M}_\ell(M) \rightarrow \mathcal{G}_\ell(M)$ . (Recall from §1 that  $\delta$  assigns to a framed link in  $M$  the formal alternating sum of its sublinks.) It follows from the proof of Theorem 2.1 that  $\psi_J$  is surjective.

Observe that the map  $\psi_J$  does not depend on the immersion of  $\Gamma$  since a “band pass” leads to equal elements in  $\mathcal{G}_\ell$  (cf. [O2]). For a similar reason it does not depend on the glueing homeomorphism between  $\partial B_1$  and  $\partial B_2$  except for the information on which components of  $\mathcal{J}_i$  are glued to which spots on  $J_i$ . If  $J$  has zero linking numbers then even the latter does not matter (again by the band-pass move or by the homotopy classification of links with zero linking numbers by their  $\bar{\mu}(ijk)$ ). These statements will be discussed more fully in [CM2]. In any case, it may indeed be more natural to average over all permutations of such glueings, but this will not be needed in the present paper.  $\square$

Next we define a map

$$d : \mathcal{D}_\ell^m \rightarrow \mathcal{D}_\ell^m$$

which is an extension of the “deframing map” of [GO2]. For an admissible graph  $\Gamma$  and any subset  $S$  of the set  $T$  of all trivalent vertices in  $\Gamma$ , let  $\Gamma_S$  denote the admissible graph obtained by “splitting open”  $\Gamma$  at each vertex in  $S$  (creating  $3s$  new univalent vertices) and deleting any resulting isolated colored edge (unless it is the only edge with that color). Then set  $d(\Gamma) = \sum_{S \subset T} (-1)^{|S|} \Gamma_S$ . Note that  $d$  is the identity if  $T$  is empty.

**Proposition 5.5.** *The deframing map  $d$  is an isomorphism.*

*Proof.* The reader can verify that  $d$  is its own inverse.  $\square$

In the remainder of this section we use the convention of [GO2] that a trivalent vertex of a graph  $\Gamma$  lying in the *domain* of the deframing map be denoted as in Figure 5.6a by a “white vertex,” whereas for  $\Gamma$  lying in the *range* it will be denoted by a “black vertex” as in 5.6b.

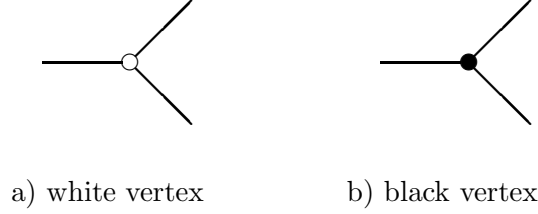

Figure 5.6

We now identify five classes of relations on  $\mathcal{D}_\ell^m$  which lie in the kernel of the composition of  $\phi_J$  with the deframing map: AS (*antisymmetry*), S (*symmetry*), IHX, Y (an integrality relation between Y-shaped graphs and closed graphs), and I (*isolated edge*).

**Theorem 5.7.** *The composition  $\psi_J \circ d$  factors through an epimorphism  $\phi_J : \mathcal{D}_\ell^m / \{\text{AS, S, IHX, I, Y}\} \longrightarrow \mathcal{G}_\ell(M)$*

The relations AS, S, IHX, I and Y are defined in the proof.

**Definition 5.8.** Let  $\overline{\mathcal{D}}_\ell^m \equiv \mathcal{D}_\ell^m / \{\text{AS, S, IHX, I, Y}\}$ . The elements of  $\overline{\mathcal{D}}_\ell^m$  are called *m-Feynman diagrams of degree  $\ell$* .

*Proof of 5.7.* An element of I is a graph  $\Gamma$ , one of whose white edges is isolated. For such a graph we have  $M_{J \cup \delta L(\Gamma)} = 0$  since  $L(\Gamma)$  contains an isolated unknotted component. Since  $d(\text{I}) \subseteq \text{I}$ , it follows that  $\psi_J \circ d(\text{I}) = 0$ .

The *antisymmetry relation* AS is shown in Figure 5.9 and says that the effect of changing the vertex orientation at a single trivalent vertex is the same as negation in  $\mathcal{D}$ , as long as at least one edge incident to that vertex is internal (i.e. ends in another trivalent vertex).

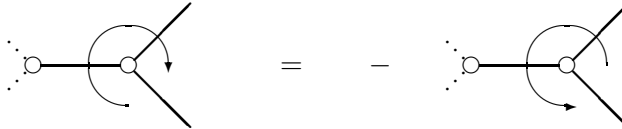

Figure 5.9: Antisymmetry

This is the same as Proposition 2.7 of [GO2], and the proof that  $\psi \circ d(\text{AS}) = 0$  also goes through as in [GO2], the only essential ingredient being the half-twist lemma (2.7). Note that the “marking lemma” (Lemma 2.1 of [GO2])

also holds in the present context, but since “markings” are not part of the structure of an admissible graph (or a Chinese Character in the case of [GO2]) it does not directly indicate relations in  $\mathcal{D}_\ell^m$ .

There are two types of *symmetry relations* S. The first is shown in Figure 5.10 where  $e$  is a *white* edge of  $\Gamma$  with exactly one univalent vertex, and says that changing the vertex orientation of the trivalent vertex of  $e$  does not change the image  $\psi_J \circ d(\Gamma)$ . The proof may be summarized as follows. A change in vertex orientation leads to an insertion of an oppositely oriented Borromean rings, changing a local  $\bar{\mu}(123)$  from 1 to  $-1$ , say. But the same effect on  $\bar{\mu}(123)$  can be achieved by changing the orientation of the component arising from  $e$ . Since these two are (locally) link homotopic, their images in  $\mathcal{G}_\ell$  are identical (see 2.9). But clearly the orientation of a link component does not affect the surgered manifold.



Figure 5.10: Symmetry

The second type of symmetry relation is very similar and has an identical proof. It states that, for any color  $j$ , changing the vertex orientations at every trivalent vertex which is incident to an edge labelled by  $j$  has no effect on  $\psi_J \circ d(\Gamma)$ . This is achieved by changing the orientation on the  $j$ -colored component of  $J$ .

The relation in Figure 5.11 is called the *IHX relation* — assume clockwise vertex orientation in the plane of the picture (see Figure 22 of [GO2]). Note that any of the 4 edges which leave the picture can be colored or not colored. However, the 4 edges leaving the picture must be distinct edges, and no two may be colored alike. This condition ensures that each of the 3 graphs shown in 5.11 is admissible. The proof of this set of relations is quite delicate and will be postponed to [CM2]. The case when none of the edges is colored is due to Garoufalidis and Ohtsuki [GO2].

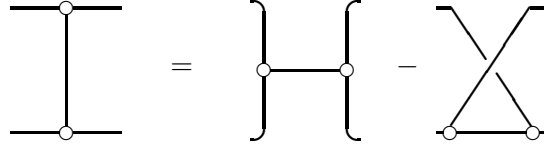

Figure 5.11: The IHX Relation

The *Y relations* are shown in Figure 5.12, with the colored edges drawn in thicker pen for clarity. They are meant to say that if  $\Gamma$  possesses any connected component which is Y-shaped, then  $2\Gamma = \Gamma'$  where  $\Gamma'$  is obtained by replacing the Y-shaped component (as shown) by the corresponding “theta-shaped” closed graph<sup>†</sup> with oppositely oriented trivalent vertices.

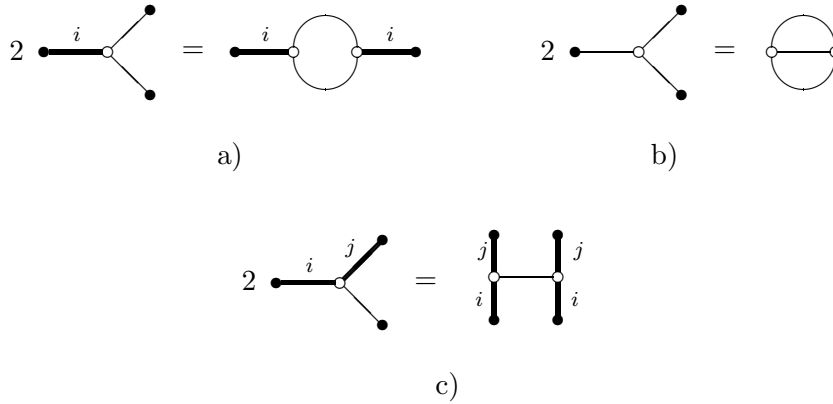

Figure 5.12: Y Relations

A sketch of the proof that  $\psi_J \circ d = 0$  for the case 5.12c is as follows. Consider AS for *one* of the white vertices of the H-shaped graph on the right hand side of the equation. Applying  $\psi_J \circ d$  to this AS relation yields a relation in  $\mathcal{G}_\ell$  wherein one sees two Borromean interactions of opposite sign between the  $i$ ,  $j$  and white component. By link homotopy considerations, as in §2, these can be cancelled and eliminated. The resulting relation in  $\mathcal{G}_\ell$  can then

<sup>†</sup>Note that the left hand side of each equation can be viewed as a half-theta  $\Xi$  and the right hand side as a full theta  $\Theta$  with the colored edges (if any) split open at the middle to conform to the definition of admissible graphs.

be seen to be exactly  $\psi_J \circ d$  applied to 5.12c. The other cases are proved in exactly the same way. A more detailed proof will be included in [CM2].

This completes the proof of Theorem 5.7 (modulo the IHX relations).  $\square$

Recall that  $\mathcal{C}_\ell^m$  is the subgroup of  $\mathcal{D}_\ell^m$  spanned by closed graphs (all white edges are internal). One can speak of relations AS, IHX and S among elements of  $\mathcal{C}_\ell^m$  since these relations respect the defining condition for  $\mathcal{C}$ . The following is then immediate.

**Proposition 5.13.** *Let  $\overline{\mathcal{C}}_\ell^m = \mathcal{C}_\ell^m / \{\text{AS, S, IHX}\}$ . There is a commutative diagram of groups, as below, where the horizontal maps are injective.*

$$\begin{array}{ccc} \mathcal{C}_\ell^m & \hookrightarrow & \mathcal{D}_\ell^m \\ \downarrow & & \downarrow \\ \overline{\mathcal{C}}_\ell^m & \hookrightarrow & \overline{\mathcal{D}}_\ell^m \end{array}$$

One also has,

**Proposition 5.14.** *Let  $\Gamma \in \mathcal{D}_\ell^m$ . Then  $2^\ell \overline{\Gamma} \in \overline{\mathcal{C}}_\ell^m$ , where  $\overline{\Gamma}$  denotes the equivalence class of  $\Gamma$  in  $\overline{\mathcal{D}}_\ell^m$ , and so  $\overline{\mathcal{C}} \otimes \mathbb{Z}[\frac{1}{2}] \cong \overline{\mathcal{D}} \otimes \mathbb{Z}[\frac{1}{2}]$ . It follows that  $\overline{\mathcal{C}}_\ell^m$  is of finite index in  $\overline{\mathcal{D}}_\ell^m$ .*

*Proof.* Suppose  $\Gamma$  has some external white edges. If any one of these is not part of a Y-shaped component, then, by AS and S (of the first type),  $2\overline{\Gamma} = 0$ . On the other hand, if all of these edges lie in Y-shaped components of  $\Gamma$ , then applying the Y relations  $k$  times (where  $k$  is the number of such components) shows that  $2^k \overline{\Gamma} \in \overline{\mathcal{C}}_\ell^m$ . Clearly  $k \leq \ell$ , and so the first statement follows. Since  $\overline{\mathcal{D}}_\ell^m$  is finitely generated, this implies that  $\overline{\mathcal{C}}_\ell^m$  is of finite index.  $\square$

**Corollary 5.15.** *The map  $\phi_J : \overline{\mathcal{C}}_\ell^m \rightarrow \mathcal{G}_\ell(M)$  is an epimorphism after tensoring with  $\mathbb{Z}[\frac{1}{2}]$  or  $\mathbb{Q}$ , and every element of the cokernel of  $\phi_J$  has order dividing  $2^\ell$ .*

We shall see that, unlike the case of homology spheres,  $\phi_J$  is *not* in general a rational isomorphism. In fact  $\overline{\mathcal{C}}_3^1$  has rank one while  $\mathcal{G}_3(S^1 \times S^2)$  has rank zero!

We compute some examples for the reader. Here  $m = 1$ ,  $M = S^1 \times S^2$ , and  $J$  is the 0-framed unknot in  $S^3$ . Recall  $\mathcal{G}_\ell = \mathcal{M}_\ell / \mathcal{M}_{\ell+1}$ . In the chart,  $\mathbb{Z}_{5q}$  represents a non-zero cyclic group of order a multiple of 5 or  $\infty$ .

$\ell$	0	1	2	3	4	5
$\overline{\mathcal{C}}_\ell^1 / 2\text{-torsion}$	$\mathbb{Z}$	0	$\mathbb{Z}$	$\mathbb{Z}$	$\mathbb{Z}^2$	$\mathbb{Z}$
generators	S	–	W	$\Theta$	C, W*W	W* $\Theta$
$\mathcal{G}_\ell(S^1 \times S^2) / 2\text{-torsion}$	$\mathbb{Z}$	0	$\mathbb{Z}$	0	$\mathbb{Z}^2$	$\mathbb{Z}_{5q}$

Figure 5.16:  $\mathcal{G}(S^1 \times S^2)$  in low degrees

Figure 5.17 shows pictures of the generators of  $\overline{\mathcal{C}}_\ell^1 \pmod{2\text{-torsion}}$ . Since  $m = 1$ , we do not need to label the colored components, which are again shown in thicker pen. We shall briefly outline how the table was derived. Let  $\Gamma$  be an element of  $\mathcal{C}_\ell^1$  with  $t$  trivalent vertices and  $c$  non-isolated colored edges. Then it is easily seen that  $3t - c = 2\ell$  by noting that two white edges emanate from each of  $c$  trivalent vertices while three emanate from each of the other  $(t - c)$  trivalent vertices, and that in this calculation each white edge is counted twice.<sup>†</sup> Hence  $2\ell/3 \leq t \leq \ell$ . This simplifies calculations, as does the following observation.

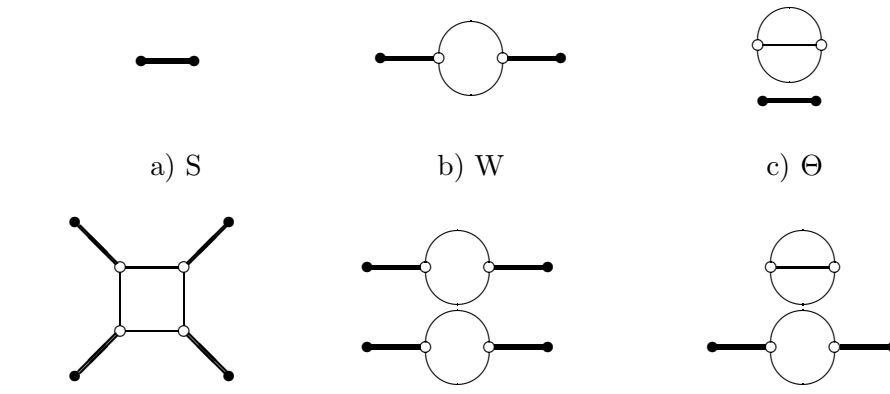

<sup>†</sup>Note that the equation  $3t - c = 2\ell$  recovers the result that, for homology spheres,  $\mathcal{G}_\ell \otimes \mathbb{Q}$  is zero unless  $\ell$  is a multiple of 3 [GL1][GO2].

d) C

e) W\*W

f) W\*Θ

Figure 5.17

**Proposition 5.18.** *If  $\Gamma \in \mathcal{C}_\ell^m$  has an odd number of trivalent vertices then  $2\Gamma = 0$  in  $\overline{\mathcal{C}}_\ell^m$ . More generally, if the number of non-isolated edges of some fixed color  $j$  is odd then  $2\Gamma = 0$ .*

*Proof.* Let  $c_i$  be the number of non-isolated  $i$ -colored edges. The equation  $3t - \sum c_i = 2\ell$  derived above shows that if  $t$  is odd then some  $c_j$  is odd. So it suffices to prove the second claim. Now changing the vertex orientation at each of vertex incident to a  $j$ -colored edge (denoted  $\Gamma^*$ ) is a symmetry. On the other hand,  $\Gamma^* = (-1)^t \Gamma$  by anti-symmetry, since no component of  $\Gamma$  is Y-shaped. Hence,  $2\Gamma = 0$  in  $\overline{\mathcal{C}}_\ell^m$ .  $\square$

Using the above considerations, one is led quite quickly by simple combinatorics to see that  $\overline{\mathcal{C}}_\ell^1$  for  $\ell \leq 4$  is generated by the graphs shown in the chart above. The case  $\ell = 5$  requires more work which we do not include here. It remains to show that W,  $\Theta$ , C and W\*W are of infinite order (and linearly independent) in  $\overline{\mathcal{C}}_\ell^1$ .

First consider the case  $\ell = 2$ . It was shown in §3 that  $\mathcal{G}_2(S^1 \times S^2)$  has a map onto  $\mathbb{Z}$  given by  $C_2$ , the coefficient of  $z^2$  in the Conway polynomial of the manifold. From Figure 5.12a we see that  $W = 2 \cdot Y$  and then one calculates that  $\phi_J(Y)$  is 0-surgery on a trefoil knot minus  $S^1 \times S^2$ . Hence  $C_2(\phi_J(Y)) = 1$ , and the case  $\ell = 2$  is settled.

The case  $\ell = 3$  is the most interesting because here it will be seen that  $\phi_J$  has a non-trivial kernel. First we show that  $\phi_J(\Theta)$  is zero by showing that  $\phi_J$  of the graph  $Y_1$  shown in Figure 5.19a is 2-torsion. We then apply the Y relation in Figure 5.12b to see that  $2Y_1 = \Theta$  in  $\overline{\mathcal{D}}_3^1$ .



Figure 5.19

Consider the framed links  $L_1$  and  $L_2$  in 5.20. These describe homeomorphic 3-manifolds as can be seen by “sliding” the smallest 1-framed circle over the 0-framed circle.

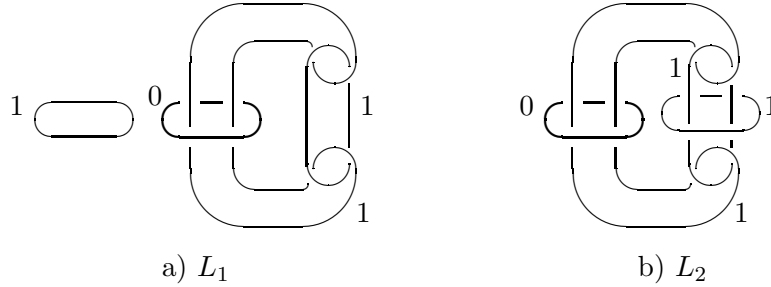

Figure 5.20

The reader can then work out that this implies that  $\phi_J(Y_1) = -\phi_J(Y_2)$ , where  $Y_2$  is the graph shown in 5.19b. But  $Y_2$  is of order 2 by an application of S and AS (see the proof of 5.14). Hence we have shown that  $\phi_J(\Theta) = 0$ .

To show that  $\Theta$  is of infinite order, we use a little trick. Observe that if  $M = L(q, 1)$  and  $J'$  is the  $q$ -framed unknot then  $\phi_{J'} : \overline{\mathcal{C}}_3^1 \rightarrow \mathcal{G}_3(L(q, 1))$  is a rational epimorphism by Corollary 5.15. So if  $\mathcal{G}_3(L(q, 1))$  has rank 1 then we are done. But this follows from 4.15c. This is summarized as follows.

**Proposition 5.21.** *The map  $\phi_J : \overline{\mathcal{C}}_3^1 \rightarrow \mathcal{G}_3^1(S^1 \times S^2)$  is not a rational isomorphism. The graph denoted  $\Theta$  in Figure 5.17 lies in the kernel. (Here  $J$  is the 0-framed unknot).*

So the reader sees that more relations must be added to account for handle slides. We shall not attempt a systematic treatment of this in the present paper.

For the case  $\ell = 4$ , consider the image of  $W*W$  in  $\mathcal{G}_4(S^1 \times S^2)$ . This is of infinite order as detected by  $C_4$ , the coefficient of  $z^4$  in the Conway polynomial; indeed it is represented by the element  $\lambda_4$  of Proposition 3.6. Similarly  $\phi_J(C)$  is the represented by the element  $\hat{\lambda}_4$  introduced in Remark 3.7, and is shown there to be of infinite order (detected by  $C_2^2$ ) and not a multiple of  $\lambda_4$ . Therefore  $\mathcal{G}_4(S^1 \times S^2) = \mathbb{Z}^2$ .

Note that the the linear independence of  $C$  and  $W*W$  in  $\overline{\mathcal{C}}_4^1$  also follows from general principles, according to the following result.



**Theorem 5.22.** *Consider the set  $\mathcal{A}$  of all closed  $m$ -admissible degree  $\ell$  graphs with no vertex orientations (for fixed  $m$  and  $\ell$ ). Let  $\mathcal{E}$  be the subset of  $\mathcal{A}$  consisting of graphs which have an even number of non-isolated edges of each color, and  $\mathcal{O} = \mathcal{A} - \mathcal{E}$ . Let  $\mathcal{C}(\mathcal{E})$  be the free abelian group on  $\mathcal{E}$  and  $\mathcal{C}(\mathcal{O})$  be group generated by  $\mathcal{O}$  with relations  $2\mathcal{O} = 0$ . Then*

$$\overline{\mathcal{C}}_\ell^m \cong \mathcal{C}(\mathcal{E})/\text{IHX} \oplus \mathcal{C}(\mathcal{O})/\text{IHX}$$

where the IHX relations are as before, but restricted to the appropriate set and with suitable sign changes (see the proof).

*Proof.* We sketch a proof. Merely observe that the anti-symmetry relations serve to eliminate generators and eliminate the vertex orientations by choosing one for each abstract graph; one must of course modify the signs in the IHX relations accordingly. The second symmetry relation leads to a tautology if  $\Gamma \in \mathcal{E}$ , or to  $2\Gamma = 0$  if  $\Gamma \in \mathcal{O}$  (see Proposition 5.18).  $\square$

**Corollary 5.23.** *Consider the set  $T$  of all  $\Gamma \in \mathcal{E}$ , each of which is a disjoint union of the closed “theta-shaped” graphs that are the right hand sides of the  $Y$ -relations (Figure 5.12). Then  $T$  is linearly independent in  $\overline{\mathcal{C}}_\ell^m$ . In particular, each such  $\Gamma$  is of infinite order.*

*Proof.* Note that  $\langle \text{IHX} \rangle \subseteq \mathcal{C}(\mathcal{E})$  is clearly contained in the span of those  $\Gamma$  which have some connected component which either has 4 different colors appearing, or has at least 3 trivalent vertices. But the set  $T$  is disjoint from this spanning set.  $\square$

This result can be refined to show  $C$  and  $W*W$  are linearly independent in  $\overline{\mathcal{C}}_4^1$  by observing that  $C$  does not lie in the span of the IHX relation since each embedding of an “I-shaped graph” in  $C$  has two inputs colored alike. This was disallowed in IHX.

Observe that it follows from Corollary 5.23 that  $W*\Theta$  is of infinite order in  $\overline{\mathcal{C}}_5^1$ . In fact  $\phi_J(W*\Theta)$  can be shown to be non-trivial of either infinite order or order a multiple of 5 in  $\mathcal{G}_5(S^1 \times S^2)$  by considering  $\tau_5^2$  of section 4.

## 6 Finite type invariants for spin manifolds

The theory of invariants of finite type for closed spin 3-manifolds was defined in 1.1–1.3 except for explaining how the surgered  $M_S$  inherits a spin structure from a spin structure on  $M$ . The reader can compare the theory of N. Shirokova [Sh]. An invariant of finite type for closed oriented 3-manifolds will be seen, *a fortiori*, to be an invariant of finite type for spin manifolds. In addition the Rochlin invariant is a degree 3 mod 16 invariant of finite type. The theory outlined by Shirokova in [Sh] has neither of these properties. As in §2, we find that the group of invariants is finitely generated within any fixed  $H_1$ -bordism class. In a later paper we hope to investigate the mysterious invariants of spin manifolds arising from quantum invariants as we have done in §4 for the non-spin invariants.

Here  $\mathcal{S}^{\text{Spin}}$  is the set of spin-structure-preserving homeomorphism classes of spin 3-manifolds  $(M, \sigma)$ ,  $\mathcal{M}^{\text{Spin}}$  is the free abelian group on  $\mathcal{S}^{\text{Spin}}$ , and  $\mathcal{M}_\ell^{\text{Spin}}$  is the span of  $[(M, \sigma), L]$  where  $L$  is any admissible link of  $\ell$  components as in §1. It is only necessary to give a precise meaning to  $[(M, \sigma), L]$  by assigning a spin structure to the manifolds  $M_S$  where  $S < L$ .

Given a spin manifold  $M$  and an admissible link  $S$ , there is a convenient way to specify the spin structure induced on  $M_S$  using the language of “characteristic sublinks” (see [KM]; p. 541). Namely, suppose  $M = S_J^3$  and  $J' \subseteq J$  is a characteristic sublink corresponding to the given spin structure on  $M$ . Then the appropriate spin structure on  $M_S$  is the one corresponding to the characteristic sublink  $J' \cup S$ . Note that since each component of  $S$  is  $\pm 1$ -framed and has zero linking numbers with all other components,  $S$  *must* be part of any characteristic sublink. This “framed surgery” language is very convenient for checking whether or not certain diffeomorphisms are actually spin diffeomorphisms since most of the diffeomorphisms we employ are described in terms of the “Kirby calculus.”

If  $A$  is a ring then  $\mathcal{O}^{\text{Spin}}$  is a filtered commutative  $A$ -algebra (as shown in Proposition 2.12). Since the “forgetful map”  $\mathcal{S}^{\text{Spin}} \rightarrow \mathcal{S}$  respects the filtrations, the following is clear.

**Proposition 6.1.** *If  $\phi : \mathcal{S} \rightarrow A$  is a finite type invariant of degree  $\ell$  then  $\phi' : \mathcal{S}^{\text{Spin}} \rightarrow \mathcal{S} \rightarrow A$  (using the forgetful map) is finite type of degree at most  $\ell$ , that is, there is a natural monomorphism  $\mathcal{O} \hookrightarrow \mathcal{O}^{\text{Spin}}$  which is an algebra map.*

Hence  $\mathcal{O}^{\text{Spin}}$  is large. There are also invariants not in the subalgebra  $\mathcal{O}$ .

**Proposition 6.2.** *The Rochlin invariant  $\mu : \mathcal{S}^{\text{Spin}} \rightarrow \mathbb{Z}_{16}$  is a finite type degree 3 invariant.*

*Proof.* Suppose  $(M, \sigma)$  is a spin 3-manifold. We claim that we may assume that  $M$  is obtainable as integral surgery on a link  $J$  in  $S^3$  which has all zero linking numbers. For Murakami has shown that for any  $M$  there exists a connected sum of lens spaces  $X$  such that  $M \# X$  has such a surgery description ([M2], Cor. 2.3). Moreover, if  $L$  is not empty  $\mu([M, L]) = \mu([M \# X, L])$  since the Rochlin invariant is additive under connected sum and  $[M \# X, L]$  is an alternating sum  $[M, L] \# X$ . Thus we can assume  $M = S_J^3$  as above.

Suppose  $J'$  is the characteristic sublink of  $J$  corresponding to the spin structure  $\sigma$  (see [KM]; p. 541–544). Suppose  $L$  is an admissible link of 4 components in  $M$ . By an isotopy in  $M$ , we may assume  $L$  lies in  $S^3 - J$  and has zero linking numbers with each component of  $J$ . This uses the properties of  $J$  and the fact that each component of  $L$  is null-homologous in  $M$ . If  $S < L$  then the characteristic sublink for the spin structure on  $M_S = S_{J \cup S}^3$  is  $C_S = J' \cup S$ , by definition. Recall that the Rochlin invariant of  $(S_{J \cup S}^3, C_S)$  is given by  $\sigma(J' \cup S) - C_S \cdot C_S + 8\text{Arf}(J' \cup S) \pmod{16}$  ([KM]; p. 542). Here  $\sigma$  is the signature of the linking matrix and  $\cdot$  is the total linking number. For brevity denote this  $\mu(M_S)$  by  $\mu(S)$ . We must show that  $\sum_{S < L} (-1)^s \mu(S) = 0$ , in other words that  $\mu(\delta L) = 0$ . Note that  $\sigma(J' \cup S) - C_S \cdot C_S = \sigma(J') + \sigma(S) - J' \cdot J' - \tau(S)$  where  $\tau$  is the trace of the linking matrix of  $S$ . Since the latter matrix is diagonal with  $\pm 1$  entries on the diagonal,  $\sigma(S) = \tau(S)$ . Thus  $\sigma(J' \cup S) - C_S \cdot C_S$  is independent of  $S$  and hence will not contribute to the alternating sum. It remains to show that  $\text{Arf}(J' \cup \delta L) \equiv 0 \pmod{2}$  if  $L$  has 4 or more components. It has been shown by Hoste, Murakami and Sturm that, for any “totally proper” link  $T$  in  $S^3$ ,  $\text{Arf}(\delta T) \equiv a_2(T)$ , the coefficient of  $z^{t+1}$  in the Conway polynomial

of  $T$  [Ho1]. Letting  $T = \delta J' \cup L$  and using the fact that  $\delta \circ \delta = \text{id}$ , we have  $\text{Arf}(J' \cup \delta L) \equiv \text{Arf}(\delta \cdot \delta J' \cup \delta L) \equiv a_2(\delta J' \cup L)$ . Now for any sublink  $J''$  of  $J'$ ,  $J'' \cup L$  is an algebraically split link of more than 3 components and Hoste has shown that  $a_2(J'' \cup L) = 0$  [Ho2]. Hence  $\text{Arf}(J' \cup \delta L) \equiv 0$  as desired. We remark in passing that J. Levine's generalization of Hoste's result has a proof which shows quite clearly that  $a_2 \equiv 0 \pmod{2}$  if  $J \cup L$  is algebraically split mod2! ([L2], Proposition 4.1). Hence it is sufficient to assume that  $J$  is a "totally proper" link. Every 3-manifold is surgery on a totally proper link in  $S^3$  since any symmetric matrix of integers can be diagonalized modulo 2 after stabilizing by adding a +1.

Since  $S^3 - P$ , where  $P$  is the Poincaré homology sphere, lies in  $\mathcal{M}_3^{\text{Spin}}$  and  $\mu(S^3 - P) \equiv 8$ ,  $\mu$  is of degree precisely 3.  $\square$

**Theorem 6.3.** *For any closed spin 3-manifold  $M$  and any integer  $\ell$ , the group  $\mathcal{G}_\ell^{\text{Spin}}(M) = (\mathcal{M}_\ell^{\text{Spin}} / \mathcal{M}_{\ell+1}^{\text{Spin}})(M)$  is finitely generated. Thus  $\mathcal{O}_\ell^{\text{Spin}}(M)$  is finitely generated, and  $\mathcal{O}_\ell^{\text{Spin}} = \Pi_{\mathcal{H}^{\text{Spin}}} \mathcal{O}_\ell^{\text{Spin}}(M_i)$  where  $\mathcal{H}^{\text{Spin}}$  is the set of  $H_1$ -bordism classes of spin 3-manifolds and  $M_i$  is a representative from the class  $i \in \mathcal{H}^{\text{Spin}}$ .*

*Proof.* Lemma 2.2 remains true in the Spin category since it is merely a combinatorial identity. Lemma 2.3 also holds using the same proof. Lemma 2.4 remains true but the proof requires comment. It is necessary to check that the diffeomorphism of the solid torus used in the proof actually preserves the given spin structures. But  $S^1 \times D^2$  has only two spin structures and these are determined by looking at the spin structure on  $S^1 \times \partial D^2$ . Since the diffeomorphism is the identity on the boundary, it preserves the spin structure.

The "Ohtsuki Lemmas" 2.5 and 2.7 remain true. The only ingredients of the proofs of 2.5 and 2.7 which are not definitions are the diffeomorphisms associated to "blowing up" or "blowing down" an unknotted circle which has zero linking numbers with all other components. It must be checked that these diffeomorphisms preserve the designated spin structures. Such  $\pm 1$  framed circles are necessarily part of the characteristic sublink since they have zero linking numbers with all other components, and for the same

reason it is known that blowing down such a curve does not change which of the other components are in the characteristic sublink [KM]. For an identical reason, Lemma 2.9 remains true in the Spin category. The rest of the proof of 2.1 works word for word, reducing  $\mathcal{G}_\ell^{\text{Spin}}(M)$  to a finite spanning set which, indeed, is obtained from the spanning set for  $\mathcal{G}_\ell(M)$  by including, for each element  $[M, L]$  of the latter,  $[(M, \sigma), L]$  where  $\sigma$  varies over the  $|H_1(M; \mathbb{Z}_2)|$  spin structures of  $M$ .  $\square$

## 7 Finite type invariants for bounded manifolds

We shall briefly discuss several theories for finite type invariants for compact 3-manifolds with boundary. The first theory leaves the boundary “unmarked” and the second and third assume the additional structure of an orientation preserving homeomorphism  $\phi : \partial M \rightarrow S_g$  where  $S_g$  is a fixed oriented surface in the homeomorphism class of  $\partial M$ . The first theory was defined in §1 as the reader will note that no assumption was made that  $\partial M$  is empty. In the second theory,  $\mathcal{S}^\partial$  is the set of triples  $(M, \partial M, \phi)$  as above where  $(M', \partial M', \phi') \sim (M, \partial M, \phi)$  if there is an orientation preserving homomorphism  $h : M \rightarrow M'$  such that  $\phi' \circ h = \phi$  on  $\partial M$ . Given a link  $L$  in  $M$ , a marking is induced on  $\partial M_L$  by using the given product structure on the boundary of the cobordism from  $M$  to  $M_L$ . In the third theory,  $\phi : \partial M \rightarrow \partial(H_g)$  ( $H_g$  is the handlebody of genus  $g$ ) is required to induce  $\phi_* : H_1(\partial M) \rightarrow H_1(\partial H_g)$  which restricts to an isomorphism from the unique  $\mathbb{Z}^g$  summand containing kernel  $(H_1(\partial M) \xrightarrow{i_*} H_1(M))$  to the kernel of  $H_1(\partial H_g) \rightarrow H_1(H_g)$ .

We deferred until now the proof of our “Finiteness Theorem” 2.1 for manifolds with boundary (unmarked). Let us indicate the changes necessary in the proof given in §2. The braiding and half-twist lemmas need to be expanded to allow, in Figures 2.6 and 2.8, “pieces of the boundary” to run algebraically zero times through  $L_1$ . This is made precise as follows. For each boundary component  $S_{g_i}$  of  $M$ , attach a handlebody  $H_i$  with the same boundary to form a closed oriented manifold  $\widehat{M}$ . Choose a spine for  $H_i$  which is abstractly homeomorphic to a union of  $g_i$  circles, one base point and  $g_i$  arcs connecting the circles to the basepoint. Let the image of this

in  $\widehat{M}$  be denoted  $\widehat{J}_i$  and their union  $\widehat{J}$ . As before  $\widehat{M}$  can be expressed as surgery on a link  $J$  in  $S^3$  which may be assumed to be disjoint from  $\widehat{J}$ . Hence  $M$  is recovered from  $S^3_J$  by merely deleting a regular neighborhood of  $\widehat{J}$ .  $\widehat{J}_i$  should be viewed as a based  $g_i$  component link in  $S^3$ . Moreover if  $L$  is an admissible link in  $M$  then each  $L_i$  bounds a surface in  $M$ . Therefore we may assume that  $L$  lies in  $\widehat{M} - \widehat{J} - J$  and that  $L_i$  has zero linking number with each component circle of  $\widehat{J}$  (it bounds a surface in  $\widehat{M} - \widehat{J}$ ), as well as with each component of  $J$  (as before). Now it is clear that we have effectively changed a problem about manifolds with boundary into a problem about closed manifolds with marked based links  $\widehat{J}$ . Then Lemmas 2.5 and 2.7 remain true with “strands” of  $\widehat{J}$  going through the disk spanned by  $L_1$ . Since  $\widehat{J}$  merely records “the location” of  $\partial M$ , this means these lemmas hold in the category of manifolds with boundary. For the remainder of the proof of Theorem 2.1 the reader should think of replacing the link  $J$  of the surgery lemma (2.9) and later by the partially based link  $J \cup \widehat{J}$ . It is important to note that we needed to choose a basing for our links in Definition 2.10 anyway, in order to use Levine’s work. Merely extend the partial basing to a full basing. The rest of the proof of Theorem 2.1 now proceeds word for word with  $J \cup \widehat{J}$  replacing  $J$ .  $\square$

Once again, invariants of degree 0 are precisely those functions which are constant on surgery equivalence classes. These include betti numbers, torsion numbers, the number of components of the boundary, the genera of the boundary components, linking form invariants, triple cup product forms and any invariants one might choose to detect the isomorphism class of the pair  $(H_1(M), H_1(\partial M))$  (see [CGO] for a fuller discussion).

We do not know if the second or third theories satisfy finite generation.

Note that  $\mathcal{S}^\partial \hookrightarrow \mathcal{S}$  by “plugging up”  $M$  via solid handlebodies (using the marking). Hence  $\mathcal{O} \hookrightarrow \mathcal{O}^\partial$ , showing that  $\mathcal{O}^\partial$  is large.

## 8 Finite type invariants for marked manifolds

Consider pairs  $(M, \psi)$ , where  $M$  is a compact oriented 3-manifold and  $\psi$  is an isomorphism from  $H_1(M)$  to a fixed abstract abelian group  $B$  (a “marking” of  $H_1(M)$ ). Let  $\mathcal{S}^*$  be the set of equivalence classes of such pairs of marked

3-manifolds, where  $(M_0, \psi_0) \sim (M_1, \psi_1)$  if and only if there is an orientation-preserving homeomorphism  $f : M_0 \rightarrow M_1$  such that  $\psi_1 \circ f_* = \psi_0$ . Note that  $(\#S^1 \times S^2, \psi_0) \sim (\#S^1 \times S^2, \psi_1)$  for any  $\psi_0, \psi_1$  so that if one is attempting to distinguish  $M$  from  $\#S^1 \times S^2$ , there is no loss in marking  $H_1$ . Now, if  $S$  is an admissible link in  $M$ , then a marking of  $H_1(M)$  extends naturally to a marking of  $H_1(M_S)$ , where  $M_S$  is the surgered manifold. Indeed it is clear that a marking of  $H_1(M)$  extends over any  $H_1$ -bordism. Thus there is a theory of finite type invariants for this category (as explained in section 1), which will be denoted by  $\mathcal{O}^*$ . Note that a theory based on pairs  $(M, \alpha)$  where  $\alpha \in H^1(M; \mathbb{Z}_n)$  works similarly.

If  $(M, \psi)$  is a marked 3-manifold then we can define many group-valued invariants which would not be possible without the marking. These include coefficients of the Conway polynomial, Reidemeister torsion and Massey products (restricted to special classes of manifolds so they are uniquely defined integers). Below we shall show that the Conway coefficients are finite type. We shall not address the Massey products here, although, since Massey products on link exteriors are known to be of finite type, one must expect that they are in this situation also. The extent to which Reidemeister torsion is determined by finite type invariants in this category will be detailed in a later paper.

Suppose  $(M, \psi)$  is a closed, marked 3-manifold with  $\mathfrak{b}_1(M) = m \geq 1$ . There is a canonical epimorphism  $B \rightarrow \mathbb{Z}$  given by sending each generator 1 in each  $\mathbb{Z}$  factor of  $B$  to 1. The ‘‘Alexander polynomial’’ of  $(M, \psi)$  is the order of  $H_1$  of the induced  $\mathbb{Z}$ -cover, divided by  $|\text{torsion } H_1(M)|$ . Any such manifold  $M$  is 0-framed surgery on a link  $K = \{K_1, \dots, K_k\}$  of null-homologous components, with  $\ell k(K_i, K_j) = 0$ , in a rational homology sphere  $\Sigma$ . The Conway polynomial of  $K$ ,  $\nabla_K(z) = z^{k-1}(a_0 + a_2z^2 + a_4z^4 + \dots)$ , is then defined and is related to the Alexander polynomial of  $\Sigma - K$  and hence to the Alexander polynomial of  $M$  in a similar fashion as explained in section 3 (see §2.3.13 of [Ls]). *The Conway polynomial of  $(M, \psi)$  is  $\nabla_K(z)$ .*

**Theorem 8.1.** *Let  $\mathcal{S}^*$  be the set of equivalence classes of closed marked 3-manifolds  $(M, \psi)$  with  $\mathfrak{b}_1(M) = k \geq 1$ . Let  $C_\ell$  be the coefficient of  $z^{k-1+\ell}$  in the Conway polynomial of  $(M, \psi)$ . Then  $C_\ell : \mathcal{S}^* \rightarrow \mathbb{Q}$  is finite type of degree at most  $k - 1 + \ell$ .*

**Remark.** In fact if  $\ell$  is odd then  $C_\ell \equiv 0$  so it is degree 0. If  $\ell$  is even we claim the degree is precisely  $k - 1 + \ell$ , but do not provide the proof here.

*Proof of 8.1.* This follows immediately from Theorem 3.2. The remark follows from Conjecture 3.14.  $\square$

**Corollary 8.2.** *The Lescop invariant  $\lambda_L$  for (unmarked) manifolds with  $\mathfrak{b}_1 = 2$  is finite type of degree 1. The invariant  $\lambda_L$  for manifolds with  $\mathfrak{b}_1 = 3$  is finite type of degree 0.*

*Proof.*  $\lambda_L$  equals  $|\text{torsion } H_1(M)| \cdot C_2(M)$  (§5.1.6 of [Ls]). The corollary then follows from Theorem 8.1 and the subsequent remark. The proof for  $\mathfrak{b}_1 = 3$  is easy and does not require 8.1 since in this case  $C_2$  is known to be the square of  $\overline{\mu}(123)$  [Co] and this is known to be constant on  $H_1$ -bordism classes (see section 1 and also [CGO]). Note that  $\lambda_L$  is independent of the marking of  $H_1(M)$ .  $\square$

**Remark 8.3.** Since we have invoked Conjecture 3.14 for  $k = 2$ ,  $\ell = 2$  in the proof of 8.2 ( $\mathfrak{b}_1 = 2$ ), we sketch the proof. Theorem 3.2 guarantees that  $z^4$  divides  $\nabla(\mathcal{M}_4)$ , whereas 3.14 claims  $z^4$  divides  $\nabla(\mathcal{M}_2)$  (restricted to  $\mathfrak{b}_1 = 2$ ). Hence it suffices to show  $z^4$  divides the Conway polynomial of a generating set for  $\mathcal{G}_2(\#_{i=1}^2 S^1 \times S^2)$  and  $\mathcal{G}_3$ . Hence it suffices to check this for the images of a generating set for the torsion free part of  $\overline{\mathcal{C}}_3^2$  and  $\overline{\mathcal{C}}_4^2$ , which is not difficult.

For manifolds with  $\mathfrak{b}_1 = 0$ , i.e. rational homology spheres, Lescop's invariant agrees with the Casson-Walker invariant  $\lambda$ , which is of degree 3 (see Corollary 10.3 below). Thus we have

**Corollary 8.4.** *The Lescop invariant  $\lambda_L : \mathcal{S} \rightarrow \mathbb{Q}$  of (unmarked) closed oriented 3-manifolds is finite type of degree 3.*



## 9 Further generalizations

The theory we have presented is centered around the concept of  $H_1$ -bordism. In effect, the 3-manifolds which are deemed “close” to  $M$  are precisely those which are  $H_1$ -bordant to  $M$  via a 4-manifold  $W$  which consists of a single 2-handle addition. The “tangent vectors” at  $M$  to the “space of 3-manifolds” are then the formal differences  $\partial_+W - \partial_-W$ , or could even be thought of as the cobordisms themselves. This leads to a theory in which the degree zero “polynomials” (being locally constant on the space of 3-manifolds) are functions which are constant on the  $H_1$ -bordism classes, which means they are group-valued functions on the set of isomorphism classes of the structure  $(H_1, \text{linking form, triple cup product forms with abelian coefficients})$ . Hence our theory of finite type invariants focusses on distinguishing manifolds with isomorphic oriented cohomology rings, separating this from the “classical” problem of distinguishing cohomology rings.

There are additional “classical” invariants of 3-manifolds, namely *higher* Massey products, which could be included with the cohomology rings, and there is a corresponding theory of finite type invariants. We summarize this theory below. Theories which fix even more aspects of the homotopy type are possible but will not be discussed.

Let  $k \geq 2$  be an integer. We describe a family of theories of  $k$ -finite type invariants which agrees with our primary theory for  $k = 2$ .

**Definition 9.1.** A framed link  $L$  in  $M$  is called  *$k$ -admissible* if

- a) each component of  $L$  lies in  $(\pi_1(M))_k$ , the  $k^{\text{th}}$  term of the lower central series of  $\pi_1(M)$
- b) the pairwise linking numbers of  $L$  are zero
- c) the framings are  $\pm 1$ .

Clearly a sublink of a  $k$ -admissible link is itself  $k$ -admissible.

**Definition 9.2.** Let  $\mathcal{M}_\ell^k$  denote the subgroup of  $\mathcal{M}$  spanned by all  $[M, L]$  where  $L$  is a  $k$ -admissible link of  $\ell$  components in a 3-manifold  $M$ . A function  $\phi : \mathcal{S} \rightarrow A$  is  *$k$ -finite type degree  $\ell$*  if  $\phi(\mathcal{M}_{\ell+1}^k) = 0$  and  $\phi(\mathcal{M}_\ell^k) \neq 0$ , and

$\mathcal{O}_\ell^k = \text{Hom}(\mathcal{M}/\mathcal{M}_{\ell+1}, A)$  is the algebra of all  $k$ -finite type invariants of degree at most  $\ell$ .

Since  $\mathcal{M}_\ell^k \subseteq \mathcal{M}_\ell^{k-1} \subseteq \dots \subseteq \mathcal{M}_\ell^2 \equiv \mathcal{M}_\ell$  we have

$$\mathcal{O}_\ell^k \supseteq \mathcal{O}_\ell^{k-1} \supseteq \dots \supseteq \mathcal{O}_\ell^2 \equiv \mathcal{O}_\ell,$$

that is to say, there are *more* invariants as  $k$  increases.

**Definition 9.3.** (see [CGO]) Two 3-manifolds  $M$  and  $N$  will be called  *$k$ -surgery equivalent* if there is a sequence  $M = M_0, M_1, \dots, M_r = N$  such that  $M_{i+1}$  is obtained by  $\pm 1$ -surgery on a circle in  $M_i$  which lies in  $\pi_1(M_i)_k$ . They are  *$\pi/\pi_k$ -bordant* if there is an oriented cobordism  $W$  between  $M$  and  $N$ , which is a “product” on  $\pi_1/(\pi_1)_k$  (so for  $k = 2$  this is  $H_1$ -bordism).

**Theorem 9.4.** [CGO] *Two 3-manifolds  $M$  and  $N$  are  $k$ -surgery equivalent if and only if  $M$  and  $N$  are  $\pi/\pi_k$ -bordant ( $k \geq 2$ ).*

If one stipulates that the “closest” 3-manifolds to  $M$  are ones that are  $\pi/\pi_k$ -bordant via a single 2-handle addition, and that the tangent vectors at  $M$  are formal differences of such, and applies a notion of combinatorial derivative, then one generates  $\mathcal{O}_\ell^k$  as the class of polynomials of degree at most  $\ell$ .

**Proposition 9.5.** *Let  $\mathcal{H}_k$  denote the set of all  $\pi/\pi_k$ -bordism classes of 3-manifolds. Then  $\mathcal{M}_\ell^k \cong \bigoplus_{\alpha \in \mathcal{H}_k} \mathcal{M}_\ell^k(\alpha)$  and  $\mathcal{O}_\ell^k \cong \prod_{\alpha \in \mathcal{H}_k} \mathcal{O}_\ell^k(\alpha)$  where  $\mathcal{O}_\ell^k(\alpha)$  is the corresponding theory restricted to manifolds in the  $\pi/\pi_k$ -bordism class of  $\alpha$ .*

It is shown in [CGO] that  $k$ -surgery equivalence is related to Massey products. It is shown that a manifold with  $H_1 \cong \mathbb{Z}^m$  is  $k$ -surgery equivalent to  $\#_{i=1}^m S^1 \times S^2$  if and only if its Massey products of order less than  $2k - 1$  vanish.

The proof that  $\mathcal{O}_\ell^k(\alpha)$  is finitely generated for each  $\alpha \in \mathcal{H}_k$  is not complete even though almost all of the steps of the proof of 2.1 carry over without difficulty. Lemmas 1.4 and 2.2 hold without change, although a non-trivial result from [CGO] is required. Lemmas 2.3 and 2.4 hold with  $k$ -admissible replacing admissible. Lemmas 2.5 and 2.7 hold without alteration. Lemma 2.9 can be rephrased and partially recovered.

**Lemma 9.6.** *If  $L$  and  $L'$  are surgery equivalent links in a 3-manifold  $M$  then  $[M, L] \sim [M, L']$  in  $\mathcal{G}_\ell^k(M)$ .*

This is true because a surgery equivalence between links in  $M$  is, by definition, accomplished by a  $\pm 1$  surgery on a circle  $K$  which bounds a disk in  $M$ . Clearly more general alterations are possible since  $K$  could be allowed to represent a non-trivial loop in  $(\pi_1(M))_k$ . Here the proof stops due to the lack of an analogue of Levine’s theorem. However note that it is already possible to reduce to the case where the link  $L \subseteq L \cup J \subseteq S^3$  has only “Borromean interactions” and hence is given by, loosely speaking, uni-trivalent graphs in  $M$ . This is entirely consistent with the fact that  $\pi/\pi_k$ -bordism of manifolds is classified by  $H_3(\pi_1(M)/\pi_1(M)_k)$  modulo automorphism (see [CGO]). Since the latter group is finitely generated, it is fairly clear that one can reduce to a finite set of *parameters* (presumably Massey products — or Milnor’s invariants — of weight less than  $2k$ ). However the details have not yet been considered. Moreover, it is less clear what is the analogue of the final step (Lemma 2.5), that is to reduce from  $\bar{\mu}(1122) = 10$   $\bar{\mu}(123) = 6$ , for example, to a sum of cases where  $\bar{\mu}(1122) \in \{0, \pm 1\}$  and  $\bar{\mu}(123) \in \{0, \pm 1\}$ . Nonetheless it would be surprising if this was a serious problem. Note that it is not necessary to *classify* links modulo the appropriate equivalence relation, just as it was not necessary for us (in 2.1) to use the full strength of Levine’s surgery equivalence theorem. The ill-definedness of higher Massey products would be a serious annoyance.

It seems clear, in light of recent work of Habegger and Masbaum relating to Milnor’s invariants to the Kontsevich integral, that the  $p$ -order (see 4.5) would vary less and less in a  $\pi/\pi_k$ -bordism class as  $k$  increases. This should allow for the well-definedness of more invariants of  $k$ -finite type derived from  $\tau_p^{\text{SO}(3)}$ .

The reader should note that  $k$ -finite type equals 2-finite type for those manifolds where  $\pi_k = \pi_2$ . This includes all manifolds with cyclic first homology!

A theory based on control of *all* the higher Massey products at once seems attractive, but the finite generation (2.1) seems unlikely for 3-manifolds whose lower central series strictly descends.

## 10 Relationships with other theories and other results

In this section, we mention some relationships with other theories: that of Garoufalidis-Ohtsuki [GO1] for rational homology spheres, and of Garoufalidis-Levine [GL3] relating to the mapping class group.

The theory of Garoufalidis-Ohtsuki for rational homology spheres is based on surgery on algebraically split links in homology spheres and as such is not strongly related to our approach. In an attempt to get  $\mathcal{G}_n$  finitely-generated they impose their “Property 1” which is overly strong in our opinion. Morally, our theory should have strictly more invariants. Certainly the  $\mathbb{Z}_p$ -rank of  $H_1(M; \mathbb{Z}_p)$  is of finite type degree zero for us but not of finite type for them. However, due to a slight flaw in their theory, we cannot show in generality that an invariant which is of GO-finite type is finite type in our sense. Indeed, Garoufalidis-Ohtsuki intended that  $\mathcal{G}_n$  should be finitely-generated (consequence of their Theorem 2). However their  $\mathcal{G}_0$  is not finitely generated: Suppose  $M$  is a rational homology sphere whose linking form is not isomorphic to the direct sum of forms on cyclic groups (see [KK]). Let  $\phi$  be the characteristic function on  $M$ . Then  $\phi$  is finite type in the sense of [GO1], because the only restrictions placed on  $\phi$  by [GO1] involve Dehn surgery on algebraically split links in an *integral* homology sphere. But any manifold so obtained has a linking form which is a direct sum of linking forms on *cyclic* groups (since its linking matrix is diagonal). Hence  $\phi$  is zero on all these manifolds. Since there are an infinite number of such manifolds  $M$  as above, their  $\mathcal{G}_0$  is infinitely generated. (Indeed there are an infinite number of non-isomorphic linking forms which are not “diagonalizable”.) But certainly  $\phi$  is not finite type in our sense (for any  $\ell$  there is a Brunnian  $\ell$ -component link  $L$  in  $S^3$  on which surgery does not yield  $S^3$  — consider  $M\#[S^3, L]$ ).

Now we will show that, on the subclass of rational homology spheres, any invariant which is finite type  $n$  in the sense of [GO1] and which is additive on connected sums, is finite type of degree at most  $n$  in our sense.

**Theorem 10.1.** *Let  $\mathcal{R} \subset \mathcal{M}$  be the span of the set of rational homology spheres. Suppose that  $\phi : \mathcal{R} \otimes \mathbb{Q} \rightarrow \mathbb{Q}$  is of finite type  $n$  in the sense of Garoufalidis-Ohtsuki [GO1, §1.2] and is additive on connected sums. Then the induced map  $\phi : \mathcal{R} \rightarrow \mathbb{Q}$  (i.e. the composition of  $\phi$  with the natural inclusion  $\mathcal{R} \hookrightarrow \mathcal{R} \otimes \mathbb{Q}$ ) is finite type of degree at most  $n$  in our sense.*

**Corollary 10.2.** *The invariant of Casson-Walker for rational homology 3-spheres is a rational valued finite type invariant of degree 3.*

*Proof of 10.1.* In fact we need only assume that  $\phi$  satisfies their “Property 0.” Property 0 says that  $\phi([\Sigma, L]) = 0$  for every integral homology sphere  $\Sigma$  and every rationally framed (with the proviso that the framings be non-zero) algebraically split link  $L$  in  $\Sigma$  with more than  $n$  components. (Here “algebraically split” means pairwise linking numbers zero.) Suppose  $M$  is a fixed rational homology sphere and  $L$  is a fixed admissible  $n + 1$  component link in  $M$ . It suffices to show that  $\phi([M, L]) = 0$ . Throughout we will identify  $\mathcal{R}$  with its image in  $\mathcal{R} \otimes \mathbb{Q}$ .

First suppose that  $M$  can be expressed as  $S^3_J$  where  $J$  is a integrally framed algebraically split link in  $S^3$ . Then we have the following combinatorial Lemma.

**Lemma 10.3.** *With the above notation,  $[S^3_J, L] = \sum_{S < J} (-1)^s [S^3, L \cup S]$ .*

The theorem follows immediately from the Lemma since, by Property 0 of [GO1],  $\phi$  vanishes on  $[S^3, L \cup S]$  since  $L \cup S$  has more than  $n$  components. The Lemma is proved easily by induction on  $j$ , the number of components of  $J$ . It is trivial for  $j = 0$ , so assume it for all links of  $j \geq 0$  components and consider a link of  $(j + 1)$  components of the form  $J \cup K$  where  $K$  is the last component. Then by Lemma 1.4,  $[S^3_{J \cup K}, L] = -[S^3_J, L \cup K] + [S^3_J, L]$ . By induction this equals  $\sum_{S < J} (-1)^s (-[S^3, L \cup K \cup S] + [S^3, L \cup S])$ . But this is  $\sum_{S < J \cup K} (-1)^s [S^3, L \cup S]$ .

Now consider the general case  $[M, L]$ . By a result of Murakami and Ohtsuki [M2], there exists a rational homology sphere  $X$  such that  $M \# X$  is integral surgery on some algebraically split link in  $S^3$ . But  $\phi([M \# X, L]) = \phi([M, L])$  since  $\phi$  is additive and  $L$  is not empty. Thus the above special case suffices to show that  $\phi$  is finite type.  $\square$

There is an interesting relation with the mapping class group. Recall the subgroup  $\mathcal{K}$  of the mapping class group generated by Dehn twists along bounding simple closed curves (see [GL3]).

**Theorem 10.4.** ([CGO])  *$M$  is  $H_1$ -bordant to  $M'$  if and only if there is a Heegard splitting  $M = H_1 \cup_f H_2$  and a homeomorphism  $g \in \mathcal{K}$  such that  $M' = H_1 \cup_{g \circ f} H_2$ .*

This indicates that one could filter all 3-manifolds using the type of filtration discussed by Garoufalidis and Levine in ([GL3], 1.3) corresponding to  $\mathcal{K}$ , and that at least at the “zero level” it would agree with our theory. However since Ohtsuki’s theory for homology spheres is a direct summand of our  $\mathcal{M}$ , and since it is still unknown even in this case if these theories agree (Ohtsuki versus [GL3]), we shall not pursue this here.

## References

- [AM] S. Akbulut and J. McCarthy, *Casson’s invariant for oriented homology 3-spheres: An exposition*, Math. Notes, vol. 36, Princeton University Press, 1990.
- [Ba] D. Bar-Natan, *On the Vassiliev knot invariants*, Topology **34** (1995), 423–472.
- [BL] J.S. Birman, X.-S. Lin, *Knot polynomials and Vassiliev’s invariants*, Invent. Math. **111** (1993), 225–270.
- [BoL] S. Boyer and D. Lines, *Conway potential functions for links in  $\mathbb{Q}$ -homology 3-spheres*, Proc. Edin. Math. Soc. **35** (1992), 53–69.
- [Co] T. Cochran *Concordance invariance of coefficients of Conway’s link polynomial*, Invent. Math. **82** (1985), 527–541.
- [CM1] T.D. Cochran and P. Melvin, *Quantum Cyclotomic Orders of 3-Manifolds*, Topology (to appear).
- [CM2] T. Cochran and P. Melvin, in preparation.
- [CGO] T. Cochran, A. Gerges, and K. Orr, *Surgery equivalence relations on 3-manifolds*, preprint 1996, Rice University.
- [Ga] S. Garoufalidis, *On finite type 3-manifold invariants I*, Jour. of Knot Theory Rami. **5** (1996), 441–462.

- [GL1] S. Garoufalidis and J. Levine, *On finite type 3-manifold invariants II*, Math. Ann. **306** (1996), 691–718.
- [GL2] S. Garoufalidis and J. Levine, *On finite type 3-manifold invariants IV: comparison of definitions*, Math. Proc. Camb. Phil. Soc. **122** (1997), 291–300.
- [GL3] S. Garoufalidis and J. Levine, *Finite type 3-manifold invariants, the mapping class group and blinks*, Jour. Diff. Geom. **47** (1997), 257–320.
- [GO1] S. Garoufalidis and T. Ohtsuki, *On finite type 3-manifold invariants V: rational homology spheres*, In: Geometry and Physics, Lecture Notes in Pure and Applied Mathematics volume 184, editor J.E. Anderson, Marcel Dekker, New York, 1997, 445–458.
- [GO2] S. Garoufalidis and T. Ohtsuki, *On finite type 3-manifold invariants III: manifold weight systems*, Topology **37** no. 2 (1998), 227–243.
- [Ge] A. Gerges, *Surgery, bordism and equivalence of 3-manifolds*, Ph.D. Thesis, Rice University, 1996; (see also [CGO]).
- [Gu] M.N. Gusarov, *On  $n$ -equivalence of knots and invariants of finite degree*, In: Topology of manifolds and varieties, editor O. Viro, Amer. Math. Soc., Providence RI, 173–192, .
- [H1] N. Habegger, *Finite type 3-manifold invariants: a proof of a conjecture of Garoufalidis*, preprint, July 1995.
- [H2] N. Habegger, *A computation of the universal quantum 3-manifold invariant for manifolds of rank greater than 2*, preprint Université de Nantes, 1997.
- [Ho1] J. Hoste, *The Arf invariant of a totally proper link*, Topol. Appl. **18** (1984), 163–177.
- [Ho2] J. Hoste, *A formula for Casson’s invariant*, Trans. Amer. Math. Soc. **297** (1986), 547–562.
- [KK] A. Kawauchi and S. Kojima, *Algebraic classification of linking pairings on 3-manifolds*, Math. Ann. **253** (1980), 29–42.
- [Ki] R. Kirby, *The calculus of framed links in  $S^3$* , Invent. Math. **45** (1978), 35–56.
- [KM] R. Kirby and P. Melvin, *The 3-manifold invariants of Witten and Reshetikhin-Turaev for  $sl(2, \mathbb{C})$* , Invent. Math. **105** (1991), 473–545.
- [Ko] M. Kontsevich, *Vassiliev’s knot invariants*, Advances in Soviet Mathematics **16** (1993), 137–150.

- [KS] A. Krieger and B. Spence, *Ohtsuki's invariants are of finite type*, Jour. of Knot Theory Rami. **6** (1997), 583–597.
- [Le] T. Le, *An invariant of integral homology 3-spheres which is universal for all finite type invariants*, Amer. Math. Soc. Transl. (2) **179** (1997), 75–100.
- [LMO] T. Le, J. Murakami and T. Ohtsuki *On a universal quantum invariant of 3-manifolds*, Topology **37** (1998), 539–576.
- [Ls] C. Lescop, *Global surgery formula for the Casson-Walker invariant*, Annals of Math. Studies #140, Princeton University Press, Princeton, N.J., 1996.
- [L1] J. Levine, *Surgery on links and the  $\bar{\mu}$ -invariants*, Topology **26** (1987).
- [L2] J. Levine, *The Conway Polynomial of an algebraically split link*, In: Knots 96, World Scientific, editor S. Suzuki, Singapore, 1996, pp. 23–30.
- [LW] X.S. Lin and Z. Wang, *On Ohtsuki's invariants of integral homology 3-spheres*, I, preprint.
- [M1] H. Murakami, *Quantum SU(2)-invariants dominate Casson's SU(2)-invariant*, Math. Proc. Camb. Phil. Soc. **115** (1994).
- [M2] H. Murakami, *Quantum SO(3)-invariants dominate the SU(2)-invariant of Casson and Walker*, Math. Proc. Camb. Phil. Soc. **117** (1995), 237–249.
- [MR] G. Masbaum and J. Roberts, *A simple proof of the integrality of quantum invariants at prime roots of unity*, Math. Proc. Camb. Phil. Soc. **121** (1997), 443–454.
- [O1] T. Ohtsuki, *A polynomial invariant of integral homology 3-spheres*, Math. Proc. Camb. Phil. Soc. **117** (1995), 83–112.
- [O2] T. Ohtsuki, *Finite type invariants of integral homology 3-spheres*, Jour. of Knot Theory Rami. **5** (1996), 101–115.
- [O3] T. Ohtsuki, *A polynomial invariant of rational homology 3-spheres*, Invent. Math. **123** (1996), 241–257.
- [RT] N. Yu Reshetikhin and V.G. Turaev, *Invariants of 3-manifolds via link polynomials and quantum groups*, Invent. Math. **103** (1991), 547–597.
- [Ro] D. Rolfsen, *Knots and Links*, Publish or Perish, Houston, TX, 1976.



- [Rz] L. Rozansky, *The trivial connection contribution to Witten's invariant and finite type invariants of rational homology spheres*, Comm. Math. Phys. **183** (1997), no. 1, 23–54.
- [Sh] N. Shirokova, *The space of 3-manifolds and Vassiliev finite type invariants*, q-alg/9705008.
- [Tu] V.G. Turaev, *Cohomology rings, linking forms and invariants of spin structures of 3-dimensional manifolds*, Math. USSR Sbornik **48** (1984), 65–79.
- [Va] V.A. Vassiliev, *Cohomology of knot spaces*, In: Theory of singularities and applications, Adv. Soviet. Math. vol. 1, 1990, 23–69, Amer. Math. Soc., Providence. RI.
- [Wi] E. Witten, *Quantum field theory and the Jones polynomial*, Comm. Math. Phys. **121** (1989), 351–399.

Tim D. Cochran  
Department of Mathematics  
Rice University  
Houston, TX 77005–1892  
cochran@math.rice.edu

Paul Melvin  
Department of Mathematics  
Bryn Mawr College  
Bryn Mawr, PA 19010–2899  
pmelvin@brynmawr.edu