

Suspensions of homology spheres

Robert D. Edwards

DEPARTMENT OF MATHEMATICS, UCLA, LOS ANGELES, CA 90095-1555
E-mail address: rde@math.ucla.edu

This research was supported in part under NSF Grant No. MCS 76-06903. Preparation of the electronic manuscript was supported by NSF Grant DMS-0407583. Final editing was carried out by Fredric Ancel, Craig Guilbault and Gerard Venema.

ABSTRACT. This article is one of three highly influential articles on the topology of manifolds written by Robert D. Edwards in the 1970's but never published. This article "Suspensions of homology spheres" presents the initial solutions of the fabled Double Suspension Conjecture. The article "Approximating certain cell-like maps by homeomorphisms" presents the definitive theorem on the recognition of manifolds among resolvable generalized manifolds. (This work garnered Edwards an invitation to give a one-hour plenary address to the 1978 International Congress of Mathematicians.) The third article "Topological regular neighborhoods" develops a comprehensive theory of regular neighborhoods of locally flatly embedded topological manifolds in high dimensional topological manifolds. The manuscripts of these three articles have circulated privately since their creation. The organizers of the Workshops in Geometric Topology (<http://www.math.oregonstate.edu/~topology/workshop.htm>) with the support of the National Science Foundation have facilitated the preparation of electronic versions of these articles to make them publicly available.

This article contains four major theorems:

- I. The double suspension of Mazur's homology 3-sphere is a 5-sphere,
- II. The double suspension of any homology n -sphere that bounds a contractible $(n+1)$ -manifold is an $(n+2)$ -sphere,
- III. The double suspension of any homology 3-sphere is the cell-like image of a 5-sphere.
- IV. The triple suspension of any homology 3-sphere is a 6-sphere.

Edwards' proof of I was the first evidence that the suspension process could transform a non-simply connected manifold into a sphere, thereby answering a question that had puzzled topologists since the mid-1950's if not earlier. Results II, III and IV represent significant advances toward resolving the general double suspension conjecture: the double suspension of every homology n -sphere is an $(n+2)$ -sphere. [The general conjecture was subsequently proved by J. W. Cannon (*Annals of Math.* 110 (1979), 83-112).]

Contents

Prologue: Consequences of the Double Suspension Theorem; plus preliminaries, definitions and notation	
1. Consequences of the Double Suspension Theorem	2
2. Preliminaries: Cell-like decompositions and the Bing Shrinking Criterion	7
3. Definitions and notation	9
Part I. The double suspension of Mazur's homology 3-sphere is S^5	11
Part II. The double suspension of any homology n-sphere which bounds a contractible $(n-1)$-manifold is S^n	
Part III. The double suspension of any homology 3-sphere is the image of S^5 under a cell-like map	
Part IV. The triple suspension of any homology 3-sphere is S^6	65
Bibliography	75

Introduction

In the study of triangulations of manifolds, there arises naturally the following.

SUSPENSION QUESTION. *Is there any manifold H^n , other than the n -sphere¹, such that for some $k \geq 1$, the k -fold suspension $\Sigma^k H^n$ is homeomorphic to the $(n+k)$ -sphere? (see Prologue, Section I; definitions are below).*

By Alexander duality applied to the $(k-1)$ -dimensional “suspension sphere” S^{k-1} in $\Sigma^k H^n$, coupled with the fact that $\Sigma^k H^n - S^{k-1}$ is homeomorphic to $H^n \times H^k$, such a manifold H^n satisfying the suspension question must necessarily be a *homology n -sphere*, which means a closed topological n -manifold having the integral homology groups of the n -sphere (this explains the customary letter H). This paper examines the sufficiency of this condition. The potential singular set (i.e. nonmanifold set) of $\Sigma^k H^n$ is along the suspension $(k-1)$ -sphere. There one readily sees that $\Sigma^k H^n$ is locally homeomorphic to $\mathring{c}H^n \times \mathbb{R}^{k-1}$, where $\mathring{c}H^n$ denotes the open cone on H^n . It is known that the suspension question really amounts to that of deciding whether $\mathring{c}H^n \times \mathbb{R}^{k-1}$ is a topological manifold. This is because:

If the suspension of a compact space Y is a manifold, then ΣY must be a sphere.

The quickest proof of this fact is to argue that the complement in ΣY of a suspension point (which is homeomorphic to $\mathring{c}Y$) must be homeomorphic to euclidean space, since every compact subset of it lies in an open ball (details of this are in [Brwn]).

The $k=2$ case of the above suspension question has come to be known as the Double Suspension Conjecture: *If H^n is a homology n -sphere, then $\Sigma^2 H^n \approx S^{n+2}$ (where \approx means “is homeomorphic to”).* The unrestricted version of this conjecture (i.e. allowing $k > 2$) is sometimes called the Multiple Suspension Conjecture. (I do not know why the Double Suspension Conjecture is a conjecture, rather than a question or problem; that is the way most people refer to it now. This conjecture has been raised as a question in various places, for example [CZ] and [G11]-[G14]; probably the best known place is Milnor’s list of problems [Las, p. 579]. Earlier it was referred to as the Sphere Problem [Moi, p. 16]. The suspension question must have confronted all researchers who since the time of Brouwer’s work [Brou] have attempted to understand triangulations of manifolds. For example, see [Cai1] or [Cai2] (especially § 6); the latter work has a particularly good bibliography. See also [Ku].

There exist many homology spheres, which are not themselves homeomorphic to spheres, on which the conjecture can be tested. Perhaps the most famous is Poincaré’s binary dodecahedral homology 3-sphere, but unfortunately it turns out to be somewhat difficult to work with, as we will see. There exist in profusion more tractable homology n -spheres in all dimensions $n \geq 3$ (see Parts I and II).

All known genuine (i.e. nontrivial) homology n -spheres are nonsimply-connected, necessarily so when $n \geq 5$, for in these dimensions the generalized topological Poincaré conjecture [New1] establishes that a simply-connected homology n -sphere is homeomorphic to a sphere. This explains why the $k=1$ case of the suspension question is not emphasized, for in that case an additional necessary condition on H^n

¹Throughout this paper, superscripts on topological spaces always denote dimension (as is customary). Their occasional appearance or disappearance in later sections has no notational significance, e.g., K^2 and K denote the same space.

is that it be simply-connected (assuming $n \geq 2$). Hence that case of the question can have nontrivial content only possibly when $n = 3$ or 4 . If H^4 is a homotopy 4-sphere, it is known that $\Sigma H^4 \approx S^5$ (see [Si3, Assertion p. 83] or [Si6, Appendix I]; compare [Hi2]); if H^3 is a homotopy 3-sphere, it is **not** known whether $\Sigma H^3 \approx S^4$, but it is known that $\sigma^2 H^3 \approx S^5$ ([Si3, Theorem A]; compare [G11]).

These results represent the first cases of the suspension conjecture ever settled (possibly vacuously, of course). For nonsimply connected homology spheres, the double suspension conjecture remained one of those tantalizing problems that had three possible outcomes: it could be true never, sometimes, or always. Now, after several stages of development due to myself and J. Cannon, the conjecture has been completely settled in the affirmative by the

DOUBLE SUSPENSION THEOREM. *The double suspension $\Sigma^2 H^n$ of any homology sphere H^n is homeomorphic to a sphere.*

The purpose of this paper is to present all of my work related to the suspension question, which took place during the period 1974-76. Briefly stated, I established as a general rule that $\Sigma^k H^n \approx S^{n+k}$ whenever $n + k \geq 6$ ($k \geq 2$). Recently, Cannon crystallized and extended my work to prove a much more general theorem, one consequence of which was the final case $\Sigma^2 H^3 \approx S^5$ [Can2].

This paper is written in four parts, elaborated in the manner I have always intended, corresponding to the four stages in the development of my understanding of the problem. The complete contents of the paper are as follows:

PROLOGUE: *Consequences of the Double Suspension Theorem; plus preliminaries, definitions and notation.*

As motivation for the main results presented in Parts I-IV, a number of consequences of the double suspension are presented. In addition, some preliminaries are discussed; specifically, cell-like decompositions and the Bing Shrinking Theorem. Finally, some definitions and notation are established.

PART I: *The double suspension of Mazur's homology 3-sphere is S^5 .*

This represents the first case of the conjecture settled for a nonsimply-connected homology sphere. The proof amounts to a self-contained, bare-hands construction of a discernible homeomorphism.

PART II: *The double suspension of any homology n -sphere which bounds a contractible $(n + 1)$ -manifold is a sphere.*

In particular, this holds for any homology n -sphere, $n \geq 4$. This part generalizes the construction in Part I. It makes essential use of an important construction introduced by Štan'ko in [Št1]. A Postscript to Part II explains a certain Replacement Principle for Cell-like Compacta in manifolds. An Appendix to Part II explains how to shrink the decomposition which is at the heart of Parts I and II, namely, the spun Bing decomposition.

PART III: *The double suspension of any homology 3-sphere is the image of S^5 under a cell-like map.*

Thus, the suspension question for an arbitrary homology 3-sphere is a cell-like decomposition space problem. This result was proved independently by Cannon in

[**Can3**]. This part contains in passing a simplified construction of Siebenmann's non PL-triangulable topological manifold, extracted from [**Sch**].

PART IV: *The triple suspension of any homology 3-sphere is S^6 .*

This ad hoc argument rests in the end on a clever construction of Bing, which he used to establish the shrinkability of a countable collection of flat arcs in a manifold.

Although these results are being formally published here for the first time, various informal lecture notes from my talks, taken by various people, have been around for some time, e.g. from Orsay (Spring 1975), Cambridge (July 1975), Nantes (Spring 1976), Institute for Advanced Study (October 1976), and the AMS St. Louis meeting (January 1977). I am grateful in particular to A. Fathi, L. Guillou and Y. M. Vissetti for their clear write-up of my Orsay talks.

**Prologue: Consequences of the
Double Suspension Theorem; plus
preliminaries, definitions and
notation**

1. Consequences of the Double Suspension Theorem

This section is a compilation of various corollaries, most of them known to various people before the theorem was proved. (In the seven month period before Cannon's work, when only my triple suspension theorem (Part IV) was known as a general rule, some of the results here were restricted to ambient dimension ≥ 6 , rather than the present ≥ 5 .)

1.1. Exotic triangulations. The most noteworthy corollary is:

THEOREM 1. *Not all triangulations of topological manifolds need be piecewise linear (PL; i.e. combinatorial) triangulations. In fact, for any given dimension $q \geq 5$, there exists a triangulated topological manifold Q^q which is not even homotopically equivalent to any PL manifold.*

DISCUSSION: A PL manifold-without-boundary can be defined to be a polyhedron P which is piecewise linearly homogeneous, that is, for any two points $x, y \in P$, there is a PL homeomorphism $h : P \rightarrow P$ such that $h(x) = y$. In this spirit, a triangulated topological manifold can be defined to be polyhedron which is **topologically** homogeneous. The point, then, of the first part of the assertion above is that there exists a topologically homogeneous polyhedron which is not piecewise linearly homogeneous. Such an example is provided by $\Sigma^2 H^n \approx S^{n+2}$ for any nontrivial polyhedral homology sphere H^n , e.g. Newman's, Poenaru's or Mazur's (see Part I).

Still, this example leaves something to be desired, since $\Sigma^2 H^n$ is topologically homeomorphic to a piecewise linearly homogeneous polyhedron. This leads to the second part of the assertion.

The most easily described example of the polyhedron Q is the familiar one $Q^q = (M^4 \cup c(\partial M^4)) \times T^{q-4}$, where T^{q-4} denotes the $(q-4)$ -torus, and where M^4 is the 4-manifold-with-boundary described by Milnor as being eight copies of the tangent disc bundle of S^2 plumbed together according to the E_8 -diagram (see [Brwd, Chap 5] or [HNK, §8]), or (equivalently) described by Hirzebruch as the resolution of the singularity of the equation $z_1^2 + z_2^3 + z_3^5 = 0$, restricted to the unit ball in C^3 [HNK, §9, esp. Exercise (5.8)]. The manifold M^4 , being smooth, can be given PL manifold structure. The boundary ∂M^4 is Poincaré's binary dodecahedral homology 3-sphere. The significance of the manifold-with-singularity $M^4 \cup c(\partial M^4)$ is that it is parallelizable off of the cone point, and it has index 8. This contrasts with the bedrock theorem of Rokhlin that any closed PL 4-manifold which is parallelizable off of a point must have index divisible by 16.

If Q were homotopically equivalent to a PL manifold, W say, then one could homotope the map

$$W \xrightarrow{\text{hom.equiv}} Q \xrightarrow{\text{proj.}} T^{q-4}$$

to be PL and transverse to a point in T^{q-4} , producing as point-preimage a closed PL 4-manifold N^4 . One argues that N^4 would be almost-parallelizable, and also would have index 8, contradicting Rokhlin's theorem. See [Si2, Section 5] and [KS2, IV, App. B] for a discussion of this and related details, and for other references.

The PL singular set of Q^q is the subset $c \times T^{q-4}$, along which Q^q is locally homeomorphic to $\dot{c}(\partial M^4) \times \mathbb{R}^{q-4}$. By the Double Suspension Theorem, Q^q is locally euclidean there, and hence is a topological manifold.

The above simple description of the manifold Q^q rests of course on the Double Suspension Theorem and all the work it entails. A topological manifold homotopically equivalent (now known homeomorphic) to Q^q , for any $q \geq 5$, was first constructed in 1969 by Siebenmann [Si2, Section 5], as a counterexample to the PL triangulation conjecture for topological manifolds. His construction, which rests in the end only on the local contractibility of the homeomorphism group of a topological manifold, is the starting point of the work in Part III.

This discussion closes with some quick remarks related to Q^q and to triangulations of manifolds.

1. TRIANGULATING TOPOLOGICAL MANIFOLDS. The question of whether all topological manifolds are triangulable (i.e., homeomorphic to polyhedra) remains open. Completing the line of investigation begun in [Si3], D. Galewski - R. Stern [GS2] and T. Matumoto [Mat2] have established the following stimulating result (incorporating now the Double Suspension Theorem into their work): *All topological manifolds of dimension ≥ 5 are triangulable if and only if there exists a homology 3-sphere H^3 , having Rokhlin invariant $1 \in \mathbb{Z}/2$ (meaning: H^3 bounds a parallelizable PL 4-manifold of index 8), such that $H^3 \# H^3$ bounds a PL acyclic 4-manifold (i.e., such that H^3 is PL homology-cobordant to $-H^3$).* In fact, there is a specific, easily constructed “test” topological 5-manifold-without-boundary M^5 , which is triangulable if and only if such a homology 3-sphere exists.

2. ALGEBRAIC VARIETIES. It is commonly known that $\Sigma^k H^n$ is a real algebraic variety for many homology spheres H^n , e.g. Poincaré’s H^3 , k arbitrary. Recently S. Akbulut and R. Mandelbaum remarked that the non- PL -triangulable manifold Q^q described above can be realized as a real algebraic variety (or complex algebraic variety, if q is even) (see [AK]).

3. STRATIFIED SPACES. As already shown, the topological space Q^q is an example of a space whose intrinsic topological stratification has only one stratum, yet for **any** polyhedral structure on Q (even up to homotopy), its intrinsic PL stratification must have at least two strata. D.R. Anderson constructed in [An] an example of such a space Q having no PL stratification as simple as its intrinsic topological stratification, without using any suspension theorems for homology spheres.

4. TOPOLOGICAL TRANSVERSALITY. Assuming the Double Suspension Theorem true for a single homology 3-sphere H^3 of Rokhlin invariant 1, e.g. Poincaré’s H^3 , M. Scharlemann established the following transversality theorem at dimension 4 (this is the nonrelative version; for complete statements, see [Sch, Thms. B and C]): *Given a map $f : M^m \rightarrow E$ from a topological m -manifold to the total space E of a euclidean microbundle $\xi : X \hookrightarrow E \rightarrow X$ of fiber dimension $m - 4$ over a space X , then there is an arbitrarily small homotopy of f to a map f_* such that f_* is microbundle-transverse to the core X of E , and such that $f_*^{-1}(X)$ is a 4-manifold-with-isolated-singularities, each singularity being homeomorphic to $\mathring{c}H^3$.* Recall that if $m - k \neq 4 \neq m$, where $k =$ fiber dimension of E , then Kirby-Siebenmann [KS2, III, Section 1] proved the best possible topological transversality theorem, which concludes that $f_*^{-1}(X)$ is an $(m - k)$ -manifold, without singularities.

5. COLLAPSIBILITY AND SHELLABILITY. In [BCC], the authors prove the following curious result, using the fact that the double suspension of some nonsimply connected homology n -sphere H^n is topologically a sphere: *For every $n \geq 3$, there is a polyhedron P^{n+2} , topologically homeomorphic to the $(n+2)$ -ball, such that $P \times I^{n-2}$ is not collapsible, but $P \times I^{n+3}$ is collapsible.* The example is $P = \Sigma^2 H^n - \text{int } B^{n+2}$, where B^{n+2} is any PL cell in $\Sigma^2 H^n$ disjoint from the suspension circle. In a similar vein, $\Sigma^2 H^n$ provides an example of a nonshellable triangulation of a sphere (see [DK]).

1.2. Polyhedral homology manifolds. Another consequence of the Double Suspension Theorem is the second half of the following assertion (the first half being already known).

THEOREM 2. *Suppose P is a connected polyhedron. If P is a topological manifold, then P is a homotopy manifold (as defined below). Conversely, if P is a homotopy manifold and $\dim P \neq 4 \neq \dim \partial P$, then P is a topological manifold.*

The dimension restriction arises because it is not known whether the cone on a homotopy 3-sphere is a manifold.

Two special cases of the above assertion are as follows:

COROLLARY 1. *Suppose P_1, P_2 are two connected polyhedra, with $\dim P_i \neq 0 \neq \dim \partial P_i$ (the latter nonequality meaning that P_i contains no open set homeomorphic to $[0, 1)$). Then*

- (1) *the product $P_1 \times P_2$ is a topological manifold $\iff P_1$ and P_2 are homology manifolds with homotopically collared boundaries, and*
- (2) *the join $P_1 \star P_2$ is a compact topological manifold (necessarily a ball or sphere) $\iff P_1$ and P_2 are compact homology manifolds with homotopically collared boundaries, such that each of P_1 and P_2 either has the integral homology groups of a sphere, or else is contractible.*

A *polyhedral homology manifold* is a polyhedron P in which the link of each component of each stratum has the integral homology groups of either a sphere or a point. Using duality, this property holds if it is known to hold only for the links of those strata-components which are closed subsets of P . The union of the strata-components whose links are acyclic comprise a subpolyhedron of P , called the *boundary* of P and denoted ∂P ; it can be shown to be a homology manifold-without-boundary.

The strata referred to in this discussion are from any PL stratification of P compatible with the PL structure of the polyhedron. For example, one could let the i^{th} stratum be $K^{(i)} - K^{(i-1)}$, where K is a simplicial complex which is PL homeomorphic to P , and where $K^{(j)}$ denotes the j -skeleton of K . The most natural stratification of a polyhedron P is the minimal one, i.e., the intrinsic PL stratification [Ak, p. 421]. A *vertex* of a stratification is simply a point of the 0-stratum; this stratum may be empty. If one prefers, one may talk about simplicial homology manifolds instead of polyhedral homology manifolds, but the polyhedral setting is the natural one (just as the notion of a PL manifold is a more natural notion than that of a combinatorial manifold).

Much of this material is explained more fully, from the simplicial standpoint, in [Mau, Chapter V].

If a polyhedral homology manifold P is to have the property that $P \times \mathbb{R}^n$ is a topological manifold for some euclidean space \mathbb{R}^n , then P must have the additional property that its acyclic links are in fact contractible (this condition is vacuous if $\partial P = \emptyset$). Let such a P be called a *polyhedral homology manifold with homotopically collared boundary*. The reason for this name is that it can be verified that a polyhedral homology manifold P satisfies this additional property if and only if there is a “homotopy collaring” map $\psi : \partial P \times [0, 1) \rightarrow P$ extending the inclusion $\partial P \times 0 = \partial P \hookrightarrow P$ such that $\psi(\partial P \times (0, 1)) \cap \partial P = \emptyset$. As an example, the polyhedron $P = \Sigma^k M$, for any acyclic compact PL manifold M and any $k \geq 1$, is a polyhedral homology manifold. However, its boundary is homotopically collared if and only if M is simply-connected.

If a polyhedral homology manifold P is itself to be a topological manifold, then in addition it must have the property that the links in both P and ∂P of vertices (as defined above) must be simply connected whenever they have dimension ≥ 2 . Let a polyhedron P which is a polyhedral homology manifold with homotopically collared boundary, and which satisfies this link condition, be called a *polyhedral homotopy manifold* (this terminology may contrast with some earlier usage, but it seems justified, here at least).

PROOF OF THEOREM. In the following discussion, all stratifications of polyhedra will be assumed to be intrinsic stratifications, in order to minimize hypotheses.

The basic case of the assertion is when P is a homotopy manifold-without-boundary. The proof in this case proceeds by induction on the *depth* of P , which is defined to be $\dim P - \dim P_0$, where P_0 is the nonempty stratum of P of lowest dimension (see for example [Si5]). For induction purposes, then, assume $n \geq 0$, and assume it has been established that given any polyhedral homotopy manifold-without-boundary Q , with depth $Q \leq n$ and $\dim Q \neq 4$, then Q is a topological manifold-without-boundary. Suppose P is a polyhedral homotopy manifold-without-boundary with depth $P = n + 1$ and $\dim P \neq 4$. Let P_0 be the nonempty stratum of P of lowest dimension. Then depth $(P - P_0) \leq n$, and hence by the induction hypothesis $P - P_0$ is a topological manifold-without-boundary. Let $k = \dim P_0$, and let L be the link of any component of P_0 . In order to show that P is a manifold, it suffices to establish:

Claim: $\mathring{c}L \times \mathbb{R}^k$ is a topological manifold.

The proof of this is divided into several cases, depending on the dimension of L .

CASE 1. $\dim L \leq 2$.

Then L is topologically a sphere, hence the claim follows.

CASE 2. $\dim L = 3$.

Then L is a (manifold) homology 3-sphere. Hence the claim follows from the Double Suspension Theorem (note that $k \geq 1$ in this case, since $\dim P \neq 4$).

CASE 3. $\dim L \geq 4$.

We have that $\text{depth}(L \times \mathbb{R}^1) (= \text{depth } L) < \text{depth } P$, and hence by the induction hypothesis the polyhedral homotopy manifold-without-boundary $L \times \mathbb{R}^1$ is a topological manifold. By the Proposition in Part II, $L \times \mathbb{R}^1$ is embeddable as a neighborhood of the end of some open contractible topological manifold M . If

$k = 0$, then by hypothesis L is homotopically a sphere, hence M is homeomorphic to \mathbb{R}^m ([Si1], or [St] coupled with the fact that M has PL manifold structure). Hence $\mathring{c}L$, which is homeomorphic to the 1-point semicompactification of the end, is a manifold. If $k \geq 1$, then $\mathring{c}L \times \mathbb{R}^k$, being homeomorphic to $M/X \times \mathbb{R}^1$, is a manifold by Part II, where $X = M - L \times \mathbb{R}^1$. This establishes the basic case of the Theorem.

(Technical aside: When only the triple suspension theorem was known for homology 3-spheres, and hence the above assertion required the additional restriction $\dim P \neq 5 \neq \dim \partial P$, the last part of this argument, for the case $\dim L = 4$ and $k \geq 2$, had to be established by a more complicated argument.)

In the general case, when $\partial P \neq \emptyset$, the preceding argument can be augmented by using the following collar argument, which avoids some delicate link analysis at ∂P . Let Q be gotten from P by attaching to P an exterior boundary collar, this being denoted

$$Q = (P + \partial P \times [0, 1]) / \partial P = \partial P \times 0.$$

Hence $\partial Q = \partial P \times 1$. By the without-boundary case, both ∂Q and $Q - \partial Q$ are manifolds, hence Q is a manifold. Furthermore the given collar $\partial P \times [0, 1]$ for ∂Q in Q is 1-LCC (1-locally co-connected) in Q , that is, small loops in $Q - \partial P \times [0, 1]$ (sizes measured in the metric of Q) are null-homotopic in $Q - \partial P \times [0, 1]$ by small homotopies. Hence, a now-standard radial engulfing argument ([Se]; see [Da3, §3]) shows that the interval-fibers of this collar in Q can be shrunk to points by pseudoisotopy of Q , and hence Q is homeomorphic to the quotient space, which is P . \square

REMARK 1. *It can be deduced from the recent work of Cannon [Can2] combined with Cannon [Can3] or Bryant-Lacher [BL2] that the purely topological analogue of the assertion above is true. That is, it remains true with polyhedron replaced by its topological analogue, namely a conelike-stratified (CS) set as defined by Siebenmann in [Si5]. Although links in cone-like stratified sets are not intrinsically well-defined, they become intrinsically well-defined after crossing them with euclidean space of dimension equal to their codimension. Hence the homotopy type of “the” link makes sense. The existence of intrinsic stratifications for conelike-stratified sets was established by M. Handel in [Han].*

1.3. Wild embeddings with mapping cylinder neighborhoods. Another consequence of the Double Suspension Theorem is:

THEOREM 3. *For any given dimension $m \geq 5$, there exists a topological embedding of a circle into an m -manifold such that the embedding has a manifold mapping cylinder neighborhood, and yet the embedding is not locally flat.*

Such an example cannot exist in dimensions $m \leq 4$ (see [BL2]). The example is provided by the suspension circle embedded in $\Sigma^2 H^n \approx S^{n+2}$, for any non-simply-connected homology sphere H^n . This particular embedding is homogeneous by ambient isotopy. Note that this shows, for example, that there is no reasonable notion of an ‘intrinsically’ good point of an embedding (one might conjecture such a notion after learning statements such as “any circle in euclidean space is tame modulo a 0-dimensional F_σ subset”).

1.4. Codimension two embeddings. Since the work of Kirby-Siebenmann, it has been known that there exists a topologically locally flat codimension 2 embedding of one PL manifold into another, such that the embedding cannot be ambient isotoped to be piecewise linearly locally flat. For example, one can take the inclusion $S^3 = S^3 \times 0 \hookrightarrow (S^3 \times \mathbb{R}^2)_\theta$, where $(S^3 \times \mathbb{R}^2)_\theta$ denotes the PL manifold obtained by putting the nonstandard PL structure θ on $S^3 \times \mathbb{R}^2$ [KS1]. The Double (or Multiple) Suspension Theorem provides another example, for given any homology 3-sphere H^3 , and any PL manifold $M^m, m \geq 0$, the homeomorphism $\Sigma^2 H^3 \times M^m \approx S^5 \times M^m$ can be chosen to be piecewise linearly locally flat on $H^3 \times M^m \Leftrightarrow$ the Rokhlin invariant of H^3 is 0. The proof will not be given here; it uses the same argument that was used in Section I above, involving transversality and Rokhlin's theorem.

1.5. Exotic group actions. It is well known that the Double Suspension Theorem establishes that *there is a nonstandard semifree action of S^1 on S^5 which is piecewise linear with respect to some polyhedral structure on S^5* . For there is a natural semifree action of S^1 on $\Sigma^2 H^3 = S^1 * S^3 \approx S^5$ with fixed point set H^3 . Another interesting group action, pointed out to me by F. Raymond and H. Samelson, is the following: *there is a topological action of $SO(3)$ on S^7 with all isotropy groups discrete*. (Compare [MS] and [OI]; the latter work in fact exhibits such an action which is smooth.) This action follows from the fact that $S^7 \approx H^3 * H^3$, where H^3 is Poincaré's binary dodecahedral homology 3-sphere (cf. II above). The action of $SO(3)$ is the diagonal action.

2. Preliminaries: Cell-like decompositions and the Bing Shrinking Criterion

The suspension problem for homology spheres is a problem in the theory of cell-like upper semicontinuous decompositions of manifolds. This venerable subject, fathered by R.L. Moore and developed largely by R.H. Bing, studied the class of proper cell-like maps $\{f : M \rightarrow Q\}$ from manifolds onto metric spaces (definitions below). The major problem of the subject is *to decide when the quotient* (i.e. target) *space Q is a manifold, or at least when $Q \times \mathbb{R}^k$ is a manifold, for some k* .

The link between the suspension question for homology spheres and cell-like decomposition theory became apparent as a result of the Newman, Poenaru and Mazur constructions of homology n -spheres which bound contractible $(n + 1)$ -manifolds (recalled in Part I). For suppose $H^3 = \partial M^4$, where M^4 is a contractible 4-manifold. Let X be a spine of M , that is, let $X = M - \partial M \times [0, 1)$, where $\partial M \times [0, 1)$ denotes any open collar for ∂M in M . Then $\Sigma^k H^3$ is a sphere if and only if $M/X \times \mathbb{R}^{k-1}$ is a manifold (as explained in the Introduction), where M/X denotes the quotient space of M gotten by identifying X to a point; clearly $M/X \approx c(\partial M)$. So the suspension question becomes one of determining whether the target of the cell-like map $M \rightarrow M/X$ is stably a manifold.

In the subject of cell-like decompositions of manifolds, there are two landmark results of a general character, the Shrinking Theorem of Bing, and the Cellular Approximation Theorem of Armentrout and Siebenmann. Both concern the question of approximating certain maps by homeomorphisms.

The version of Bing's theorem which I prefer is the following if-and-only-if version. In applications of this theorem, invariably M is a manifold, f is a cell-like surjection and the problem is to decide whether Q is a manifold. The significance

of Bing's theorem was to turn attention from the target space Q , where it had been focused since R.L. Moore's work [Mo] on cell-like decompositions of the plane, to the source space M , where one had the obvious advantage of working in a space known to be a manifold. The justification for the approximation statement in the theorem will become clear after the next theorem.

SHRINKING THEOREM (Bing 1952, from [Bi1, Section 3 II, III]; compact version). *A surjection $f : M \rightarrow Q$ of compact metric spaces is approximable by homeomorphisms if and only if the following condition holds (now known as the Bing Shrinking Criterion): Given any $\epsilon > 0$, there exists a homeomorphism $h : M \rightarrow M$ such that*

- (1) distance $(fh, f) < \epsilon$, and
- (2) for each $y \in Q$, $\text{diam}(h(f^{-1}(y))) < \epsilon$.

There are many refinements and addenda one can make to this theorem, the most significant having to do with realizing f by pseudoisotopy versus realizing h by ambient isotopy. These will be not discussed here. Bing used the theorem in much of his subsequent work, including [Bi2, proofs of Theorems], [Bi3, Section 8] and [Bi4, §3 and Thm2]. McAuley [McA 1] was the first person to broaden the theorem to the above generality; his proof was a straightforward adaptation of Bing's.

The easy half of the proof of the theorem is the implication \Rightarrow ; one simply writes $h = g_0^{-1}g_1$ for two successively chosen homeomorphisms g_0, g_1 approximating f . The nontrivial, and significant half of the theorem is the implication \Leftarrow . Bing's idea here was to construct a surjection $p : M \rightarrow M$, with fp close to f , such that the point-inverse sets of p coincide exactly with those of f . Then $g \equiv fp^{-1} : M \rightarrow Q$ defines the desired homeomorphism approximating f . The map p is constructed as a limit of homeomorphisms $p = \lim_{i \rightarrow \infty} h_1 h_2 \dots h_i$ where the h_i 's are provided by the Shrinking Criterion, for ϵ_i values which go to 0 and i goes to ∞ . The heart of the proof is showing how to choose each ϵ_i , the main point being that it depends on the composition $h_1 \dots h_{i-1}$. Details are given in many places, for example, [Ch, pp. 45,46].

This proof of the implication \Leftarrow becomes quite transparent when recast as a Baire category argument. For in the Baire space $C(M, Q)$ of maps from M to Q , with the uniform metric topology, let E be the closure of the set $\{fh \mid h : M \rightarrow M \text{ is a homeomorphism}\}$. The Bing Shrinking Criterion amounts to saying that for any $\epsilon > 0$, the open subset of ϵ -maps in E , call it E_ϵ , is dense in E . Hence $E_0 \equiv \bigcap_{\epsilon > 0} E_\epsilon$ is dense in E , since E is a Baire space. Since E_0 consists of homeomorphisms, this shows that $f \in E$ is approximable by homeomorphisms.

In applying the above Shrinking Theorem to show that various of his decomposition spaces were manifolds, possibly after stabilizing ([Bi1][Bi2][Bi3]), Bing used only the "if" part of the theorem, establishing that his Criterion held, i.e. establishing that the decomposition was shrinkable. But to show that his dog-bone decomposition space was **not** a manifold, Bing used the "only if" part of the theorem, bridging the gap by showing that if the decomposition space Q were a manifold, then the quotient map $f : \mathbb{R}^3 \rightarrow Q$ would have to be approximable by homeomorphisms [Bi3, Section 8]. This result has been generalized to become the

CELLULAR APPROXIMATION THEOREM. (extending Moore [Mo] for $m = 2$, see [McA 2, §11]; Armentrout [Ar] for $m = 3$; Siebenmann [S16] for $m \geq 5$; compact without-boundary version). *Suppose $f : M^m \rightarrow Q^m$ is a map of closed manifolds, $m \neq 4$. Then f is a cell-like surjection (read cellular if $m = 3$) if and only if f is approximable by homeomorphisms.*

The previously known “if” part is quite easy, and holds for all m . The “only if” part requires some highly sophisticated geometrical analysis.

The significance of these two theorems taken together is clear:

The problem of deciding whether a particular cell-like image of a manifold-without-boundary is itself a manifold is equivalent to deciding whether the Bing Shrinking Criterion holds in the source (dimension 4 excepted).

The subject of cell-like decompositions of manifolds developed in the 1950’s into a robust and active theory, thanks to Bing’s spectacular series of theorems. By comparison, progress throughout the 1960’s was gradual. From 1960 on, the duncehat decomposition problem for $M^4 \times \mathbb{R}^1$ (explained in Part I) was a natural problem to work on; from about 1970 on, it was the natural problem to work on.

In this paper, only the “if” part of Bing’s Shrinking Theorem is used. But the psychological comfort provided by Siebenmann’s theorem was vital to this work.

3. Definitions and notation

Throughout this paper, *all spaces are locally compact separable metric*, and all manifolds are topological manifolds, possibly with boundary, unless states otherwise. All definitions are standard.

The (single) *suspension* of a compact metric space Y , denoted ΣY , is the quotient of $Y \times [-1, 1]$ gotten by identifying to distinct points the two subsets $Y \times \pm 1$. The k -fold *suspension* $\Sigma^k Y$ is $\Sigma(\dots(\Sigma Y)\dots)$ (k times); if $k = 0$, this is understood to be Y . Equivalently, $\Sigma^k Y$ can be defined to the join, $Y * S^{k-1}$ of Y with the $(k-1)$ -sphere. It follows that $Y * S^{k-1} - S^{k-1}$ is homeomorphic to $Y \times \mathbb{R}^k$, and $Y * S^{k-1} - Y$ is homeomorphic to $\mathring{c}Y \times S^{k-1}$, where $\mathring{c}Y$ denotes the *open cone* on Y , that is, $\mathring{c}Y = Y \times [0, 1)/Y \times 0$.

A compact metric space is *cell-like* provided that whenever it is embedded in an ANR (e.g., in the Hilbert cube), it is null-homotopic inside of any given neighborhood of itself in the ANR (see [Lac1] and [Lac2] for an elaboration of this and related facts). A map $f : X \rightarrow Y$ of spaces is *proper* provided the preimage of any compact subset of Y is compact, and f is *cell-like* provided it is onto and each point-inverse is cell-like. A *cell-like upper-semicontinuous decomposition* of a space X is nothing more than a proper cell-like surjection from X onto some (quotient) space Y .

Standard notations are $\text{int}_X A$, $\text{cl}_X A$ and $\text{fr}_X A$ for the *interior*, *closure* and *frontier* of a subset A in a space X ; the subscript X is omitted whenever it is clear. In this paper careful distinction is made between the notions of *boundary* and *frontier*, the former being used only in the manifold sense, e.g. ∂M , and the latter being used only in the point-set sense, e.g. $\text{fr } A$.

This paper is concerned largely with constructing homeomorphisms and ambient isotopies of manifolds. The ambient manifolds can always be assumed to be piecewise linear (or smooth, if one prefers), and it will be convenient to use

the well-established concepts of piecewise linear topology, e.g., regular neighborhoods, expansions and collapses, and transversality. As an example, the phrase “ J is transverse to $M \times 0$ in $M \times \mathbb{R}^1$ ”, where J is a polyhedron (homeomorphic to $K \times \mathbb{R}^1$, in Part I) and M is a manifold, will mean that there is a bicollar $\alpha : M \times (-1, 1) \rightarrow M \times \mathbb{R}^1$ for $M = M \times 0$ in $M \times \mathbb{R}^1$ (which, after ambient isotopy fixing $M \times 0$, can be assumed to be the standard bicollar) such that $\alpha|(J \cap M \times (-1, 1))$ is a bicollar for $J \cap M \times 0$ in J (everything *PL*).

Part I

The double suspension of Mazur's
homology 3–sphere is S^5

The goal of this part is to show that the double suspension of a certain homology 3-sphere described by Mazur is homeomorphic to S^5 (this was announced in [Ed2]). The proof is completely descriptive, so that in particular one can see the wild suspension circle in S^5 materialize as a limit of tame circles.

By Lefschetz duality, the boundary of any compact contractible manifold is a homology sphere. Examples of contractible $(n + 1)$ -manifolds with nonsimply connected boundary (i.e. genuine homology n -sphere boundary), for $n \geq 4$, were first constructed by Newman [New1], by taking the complement in S^{n+1} of the interior of a regular neighborhood of any acyclic, nonsimply-connected 2-complex (some applications of this construction appear in [Wh2], [CW] and [CZ]). Constructions were subsequently given for $n = 3$ by Poenaru [Po] and Mazur [Maz]. In this part we are interested in the simplest possible such construction, of lowest possible dimension, namely $n = 3$.

The Poenaru construction goes as follows. Take the product

$$P^4 \equiv (S^3 - \text{int } N(K_0)) \times [-1, 1]$$

of a compact, nontrivial knot complement with an interval, and attach to it a 4-ball B^4 by gluing a tubular neighborhood $N(K_1)$ of a nontrivial knot K_1 in ∂B^4 to a tubular neighborhood of a meridian $\mu \times 0$ in P^4 . This is the desired manifold, which can be written $M^4 = (P^4 \cup B^4)/[N(\mu \times 0) = N(K_1)]$. The advantage of this construction of Poenaru is the ease with which one can verify that (1) M^4 is contractible, since the attached 4-ball kills $\pi_1(P^4)$, and (2) ∂M^4 is not simply connected, since it is the union of two knot complements, and the Loop Theorem implies that for any nontrivial knot K in S^3 , $\pi_1(\partial N(K)) \rightarrow \pi_1(S^3 - \text{int } N(K))$ is monic. The disadvantage of this construction (for the purposes of Part I) is that the spine of M^4 , although it can be chosen 2-dimensional, is not especially simple.

Mazur's construction, on the other hand, starts with the simplest possible spine, i.e. the simplest contractible but noncollapsible polyhedron, namely the 2-dimensional duncehat, and thickens it to be a 4-manifold with nonsimply connected boundary. Recall that the duncehat can quickly be described as the space gotten by attaching a 2-cell B^2 to a circle S^1 by sewing ∂B^2 to S^1 by a degree one map which goes twice around S^1 in one direction, and once around in the other direction. Since Mazur's homology 3-sphere is the one we work with, we recall further details and establish some notation.

The duncehat K^2 and its thickening M^4 will be described together, making use of Figure I-1.

It is convenient to express M^4 as a union of a 0-handle D^4 , a 1-handle $B^1 \times D^3$ and a 2-handle $B^2 \times D^2$. Let L^1 be the 1-complex embedded in ∂D^4 as shown in Figure I-1a.

L^1 is usually referred to as the *linked eyeglasses*. The intersection $K^2 \cap D^4$ is to be cL^1 , where the coning is done to the centerpoint of D^4 . The 1-handle $B^1 \times D^3$ is attached to D^4 as shown in Figure I-1b, and $K^2 \cap S^1 \times \partial D^3$ is defined to be the familiar Mazur curve Γ in $S^1 \times \partial D^3$. The intersection $K^2 \cap S^1 \times D^3$ is to be regarded as the mapping cylinder of an apparent degree one map from Γ onto the core $S^1 \times 0$ of $S^1 \times D^3$. Finally, the 2-handle $B^2 \times D^2$ is attached to $S^1 \times B^3$ by identifying $\partial B^2 \times D^2$ with a neighborhood of Γ in $S^1 \times \partial D^3$ in such a manner that $\partial B^2 \times 0$ is identified to Γ . Then $K^2 \cap B^2 \times D^2$ can be taken to be $B^2 \times 0$. The "twisting" of the attaching map here (in the direction perpendicular to Γ) is not specified, because it is irrelevant in the upcoming constructions.

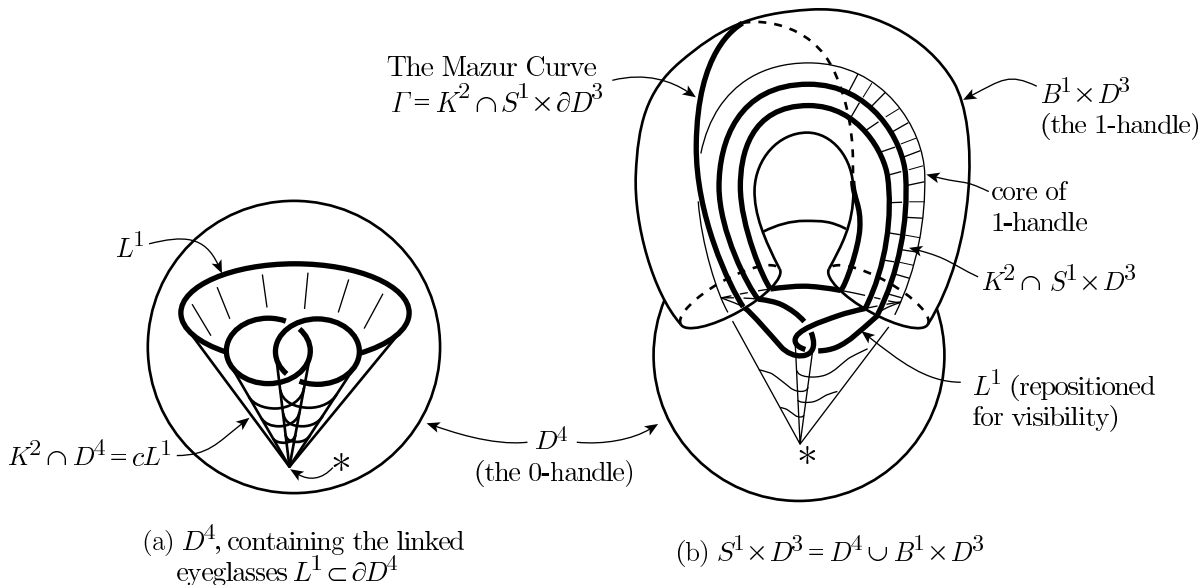

FIGURE I-1. The Mazur 4-manifold $M^4 = 0\text{-handle } D^4 \cup 1\text{-handle } B^1 \times D^3 \cup 2\text{-handle } B^2 \times D^2$, and its duncehat spine K^2

The only properties of the pair (M^4, K^2) used below are:

- (i) M^4 is a contractible PL manifold, and K^2 is a polyhedral spine of M^4 ;
- (ii) $K^2 - K^{(1)}$ is an open 2-cell locally flatly embedded in $\text{int } M^4$, where $K^{(1)}$ denotes the intrinsic 1-skeleton of K^2 , namely $S^1 \times 0$; and
- (iii) near $* \in K^2$, the embedding of K^2 in $\text{int } M^4$ is as described in Figure I-1.

To prove that $\Sigma^2(\partial M^4) \approx S^5$, i.e. that $M^4/K^2 \times \mathbb{R}^1$ is a manifold, it suffices to establish that the Bing Shrinking Criterion holds for the stabilized quotient map $\pi \times id_{\mathbb{R}^1} : M \times \mathbb{R}^1 \rightarrow M/K \times \mathbb{R}^1$. This amounts to establishing the

SHRINKING PROPOSITION. *Given any $\varepsilon > 0$, there is a homeomorphism $h : M^4 \times \mathbb{R}^1 \rightarrow M^4 \times \mathbb{R}^1$, fixed on $\partial M^4 \times \mathbb{R}^1$, such that for each $t \in \mathbb{R}^1$,*

- (1) $h(M \times t) \subset M \times [t - \varepsilon, t + \varepsilon]$, and
- (2) $\text{diam}(h(K^2) \times t) < \varepsilon$.

TECHNICAL NOTES. The following brief comments concern the precise relation of the above statement to the Bing Shrinking Criterion as stated in the Preliminaries: (a) If one prefers to stay in the world of compacta, one can replace \mathbb{R}^1 by S^1 ; the reasons that \mathbb{R}^1 is used here are (i) tradition, and (ii) the notion of, and notation for, “vertical” and “horizontal” motions are more natural in $M \times \mathbb{R}^1$ than in $M \times S^1$; (b) tradition has the homeomorphism h being uniformly continuous, which in fact it is by construction but that is not really necessary; and (c) in the above statement of the Shrinking Proposition, the Bing Shrinking Criterion really demands that ∂M be replaced by $M - \text{int } N_\varepsilon(K)$, but this stronger statement is clearly deducible from the given one by replacing M by a small regular neighborhood of K in M .

The above homeomorphism h will be isotopic to the identity *rel* $\partial M \times \mathbb{R}^1$, by construction. This is useful to keep in mind when trying to visualize it.

To understand the motivation for the following construction of h , recall the basic principle:

h is to be thought of as being an arbitrarily close approximation to a surjection $p : M \times \mathbb{R}^1 \rightarrow M \times \mathbb{R}^1$, whose nontrivial point-inverses are precisely the sets $\{K \times t \mid t \in \mathbb{R}^1\}$.

This is because in Bing's proof of the implication \Leftarrow of his theorem (see the Preliminaries), he constructs p as a limit $p = \lim_{i \rightarrow \infty} h_1 h_2 \dots h_i$, where the h_i 's are homeomorphisms provided by the Shrinking Proposition, for smaller and smaller values of ϵ . (Recall that from this map p one gets the desired homeomorphism g approximating the quotient map $\pi \times id_{\mathbb{R}^1} : M \times \mathbb{R}^1 \rightarrow M/K \times \mathbb{R}^1$ by defining $g = (\pi \times id_{\mathbb{R}^1})p^{-1} : M \times \mathbb{R}^1 \xrightarrow{\approx} M/K \times \mathbb{R}^1$.)

Now, the image $p(K \times \mathbb{R}^1)$ ($\approx \mathbb{R}^1$) in $M \times \mathbb{R}^1$ must have the following remarkable pathological property (recognized by Glaser in [G12, p. 16, last two paragraphs]):

for each $t \in \mathbb{R}^1$, the intersection $p(K \times \mathbb{R}^1) \cap M^4 \times t$ must be 0-dimensional, yet wild enough so that the inclusion $\partial M^4 \times t \hookrightarrow M \times t - p(K \times \mathbb{R}^1)$ induces a π_1 -monomorphism.

The second assertion follows because the inclusion

$$\partial M^4 \times t \hookrightarrow M^4 \times \mathbb{R}^1 - p(K \times \mathbb{R}^1)$$

must induce a π_1 -monomorphism, which is clear from the properties of p . The first assertion follows because if $p(K \times \mathbb{R}^1) \cap M^4 \times t$ were not 0-dimension, then there would exist some interval $(a, b) \subset \mathbb{R}^1$ such that $p(K \times (a, b)) \subset M^4 \times t$, which would then guarantee that the interval $p(K \times (a, b))$ would be locally flatly embedded in $M \times \mathbb{R}^1$ (say by the Klee trick, as in [CW, Part II]), and hence ∂M would be simply connected (e.g. by general positioning off of $p(K \times \mathbb{R}^1)$ in $M \times \mathbb{R}^1$ a 2-disc initially mapped into $p(M \times c)$, $c = \text{midpoint of } (a, b)$, and then pushing this 2-disc out to $\partial M \times \mathbb{R}^1$). Consequently, if the homeomorphism h of the Shrinking Proposition is to approximate p , then given $\epsilon > 0$ one must be able to construct a homeomorphism h having the following property:

for each $t \in \mathbb{R}^1$, each component of the intersection $h(K \times \mathbb{R}^1) \cap M \times t$ has diameter $< \epsilon$ (and yet necessarily the inclusion $\partial M \times t \hookrightarrow M \times t - h(K \times \mathbb{R}^1)$ must induce a π_1 -monomorphism).

This is what motivates the construction below.

The Basic Lemma below (or more accurately, the first 3 steps of it) shows how to construct such a homeomorphism h having this intersection property with respect to the single level $M \times 0$. This Lemma is the heart of the entire proof; everything after it amounts to tidying up.

The first, second and fourth steps of the Basic Lemma involve splitting operations, which are called either meiosis or mitosis, depending on the context. They are the freshest ingredients of the proof.

The Lemma requires a definition. Given a homeomorphism $h : M \times \mathbb{R}^1 \rightarrow M \times \mathbb{R}^1$, then a component C of $h(K \times \mathbb{R}^1) \cap M \times 0$ is *source-isolated* if $h^{-1}(C)$ is isolated in $K \times \mathbb{R}^1$, in the sense that there is an interval $(a, b) \subset \mathbb{R}^1$ such that $K \times (a, b) \cap h^{-1}(M \times 0) = h^{-1}(C)$. In the statement below, C most often will be a 2-sphere lying in $h(K - K^{(1)}) \times \mathbb{R}^1$, in which case source-isolation will imply that $h^{-1}(C)$ bounds a 3-cell in $K \times \mathbb{R}^1$ whose interior misses $h^{-1}(M \times 0)$.

One should think of the following lemma as starting at $i = 0$, with $h_0 = \text{identity}$, and producing successively better approximations to the desired homeomorphism h of the Shrinking Proposition.

BASIC LEMMA $_i$ (to be read separately and successively for $i = 1, 2, 3, 4$). *Given $\delta > 0$, there exists a homeomorphism $h_i : M \times \mathbb{R}^1 \rightarrow M \times \mathbb{R}^1$, with compact support in $\text{int } M \times \mathbb{R}^1$, such that $h_i(K \times \mathbb{R}^1)$ is transverse to $M \times 0$ and the components of $h_i(K \times \mathbb{R}^1) \cap M \times 0$ are as follows.*

($i = 1$) *There are two components. One is a pierced duncehat (described below) having diameter $< \delta$, and the other is a source-isolated 2-sphere $\Sigma^2 \times 0$, where $\Sigma^2 \subset M^4$.*

Let $\Sigma^2 \times D^2$ be a product neighborhood of Σ^2 in M^4 .

($i = 2$) *There are $1 + 2^p$ components ($p = p(\delta)$). One is the δ -small pierced duncehat from Step 1, and the remaining 2^p are source-isolated 2-spheres lying in $\Sigma^2 \times D^2 \times 0$, such that this collection of 2^p 2-spheres in $\Sigma^2 \times D^2 \times 0$ is equivalent to the p^{th} stage in the spun Bing collection of 2-spheres in $S^2 \times D^2$ (described below).*

($i = 3$) *There are $1 + 2^p$ components (same $p = p(\delta)$). One is the δ -small pierced duncehat, and the remaining 2^p are source-isolated δ -small 2-spheres in $\Sigma^2 \times D^2 \times 0$.*

($i = 4$) *There are $1 + 2^{p+1}$ components (same $p = p(\delta)$). One is the δ -small pierced duncehat, and the remaining 2^{p+1} are δ -small embedded duncehats lying in $\Sigma^2 \times D^2 \times 0$, each being the image under h_4 of some entire level $K \times t_q, 1 \leq q \leq 2^{p+1}$.*

NOTE. In using the above Lemma later, all we will really care about is the intersection of $h_i(K \times \mathbb{R}^1)$ with the 2-handle $B^2 \times D^2 \times 0 \subset M^4 \times 0$, not with the entire level $M^4 \times 0$. But we have stated the Lemma in the above elaborated form to make the overall process a little clearer.

PROOF. It is best to gain first a qualitative understanding of the components of $h_i(K \times \mathbb{R}^1) \cap M \times 0$, for $i = 1, \dots, 4$, without paying attention to their size. For this purpose, it is easiest to work in the source, understanding there the pre-images $K \times \mathbb{R}^1 \cap h_i^{-1}(M \times 0)$. After this one can come to grips with the images $h_i(K \times \mathbb{R}^1) \cap M \times 0$, and the size of their components. Following this advice, we present the construction in two rounds, in the first round just working in the source, describing there the sets $K \times \mathbb{R}^1 \cap h_i^{-1}(M \times 0), 1 \leq i \leq 4$, and their components. In the second round we pay attention to how these components are embedded in $M \times 0$, and their size.

In the first round of the construction, each set $h_i^{-1}(M \times 0), 1 \leq i \leq 4$, will be described as the frontier in $M \times \mathbb{R}^1$ of an arbitrarily small (relative) regular neighborhood in $M \times \mathbb{R}^1$ of a subpolyhedron A_i of $M \times \mathbb{R}^1$, where

$$M \times (-\infty, 0] = A_0 \nearrow A_1 \wedge \dots \wedge A_2 = A_3 \wedge A_4.$$

Here the arrows indicate expansions and collapses. Each A_i will contain A_0 , and $\text{cl}(A_i - A_0)$ will be a compact 2-dimensional polyhedron in $\text{int } M \times \mathbb{R}^1$. The regular neighborhoods will be relative to $\partial M \times (-\infty, 0]$, and hence the intersection of their frontiers with $\partial M \times \mathbb{R}^1$ will be $\partial M \times 0$. Each regular neighborhood is to be chosen

so that its restriction to $K \times \mathbb{R}^1$ is a regular neighborhood in $K \times \mathbb{R}^1$ of the subpolyhedron $B_i \equiv A_i \cap K \times \mathbb{R}^1$. The successive sets $\{h_i^{-1}(M \times (-\infty, 0])\}$, $1 \leq i \leq 4$, can be thought of as gotten by applying the uniqueness of regular neighborhoods principle, with each homeomorphism h_i being the end of an ambient isotopy. (This regular neighborhood description, from my Cambridge notes, is not quite the manner in which I originally perceived the h_i 's, but it is the quickest way to describe them.)

The (A_i, B_i) 's are as follows (see Figure I-3).

Step i = 0. $A_0 = M \times (-\infty, 0]$; $B_0 = K \times (-\infty, 0]$.

Step i = 1 (first round). Let $a \in L^1$ be the midpoint of the interval part of the linked eyeglasses L^1 (see Figure I-2).

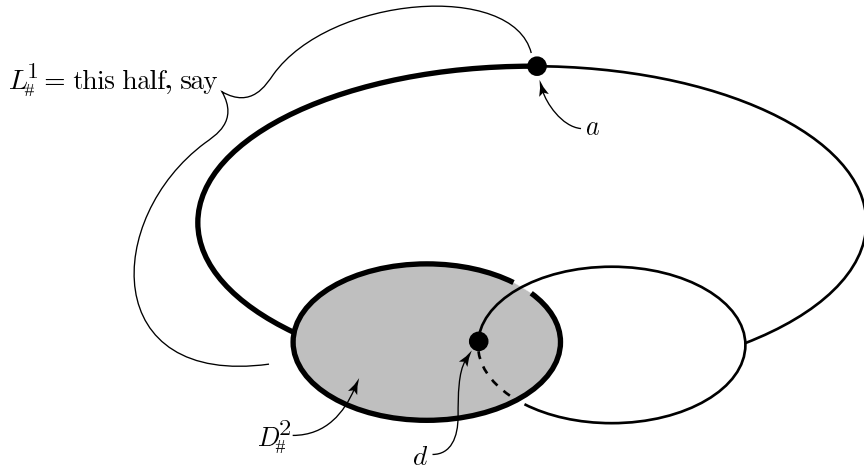

FIGURE I-2. $L^1 =$ linked eyeglasses $\subset \partial D^4$

Let $L^1_{\#}$ be the closure of one of the components of $L^1 - a$ (either one); hence $L^1_{\#}$ is a circle with a feeler attached, with the free end of the feeler being the point a . Let $D^2_{\#}$ be the natural 2-disc that the circle of $L^1_{\#}$ bounds in ∂D^4 , so that $D^2_{\#} \cap L^1 = \partial D^2_{\#} \cup d$, where d is an interior point of $D^2_{\#}$. Writing the 0-handle D^4 of M^4 as $D^4 = \partial D^4 \times [0, 1] \cup *$, then define

$$A_1 = A_0 \cup (L^1_{\#} \cup D^2_{\#}) \times \frac{1}{2} \times 1 \cup a \times \frac{1}{2} \times [0, 1] \subset A_0 \cup D^4 \times \mathbb{R}^1 \subset M \times \mathbb{R}^1$$

(see Figure I-3₁).

In other words, $A_1 - A_0$ lies in $\partial D^4 \times \frac{1}{2} \times [0, 1]$, where $[0, 1]$ is a sub-interval of the vertical coordinate \mathbb{R}^1 of $M \times \mathbb{R}^1$, and $A_1 - A_0$ consists of a horizontal 2-disc-with-feeler lying in the $M \times 1$ level, together with the vertical interval joining the free end of the feeler to the $M \times 0$ level. Let A_{δ} denote A_1 minus the interior of the 2-disc $D^2_{\#} \times \frac{1}{2} \times 1$, and let $B_{\delta} = A_{\delta} \cap K \times \mathbb{R}^1$, which is $K \times (-\infty, 0]$ with a circle-with-feeler attached. By the construction, $B_1 = B_{\delta} \cup d \times \frac{1}{2} \times 1$, which has two components, one of them a point.

The set $K \times \mathbb{R}^1 \cap h_1^{-1}(M \times 0)$, being the frontier in $K \times \mathbb{R}^1$ of a regular neighborhood of B_1 in $K \times \mathbb{R}^1$, will consist of two components, one of them the 2-sphere boundary of a 3-ball, and the other a *pierced duncehat* (see Figure I-4).

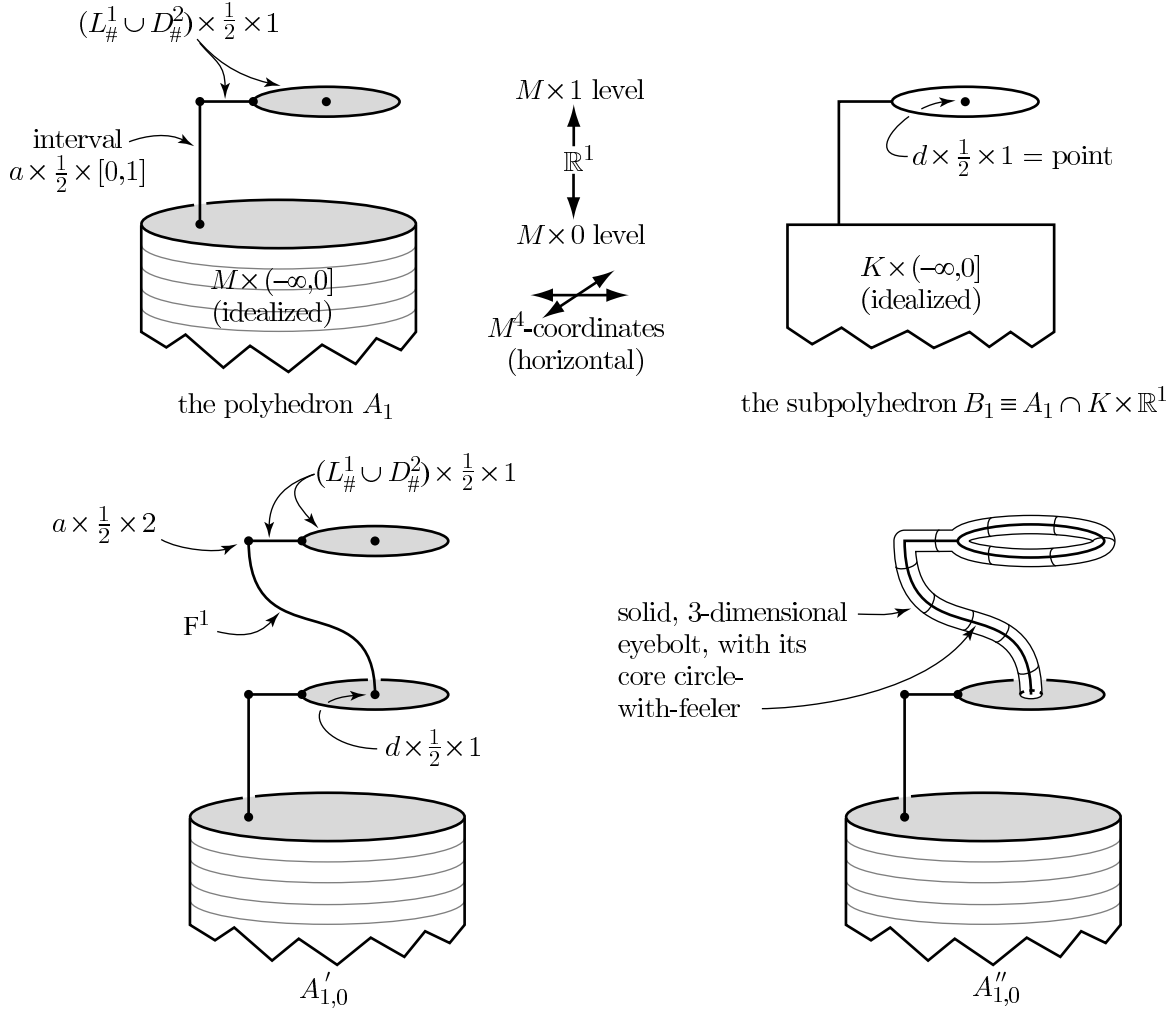

As an abstract set, a pierced duncehat $K_{\#}^2$ can be described as the union of a duncehat-with-hole and a 2-torus, the boundary of the hole being identified with an essential curve on the 2-torus. In symbols,

$$K_{\#}^2 = (K^2 - \text{int } C^2) \cup_{\partial C^2 = S^1 \times \text{point}} S^1 \times S^1,$$

where C^2 is a 2-cell in $K^2 - K^{(1)}$. This will be taken up again in the second round; for the moment, our main concern is to define the sets $\{h_i^{-1}(M \times (-\infty, 0])\}$ and (therefore) $\{K \times \mathbb{R}^1 \cap h_i^{-1}(M \times (-\infty, 0])\}$, leaving to be specified the actual behavior of the h_i 's on these sets.

Step i = 2 (first round). This is the interesting step. The polyhedron A_2 will be described in stages, by describing a finite sequence of polyhedra

$$A_1 = A_{1,0} \frown A_{1,1} \frown \dots \frown A_{1,p-1} \frown A_{1,p} = A_2$$

where p is to be specified. The first expansion-collapse is typical of them all; it is described using two expansions and a collapse, plus a final repositioning:

$$A_{1,0} \nearrow A'_{1,0} \nearrow A''_{1,0} \searrow A'''_{1,0} \rightsquigarrow A_{1,1}$$

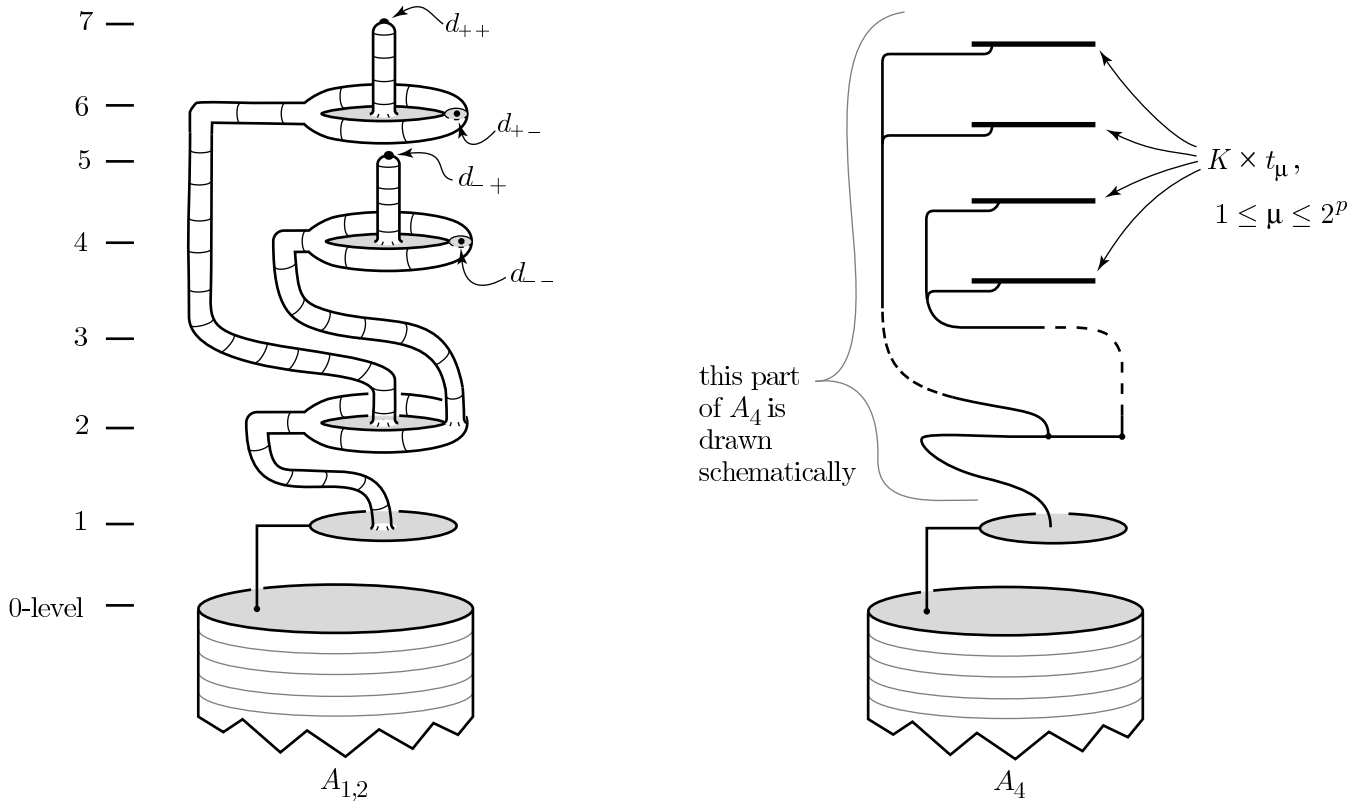
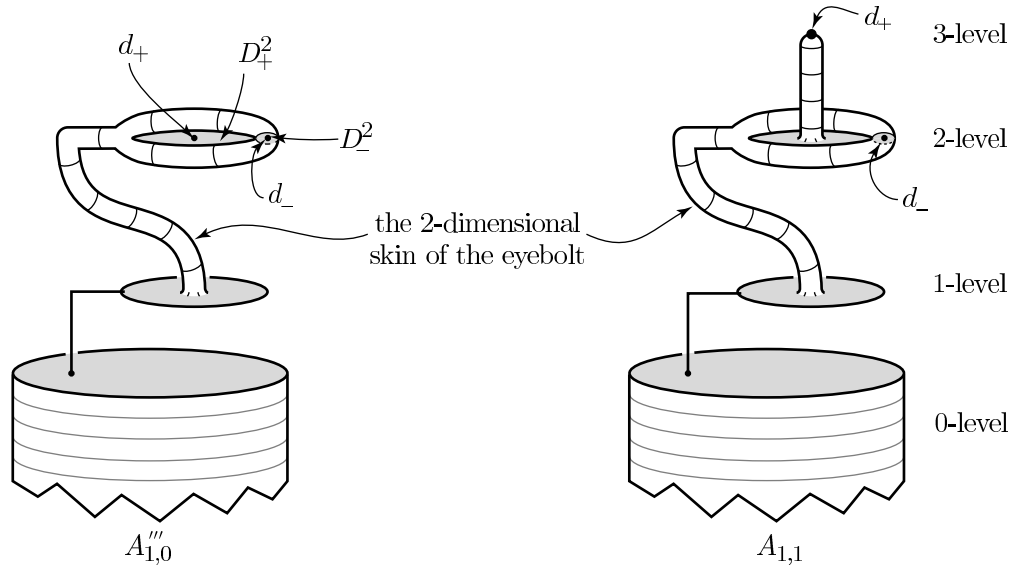
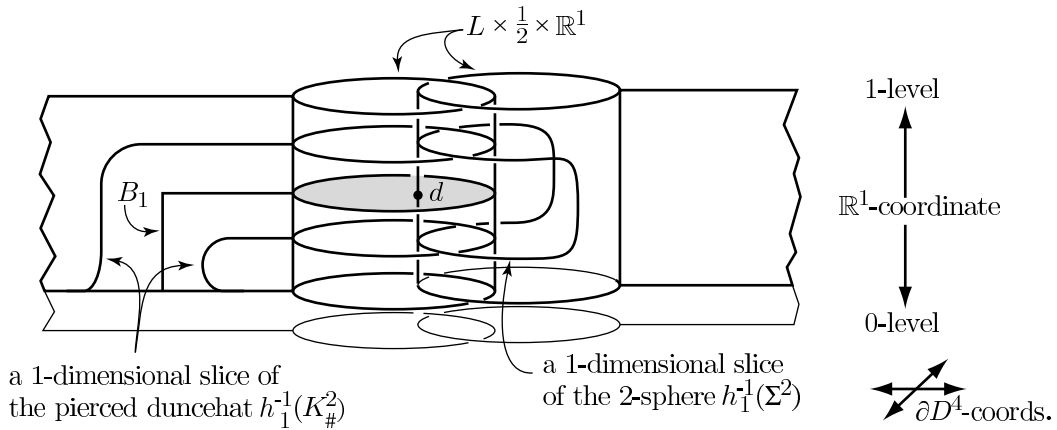

Figure I-3₂, end

Figure I-3₄

(see Figure I-3₂).



a 1-dimensional slice of the pierced duncehat $h_1^{-1}(K_{\#}^2)$

a 1-dimensional slice of the 2-sphere $h_1^{-1}(\Sigma^2)$

Part (a). A slice of $K^2 \times \mathbb{R}^1 \cap h_1^{-1}(M^4 \times 0)$. The ambient space of the picture is the 4-dimensional slice $\partial D \times \frac{1}{2} \times \mathbb{R}^1$ of $M^4 \times \mathbb{R}^1$.

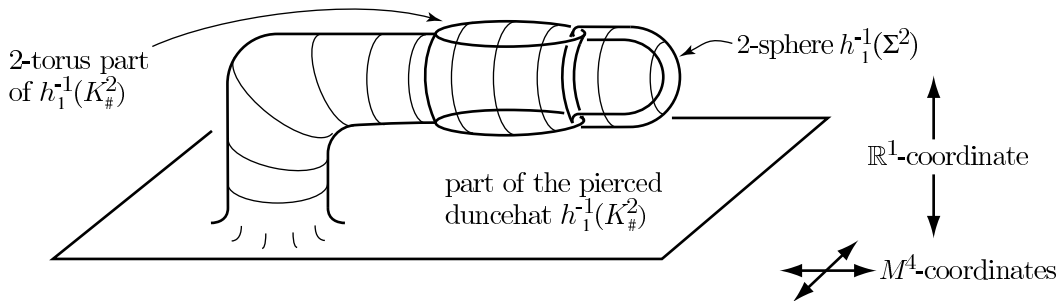

2-torus part of $h_1^{-1}(K_{\#}^2)$

2-sphere $h_1^{-1}(\Sigma^2)$

part of the pierced duncechat $h_1^{-1}(K_{\#}^2)$

Part (b). Another view of $K^2 \times \mathbb{R}^1 \cap h_1^{-1}(M^4 \times 0)$, which consists of the pierced duncechat $h_1^{-1}(K_{\#}^2)$ and the 2-sphere $h_1^{-1}(\Sigma^2)$.

The view in Part (a) is a slice of this.

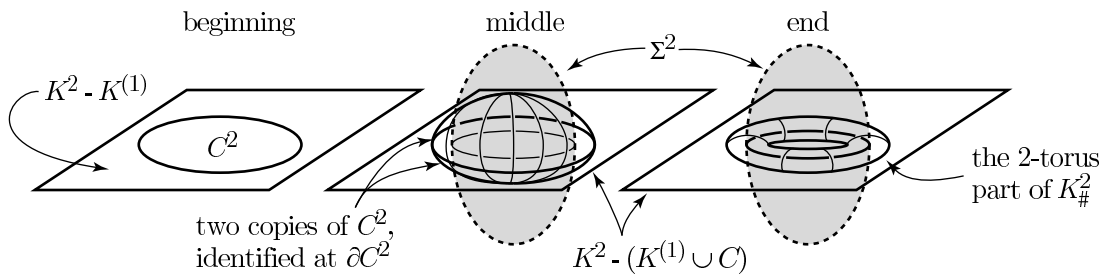

Part (c). Three stages in the growth of the pierced duncechat $K_{\#}^2$ and the linking 2-sphere Σ^2 , taking place in $M^4 \times 0$. The 2-sphere Σ^2 has dotted lines to indicate that the hemispheres of Σ^2 lie in the 4th dimension; only the equator of Σ^2 lies in this 3-dimensional slice of $M^4 \times 0$.

FIGURE I-3. Some aspects of Step $i = 1$, including the pierced duncehat

The polyhedron $A'_{1,0}$ is gotten from $A_{1,0} = A_1$ by starting at the point $d \times \frac{1}{2} \times 1$ in A_1 , and sending out a feeler (= interval) F^1 upwards from this point to the point $a \times \frac{1}{2} \times 2$, always staying in $(K - K^{(1)}) \times [1, 2]$, and then adjoining the disc-with-feeler $(L^1_{\#} \cup D^2_{\#}) \times \frac{1}{2} \times 2$ to $A_{1,0} \cup F^1$. Note that the feeler F^1 may have to travel a long distance to join the two points, but nevertheless it is possible, since the points a and d are joinable by an arc in the open 2-cell $K^2 - K^{(1)}$. (Aside: This entire step could be done without any vertical motion, working always in the $M \times 1$ level to change A_1 to A_2 , postponing to Step 3 or 4 the matter of source-isolation. This is the point of view adopted in the more general program in Part II. But for Part I the present description seems a bit easier.)

Next, $A''_{1,0}$ is gotten by thickening part of $A'_{1,0}$, adding to it a small 3-dimensional “tubular neighborhood” of $F^1 \cup L^1_{\#} \times \frac{1}{2} \times 2$, resembling a 3-dimensional eyebolt where “tubular neighborhood” of F^1 means the restriction to F^1 of a 2-disc normal bundle of $(K^2 - K^{(1)}) \times \mathbb{R}^1$ in $M^4 \times \mathbb{R}^1$, and where “tubular neighborhood” of $L^1_{\#} \times \frac{1}{2} \times 2$ means a genuine regular neighborhood of it (rel $a \times \frac{1}{2} \times 2$) in $\partial D^4 \times \frac{1}{2} \times 2$. We assume these thickenings match up nicely with each other, and with what has already been defined, as suggested by Figure I-3₂.

To get $A'''_{1,0}$ from $A''_{1,0}$, most of the newly added 3-dimensional eyebolt is collapsed away, starting at the $(d \times \frac{1}{2} \times 1)$ -end and collapsing upwards, so that the only material which is left behind is the 2-dimensional outer skin of the eyebolt, plus a spanning 2-disc D^2_- in the handle at the end of the eyebolt. Also left undisturbed is the other 2-disc D^2_+ spanning the eye of the eyebolt. Thus, $A'''_{1,0}$ is homeomorphic to

$$A_{\delta} \cup (2 - \text{disc with handle}) \cup D^2_- \cup D^2_+,$$

where the boundaries of D^2_- and D^2_+ are identified with the circles in the figure-eight spine of the disc-with-handle (which is a punctured 2-tours), and where the boundary of the disc-with-handle is identified with the circle in A_{δ} . In the collapsing of $A''_{1,0}$ to $A'''_{1,0}$, some of the intersection of $A''_{1,0}$ with $K \times \mathbb{R}^1$ is collapsed away. Originally it consisted of B_{δ} , plus a circle with a feeler attached, plus a point $d_+ \in \text{int } D^2_+$. When done with the collapse the circle-with-feeler has been reduced to just a single point on the circle, namely the center d_- of D^2_- , while B_{δ} and the point d_+ remain undisturbed.

The final repositioning of $A'''_{1,0}$, done to achieve the source-isolation property of the Lemma, is to move one of the two intersection points, say d_+ , upwards to say the $M \times 3$ level, keeping fixed the complement of a small neighborhood of this point in $A'''_{1,0}$. Let $A_{1,1}$ be this repositioned copy of $A'''_{1,0}$. By construction,

$$B_{1,1} = (B_{1,0} - d \times \frac{1}{2} \times 1) \cup \{d_-, d_+\} = B_{\delta} \cup \{d_-, d_+\},$$

where one of the new points is at the 2-level, and the other is at the 3-level.

Qualitatively, $A_{1,1}$ is gotten from $A_{1,0}$ in a single operation, simply by *puckering* the 2-disc $D^2_{\#} \times \frac{1}{2} \times 1 \subset A_{1,0}$, where a *puckered 2-disc* is a 2-disc-with-handle with two spanning 2-discs attached to make it contractible, as remarked in the description of $A'''_{1,0}$ above. Note that a puckered 2-disc really is obtained by puckering a genuine 2-disc; see Figure I-6a.

To get $A_{1,2}$ from $A_{1,1}$, qualitatively one simply puckers each of the two spanning 2-discs D^2_- and D^2_+ in $A_{1,1}$. Quantitatively, one does two independent, non-interfering expansion-collapse processes, each process being a copy of the one used

above to go from $A_{1,0}$ to $A_{1,1}$, this time starting at the two new points d_- and d_+ of $B_{1,1}$. The initial feelers sent out should go up to say the 4-level (from the 2-level) and to the 6-level (from the 3-level), and then the bulk of the activity takes place in those levels, except that the final repositioning operation makes the four new points of $B_{1,2} = B_\delta \cup \{d_{--}, d_{-+}, d_{+-}, d_{++}\}$ lie in say the 4, 5, 6 and 7-levels.

Now the pattern is established. The set $K \times \mathbb{R}^1 \cap h_{i,j}^{-1}(M \times 0)$, being the frontier in $K \times \mathbb{R}^1$ of a regular neighborhood in $K \times \mathbb{R}^1$ of $B_{1,j} = B_\delta \cup 2^j$ points, will consist of a pierced duncehat and 2^j 2-spheres, and these components are isolated in $K \times \mathbb{R}^1$, in that they have no overlap in the \mathbb{R}^1 -coordinate (i.e., their \mathbb{R}^1 -projections are disjoint). On the other hand, the images under $h_{1,j}$ of these components are linked in $M^4 \times 0$ in a very interesting manner, as will be explained in the second round.

Step i = 3 (first round). $A_3 = A_2$. Hence h_3 is qualitatively the same as h_2 . The quantitative difference between h_3 and h_2 will be explained in the second round.

Step i = 4 (first round). See Figures I-3₄ and I-7. Given $A_2 (= A_3)$, let $\{t_\mu \mid 1 \leq \mu \leq 2^p\}$ denote the \mathbb{R}^1 -levels of the 2^p points of B_2 (in the above construction, these levels were $t_\mu = 2^p + \mu - 1$). Then define $A_4 = A_2 \cup \bigcup \{K^2 \times t_\mu \mid 1 \leq \mu \leq 2^p\}$. The expansion-collapse $A_2 \nearrow A_4$ follows from the fact that $K \times I$ is collapsible. Note that $B_4 = B_2 \cup \bigcup \{K^2 \times t_\mu \mid 1 \leq \mu \leq 2^p\} = B_\delta \cup \bigcup \{K^2 \times t_\mu \mid 1 \leq \mu \leq 2^p\}$. It is clear that the intersection $K^2 \times \mathbb{R}^1 \cap h_4^{-1}(M^4 \times 0)$ consists of $1 + 2^{p+1}$ components, one being the pierced duncehat, and the others being say the 2^{p+1} duncehats $\{K^2 \times (t_\mu \pm \lambda) \mid 1 \leq \mu \leq 2^p\}$, for some small $\lambda > 0$.

Having established the qualitative definitions of the h_i 's, we seek now to gain a better understanding of their behavior, paying close attention to the target intersections $h_i(K^2 \times \mathbb{R}^1) \cap M^4 \times 0$.

Step i = 1 (second round). Analysis of the two-component intersection $h_1(K \times \mathbb{R}^1) \cap M \times 0$ reveals that it can be described in the following way (this amplifies the earlier remarks; see Figure I-4c).

Starting with K^2 in M^4 , remove a small 2-cell C^2 from $K^2 - K^{(1)}$, and replace it with a 2-torus to produce the pierced duncehat component $K^2_\#$. At the same time, add to the picture a disjoint 2-sphere Σ^2 lying in M^4 , so that in M^4 it links the 2-torus of $K^2_\#$, as suggested by Figure I-4c. Note that the inclusion $\partial M^4 \hookrightarrow M^4 - (K^2_\# \cup \Sigma^2)$ is monic on the fundamental group, as it must be (but this need not be verified).

It is interesting to actually watch the original duncehat

$$K^2 \times 0 = K^2 \times \mathbb{R}^1 \cap M^4 \times 0$$

in $M^4 \times 0$ transform into these two components $K^2_\# \times 0$ and $\Sigma^2 \times 0$, by following the ambient isotopy h_t of $h_0 = \text{identity}$ to h_1 , focusing on the intersection $h_t(K \times \mathbb{R}^1) \cap M \times 0$ (or more easily, on $K \times \mathbb{R}^1 \cap h_t^{-1}(M \times 0)$, using the earlier description). The changes in $K^2 \times 0$ take place in an arbitrarily small neighborhood of $C^2 \times 0$ in $M^4 \times 0$, and are symmetric under rotation of this 4-dimensional neighborhood about the fixed 2-plane transverse to $C^2 \times 0$ at its center (the ‘‘spinning’’ point of view, explained in the upcoming $i = 2$ case, is also useful here). The changes are (Figure I-4c): first $C^2 \times 0$ divides, or splits, into two parallel copies of itself, with boundaries remaining joined together at $\partial C^2 \times 0$; then the 2-sphere $\Sigma^2 \times 0$ materializes, growing from say the original center point of $C^2 \times 0$, until its diameter is almost that of $C^2 \times 0$; finally, the two parallel boundary-identified copies of $C^2 \times 0$

join together near their centers, becoming pierced there, so their union forms the 2-torus which links the 2-sphere in $M \times 0$. This dividing operation can be regarded as *duncehat meiosis*.

The pierced duncehat $K_{\#} \times 0$ can now be made arbitrarily small in $M \times 0$, by level-preserving ambient isotopy of $M \times \mathbb{R}^1$, because it can be pushed arbitrarily close to the circle $K^{(1)} \times 0$, which itself can be made small homotopically hence isotopically, using the contractibility of K^2 . This motion will stretch $\Sigma^2 \times 0$ large, but that is allowed, for Steps 2 and 3 will take care of that. We henceforth will assume these motions have been incorporated into the homeomorphism h_1 .

Step i = 2 (second round). In this step the 2-sphere component of intersection $\Sigma^2 \times 0$ from Step 1 is replaced by 2^p new 2-sphere components of intersection, which are embedded in a tubular neighborhood $\Sigma^2 \times D^2 \times 0$ of $\Sigma^2 \times 0$ in $M^4 \times 0$. The goal here is to describe how these new 2-spheres are embedded. The pierced duncehat component $K_{\#}^2 \times 0$ from Step 1 is left untouched (for the remainder of the proof, in fact).

The model situation comes from Bing's foundational 1952 paper [Bi1]. There Bing described a certain nest of 3-dimensional solid tori, which he used to define a decomposition of \mathbb{R}^3 . They can be described as follows (see Figure I-5).

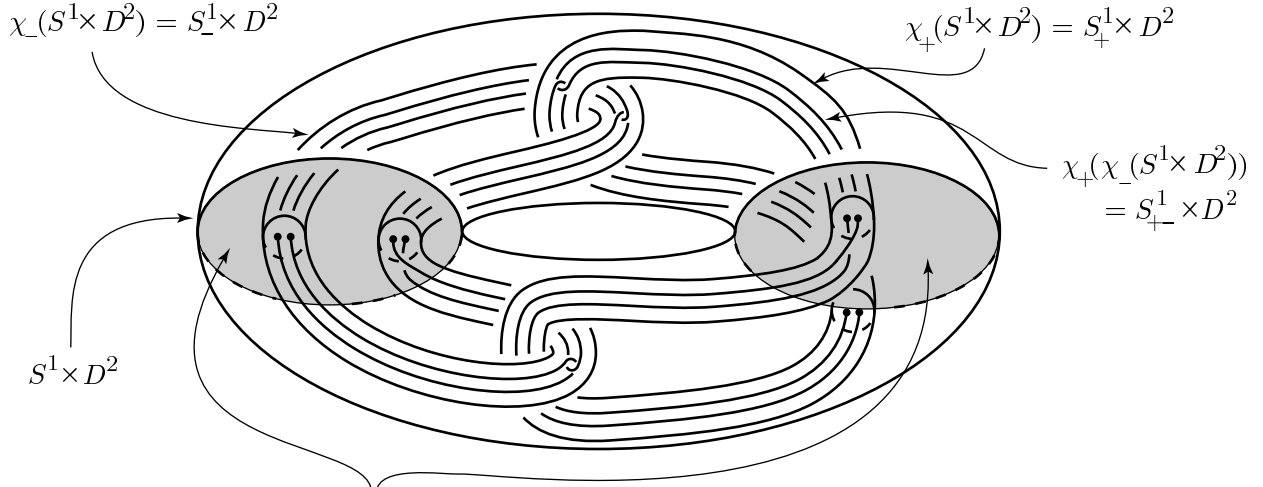

The subspace \mathbb{R}^2 is positioned vertically here, to cut the collection of solid tori in half, symmetrically.

FIGURE I-4. The Bing collection of thickened 1-spheres (i.e., solid tori) in \mathbb{R}^3

Starting with $S^1 \times D^2$, let $\chi_-, \chi_+ : S^1 \times D^2 \rightarrow S^1 \times \text{int } D^2$ be two disjoint embeddings, with images denoted $S_-^1 \times D^2$ and $S_+^1 \times D^2$, such that each image is by itself trivially embedded in $S^1 \times D^2$, and yet the two images are linked in $S^1 \times D^2$ as shown in Figure I-5. These embeddings can be iterated, to produce for any $p > 0$ a collection of 2^p solid tori $\{S_{\mu}^1 \times D^2 \mid \mu \in \{-, +\}^p\}$ in $S^1 \times D^2$, where

$$S_{\mu}^1 \times D^2 = \chi_{\mu(1)}(\chi_{\mu(2)}(\dots(\chi_{\mu(p)}(S^1 \times D^2))\dots)).$$

We assume that the embeddings χ_-, χ_+ are chosen so that this collection is invariant under reflection in $\mathbb{R}^2 \subset \mathbb{R}^3$, as shown in Figure I-5, where \mathbb{R}^2 is drawn vertically in \mathbb{R}^3 .

The collection of 2-spheres that arises in this step is gotten by “spinning” this original Bing collection of 1-spheres. Imagine \mathbb{R}^4 as being gotten from $\mathbb{R}^3 = \mathbb{R}^3 \times 0 \subset \mathbb{R}^4$, by spinning, or rotating, \mathbb{R}^3 in \mathbb{R}^4 through 360° (or 180° , if you wish to be economical) about the plane \mathbb{R}^2 , keeping \mathbb{R}^2 fixed. Because of the symmetric positioning of the embeddings $\{\chi_\mu\}$, each solid torus $S_\mu^1 \times D^2$, when spun, produces a thickened 2-sphere $S_\mu^2 \times D^2$. This collection $\{S_\mu^2 \times D^2\}$ of thickened 2-spheres in $S^2 \times D^2$ will be called the *spun Bing collection* of thickened 2-spheres.

It turns out that in Step 2, as described earlier, the 2^p 2-sphere components of $h_2(K \times \mathbb{R}^1) \cap M \times 0$ can be described as the collection $\{\Sigma_\mu^2 \mid \mu \in \{-, +\}^p\} \times 0$, where Σ_μ^2 is the core $\Sigma_\mu^2 \times 0$ of the thickened 2-sphere $\Sigma_\mu^2 \times D^2$ lying in $\Sigma^2 \times D^2$, all of this data being gotten by corresponding $\Sigma^2 \times D^2$ to $S^2 \times D^2$.

This can be seen by careful analysis of the earlier description. What follows is a description of a precise model which may make this clearer; this is the way I originally perceived the construction. Since the model also will be used to describe the generalization in Part II, it is presented here in its generalized context.

The model starts in euclidean 3-space, which will be denoted \mathbb{E}^3 here so that there will be no erroneous correspondence made with \mathbb{R}^3 in the description of spinning given above, or in the Appendix. In \mathbb{E}^3 we define the 1-dimensional subsets L_-^1 and L_+^1 shown in Figure I-6b, each consisting of a circle with an infinitely long tail attached, such that the circles are linked. Using coordinates (a, b, c) for \mathbb{E}^3 as shown, their precise descriptions are as follows (where $\eta > 0$ small): L_-^1 is the union of the set of points in the ac -plane which are exactly distance η from the interval $0 \times 0 \times [-2, 0]$, together with the interval $0 \times 0 \times (-\infty, -2, -\eta]$ (pardon the nonstandard coordinates used in Figure I-6, but they seem to yield the best pictures).

Similarly, L_+^1 is the union of the set of points in the bc -plane which are exactly distance η from the interval $0 \times 0 \times [0, 2]$, together with the interval $0 \times 0 \times [2 + \eta, \infty)$.

In what follows the two first stage $(1+k)$ -spheres $S_-^{1+k} \cup S_+^{1+k}$ of the k -times spun Bing collection of $(1+k)$ -spheres in $S^{1+k} \times D^2$ will be described, by means of intersections taking place in $(4+k)$ -space. It is probably best to understand first the $k=0$ case (i.e. the original Bing case) and the $k=1$ case (which is the case of interest in Part I). After describing the model, and the operation of spherical mitosis in the model, it will be shown how the $k=1$ case of the model corresponds to the current situation in $M^4 \times \mathbb{R}^1$. The relevant pictures are Figures I-6 b,c.

In euclidean $(4+k)$ -space $\mathbb{E}^{4+k} = \mathbb{E}^3 \times \mathbb{E}^{1+k}$ (see above comment on the use of \mathbb{E}), consider the sets $L_-^{2+k} \equiv L_-^1 \times \mathbb{E}^{1+k}$; $L_+^{2+k} \equiv L_+^1 \times \mathbb{E}^{1+k}$; $\mathbb{E}^2 = \mathbb{E}^2 \times 0 = \mathbb{E}^2(a, b) \subset \mathbb{E}^3 = \mathbb{E}^3 \times 0 \subset \mathbb{E}^{4+k}$; and $Q^{3+k} \equiv$ the boundary of the unit tubular neighborhood of \mathbb{E}^2 in \mathbb{E}^{4+k} . Thus \mathbb{E}^2 is a 2-plane in \mathbb{E}^3 perpendicular to the c -axis, and Q^{3+k} is naturally homeomorphic to $\mathbb{E}^2 \times S^{1+k}$, where we are thinking of S^{1+k} as the unit sphere in $0 \times \mathbb{E}^1(c) \times \mathbb{E}^{1+k}$, where $\mathbb{E}^1(c)$, is the c -coordinate axis in $\mathbb{E}^3 = \mathbb{E}^2(a, b) \times \mathbb{E}^1(c)$. (Note that \mathbb{E}^3 itself can be regarded as the $k=-1$ case of this construction.)

Let D^2 denote the unit disc in \mathbb{E}^2 , so that $D^2 \times S^{1+k}$ (henceforth denoted $S^{1+k} \times D^2$) is the intersection of Q^{3+k} with $D^2 \times \mathbb{E}^1(c) \times \mathbb{E}^{1+k}$ in $\mathbb{E}^3 \times \mathbb{E}^{1+k}$. The significance of this model is the following

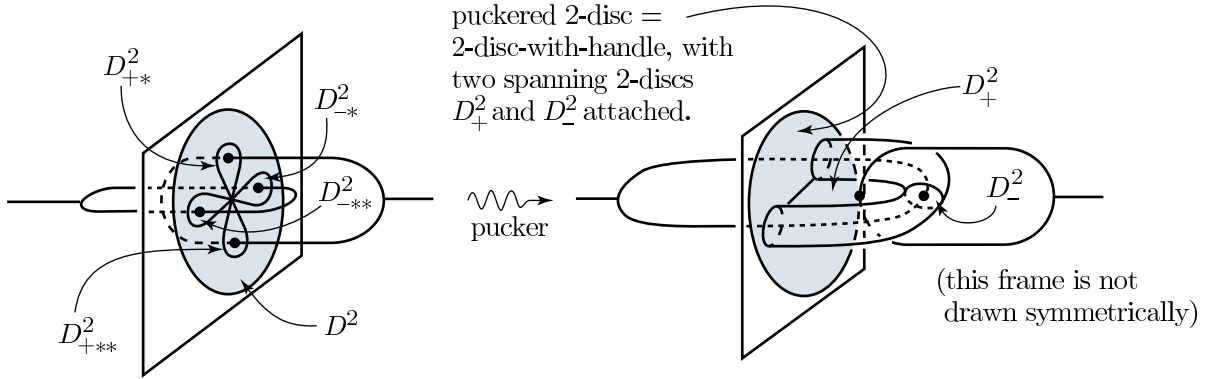

Part (a). The puckering operation: identify D_{-*}^2 to D_{-**}^2 to get D_-^2 and identify D_{+*}^2 to D_{+**}^2 to get D_+^2 . Note that the four points of intersection become two points of intersection.

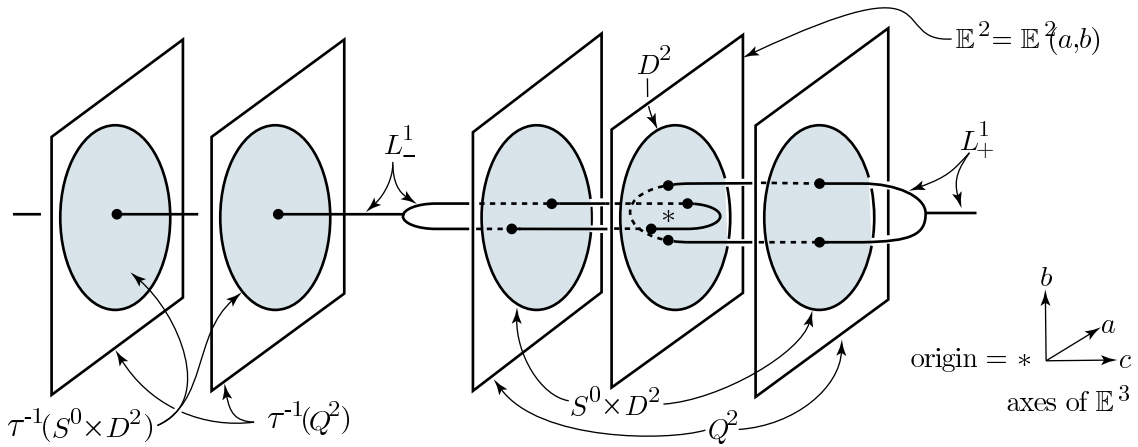

Part (b). The model 3-space \mathbb{E}^3

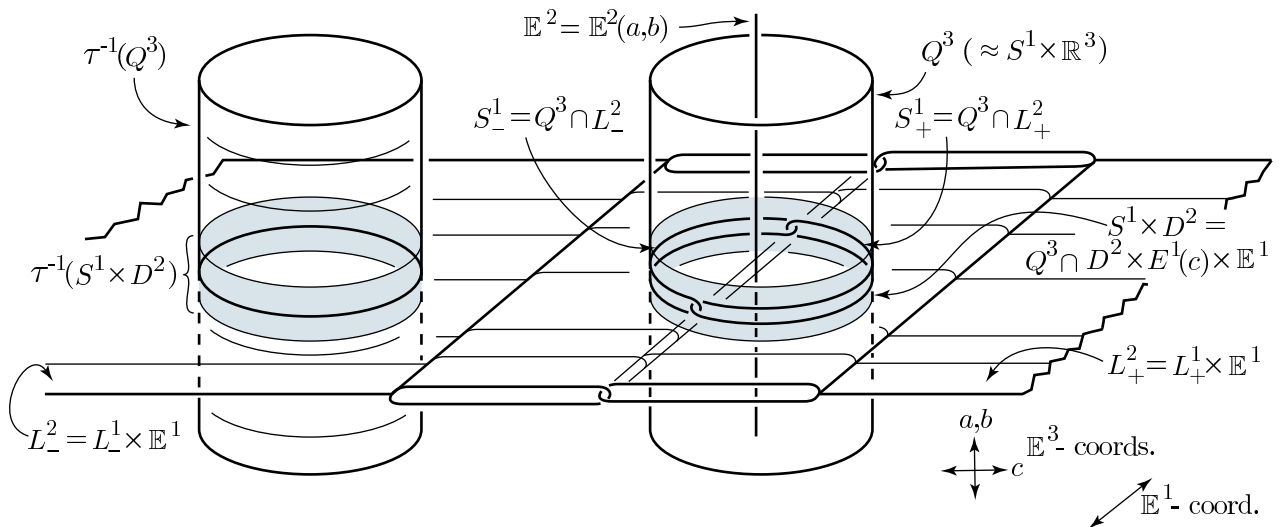

Part (c). The model 4-space $\mathbb{E}^4 = \mathbb{E}^3 \times \mathbb{E}^1$

FIGURE I-5. Some aspects of Step $i = 2$

Observation. *The pair $(S^{1+k} \times D^2, S^{1+k} \times D^2 \cap (L_-^{2+k} \cup L_+^{2+k}))$ corresponds in a natural manner to the pair $(S^{1+k} \times D^2, S_-^{1+k} \cup S_+^{1+k})$, where S^{1+k} and S_+^{1+k} are the two first-stage $(1+k)$ -spheres in the k -times spun Bing collection of $(1+k)$ -spheres in $S^{1+k} \times D^2$.*

Understanding this is a matter of analyzing the model, seeing first the $k = 0$ case and then proceeding to higher dimensions.

We wish to describe a process by which these two $(1+k)$ -spheres $S_-^{1+k} \cup S_+^{1+k}$ can be gotten from the original core $(1+k)$ -sphere $S^{1+k} \times 0 \subset S^{1+k} \times D^2$ in a continuous manner. Let $\tau : \mathbb{E}^3 \times \mathbb{E}^{1+k} \rightarrow \mathbb{E}^3 \times \mathbb{E}^{1+k}$ be translation by 4 units in the positive direction of the c -axis of \mathbb{E}^3 . Let τ_t , $0 \leq t \leq 1$, be the natural linear isotopy joining $\tau_0 = \text{identity}$ to $\tau_1 = \tau$. We wish to focus on the translated copy $\tau^{-1}(S^{1+k} \times D^2)$ of $S^{1+k} \times D^2$, and to examine its intersection with the always-fixed subset $L_-^{2+k} \cup L_+^{2+k}$ of \mathbb{E}^{4+k} , as $\tau^{-1}(S^{1+k} \times D^2)$ is translated back to its standard position $S^{1+k} \times D^2$ by the isotopy $\{\tau_t\}$. (The reason for this somewhat backward point of view, i.e. moving $S^{1+k} \times D^2$ instead of moving $L_-^{2+k} \cup L_+^{2+k}$, is that in the real situation in $M^4 \times \mathbb{R}^1$ this is what is happening, as we will see.) Examination reveals that the intersection $\tau_t(\tau^{-1}(S^{1+k} \times D^2)) \cap (L_-^{2+k} \cup L_+^{2+k})$ starts out at $t = 0$ looking like the core sphere of $\tau^{-1}(S^{1+k} \times D^2)$, and then as t increases the intersection undergoes a transformation, dividing into two components, so that ultimately at time $t = 1$ it has become the pair of linked $(1+k)$ -spheres $S_-^{1+k} \cup S_+^{1+k}$ in $\tau_1(\tau^{-1}(S^{1+k} \times D^2)) = S^{1+k} \times D^2$. This is the process of *spherical meiosis*. It is interesting to follow the intermediate stages, even in the original Bing $k = 0$ case.

The $k = 1$ case of the above-described model is corresponded to our situation in $M^4 \times \mathbb{R}^1$ in the following manner. The space \mathbb{E}^3 is to be thought of as an open subset of the boundary ∂D^4 of the 0-handle D^4 of M^4 , so that $\mathbb{E}^3 \cap L^1 = L_-^1 \cup L_+^1$. The fourth coordinate \mathbb{E}^1 of $\mathbb{E}^3 \times \mathbb{E}^{1+1}$ is to be thought of as the $(0, 1)$ -coordinate in $D^4 - * = \partial D^4 \times [0, 1)$, with the origin of \mathbb{E}^1 corresponding say to the point $\frac{1}{2} \in [0, 1)$. Finally, the fifth coordinate \mathbb{E}^1 of $\mathbb{E}^3 \times \mathbb{E}^{1+1}$ is to be thought of as the \mathbb{R}^1 coordinate of $M^4 \times \mathbb{R}^1$, translated so that the origin of \mathbb{E}^1 is at the 2-level (or later on at the 4-level, or 6-level, or whatever higher level of \mathbb{R}^1 one is working in at the time). In summary, the first four coordinates of $\mathbb{E}^3 \times \mathbb{E}^{1+1}$ are to be thought of as defining an open subset of the 0-handle D^4 of M^4 , and the fifth coordinate is to be thought of as the vertical coordinate of $M^4 \times \mathbb{R}^1$. (Aside: Actually, there is no mathematical justification for distinguishing the last two coordinates of $\mathbb{E}^3 \times \mathbb{E}^{1+1}$ from each other, since the construction in the model is symmetric about \mathbb{E}^3 . But it is conceptually helpful to make this distinction.)

We now can use this model to understand the construction of $h_{1,1}$ from $h_{1,0} = h_1$. Let $\mathbb{E}_\#^2 = \text{int } D_\#^2 \times \frac{1}{2} \times 1$ denote the interior of the 2-disc part of A_1 . Then $\mathbb{E}_\#^2 \subset M \times 1$, and $\mathbb{E}_\#^2 \cap K \times \mathbb{R}^1$ is the center point $d \times \frac{1}{2} \times 1$ of $\mathbb{E}_\#^2$. Suppose distances are scaled so that the portion of $h_1^{-1}(M \times 0)$ lying near the 2-sphere component $h_1^{-1}(\Sigma^2 \times 0)$ of $K \times \mathbb{R}^1 \cap h_1^{-1}(M^4 \times 0)$ looks like the boundary of the unit tubular neighborhood of $\mathbb{E}_\#^2$ in $M^4 \times \mathbb{R}^1$. Forget the 3-stage transformation of $A_{1,0} = A_1$ to $A_{1,1}$; instead let us just isotope $A_{1,0}$ to a new position by isotoping $\mathbb{E}_\#^2$ in $M^4 \times \mathbb{R}^1$, keeping it fixed near its boundary, so that a neighborhood in $\mathbb{E}_\#^2$ of the center point $d \times \frac{1}{2} \times 1$ of \mathbb{E}^2 is moved up to the 2-level $M \times 2$, there to coincide with a large compact piece of the plane $\mathbb{E}^2 = \mathbb{E}^2(a, b)$ of the model. During the first part of this isotopy, the intersection of $\mathbb{E}_\#^2$ with $K^2 \times \mathbb{R}^1$ is to be kept always the center

point of $\mathbb{E}_{\#}^2$. As $\mathbb{E}_{\#}^2$ nears the end of its journey, in a neighborhood of the $M^4 \times 2$ level, we see it near the 0-level of the model. There we suppose that the end of its isotopy coincides with the translation by τ_t of the plane $\tau^{-1}(\mathbb{E}^2)$ in the model to its standard position \mathbb{E}^2 . Hence, near the end of the isotopy the intersection of the moving $\mathbb{E}_{\#}^2$ with the fixed $K \times \mathbb{R}^1$ changes from a single point to four points. But that is not important. What is important is that the movement of $h_{1,0}^{-1}(M \times 0)$ to $h_{1,1}^{-1}(M \times 0)$ can be viewed as the movement of the frontier of a regular neighborhood of this moving plane $\mathbb{E}_{\#}^2 \subset A_{1,0}$, where at the end of the isotopy the portion of this regular neighborhood we see in the model is the 1-neighborhood of the moving plane $\tau_t(\tau^{-1}(\mathbb{E}^2))$. So the point is this: qualitatively, the change in the intersection of $h_{1,0}^{-1}(M \times 0)$ with $K \times \mathbb{R}^1$, as it is isotoped to $h_{1,1}^{-1}(M \times 0)$, is the same as the change of the intersection of $\tau^{-1}(Q^4)$ with $L_-^3 \cup L_+^3$ in the model $\mathbb{E}^3 \times \mathbb{E}^2$, as $\tau^{-1}(Q^4)$ is isotoped by the translations $\{\tau_t\}$ back to its standard position Q^4 . Hence the change in the intersection amounts to spherical meiosis.

From this, the relation of the two 2-sphere components of $h_{1,1}(K \times \mathbb{R}^1) \cap M \times 0$ to the single 2-sphere component of $h_{1,0}(K \times \mathbb{R}^1) \cap M \times 0$ can be seen to be modelled on the spun Bing construction. (As an incidental remark, to change the above repositioned $A_{1,0}$ into the earlier-described $A_{1,1}$, one only has to pucker (cf. earlier) the newly positioned $\mathbb{E}_{\#}^2$, to reduce its four pints of intersection with $K^2 \times \mathbb{R}^1$ to two points of intersection. See Figure I-6a.)

This same analysis works for the later stages of this step, i.e. going from $h_{1,1}$ to $h_{1,2}$, etc.

Step i=3 (second round). In this step, there are no qualitative changes made in h_2 to get h_3 , but instead the diameters of the various 2-sphere components of $h_2(K \times \mathbb{R}^1) \cap M \times 0$ are made δ -small, by following h_2 by a level-preserving homeomorphism of $M \times \mathbb{R}^1$. This level-preserving homeomorphism is obtained in the obvious manner from the ambient isotopy of $\Sigma^2 \times D^2$ *rel* ∂ used to shrink small the 2^p p^{th} stage 2-spheres in the spun Bing collection of 2-spheres. This shrinking of the spun Bing collection is explained in the Appendix to Part II. It is for this shrinking argument that $p = p(\delta)$ must be chosen large. Note that p can in fact be chosen at the start of Step 2 (as it must be) because, in addition to δ , it depends only on how $\Sigma^2 \times D^2$ is embedded in M , and that embedding is chosen after the construction of h_1 .

Step i=4 (second round). The effect of this step is to take each δ -small 2-sphere component $\Sigma_{\mu}^2 \times 0$ of $h_3(K \times \mathbb{R}^1) \cap M \times 0$, and to replace it by two copies of duncehats, $h_4(K^2 \times (t_{\mu} \pm \lambda))$, as suggested earlier. See Figure I-7.

The important thing is that these two new duncehat components of intersection can be chosen to lie in any arbitrarily small neighborhood $\Sigma_{\mu}^2 \times D^2 \times 0$ of $\Sigma_{\mu}^2 \times 0$ in $M^4 \times 0$, hence their size is automatically controlled. If one examines the isotopy of h_3 to h_4 , engendered by the expansion-collapse of A_3 to A_4 , one can see the component-of-intersection $\Sigma_{\mu}^2 \times 0$ undergo meiosis in $\Sigma_{\mu}^2 \times D^2 \times 0$, becoming two duncehats which are linked there.

This completes the proof of the Basic Lemma. □

Given the Basic Lemma, the remainder of the proof of the Shrinking Proposition is patterned on [EM, Section 3]. Figures 1, 3, and 4 there are meaningful here, too. More precise details can be gotten from that paper. Recall that $B^2 \times D^2$ denotes the 2-handle of M^4 .

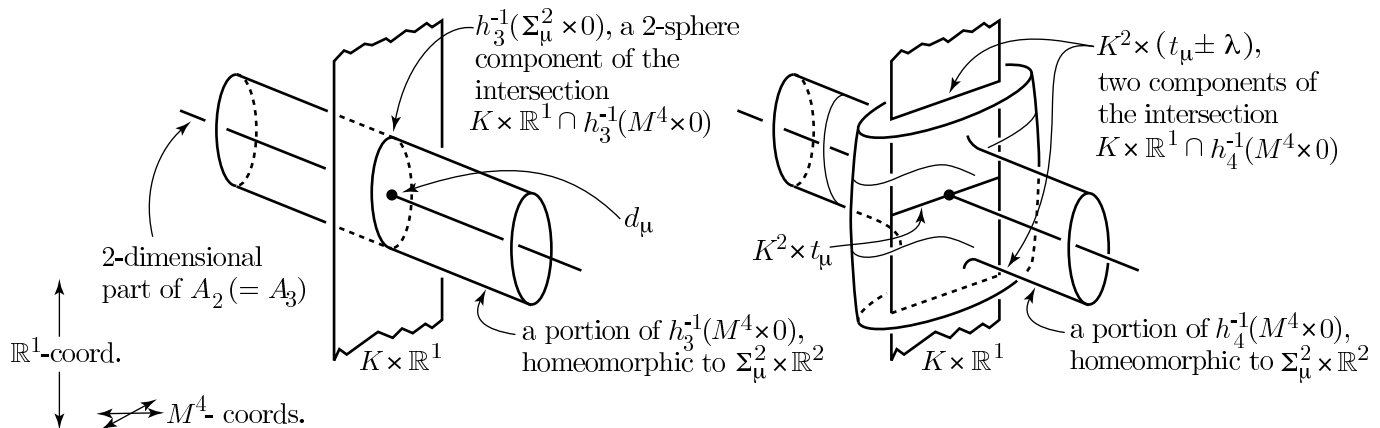
FIGURE I-6. Step $i = 4$: the passage from h_3 to h_4

WINDOW BUILDING LEMMA. *Given $\delta > 0$, there is a homeomorphism $h_{\#} : M \times \mathbb{R}^1 \rightarrow M \times \mathbb{R}^1$, fixed on $\partial M \times \mathbb{R}^1$, such that*

- (1) *for each $j \in \mathbb{Z}$ and each $t \in [j - 1, j + 1]$, $h_{\#}(M \times t) \subset M \times [j - 1, j + 1]$, and*
- (2) *for each $t \in \mathbb{R}^1$, if $h_{\#}(K \times t) \cap B^2 \times D^2 \times [j - 1 + \delta, j + 1 - \delta] \neq \emptyset$ for any $j \in 2\mathbb{Z}$, then $\text{diam } h_{\#}(K \times t) < \delta$.*

PROOF. This follows quickly from the Basic Lemma. We can suppose that the homeomorphism h_4 constructed there has the additional property that the punctured duncehat component of $h_4(K^2 \times \mathbb{R}^1) \cap M^4 \times 0$ does not intersect $B^2 \times D^2 \times 0$. This either can be verified by construction (e.g., it would be natural to make h_1 have this property), or one can argue that the pierced duncehat component, being δ -small, can be assumed to lie in some ball in $M^4 \times 0$, and therefore it can be isotoped off of $B^2 \times D^2 \times 0$ in $M^4 \times 0$. Supposing this, then by applying after h_4 a vertical homeomorphism of $M^4 \times \mathbb{R}^1$ which basically expands $B^2 \times D^2 \times [-\eta, \eta]$ to $B^2 \times D^2 \times [-1 + \delta, 1 - \delta]$ (i.e., “opens the window wider”), for some small $\eta > 0$, one can obtain a homeomorphism $h_* : M \times \mathbb{R}^1 \rightarrow M \times \mathbb{R}^1$, fixed on $\partial M \times \mathbb{R}^1$ and having compact support, such that h_* satisfies condition (2) above for the value $j = 0$. To complete the proof, one conjugates h_* to make it have the additional property that its support lies in $M \times [-1, 1]$, and then one obtains $h_{\#}$ by taking the sum of an infinite number of translates of h_* stacked on top of each other. \square

PROOF OF SHRINKING PROPOSITION FROM THE WINDOW BUILDING LEMMA. Given $\epsilon > 0$, choose a small ball B^4 in $\text{int } M^4$, with $\text{diam } B^4 < \epsilon/2$. We indicate how to construct a homeomorphism $h : M \times \mathbb{R}^1 \rightarrow M \times \mathbb{R}^1$, fixed on $\partial M \times \mathbb{R}^1$, which satisfies the following weakened versions of the conditions from the Shrinking Proposition: for each $t \in \mathbb{R}^1$,

- 1'. $h(M \times t) \subset M \times [t - 3, t + 3]$, and
- 2'. either
 - a. $h(K^2 \times t) \subset B^4 \times [t - 3, t + 3]$, or
 - b. $\text{diam } h(K^2 \times t) < \epsilon$

From this weaker version of the Shrinking Proposition it is clear that the original version follows, simply by rescaling the vertical coordinate.

1. To construct this h , first one constructs a uniformly continuous homeomorphism $g : M \times \mathbb{R}^1 \rightarrow M \times \mathbb{R}^1$, fixed on $\partial M \times \mathbb{R}^1$, such that for each $t \in \mathbb{R}^1$, $g(M \times t) \subset M \times [t - 1, t + 1]$, and
2. the image under g of $(M_1^4 \cap (D^4 \cup B^1 \times D^3)) \times \mathbb{R}^1 \cup \{M_1 \times (j+1) \mid j \in 2\mathbb{Z}\}$ lies in $B^4 \times \mathbb{R}^1$, where $M_1^4 = M^4 - \partial M \times [0, 1)$ for some collar $\partial M \times [0, 2)$ of ∂M in M^4 , and where $D^4 \cup B^1 \times D^3$ is the union of the 0-handle and the 1-handle of M^1 .

The details for g (which are simple) are omitted, since a more general such g is constructed in Part II. Given g , then one can let $h = gh_\#$, where $h_\#$ is provided by the Window Building Lemma for some sufficiently small value of $\delta = \delta(\epsilon, g)$, and where we are assuming without loss that $h_\#(K \times \mathbb{R}^1) \subset M_1 \times \mathbb{R}^1$. This completes the proof of the Shrinking Proposition, and hence Part I. \square

Part II

The double suspension of any
homology n -sphere which bounds
a contractible $(n - 1)$ -manifold is a
sphere

The purpose of this part is to generalize Part I to prove

THEOREM 4. *The double suspension $\Sigma^2 H^n$ of any homology sphere H^n which bounds a contractible topological manifold is homeomorphic to a sphere. In particular, if $n \geq 4$, this conclusion holds.*

The last sentence is justified by the following Proposition (which basically is known; see proof). It is stated in sufficient generality for use in the Prologue, Section II.

PROPOSITION 1. *Suppose H^n is a compact space such that $H^n \times S^1$ is a topological manifold-without-boundary, and such that H^n has the integral homology groups of the n -sphere. If $n \geq 4$, then there is an embedding of $H^n \times \mathbb{R}^1$ into some open contractible topological manifold M^{n+1} so that $M^{n+1} - (H^n \times \mathbb{R}^1)$ is compact (i.e., $H^n \times \mathbb{R}^1$ is a neighborhood of the end of M^{n+1}).*

The Proposition is unknown for $n = 3$. If $n \geq 4$, and H^n is a *PL* manifold homology n -sphere, then Kervaire proved in [Ke, Cor, p. 71] that H^n bounds a contractible *PL* manifold. Using the post-1968 knowledge that any (topological manifold) homology n -sphere, $n \geq 5$, is a *PL* manifold, then Kervaire's proof covers this case, too. (Aside: it is unknown whether every homology 4-sphere is a *PL* manifold, but topological immersion theory readily establishes, by immersing $H^n - \text{point}$ into \mathbb{R}^4 , that $H^n - \text{point}$ is a *PL* manifold).

The virtue of the following proof is its brevity.

PROOF OF PROPOSITION 1. It is rudimentary homotopy theory that one can attach to H^n a finite number of 2-cells, and then an equal number of 3-cells, to make H^n homotopically a sphere. Doing these attachings as surgeries in a band $H^n \times (0, 1)$ in $H^n \times S^1$, one produces from $H^n \times S^1$ a new manifold, say G , which is homotopically equivalent to $S^n \times S^1$. (The one nontrivial aspect of this argument is embedding the attaching 1- and 2-spheres to have product neighborhoods (i.e., trivial normal bundles). Perhaps this is most easily handled by using the above-mentioned immersion proof to put a smooth structure on $(H^n - \text{point}) \times (0, 1)$, and then doing all surgeries there, using well-known smooth arguments). Now the elementary argument in [Si6, Appendix I] establishes that \tilde{G} , the universal cover of G , is homeomorphic to $S^n \times \mathbb{R}^1$. Let $F = \tilde{G} \cup \infty \approx \mathbb{R}^{n+1}$ be gotten by compactifying one end of \tilde{G} . Then we can let $M^{n+1} \subset F$ be the bounded open complementary domain of $F - H^n \times 0$, where $H^n \times 0$ denotes any of the infinitely many natural copies of H^n in F . \square

As indicated in the Preliminaries, Theorem 4 follows from the more general

THEOREM 5 (single cell-like set version). *Suppose X is a cell-like set in a manifold-without-boundary M^m . If $m \geq 4$, then the stabilized quotient map $\pi \times id_{\mathbb{R}^1} : M \times \mathbb{R}^1 \rightarrow M/X \times \mathbb{R}^1$ is approximable by homeomorphisms.*

The $m = 3$ version of this theorem was established in [EP] [EM] under the additional assumption that X has a irreducible 3-manifold neighborhood in M , thus avoiding the Poincaré conjecture. The $m = 2$ version, which does not require stabilization, is considered classical. From the above-stated version of Theorem 5, one readily deduces the somewhat more general “closed-0-dimensional” version, as in [EP] [EM], explained again in [Ed2], but there is no reason to elaborate this here.

The reader will recognize the construction below as a straightforward generalization of that in Part I, a fact which I realized in the month (January 1975) following the completion of Part I. But the $m = 4$ case was elusive, and it wasn't until several months later (August 1975) that I realized that the solution there was to use the freedom of the extra \mathbb{R}^1 -coordinate.

In case X happens to be a codimension 2 polyhedron in M (e.g., if M is a compact contractible PL manifold, $\dim M \geq 5$, then M has such a spine X), then several steps in the following proof become trivial, so this is a good case to keep in mind.

Theorem 5 is proved by showing that the Bing Shrinking Criterion is satisfied, i.e., by proving

SHRINKING PROPOSITION. *Suppose X is a cell-like set in a manifold-without-boundary M^m . If $m \geq 4$, then given any neighborhood U of X and any $\varepsilon > 0$, there is a homeomorphism $h : M \times \mathbb{R}^1 \rightarrow M \times \mathbb{R}^1$, fixed on $(M - U) \times \mathbb{R}^1$, such that for each $t \in \mathbb{R}^1$,*

1. $h(U \times t) \subset U \times [t - \varepsilon, t + \varepsilon]$, and
2. $\text{diam } h(X \times t) < \varepsilon$.

Succinctly stated, the idea of the proof is to produce a neighborhood basis for X in M which is sufficiently standard in some sense, so that the constructions from Part I can be applied. Details follow.

Since X is cell-like, then X has a PL triangulable neighborhood in M^m (even when $m = 4$). The easiest proof of this is the one which uses topological immersion theory to immerse some neighborhood of X into \mathbb{R}^m (cf. proof of Proposition above). So without loss M is a PL manifold.

It is a standard fact that X has an arbitrarily small compact PL manifold neighborhood N in M such that N has an $(m - 2)$ -dimensional spine. This is proved by taking an arbitrary compact PL manifold neighborhood N_* of X , and by isotoping its dual 1-skeleton off of X , by an ambient isotopy supported in $\text{int } N_*$, using the fact that X is cell-like and $N_* - X$ has one end. Then a small neighborhood of the repositioned dual 1-skeleton of N_* can be deleted from N_* to produce N . This argument used the dimension restriction $m \geq 4$ in constructing the isotopy. (Recall that when $m = 3$ the existence of such a neighborhood for X a contractible 2-dimensional polyhedron would imply the Poincaré conjecture. However, in this dimension, if one hypothesizes in addition that X has an irreducible 3-manifold neighborhood, then such 1-spine neighborhoods exist; see [McM1, Lemma 1].)

Letting N be such a neighborhood of X , we can write $N = L \cup (\bigcup_{\alpha=1}^r H_\alpha)$ (see Figure II-1), where L is a compact manifold with an $(m - 3)$ -dimensional spine, and where the H_α 's are disjoint handles of index $m - 2$, attached to L so that for each α , $L \cap H_\alpha = \delta H_\alpha \subset \partial L$, where δH_α is the *attaching-boundary* of H_α , defined by $\delta H_\alpha = \partial D_\alpha^{m-2} \times D^2 \subset D_\alpha^{m-2} \times D^2 = H_\alpha$. The *core* of the handle is the $(m - 2)$ -cell $D_\alpha^{m-2} = D_\alpha^{m-2} \times 0 \subset D_\alpha^{m-2} \times D^2 = H_\alpha$. See Figure II-1.

This neighborhood N can be thought of as a higher dimensional analogue of the familiar 3-dimensional cube-with-handles neighborhood.

The primary goal is to establish

LEMMA 1 (Building a Single Window). *Suppose the data $X \subset N^m$ as above. Let H_α be any one of the $(m - 2)$ -handles of N . Then given any $\delta > 0$, there is a homeomorphism $h_\alpha : N \times \mathbb{R}^1 \rightarrow N \times \mathbb{R}^1$ such that*

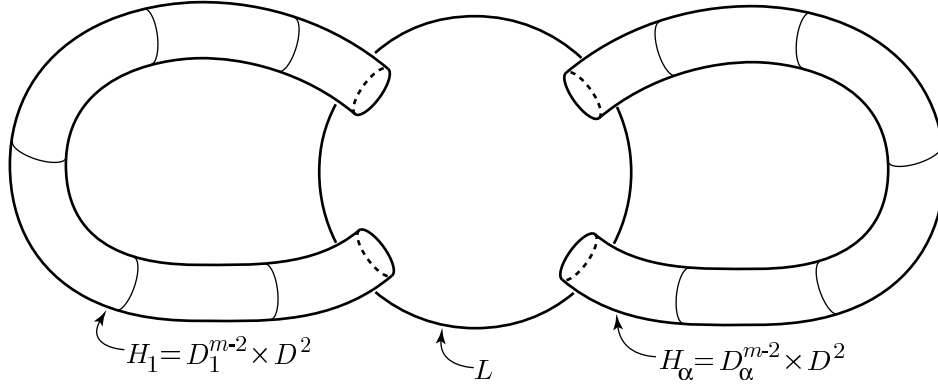

FIGURE II-1. The neighborhood $N = L \cup \bigcup_{\alpha=1}^r H_{\alpha}$

- (1) h_{α} has compact support in $\text{int } N \times \mathbb{R}^1$, and
- (2) for each $t \in \mathbb{R}^1$, if $h_{\alpha}(X \times t) \cap H_{\alpha} \times [-1, 1] \neq \emptyset$, then $\text{diam } h_{\alpha}(X \times t) < \delta$.

NOTE. h_{α} can be regarded as the analogue of the homeomorphism h_{*} constructed during the proof of the Window Building Lemma, Part I (at least in the case N has only one $(m-2)$ -handle H_{α}).

The first task is to describe a certain *model handle* sequence which will be used in the proof of Lemma 1. The 3-dimensional version of the model is a solid cylinder $H^3(0) = D^1 \times D^2$ (to be thought of as a 1-handle), containing the familiar infinite sequence of linked sub-1-handles as shown in Figure II-2. That is, $H^3(0)$, together with its subhandles, amount to the Bing collection of solid tori, cut in half by the vertical plane shown in Figure I-5. The *attaching-boundary* of $H^3(0)$ is the union of the two end discs, $\delta H^3(0) = \partial D^1 \times D^2$. The union of the 2^p sub-1-handles of $H^3(0)$ at stage p is denoted $H^3(p)$, with attaching-boundary $\delta H^3(p) = H^3(p) \cap \delta H^3(0)$.

In higher dimensions, the initial *model handle* is $H^m(0) \equiv H^3(0) \times D^{m-3}$ (which we really want to think of as $(D^1 \times D^{m-3}) \times D^2$), and the *attaching-boundary* of $H^m(0)$ is $\delta H^m(0) = \delta H^3(0) \times D^{m-3} \cup H^3(0) \times \partial D^{m-3}$ (which can then be thought of as the thickened $(m-3)$ -sphere $\partial(D^1 \times D^{m-3}) \times D^2$). Let $H^m(p) = H^3(p) \times D^{m-3}$ and let $\delta H^m(p) = H^m(p) \cap \delta H^m(0)$. It is important to realize that $\delta H^m(p)$ is **not** just $\delta H^3(p) \times D^{m-3}$, but also includes $H^3(p) \times \partial D^{m-3}$. Hence for $m \geq 1$, the subset $\delta H^m(p)$ of $\delta H^m(0)$ looks like the p^{th} stage of the spun Bing collection of thickened $(m-3)$ -spheres in $S^{m-3} \times B^2$.

We will need ramified versions of these models, produced in the spirit of R. Daverman's ramified cantor set constructions [Da1, Lemma 4.1]. Any stage in the construction of the sequence $\{H^3(p)\}$, starting with the 0th stage, may be *ramified*, which means that each handle of that stage is replaced by several adjacent, parallel copies of itself. Examples are shown in Figure II-3.

There may be a different number of ramifications performed in each handle-component at each stage; the only restriction is that the number of ramifications at each stage be finite. These ramification indices will not be recorded in any way, and our notation for a ramified handle will be the same as that for an unramified handle. It will become clear why these ramifications arise.

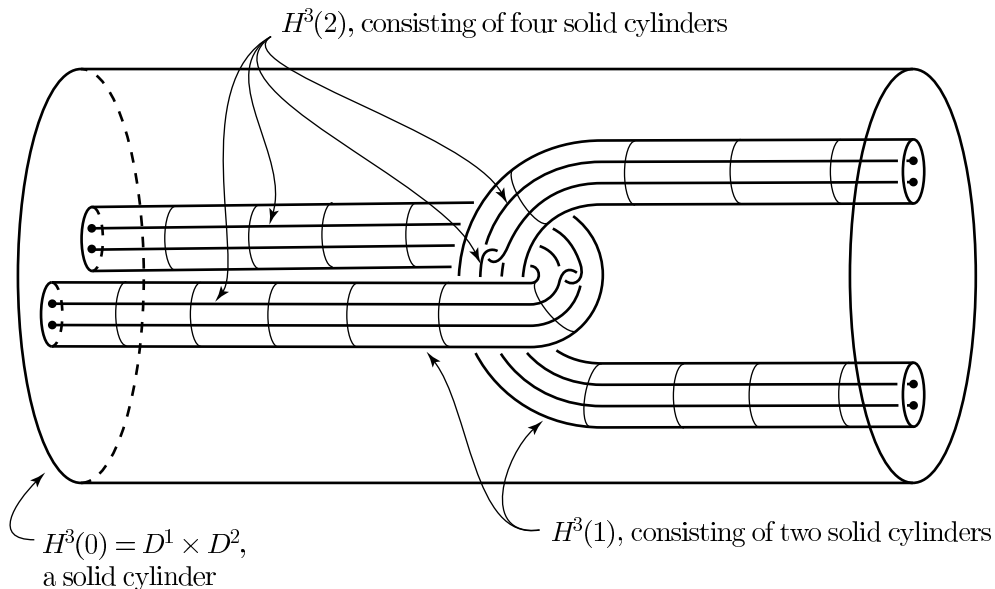

FIGURE II-2. The model handle sequence $H^3(0) \supset H^3(1) \supset H^3(2) \supset \dots$

A model ramified $(m-2)$ -handle sequence $\{H^m(p)\}$ is defined to be $\{H^3(p) \times D^{m-3}\}$, as before, where now $\{H^3(p)\}$ is a model ramified 1-handle sequence. In particular there is no ramification in the D^{m-3} -coordinate (whatever that would mean).

The reason for these model handles is for use in the following Lemma. From now on, we restrict attention to the $\dim M \geq 5$ case, returning to the $\dim M = 4$ case at the end of the proof.

LEMMA 2 (Repositioning). *Suppose X, N^m and H_α are as in Lemma 1, and suppose $m \geq 5$. Then for any $p \geq 0$, there is a repositioning of X in $\text{int } N$ (by an unnamed ambient isotopy of N rel ∂) and there is a sequence of compact neighborhoods of the repositioned X , $N = N_0 \supset N_1 \supset \dots \supset N_p$, such that the $(p+1)$ -tuple of pairs $(H_\alpha, \delta H_\alpha) \cap (N_0, N_1, \dots, N_p)$ is homeomorphic, respecting this filtered structure, to the first p stages of some model ramified pair $(H^m(0), \delta H^m(0))$, i.e., to*

$$((H^m(0), H^m(1), \dots, H^m(p)), (\delta H^m(0), \delta H^m(1), \dots, \delta H^m(p))).$$

We are really only interested in the p^{th} stage itself, but the intermediate stages help clarify the picture.

The Repositioning Lemma will be deduced by repeated application of the following Lemma, which was inspired by a similar construction in Štanko's work [Št1, § 3.1], [Št2, § 6.1], cf. [Ed1, Fundamental Lemma].

LEMMA 3. *Suppose N is a compact manifold neighborhood of a cell-like set X , $\dim N \geq 5$, and suppose D_1^2, \dots, D_q^2 are disjoint 2-discs in N such that for each j , $D_j^2 \cap \partial N = \partial D_j^2$ (with all embeddings nice, e.g. PL). Then for each j , there is a disc-with-handles F_j^2 , gotten from D_j^2 by adding some (unspecified) number of*

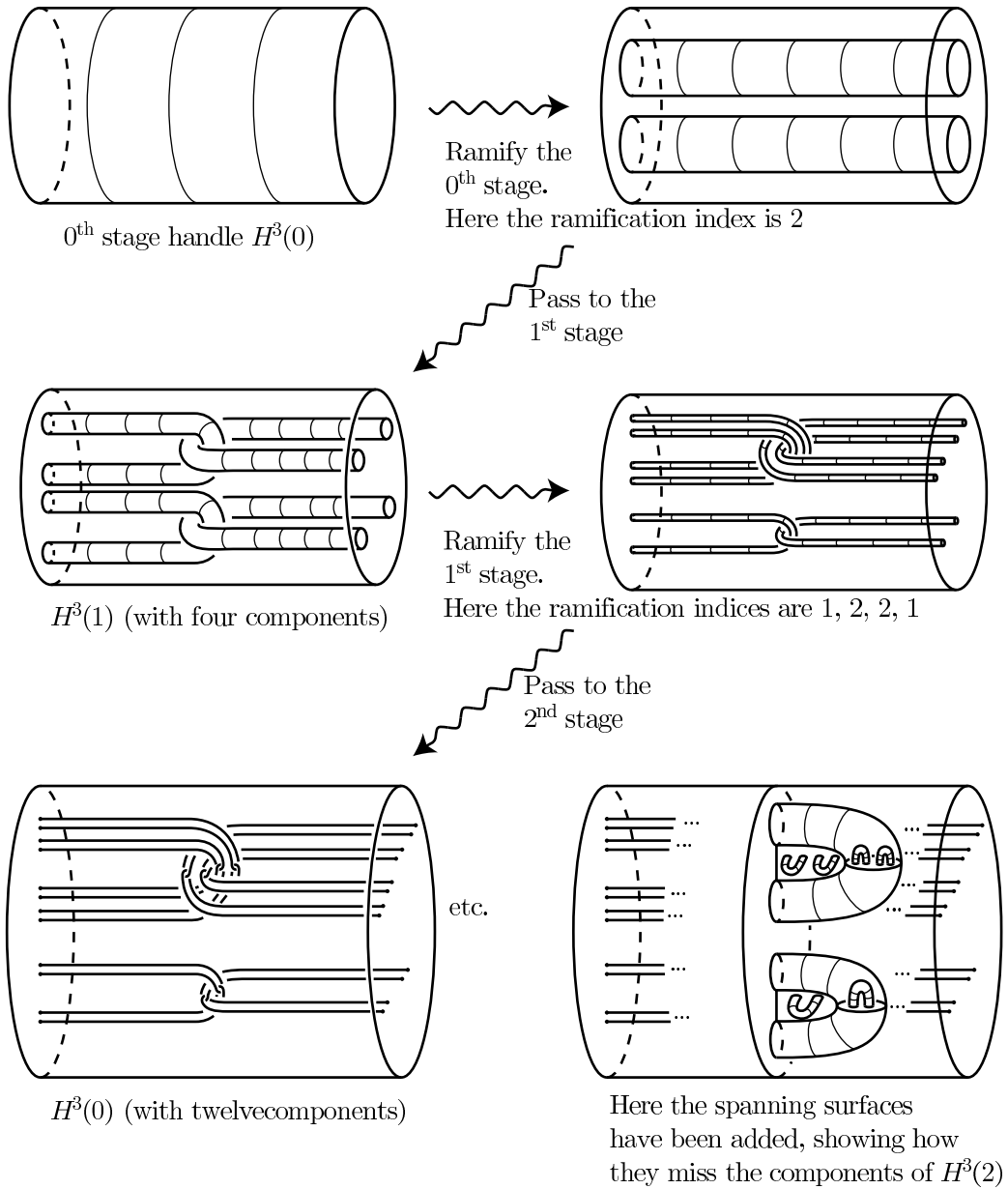

FIGURE II-3. Producing a model ramified handle sequence

standard handles, which are arbitrarily small and arbitrarily close to $D_j^2 \cap X$, and there is a repositioning of X , with support arbitrarily close to X , such that when done $X \cap (\bigcup_{j=1}^q F_j^2) = \emptyset$.

PROOF OF LEMMA 3. For simplicity, we treat only the $q = 1$ case, writing D^2 for D_1^2 ; the general case is the same. Also, we omit the precise treatment of epsilons. Let $A^2 \subset \text{int } D^2$ be a small compact 2-manifold neighborhood of $X \cap D^2$

in D^2 . The key fact is: for each component A_ℓ^2 of A^2 , there is a connected oriented surface \tilde{A}_ℓ^2 in $N - X$, lying close to X , with $\partial\tilde{A}_\ell^2 = \partial A_\ell^2$. This is because, by Alexander duality, loops in $N - X$ near X are null-homologous in $N - X$ near X . Let $\tilde{F}^2 = (D^2 - A^2) \cup \tilde{A}^2$, where \tilde{A}^2 is the union of the \tilde{A}_ℓ^2 's, general-positioned to be disjoint as necessary. It remains to isotope \tilde{F}^2 to coincide with the ‘‘standard’’ surface F^2 , which is gotten from D^2 by adding to each component of A_ℓ^2 a number of small handles equal to the genus of \tilde{A}_ℓ^2 . This is where X is moved. Since X is cell-like, there is a homotopy of \tilde{F}^2 inside of a small neighborhood of X , carrying $\text{id}: \tilde{F}^2 \rightarrow \tilde{F}^2$ to a homeomorphism $\tilde{F}^2 \rightarrow F^2$. Since $\dim M \geq 5$, this homotopy can be converted into an isotopy (if $\dim N = 5$, use general position and the Whitney trick to embed this 3-dimensional homotopy in $N \times I$ near $X \times I$, and then invoke concordance \Rightarrow isotopy). This completes the proof of Lemma 3. \square

PROOF OF LEMMA 2 FROM LEMMA 3. First we produce N_1 . Let D_α^2 be the cocore 2-disc of the handle H_α , i.e., $D_\alpha^2 = 0 \times D^2 \subset D_\alpha^{m-2} \times D^2 = H_\alpha^m$. Applying Lemma 3, we can assume that X has been repositioned so that $X \cap F_\alpha^2 = \emptyset$, where F_α^2 is gotten from D_α^2 by adding some number of small handles, say k of them. Let $H^m(1)$ denote the first stage of a model $(m - 2)$ -handle $H^m(0)$ in which the 0th stage ramification index is k , that is, $H^m(1)$ consists of k pairs of linked handles, instead of just one pair of linked handles as in the unramified model (caution: by our convention, handles from distinct pairs in $H^m(1)$ do not link; see Figure II-3, third frame.) Let N_1 be gotten from N by replacing H_α^m with a copy of $H^m(1)$, positioned so that $N_1 \cap F_\alpha^2 = \emptyset$, and so that N_1 is a spine of $N - F_\alpha^2$. This is best seen in the $m = 3$ case; see Figure II-3, third and sixth f . To complete this step, isotope X into $\text{int } N_1$.

Next, N_2 is produced inside of N_1 , just as N_1 was produced in N , this time using the $2k$ 2-discs in N_1 which are the natural cocore 2-discs of the $2k$ $(m - 2)$ -handles of N_1 lying in H_α . See Figure II-3, last four frames. In applying Lemma 3 to the set of 2-discs in N_1 , each 2-disc may have a different number of handles added, and so the ramification indices of these various first stage handles may be different (of course, one could add dummy handles, to make the indices all the same). Continuing this way one completes the proof of the Repositioning Lemma.

From this point on, the outline of the proof is the same as that of Part I, and we will concentrate only on the nontrivial differences. \square

PROOF OF LEMMA 1. This is modeled on the Basic Lemma of Part I. We will describe the analogous successive homeomorphisms h_1, h_2, h_3, h_4 , and finally the homeomorphism h_α , without precisely stating the full list of properties each has, to save unnecessary repetition.

During the course of this construction, there will be a great deal of ‘‘repositioning’’ of X in N , often unnamed, as done earlier in Lemmas 2 and 3, and this repositioning is to be built into the h_i 's. This repositioning is always to be thought of as being done in the source copy of $N \times \mathbb{R}^1$, that is, such motions will always be put in front of any already-constructed motions. It will be understood that any such repositionings in $N \times \mathbb{R}^1$ will be level-preserving, and will be damped to be the identity out near $N \times \pm\infty$, away from all of the essential activity.

The goal of the first three steps is to produce a homeomorphism h_3 which has nicely controlled behavior at the target level $N \times 0$, as before. But unlike in Part

I, there will be no discussion until Step 4 of the source-isolation of the components of $h_i(X \times \mathbb{R}^1) \cap N \times 0$.

Step 1. Suppose X has been repositioned so that $N_1 \subset N$ exists, as described in Lemma 2. For the moment, suppose the intersection $N_1 \cap H_\alpha$ is a single, unramified pair of linked handles. The purpose of h_1 is to “pierce” the intersection $N_1 \times \mathbb{R}^1 \cap N \times 0 = N_1 \times 0$ by moving $N_1 \times \mathbb{R}^1$ so that $h_1(N_1 \times \mathbb{R}^1) \cap N \times 0$ consists of two components, one of them a pierced copy of N_1 , and the other a thickened $(m-2)$ -sphere. This is most easily described in the source, using a polyhedral pair (A_1, B_1) , as in Part I. This time the important 2-dimensional part of A_1 (i.e., $A_1 - N \times (-\infty, 0]$) is more like a 2-dimensional finger rather than a 1-dimensional feeler with a 2-disc attached to its end. See Figure II-4.

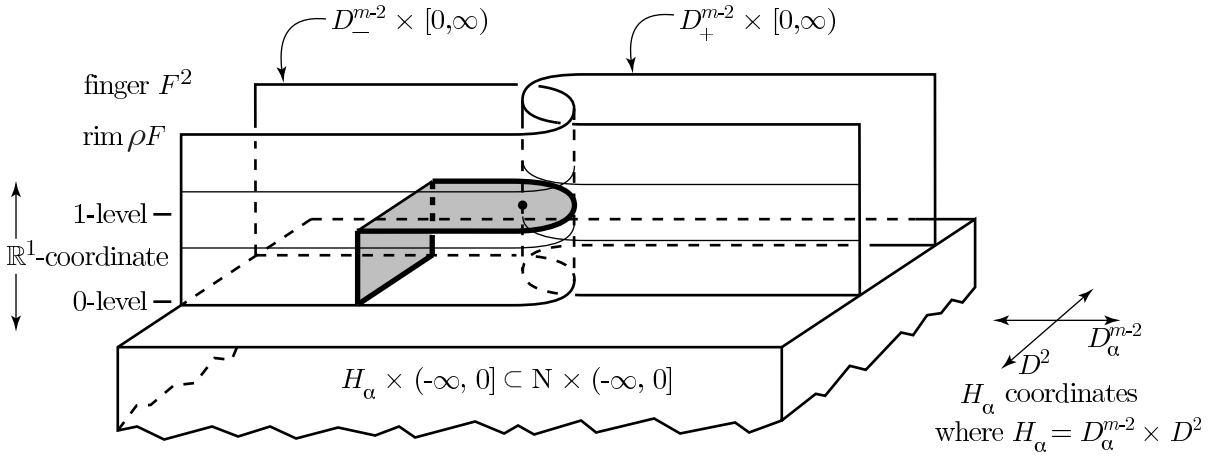

FIGURE II-4. The 2-dimensional finger part F^2 of A_1 , in the construction of h_1

If we were restricting the construction to the essential part of the linked handle pair $N_1 \cap H_\alpha$, namely the $(m-2)$ -dimensional cores $D_-^{m-2} \cup D_+^{m-2} \subset N_1 \cap H_\alpha$, then we would choose $A_1 \equiv N \times (-\infty, 0] \cup F^2$, where F^2 is a 2-dimensional finger (topologically a 2-disc) which intersects $N \times (-\infty, 0]$ in (the bottom) half of its 1-dimensional circle boundary, and intersects $D_-^{m-2} \times [0, \infty)$ in the other half of its boundary (\approx interval, called its *rim* and denoted ρ_-^F), and is such that $F^2 \cap (D_+^{m-2} \times \mathbb{R}^1) = \text{point}$. If the cores $D_-^{m-2} \cup D_+^{m-2}$ are thickened by crossing them with D^2 to form $N_1 \cap H_\alpha$, then F^2 should be thickened at its rim ρF by the same amount. Given this new, suitably thickened $A_1 = N \times (-\infty, 0] \cup F^2 \cup \rho F \times D^2$, let $h_1 : N \times \mathbb{R}^1 \rightarrow N \times \mathbb{R}^1$ be defined as in Part I, so that $h_1^{-1}(N \times (-\infty, 0])$ is a regular neighborhood rel $\partial N \times \mathbb{R}^1$ of A_1 in $N \times \mathbb{R}^1$, and so that $N_1 \times \mathbb{R}^1 \cap h_1^{-1}(N \times 0)$ is the frontier in $N_1 \times \mathbb{R}^1$ of a regular neighborhood rel $\partial N_1 \times \mathbb{R}^1$ of

$$B_1 \equiv A_1 \cap N_1 \times \mathbb{R}^1 = N_1 \times (-\infty, 0] \cup \rho F \times D^2 \cup (\text{point} \times D^2).$$

It follows that this set $N_1 \times \mathbb{R}^1 \cap h_1^{-1}(N \times 0)$ consists of the two components being sought, namely a pierced copy of N_1 and a thickened $(m-2)$ -sphere.

In the general ramified situation where the intersection $N_1 \cap H_\alpha$ consists of k pairs of linked handles instead of just one pair, one must use k fingers in A_1 instead of one, so that $h_1(N_1 \times \mathbb{R}^1) \cap N \times 0$ will have $k+1$ components, one of them a

k -times-pierced copy of N_1 , denoted $N_{1\#}$, and the other k of them being thickened $(m-2)$ -spheres.

To complete Step 1, one follows the above homeomorphism h_1 by a level-preserving homeomorphism of (the target) $N \times \mathbb{R}^1$, which moves $N_{1\#} \times 0$ in $N \times 0$ to be disjoint from the handle $H_\alpha \times 0$. It is the newly made holes in $N_{1\#}$ that allow this move, just as in the pierced duncehat case in Part I.

Step 2. The homeomorphism h_2 will be gotten from h_1 by preceding h_1 by a level-preserving repositioning of X in the source. Qualitatively this will be a mildly different point of view from that in Part I, but it will accomplish the same thing (Step 2 of Part I could have been done this way, but it didn't seem worth the effort in that simple situation).

Suppose $p = p(\delta)$ has been chosen, as it will be in Step 3 (caution: this p will correspond to $p-1$, not p , of Part I. Relabeling could be done to avoid this, but that probably would cause more confusion than it would prevent.) The motion needed to get h_2 from h_1 is simply this: X is repositioned in N_1 so that a sequence $N \supset N_1 \supset \dots \supset N_p$ of neighborhoods of X exists, as described in Lemma 2 (where N_1 is from the preceding Step 1). Then it turns out that the intersection $h_2(N_p \times \mathbb{R}^1) \cap N \times 0$, which lies in the previously constructed intersection $h_1(N_1 \times \mathbb{R}^1) \cap N \times 0$, consists of a copy of N_p that has been pierced many times, plus a collection of thickened $(m-2)$ -spheres which is equivalent to the collection of $(p-1)^{\text{st}}$ stage thickened $(m-2)$ -spheres in a ramified spun Bing collection of $(m-2)$ -spheres. If there were no ramifications done in constructing the sequence N_1, \dots, N_p , then there would be exactly 2^{p-1} thickened $(m-2)$ -spheres in this collection; in general, there are many more.

Step 3. The homeomorphism h_3 is gotten by following h_2 by a level-preserving homeomorphism of (the target) $N \times \mathbb{R}^1$, which shrinks to diameter $< \delta$ the thickened $(m-2)$ -sphere components of the intersection $h_2(N_p \times \mathbb{R}^1) \cap N \times 0$. This uses the shrinkability of the spun Bing collection of $(m-2)$ -spheres, explained in the Appendix to Part II. Here we assume that $p = p(\delta)$ was chosen so large that this shrinking to size less than δ is possible. At the end of this step, it has been arranged that each component of $h_3(N_p \times \mathbb{R}^1) \cap N \times 0$ which intersects $H_\alpha \times 0$ has diameter $< \delta$.

Steps 4 and α . These steps are combined, because the generality of the present setting makes it difficult² to construct a pure analogue of the homeomorphism h_4 of the duncehat case. The complicating factors will be explained after establishing some geometry.

The important thing to realize for this step is that near any thickened $(m-2)$ -sphere component $\Sigma_\mu^{m-2} \times D^2$ of $N_p \times \mathbb{R}^1 \cap h_3^{-1}(N \times 0)$ (working now in the source), the preimage $h_3^{-1}(N \times 0)$ looks like the boundary of a tubular neighborhood in $N \times \mathbb{R}^1$ of some 2-dimensional plane, call it $\mathbb{E}_\mu^2 \times 1$ (which we will assume lies in the level $N \times 1$), where \mathbb{E}_μ^2 cuts transversally across one of the $(m-2)$ -handles of N_p in N , say $D_\gamma^{m-2} \times D^2$, hence $\mathbb{E}_\mu^2 \cap D_\gamma^{m-2} \times D^2 = \text{point} \times D^2$. The plane \mathbb{E}_μ^2 is not a closed subset of N , so when we talk about a tubular neighborhood of $\mathbb{E}_\mu^2 \times 1$ in $N \times \mathbb{R}^1$, it should be understood that we are restricting attention to a neighborhood of $N_p \times \mathbb{R}^1$. The plane \mathbb{E}_μ^2 is not immediately apparent from the description given so far, but it could be obtained from the finger F^2 by puckering F^2 , just as the

²In fact impossible, by the example in [McM2].

corresponding plane int D_μ^2 in Part I was obtained by puckering the 2-disc part of A_1 . The only real difference between the present situation and that of Part I is the thickness of the various components of the picture, i.e., the fact that some of the components from Part I have been produced with D^2 to obtain the components here.

Consider the pair $(N(\mathbb{E}_\mu^2 \times 1), \partial N(\mathbb{E}_\mu^2 \times 1)) \cap N_p \times \mathbb{R}^1$, i.e. the intersection of the tubular neighborhood $N(\mathbb{E}_\mu^2 \times 1)$ of $\mathbb{E}_\mu^2 \times 1$ in $N \times \mathbb{R}^1$, and its boundary $\partial N(\mathbb{E}_\mu^2 \times 1)$, with $N_p \times \mathbb{R}^1$. It can be regarded as a pair $(\Delta_\mu^{m-1}, \Sigma_\mu^{m-2}) \times D^2$, where the (ball, boundary sphere) pair $(\Delta_\mu^{m-1}, \Sigma_\mu^{m-2})$ is the intersection of the pair $(N(\mathbb{E}_\mu^2 \times 1), \partial N(\mathbb{E}_\mu^2 \times 1))$ with $D_\gamma^{m-2} \times \mathbb{R}^1$, where D_γ^{m-2} is as above. As a consequence, the intersection $N_p \times \mathbb{R}^1 \cap h_3^{-1}(N \times [-\epsilon, \epsilon])$, for small $\epsilon > 0$, can be regarded as being $\Sigma_\mu^{m-2} \times [-\epsilon, \epsilon] \times D^2$, where $\Sigma_\mu^{m-2} \times [-\epsilon, \epsilon]$ denotes a small collar neighborhood of Σ_μ^{m-2} in $D_\gamma^{m-2} \times \mathbb{R}^1$, and where the correspondence preserves the $[-\epsilon, \epsilon]$ -coordinate. By a simple reparametrization of this collar coordinate, combined with an expansion in the target taking $N \times [-\epsilon, \epsilon]$ onto $N \times [-1, 1]$, we can assume without loss that $\epsilon = 1$ above, which we do from now on.

As in Part I, the components of the intersection $N_p \times \mathbb{R}^1 \cap h_3^{-1}(N \times [-1, 1])$ can be made (source-)isolated, i.e., their projections to the \mathbb{R}^1 coordinate can be arranged to be disjoint, because the various disjoint thickened $(m-1)$ -cells $\{\Delta_\mu^{m-1} \times D^2\}$ corresponding to the spherical components of intersection can be slid vertically to have nonoverlapping \mathbb{R}^1 -coordinate values. Another way of saying this is that the planes $\{\mathbb{E}_\mu^2 \times 1\}$ in $N \times \mathbb{R}^1$ can be vertically repositioned to lie at different levels $\{\mathbb{E}_\mu^2 \times t_\mu\}$. We assume that this has been done (as it was in Part I).

In constructing the homeomorphism h_α there are two aspects of this general situation which serve to make this step more complicated than that of Part I: the 2-plane \mathbb{E}_μ^2 may intersect X in more than a single point, and also $X \times t_\mu$ may not have a ball regular neighborhood in $N \times \mathbb{R}^1$ whose boundary slices $X \times \mathbb{R}^1$ at precise, entire levels (this was guaranteed in Part I by $K \times I$ being collapsible). Before dealing with these difficulties, it is worth noting that if in fact these nice conditions prevail, then the construction in Part I for h_4 and h_* also works here to produce h_α .

The following adaptation of the Part I construction will take care of both difficulties at the same time. Suppose for the moment that $C_\mu \equiv \mathbb{E}_\mu^2 \cap X$ is 0-dimensional, e.g., a cantor set. Let $\phi_\mu : N \times \mathbb{R}^1 \rightarrow N \times \mathbb{R}^1$ be a near-homeomorphism (i.e. a limit of homeomorphisms), supported arbitrarily near $X \times t_\mu$, such that for each $t \in \mathbb{R}^1$, if $\phi_\mu(X \times t) \cap \mathbb{E}_\mu^2 \times t_\mu \neq \emptyset$, then $\phi_\mu(X \times t) = \text{point} \in \mathbb{E}_\mu^2 \times t_\mu$, and furthermore these $X \times t$'s are the only nontrivial point-inverses of ϕ_μ (see Figure II-5). To get the map ϕ_μ , basically one uses the idea that any cantor set's worth of $X \times t$'s in $N \times \mathbb{R}^1$ is shrinkable. Arguing more precisely, one first can do a vertical perturbation of $\mathbb{E}_\mu^2 \times t_\mu$ to make it intersect each $X \times t$ in at most a single point, and then one can use engulfing to shrink these $X \times t$'s to the points of intersection, keeping fixed the repositioned $\mathbb{E}_\mu^2 \times t_\mu$. After shrinking, one brings the repositioned $\mathbb{E}_\mu^2 \times t_\mu$ back to its original position, using the inverse of the original vertical perturbation.

Given ϕ_μ , the idea now is to do a sort of expansion-meshing operation, by taking the earlier chosen collar $\Sigma_\mu^{m-2} \times [-1, 1]$ in $D_\gamma^{m-2} \times \mathbb{R}^1$ (recall $\epsilon = 1$) and isotoping it in $D_\gamma^{m-2} \times \mathbb{R}^1$ in a certain manner. Because of the correspondence

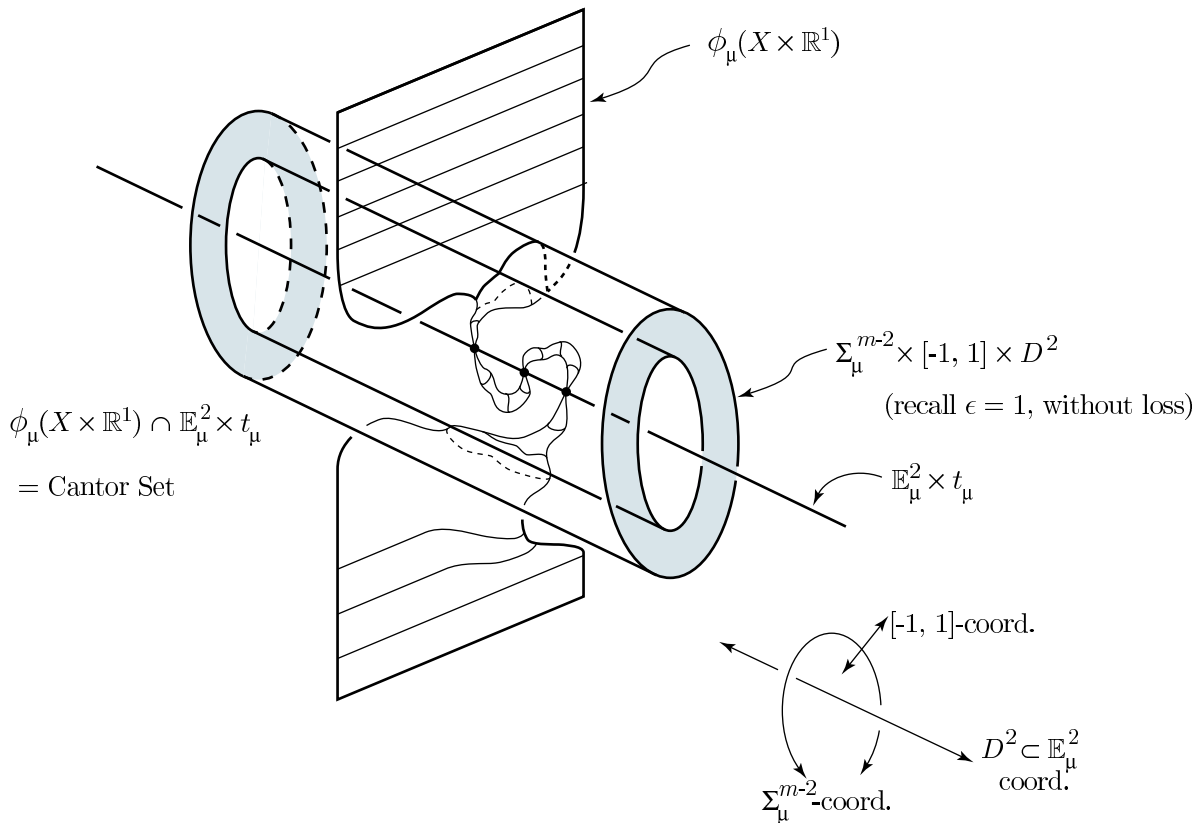
FIGURE II-5. The construction of h_4 and h_α

made above of $\Sigma_\mu^{m-2} \times [-1, 1] \times D^2$ with $N_p \times \mathbb{R}^1 \cap h_3^{-1}(N \times [-1, 1])$, this isotoping may be regarded as producing a modification of the homeomorphism h_3 . The goal of isotoping the collar is to achieve, for an arbitrary preassigned $\eta > 0$, that for each $t \in \mathbb{R}^1$, $\phi_\mu(X \times t) \cap \Sigma_\mu^{m-2} \times [-1, 1] \times D^2 \subset \Sigma_\mu^{m-2} \times [s - \eta, s + \eta] \times D^2$ for some $s \in [-1, 1]$. This is done as follows. First, one takes the originally chosen collar $\Sigma_\mu^{m-2} \times [-1, 1]$ and, keeping the outer boundary $\Sigma_\mu^{m-2} \times 1$ fixed, one isotopes the band $\Sigma_\mu^{m-2} \times [-1, 1 - \eta]$ so close to the plane $\mathbb{E}_\mu^2 \times t_\mu$ that no image $\phi_\mu(X \times t)$, t arbitrary, intersects both $\Sigma_\mu^{m-2} \times 1$ and $\Sigma_\mu^{m-2} \times [-1, 1 - \eta]$. Next, keeping fixed the repositioned band $\Sigma_\mu^{m-2} \times [1 - \eta, 1]$ one isotopes the band $\Sigma_\mu^{m-2} \times [-1, 1 - 2\eta]$ much closer to the plane $\mathbb{E}_\mu^2 \times t_\mu$, so that no image $\phi_\mu(X \times t)$ intersects both $\Sigma_\mu^{m-2} \times [1 - \eta, 1]$ and $\Sigma_\mu^{m-2} \times [-1, 1 - 2\eta]$. Continuing this way, the desired degree of control is achieved.

Having done this expansion-meshing operation, independently and disjointly for each μ , then one can define $h_\alpha = \bar{h}_3 \bar{\phi}$, where $\bar{\phi}$ is a homeomorphism closely approximating the union ϕ of all of the ϕ_μ 's that were chosen above, and where \bar{h}_3 denotes the homeomorphism obtained by modifying h_3 by the expansion-meshing operations just described.

It remains to discuss how the 0-dimensionality of C_μ can be achieved. If X had dimension $\leq m - 2$, i.e. if X had codimension ≥ 2 in N , then achieving this

would be an easy matter of putting X in topological general position with respect to \mathbb{E}_μ^2 . This suggests a solution: make X have dimension $\leq m - 2$. That is, replace X with a new cell-like space X_* lying near X and obtained from X by a certain limiting process, such that $\dim X_* \leq m - 2$ and $M - X_* \approx M - X$. The most convenient time to do this is at the very start of the proof, using the fact that X has arbitrarily small neighborhoods with spines of dimension $\leq m - 2$. For if one takes a nested basis of such neighborhoods, and squeezes the first one close to its spine, and then the (repositioned) second one very close to its (repositioned) spine, etc., one produces in the limit the desired X_* . This process is enlarged upon in the Postscript below, where a replacement X_* having much nicer properties is produced. This completes the proof of Lemma 1, in the $m \geq 5$ case.

In the $m = 4$ case, the above proof breaks down for one essential reason: Lemma 2 is unknown. The trouble comes in Lemma 3, in constructing the surfaces \tilde{A}_ℓ^2 (which can in fact be done), and in trying to move these surfaces back to standard position by isotopy (this is a fundamental problem). The way to circumvent this difficulty is to use the extra freedom provided by the \mathbb{R}^1 coordinate, which in effect turns the problem from a 4-dimensional problem into a 5-dimensional problem. An outline of this rescue operation follows.

The idea is that one can at least do the already-described motions of Lemma 3 in $N \times \mathbb{R}^1$, if not in N . This lets one prove a weaker version of Lemma 2, which says that $X \times \mathbb{R}^1$ can be repositioned in $N \times \mathbb{R}^1$ so that $X \times \mathbb{R}^1 \cap N \times [-a, a] \subset N_p \times [-a, a]$ for any preassigned large a (of course, the vertical movement of $X \times \mathbb{R}^1$ may have to be as large as a , but that is not important). Now, one can do Steps 1, 2, and 3 above without change. Step 4- α works also (let us assume, as justified above, that $\dim X \leq 2$), even though $X \times \mathbb{R}^1$ has been grossly perturbed. One can still make the intersection of $\mathbb{E}_\mu^2 \times t_\mu$ with the perturbed $X \times \mathbb{R}^1$ be 0-dimensional, with the intersection points all having distinct \mathbb{R}^1 -coordinates in $X \times \mathbb{R}^1$, and then one can shrink these particular $X \times t$ levels to these intersection points. Then the expansion-meshing works as described, to produce h_α .

The proof of Lemma 1 is now complete, for all $m \geq 4$, as claimed. \square

From this point on, the proof is modeled on [EM, pp. 201,202], just as the proof in Part I. The first step is to establish the

WINDOW BUILDING LEMMA. *Suppose the data $X \subset N^m$ as earlier (explained before Lemma 1), and let $H_\# = \cup_{\alpha=1}^r H_\alpha$ be the union of the $(m - 2)$ -handles of N . Then given any $\delta > 0$, there is a homeomorphism $h_\# : N \times \mathbb{R}^1 \rightarrow N \times \mathbb{R}^1$, fixed on $\partial N \times \mathbb{R}^1$, such that*

1. *for each $j \in 2\mathbb{Z}$ and each $t \in [j - 1, j + 1]$, $h_\#(N \times t) \subset N \times [j - 1, j + 1]$,
and*
2. *for each $t \in \mathbb{R}^1$, if $h_\#(X \times t) \cap H_\# \times [j - 1 + \delta, j + 1 - \delta] \neq \emptyset$ for any $j \in 2\mathbb{Z}$, then $\text{diam } h_\#(X \times t) < \delta$.*

This is easily proved from the model single window version, Lemma 1. The idea is first to construct a homeomorphism $h_* : N \times \mathbb{R}^1 \rightarrow N \times \mathbb{R}^1$, compactly supported in $\text{int } N \times \mathbb{R}^1$, such that h_* satisfies condition (2) above for the value $j = 0$. This h_* is gotten by first selecting some nonoverlapping vertical translates of the “window blocks” $H_\alpha \times [-1 + \delta, 1 - \delta]$, $1 \leq \alpha \leq r$ then applying Lemma 1 separately to “make a window” in each of these completely disjoint blocks, using for this the different

h_α 's, and finally translating these windows back to their original positions. Next, h_* can be conjugated by a vertical homeomorphism of $N \times \mathbb{R}^1$ to arrange that the support of h_* lies in $\text{int } N \times (-1, 1)$. From this h_* , one builds the desired $h_\#$ by stacking vertical translates of h_* on top of each other.

PROOF OF SHRINKING PROPOSITION FROM THE WINDOW BUILDING LEMMA. Given a neighborhood U of X in M^m and an $\epsilon > 0$, choose a small ball B^m in U , with $\text{diam } B^m < \epsilon/2$ and $\text{int } B^m \cap X \neq \emptyset$. We show how to construct a homeomorphism $h : M \times \mathbb{R}^1 \rightarrow M \times \mathbb{R}^1$, fixed on $(M - U) \times \mathbb{R}^1$, which satisfies the following weakened versions of the conditions from the Shrinking Proposition: for each $t \in \mathbb{R}^1$,

- 1'. $h(U \times t) \subset U \times [t - 3, t + 3]$, and
- 2'. either
 - a. $h(X \times t) \subset B^m \times [t - 3, t + 3]$, or
 - b. $\text{diam } h(X \times t) < \epsilon$.

From this it is clear that the original Shrinking Proposition follows, simply by rescaling the vertical coordinate.

To construct this h , first one constructs a certain auxiliary homeomorphism $g = g_2 g_1 : M \times \mathbb{R}^1 \rightarrow M \times \mathbb{R}^1$. Let $*$ in $\text{int } B^m \cap X$ be a basepoint. First one chooses a uniformly continuous homeomorphism g_2 , which is supported in $\bigcup \{U \times [j + \frac{1}{2}, j + \frac{3}{2}] \mid j \in 2\mathbb{Z}\}$ and fixed on $* \times \mathbb{R}^1$, such that for each $j \in 2\mathbb{Z}$, $g_2(X \times (j + 1)) \subset \text{int } B^m \times \mathbb{R}^1$. The existence of g_2 follows from the cellularity of $X \times t$ in $M \times \mathbb{R}^1$. Let V be a compact neighborhood of X in U such that $g_2(V \times (j + 1)) \subset \text{int } B^m \times \mathbb{R}^1$ for each $j \in 2\mathbb{Z}$, and let C^m be a compact neighborhood of $*$ in B^m such that $g_2(C^m \times \mathbb{R}^1) \subset \text{int } B^m \times \mathbb{R}^1$. By codimension 3 engulfing, there is a (small) neighborhood N of X in V , with structure $N = L \cup \bigcup_{\alpha=1}^r H_\alpha$ as discussed earlier (so in particular L has an $(m - 3)$ -spine), and there is a homeomorphism $g_0 : M \rightarrow M$, supported in V , such that $g_0(L) \subset C$. Let $g_1 = g_0 \times \text{id}_{\mathbb{R}^1} : M \times \mathbb{R}^1 \rightarrow M \times \mathbb{R}^1$. Then $g = g_2 g_1 : M \times \mathbb{R}^1 \rightarrow M \times \mathbb{R}^1$ is such that

- 1. $g = \text{identity on } (M - U) \times \mathbb{R}^1$, and for each $t \in \mathbb{R}^1$, $g(U \times t) \subset U \times [t - 1, t + 1]$, and
- 2. the image under g of $L \times \mathbb{R}^1 \cup \bigcup \{N \times (j + 1) \mid j \in 2\mathbb{Z}\}$ lies in $B^m \times \mathbb{R}^1$.

Given g , then one can let $h = gh_\#$, where $h_\#$, is provided by the Window Building Lemma for some sufficiently small value of $\delta = \delta(\epsilon, g)$, and where $h_\#$ is assumed to be extended via the identity over $(M - N) \times \mathbb{R}^1$. This completes the proof of the Shrinking Proposition, and hence Theorem 2.

Postscript to Part II

□

Embedded in the preceding proof is what I call the

REPLACEMENT PRINCIPLE FOR CELL-LIKE SETS. *Given any cell-like compact set X in a manifold-without-boundary M , $\dim M \geq 5$, then X can be replaced by a nearby 1-dimensional cell-like set X_* , such that $M - X_*$ is homeomorphic to $M - X$, while X_* is homeomorphic to a reduced cone on a cantor set (defined more precisely below).*

In fact, the replacement operation can be done in the following continuous manner. There is an isotopy of embeddings $g_t : M - X \rightarrow M$, $0 \leq t \leq 1$, starting at $g_0 = \text{identity}$ and fixed off of an arbitrarily small neighborhood of X , such that $g_1(M - X) = M - X_$. Thus, in particular, X is transformed to X_* in a semicontinuous fashion, through the intermediate cell-like sets $\{M - g_t(M - X)\}$.*

I first enunciated this principle at the time of the Park City Conference (February 1974), when I proved it for (wildly embedded) cell-like sets X of codimension ≥ 3 , using my variation of the proof of Štanko's Approximation Theorem (unpublished notes; cf. [BL2]). In certain special cases one can find better replacements for X , e.g. Giffen's replacement of the duncehat spine of Mazur manifold by a 2-disc [Gi] (which can then be made into an arc (see [DE] and [She, §3])), but as general rule, the above principle seems the best possible, even for X a polyhedron.

PROOF OF THE REPLACEMENT PRINCIPLE FOR CELL-LIKE SETS . (Using the machinery of Part II). The basic tool is the following variation of Lemma 2 (see Figure IIP-1). Recall $m \geq 5$. □

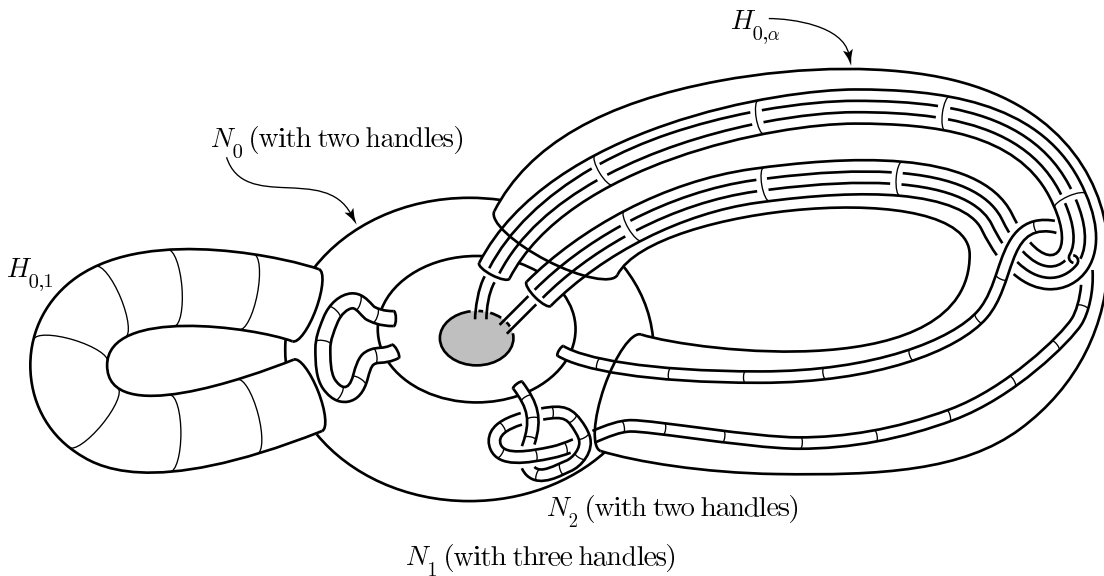

FIGURE IIP-1. The nested neighborhood sequence $\{N_i\}$, from the Postscript.

LEMMA 2'. Given any neighborhood $N_0^m = L_0 \cup \bigcup\{H_{0,\alpha} \mid 1 \leq \alpha \leq r_0\}$ of X with structure as described earlier (i.e., L_0 has an $(m-3)$ -spine, and the $H_{0,\alpha}$'s are $(m-2)$ -handles attached to L_0 , then there is an arbitrarily small neighborhood $N_1 = L_1 \cup \{H_{1,\beta} \mid 1 \leq \beta \leq r_1\}$ of X in $\text{int } N_0$, and a repositioning of N_1 in N_0 (by an unnamed isotopy of $N_0 \text{ rel } \partial N_0$), such that after repositioning,

1. $L_1 \subset \text{int } L_0$,
2. for each handle $H_{0,\alpha}$ of N_0 , the triple $(H_{0,\alpha}, \delta H_{0,\alpha}, H_{0,\alpha} \cap N_1)$ is homeomorphic to a standard triple $(H(0), \delta H(0), H(1))$, where $H(1)$ is a ramified collection of 1st stage $(m-2)$ -handles in $H(0)$ (as defined earlier; see Figure II-3, third frame), and
3. each handle $H_{1,\beta}$ of N_1 intersects at most one handle $H_{0,\alpha}$ of N_0 , and there is at most one component of intersection (which by (2) is a single subhandle of $H_{0,\alpha}$).

PROOF OF LEMMA 2'. First choose an arbitrarily small neighborhood N^m of X having $(m-2)$ -spine, and position N in N_0 , using simple general positioning, so that for each handle $H_{0,\alpha}$ of N_0 , the intersection $N \cap H_{0,\alpha}$ goes straight through the handle, looking like several parallel, smaller copies of $H_{0,\alpha}$ (i.e., like a ramified version of $H_{0,\alpha}$, as in Figure II-3, second frame). Now, using the earlier Repositioning Lemma 2, applied to N and the 2-discs which are the central cocores of the handle-components of $N \cap H_{0,\alpha}$, for all α , find a repositioning of X in N and a neighborhood N_1 having $(m-2)$ -spine such that for each handle $H_{0,\alpha}$, the intersection $H_{0,\alpha} \cap N_1$ is as described in (2) above. It remains to achieve (1) and (3). Let the $(m-2)$ -dimensional spine K_1 of N_1 be positioned, and subdivided if necessary, so that $K_1^{(m-3)} \subset \text{int } L_0$, and so that each $(m-2)$ -simplex of K_1 intersects at most one $(m-2)$ -handle $H_{0,\alpha}$ of N_0 , in at most a single $(m-2)$ -disc. Now squeeze N_1 close to its newly positioned spine K_1 , and let L_1 be the "restriction" of N_1 to $K_1^{(m-3)}$. This completes the proof of Lemma 2'. \square

PROOF OF REPLACEMENT PRINCIPLE (CONTINUED). Given Lemma 2', one applies it repeatedly to produce an infinite sequence $\{N_i = L_i \cup \bigcup\{H_{i,\gamma} \mid 1 \leq \gamma \leq r_i\}\}$ of neighborhoods of X , repositioning X at each step, such that each N_i is null homotopic in its predecessor N_{i-1} , and is positioned there as described by Lemma 2'. This produces in the limit a new cell-like compactum $X_\infty = \bigcap\{N_i\}$. We assume in addition that in the sequence $\{N_i\}$ the handle alignment is maintained from step to step as shown in Figure IIP-1 so that for any handle $H_{i,\gamma}$ of any neighborhood N_i , the triple $(H_{i,\gamma}, \delta H_{i,\gamma}, H_{i,\gamma} \cap X_\infty)$ is homeomorphic to a model ramified triple $(H(0), \delta H(0), H(\infty))$, where $H(\infty) \equiv \bigcap_{p=0}^\infty H(p)$, which is a ramified collection of $(m-2)$ -dimensional Bing cells. Elaborating this, letting $\delta H(\infty) \equiv \bigcap_{p=0}^\infty \delta H(p) = H(\infty) \cap \delta H(0)$, then $\delta H(\infty)$ is a cantor set's worth of $(m-3)$ -cells (namely the $(m-4)$ -times-spun Bing collection of arcs) and $(H(\infty), \delta H(\infty)) \approx \delta H(\infty) \times ([0, 1], 0)$. Hence in particular $X_\infty - \text{int } H_{i,\gamma}$ is a strong deformation retract of X_∞ .

For each handle $H_{i,\gamma}$, let $G_{i,\gamma}$ denote the union of all $(m-2)$ -handles $H_{j,\sigma}$, $j > 1$, which intersect $H_{i,\gamma}$, and let $F_{i,\gamma} = G_{i,\gamma} \cap X_\infty$. By our assumptions, if $H_{i,\gamma}$ and $H_{k,\tau}$ are two handles and if $G_{i,\gamma} \cap G_{k,\tau} \neq \emptyset$ then $k > i$ and $G_{k,\tau} \subset G_{i,\gamma}$ (or vice versa). More importantly, $F_{i,\gamma}$ is homeomorphic to $H(\infty) - \delta H(\infty)$ for some

ramified model $H(\infty)$. Let $L_\infty = \bigcap_{i=0}^\infty L_i \subset X_\infty$, so that $X_\infty - L_\infty$ is the disjoint union of all of the $F_{i,\gamma}$'s.

Claim. L_∞ is cellular in M .

Proof. L_∞ is cell-like because it is the intersection of a nested sequence of cell-like sets, namely $L_\infty = \bigcap_{i=0}^\infty (L_i \cap X_\infty)$. Each set $L_i \cap X_\infty$ is cell-like because it is a retract of X_∞ , for as noted above, $X_\infty - \text{int } H_{i,\gamma}$ is a strong deformation retract of X_∞ for each $m-2$ handle $H_{i,\gamma}$ of N_i . Granted that L_∞ is cell-like, then it is cellular because it is an intersection of manifolds having $(m-3)$ -spines. This establishes the Claim.

Since L_∞ is cellular, it can be shrink to a point, producing $X_\# = X_\infty/L_\infty$. This space $X_\#$ has particularly nice structure, being a countable null wedge of subsets of M each homeomorphic to $H(\infty)/\delta H(\infty)$. This latter set is a cone on a cantor set's worth of $m-3$ cells (as in Bing's original $m=3$ case). To obtain X_* from $X_\#$, one can use the shrinkability of the spun Bing collection of $(m-3)$ -cells (see the Appendix) to shrink each copy of $H(\infty)/\delta H(\infty)$ to a cone on a cantor set, by shrinking to a cantor set each of the parallel copies of $\delta H(\infty) \times \{\text{point}\}$ that make up $H(\infty)/\delta H(\infty) \approx \delta H(\infty) \times [0, 1]/\delta H(\infty) \times 0 = c\delta H(\infty)$.

Appendix. Shrinking the spun Bing decomposition.

□

The k -times spun Bing decomposition of euclidean $(3 + k)$ -space into points and tame $(k + 1)$ -discs, described earlier and again below, is at the very heart of the work of Parts I and II (and Cannon's subsequent work, too). The purpose of this Appendix is to establish:

THEOREM 6. *The spun Bing decomposition is shrinkable.*

The ramified versions of the spun Bing decomposition, which appeared earlier in Part II, are also shrinkable. This will be evident from the construction below, which also works in the ramified context, with identical motions and equal efficiency.

The k -times spun Bing decomposition has been around for some time (as I found out after needing and proving the above theorem in 1974). L. Lininger, in order to exhibit some nonstandard topological involutions of spheres, showed in [Li] that the once-spun version was shrinkable, and suggested that the higher dimensional versions were also. Neuzil's thesis [Neu] handled a class of decompositions of 4-space that included the once-spun version. Recently, R. Daverman [Da3, Cor 11.7] showed that the shrinkability of the general k -times-spun, versions, $k \geq 2$, followed from a general mismatch theorem. This was adapted to the $k = 1$ case in [CD].

The proof given here is elementary, in the sense of Bing's original proof, for that is what it is modeled on. In fact, it is almost fair to say that one simply takes Bing's original proof and spins it.

PROOF OF THEOREM 6. The proof is divided into two natural steps. The first step describes a certain decomposition of $\mathbb{R}^3 \times [0, \infty)$, gotten by unfolding, or unraveling, the original Bing decomposition of $\mathbb{R}^3 \times 0$, and then shows that this decomposition of $\mathbb{R}^3 \times [0, \infty)$ is shrinkable in a certain level-preserving manner. The second step shows how to spin these motions to shrink the spun Bing decomposition.

Step 1. Consider the original Bing decomposition of \mathbb{R}^3 (from [Bi1]), as shown at the bottom of Figure IIA-1. It is defined using two disjoint, linked embeddings $\chi_-, \chi_+ : S^1 \times D^2 \rightarrow S^1 \times \text{int } D^2$, whose images are denoted $S_-^1 \times D^2$ and $S_+^1 \times D^2$. By taking iterates of these embeddings, e.g. $\chi_+(\chi_-(S^1 \times D^2))$, one obtains the deeper stages of the defining neighborhood sequence of solid tori. At the p^{th} stage, there are 2^p linked solid tori, denoted $\{S_\mu^1 \times D^2 \mid \mu \in \{-, +\}^p\}$, embedded in the original solid torus $S^1 \times D^2$. Letting T_p denote the union of the 2^p p^{th} stage components, then the nontrivial elements of the Bing decomposition of \mathbb{R}^3 are the components of the intersection $\bigcap_{p=1}^\infty T_p$, which can be arranged to be C^∞ -smooth arcs, as suggested in Figure IIA-1.

We wish to extend this decomposition of $\mathbb{R}^3 = \mathbb{R}^3 \times 0$ to one of $\mathbb{R}^3 \times [0, \infty)$, with all decomposition elements lying in levels $\{\mathbb{R}^3 \times t\}$, by unravelling it, as suggested by Figure IIA-1. Fix some small $\eta > 0$. Then, as one works up through the levels, from $t = 0$ to $t = 1$, the following activity takes place: from $t = 0$ to $t = 1 - \eta$, nothing happens, i.e., the decomposition of each intermediate level is just a translate of the decomposition of the 0-level; from $t = 1 - \eta$ to $t = 1 - \eta/2$, the first stage is unraveled, i.e., $S_+^1 \times D^2$ and $S_-^1 \times D^2$ are isotoped until they look disjoint (i.e., are separated by a hyperplane), as pictured; from $t = 1 - \eta/2$ to $t = 1 - \eta/3$, the second stage is unraveled, etc. What one obtains is an unraveling of the original

UNDERSTANDING THE SPUN BING DECOMPOSITION

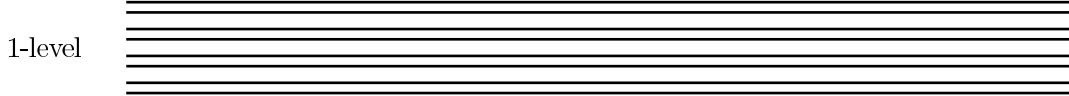

At this topmost level, all of the stages are completely unraveled. They comprise a straight Cantor set of arcs.

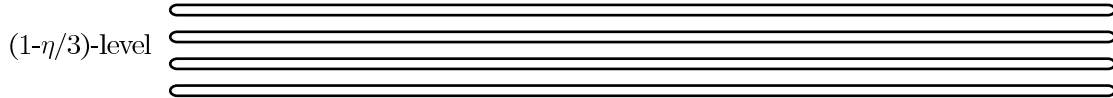

At this level the first and second stages are unraveled.

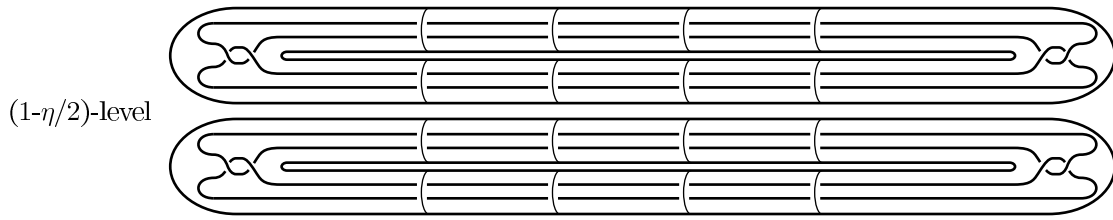

At this level the first stage is unraveled.

(1- η)-level (Same picture as at the 0-level)

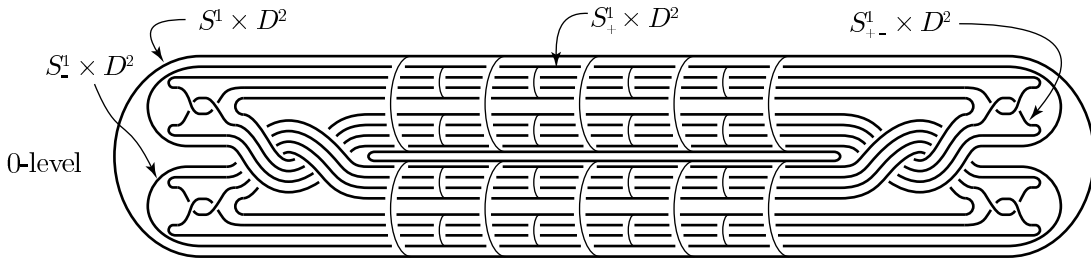

“ t -level” means the subset $\mathbb{R}^3 \times t$.

This level represents the original Bing decomposition of $\mathbb{R}^3 = \mathbb{R}^3 \times 0$ into points and a Cantor set’s worth of smooth arcs.

FIGURE IIA-1. Unraveling the original Bing decomposition in $\mathbb{R}^3 \times [0, \infty)$

Bing decomposition of $\mathbb{R}^3 \times 0$ to a standard decomposition of $\mathbb{R}^3 \times 1$ consisting of

a straight cantor set's worth of arcs. (It is interesting to ponder the pseudoisotopy of \mathbb{R}^3 that this process yields in the limit, but that is another matter.)

There is a natural “defining neighborhood sequence” for this decomposition of $\mathbb{R}^3 \times [0, \infty)$, which we describe at this point. For each $p \geq 0$ and each $\mu \in \{-, +\}^p$, let C_μ^3 denote the convex hull of the p^{th} stage component $S_\mu^1 \times D^2$ **after** it has been unraveled, i.e., in any level $\mathbb{R}^3 \times t$ for $1 - \eta/(p+1) \leq t \leq 1$. Let N_p^4 denote the union of $\cup\{C_\mu^3 \mid |\mu| = p\} \times [1 - \eta/(p+1), 1 + \eta/(p+1)]$ together with the unraveling images of $\cup\{S_\mu^1 \times D^2 \mid |\mu| = p\}$ in $\mathbb{R}^3 \times [0, 1 - \eta/(p+1)]$. Then each N_p^4 is homeomorphic to $B^2 \times D^2$, with $N_p^4 \cap \mathbb{R}^3 \times 0$ corresponding to $\partial B^2 \times D^2$, and furthermore the above described decomposition of $\mathbb{R}^3 \times [0, \infty)$ has as its nontrivial elements the components of $(\cap_{p=0}^\infty N_p^4) \cap \mathbb{R}^3 \times t$, for t varying from 0 to 1.

It turns out that this decomposition of $\mathbb{R}^3 \times [0, \infty)$ is shrinkable *in a level-preserving manner*. This calls for a mild extension of Bing’s original shrinking argument.

As Bing showed, the key to shrinking his decomposition is to regard $S^1 \times D^2$ as being long and thin, as drawn in Figure II A-2, and to show that if one cuts $S^1 \times D^2$ into any number of chambers by means of transverse 2-planes in \mathbb{R}^3 , then the decomposition elements can be isotoped in $S^1 \times D^2$ so that when done each lies inside a single chamber. To save words, we make a definition for this. Suppose P_1^2, \dots, P_q^2 are q parallel 2-planes in \mathbb{R}^3 , transverse to the “long” axis of $S^1 \times D^2$ as shown in Figure II A-2, such the two “bends” of $S^1 \times D^2$ lie to the outer sides of the endmost planes P_1 and P_q . These planes cut \mathbb{R}^3 into $q+1$ *chambers* (and they cut $S^1 \times D^2$ into $2q$ chambers). We will say that the p^{th} stage of the Bing decomposition is *essentially q -chamberable* if, for any $\delta > 0$, there is an ambient isotopy of \mathbb{R}^3 , fixed outside of $S^1 \times D^2$, such that the image of each of the 2^p p^{th} stage solid tori under the final homeomorphism lies in the δ -neighborhood of one of these chambers. Generalizing this in a natural manner, we say that the p^{th} stage of the developed Bing decomposition of $\mathbb{R}^3 \times [0, \infty)$ (as described above) is *essentially q -chamberable* if, for any $\delta > 0$, there is a level-preserving ambient isotopy of $\mathbb{R}^3 \times [0, \infty)$, fixed outside of

$$N_0^4 = (S^1 \times D^2 \times [0, 1 - \eta]) \cup (C^3 \times [1 - \eta, 1 + \eta]),$$

where $C^3 \approx B^3$ is the convex hull of $S^1 \times D^2$ in \mathbb{R}^3 , such that the image of each of the 2^p components of the p^{th} stage neighborhood N_p^4 under the final homeomorphism lies in the δ -neighborhood of one of the $q+1$ chambers of $\mathbb{R}^3 \times [0, \infty)$ determined by the 3-planes $P_i^2 \times [0, \infty)$, $1 \leq i \leq q$.

Bing proved that for any $q \geq 0$, the q^{th} stage of his decomposition is essentially q -chamberable. The following proposition is a simple extension of this.

Proposition 1. *For any $q \geq 0$, the q^{th} stage of the developed Bing decomposition of $\mathbb{R}^3 \times [0, \infty)$ is essentially q -chamberable.*

Proof of Proposition 1. By induction on q . See Figure IIA-3. (also, Bing’s pictures in [Bi1] are helpful here). Let the 2-planes P_1^2, \dots, P_q^2 be given. The first step is to apply the induction hypothesis separately inside of the two components N_-^4 and N_+^4 of N_1^4 , to reposition in them the components of the q^{th} stage N_q^4 which lie there, as follows. For N_-^4 , using the initial $q-1$ 2-planes P_1^2, \dots, P_{q-1}^2 , the induction hypothesis provides a level-preserving isotopy of $\mathbb{R}^3 \times [0, \infty)$ supported in N_-^4 such that for each of the 2^{q-1} components of N_q^4 lying in N_-^4 , its image under

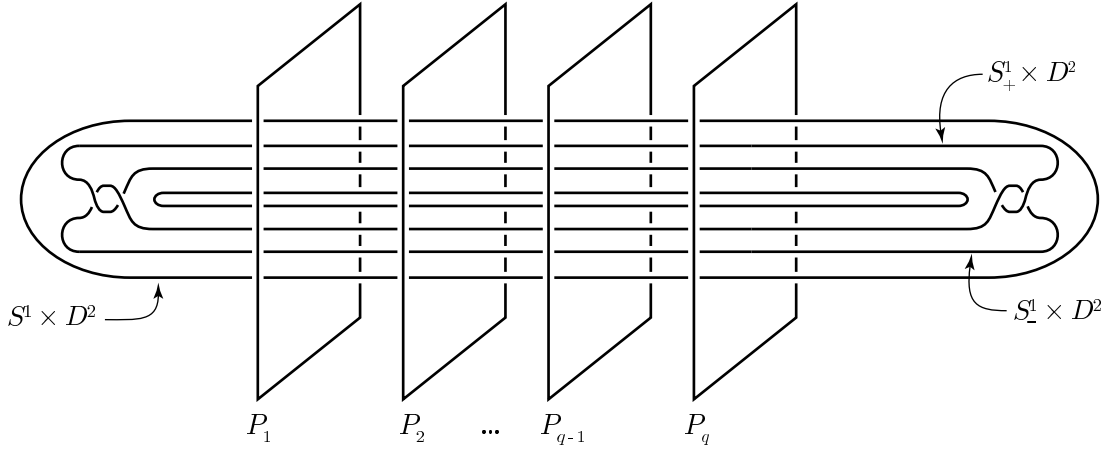

the final homeomorphism lies in the δ -neighborhood (δ arbitrarily small) of one of the q chambers of $\mathbb{R}^3 \times [0, \infty)$ determined by $P_1^2 \times [0, \infty), \dots, P_{q-1}^2 \times [0, \infty)$. For N_+^4 , one finds a similar isotopy, **using instead** the final $q-1$ q -planes P_2^2, \dots, P_q^2 . Let these isotopies be applied to $\mathbb{R}^3 \times [0, \infty)$.

The Proposition is completed by isotoping $N_-^4 \cup N_+^4$ in N_0^4 in a certain careful manner, as shown in Figure IIA-3.

It is best to describe this level-preserving isotopy in three pieces. Below the $(1-\eta)$ -level, one does in each t -level the classic Bing move, whose motion here takes place only in the two outermost chambers (i.e. the two chambers whose frontiers are $P_1^2 \times [0, \infty)$ and $P_q^2 \times [0, \infty)$). In the left most chamber one pulls the loop of N_+^4 very tight to make it poke into this chamber no more than distance δ . In the rightmost chamber one similarly pulls the loop of N_-^4 very tight. Of course, these pulling motions stretch the other two end-loops longer, but that does not matter. Above the $(1-\eta/2)$ -level, where $S_-^2 \times D^2$ and $S_+^1 \times D^2$ are in their unraveled positions, the motion again takes place only in the two outermost chambers, and again the same pulling-tight rule is applied, making small the left end-loop of N_+^4 and the right end-loop of N_-^4 . The nontrivial part of the isotopy is what takes place in between these two levels. This is described in Figure IIA-3, which shows the positioning of $N_-^4 \cup N_+^4$ in N_0^4 before and after the isotopy is applied. That is, the left side of Figure IIA-3 shows the original unraveling motion of $S_-^1 \times D^2 \cup S_+^1 \times D^2$ in the various levels $\mathbb{R}^3 \times t, 0 \leq t \leq 1 + \eta$, and the right side of Figure IIA-3 shows the new unraveling motion, which has been gotten by applying the level-preserving isotopy of N_0^4 to the original unraveling motion. The important thing is that between the 3-planes $P_1^2 \times [0, \infty)$ and $P_q^2 \times [0, \infty)$ this new unraveling motion *respects projection to the "long" axis* (i.e., the left-right axis, in the pictures). Hence the chambering which was already achieved inside of N_-^4 and N_+^4 , by the earlier motions which took place there is not lost. It can be verified that after applying this pictorially-described isotopy, the desired chambering has been achieved, completing the proof.

Strictly speaking, the only part of Proposition 1 that is used in Step 2 is the motion of $N_-^4 \cup N_+^4$ in N_0^4 described above. But it is useful to understand the entire Proposition, for it is a special case of what follows.

Step 2. In this step, the motions of Proposition 1 are applied to shrink the k -times-spun Bing decomposition. In a nutshell, the point is that the unfolded Bing decomposition described in Step 1 is exactly one-half of the once-spun Bing decomposition (after amalgamating arcs in the former to become half-discs in the latter), and furthermore, the k -times-spun Bing decomposition, $k \geq 2$, can be gotten by $(k - 1)$ -spinning the unfolded Bing decomposition (with its elements amalgamated). This entire step can best be understood by concentrating on the $k = 1$ and $k = 2$ cases.

To define the k -times-spun Bing decomposition of \mathbb{R}^{3+k} into points and tame $(1 + k)$ -cells, one starts with half of the original Bing decomposition, lying in $\mathbb{R}^2 \times [0, \infty)$ as shown in Figure IIA-4, with stages denoted by $B^1 \times D^2$ and $\{B_\mu^1 \times D^2 \mid \mu \in \{-, +\}^p\}$. Then one imagines \mathbb{R}^{3+k} as being obtained from $\mathbb{R}^2 \times [0, \infty)$ by spinning $\mathbb{R}^2 \times [0, \infty)$ through a k -sphere's worth of directions, keeping $\mathbb{R}^2 \times 0$ fixed. During this spinning, the arcs of the half-Bing-decomposition sweep out $(1 + k)$ -cells in \mathbb{R}^{3+k} . (Equivalently, one can define this decomposition of \mathbb{R}^{3+k} to be the restriction to the boundary $(3 + k)$ -sphere of the product decomposition of $B^1 \times D^2 \times I^{1+k}$ into $(2 + k)$ -cells. But the first model seems better suited to this proof.) The p^{th} stage defining neighborhoods of the k -times-spun Bing decomposition are the thickened $(1 + k)$ -spheres $\{S_\mu^{1+k} \times D^2 \mid \mu \in \{-, +\}^p\}$, which are the images of the cylinders $\{B_\mu^1 \times D^2 \mid \mu \in \{-, +\}^p\}$ under the spinning.

In trying to shrink this decomposition, the important coordinate is the \mathbb{R}^{1+k} coordinate in $\mathbb{R}^2 \times \mathbb{R}^{1+k} = \mathbb{R}^{3+k}$, i.e., the coordinate which is perpendicular to the fixed plane \mathbb{R}^2 . In the original Bing case, i.e. when $k = 0$, this is the long-and-thin coordinate direction. For higher k it might be thought of as the flat-and-thin coordinate direction. The point is, if one projects the k -times-spun Bing decomposition onto this \mathbb{R}^{1+k} coordinate, then each $(1 + k)$ -disc is projected homeomorphically onto a ball I^{1+k} in \mathbb{R}^{1+k} (at least if the decomposition is correctly positioned, e.g. as in Figure IIA-1, bottom frame). Also, the core $(1 + k)$ -sphere of each component $S_\mu^{1+k} \times D^2$ of any stage of the defining neighborhood sequence is flattened by this projection to be a $(1 + k)$ -disc.

Now we shift from round thinking to square thinking, in order to talk about chambers. Regarding I^{1+k} as $[-1, 1]^{1+k}$ (which explains the reason for the letter I , we can choose a set of k -planes in \mathbb{R}^{1+k} , each being perpendicular to one of the $1 + k$ coordinate axes and each passing through int I^{1+k} , so that these k -planes cut \mathbb{R}^{1+k} into *chambers*, whose intersections with I^{1+k} are small. For notational purposes, let this collection of k -planes be denoted $P^k(\vec{q})$, where the $(1 + k)$ -tuple of non-negative integers $\vec{q} = (q_1, q_2, \dots, q_{1+k})$ lists the number of k -planes perpendicular to each axis. Let $\|\vec{q}\| = \sum_{i=1}^{1+k} q_i$.

Crossing these k -planes and chambers with \mathbb{R}^2 , we get a partitioning of \mathbb{R}^{3+k} , which we will use to measure smallness with regard to the spun Bing decomposition. But there is one technical point which has to be discussed, namely how these $(2 + k)$ -planes are allowed to pass through the “bends” in the $S_\mu^{1+k} \times D^2$'s near ∂I^{1+k} (as they must do, when $k \geq 1$). The idea here is to impose as much regularity as possible. One way to say this accurately is, given the collection $P^k(\vec{q})$ of k -planes, and letting ϵ be the minimum distance from any of the k -planes to either of the two k -faces of I^{1+k} parallel to it, then the decomposition is made so taut, and the bends in the defining neighborhoods $\{S_\mu^{1+k} \times D^2\}$ are made so sharp, and so near ∂I^{1+k} , that for any of the $(1 + k)$ -choose- ℓ coordinate sub-spaces \mathbb{R}^ℓ of

\mathbb{R}^{1+k} ($1 \leq \ell \leq 1+k$), the projection $\pi : \mathbb{R}^{3+k} \rightarrow \mathbb{R}^\ell$, when restricted **over** the subset $[-1 + \epsilon/2, 1 - \epsilon/2]^\ell \subset \mathbb{R}^\ell$, is a product map on all members of the defining neighborhood sequence (i.e., any bending, or pinching, in the \mathbb{R}^ℓ coordinate direction occurs outside of $\pi^{-1}([-1 + \epsilon/2, 1 - \epsilon/2]^\ell)$). Hence this restricted part of the k -times-spun decomposition (and its defining neighborhood sequence) looks like the product of the $(k - \ell)$ -times-spun Bing decomposition (and its defining neighborhood sequence) with the cube $[-1 + \epsilon/2, 1 - \epsilon/2]^\ell$. One consequence of this regularity is that the two basic spun embeddings $\underline{x}, \underline{x}_+ : S^{1+k} \times D^2 \rightarrow S^{1+k} \times D^2$ which define the k -times-spun Bing decomposition (cf. start of Step 1) can be assumed to respect the chambering of \mathbb{R}^{3+k} by the codimension one hyperplanes $\mathbb{R}^2 \times P^k(\vec{q})$, that is, for each such chamber C , $\chi_\pm(C \cap S^{1+k} \times D^2) \subset C$. Hence the various finite compositions of χ_- and χ_+ have this property. This will be important in Proposition 2 below.

Generalizing the earlier definition, we say the p^{th} stage of the k -times-spun Bing decomposition is *essentially q -chamberable* if for any collection $P^k(\vec{q})$ of k -planes as described above, with $\|\vec{q}\| = q$, and for any $\delta > 0$, there is an ambient isotopy of \mathbb{R}^{3+k} , fixed outside of the 0^{th} stage $S^{1+k} \times D^2$, such that the image of each of the 2^p p^{th} stage components $S_\mu^{1+k} \times D^2$ under the final homeomorphism lies in the δ -neighborhood of one of the chambers of \mathbb{R}^{3+k} determined by $P^k(\vec{q})$.

Proposition 2. *For any $q \geq 0$, the q^{th} stage of the k -times-spun Bing decomposition of \mathbb{R}^{3+k} is essentially q -chamberable.*

Proof of Proposition 2. By induction on q . Let q_i be any nonzero component of $\vec{q} = (q_1, \dots, q_{1+k})$. We want to regard the k -times-spun Bing decomposition as being gotten by $(k - 1)$ -spinning the unfolded Bing decomposition. This $(k - 1)$ -spinning is to be done in $\mathbb{R}^{3+k} = \mathbb{R}^2 \times \mathbb{R}^{1+k}$, by taking the base $\mathbb{R}^3 \times 0$ of $\mathbb{R}^3 \times [0, \infty)$ and identifying it with $\mathbb{R}^2 \times \mathbb{R}^1(e_i)$, where e_i is the i^{th} coordinate direction in \mathbb{R}^{1+k} (i as in q_i , above), and then by spinning $\mathbb{R}^3 \times [0, \infty)$ through the $(k - 1)$ -sphere's worth of directions in $\mathbb{R}^k(e_1, \dots, \hat{e}_i, \dots, e_{1+k})$. The important thing is: this spinning can be done so that

- a) the $(k-1)$ -spin of the defining neighborhood sequence of the unfolded Bing decomposition (i.e., the N_p^4 's in Step 1) is corresponded to the defining neighborhood sequence of the k -times-spun Bing decomposition (i.e., to the unions $\cup \{S_\mu^{1+k} \times D^2 \mid \mu \in \{-, +\}^p\}$, for each $p \geq 0$; hence in particular the decompositions will coincide);
- b) the q_i $(2 + k)$ -planes of $\mathbb{R}^2 \times P^k(\vec{q})$ which are perpendicular to $\mathbb{R}^1(e_i)$ become perpendicular to the $(-\infty, \infty)$ -coordinate of $\mathbb{R}^3 = \mathbb{R}^2 \times (-\infty, \infty)$ in the $(k - 1)$ -spin structure, and
- c) the remaining $q - q_i$ $(2 + k)$ -planes of $\mathbb{R}^2 \times P^k(\vec{q})$ become parallel to the \mathbb{R}^3 coordinate in the $(k - 1)$ -spin structure.

Granted this, then Proposition 2 follows using the argument from Proposition 1, as we now explain.

First, one applies the induction hypothesis of Proposition 2 separately to the two first stage components $S_-^{1+k} \times D^2$ and $S_+^{1+k} \times D^2$. For notation here, let $P_{i,1}^k$ and P_{i,q_i}^k denote the first and the last (i.e. the extremes) among the subcollection P_i^k of q_i k -planes in $P^k(\vec{q})$ which are perpendicular to $\mathbb{R}^1(e_i)$ (if $q_i = 1$, then these two k -planes coincide). Let $P_- = P^k(\vec{q}) - \{P_{i,q_i}^k\}$ and $P_+ = P^k(\vec{q}) - \{P_{i,1}^k\}$. Then applying the induction hypothesis to those of the q^{th} stage components $\{S_u^{1+k} \mid u \in \{-, +\}^q\}$

which lie inside of $S_-^{1+k} \times D^2$, using the collection P_- of $q-1$ k -planes, one obtains an isotopy of $S_-^{1+k} \times D^2$ *rel* ∂ such that the image of each of these components under the final homeomorphism lies in the δ -neighborhood (δ arbitrarily small) of one of the chambers of \mathbb{R}^{3+k} determined by P_- . Similarly, one obtains an isotopy of $S_+^{1+k} \times D^2$ *rel* ∂ such that the image of each of the remaining q^{th} stage components under the final homeomorphism lies in the δ -neighborhood of one of the chambers of \mathbb{R}^{3+k} determined by P_+ . After applying these two isotopies in \mathbb{R}^{3+k} , one completes the motion of Proposition 2 by applying the corresponding next motion of Proposition 1, spun $k-1$ times in the structure described above to become a motion of \mathbb{R}^{3+k} . The q_i 2-planes that are used for the motion of Proposition 1 are the intersections with $\mathbb{R}^2 \times \mathbb{R}^1(e_i)$ of the q_i perpendicular planes in the collection $\mathbb{R}^2 \times P_i^k$. The fact that the motion from Proposition 1 was level-preserving, combined with (c) above, ensures that the δ -control imposed by the initial isotopies supported in $S_-^{1+k} \times D^2 \cup S_+^{1+k} \times D^2$ is not diminished at all. Using the same analysis as in Proposition 1, this proof is seen to be completed. \square

The Interlude

In the (seemingly long) period between my proofs of Theorem 2 (basically January 1975) and the nearly definitive Triple Suspension Theorem (Part IV; October 1976), a certain fact became known, which seemed to make it more likely that the Multiple Suspension Conjecture was true. For historical interest, it seems worth recalling,

OBSERVATION. *Suppose H_1^3, H_2^3 are homology 3-spheres. Fix $k \geq 2$. Then $\Sigma^k(H_1^3 \# H_2^3) \approx S^{k+3} \Leftrightarrow \Sigma^k H_i \approx S^{k+3}$ for $i = 1, 2$.*

If the Multiple Suspension Conjecture were to be false, it seemed natural that it would fail precisely for Rokhlin invariant 1 homology 3-spheres, because of the significant relation they were known to have with regard to PL versus non- PL triangulations of manifolds (cf. Prologue). But a consequence of the above observation is the

COROLLARY. *The following conjecture is false: $\Sigma^k H^3 \approx S^{k+3} \Leftrightarrow \mu(H^3) = 0$, where μ is the Rokhlin invariant in $Z/2$.*

The corollary follows because μ is additive under connected sum.

The implication \Leftarrow of the Observation is implicit in [G12, proof of Prop 4], [G13, Step 5], and is explicitly noted in [ES]. The implication \Rightarrow (which I realized in February 1975, and others did independently around then is a consequence of Štanko's Approximation Theorem in the codimension one setting ([Št3]; its fault (see [AC]) is immaterial here). It says that, granted $\mathring{c}(H_1^3 \# H_2^3) \times \mathbb{R}^{k-1}$ is a manifold, then the natural closed subset $\mathring{c}(H_i^3 - \text{int } B^3) \times \mathbb{R}^{k-1}$ ($i = 1$ or 2) can be re-embedded to have 1-LC complement, hence (by [Da2] or [Ce]) be collared, hence $\mathring{c}H_i^3 \times \mathbb{R}^{k-1}$ is a manifold.

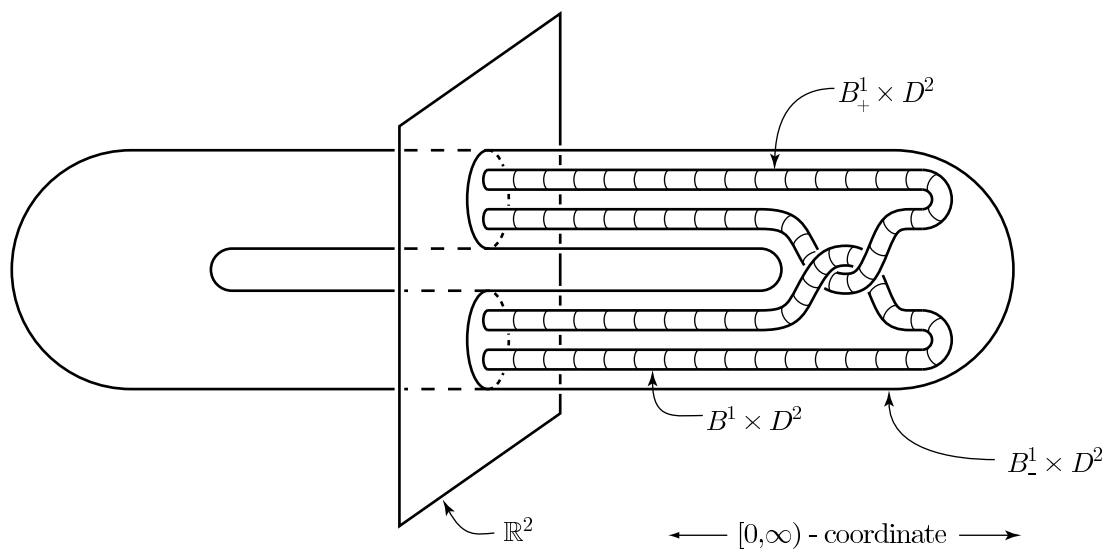

FIGURE IIA-3. Half of the original Bing decomposition of \mathbb{R}^3 .

Part III

The double suspension of any
homology 3–sphere is the image of
 S^5 under a cell-like map

When working on the double suspension question for an arbitrary homology 3-sphere H^3 , it is natural first to ask whether it can be reduced to a cell-like decomposition space problem, i.e., whether $\Sigma^2 H^3$ is the cell-like image of some manifold. The aim of this section is to prove that this is so.

THEOREM 7. *For any homology n -sphere H^n , there is a cell-like map $f : S^{n+2} \rightarrow \Sigma^2 H^n$ from the $(n+2)$ -sphere onto the double suspension of H^n .*

This was proved independently by J. Cannon in [**Can1**].

Recall that the Theorem is readily established in the cases where H^n is known to bound a contractible $(n+1)$ -manifold, hence whenever $n \geq 4$ (see the remark following the Proposition, Part II). So the new content of the theorem is the $n = 3$ case (but the proof works for any n).

The construction which follows is the second I formulated (in February 1976); the first (September 1975) is sketched at the end of this part. This second construction has the advantage that the prerequisites are simpler (they being only the half-open h -cobordism theorem and the local contractibility of the homeomorphism group of a topological manifold), and also that the non-trivial point-inverses of f are easier to understand.

The following construction grew out of my attempt to understand a fundamental manifold in PL-TOP manifold theory: the compact topological manifold P^5 , homotopy-equivalent to S^1 , such that $\partial P^5 \approx H^3 \times S^1$, where H^3 is any given homology 3-sphere. The importance of such a manifold P^5 is that, when the Rokhlin invariant of H^3 is nonzero, then P^5 provides a counterexample to the PL triangulation conjecture for topological manifolds (cf. Prologue, Section I). (The goal of the double suspension problem is to show that P^5 is in fact $cH^3 \times S^2$. The goal of the Theorem above amounts to constructing a cell-like map p from P^5 onto $cH^3 \times S^1$ such that p is a homeomorphism on ∂P^5 . The above-implied uniqueness of P^5 is a consequence of the 6-dimensional topological s-cobordism theorem applied to a cobordism constructed to join rel ∂ two candidates P_0 and P_1 . The cobordism, which is homeomorphic to $B^5 \times S^1$, exists because $P_0 \cup_{\partial} P_1$ is homotopically equivalent to $S^4 \times S^1$, hence is homeomorphic to $S^4 \times S^1$ (applying the topological version of [**Sha1**, Thm 1.2] [**Sha2**, Thm 1.1]; or see [**KS2**, V, App C], keeping in mind that $S^{TOP}(B^4 \times S^1) = 0$ implies the above-mentioned fact). However, the uniqueness of P^5 is not germane here.)

The existence of the manifold P^5 is a consequence of the work of Kirby-Siebenmann. In [**Si2**, Section 5] Siebenmann presented a construction which produced $P^5 \times S^1$, and P^5 itself was an implicit consequence of this and a splitting theorem (cf. [**Si2**, Remark 5.4]). This was made explicit in [**Mat1**] and [**GS1**]. In [**Sch**], Scharlemann presented a simplified construction of P^5 , which was distilled from some earlier arguments of Kirby and Siebenmann. In doing so he exhibited a structure on P^5 that was strong enough to let him make some significant assertions about topological transversality at dimension 4 (cf. Prologue, Section I). My construction below of the cell-like map $f : S^5 \rightarrow \Sigma^2 H^3$ is a direct extension of the work of Siebenmann and Scharlemann.

One can take the following point of view about P^5 . Observing that $P^5 \cup_{\partial} H^3 \times B^2$ is a homotopy 5-sphere, hence is homeomorphic to S^5 , the problem in constructing P^5 amounts to constructing an embedding of $H^3 \times B^2$ into S^5 so that the complement has the homotopy type of S^1 . (Such a construction was known for "homology type of S^1 " in place of "homotopy type of S^1 ", for it was known that any

oriented 3-manifold smoothly embeds in S^5 with product neighborhood [Hi1, Cor. 4]. Recall that the desired embedding $H^3 \times B^2 \rightarrow S^5$ above can be made smooth, if and only if the Rokhlin invariant of H^3 is zero (see Prologue, Section IV).

The construction of P^5 in [Sch] can be briefly described as follows (details are filled in below). Given a homology 3-sphere H^3 , do 1- and 2-surgeries to $H^3 \times T^2$ ($T^2 = 2$ -torus), with the attaching maps of the surgeries being confined to some tube $H^3 \times D^2$, to produce a manifold, denoted $\chi(H^3 \times T^2)$, which is homotopy-equivalent to $S^3 \times T^2$. By the local contractibility of the homeomorphism group of a manifold, some finite cover of $\chi(H^3 \times T^2)$ is homeomorphic to $S^3 \times T^2$ (see the Proposition below; the minimum information needed in this paragraph is that the universal cover $\tilde{\chi}(H^3 \times T^2)$ is homeomorphic to $S^3 \times \mathbb{R}^2$). Hence $\tilde{\chi}(H^3 \times T^2) \approx S^3 \times \mathbb{R}^2$ can be compactified in the natural way by adding a circle at infinity to produce $S^5 = S^3 \times \mathbb{R}^2 \cup S^1$. Letting $B^2 \subset \text{int}(T^2 - D^2)$ be some 2-cell, this produces the desired embedding of $H^3 \times B^2$ into S^5 .

The proof below of the Theorem amounts to showing that embedded in the above construction there is a natural cell-like map from S^5 onto $\Sigma^2 H^3$.

We proceed to the details of the proof. For convenience and completeness, the preceding part of the argument will be repeated, with full details. We continue to restrict attention to the $n = 3$ case, although the proof works for any n , without alteration.

PROOF OF THEOREM 7. Let H^3 be any homology 3-sphere. Let $G^3 = H^3 - \text{int } B^3$, where B^3 is some collared 3-cell in H^3 . Consider the homology 5-cell $G^3 \times I^2$.

From [Ke] (cf. Proposition, Part II) there is a contractible 5-manifold M^5 such that $\partial M^5 = \partial(G^3 \times I^2)$ (M^5 is in fact unique, by the 6-dimensional h -cobordism theorem *rel* ∂). Inasmuch as M^5 is the fundamental building block of this proof, it may be worthwhile pointing out how easily it can be constructed. Kervaire quickly produced M^5 by doing 1- and 2-surgeries in $\text{int}(G^3 \times I^2)$, the 1-surgeries to kill the fundamental group, and the (equal number of) 2-surgeries to make H_2 again 0. Another way of exhibiting M^5 comes from the observation that $M^5 \cup_{\partial} G^3 \times I^2$ is a homotopy 5-sphere, hence is S^5 . Thus M^5 can be regarded as the complement $S^5 - \alpha(G^3 \times I^2)$, where $\alpha : G^3 \times I^2 \rightarrow S^5$ is any (PL say) embedding. Any such α works, because $S^5 - \alpha(G^3 \times I^2)$ is not only acyclic (by duality), but is simply connected, since $\alpha(G^3 \times I^2)$ has a 2-dimensional spine. Such an embedding α is most easily produced by first embedding a 2-dimensional spine of G^3 into S^5 , and then taking a regular neighborhood of the image. That this neighborhood is homeomorphic to $G^3 \times I^2$ can be verified by comparing the 0,1 and 2-handle structure of the regular neighborhood to that of $G^3 \times I^2$. (Note that the embedding α is in fact unique, by the above mentioned uniqueness of M *rel* ∂).

Returning to the proof of the Theorem, one has the natural map $I^2 \rightarrow T^2$ which identifies the opposite sides of the square I^2 to produce the 2-torus T^2 . Doing these identifications to each 1-dimensional square $g \times \partial I^2$ in $G^3 \times \partial I^2 \subset M^5$, one produces from M^5 a manifold-with-boundary N^5 , with $\partial N^5 \approx \partial B^3 \times T^2$, and a map $\phi : N^5 \rightarrow B^3 \times T^2$ which is a homeomorphism on the boundary, and is a homotopy equivalence *rel* ∂ . Now comes the basic

Proposition (Kirby-Siebenmann). *Some finite cover $\hat{\phi} : \hat{N}^5 \rightarrow B^3 \times \hat{T}^2 \approx B^3 \times T^2$ is homotopic *rel* ∂ to a homeomorphism.*

Actually, it follows from the work of Kirby-Siebenmann that ϕ itself is homotopic *rel* ∂ to a homeomorphism [KS2, V, Thm. C.2] [HW], but that is unnecessarily strong for the purposes at hand.

Proof of Proposition (From [Si2, Lemma 4.1]). Regard N^5 as a 5-dimensional h-cobordism-with-boundary from $N_0^4 \equiv B^2 \times 0 \times T^2$ to $N_1^4 \equiv B^2 \times 1 \times T^2$, the product-boundary being $\partial B^2 \times [0, 1] \times T^2 = \partial N_0 \times [0, 1] = \partial N_1 \times [0, 1]$, where we are regarding B^3 as $B^2 \times [0, 1]$. For notational convenience below, assume without loss that $\phi^{-1}(\partial B^3 \times T^2) = \partial N^5$. By the half-open 5-dimensional h-cobordism theorem ([Co]; recall that it uses only engulfing), the restricted map $\phi| : N^5 - N_1^4 \rightarrow B^2 \times [0, 1] \times T^2$ is homotopic *rel* ∂ to a homeomorphism, say $\phi_0 : N^5 - N_1^4 \xrightarrow{\approx} B^2 \times [0, 1] \times T^2$, and similarly the restricted map $\phi| : N^5 - N_0^4 \rightarrow B^2 \times (0, 1] \times T^2$ is homotopic *rel* ∂ to a homeomorphism $\phi_1 : N^5 - N_0^4 \xrightarrow{\approx} B^2 \times (0, 1] \times T^2$. The goal now is to make ϕ_0 agree with ϕ_1 over say $B^2 \times [\frac{1}{2}, 1] \times T^2$, by using meshing (à la Cernavskii) and taking finite covers and then applying local contractibility of the homeomorphism group of a manifold. Amplifying this, it is an easy matter using meshing in the radial direction of B^2 , and also in the $(0, 1)$ -coordinate, to arrange that $\phi_1 \phi_0^{-1}|_{B^2 \times (0, 1) \times T^2}$ respects the $B^2 \times (0, 1)$ coordinate to an arbitrarily fine degree. Now, let $\widehat{\phi}_0, \widehat{\phi}_1$ be large finite covers of ϕ_0, ϕ_1 so that the homeomorphism $\widehat{\phi}_1 \widehat{\phi}_0^{-1} : B^2 \times (0, 1) \times T^2 \rightarrow B^2 \times (0, 1) \times T^2$ arbitrarily closely respects the T^2 coordinate, in addition to the $B^2 \times (0, 1)$ coordinate. That is, $\widehat{\phi}_1 \widehat{\phi}_0^{-1}$ is arbitrarily close to the identity. By local contractibility, there is a homeomorphism $\rho : B^2 \times [0, 1] \times T^2 \rightarrow B^2 \times [0, 1] \times T^2$ such that $\rho = \text{identity}$ on $B^2 \times [0, \frac{1}{4}] \times T^2 \cup \partial B^2 \times [0, 1] \times T^2$ and $\rho = \widehat{\phi}_1 \widehat{\phi}_0^{-1}$ over $\phi B^2 \times [\frac{1}{2}, 1] \times T^2$. Replacing $\widehat{\phi}_0$ by $\rho \widehat{\phi}_0$, one sees that the homeomorphisms $\rho \widehat{\phi}_0$ and $\widehat{\phi}_1$ agree over $B^2 \times [\frac{1}{2}, 1] \times T^2$, and so together they define the desired homeomorphism of \widehat{N}^5 to $B^2 \times [0, 1] \times T^2$.

Let $\psi : \widehat{N}^5 \rightarrow B^3 \times T^2$ be the homeomorphism of finite covers promised by the Proposition. Let $\widetilde{\psi} : \widetilde{N}^5 \rightarrow B^3 \times \mathbb{R}^2$ be an induced homeomorphism of universal covers. Let $\gamma : \mathbb{R}^2 \rightarrow \text{int } D^2$ be a radial homeomorphism, say $\gamma(x) = x/(1 + \|x\|)$, where D^2 denotes the unit disc in \mathbb{R}^2 (the letter D^2 is used here, rather than B^2 , for notational distinction and clarity. Henceforth one should think of the B^2 's and B^3 's as coming from the first coordinate of $B^3 \times \mathbb{R}^2$, and D^2 as coming from the second coordinate.) Identifying B^5 with the joint $B^3 * S^1$, so that $B^5 - S^1 = B^3 * S^1 - S^1 = B^3 \times \mathring{c}S^1 = B^3 \times \text{int } D^2$, where $S^1 = \partial D^2$ and $\mathring{c}S^1$ denotes the open cone on S^1 , then the embedding $id_{B^3} \times \gamma : B^3 \times \mathbb{R}^2 \rightarrow B^3 \times \text{int } D^2 \hookrightarrow B^3 * S^1 = B^5$ establishes a compactification of $B^3 \times \mathbb{R}^2$ by a circle to a space homeomorphic to B^5 . Preceding this embedding with the homeomorphism $\widetilde{\psi} : \widetilde{N}^5 \rightarrow B^3 \times \mathbb{R}^2$ establishes such a compactification of \widetilde{N}^5 ; this will be denoted $\widetilde{N}^5 \cup S^1 \approx B^5$.

At this point one has produced the manifold P^5 which disproves the *PL* triangulation conjecture for topological manifolds (cf. earlier remarks, fifth paragraph before Proposition.)

The task now is to construct a cell-like surjection $f_0 : \widetilde{N}^5 \cup S^1 \rightarrow G^3 * S^1 (\approx \Sigma^2 G^3)$ such that f_0 carries $\partial \widetilde{N}^5 \cup S^1 (\approx S^4)$ homeomorphically onto $\partial G^3 * S^1 (= S^2 * S^1)$. Thus each point-inverse of f_0 will intersect $\partial \widetilde{N}^5 \cup S^1$ in at most a single point. Given such a cell-like map f_0 , one produces the desired cell-like map $f : S^5 \rightarrow H^3 * S^1 (\approx \Sigma^2 H^3)$ simply by gluing 5-balls onto the source and target of f_0 ,

and extending f_0 over these 5-balls by coning. In symbols,

$$f : S^5 \approx \tilde{N}^5 \cup S^1 \cup_{\partial} B^5 \xrightarrow{f_0 \cup \text{homeo.}} G^3 * S^1 \cup_{\partial} B^3 * S^1 = (G^3 \cup_{\partial} B^3) * S^1 = H^3 * S^1.$$

To construct f_0 , we analyze in more detail the structure of the universal cover \tilde{N}^5 of N^5 and its compactification $\tilde{N}^5 \cup S^1$. For each $(i, j) \in \mathbb{Z} \oplus \mathbb{Z}$, let $I^2(i, j)$ be the square $[i - \frac{1}{4}, i + \frac{1}{4}] \times [j - \frac{1}{4}, j + \frac{1}{4}]$ in \mathbb{R}^2 ; it is centered at the point (i, j) and has side-length $\frac{1}{2}$. Let $G_1^3 = G^3 - \partial G^3 \times [0, 1] \subset \text{int } G^3$, where $\partial G^3 \times [0, 2)$ is some boundary collar for ∂G^3 in G^3 . In $G^3 \times \mathbb{R}^2$, take each 5-dimensional block $G_1^3 \times I^2(i, j)$, for each pair (i, j) **except** $(0, 0)$, and replace it, fixing boundary, with a copy of the contractible manifold M^5 , which will be denoted $M^5(i, j)$. It turns out that this produces \tilde{N}^5 . The reasoning here is in two steps. First, it is clear that \tilde{N}^5 can be identified with the space gotten from $G^3 \times \mathbb{R}^2$ by replacing **all** of the blocks $G_1^3 \times I^2(i, j)$ with copies of M^5 . Second, leaving $G_1^3 \times I^2(0, 0)$ unreplaced (the reason for which will become clear) does not affect the homeomorphism type of the resultant union, because for example the space

$$F^5 \equiv \left(G^3 \times \left[-\frac{1}{2}, \frac{1}{2} \right] \times \left[-\frac{1}{2}, \infty \right) - \cup_{j=1}^{\infty} G_1^3 \times I^2(0, j) \right) \cup \bigcup_{j=1}^{\infty} M^5(0, j)$$

is homeomorphic fixing boundary to the space $(F^5 - G_1^3 \times I^2(0, 0)) \cup M^5(0, 0)$, by a simple sliding motion in the $[-\frac{1}{2}, \infty)$ -coordinate direction which takes each $M(0, j)$ onto $M(0, j - 1)$, for $j \geq 1$.

We now construct a simple but important cell-like surjection $\rho : D^2 \rightarrow D^2$ (see Figure III-2). This map ρ will be the identity on ∂D^2 , and the nontrivial point-inverses of ρ will comprise a countable null collection of 2-discs, each intersecting ∂D^2 in a single point (*null* means that for any $\epsilon > 0$, there are only finitely many members of the collection having diameter $\geq \epsilon$). For each relatively prime pair $(p, q) \in \mathbb{Z} \oplus \mathbb{Z} - (0, 0)$ (i.e. $\gcd\{p, q\} = 1$, so this includes all pairs where p or q is ± 1), let $I_*(p, q) = \bigcup_{\ell \geq 1} I(\ell p, \ell q)$, which is a union of squares in \mathbb{R}^2 converging to infinity in the direction θ , where $\cos \theta = p/\|(p, q)\|$ and $\sin \theta = q/\|(p, q)\|$. For each (p, q) , we wish to join together the components of $I_*(p, q)$ by using bands to connect adjacent squares in the sequence, so that the resultant union, to be denoted $I_{\#}(p, q)$, is contractible (See Figure III-1; this operation is amplified in the next paragraph). In fact, $I_{\#}(p, q)$ will be homeomorphic to a 2-disc minus a boundary point. This connecting operation is to be done so that if one defines $D(p, q) = \gamma(I_{\#}(p, q)) \cup (p, q)/\|(p, q)\| \subset D^2$, where $\gamma : \mathbb{R}^2 \xrightarrow{\sim} \text{int } D^2$ is as above and the point $(p, q)/\|(p, q)\|$ lies on ∂D^2 , then the collection $\{D(p, q)\}$ is a disjoint null collection of 2-discs in D^2 , each intersecting ∂D^2 in a single point. Given the collection $\{D(p, q)\}$, then ρ can be taken to be any map $\rho : D^2 \rightarrow D^2$, fixed on ∂D^2 , such that the nontrivial point-inverses of ρ are precisely the sets $\{D(p, q)\}$.

One way to do the above connecting operation with precision is, given $I_*(p, q)$, to adjoin to it the straight ray $\mathbb{R}^1(p, q) (\approx [0, \infty))$ which starts at the point (p, q) and passes through all of the points $(\ell p, \ell q)$, $\ell \geq 1$. These rays $\{\mathbb{R}(p, q)\}$ are all disjoint, but a given $\mathbb{R}(p, q)$ may unfortunately pass through other $I(p', q')$'s. To get the desired disjointness here, one can argue as follows. Let $\pi : \mathbb{R}^2 \rightarrow \mathbb{R}^2$ be a map, bounded close to $id_{\mathbb{R}^2}$ (say by making it the identity on the grid $(\mathbb{Z} + \frac{1}{2}) \times \mathbb{R}^1 \cup \mathbb{R}^1 \times (\mathbb{Z} + \frac{1}{2}) \subset \mathbb{R}^2$), such that the only nontrivial point-inverses of π are the sets $\pi^{-1}((i, j)) = I^2(i, j)$, $(i, j) \in \mathbb{Z} \oplus \mathbb{Z} - (0, 0)$, and such that for each

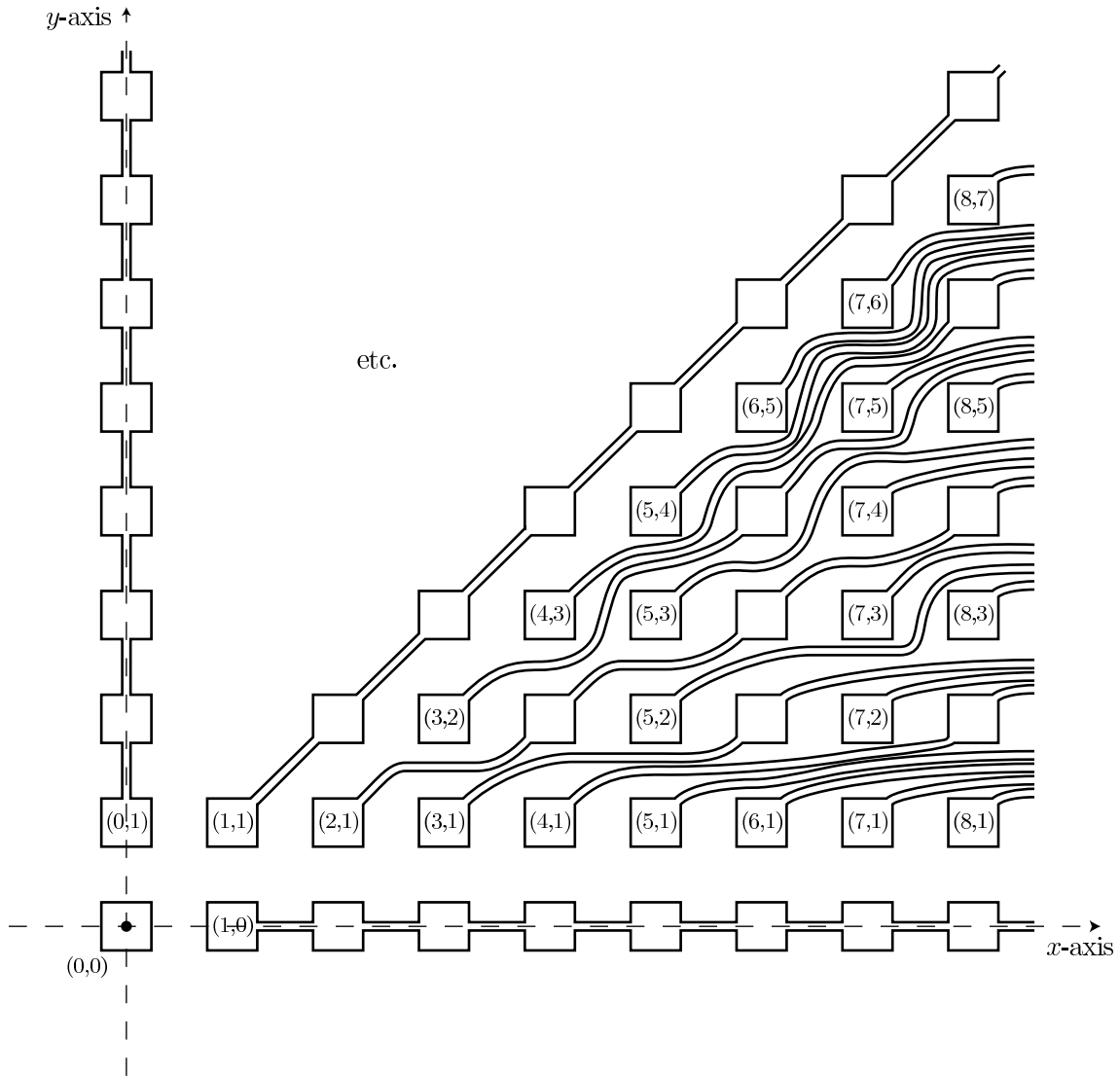

FIGURE III-1. Connecting the squares of $I_*(p, q)$ to make $I_\#(p, q)$, in \mathbb{R}^2 . Each labeled pair (p, q) is relatively prime.

relatively prime pair (p, q) , π leaves invariant (not fixed) the set $\mathbb{R}(p, q) \cap \bigcup_{\ell \geq 1} [\ell p - \frac{1}{2}, \ell p + \frac{1}{2}] \times [\ell q - \frac{1}{2}, \ell q + \frac{1}{2}]$. Then each preimage set $\pi^{-1}(\mathbb{R}(p, q))$ looks like $I_*(p, q)$ with its components joined together by arcs. So one can take as $I_\#(p, q)$ a small thickening of $\pi^{-1}(\mathbb{R}(p, q))$.

Given ρ as described above, let $\rho_t : D^2 \rightarrow D^2, 0 \leq t \leq 1$, be a pseudoisotopy of $\rho_0 = \text{identity}$ to $\rho_1 = \rho$ (pseudoisotopy means here that each $\rho_t, t < 1$, is a homeomorphism).

In order to define the desired cell-like map $f_0 : \tilde{N} \cup S^1 \rightarrow G^3 * S^1$, we first define a certain cell-like map $g_0 : G^3 * S^1 \rightarrow G^3 * S^1$. For each $x \in G^3$, define

The 2-cell D^2

FIGURE III-2. The nontrivial point-inverses of the cell-like surjection $\rho = D^2 \rightarrow D^2$. Each nontrivial point-inverse is homeomorphic to a 2-cell, and intersects ∂D^2 in a single point.

$g_0|x * S^1$ to be the map $\rho_{t(x)} : x * S^1 \rightarrow x * S^1$, where $x * S^1$ is being identified with $D^2 = 0 * S^1$ in the obvious manner, and where $t(x) \in [0, 1]$ is defined using the previously chosen collar $\partial G^3 \times [0, 2)$, by

$$t(x) = \begin{cases} t & \text{if } x \in \partial G^3 \times t, \ t \in [0, 1), \text{ or} \\ 1 & \text{if } x \in G^3 - \partial G^3 \times [0, 1) = G_1^3. \end{cases}$$

Thus $g_0|\partial G^3 * S^1 = \text{identity}$, and the nontrivial point-inverses of g_0 comprise a countable null collection of cell-like subsets of $G^3 * S^1$, each intersecting S^1 in a

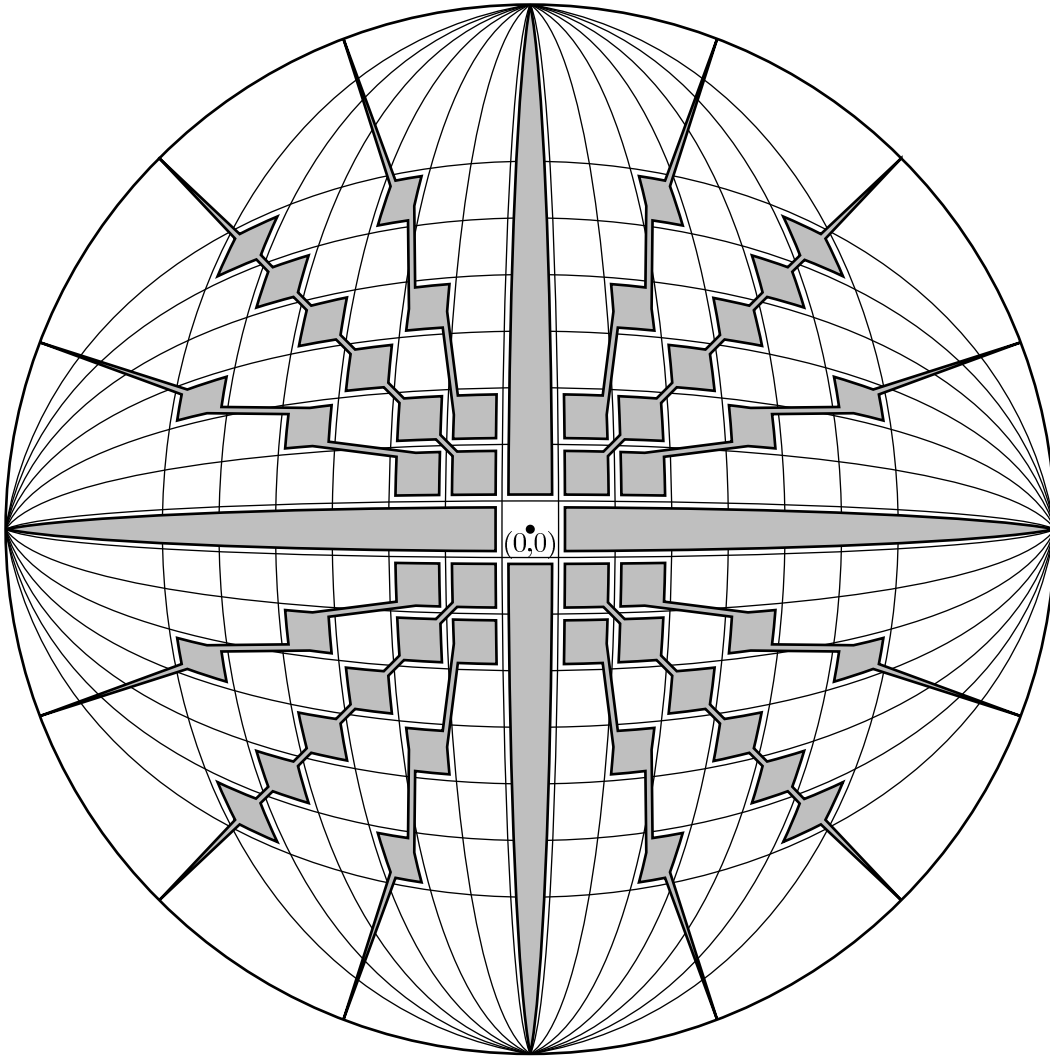
single point. This is because the nontrivial point-inverses of g_0 are the sets

$$G_1^3 \times \gamma(I_{\#}^2(p, q)) \cup (p, q) / \|(p, q)\| \subset G^3 \times \text{int } D^2 \cup S^1 = G^3 * S^1,$$

where (p, q) ranges over all relatively prime pairs in $\mathbb{Z} \oplus \mathbb{Z} - (0, 0)$, and each of these set is homeomorphic to $c(G_1^3 \times I)$.

Now, according to the discussion earlier, we can regard $\tilde{N}^5 \cup S^1$ as being obtained from $G^3 * S^1$ by removing each block $G_1^3 \times \gamma(I^2(i, j))$, $(i, j) \in \mathbb{Z} \oplus \mathbb{Z} - (0, 0)$, and replacing it with a copy $M(i, j)$ of M^5 . Since g_0 sends each block $G_1^3 \times \gamma(I^2(i, j))$ to a single point in $S^1 \subset G^3 * S^1$, then g_0 gives rise to a well-defined map **after** these replacement operations are done in the **source** of g_0 . This new map is the desired $f_0 : \tilde{N}^5 \cup S^1 \rightarrow G^3 * S^1$.

If this definition is to be made more formally, let $\chi : G^3 * S^1 \rightarrow \tilde{N}^5 \cup S^1$ be a map which restricts on each block $G_1^3 \times \gamma(I^2(i, j))$ to a degree 1 identity-on-boundary map onto $M(i, j)$, and which is the identity elsewhere, and then note that $g_0 \chi^{-1}$ well-defines the desired map f_0 .

The nontrivial point-inverses of f_0 are each homeomorphic to the one-point-compactification $F^5 \cup \infty$ of

$$F^5 \equiv (G_1^3 \times [-\frac{1}{2}, \frac{1}{2}] \times [\frac{1}{2}, \infty) - \cup_{j=1}^{\infty} G_1^3 \times I^2(0, j)) \cup \bigcup_{j=1}^{\infty} M^5(0, j).$$

The compactum $F^5 \cup \infty$ is cell-like because it is contractible, which in turn follows from the fact that the space consisting of two copies of M^5 glued together along $G^3 \times I \subset \partial M^5$, strongly deformation retracts to either single copy of M^5 , since each space is contractible (this fact is to be contrasted to the fact that M^5 itself does not strongly deformation retract to $G^3 \times I$).

This completes the construction of f_0 and hence f . It turns out, then, that f has a countable null collection of nontrivial point-inverses, each a contractible ANR. One can seek to improve the point-inverses of f , for example by taking spines to lower their dimension, keeping in mind that the ultimate goal is to make f a homeomorphism. That leads to the work in Part IV. \square

The following paragraphs describe the original proof I formulated that the double suspension conjecture for any homology 3-sphere is reducible to a cell-like decomposition problem for S^5 . It rests on some clever 4-dimensional analysis of A. Casson. I found this proof useful only psychologically, because I was never able to make the decomposition of S^5 nice enough so that I could work with it. Interestingly, one message of Cannon's work in [Can2] is that given such a decomposition as I produced (or he, in [Can2]), it can always be changed into a standard decomposition which one can work with. This proof is presented here in part to advertise Cannon's unpublished work, which focuses attention on some interesting questions in 4-dimensional topology.

ORIGINAL PROOF OF THEOREM 7 . Suppose, then, that H^3 is any homology 3-sphere. It was pointed out in the Interlude following Part II how the implication $\Sigma^2(H^3 \# H^3) \approx S^5 \Rightarrow \Sigma^2 H^3 \approx S^5$ followed from a certain splitting construction. Hence it suffices here to work with a homology 3-sphere of Rokhlin invariant 0, namely $H^3 \# H^3$, instead of an arbitrary H^3 . The following argument shows:

Given a homology 3-sphere H^3 of Rokhlin invariant 0, there is a cell-like map $p : P^5 \rightarrow cH^3 \times S^1$ from some 5-manifold-with-boundary P^5 onto $cH^3 \times S^1$ such that the only nontrivial point-inverses of p lie in $p^{-1}(c \times S^1) \subset \text{int } P^5$.

(Recall that if one wishes to produce from p a cell-like map from S^5 onto $\Sigma^2 H^3$, one merely glues copies of $H^3 \times B^2$ onto the boundaries of P^5 and $cH^3 \times S^1$, and extends p over these sets via the identity.)

If H^3 has Rokhlin invariant 0, it is a standard consequence that $H^3 = \partial M^4$, where M^4 is some simply-connected parallelizable PL manifold such that $M^4 \cup c\partial M^4$ has the homotopy type of $\#_k S^2 \times S^2$, the connected sum of k copies of $S^2 \times S^2$, for some k . One would like to be able to do 4-dimensional (simply-connected) surgery to $\text{int } M^4$, to convert M^4 to a contractible 4-manifold N^4 (which could even be topological for the purposes at hand). For then one could let $P^5 = N^4 \times S^1$, and $p = n \times id_{S^1}$, where $n : N^4 \rightarrow cH^3$ is gotten by collapsing to a point a spine of N^4 . Unfortunately, such surgery is not known to be possible. But, Andrew Casson has shown that such surgery is possible to some extent, and using his work one can construct the desired manifold P^5 and map $p : P^5 \rightarrow cH^3 \times S^1$.

Casson has shown the following:³ There exist disjoint open sets U_1, \dots, U_k in $\text{int } M^4$, bounded away from ∂M^4 , such that

- (i) each U_i is proper-homotopy-equivalent to $S^2 \times S^2 - *$ ($*$ = point), in the following special manner: Each U_i is homeomorphic to $S^2 \times S^2 - C_i$, where C_i is some compact subset of $S^2 \times S^2$ which is cell-like and satisfies the cellularity criterion of McMillan [McM1] (which is that the end of $S^2 \times S^2 - C_i$ is 1-connected; from this one can show that $S^2 \times S^2 - C_i$ is proper-homotopy-equivalent to $S^2 \times S^2 - *$), and
- (ii) the homomorphism $\bigoplus_{i=1}^k H_2(U_i) \rightarrow H_2(M)$ is an intersection-form-preserving isomorphism.

As a consequence of (i) and (ii), it follows that $M^4 - \bigcup_{i=1}^k U_i$ is Čech homotopically 3-connected.

(One of Casson's fundamental questions is: *Are the ends of the U_i 's diffeomorphic (or even homeomorphic) to $S^3 \times R^1$?* If so, one can do surgery on M^4 by replacing each U_i by an open 4-cell, thereby producing the desired contractible manifold N^4 mentioned above. Although unnecessary for our purposes, it may be worth recalling what Casson's typical open set U_i looks like. Regard $S^2 \times S^2$ as consisting of a 0-handle B^4 , two 2-handles attached to a pair of linking solid tori in ∂B^4 , and a 4-handle. Let W_1, W_2 be two Whitehead continua in ∂B^4 , each the familiar intersection of a nest of solid tori, constructed in the two given solid tori in ∂B^4 ([Wh1, §4]; see also [Bi4, §11]). Thus W_1 and W_2 link geometrically in ∂B^4 . Let $C \approx \Sigma W_1 \vee \Sigma W_2$ be gotten by coning $W_1 \cup W_2$ to the origin in B^4 , and then coning W_1 and W_2 separately to the center points of the respective 2-handles in which they lie. Then $U = S^2 \times S^2 - C$ is the model open set of Casson. His general open set is gotten by replacing W_1 and W_2 above by two Whitehead-like continua which are produced by suitably ramifying the original Whitehead construction.)

Let U_i be any open 4-manifold as described in (i) above.

Proposition. $U_i \times S^1$ is homeomorphic to $(S^2 \times S^2 - *) \times S^1$, in such a manner that the S^1 coordinate is preserved at ∞ . That is, there is a homeomorphism of

³This is unpublished, although some notes from Casson's lectures, taken by C. Gordon and R. Kirby, have been in circulation since Casson's work in 1974.

pairs $h : (U_i \cup \infty, \infty) \times S^1 \xrightarrow{\cong} (S^2 \times S^2, *) \times S^1$ such that $h|_{\infty \times S^1} = \text{identity}$, where $U_i \cup \infty$ denotes the one-point compactification of U_i .

Proof of Proposition. This is a cell-like decomposition problem. Regarding U_i as the subset $S^2 \times S^2 - C_i$ of $S^2 \times S^2$, the assertion is that there is a homeomorphism $h : (S^2 \times S^2 / C_i) \times S^1 \rightarrow S^2 \times S^2 \times S^1$ such that h carries $\{C_i\} \times S^1$ onto $* \times S^1$ via the identity. To construct h , it suffices as usual to construct a map $f : S^2 \times S^2 \times S^1 \rightarrow S^2 \times S^2 \times S^1$ such that f is a homeomorphism over the complement of $* \times S^1$, and $f^{-1}(* \times t) = C_i \times t$ for each $t \in S^1$. For then one can define $h = f\pi^{-1}$, where $\pi : S^2 \times S^2 \times S^1 \rightarrow (S^2 \times S^2 / C_i) \times S^1$ is the natural quotient map. The map f is constructed by shrinking the decomposition $\{C_i \times t \mid t \in S^1\}$ of $S^2 \times S^2 \times S^1$ keeping $* \times S^1$ fixed, where without loss $* \in C_i$. This shrinking can be done using a dual skeleton engulfing argument in the manner of [EG, Thm 1].

Given the Proposition, one produces the manifold P^5 by removing from $M^4 \times S^1$ each open set $U_i \times S^1$, and sewing in its place $\text{int } B^4 \times S^1$. To do this precisely, let $\alpha : \text{int } B^4 - 0 \rightarrow S^2 \times S^2 - *$ be an embedding such that $S^2 \times S^2 - (* \cup \text{image } (\alpha))$ is compact (i.e., image (α) is a deleted neighborhood of $*$ in $S^2 \times S^2$) and such that the α -image of the ∂B^4 -end of $\text{int } B^4 - 0$ lies toward $*$. Let $\beta = \alpha \times \text{id}_{S^1} : (\text{int } B^4 - 0) \times S^1 \rightarrow (S^2 \times S^2 - *) \times S^1$. Then we can define $P^5 = M^4 \times S^1 - \bigcup_{i=1}^k (U_i \times S^1 - h_i^{-1}(\text{image } \beta)) \bigcup_{i=1}^k (\text{int } B^4 \times S^1)_i$ where, for each i , the open subset $(\text{int } B^4 - 0) \times S^1$ of the i^{th} copy of $\text{int } B^4 \times S^1$ is identified to $h_i^{-1}(\text{image } \beta)$ by the homeomorphism $h_i^{-1}\beta$.

This manifold P^5 is known to topologists, being the unique manifold which is homotopy equivalent, fixing boundary, to $cH^3 \times S^1$ (cf. introductory remarks of Part III; here however P^5 is not so interesting, because the Rokhlin invariant of H^3 is 0). What is useful about the above description of P^5 is that it provides a layering of P^5 into cell-like subsets. Namely, for each $\theta \in S^1$, let $Q_\theta = (M^4 - \bigcup_{i=1}^k (U_i \times \theta)) \cup \bigcup_{i=1}^k (\text{int } B^4 \times \theta)_i \subset P^5$ (although Q_θ is compact, it is not necessarily an ANR, because its two parts may not match up very smoothly where they come together). Let $H^3 \times [0, 1) \hookrightarrow M^4 - \bigcup_{i=1}^k U_i$ be an open boundary collar for ∂M^4 in M^4 . Define $p : P^5 \rightarrow cH^3 \times S^1$ to be the “level-preserving” map gotten by sending the collar $H^3 \times [0, 1) \times S^1$ homeomorphically onto $(cH^3 - c) \times S^1$, and by sending each compact set $Q_\theta - H^3 \times [0, 1) \times \theta$ to the point $c \times \theta, \theta \in S^1$.

Proposition. p is cell-like.

It follows from properties (i) and (ii) above, together with the construction of P^5 , that for any open interval (θ_0, θ_1) in S^1 , the manifold $p^{-1}(\theta_0, \theta_1)$ is contractible. Hence each point-inverse of p has arbitrarily small contractible neighborhoods.

This completes the description of my original map $p : P^5 \rightarrow cH^3 \times S^1$. \square

Part IV

The triple suspension of any
homology 3–sphere is S^6

The purpose of this part is to show how I proved the following

THEOREM 8 (Triple Suspension). *For any homology 3-sphere H^3 , the triple suspension $\Sigma^3 H^3$ is homeomorphic to S^6 . Recall that Cannon subsequently has improved this by showing that $\Sigma^2 H^3 \approx S^5$ [Can1].*

My proof (done in October 1976) made use of my earlier suspension work, specifically the result that $\Sigma^2 sp(H^3) \approx S^6$, where $sp(H^3)$ is the homology 4-sphere gotten by spinning H^3 (defined below). Aside from this fact, this part does not use anything from Parts I and II. However, it does use very strongly the construction of Part III.

Given a compact metric space H containing a collared n -cell B^n (in general, H will be a homology n -sphere), the k -spin of H ($k \geq 0$) is the space $sp^k H \equiv \partial((H - \text{int } B^n) \times I^{k+1})$, i.e., $sp^k H = (H - \text{int } B^n) \times \partial I^{k+1} \cup \partial B^n \times I^{k+1} \subset (H - \text{int } B^n) \times I^{k+1}$ (note that the 0-spin of H is the double of $H - \text{int } B^n$ along ∂B^n).

After proving the above theorem, I realized that the result could be interpreted as a converse to work of Glaser [G12]-[G14] in 1969-70, by casting it in the following manner.

THEOREM 9. *Given any compact metric space H containing a collared n -cell, and given any $k \geq 2$, then*

$$\Sigma^k H \approx S^{n+k} \Leftrightarrow \Sigma^2(sp^{k-2}(H)) \approx S^{n+k}.$$

The work of Glaser amounted to establishing the implication \Rightarrow (see [Si4], where this argument, extracted from Glaser's work, is presented in a single page). My work below contains a proof for the implication \Leftarrow (the $k = 2$ case is discussed in the Interlude following Part II). The real case of interest here is when $k = 3$ and H is a homology 3-sphere, in which case we know from Part II that the right hand conclusion is true. The goal of the remainder of Part IV is to prove this special case, i.e., to show that if $\Sigma^2 sp(H^3) \approx S^6$, then $\Sigma^3 H^3 \approx S^6$.

The idea of the proof is to use the hypothesis to understand better a certain cell-like map $\bar{f} : S^6 \rightarrow \Sigma^3 H^3$, which is constructed in completely analogous fashion to the cell-like map $f : S^5 \rightarrow \Sigma^2 H^3$ from Part III. Before expanding on this, we emphasize that \bar{f} is **not** the suspension of f ; that would make \bar{f} have the undesirable feature of having uncountably many nontrivial point-inverses. Instead, \bar{f} is to have a countable null sequence of nontrivial point-inverses, just as f did.

The rule for constructing \bar{f} is everywhere in Part III to increase the dimension from 5 to 6, by increasing the dimension of the second coordinate from 2 to 3. Thus, $G^3 \times I^2$ becomes $G^3 \times I^3$; M^5 becomes M^6 , which is the (unique) contractible manifold such that $\partial M^6 = \partial(G^3 \times I^3)$; and N^5 becomes N^6 , with its rel-boundary homotopy equivalence $\bar{\phi} : N^6 \rightarrow B^3 \times T^3$. (The bar symbol, e.g. $\bar{f}, \bar{\phi}, \bar{\rho}, \bar{g}_0$, is used over maps which are the one-dimension-higher analogues of maps from Part III.) The compactification $\tilde{N}^5 \cup S^1$ becomes $\tilde{N}^6 \cup S^2$, using the radial homeomorphism $\bar{\gamma}(x) = x/(1 + \|x\|) : \mathbb{R}^3 \xrightarrow{\approx} \text{int } D^3$, where D^3 is the unit ball in \mathbb{R}^3 . In the construction of the map $\bar{\rho} : D^3 \rightarrow D^3$, which is the analogue of $\rho : D^2 \rightarrow D^2$, one works in \mathbb{R}^3 instead of \mathbb{R}^2 , using the 3-dimensional cubes $I^3(i, j, k) \equiv [i - \frac{1}{4}, i + \frac{1}{4}] \times [j - \frac{1}{4}, j + \frac{1}{4}] \times [k - \frac{1}{4}, k + \frac{1}{4}]$, for $(i, j, k) \in \mathbb{Z} \oplus \mathbb{Z} \oplus \mathbb{Z} - (0, 0, 0)$. In particular, Figure III-1 becomes a 3-dimensional picture, to be compactified by adding a 2-sphere at ∞ . Each nontrivial point-inverse of $\bar{\rho}$ is a 3-cell $\bar{\gamma}(I_{\#}^3(p, q, r)) \cup (p, q, r) / \|(p, q, r)\| \subset D^3$,

where $(p, q, r) \in \mathbb{Z} \oplus \mathbb{Z} \oplus \mathbb{Z} - (0, 0, 0)$ is a relatively prime triple, i.e., a triple such that $\gcd\{p, q, r\} = 1$. These changes and adaptations are all routine, and should require only a few moments thought to absorb.

The idea of the following proof is this. Given the hypothesis that $\Sigma^2 sp(H^3)$ ($\equiv \Sigma^2 \partial(G^3 \times I^2)$) is homeomorphic to S^6 , or more germanely that $c(\partial(G^3 \times I^2)) \times \mathbb{R}^1$ is a manifold, it will be shown that then the point-inverses of $\bar{f} : S^6 \rightarrow \Sigma^3 H^3$ can be improved to be cellular arcs, which are embedded in S^6 in a certain regular manner. Then it will be shown that this decomposition of S^6 into points and arcs is shrinkable, and consequently \bar{f} is approximable by homeomorphisms.

The precise point of view that we adopt for this procedure is the following. The map $\bar{f} : S^6 \rightarrow \Sigma^3 H^3$ will be factored into two cell-like maps

$$\bar{f} = \beta\alpha : S^6 \xrightarrow{\alpha} Q^6 \xrightarrow{\beta} \Sigma^3 H^3,$$

and each of these maps will be shown to be approximable by homeomorphisms. This approximating will be trivial for α , but will require some work for β (whose nontrivial point-inverses are arcs).

A key item for the construction below is the following description of M^6 . It is inspired by Glaser's constructions in [G12]-[G14].

Define

$$M_*^6 = G^3 \times I^2 \times [0, 1] / \{G_1^3 \times I_1^2 \times t \mid \frac{1}{3} \leq t \leq \frac{2}{3}\},$$

that is, M_*^6 is the quotient space gotten from $G^3 \times I^2 \times [0, 1]$ by identifying to points each of the subsets $G_1^3 \times I_1^2 \times t$, $\frac{1}{3} \leq t \leq \frac{2}{3}$, where $G_1^3 \subset \text{int } G^3$ and $I_1^2 \subset \text{int } I^2$ denote smaller copies of G^3 and I^2 , obtained as usual by taking complements of open collars. It is in the following claim that the hypothesis of the theorem is used. (compare [G12, Prop. 1]).

Claim. M_*^6 is a contractible manifold.

Proof. M_*^6 is contractible because it is gotten by identifying to an arc the spine of a manifold. To see that M_*^6 is a manifold, one uses the hypothesis of the theorem, which amounts to assuming that $c(\partial(G^3 \times I^2)) \times \mathbb{R}^1$ is a manifold. From this one sees that M_*^6 is a manifold along the interior of the arc-spine. This leaves the two endpoints of the arc-spine to analyze. Each endpoint has a deleted neighborhood homeomorphic to $L^5 \times \mathbb{R}^1$, where $L^5 = G^3 \times I^2 \cup_{\partial} c(\partial(G^3 \times I^2))$. Since L^5 is homotopically a 5-sphere and $L^5 \times \mathbb{R}^1$ is a manifold, it follows that $L^5 \times \mathbb{R}^1$ is homeomorphic to $S^5 \times \mathbb{R}^1$ (see [Si6, App. 1]). Thus M_*^6 is a manifold, henceforth denoted M^6 .

By analogy with Part III, we regard the space $(\tilde{N}^6 \cup S^2) \cup_{\partial} B^6$ ($\approx S^6$) and the map $\bar{f} : (\tilde{N}^6 \cup S^2) \cup_{\partial} B^6 \rightarrow H^3 * S^2$ ($\approx \Sigma^3 H^3$) as being obtained by doing modifications to the source of a certain cell-like map

$$\bar{g}_0 \cup \text{homeo} : G^3 * S^2 \cup_{\partial} B^6 \rightarrow G^3 * S^2 \cup_{\partial} B^3 * S^2 = H^3 * S^2.$$

The map $\bar{g}_0 : G^3 * S^2 \rightarrow G^3 * S^2$ is defined, as earlier, by letting $\bar{g}_0|x * S^2 \rightarrow x * S^2$, for $x \in G^3$, where $\{\bar{p}_t\}$ is a pseudoisotopy of $\bar{p}_1 = \bar{p} : D^3 \rightarrow D^3$ to $\bar{p}_0 \equiv id_{D^3}$, and $D^3 = x * S^2$. The nontrivial point-inverses of \bar{g}_0 are the sets $\{G_1^3 \times \bar{\gamma}(I_{\#}^3(p, q, r)) \cup (p, q, r) / \|(p, q, r)\|\}$, where $(p, q, r) \in \mathbb{Z} \oplus \mathbb{Z} \oplus \mathbb{Z} - (0, 0, 0)$ is a relatively prime triple, as above. In order to be able to uniformly describe these nontrivial point-inverses of \bar{g}_0 , we choose for each triple (p, q, r) a neighborhood of $\bar{\gamma}(I_{\#}^3(p, q, r))$ in $\text{int } D^3$, to be uniformly denoted $I^2 \times [0, \infty)$, such that all of

these neighborhoods are disjoint, and such that the spine $I_1^2 \times [1, \infty)$ of $I^2 \times [0, \infty)$ coincides with the set $\overline{\gamma}(I_{\#}^3(p, q, r))$. From now on we will refer to the nontrivial point-inverses of \overline{g}_0 as the sets $\{G_1^3 \times I_1^2 \times [1, \infty) \cup \infty\}$, which have disjoint pinched neighborhoods $\{G^3 \times I^2 \times [0, \infty) \cup \infty\}$ in $G^3 * S^2$, and it will be understood that the indices $\{(p, q, r)\}$ are being suppressed.

Recall that the space $\tilde{N}^6 \cup S^2 (\approx B^6)$ is regarded as being obtained from $G^3 * S^2$ by replacing each of the blocks $G_1^3 \times \overline{\gamma}(I^3(i, j, k))$, $(i, j, k) \in \mathbb{Z} \oplus \mathbb{Z} \oplus \mathbb{Z} - (0, 0, 0)$, by a copy $M^6(i, j, k)$ of M^6 . Using the above explicit description of M^6 as M_*^6 , we can equivalently describe $\tilde{N}^6 \cup S^2$ as the quotient space obtained from $G^3 * S^2$ by the acyclic quotient map $\overline{\chi} : G^3 * S^2 \rightarrow \tilde{N}^6 \cup S^2$, where $\overline{\chi}$ makes the following quotient-identifications in each nontrivial point-inverse of \overline{g}_0 :

$$G^3 \times I^2 \times [0, \infty) \xrightarrow{\overline{\chi}|} G^3 \times I^2 \times I^2 \times [0, \infty) / \{G_1^3 \times I_1^2 \times t \mid \ell + \frac{1}{3} \leq t \leq \ell + \frac{2}{3}, \ell \geq 1\}$$

(cf. above convention on notation). See Figure IV-1. Here, one is thinking of the copies $M^6(i, j, k)$ of M^6 in $\tilde{N}^6 \cup S^2$ as being say the various blocks $\overline{\chi}(G^3 \times I^2 \times [\ell, \ell + 1])$, for $\ell \geq 1$ (actually, these blocks are enlarged-by-collar versions of the genuine $M^6(i, j, k)$'s, but that is not important). Using this description of $\tilde{N}^6 \cup S^2$, then the map $\overline{f}_0 : \tilde{N}^6 \cup S^2 \rightarrow G^3 * S^2$ is the map which identifies to a point each of the sets $\overline{\chi}(G_1^3 \times I_1^2 \times [1, \infty) \cup \infty)$. Note that this typical nontrivial point-inverse of \overline{f}_0 looks like an infinite sequence of (singlefold) suspensions of $G_1^3 \times I_1^2$ (except that the first ‘‘suspension’’, $G_1^3 \times I_1^2 \times [1, \frac{4}{3}] / G_1^3 \times I_1^2 \times \frac{4}{3}$, is really a cone), strung together by arcs joining adjacent members of the sequence, and then compactified by the point at ∞ . See Figure IV-1, second from the top.

There is now an apparent factoring of \overline{f}_0 into two cell-like maps,

$$\overline{f}_0 = \beta_0 \alpha_0 : \tilde{N}^6 \cup S^2 \xrightarrow{\alpha_0} Q_0^6 \xrightarrow{\beta_0} G^3 * S^2,$$

which is described by factoring into two maps each of the trivial restricted maps

$$\overline{f}_0| : \overline{\chi}(G_1^3 \times I_1^2 \times [1, \infty) \cup \infty) \rightarrow \infty \in S^2$$

(see Figure IV-1).

The first map $\alpha_0|_{\overline{\chi}(G_1^3 \times I_1^2 \times [1, \infty) \cup \infty)}$ identifies to a point each of the countably many suspension (or cone) subsets in each of the sets $\overline{\chi}(G_1^3 \times I_1^2 \times [1, \infty) \cup \infty)$, thereby producing from $\tilde{N}^6 \cup S^2$ a quotient space Q_0^6 . The second map β_0 completes the remaining identifications by identifying each set $\alpha_0(\overline{\chi}(G_1^3 \times I_1^2 \times [1, \infty) \cup \infty))$ to a point. In symbols, this becomes

$$\begin{aligned} \overline{\chi}(G_1^3 \times I_1^2 \times [1, \infty) \cup \infty) &= \\ & (G_1^3 \times I_1^2 \times [1, \infty) \cup \infty) / \{G_1^3 \times I_1^2 \times t \mid \ell + \frac{1}{3} \leq t \leq \ell + \frac{2}{3}, \ell \geq 1\} \\ & \xrightarrow{\alpha_0|} (G_1^3 \times I_1^2 \times [1, \infty) \cup \infty) / (\{G_1^3 \times I_1^2 \times t \mid \ell + \frac{1}{3} \leq t \leq \ell + \frac{2}{3}, \ell \geq 1\} \cup \\ & \quad \{G_1^3 \times I_1^2 \times [1, \frac{4}{3}]\} \cup \{G_1^3 \times I_1^2 \times [\ell + \frac{2}{3}, \ell + \frac{4}{3}] \mid \ell \geq 1\}) \\ & = [1, \infty] / \{[1, \frac{4}{3}], [\frac{5}{3}, \frac{7}{3}], [\frac{8}{3}, \frac{10}{3}], \dots\} \approx \text{arc } \xrightarrow{\beta_0|} \infty \in S^2. \end{aligned}$$

Let

$$\begin{aligned}\alpha &\equiv \alpha_0 \cup_\sigma id_{B^6} : (\tilde{N}^6 \cup S^2) \cup_\sigma B^6 (\approx S^6) \rightarrow Q^6 \\ &\equiv Q_0^6 \cup_\sigma B^6\end{aligned}$$

and let

$$\beta \equiv \beta_0 \cup_\partial id_{B^3 * S^2} : Q^6 \rightarrow G^3 * S^2 \cup_\partial B^3 * S^2 = H^3 * S^2.$$

Then $\bar{f} = \beta\alpha$.

Claim. α is approximable by homeomorphisms.

Proof. This follows because $\alpha_0|_{\tilde{N}^6}$ is arbitrarily majorant-closely approximable by homeomorphisms, which in turn follows because $\alpha_0|_{\tilde{N}^6}$ satisfies the Bing Shrinking Criterion, namely, $\alpha_0|_{\tilde{N}^6}$ has a countable discrete collection of nontrivial point-inverses, each of which is cellular. This is because, recalling the present description of \tilde{N}^6 as a quotient of $G^3 * S^2 - S^2 \approx G^3 \times \mathbb{R}^2$, the nontrivial point-inverses of $\alpha_0|_{\tilde{N}^6}$ are each homeomorphic to $c(G_1^3 \times I_1^2)$ or to $\Sigma(G_1^3 \times I_1^2)$, each of which has a deleted neighborhood homeomorphic to $(G^3 \times I^2 \cup c(\partial(G^3 \times I^2))) \times \mathbb{R}^1$ or to $\Sigma(\partial(G^3 \times I^2)) \times \mathbb{R}^1$, which are each homeomorphic to $S^5 \times \mathbb{R}^1$ (cf. earlier remarks on $L^5 \times \mathbb{R}^1$).

We now turn our attention to $\beta : Q^6 \rightarrow H^3 * S^2$, where now we know from the preceding Claim that Q^6 is a manifold, homeomorphic to S^6 . The nontrivial point inverses of β consist of a countable null sequence of arcs. Inspection reveals that we can regard any one of these arcs, A say, as having a compact pinched neighborhood W in Q , described by the following model:

$$\begin{aligned}A &\equiv \{G_1^3 \times I_1^2 \times t \mid 1 \leq t < \infty\} \cup \infty (\approx [1, \infty]) \subset W \\ &\equiv (G^3 \times I^2 \times [0, \infty]) / \{G_1^3 \times I_1^2 \times t \mid 1 \leq t < \infty\} \cup \infty.\end{aligned}$$

There is a useful cone structure on W , displayed by writing

$$W = c_1(G^3 \times I^2 \cup c_\infty(\partial(G^3 \times I^2))),$$

where $G^3 \times I^2$ here is to be regarded as

$$G^3 \times I^2 \times 0 \cup \partial(G^3 \times I^2) \times [0, 1]$$

in the first description, where c_∞ denotes coning to the point ∞ , and where c_1 denotes coning to a point labelled 1. In this latter description, the arc A becomes the interval $A = [c_1, c_\infty] \subset W$. Note that W has a natural manifold interior, $\text{int } W = \dot{c}_1(G^3 \times I^2 \cup c_\infty(\partial(G^3 \times I^2)))$, but the ‘‘boundary’’ (i.e., the base of the cone) is not necessarily a manifold. From the definitions, $A \cap \text{int } W = A - c_\infty$, and also $A - (c_1 \cup c_\infty)$ has a product neighborhood in $\text{int } W$ (but this neighborhood, after deleting the core, need not be simply connected, as it has the homotopy type of $\partial(G^3 \times I^2)$).

Using this model, we can describe Q^6 and $\beta : Q^6 \rightarrow H^3 * S^2$ this way. To obtain Q^6 , start with $G^3 * S^2 \cup_\partial B^6$, and replace each of the countably many nontrivial g_0 -point-inverse sets, i.e. each of the pinched neighborhoods $G^3 \times I^2 \times [0, \infty) \cup \infty$, with a copy of W in the obvious manner. The map β is the quotient map which identifies to a point each arc A in each copy of W in Q^6 . We will denote this countable null collection of arcs and their pinched neighborhoods in Q^6 by $\{A_\ell\}$ and $\{W_\ell\}$.

To complete the proof, it remains to establish:

Proposition. $\beta : Q^6 \rightarrow H^3 * S^2$ is approximable by homeomorphisms. That is, the above decomposition of Q^6 into arcs $\{A_\ell\}$ and points is shrinkable.

The inspiration for this proposition and its proof comes from a theorem of Bing [Bi2, Thm. 3], who showed that a decomposition of a manifold whose nontrivial elements comprise a countable (not necessarily null) collection of flat arcs is a shrinkable decomposition. (Bing did not require his collection to be null, because he gave an ingenious but simple argument about limits [Bi2, p. 368], which in effect let him assume that his collection was null. Since our collection above is null to begin with, we will not need this part of his argument.)

The heart of Bing's argument is a certain technical proposition [Bi2, Lemma 4] dealing with shrinking individual arcs, which we state here in a form applicable to our situation.

LEMMA 4 (Shrinking an individual arc). Suppose A_0 is one of the arcs in the collection $\{A_\ell\}$, and suppose $\epsilon > 0$ is given. Then there exists a neighborhood U of A_0 in $N_\epsilon(A_0)$ (the ϵ -neighborhood of A_0 in Q^6) and there exists a homeomorphism $h : Q^6 \rightarrow Q^6$, supported in U , such that for any arc A_ℓ , if $A_\ell \cap U \neq \emptyset$, then $\text{diam } h(A_\ell) < \epsilon$.

Given this lemma, it is an easy matter to establish that the Bing Shrinking Criterion holds for the decomposition $\{A_\ell\}$, for one only has to apply the lemma to those finitely many members of $\{A_\ell\}$ whose diameters are bigger than some preassigned $\epsilon > 0$.

To prove his original version of the Lemma, Bing used the flatness of his arc A_0 . It turns out that our nonflat arcs have enough regularity so that all the requisite motions of the lemma can be performed. In order to describe these motions, we make a definition. An embedded arc A (parametrized by $[1, \infty]$, here) in a manifold-without-boundary Q has the *almost covering retraction* property (toward the 1-end, in the definition here) provided that for any $a \in [1, \infty]$ and any $\epsilon > 0$, there is a homeomorphism $h : Q \rightarrow Q$, supported in $N_\epsilon([a, \infty])$, such that the restriction $h|_{[1, \infty]}$ is ϵ -close to the retraction-inclusion map $[1, \infty] \rightarrow [1, a] \hookrightarrow Q$. (This concept has been used profitably by several people, among them Bryant-Seebeck [BS], Cantrell-Lacher [CL], Bryant [Bry] and Price-Seebeck [PS].) The simplest example of an arc with this property is a flat arc, or more generally, any subarc of an open arc having a product neighborhood. Also, we have:

LEMMA 5. Suppose A_0 is one of the arcs in the collection $\{A_\ell\}$. Then A_0 has the almost covering retraction property, toward the 1-end.

Note. If $\pi_1(G^3) \neq 1$, then A_0 cannot have the almost covering retraction property toward the ∞ -end, as a straightforward fundamental group analysis shows.

PROOF OF LEMMA 4 FROM LEMMA 5. The following argument is adapted from [Bi2, Lemma 4]. Pictures are indispensable (but are not provided here). Given $A_0 \approx [1, \infty]$ and given $\epsilon > 0$, choose a partition $1 = a_1 < a_2 < \dots < a_n < a_{n+1} = \infty$ of $[1, \infty]$ so fine that each subinterval $[a_i, a_{i+1}]$ in Q has diameter $< \epsilon/6$. Let $\delta \in (0, \frac{\epsilon}{12})$ be so small that 2δ is less than the minimum distance between any two nonintersecting subintervals in this partitioning, and such that for any arc A_ℓ aside from A_0 , if A_ℓ intersects $N_\delta(A_0)$, then $\text{diam } A_\ell < \epsilon/2$. Choose, in the order

$U_n, h_n, U_{n-1}, h_{n-1}, \dots, U_1, h_1$, a sequence of open subsets $\{U_i\}$ of Q and homeomorphisms $\{h_i\}$ of Q , satisfying the following conditions (letting $U_{n+1} = \emptyset$ and $h_{n+1} = \text{identity}$). Each U_i is a neighborhood of $[a_i, \infty]$ such that

- (1) $U_i - U_{i+1} \subset N_\delta([a_i, a_{i+1}])$ (and hence, applying induction, $\cup_{j=i}^n U_j \subset N_\delta([a_i, \infty])$),
- (2) (cf. (5) below for $h_{i+1}h_{i+1}(U_i) \subset N_\delta([a_i, a_{i+1}])$ (and hence by (1), $h_{i+1}(U_i) \cap \cup_{j=i+2}^n U_j = \emptyset$), and
- (3) no arc A_ℓ intersects both U_i and $(\cup_{j=i+2}^n U_j) - U_{i+1}$ (note this latter set misses A_0).

Each h_i is chosen, using the almost covering retraction property for the retraction $[1, \infty] \rightarrow [1, a_i]$, so that

- (4) h_i is supported in U_i , and
- (5) $h_i([a_{i-1}, \infty]) \subset N_\delta([a_{i-1}, a_i])$.

The desired homeomorphism of Lemma 4 is $h = h_n h_{n-1} \dots h_2 h_1$, which is supported in $U = \cup_{i=1}^n U_i \subset N_\delta(A_0)$. To verify the conclusion, suppose A_ℓ is such that $A_\ell \cap U \neq \emptyset$. Let i be the least index such that $U_i \cap A_\ell \neq \emptyset$. Hence A_ℓ misses the supports of h_1, \dots, h_{i-1} and so $h(A_\ell) = h_n \dots h_i(A_\ell)$. By (3), A_ℓ misses $(\cup_{j=i+2}^n U_j) - U_{i+1}$, and so $A_\ell \cap U \subset U_i \cup U_{i+1}$. Now, $h_{i+1}h_i(U_i \cup U_{i-1}) \subset U_i \cup U_{i+1}$. By (2), $h_{i+2}(U_{i+1}) \subset N_\delta([a_{i+1}, a_{i+2}])$, and by (1) and (4), $U_i - U_{i+1}$ is not moved by h_{i+2} . Consequently $h_{i+2}(U_i \cup U_{i+1}) \subset N_\delta([a_i, a_{i+2}])$, and $h_{i+2}(U_i \cup U_{i+1})$ misses $\cup_{j=i+3}^n U_j$. So $h(A_\ell \cap U) \subset h_n \dots h_{i+2}(U_i \cup U_{i+1}) = h_{i+2}(U_i \cup U_{i+1}) \subset N_\delta([a_i, a_{i+2}])$. So $\text{diam } h(A_\ell \cap U) < \epsilon/2$. Now by choice of δ , $\text{diam}(A_\ell - U) < \epsilon/2$. Hence Lemma 4 is established from Lemma 5 \square

PROOF OF LEMMA 5. Because of the product and cone structure of $\text{int } W_0$, which in particular ensures that any subarc $[1, a]$ of A_0 , $a < \infty$, has the almost covering retraction property toward the 1-end, it is clear that Lemma 5 can be deduced from the

Claim. *Given any $\delta > 0$, there is a homeomorphism h of Q , supported in $N_\delta(\infty)$, such that $h(A_0) \subset \text{int } W_0$ where ∞ denotes the ∞ -endpoint of A_0 .*

This claim is established by engulfing. Let $W_1 \subset (\text{int } W_0) \cup \infty$ be a copy of W_0 gotten by squeezing W_0 inwards a bit, keeping ∞ fixed, using an interior collar of W_0 which is pinched at ∞ . Then $\text{int } W_0 \cup \text{ext } W_1 = Q^6 - \infty$. Given $\delta > 0$, the idea is to use engulfing to produce two homeomorphisms $h_0, h_1 : Q^6 \rightarrow Q^6$, each supported in $N_\delta(\infty)$, such that $h_0(\text{int } W_0) \cup h_1(\text{ext } W_1) = Q^6$. Then $h = h_0^{-1} h_1$ is the desired homeomorphism of the Claim.

In order to construct these homeomorphisms using dual-skeleton engulfing arguments, it suffices as usual to construct certain engulfing homotopies (compare the following engulfing argument to that, in say, [Se]). Letting U denote either $\text{int } W_0$ or $\text{ext } W_1$, one wants establish that for any neighborhood V_0 of the point ∞ in Q^6 , there is a smaller neighborhood V_1 of ∞ and a homotopy deformation of $U \cup V_1$ into U such that all of the motion takes place in V_0 . Since $\text{cl } U$ is an ANR, it suffices to show that for any $\delta > 0$, there is a map $\text{cl } U \rightarrow U$ which is δ -close to the identity. The existence of this map is clear for $U = \text{int } W_0$, because W_0 has an interior collar. For $U = \text{ext } W_1$, one must analyze the situation more carefully. Probably the quickest argument is to pass to the target space under the cell-like

map $\beta : Q^6 \rightarrow H^3 * S^2$. Using the fact that U is saturated with respect to the point-inverses of β , and that the nontrivial point-inverses in U have diameter tending to 0 as they approach $\text{fr } U$, and using the map lifting property of cell-like maps, (see for example [Lac1, Lemmas 2.3, 3.4], [Ko, Thm 1] or [Hav, Lemma 3]), it suffices to show in the target $H^3 * S^2$ that for any $\delta > 0$ there is a map $\beta(\text{cl } U) \rightarrow \beta(U)$ which is δ -close to the identity. The construction of this map is fairly clear, using the uniform structure of $H^3 * S^2$ and the explicit description of $\beta(\text{cl } U)$ available from definitions, and using the interior collar on $B^3 * S^2 \subset H^3 * S^2$ to make sets disjoint from $G^3 * S^2$ by pushing them into $\text{int}(B^3 * S^2)$. This completes the proof of the Theorem. \square

The above proof does not apply in dimension 5 for the simple reason that there it would require the hypothesis that $\Sigma^2(H^3 \# H^3) \approx S^5$, which is essentially what one is trying to prove. Still, the above arguments in Lemmas 4 and 5 seem at first glance almost to work in dimension 5 to shrink the nontrivial point-inverses of the original cell-like map $f : S^5 \rightarrow \Sigma^2 H^3$ constructed in Part III. But the difficulty is that the nontrivial point-inverses of f , unlike arcs, have thickness as well as length. Hence the almost covering retraction principle fails to do the job completely. It would be interesting if such an argument could be made to work, for that would provide a brief proof of the Double Suspension Theorem.

The pinched neighborhood
 $G^3 \times I^2 \times [0, \infty) \cup \infty$, lying
in the ambient space $G^3 * S^2$

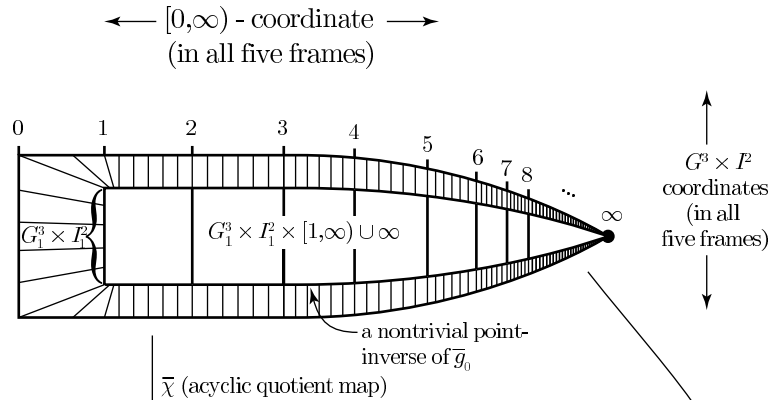

The pinched neighborhood
 $\bar{\chi}(G^3 \times I^2 \times [0, \infty) \cup \infty) =$
 $(G^3 \times I^2 \times [0, \infty) \cup \infty) / \{G_1^3 \times I_1^2 \times t \mid$
 $\ell + \frac{1}{3} \leq t \leq \ell + \frac{2}{3}, \ell \geq 1\}$, in
the ambient space $N^6 \cup S^2 (\approx B^6)$

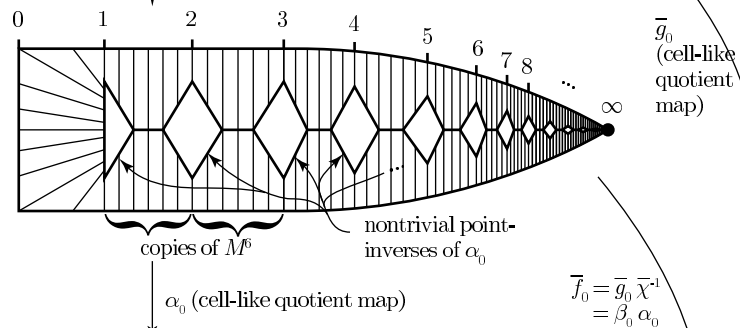

The pinched neighborhood
 $\alpha_0 \bar{\chi}(G^3 \times I^2 \times [0, \infty) \cup \infty)$
(precisely as described in the text)
the ambient space $Q_0^6 (\approx B^6)$

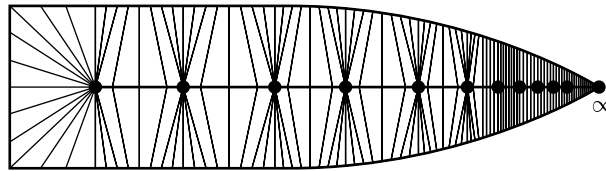

The pinched neighborhood
 $W = (G^3 \times I^2 \times [0, \infty) \cup \infty) /$
 $\{G_1^3 \times I_1^2 \times t \mid 1 \leq t < \infty\} \approx$
 $c_1(G^3 \times I^2 \cup c_\infty(\partial(G^3 \times I^2)))$, in
the ambient space $Q_0^6 (\approx B^6)$

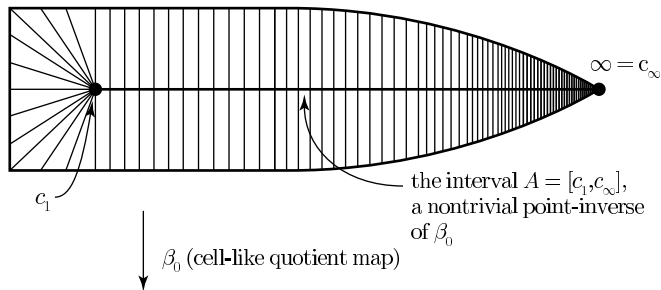

$\beta_0(W) \approx c_\infty(G^3 \times I^2)$, in
the ambient space $G^3 * S^2$

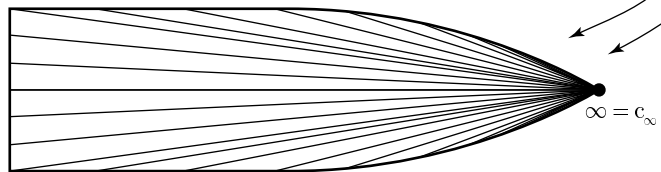

FIGURE IV-1. The nontrivial point inverses of the various maps $\bar{\chi}$, α_0 , β_0 , \bar{g}_0 , and \bar{f}_0 , together with their pinched neighborhoods

Bibliography

- [AK] S. Akbulut and H. King, *Realizing spaces by real algebraic varieties*, Notices Amer. Math. Soc. 24 (1977), A-623, 624.
- [Ak] E. Akin, *Manifold phenomena in the theory of polyhedra*, Trans. Amer. Math. Soc. 143 (1969), 413-473.
- [AC] F. D. Ancel and J.W. Cannon, *The locally flat approximation of cell-like embedding relations*, preprint, 1977.
- [An] D. R. Anderson, *A triangulable space which possesses no natural PL structure*, preprint, 1976. Announced in Notices Amer. Math. Soc. 24 (1977), A-151.
- [Ar] S. Armentrout, *Cellular decompositions of 3-manifolds that yield 3-manifolds*, Memoirs of the Amer. Math. Soc., no. 107, 1971.
- [BCC] I. Bernstein, M. Cohen and R. Connelly, *Contractible, non-collapsible products with cubes*, preprint, 1977. Announced in Notices Amer. Math. Soc. 24 (1977), A-445.
- [Bi1] R. H. Bing, *A homeomorphism between the 3-sphere and the sum of two solid horned spheres*, Ann. of Math. 56 (1952), 354-362.
- [Bi2] R. H. Bing, *Upper semicontinuous decompositions of \mathbb{E}^3* , Ann. of Math. (65) 1957, 363-374.
- [Bi3] R. H. Bing, *A decomposition of \mathbb{E}^3 into points and tame arcs such that the decomposition space is topologically different from \mathbb{E}^3* , Ann. of Math 65 (1957), 484-500.
- [Bi4] R. H. Bing, *The cartesian product of a certain non-manifold and a line is \mathbb{E}^4* , Ann. of Math. 70 (1959), 399-412.
- [Brou] L. E. J. Brouwer, *Über Abbildungen von Mannigfaltigkeiten*, Mathematische Annalen 71 (1912), 97-115.
- [Brwd] W. Browder, *Surgery on Simply-connected Manifolds*, Springer-Verlag, 1972.
- [Brwn] M. Brown, *The monotone union of open n -cells is an open n -cell*, Proc. Amer. Math. Soc. 12 (1961), 812-814.
- [Bry] J. L. Bryant, *Euclidean n -space modulo an $(n-1)$ -cell*. Trans. Amer. Math. Soc. 179 (1973), 181-192.
- [BL1] J. L. Bryant and R. C. Lacher, *Mapping cylinder neighborhoods of one-complexes in four-space*, Trans. Amer. Math. Soc. 164 (1972), 333-339.
- [BL2] J. L. Bryant and R. C. Lacher, (*Theorem: An ENR homology n -manifold, $n \geq 5$, with codimension ≥ 3 nonmanifold set, is the cell-like image of an n -manifold*; 1977.)
- [BS] J. L. Bryant and C. L. Seebeck III, *Locally nice embeddings of polyhedra*, Quart. J. Math. Oxford Ser. (2) 19 1968 257-274.
- [Cai1] S. S. Cairns, *Triangulated manifolds which are not Brouwer manifolds*, Ann. of Math. 41 (1940), 792-795.
- [Cai2] S. S. Cairns, *The triangulation problem and its role in analysis*, Bull. Amer. Math. Soc. 52 (1946), 545-571.
- [Can1] J. W. Cannon, $\Sigma^2 H^3 = S^5/G$, Rocky Mountain J. Math. (to appear).
- [Can2] J. W. Cannon, *Shrinking cell-like decompositions of manifolds. Codimension three*, Ann. of Math (to appear).
- [Can3] J. W. Cannon, (*Theorem: An ENR homology n -manifold, $n \geq 4$, with codimension ≥ 3 nonmanifold set, is the cell-like image of an n -manifold*; 1977.)
- [CD] J.W. Cannon and R. J. Daverman, *Cell-like decompositions arising from mismatched sewings: applications to 4-manifolds*, preprint, 1977.
- [CE] J. C. Cantrell and C. H. Edwards, Jr., eds., *Topology of Manifolds*, (Proceedings of the 1969 Georgia Conference), Markham, Chicago, 1970.

- [CL] J. C. Cantrell and R. C. Lacher, *Local flattening of a submanifold*, Quart. J. Math. Oxford Ser. (2) 20 1969 1–10.
- [Ce] A. V. Cernavskii, *The identity of local flatness and local simple connectedness for imbeddings of $(n-1)$ -dimensional into n -dimensional manifolds when $n > 4$* . (Russian) Mat. Sb. (N.S.) 91(133) (1973), 279–286, 288.
- [Ch] T. Chapman, *Lectures on Hilbert Cube Manifolds*, C.B.M.S. Regional Conference Series, no. 28, Amer. Math. Soc., 1976.
- [Co] E. H. Connell, *A topological h -cobordism theorem*, Illinois J. Math. 11 (1967), 300–309.
- [CW] M. L. Curtis and R. L. Wilder, *The existence of certain types of manifolds*, Trans. Amer. Math. Soc. 91 (1959), 152–160.
- [CZ] M. L. Curtis and E. C. Zeeman, *On the polyhedral Schoenflies theorem*, Proc. Amer. Math. Soc. 11 (1960), 888–889.
- [Da1] R. J. Daverman, *On the scarcity of tame disks in certain wild cells*, Fund. Math. 79 (1973), 63–77.
- [Da2] R. J. Daverman, *Locally nice codimension one manifolds are locally flat*, Bull. Amer. Math. Soc. 79 (1973), 410–413.
- [Da3] R. J. Daverman, *Sewings of closed n -cell complements*, Trans. Amer. Math. Soc. (to appear).
- [DE] R. J. Daverman and W. T. Eaton, *An equivalence for the embeddings of cells in a 3-manifold*, Trans. Amer. Math. Soc. 145 (1969), 369–381.
- [DK] G. Danaraj and V. Klee, *Which spheres are shellable?*, preprint 1977.
- [EP] W. T. Eaton and C. P. Pixley, *S^1 cross a UV decomposition of S^3 yields $S^1 \times S^3$* , pp. 166–194 in [GR].
- [Ed1] R. D. Edwards, *Approximating codimension ≥ 3 σ -compacta with homotopically tame embeddings*, preprint, 1972.
- [Ed2] R. D. Edwards, *The double suspension of a certain homology 3-sphere is S^5* , Notices Amer. Math. Soc. 22 (1975), A336.
- [Ed3] R. D. Edwards, *Approximating certain cell-like maps by homeomorphisms*, manuscript, 1977. Announced in Notices Amer. Math. Soc. 24 (1977), A-649.
- [EG] R. D. Edwards and L. C. Glaser, *A method for shrinking decompositions of certain manifolds*, Trans. Amer. Math. Soc. 165 (1972), 45–56.
- [EM] R. D. Edwards and R. T. Miller, *Cell-like closed-0-dimensional decompositions of \mathbb{R}^3 and \mathbb{R}^4 factors*, Trans. Amer. Math. Soc. 215 (1976), 191–203.
- [ES] R. D. Edwards and M. G. Scharlemann, *A remark on suspensions of homology spheres*, Notices Amer. Math. Soc. 21 (1974), A-324.
- [GS1] D. E. Galewski and R. J. Stern, *The relationship between homology and topological manifolds via homology transversality*, preprint, 1975.
- [GS2] D. E. Galewski and R. J. Stern, *Classification of simplicial triangulations of topological manifolds*, preprint, 1976 (abridged, 1977).
- [Gi] C. H. Giffen, *Disciplining dunce hats in 4-manifolds*, Ann. of Math. (to appear).
- [G11] L. C. Glaser, *On the double suspension of certain homotopy 3-spheres*, Ann. of Math. 85 (1967), 494–507.
- [G12] L. C. Glaser, *On double suspensions of arbitrary nonsimply connected homology n -spheres*, pp. 5–17 in [CE].
- [G13] L. C. Glaser, *On suspensions of homology spheres*, pp. 8–16 in: Manifolds-Amsterdam 1970, N. H. Kuiper, ed., Lecture Notes in Mathematics no. 197, Springer-Verlag, 1971.
- [G14] L. C. Glaser, *Decomposition problems related to suspensions of homology spheres*, pp. 225–237 in [McA3].
- [Han] M. Handel, *A resolution of two stratification conjectures for CS sets*, Topology (to appear).
- [Hav] W. E. Haver, *Mappings between ANR's that are fine homotopy equivalences*, Pacific J. Math. 58 (1975), 457–461.
- [Hi1] M. W. Hirsch, *The imbedding of bounding manifolds in euclidean space*, Ann. of Math. 74 (1961), 494–497.
- [Hi2] M. W. Hirsch, *On homotopy spheres of low dimensions*, pp. 199–204 in: Differential and Combinatorial Topology, S.S. Cairns, ed., Princeton University Press, 1965.
- [HNK] F. Hirzebruch, W. D. Neumann and S. S. Koh, *Differentiable Manifolds and Quadratic Forms*, Marcel Dekker, Inc., New York, 1971.

- [HW] W.-C. Hsiang and C.T.C. Wall, *On homotopy tori II*, Bull. London Math Soc. 1(1969), 341-342.
- [Ke] M. A. Kervaire, *Smooth homology spheres and their fundamental groups*, Trans. Amer. Math. Soc. 144 (1969), 67-72.
- [KS1] R. C. Kirby and L. C. Siebenmann, *A straightening theorem and a Hauptvermutung for pairs*, Notices Amer. Math. Soc. 16 (1969), 582.
- [KS2] R. C. Kirby and L. C. Siebenmann, *Foundational Essays on Topological Manifolds, Smoothings, and Triangulations*, Annals of Mathematics Studies, Princeton University Press, 1977.
- [Ko] G. A. Kozłowski, *Factorization of certain maps up to homotopy*, Proc. Amer. Math Soc. 21 (1969), 88-92.
- [Ku] N. H. Kuiper, *A short history of triangulation and related matters*, preprint of address to the Wiskundig Genootschap (=Congress of the Dutch Mathematical Society)(1977).
- [Lac1] R. C. Lacher, *Cell-like mappings*, I, Pacific J. Math. 30 (1969), 717-731.
- [Lac2] R. C. Lacher, *Cell-like mappings and their generalizations*, Bull. Amer. Math. Soc. 83 (1977), 495-552.
- [Las] R. Lashof, *Problems in differential and algebraic topology*, Seattle Conference, 1963, Ann. of Math. 81 (1965), 565-591.
- [Li] L. L. Lininger, *Actions on S^n* , Topology 9 (1970), 301-308.
- [Mat1] T. Matumoto, *Homology manifolds and topological manifolds*, preprint, 1973. This is now part of [Mat2].
- [Mat2] T. Matumoto, *Variétés simpliciales d'homologie et variétés topologiques metrisables*, Thesis, University of Paris, Orsay, 1976.
- [Mau] C. R. F. Maunder, *Algebraic Topology*, Van Nostrand Reinhold, London, 1970.
- [Maz] B. Mazur, *A note on some contractible 4-manifolds*, Ann. of Math. 73 (1961), 221-228.
- [McA 1] L. F. McAuley, *Upper semicontinuous decompositions of \mathbb{E}^3 into \mathbb{E}^3 and generalizations to metric spaces*, pp. 21-26 in: Topology of 3-Manifolds and Related Topics (Proceedings of the 1961 Georgia Conference), M. K. Fort, Jr., ed., Prentice-Hall, 1962.
- [McA 2] L. F. McAuley, *Some fundamental theorems and problems related to monotone mappings*, pp. 1-36 in [McA3].
- [McA3] L. F. McAuley, ed., *Proceedings of the First Conference on Monotone Mappings and Open Mappings*, State University of New York at Binghamton, 1971.
- [McM1] D. R. McMillan, *A criterion for cellularity in a manifold*, Ann. of Math. 79 (1964), 327-337.
- [McM2] D. R. McMillan, *An arc in M^N with no neighborhood in S^N , $N \geq 4$* , preprint, 1976.
- [Moi] E. E. Moise, *Certain classical problems of euclidean topology*, in: Summary of Lectures and Seminars, Summer Institute on Set Theoretic Topology, Madison, Wisconsin, 1955.
- [MS] D. Montgomery and H. Samelson, *On the action of $SO(3)$ on S^n* , Pacific J. Math. 12 (1962), 649-659.
- [Mo] R. L. Moore, *Concerning upper semicontinuous collections of continua*, Trans. Amer. Math. Soc. 27 (1925), 416-428.
- [Neu] J. L. Neuzil, *Spheroidal decompositions of \mathbb{E}^4* , Trans. Amer. Math. Soc. 155 (1971), 35-64.
- [New1] M. H. A. Newman, *Boundaries of ULC sets in Euclidean n -space*, Proc. Nat. Acad. Sci. U.S.A. 34 (1948), 193-196.
- [New2] M. H. A. Newman, *The engulfing theorem for topological manifolds*, Ann. of Math. 84 (1966), 555-571.
- [Ol] R. Oliver, *Weight systems for $SO(3)$ -actions*, preprint, 1977.
- [Po] V. Poenaru, *Les decompositions de l'hypercube en produit topologique*, Bull. Soc. Math. France 88 (1960), 113-129.
- [PS] T. Price and C. L. Seebeck III, *A codimension two taming theorem*, Geometric Topology (Proc. Conf., Park City, Utah, 1974), pp. 371-394. Lecture Notes in Math., Vol. 438, Springer, Berlin, 1975.
- [Sch] M. G. Scharlemann, *Transversality theories at dimension four*, Inventiones Math. 33 (1976), 1-14.
- [Se] C. L. Seebeck III, *Collaring an $(n-1)$ -manifold in an n -manifold*, Trans. Amer. Math. Soc. 148 (1970), 63-68.

- [Sha1] J. L. Shaneson, *Embeddings with codimension two of spheres in spheres and h-cobordisms of $S^1 \times S^3$* , Bull. Amer. Math. Soc. 74 (1968), 972-974.
- [Sha2] J. L. Shaneson, *Non-simply-connected surgery and some results in low dimensional topology*, Comments. Math. Helv. 45 (1970), 333-352.
- [Si1] L. C. Siebenmann, *On detecting euclidean space homotopically among topological manifolds*, Inventiones Math. 6 (1968), 245-261.
- [Si2] L. C. Siebenmann, *Disruption of low dimensional handlebody theory by Rohlin's theorem*, pp. 57-76 in [CE].
- [Si3] L. C. Siebenmann, *Are non-triangulable manifolds triangulable?*, pp. 77-84 in [CE].
- [Si4] L. C. Siebenmann, *On suspensions of homology spheres*, Archive der Math 23 (1972), 318.
- [Si5] L. C. Siebenmann, *Deformation of homeomorphisms on stratified sets*, Comment. Math. Helv. 47 (1972), 123-163.
- [Si6] L. C. Siebenmann, *Approximating cellular maps by homeomorphisms*, Topology 11 (1973), 271-294.
- [She] R. B. Sher, *Tame polyhedra in wild cells and spheres*, Proc. Amer. Math. Soc. 30 (1971), 189-174.
- [St] J. R. Stallings, *The piecewise linear structure of euclidean space*, Proc. Cambridge Phil. Soc. 58 (1962), 481-488.
- [Št1] M. A. Štan'ko, *Approximation of the imbeddings of compacta in codimensions greater than two*, Dokl. Akad. Nauk SSSR 198 (1971), 783-786 = Soviet Math. Dokl. 12 (1971), 906-909.
- [Št2] M. A. Štan'ko, *Approximation of compacta in \mathbb{E}^n in codimension greater than two*, Mat. Sbornik 90 (132) (1973), 625-636 = Math. USSR Sbornik 19 (1973), 615-626 (expanded version of [Št1], with some revisions in exposition).
- [Št3] M. A. Štan'ko, *Approximation of imbeddings of manifolds in codimension one*, Math. Sbornik 94 (136) (1974), 483-494 = Math. USSR Sbornik 23 (1974), 456-466.
- [Wh1] J. H. C. Whitehead, *A certain open manifold whose group is unity*, Quart. J. of Math. (Oxford) 6 (1935), 268-279.
- [Wh2] J. H. C. Whitehead, *On involutions of spheres*, Ann. of Math. 66 (1957), 27-29.