

On The Discrepancy of Quasi-progressions

Sujith Vijay

Department of Mathematics,

Rutgers, the State University of New Jersey

A classic result in discrepancy theory is the theorem of Roth [2] stating that if the elements of $\{0, 1, 2, \dots, n\}$ are 2-coloured, there exists an arithmetic progression $\{a, a+d, \dots, a+(k-1)d\}$ of discrepancy at least $(1/20)n^{1/4}$, with $0 \leq a < d \leq \sqrt{6n}$. In 1996, Matoušek and Spencer [8], building upon results by Sárközy (see [3]) and Beck [5], showed that apart from constants, this result is the best possible.

The situation is quite different, however, for homogeneous arithmetic progressions (HAPs), the subfamily of arithmetic progressions containing 0. It turns out that there are extremely balanced colourings for such arithmetic progressions. Consider the following examples.

$$\begin{aligned}\chi_3(3k+1) &= 1; \chi_3(3k+2) = -1; \chi_3(3k) = \chi_3(k) \\ \chi_3^*(3k+1) &= 1; \chi_3^*(3k+2) = -1; \chi_3^*(3k) = 0\end{aligned}$$

It is easy to show that all HAPs contained in $\{0, 1, \dots, n\}$ have discrepancy $O(\log n)$ under χ_3 and discrepancy at most 1 under χ_3^* . (Of course, χ_3^* is a 3-colouring, and if we are going to allow 0 we might as well colour everything 0, but let us look the other way and at the bright side for a moment.) In general, for any prime p , we can define a colouring χ_p^* via the non-trivial real character modulo p (the Legendre symbol). The discrepancy of all HAPs are bounded by $(p-1)/2$ under this colouring. Also note that χ_p^* is “almost admissible” for large p , since only a small fraction of numbers is coloured 0. Whether there is a “completely admissible” colouring of bounded discrepancy for HAPs is a question raised by Erdős in the 1930s, and one that remains unsolved to this day. It is indeed a mishap that this innocent-looking question should turn out to be so difficult.

Yet homogeneous arithmetic progressions are tiny herrings on the tip of the iceberg of quasi-progressions. Perhaps a definition is in order. A quasi-progression $Q(\alpha; s, t)$ is the sequence of integers

$$\lfloor s\alpha \rfloor, \lfloor (s+1)\alpha \rfloor, \dots, \lfloor t\alpha \rfloor$$

In other words, a quasi-progression is a sequence of successive multiples of a real number, with each multiple rounded down to the nearest integer. Since distinct real numbers yield distinct quasi-progressions, we are dealing with an uncountable family of sequences. Note that for integer values of α , quasi-progressions reduce to HAPs, or the set-difference of two HAPs. Thus the problem raised by Erdős concerns a subfamily of quasi-progressions, corresponding to integer values of α .

Our first theorem gives a lower bound on the discrepancy of the family of all quasi-progressions contained in $\{0, 1, \dots, n\}$.

Theorem 1 If the integers from 0 to n are 2-coloured, there exists $\alpha > 1$ and integers s and t such that the quasi-progression $Q(\alpha; s, t)$ has discrepancy at least $(1/50)n^{1/6}$.

Proof Let $m < n$. The value of m will be specified at the end of the proof. By Roth's theorem, there exists an arithmetic progression $P_1 = \{a, a + d, a + 2d, \dots\}$ contained in $\{0, 1, \dots, m\}$, $2 \leq d < \sqrt{6m}$, $0 \leq a < d$, with discrepancy at least $(1/40)m^{1/4}$. Let $P_2 = (n - m) + P_1$. We will show that for suitably chosen m , P_2 can be realised as a quasi-progression corresponding to a real number $\alpha > 1$.

Observe that if $\alpha = d - \epsilon$, the first $\lfloor 1/\epsilon \rfloor$ elements in the sequence $\lfloor \alpha \rfloor, \lfloor 2\alpha \rfloor, \lfloor 3\alpha \rfloor, \dots$ are congruent to $-1 \pmod{d}$, the next $(\lfloor 2/\epsilon \rfloor - \lfloor 1/\epsilon \rfloor)$ elements are congruent to $-2 \pmod{d}$, and so on. In particular, the arithmetic progression $P_2 \equiv -(d - a) \pmod{d}$ can be realised as a quasi-progression by choosing ϵ such that P_2 is completely contained in the $(d - a)^{th}$ block of length $(1/\epsilon) + O(1)$.

Since $P_2 \subseteq \{n - m, n - m + 1, \dots, n\}$, it suffices to choose ϵ such that $(d - a - 1)\lceil 1/\epsilon \rceil < n - m$ and $(d - a)\lfloor 1/\epsilon \rfloor > n$. Such an ϵ exists if

$$\frac{n - m}{d - a - 1} - \frac{n}{d - a} > 1$$

Note that $d - a \leq d \leq \sqrt{6m}$. Therefore, we can choose $m = \lfloor 6^{-1/3}n^{2/3} \rfloor$. This yields a quasi-progression of discrepancy at least $(1/50)n^{1/6}$. ■

While it is not known whether the set of homogeneous arithmetic progressions have bounded discrepancy, there exist colourings (see [9]) for which the arithmetic progression $\{0, d, 2d, \dots\}$ has discrepancy at most $d^{4+o(1)}$ for all d . It turns out, however, that upper bounds independent of n do not exist for most quasi-progressions.

Let $\alpha > 1$ be given, together with a 2-colouring of $\{0, 1, \dots, n\}$. Let $D_\alpha(n)$ denote the maximum discrepancy of $Q(\alpha; s, t)$ over all admissible s and t . In 1986, Beck [6] showed that given any 2-colouring of the non-negative integers, for almost every $\alpha \in [1, \infty)$, there are infinitely many n such that $D_\alpha(n) \geq \log^* n$. Recall that $\log^* x$ denotes the inverse of the tower function: $\log^* x = \ln x$ for $1 < x < e$ and $\log^*(e^x) = 1 + \log^* x$.

We improve on this result, and prove the following theorem.

Theorem 2 Let χ be a partial colouring of the non-negative integers with density $\rho > 0$, and let χ_n denote the restriction of χ to $\{0, 1, \dots, n\}$. Then for almost every $\alpha \in [1, \infty)$, there are infinitely many n such that $D_\alpha(n) \geq (\log n)^{1/4-o(1)}$.

Proof Let E denote the set of α such that there are only finitely many n with $D_n(\alpha) \leq (\log n)^{1/4-o(1)}$ under the colouring χ . If E has positive measure, there exists a positive integer t for which the set of balanced α in $[t, t+1)$ has measure $\delta > 0$. But it follows from the Main Lemma (see below) that there exists $c_0 = c_0(\rho, t, \delta)$ such that the set of α with $D_n(\alpha) \leq c_0(\log n)^{1/4}$ has measure less than δ . For all other α in $[t, t+1)$, we have $D_n(\alpha) > (\log n)^{1/4-o(1)}$ for sufficiently large n , yielding a contradiction. ■

It remains to state and prove the Main Lemma.

Main Lemma Let χ and χ_n be as in the statement of Theorem 2. Given $t \in [1, \infty)$ and $\delta > 0$, there exists $c_0 = c_0(\rho, t, \delta)$ such that the set of α in $[t, t+1)$ with $D_\alpha(n) \leq c_0(\log n)^{1/4}$ under χ_n has Lebesgue measure less than δ .

Remark: We say that α is M -balanced if $D_\alpha(n) \leq M$. For brevity, we shall hereafter refer to $(c_0(\log n)^{1/4})$ -balanced α simply as “balanced”. We will transform the problem into a geometric setting, with a view to using orthogonal functions, as was done by Roth [1] in his classic paper on the

measure-theoretic discrepancy of axis-parallel rectangles. A similar construction was used by Hochberg [7] to show the existence of a quasi-progression of discrepancy $c'_0(\log n)^{1/4}$. As we saw in Theorem 1, quasi-progressions with much larger discrepancy do occur.

Proof We shall assume, for the sake of convenience, that $n = (t + 1)m$ where $m = 2^u$ for some positive integer u . We join each lattice point (a, b) with the one vertically above it, and give the resulting unit segment the colour $\chi(b)$. For each point (x, y) in the plane, the discrepancy function $D(x, y)$ is defined to be the sum of the χ -values of the unit segments crossed by the line joining $(0, 0)$ and (x, y) . Note that $|D(x, y)| \leq M$ if and only if y/x is M -balanced.

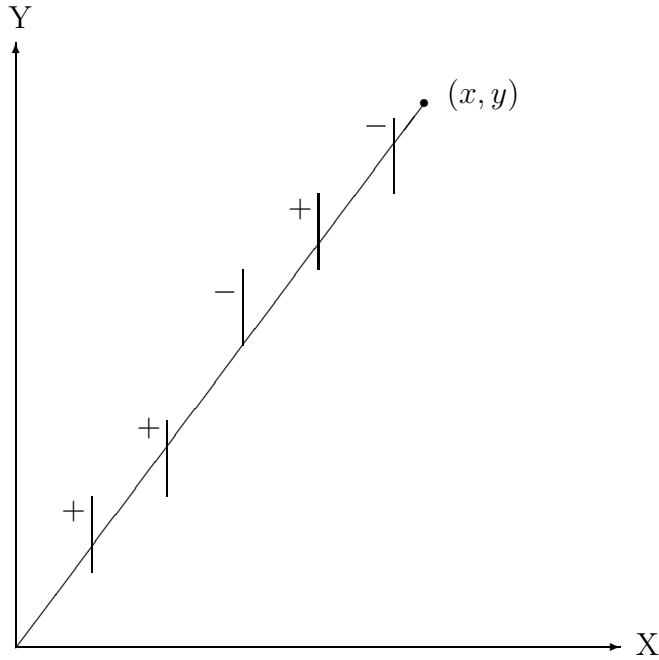

Let $H(x, y) = D(x, y)$ if y/x is balanced, and 0 otherwise. Suppose that the measure of the set of balanced α in $[t, t + 1)$ is at least δ . We will deduce a contradiction for a suitably chosen c_0 by producing a point (x_0, y_0) with $H(x_0, y_0) > c_0(\log n)^{1/4}$.

Let R denote the region bounded by the lines $x = m/2, x = m, y = tx, y = (t + 1)x$. We will construct orthonormal functions g_1, g_2, \dots, g_r on R where $r = (\log n)/8$ and

$$\sum_{i=1}^r (\langle H, g_i \rangle)^2 \geq \frac{\rho^2 \delta^{13} m^2 (\log n)^{1/2}}{2^{27} c_0^2 t^3}$$

Since R has area $3m^2/8$, it follows from Bessel's inequality that there exists (x_0, y_0) with $H(x_0, y_0) > c_0(\log n)^{1/4}$ for

$$c_0(\rho, t, \delta) = \frac{\rho^{1/2} \delta^{13/4}}{142t^{3/4}}$$

yielding the desired contradiction.

The functions g_1, g_2, \dots, g_r will be normalised versions of mutually orthogonal functions G_1, G_2, \dots, G_r . Following Hochberg, we will construct G_i by dividing R into a grid of trapezoids, called the i^{th} trapezoidal grid. We use vertical lines spaced $\ell = 2^i$ apart and slanting lines with slopes equally spaced between t and $t + 1$. The slopes of consecutive slanting lines differ by $\tau \doteq 1/(\ell\beta m)$ where $\beta = c_2(\log n)^{1/4}$. The value of c_2 will be specified later. It is easy to see that the individual grid trapezoids have area at most $1/\beta$ and at least $1/(2\beta)$.

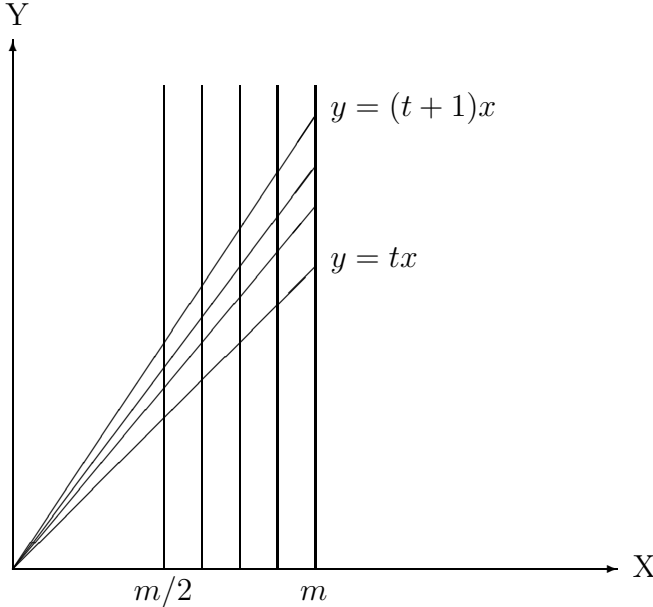

Note that we have specified only the spacing between the grid lines and not their actual position. We choose the position of the rightmost vertical line randomly and uniformly in the interval $[n - \ell, n)$, and the slope of the lowermost line randomly and uniformly in the interval $[t, t + \tau)$. The region between two consecutive sloping lines will be called a *sector*, and sectors will be identified with subintervals of $[t, t + 1)$ in the natural fashion. We will denote the measure of balanced α in the j^{th} sector of the i^{th} grid by μ_{ij} . For convenience, we define $\mu_{ij}^* = \mu_{ij}/\tau$.

If $\chi(b) \neq \chi(b - 1)$, we refer to b as a *switch value*. Furthermore, a lattice point (a, b) will be called a *switch point* if b is a switch value. A switch point is said to be *good* if it finds itself alone in a trapezoid no matter how the grid is positioned; *bad* otherwise. We shall denote the number of good switch points in the j^{th} sector of the i^{th} grid by s_{ij}^* .

We define G_i as follows: On a trapezoid containing exactly one switch point, G_i is defined in a checkerboard fashion. On all other trapezoids, G_i is defined to be identically zero.

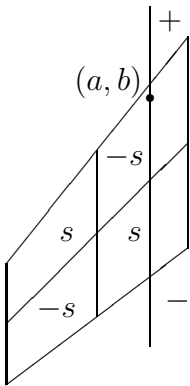

The vertical dividing line passes through the centre of the trapezoid. The position of the slanted dividing line is chosen such that the measure of balanced α above the line and inside the sector equals the measure of balanced α below the line and inside the sector. The value of s will vary from trapezoid to trapezoid, but will always equal $+1$ or -1 . Since the vertical dividing lines are nested dyadically (note that the vertical spacing is $\ell = 2^i$), it is clear that $\{G_i\}$ form an orthogonal family.

We now derive a lower bound on the inner product $\langle H, G_i \rangle$. The position of the slanting dividing line has been chosen with a view to extending Hochberg's argument for the $\mu_{ij}^* = 1$ case to the more general problem at hand.

Lemma 1 $E(\langle H, G_i \rangle) \geq (\sum_j (\mu_{ij}^*)^2 s_{ij}^*) / (32\beta)$

Proof Consider the contribution of a unit vertical segment $\ell_{a,b}$ joining (a, b) and $(a, b + 1)$ to the discrepancy function $H(x, y)$. Let

$$B_{a,b} = \left\{ (x, y) : x \geq a, \frac{b}{a} \leq \frac{y}{x} < \frac{b+1}{a} \right\}$$

denote the set of points behind the line $\ell_{a,b}$.

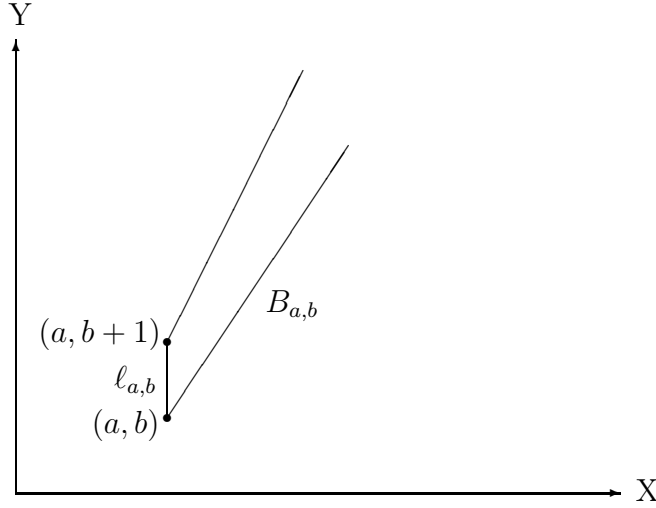

Now define

$$H_{a,b}(x, y) = \begin{cases} \chi(b) & \text{if } (x, y) \in B_{a,b} \text{ and } y/x \text{ is balanced} \\ 0 & \text{otherwise} \end{cases}$$

Clearly,

$$H(x, y) = \sum_{a=0}^{\infty} \sum_{b=0}^{\infty} H_{a,b}(x, y)$$

Furthermore, only finitely many terms in this sum are non-zero, for any fixed (x, y) . Consider a good switch point (a, b) lying inside a trapezoid T , located

in the j^{th} sector of the i^{th} grid.

We claim that if neither (a, b) nor $(a, b + 1)$ lie inside T , then

$$\int_T \int G_i(x, y) H_{a,b}(x, y) dx dy = 0$$

If T lies entirely outside or entirely inside $B_{a,b}$, it is clear that the integral is zero. If exactly one of the bounding lines of $B_{a,b}$ intersects T , the geometric symmetry with respect to the vertical dividing line or the measure-theoretic symmetry with respect to the sloping dividing line, as the case may be, ensures that there is perfect cancellation. Thus the integral vanishes in this case as well.

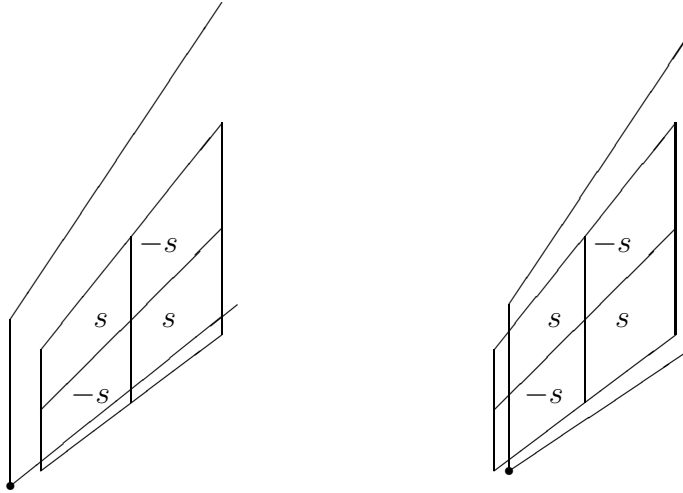

Therefore, we need consider only the terms $H_{a,b}(x, y)$ and $H_{a,b-1}(x, y)$, where $(a, b) \in T$. If (a, b) is not a switch point, we have,

$$\int_T \int G_i(x, y) (H_{a,b}(x, y) + H_{a,b-1}(x, y)) dx dy = 0$$

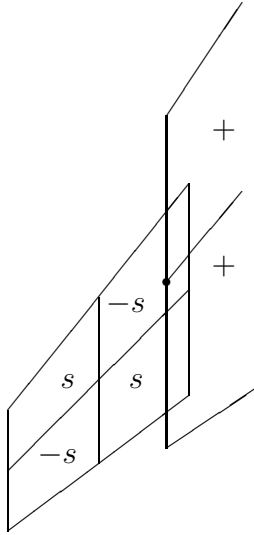

Now suppose that \$(a, b)\$ is a switch point. If \$(a, b)\$ lies on the intersection of the two dividing lines, we have

$$\int_T \int G_i(x, y)(H_{a,b}(x, y) + H_{a,b-1}(x, y)) dx dy = \frac{s}{4}(\chi(b) - \chi(b-1))\mu_{ij}^* \text{ area}(T)$$

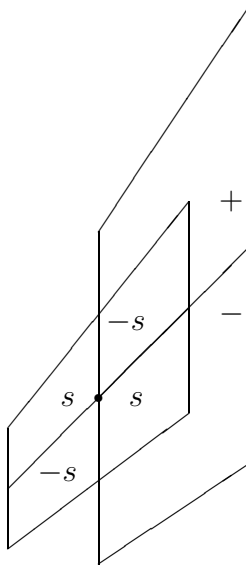

We choose \$s\$ so that the integral is positive. Since the switch point \$p\$ is good, there are no other lattice points in \$T\$, and the value of \$s\$ can now be

safely assumed fixed. Thus we get

$$\int_T \int G_i(x, y) H(x, y) dx dy \geq \frac{\mu_{ij}^*}{8\beta}$$

provided (a, b) lies on the intersection of the two dividing lines. Since the location of (a, b) inside the trapezoid is a uniformly distributed random variable, we have

$$E \left(\int_T \int G_i(x, y) H(x, y) dx dy \right) \geq \frac{(\mu_{ij}^*)^2}{32\beta}$$

Adding over all switch points and using the linearity of expectation, we get

$$E(\langle H, G_i \rangle) \geq \frac{1}{32\beta} \sum_j (\mu_{ij}^*)^2 s_{ij}^*$$

as claimed. \blacksquare

We now prove a slightly stronger version of a lemma due to Beck [6].

Lemma 2 Let $J \subseteq [0, 1]$ be an arbitrary interval of length λ and let $1 \leq b_1 < b_2 < \dots < b_q$ be integers. Let $N(\alpha, J) = |\{j : \{b_j \alpha\} \in J, 1 \leq j \leq q\}|$. If $q \geq \lambda^{-6}$, then $\mu(\{\alpha \in [0, 1] : N(\alpha, J) \geq (q\lambda/2)\}) \geq 1 - (8/\sqrt{q})$.

Proof The proof uses LeVeque's inequality from the theory of uniform distributions, and is almost identical to the proof of Beck's original lemma.

Let $x_j = \{b_j \alpha\}$, $1 \leq j \leq q$. Define $\Delta(\alpha)$ and $S_n(\alpha)$ as follows:

$$\Delta(\alpha) = \sup_{0 \leq a < b \leq 1} \left| \left(\sum_{j: x_j \in [a, b)} \frac{1}{q} \right) - (b - a) \right|$$

$$S_n(\alpha) = \frac{1}{q} \sum_{j=1}^q e^{2\pi i n x_j}$$

Note that

$$\int_0^1 |S_n(\alpha)|^2 d\alpha = \frac{1}{q^2} \int_0^1 \sum_{j=1}^q \sum_{k=1}^q e^{2\pi i n(b_j - b_k)\alpha} d\alpha = \frac{1}{q}$$

By LeVeque's inequality,

$$\Delta^3(\alpha) \leq \frac{6}{\pi^2} \sum_{n \in N} \frac{|S_n(\alpha)|^2}{n^2}$$

Therefore,

$$\int_0^1 \Delta^3(\alpha) d\alpha \leq \frac{6}{\pi^2} \int_0^1 \left(\sum_{n \in N} \frac{1}{n^2} |S_n(\alpha)|^2 \right) d\alpha = \frac{1}{q}$$

Let $E = \{\alpha \in [0, 1) : N(\alpha, J) \geq q\lambda/2\}$ and $F = [0, 1) \setminus E$. Clearly,

$$\frac{\lambda^3 \mu(F)}{8} \leq \int_0^1 \left| \left(\sum_{j: x_j \in J} \frac{1}{q} \right) - \lambda \right| d\alpha \leq \int_0^1 \Delta^3(\alpha) d\alpha$$

Therefore, $\lambda^3 \mu(F)/8 \leq 1/q$. Since $q \geq \lambda^{-6}$, we have

$$\mu(E) = 1 - \mu(F) \geq 1 - \frac{8}{\sqrt{q}},$$

proving the lemma. \blacksquare

Let b_1, b_2, \dots, b_q be the switch values of the colouring χ in $[N/2, N]$. Note that $q \geq (N\rho)/(4c_0(t+1)(\log n)^{1/4}) = (m\rho)/(4c_0(\log n)^{1/4})$. Since switch points come in rows, it is clear that χ_n gives rise to mq switch points.

Lemma 3 $\sum_j (\mu_{ij}^*)^2 s_{ij}^* \geq \delta^5 m q / (4096t)$, for $1 \leq i \leq r$

Proof We say that a sector is *rich* if $\mu_{ij}^* > \delta/2$. Let $\{I_k\}_{k=1}^L$ be an enumeration of the rich sectors. Since $(\delta/2)(n\ell\beta - L) + L\tau \geq \delta$, we have $L > (\delta/2)m\ell\beta$.

We use Lemma 2 with $J = [0, \delta/(4\ell\beta(t+1))]$, so that $\lambda = \delta/(4\ell\beta(t+1))$. Since $r = \log m/8$ and $i \leq r$, we have $q \geq \lambda^{-6}$. For an arbitrary interval $I = [a_k, b_k)$, let I' and I'' denote $[a_k, c_k)$ and $[c_k, b_k)$ respectively,

where the measure of balanced α in I' and I'' are equal. Let $A = \cup_{k=1}^L I'_k$. Note that A has measure at least $\delta^2/8$. Let $B = \{\theta : 1/\theta \in A\}$. Since $A \subseteq [t, t+1) \subseteq [t, 2t)$, the measure of B is at least $\delta^2/(32t^2)$.

Let $B^* = \{\theta \in B : N(\theta, J) \geq (q\lambda)/2\}$. For sufficiently large n , B^* has measure at least $\delta^2/(64t^2)$. Note that $\theta \in B^* \Rightarrow 1/\theta \in I'_k$ for some k . Suppose $\{b_v\theta\} \in J$ for such a θ . Let $a_v = \lfloor b_v\theta \rfloor$. Then we have,

$$0 < \frac{b_v}{a_v} - \frac{1}{\theta} < \frac{2\lambda(t+1)}{m} < \frac{\delta\tau}{4}$$

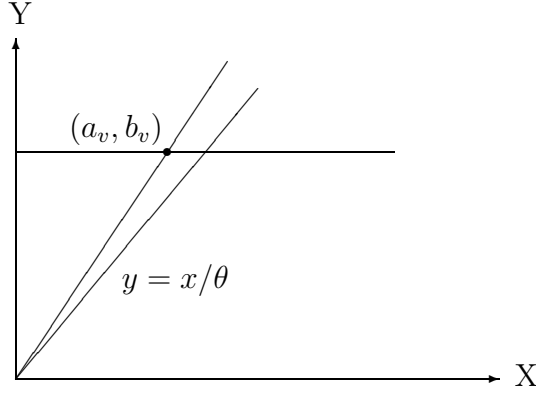

It follows that $(b_v/a_v) \in I_k$. Thus the k^{th} sector contains a switch point of the form (a_v, b_v) .

Since the contribution of a single I'_k towards the measure of B^* is at most τ/t^2 , there must be at least $\delta^2 m \ell \beta / (32t^2)$ rich sectors contributing at least $\delta^3 m q / (1024t)$ switch points between them.

We now derive an upper bound on the total number of bad switch points.

Given a bad switch point (a, b) , there exists a' such that

$$|a' - a| \leq \ell \text{ and } \left\| \frac{ba'}{a} \right\| < \frac{1}{\ell\beta}$$

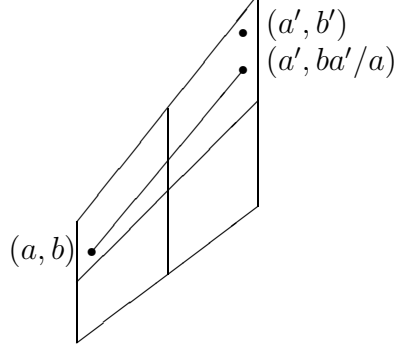

Let $d = |a' - a|$. Note that there are $m\ell/2$ pairs (a, d) with $1 \leq d \leq \ell$, $m/2 \leq a \leq m$. For each such pair, there are $a/(\ell\beta) + O(\ell)$ values of b that satisfy $||bd/a|| < 1/(\ell\beta)$. It follows that there are at most m^2/β lattice points which do not find themselves alone in a trapezoid for some placement of the grid.

Since the number of bad switch points is at most

$$\frac{m^2}{\beta} = \frac{m^2}{c_2(\log n)^{1/4}} < \frac{\delta^3 mq}{1024t}$$

for $c_2 \geq 4096c_0t/(\delta^3\rho)$, we have

$$\sum (\mu_{ij}^*)^2 s_{ij}^* > \frac{\delta^5 mq}{4096t}$$

as required. ■

Note that

$$E(\langle H, G_i \rangle^2) \geq [E(\langle H, G_i \rangle)]^2 \geq \left(\sum_j \frac{(\mu_{ij}^*)^2 s_{ij}^*}{32\beta} \right)^2$$

Furthermore, the combined area of all the grid trapezoids containing exactly one switch point is at most mq/β . Therefore,

$$E(\langle H, g_i \rangle^2) \geq \sum_j \frac{(\mu_{ij}^*)^2 s_{ij}^*}{1024mq\beta} \geq \frac{\rho^2 \delta^{13} m^2}{2^{24} c_0^2 t^3 (\log n)^{1/2}}$$

By the linearity of expectation,

$$E \left(\sum_{i=1}^r \langle H, g_i \rangle^2 \right) \geq \frac{\rho^2 \delta^{13} m^2 (\log n)^{1/2}}{2^{27} c_0^2 t^3}$$

Thus, for some placement of the grids, the resulting g_i satisfy

$$\sum_{i=1}^r (\langle H, g_i \rangle)^2 \geq \frac{\rho^2 \delta^{13} m^2 (\log n)^{1/2}}{2^{27} c_0^2 t^3}$$

yielding the statement of the main lemma. ■

Acknowledgement

I thank Professor József Beck for pointers to literature, useful discussions and constant encouragement.

References

1. K. F. Roth, *On irregularities of distribution*. Mathematika 1, 1954.
2. K. F. Roth, *Remark concerning integer sequences*. Acta Arithmetica 9, 1964.
3. P. Erdős and J. Spencer, *Probabilistic Methods in Combinatorics*. Akadémiai Kiadó, Budapest, 1974.
4. P. Erdős, *On the combinatorial problems which I would most like to see solved*. Combinatorica 1, 1981.
5. J. Beck, *Roth's estimate of the discrepancy of integer sequences is nearly sharp*. Combinatorica 1, 1981.
6. J. Beck, *On irregularities of ± 1 -sequences*. Österreich. Akad. Wiss. Math.-Natur. Kl. Sitzungsber II 195, 1986.
7. R. Hochberg, *Discrepancy and Bandwidth*. Ph.D. Thesis, Rutgers University, 1994.

8. J. Matoušek and J. Spencer, *Discrepancy in arithmetic progressions*. Journal of the American Mathematical Society 9, 1996.
9. D. Reimer, *Five Coloring Theorems*. Ph.D. Thesis, Rutgers University, 1997.