

# Color spectra and coloring conjectures

Louis H. Kauffman

Department of Mathematics, Statistics and Computer Science  
University of Illinois at Chicago  
851 S. Morgan St., Chicago IL 60607-7045  
USA

`kauffman@uic.edu`

and

Pedro Lopes

Departamento de Matemática  
Instituto Superior Técnico  
Av. Rovisco Pais  
1049-001 Lisboa  
Portugal  
`pelopes@math.ist.utl.pt`

June 1, 2006

## Abstract

In this article we take up the calculation of the minimum number of colors needed to produce a non-trivial coloring of a knot. This is a knot invariant and we use the torus knots of type  $(2, n)$  as our case study. We calculate the minima in some cases. In other cases we estimate upper bounds for these minima leaning on the features of modular arithmetic. We introduce a sequence of transformations on colored diagrams called Teneva Transformations. Each of these Transformations reduces the number of colors in the diagrams by one (up to a point). This allows us to further decrease the upper bounds on these minima. We conjecture on the value of these minima. We apply these Transformations to rational knots.

## 1 Introduction

In this article we take up the calculation of an invariant which stems from the number of colorings invariant of a knot. This invariant is the minimum number of colors it takes to produce a non-trivial coloring. See also [8].

The colorings we are here concerned with are the so-called Fox colorings, [5]. Given a knot diagram and an integer  $r$  we consider the integers  $0, 1, 2, \dots, r-1 \pmod r$ , whose set will be denoted  $\mathbb{Z}_r$ . We assign one integer (call it a color) to each arc of the diagram so that at each crossing the sum of the integers at the under-arcs minus twice the integer at the over-arc equals zero mod  $r$ . In this way, we set up a system of equations over  $\mathbb{Z}_r$ . Each of the solutions of this system of equations is called an  $r$ -coloring of the knot under consideration. There are always at least  $r$  solutions, regardless of the knot diagram or the integer  $r$  we are choosing; each of these  $r$  solutions is obtained by assigning the same color to each arc of the diagram. These are called the trivial solutions. A one-to-one correspondence of the solutions of the systems of equations before and after the performance of each of the Reidemeister moves is presented in [10]. In this correspondence, the trivial solutions go over to trivial solutions and non-trivial solutions go over to non-trivial solutions. In particular, the number of solutions for each  $r$ , is an invariant of the knot under study. The efficiency of this invariant in distinguishing prime knots up to ten crossings is illustrated in [4]. The invariant we there associate to each knot is in fact the *Color Spectrum of the Knot* i.e., the sequence of number of solutions (colorings) per  $r$ .

There is an alternative way of expressing the above results using the notion of quandles. A quandle is an algebraic structure ([7, 11]). The *knot quandle* is an invariant of the knot which is presented in the following way. Consider any diagram of the knot under study. Regard the arcs of the diagram as generators of the knot quandle and read specific relations at the crossings. The quandle so presented is the *knot quandle*. As with presentations of groups, a presentation of a quandle is not very helpful when one wants to decide after a finite number of steps whether two given presentations are isomorphic. One of the ways to make use of this invariant is to count homomorphisms from the knot quandle to specified labelling quandles. This is equivalent to our counting of solutions, as above, when we restrict the class of labelling quandles to the so-called *dihedral quandles*.

The importance of knowing the Color Spectrum of the knot  $K$  under consideration, is that it tells us immediately whether  $K$  is interesting or not for our current research and whether there is significant topological information in the Spectrum. In fact, for any  $r$ , the number of trivial colorings is  $r$ . Hence if the number of colorings for a given  $r$  is greater than  $r$ , there exist then non-trivial colorings for the knot under consideration. As an example, the trefoil exhibits nine 3-colorings. It has then non-trivial 3-colorings.

Assume we are considering an integer  $r$  and a knot diagram which exhibits non-trivial  $r$ -colorings. What is the least number of distinct colors it takes to construct a non-trivial coloring? Could we use less colors to construct a non-trivial coloring, if we work with a Reidemeister equivalent diagram to the current one? Having fixed the integer  $r$ , there is, for each knot  $K$ , a minimum number of colors such that, there is no diagram of this knot with a non-trivial coloring using less colors. We denote this minimum number of colors  $mincol_r(K)$ . This is a knot invariant. Apparently, in order to compute it, we have to consider a diagram of the knot under study say  $K$ , and find the minimum number of colors it takes to construct a non-trivial  $r$ -coloring. This operation should then be repeated for all diagrams of  $K$ , presenting the minimum for each of these diagrams. Finally, the minimum of these minima is the  $mincol_r(K)$ . In this article we present techniques that allow us to calculate  $mincol_r(K)$  in infinitely many cases and in other cases to estimate its upper bounds.

This invariant was first introduced in [6]. Considerations of the authors about it led them to set forth the Kauffman-Harary Conjecture which has already been proven to be true for rational knots, [9], and for Montesinos links, [1].

**Conjecture 1.1 (Kauffman-Harary, [6])** *Let  $p$  be a prime integer and assume  $K$  is an alternating knot of determinant  $p$ . Then, any non-trivial  $p$ -coloring on any minimal diagram of  $K$  assigns different colors to different arcs of the diagram.*

We note that the Kauffman-Harary Conjecture deals only with a specific  $r$  per knot. Moreover, the knots under consideration in this conjecture are all alternating knots of prime determinant (and the specific  $r$  is precisely this determinant, for each of these knots). In this article we adopt a broader point of view by not specifying  $r$ . In fact, we would like to develop computational tools that would allow us to calculate the  $mincol_r(K)$  for any  $r$ , and for any  $K$ . Here we content ourselves on studying the class of torus knots of type  $(2, n)$ .

The organization of this article is as follows. In Section 2 we develop the material and the notation that we use in the rest of the paper. In Subsection 3.1 we compute the Spectrum of each torus knots of type  $(2, n)$  i.e., for each of these knots we calculate the number of  $r$ -colorings for each  $r$ . To the best of our knowledge, this had never been calculated for non-prime  $r$ . In Subsection 3.2 we estimate upper bounds for minimum number of colors for the torus knots of type  $(2, n)$  by leaning on features of modular arithmetic. In Subsection 4.1 we calculate the exact minimum in two cases. In Subsection 4.2 we introduce the Teneva Transformations which allows to further decrease the upper bounds calculated in Subsection 3.2; we conjecture the value of the minimum number of colors based on the Teneva Transformations. In Subsection 5.1 we prove this conjecture in another instance. In Subsection 5.2 we apply Teneva Transformations to minimize the number of colors in rational knots. In Section 6 we present the final remarks.

## 1.1 Acknowledgements

**Acknowledgement.** It gives L.K. pleasure to thank the National Science Foundation for support of this research under NSF Grant DMS-0245588.

P.L. acknowledges support by *Programa Operacional “Ciência, Tecnologia, Inovação”* (POCTI) of the *Fundação para a Ciência e a Tecnologia* (FCT) cofinanced by the European Community fund FEDER. He also thanks the staff at IMPA and especially his host, Marcelo Viana, for hospitality during his stay at this Institution.

## 2 Background and notation

In this section we develop the material and notation that we use in this article.

**Definition 2.1 (Knot)** *We call an embedding of  $S^1$ , or of a finite number of  $S^1$ ’s, in 3-space a **knot**. In the literature, two knots are usually identified when the corresponding embeddings are deformable into each other. Due to the lack of ability of counting of colorings in telling apart knots that differ by reversing the orientation of the ambient space or by reversing the orientation of the embedding, we use here a different identification of knots. In this article we identify two knots  $K_1$  and  $K_2$  not only when their embeddings are deformable into each other but also when one of them, say  $K_1$ , is deformable into knot  $K_2'$  which is obtained from knot  $K_2$  by one or both the operations mentioned above: reversal of the orientation of the ambient space; reversal of the orientation of  $K_2$ .*

**Definition 2.2 (Quandle)** *A **quandle** is a set,  $X$ , equipped with a binary operation, denoted  $*$ , such that:*

- for all  $a \in X$ ,  $a * a = a$ ;
- for all  $a, b \in X$  there exists a unique  $x \in X$  such that  $x * b = a$  holds;
- for all  $a, b, c \in X$ ,  $(a * b) * c = (a * c) * (b * c)$

We give two examples of classes of finite quandles.

**Definition 2.3 (The trivial quandles)** *For each positive integer  $r$ , the set  $\{0, 1, 2, \dots, r - 1\}$  endowed with the operation  $a * b = a$  is a quandle called the **trivial quandle** of order  $r$ , denoted  $T_r$ .*

**Definition 2.4 (The dihedral quandles)** *For each integer  $r > 1$ , the set  $\{0, 1, 2, \dots, r - 1\}$  endowed with the operation  $a * b = 2b - a \pmod{r}$  is a quandle called the **dihedral quandle** of order  $r$ , denoted  $R_r$ .*

We note that we are here considering also the dihedral quandle of order two. This quandle is identical to the trivial quandle of order two.

**Definition 2.5 (Unoriented knot quandle)** *Given a knot  $K$ , its **unoriented knot quandle**,  $UQ(K)$ , is presented in the following way. Consider any knot digram of  $K$ , without orientation. The arcs of the diagram become the generators for the presentation and, at each crossing, relations are read as shown in Figure 1. Since there is no prejudicial choice between one side or the other of the over arc, we add the*

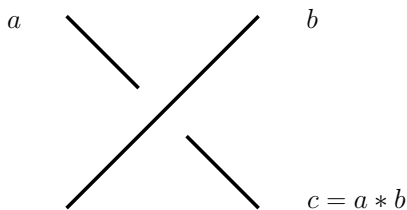

Figure 1: Generators and relation at a crossing

following involutory axiom to the arcs of the quandle:

$$(a * b) * b = a$$

**Definition 2.6 (*r*-coloring)** Given a knot  $K$ , and fixing an integer  $r > 1$ , an  $r$ -coloring is a homomorphism from the unoriented knot quandle to the dihedral quandle of order  $r$ ,  $R_r$ . Then, an  $r$ -coloring is a coloring by the dihedral quandle of order  $r$ . Moreover, in order to obtain an  $r$ -coloring, we replace equations of the form  $c = a * b$ , in the presentation of the unoriented knot quandle, by  $c = 2b - a$  in the labelling dihedral quandle. Any assignment of colors (elements from  $R_r$ ) to a knot diagram which satisfies the  $c = 2b - a$  condition at each crossing of the diagram is an  $r$ -coloring of this diagram.

Here is an alternative way of regarding colorings by dihedral quandles which allows us to introduce the definition of another invariant of a knot, the determinant of a knot.

**Definition 2.7 (Determinant of the knot)** Given a knot diagram or tangle diagram we can label the arcs by letters and write equations of the sort  $2b - a = c$  at crossings. This gives us a system of equations which may have solutions (colorings) over the integers for some tangles. For a knot, one of these equations will always be a linear combination of the others. We remove this equation and the unknown which corresponds to it from the system of equations thus obtaining a reduced system of equations. The determinant of the coefficients matrix of this reduced system (determinant of the reduced matrix) is the **determinant of the knot**. It is an invariant of the knot.

We next describe a technique to count colorings. It relies on the notion of **braid**. The braid group on  $n$  strands,  $B_n$ , can be presented by

$$\langle \sigma_1, \dots, \sigma_{n-1} \mid \sigma_i \sigma_j = \sigma_j \sigma_i (|i - j| > 1), \sigma_i \sigma_{i+1} \sigma_i = \sigma_{i+1} \sigma_i \sigma_{i+1} (i = 1, \dots, n - 1) \rangle$$

The geometric interpretation of a  $\sigma_i$  for a given  $i \in \{1, 2, \dots, n - 1\}$  is given in Figure 2. Multiplication of the generators is juxtaposition of the corresponding geometric objects. In this way, a braid i.e., an element of the braid group, stands for a number of entangled (or braided) heavy strands, acted upon by gravity. Each of these strands is further assumed to be suspended from one and only one of its endpoints, and all these endpoints are at the same height. The **closure of the braid** is the connection of the top segment of each strand of the braid to the bottom segment right below it. Upon closure, a braid becomes a knot. It is a theorem of Alexander that any knot can be realized as the closure of some braid. In this paper we will be mainly concerned with torus knots of type  $(2, n)$ . These can be realized as the closure of the product of  $n$  factors  $\sigma_1 \in B_2, \widehat{\sigma_1^n}$ . For more information on braids we refer the reader to Birman's book [2].

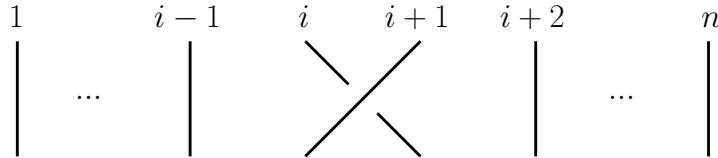

Figure 2:  $\sigma_i \in B_n$

Braids provide a systematic way of checking if a given assignment of colors to a diagram is a coloring. The procedure is as follows. We assign colors to the top segments of the braid and calculate their propagation downwards until the bottom segments of the braid are reached. That is, starting from the top crossing, at each crossing we assign to the lower under-arc the color which is twice the color of the over-arc minus the color of the under-arc right above the crossing in consideration. We repeat this operation at each crossing until the bottom crossing is reached. Since the bottom segments close up with the top segments (in order for the braid to stand for a knot diagram of the knot under study) then the expressions for the colors on the bottom segments have to equal the colors on the top segments. We call these equalities the coloring equation(s) for the knot under study, by the given quandle. Each solution of these coloring equations with respect to a given quandle yields a coloring of the knot by this quandle. Counting colorings by this quandle amounts to counting these solutions. Look at figure 3 for an illustrative example using a dihedral quandle. In this figure, in order for the colors  $a, b$  assigned to the top segments to stand for a coloring, the following equations have to hold, **in the dihedral quandle**,  $R_r$ :

$$\begin{cases} 3b - 2a =_r a \\ 4b - 3a =_r b \end{cases}$$

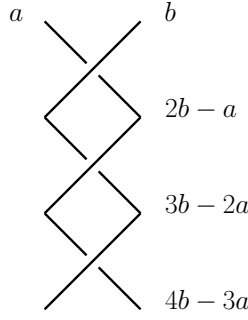

Figure 3: Coloring assignment to  $\sigma_1^3$

with the following understanding:

**Definition 2.8** Fix a positive integer  $r > 1$ . Given two integers  $n$  and  $n'$ , we write

$$n =_r n'$$

(read: “ $n$  equals  $n'$  modulo  $r$ ”) if, and only if,

$$n - n' = kr$$

for some integer  $k$ .

We remark that, in this article, braids usually stand for their closures. If  $\beta$  denotes a braid, its closure is denoted  $\widehat{\beta}$ . Even when the closure of braids is not explicitly mentioned this is what is meant. In particular, colorings of braids are always such that colors on the bottom segments match the colors on the top segments.

**Definition 2.9** Given an integer  $r > 1$  and a link  $K$ , we let

$$\#col_r K$$

stand for the number of  $r$ -colorings of  $K$ .

**Definition 2.10 (Spectrum of a knot)** Given a knot  $K$ , we call “Color Spectrum of Knot  $K$ ”, or just “Spectrum of  $K$ ”, denoted  $Spec(K)$ , the sequence of numbers of colorings of  $K$  by each of the finite quandles. Since we are only considering dihedral quandles for finite quandles, these are ordered by cardinality of the underlying set so that

$$Spec(K) = (\#col_2 K, \#col_3 K, \dots, \#col_r K, \dots)$$

In this way, a “Spectral Theorem” for a knot describes the Spectrum of this knot i.e., the numbers of colorings by each of the labelling quandles in use.

We also define the “Reduced Spectrum of  $K$ ”, denoted  $Spec_{red}(K)$ , to be

$$Spec_{red}(K) = \left( \frac{\#col_2 K}{2}, \frac{\#col_3 K}{3}, \dots, \frac{\#col_r K}{r}, \dots \right)$$

**Definition 2.11** Given two positive integers  $l$  and  $m$ , we let

$$(l, m)$$

stand for the greatest common divisor of  $l$  and  $m$ .

We also let

$$\langle l, m \rangle = \begin{cases} 1, & \text{if } (l, m) = 1 \\ \text{least common prime factor of } l \text{ and } m, & \text{if } (l, m) > 1 \end{cases}$$

### 3 The Spectral Theorem for the $T(2, n)$ knots. Upper bounds on the minimum numbers of colors.

#### 3.1 Calculating $r$ -colorings for $T(2, n)$ knots.

**Theorem 3.1 (The Spectral Theorem for the  $T(2, n)$  Knots)** For each integer  $n \geq 2$ ,

$$\#col_r T(2, n) = (n, r)r$$

for all  $r \geq 2$ .

Proof: Consider the diagram of  $T(2, n)$  given by the closure of  $\sigma_1^n$  ( $\sigma_1 \in B_2$ ) - see Figure 3. Assume further that  $\widehat{\sigma_1^n}$  is endowed with an  $r$ -coloring for some integer  $r \geq 2$ . In order to set up the system of equations whose solutions are the  $r$ -colorings of  $T(2, n)$ , we will state and prove the following:

**Lemma 3.1** Let  $n$  be an integer greater than 2 and assume the diagram  $\widehat{\sigma_1^n}$  is endowed with an  $r$ -coloring for some integer  $r \geq 2$ . If the top segments of the braid  $\sigma_1^n$  ( $\sigma_1 \in B_2$ ) are colored (from left to right) with  $a, b \in \mathbb{R}_r$  then, for each  $i = 1, \dots, n$ , the segment emerging from the  $i$ -th crossing will bear color  $(i + 1)b - ia$  (counting crossings from top to bottom).

Proof: By induction on  $n$ . The  $n = 3$  instance is clear by inspection of figure 3. Assume claim is true for a specific  $n \in \mathbb{N}$ . Juxtaposing another crossing to the previous  $n$  (see figure 4), it is easy to see that the induction step follows. ■

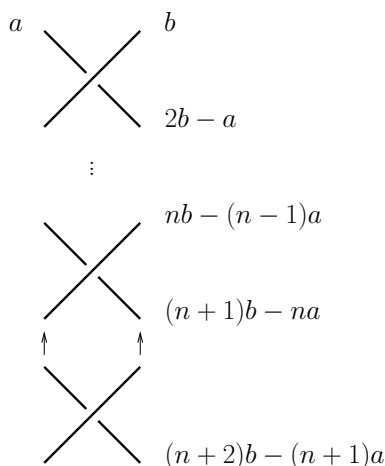

Figure 4: Juxtaposing the  $(n + 1)$ -th crossing

We now return to the proof of the theorem. For  $n$  crossings, the labellings on the bottom segments become  $nb - (n - 1)a$  and  $(n + 1)b - na$  (from left to right). In order for these  $a$  and  $b$  to stand for an  $r$ -coloring, the bottom left labelling has to equal the top left labelling and the bottom right labelling has to equal the top right labelling i.e.,  $nb - (n - 1)a =_r a$  and  $(n + 1)b - na =_r b$  which simplify both to

$$n(b - a) =_r 0$$

So,  $b - a$  has to provide the largest factor of  $r$  which is relatively prime to  $n$  for the equation to hold; this factor is  $\frac{r}{(n, r)}$ . Thus  $b - a$  equals  $\frac{r}{(n, r)}$  or one of its multiples in  $\{1, 2, \dots, r\}$  i.e.,  $b - a$  can be any of the following:

$$\frac{r}{(n, r)}, \quad 2\frac{r}{(n, r)}, \quad 3\frac{r}{(n, r)}, \quad \dots, \quad ((n, r) - 1)\frac{r}{(n, r)}, \quad (n, r)\frac{r}{(n, r)}$$

Finally, there are  $r$  ordered pairs  $(a, b)$  compatible with each of the above  $(n, r)$  possibilities. This statement is justified by the following Lemma.

**Lemma 3.2** For any  $i \in \{0, 1, 2, \dots, r - 1\}$ , there are exactly  $r$  pairs  $(a, b)$  which are solutions to  $b - a =_r i$  ( $a, b \in \{0, 1, 2, \dots, r - 1\}$ ).

Proof: Clearly there are, at least,  $r$  solutions, namely:

$$(0, i), \quad (1, i + 1), \quad \dots, \quad (r - 1, i + r - 1)$$

where the entries in the ordered pairs are taken modulo  $r$ . Now, when we consider the set of all these  $r$  equations,  $\{b - a =_r i\}_{i=0}^{r-1}$ , the set of  $(a, b)$ 's which are solutions to at least one of these equations has, at most,  $r^2$  solutions. Since there are, at least,  $r$  solutions per  $i$  then there are, exactly,  $r$  solutions per  $i$ . ■

Resuming the proof of the theorem, there are  $(n, r)$  possibilities for the  $b - a$  so that the equation  $n(b - a) =_r 0$  holds. Each of these possibilities can be realized in  $r$  distinct ways. There are then  $(n, r)r$  solutions i.e.,  $(n, r)r$   $r$ -colorings of  $T(2, n)$ . ■

**Corollary 3.1** *For each integer  $n \geq 2$ , the determinant of  $T(2, n)$  is  $n$ .*

Proof: The fact that we obtained  $n(b - a) = 0$  for coloring equation in the proof of the preceding theorem means that we were able to simplify the coefficient matrix of the system of equations to upper triangular form with a 0 on the last entry of the diagonal, an  $n$  on the entry before the last of the diagonal, and 1's on all other entries of the diagonal. The determinant of the reduced matrix is then  $n$ . Hence, the determinant of the  $T(2, n)$  is  $n$ . ■

**Corollary 3.2** *The determinant classifies the torus knots of type of  $(2, n)$ .*

Proof: It follows from the fact that the determinant of a knot is an invariant of this knot in conjunction with Corollary 3.1. ■

We now give a second proof of the classification of the  $T(2, n)$  knots by considering the counting of  $r$ -colorings.

**Corollary 3.3** *Given two distinct integers  $(2 <)n < n'$ ,*

$$\#col_n T(2, n) < \#col_{n'} T(2, n')$$

*In particular, any two distinct torus links,  $T(2, n)$  and  $T(2, n')$ , are told apart by their numbers of  $r$ -colorings.*

Proof: Given  $n$  and  $n'$  as in the statement,

$$\#col_n T(2, n) = (n, n')n' < n'n' = (n', n')n' = \#col_{n'} T(2, n')$$

Since the number of  $r$ -colorings is a knot invariant, the statement follows. ■

**Corollary 3.4** *There are nontrivial colorings if, and only if,  $(n, r) \neq 1$ .*

Proof: Omitted. ■

The following result is also included here for completeness:

**Proposition 3.1** *For any integer  $k \geq 1$ ,  $T(2, 2k+1)$  is a 1-component knot and  $T(2, 2k)$  is a 2-component knot. Moreover, the two components of any  $T(2, 2k)$  are linked to each other but each one of them is, per se, a trivial 1-knot.*

Proof: For any integer  $n \geq 2$ , consider the braid  $\sigma_1^n$  ( $\sigma_1 \in B_2$ ). Let 00 be the leftmost point at the top of  $\sigma_1^n$ , 01 be the rightmost point at the top of it; let 10 be the leftmost point at the bottom of  $\sigma_1^n$ , and let 11 be the rightmost point at the bottom of it. 0 and 1 are here regarded as binary digits. In this way, if  $x$  is 0 (1, respect.) then  $\bar{x}$  is 1 (0, respect.). Check Figure 5 for the  $n = 3$  instance.

**Lemma 3.3** *For any integer  $k \geq 1$  consider the diagram  $\sigma_1^{2k+1}$  ( $\sigma_1 \in B_2$ ). For any  $x \in \{0, 1\}$ , starting at  $0x$  and progressing downwards along the diagram we arrive at  $1\bar{x}$ .*

Proof: The  $k = 1$  instance is visualized in Figure 5. Assume the statement is true for a generic  $k$ . Juxtaposing  $\sigma_1^2$  to  $\sigma_1^{2k+1}$  it is easy to see that the induction step follows. This proves the lemma. ■

Roughly speaking, what this lemma proves is that if one goes along the  $\sigma_1^{2k+1}$  braid starting from one side at the top one gets to the bottom on the other side. Upon closure of the braid, one continues travelling along the knot going up around the back of the braid on this other side, then down along the braid to the side one previously started on and finally up around the back to the original point. In particular,  $T(2, 2k + 1)$  is a 1-component knot.

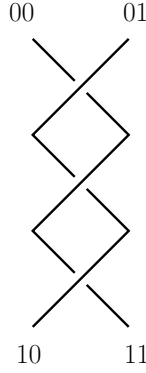

Figure 5: The 00, 01, 10, and 11 points on  $\sigma_1^3$

**Lemma 3.4** For any integer  $k \geq 1$  consider the diagram  $\sigma_1^{2k}$  ( $\sigma_1 \in B_2$ ). For any  $x \in \{0, 1\}$ , starting at  $0x$  and progressing downwards along the diagram we arrive at  $1x$ .

Proof: Omitted. ■

Noting that at each horizontal level there are exactly two points, then the preceding Lemma implies that there are two components in the closure of  $T(2, 2k)$  for any integer  $k \geq 2$  i.e.,  $T(2, 2k)$  is a 2-component knot.

**Lemma 3.5** For any integer  $k \geq 1$  consider the diagram  $\sigma_1^{2k}$  ( $\sigma_1 \in B_2$ ). For any  $x \in \{0, 1\}$ , If we remove the arc that connects  $0x$  to  $1x$  on  $\sigma_1^{2k}$ , we are left with an arc which is deformable to a straight line connecting points  $0x$  to  $1x$ .

Proof: By induction. We leave the straightforward details to the reader. ■

Resuming the proof of the Proposition, the preceding Lemma implies that the 2-component knot obtained from the closure of  $\sigma_1^{2k}$  is formed by components which are unknotted. This proves the last statement in the Proposition. We now prove that these two components are linked. As a matter of fact, if they were not linked then there would be a diagram of  $T(2, 2k)$  made up of two disjoint unknotted circles. The number of  $r$ -colorings of  $T(2, 2k)$  would then be  $r^2$  for any integer  $r \geq 2$ . This contradicts the formula established in Theorem 3.1:

$$\#col_r T(2, 2k) = (2k, r)r$$

at least for all primes  $r$  greater than  $2k$ . This concludes the proof of the Proposition. ■

Leaning on Theorem 3.1, we give a brief description of the spectrum of  $T(2, n)$ , for an integer  $n \geq 2$ . At each  $r$  such that  $r|n$  there are  $r^2$  colorings; at each  $r$  such that  $(n, r) = 1$  there are  $r$  (trivial) colorings; and, as  $r$  increases beyond  $n$ , at each  $r$  which is a multiple of a power of  $n$  there are  $nr$  colorings. At all other  $r$ , the number of colorings satisfies:

$$r < \#col_r T(2, n) = (n, r)r < nr$$

The spectrum of  $T(2, n)$  is in general restricted to the sector between and including the lines through the origin with slopes 1 and  $n$ , except for those  $r$  that divide  $n$ ; at each of these  $r$ 's that divide  $n$ , the number of colorings is  $r^2$ . The Reduced Spectrum of  $T(2, 7)$ ,  $T(2, 8)$ ,  $T(2, 9)$ , and  $T(2, 15)$  is shown in Figures 6, 7, 8, 9. In the Reduced Spectrum we associate  $\#col_r T(2, n)/r$  to each  $r$ .

### 3.2 Minimizing numbers of colors

We now look into the minimum number of distinct colors needed to produce a non-trivial  $r$ -coloring of  $T(2, n)$ . We use the following

**Definition 3.1** Given an integer  $r > 1$ , assume there are non-trivial  $r$ -colorings on a given knot  $K$ . Assume further that  $D$  is a diagram of  $K$ . We let  $n_{r,K}(D)$  denote the minimum number of distinct colors



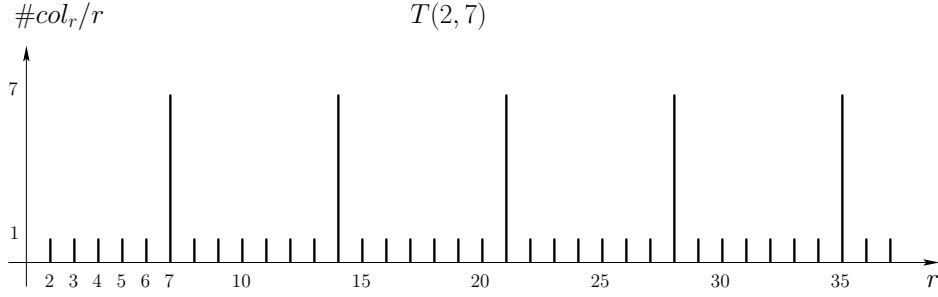

Figure 6: Part of the Reduced Spectrum of  $T(2, 7)$

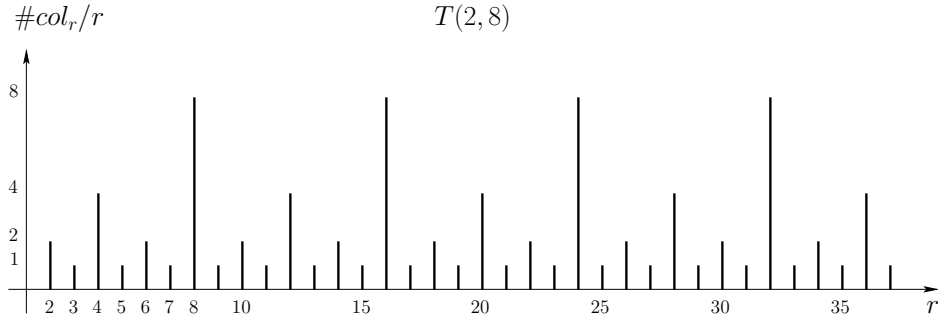

Figure 7: Part of the Reduced Spectrum of  $T(2, 8)$

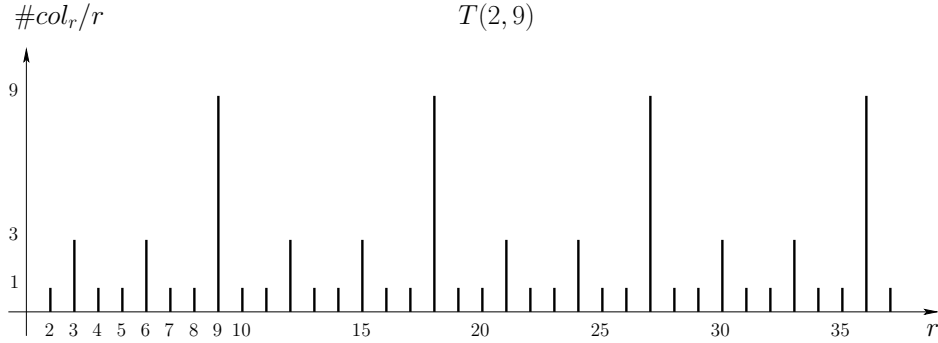

Figure 8: Part of the Reduced Spectrum of  $T(2, 9)$

assigned to the arcs of  $D$  it takes to produce a non-trivial  $r$ -coloring on  $D$ . We denote  $\text{mincol}_r K$  the minimum of these minima over all diagrams  $D$  of  $K$ :

$$\text{mincol}_r K := \min\{n_{r,K}(D) \mid D \text{ is a diagram of } K\}$$

Note that  $\text{mincol}_r K$  is tautologically a topological invariant of  $K$ .

The following theorem presents an upper bound for  $\text{mincol}_r T(2, n)$ . We remark that, given two positive integers  $l$  and  $m$ ,  $\langle l, m \rangle$  stands for the least common prime factor of  $l$  and  $m$  - which may be 1 (see Definition 2.11).

**Theorem 3.2** *Let  $n$  and  $r$  be positive integers greater than 1. If  $(n, r) = 1$  there are only trivial  $r$ -colorings of  $T(2, n)$ . If  $(n, r) > 1$ ,*

$$\text{mincol}_r T(2, n) \leq \langle n, r \rangle$$

Proof: If  $(n, r) = 1$  then, by the Spectral Theorem (Theorem 3.1), the number of  $r$ -colorings is  $r$ . These are necessarily the trivial  $r$ -colorings.

If  $(n, r) > 1$  set

$$p = \langle n, r \rangle$$

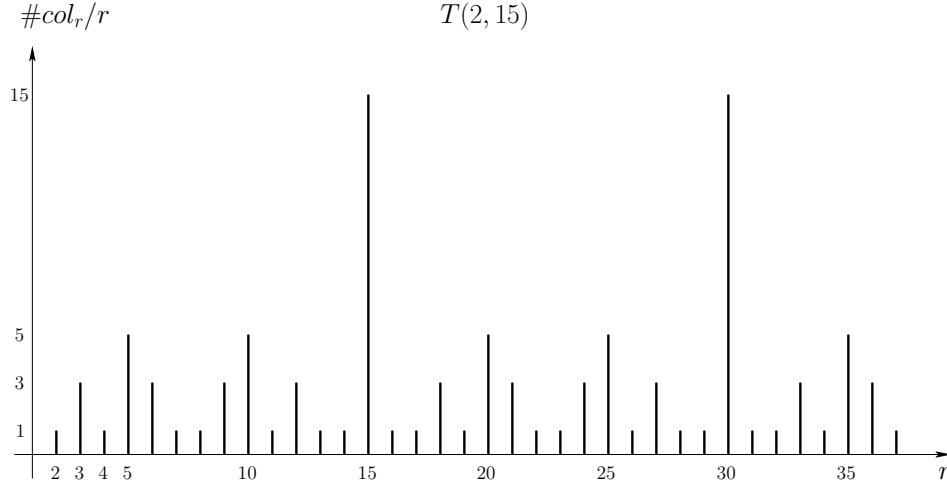

Figure 9: Part of the Reduced Spectrum of  $T(2, 15)$

The set

$$\left\{ 0, \frac{r}{p}, 2 \frac{r}{p}, \dots, (p-1) \frac{r}{p} \right\}$$

endowed with the  $a * b = 2b - a \pmod{r}$  operation is a subquandle of  $R_r$ , call it  $R_r^p$ . As a quandle,  $R_r^p$  is isomorphic with  $R_p$ . Also note that, in this  $p = \langle n, r \rangle > 1$  case, the  $\sigma_1^n$  braid ( $\sigma_1 \in B_2$ ), whose closure gives a knot diagram for  $T(2, n)$ , can be regarded as a product of  $\frac{n}{p}$   $\sigma_1^p$ 's:

$$\underbrace{\sigma_1^p \cdots \sigma_1^p}_{\frac{n}{p} \text{ factors}}$$

This reflects on the coloring equation:

$$0 =_r n(b-a) =_r \frac{n}{p} \cdot p(b-a)$$

Hence, any two  $a, b$  from  $R_r^p$  yield an  $r$ -coloring of  $\widehat{\sigma_1^n}$ . We have, thus,  $p^2$   $r$ -colorings from  $R_r^p$ . Note, also, that any of these  $a, b$  from  $R_r^p$  yield an  $r$ -coloring of  $\widehat{\sigma_1^p}$ , since they satisfy

$$0 =_r p(b-a)$$

We can, thus, regard some non-trivial  $r$ -colorings of  $\widehat{\sigma_1^n}$  as stackings of  $\frac{n}{p}$   $p$ -colorings of  $\widehat{\sigma_1^p}$  (see Figure 10). Now, each of the non-trivial  $p$ -colorings of  $\widehat{\sigma_1^p}$  uses exactly  $p$  distinct colors thanks to the following lemma:

**Lemma 3.6** *If  $p$  is prime then each non-trivial  $p$ -coloring of  $\widehat{\sigma_1^p}$  uses exactly  $p$  distinct colors.*

Proof: Pick  $a, b \in R_p$ , distinct. Suppose there exist  $i, j \in \{0, \dots, p-1\}$  such that  $ib - (i-1)a =_p jb - (j-1)a$ . Then  $(i-j)(b-a) =_p 0$  which is equivalent to saying that  $i = j$ , for  $\mathbb{Z}_p$  is a field. ■

Hence, given positive integers  $n$  and  $r$  such that  $\langle n, r \rangle > 1$  we constructed a non-trivial  $r$ -coloring of  $T(2, n)$  which uses exactly  $\langle n, r \rangle$  colorings.  $\langle n, r \rangle$  is then an upper bound for  $\text{mincol}_r T(2, n)$ . This concludes the proof. ■

## 4 Some minima.

### Improvements on other upper bounds: Teneva Reduction.

#### Conjecture on the minima.

##### 4.1 Calculating some minima.

We now calculate  $\text{mincol}_r(K)$  for some  $r$ 's and for some knots,  $K$ , from  $\{T(2, n) \mid n = 2, 3, 4, \dots\}$ .

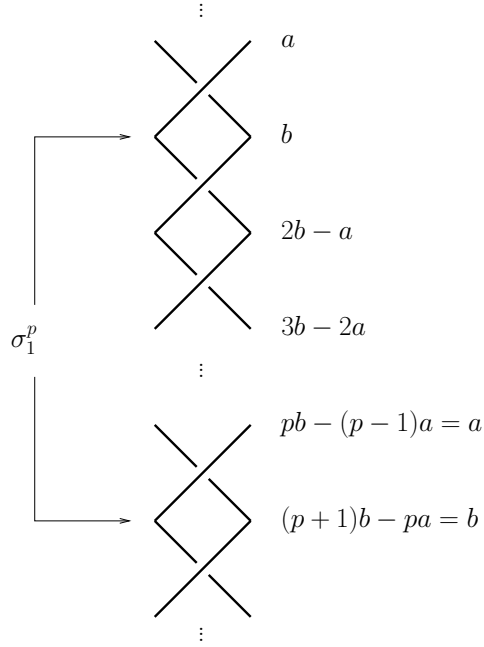

Figure 10: Coloring of  $\sigma_1^p$  inside coloring of  $\sigma_1^n$

**Theorem 4.1** For even positive integers  $n$  and  $r$

$$\text{mincol}_r T(2, n) = 2$$

Proof: For even positive integers  $n$  and  $r$ ,  $\langle n, r \rangle = 2$ . Then, by Theorem 3.2,

$$\text{mincol}_r T(2, n) \leq 2$$

Since a nontrivial coloring has to use at least two distinct colors, the result follows.  $\blacksquare$

We remind again the reader that we call trivial coloring any coloring which assigns the same color to each arc of the diagram under study. We remark that this implies that a trivial knot of more than one component can be assigned non-trivial colorings. In order to see this, consider a diagram of this knot where one component lies in a neighborhood which is disjoint from a neighborhood which contains the rest of the diagram. Color the singled out component with color  $a$  and the rest of diagram with color  $b (\neq a)$  - this is a non-trivial coloring of this trivial knot. Note further that this type of phenomenon does not occur for one component knots. In fact, a trivial knot with only one component has a diagram with no crossings. Any coloring of this diagram can only have one color - hence any other of this knot's diagrams is colored with only one color.

**Theorem 4.2** For positive integers  $n$  and  $r$  such that  $\langle n, r \rangle = 3$ ,

$$\text{mincol}_r T(2, n) = 3$$

Proof: Since  $\langle n, r \rangle = 3$ , then there is an  $r$ -coloring of  $T(2, n)$  with as few as three colors by the proof of Theorem 3.2. We next prove that two distinct colors are not enough to produce a non-trivial coloring in the  $\langle n, r \rangle = 3$  case. We consider two possibilities: odd  $r$  and even  $r$ .

Suppose  $r$  is odd and  $a, b \in R_r$ . If  $b = a * b (= 2b - a)$  then  $a = b$ ; if  $a = a * b (= 2b - a)$  then  $2b = 2a$  which is equivalent to saying  $a = b$  since  $r$  is odd (hence 2 is invertible). Thus if we choose distinct  $a, b$  from  $R_r$  then  $\#\{a, b, a * b\} = 3$  and so any non-trivial  $r$ -coloring of  $T(2, n)$ , for odd  $r$ , has at least three colors. This concludes the proof for odd  $r$ .

Suppose  $r$  is even; then  $n$  is odd for otherwise  $\langle n, r \rangle = 2$ . Assume there is an  $r$ -coloring of a diagram  $D$  of  $T(2, n)$  which uses exactly two distinct colors, say  $a, b$ . At some crossing of the diagram the two colors meet. The possibilities for the color on the emerging arc are as follows. Either  $b = a * b (= 2b - a)$  i.e.,  $a = b$  which is contrary to the assumption; or  $a = a * b (= 2b - a)$  i.e.,  $a = b + \frac{r}{2}$ . Hence,

$b * a = 2a - b = 2(b + \frac{r}{2}) - b = b \pmod r$ . Thus, the subquandle of  $R_r$  generated by  $b$  and  $a = b + \frac{r}{2}$  is formed by exactly  $a$  and  $b$ , when  $r$  is even. Consider again the diagram  $D$  endowed with the indicated coloring which uses only the two colors  $a$  and  $b$ . By performing Reidemeister moves and consistently changing the colors after each move (cf. [10]) we obtain a new diagram of  $T(2, n)$  endowed with a coloring which uses only the two colors  $a$  and  $b$  - because  $\{a, b\}$  constitute an algebraically closed set with respect to the  $*$ -operation, as was seen above.

In particular, we could transform  $D$  into  $\widehat{\sigma}_1^n$  upon performance of Reidemeister moves and the associated coloring (obtained by consistently changing the colorings after each Reidemeister move) would use exactly two colors. We now prove that  $\widehat{\sigma}_1^n$  cannot be colored with only two colors - because  $n$  is odd. As a matter of fact, starting with distinct  $a$  and  $b$  from  $R_r$  at the top segments of  $\sigma_1^n$  (from left to right) we obtain, using induction,  $b, a$  (from left to right) after an odd number of crossings. This concludes the proof. ■

**Definition 4.1 (Splittable knot)** *We say that a knot,  $K$ , is **splittable** if there exist two disjoint neighborhoods in  $\mathbb{R}^3$ , say  $N_1$  and  $N_2$ , such that*

$$K \subset N_1 \cup N_2 \quad \text{and} \quad N_1 \cap K \neq \emptyset \neq N_2 \cap K$$

We remark that the proof of Theorem 4.2 yields a stronger result than the statement of the Theorem. Specifically,

**Corollary 4.1** *Let  $r$  be an integer greater than 1.*

- *If  $r$  is odd and if  $K$  is not splittable then,*
  - $\text{mincol}_r K > 2$
- *If  $r$  is even and  $K$  is not splittable then,*
  - *a specific diagram of  $K$  admits an  $r$ -coloring with exactly two colors if, and only if, any other diagram of  $K$  admits an  $r$ -coloring with exactly two colors*

Proof: Omitted. ■

In particular,

**Corollary 4.2** *If  $\langle n, r \rangle$  is an odd prime then:*

$$\text{mincol}_r T(2, n) > 2$$

Proof: If  $r$  is odd, the statement of this Corollary is a particular case of the first statement of Corollary 4.1. If  $r$  is even, then  $n$  is odd. In particular,  $T(2, n)$  is a 1-component knot, by Proposition 3.1, and so the second statement of Corollary 4.1 applies. Repeating an argument used in the proof of Theorem 4.2 we see that the closure of  $\sigma_1^n$  cannot have an  $r$ -coloring with just two colors, since  $n$  is odd. Whence no diagram of  $T(2, n)$  can have an  $r$ -coloring with just two colors. This concludes the proof. ■

## 4.2 Teneva Transformations.

The results we obtained on  $\text{mincol}_r T(2, n)$ , so far, relied on the features of modular arithmetic. We will now come up with better estimates for  $\text{mincol}_r T(2, n)$  by making use of Reidemeister moves. In particular, we will obtain diagrams endowed with non-trivial colorings that use less colors than the ones considered so far although these diagrams have more arcs. In order to obtain these diagrams we will use what we call Teneva Transformation. This a particular sequence of Reidemeister moves, starting from the  $\widehat{\sigma}_1^n$  diagram of  $T(2, n)$  endowed with a non-trivial coloring and consistently coloring the diagrams after each move, in the sense introduced in [10]. This formalizes and generalizes a particular case due to Irina Teneva presented in [6].

Specifically, we now establish that, for any odd prime  $p = 2k + 1$  (for some positive integer  $k$ ),

$$\text{mincol}_p T(2, p) \leq k + 2$$

In order to do this we will prove that, for any positive integer  $k$ ,  $\text{mincol}_{2k+1}T(2, 2k+1) \leq k+2$ . Of course, for non-prime  $2k+1$ , Theorem 3.2 presents a strictly smaller upper bound but in this way we are able to use induction on  $k$  thus establishing the  $k+2$  upper bound also for prime  $p = 2k+1$ . This is a better estimate than the Theorem's, in the prime  $p$  situation. We remark, in passing, that, for any positive integer  $k$ ,  $k+2$  is also an upper bound for  $\text{mincol}_{2k}T(2, 2k)$ ; again in this case, Theorem 3.2 presents a strictly smaller upper bound.

In order to prove that  $k+2$  is an upper bound, as referred to above, we consider the diagram of the torus knot  $T(2, 2k+1)$  (for  $k > 1$ ) as given by the braid closure of  $\sigma_1^{2k+1}$  ( $\sigma_1 \in B_2$ ) and endowed with a non-trivial  $(2k+1)$ -coloring. This coloring is represented by assigning  $a, b \in R_{2k+1}$  ( $a \neq b$ ) to the top segments of the braid  $\sigma_1^{2k+1}$  in the usual manner. Since  $2k+1$  is the number of arcs of  $\sigma_1^{2k+1}$  there are, at most,  $2k+1$  colors in this coloring. If  $a = 0$  and  $b = 1$  then there are exactly  $2k+1$  colors. If  $2k+1$  is prime then there are exactly  $2k+1$  colors whenever  $a \neq b$ , thanks to Lemma 3.6. We, thus, assume that, for each  $k$ , the coloring in point uses  $2k+1$  colors. We then perform  $1+k$  Reidemeister moves on the diagrams, consistently changing the coloring assignments after each move (cf. [10]), eventually obtaining a coloring assignment with  $k+2$  colors.

We exemplify for  $k = 2$  starting from the diagram of  $T(2, 5)$  given by the closure of  $\sigma_1^{2 \cdot 2+1}$  and endowed with an  $r$ -coloring as indicated (see Figure 11). The dotted lines indicate where the arc in point is taken to by the next move. There are  $1+2 = 3$  moves. The first one is a type I Reidemeister move on the arc labeled  $a$  in the bottom right of the first diagram in figure 11; the two other moves are type III Reidemeister moves. The first of these two type III Reidemeister moves moves the arc labeled  $a$  (which stems from the bottom left of the second diagram) over a crossing above it in the manner indicated in figure 11 (dotted lines in the second diagram). Color  $2b-a$  is introduced with this move but since it was already part of the coloring, the number of colors remains the same. The second type III Reidemeister move moves the arc we just referred to over the crossing right above it. With this move color  $3b-2a$  is introduced and color  $4b-3a$  is removed. Since color  $3b-2a$  was already part of the coloring and there was only one arc assigned color  $4b-3a$ , this move reduces the number of colors by one. We end up thus with  $5-1 = k+2$  colors for  $k = 2$  as announced.

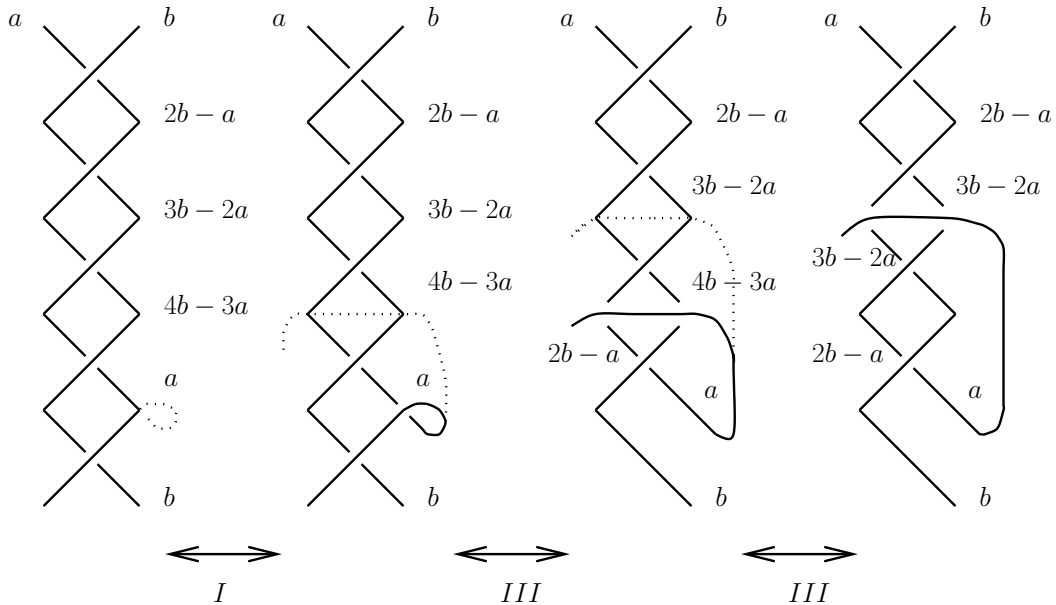

Figure 11: Colored  $T(2, 5)$ : from 5 to 4 colors

For a general integer  $k > 1$ , there are  $1+k$  moves on  $\sigma_1^{2k+1}$  with the first three as indicated for  $T(2, 5)$ , in figure 11. As of the third, each move will be analogous to the previous one, the arc in point being pulled up over one crossing at a time. As with  $T(2, 5)$ , the first two moves will not affect the number of colors used. The third move will remove color  $(2k)b - (2k-1)a$ , the fourth move will remove color  $(2k-1)b - (2k-2)a, \dots$ , the  $k$ -th move will remove color  $(k+3)b - (k+2)a$ , and the  $(k+1)$ -th move will remove color  $(k+2)b - (k+1)a$ . Analogous remarks apply for the even  $n = 2k$  case. We then state:

**Proposition 4.1 (Teneva Reduction)** For any integer  $k > 1$ ,

$$\text{mincol}_{2k+1}T(2, 2k+1) \leq k+2$$

Before embarking on the proof of this proposition we will first state and prove a technical lemma which will help us deal with it.

**Lemma 4.1 (Teneva Transformation)** For each integer  $n \geq 3$ , consider  $\sigma_1^n$  ( $\sigma_1 \in B_2$ ) such that  $\widehat{\sigma_1^n}$  is endowed with an  $n$ -coloring as in Lemma 3.1 using  $n$  distinct colors (see discussion above). Then,  $n-1$  type III Reidemeister moves are performed, taking the bottom left arc of the braid over each crossing above it until the top of the braid is reached. These type III Reidemeister moves are preceded by a type I Reidemeister move which prepares the setting for the subsequent moves (see left-most braid in figure 11, for the  $n = 5$  instance). The diagrams are consistently colored after each move. We keep the notation of Lemma 3.1.

The first type III Reidemeister move introduces color  $(n+2)b - (n+1)a$  on the left-hand side of the diagram. For  $2 \leq i \leq n-1$ , the  $i$ -th type III Reidemeister move removes color  $(n+1-i)b - (n-i)a$  from the right-hand side of the diagram and introduces color  $(n+1+i)b - (n+i)a$  on the left-hand side of the diagram.

Proof: We use induction on  $n$ . For  $n = 3$ , see figure 12.

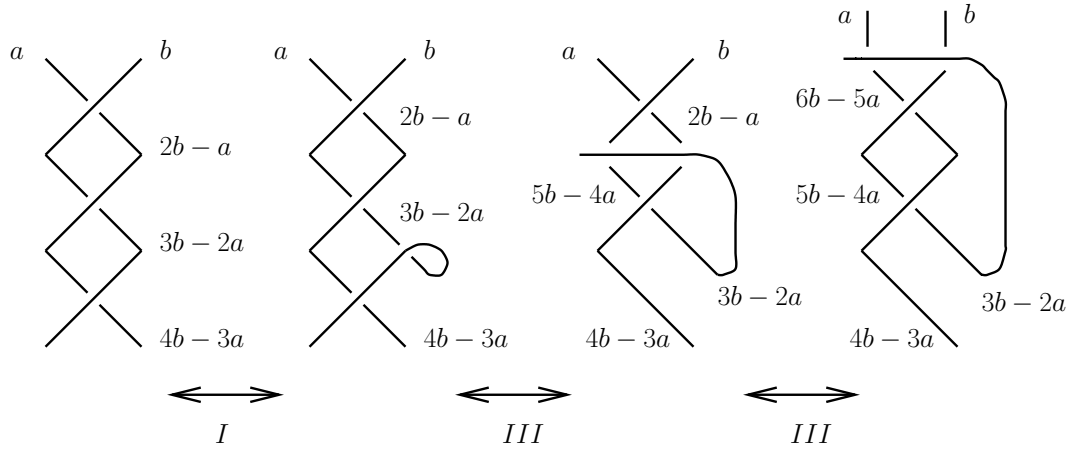

Figure 12: The  $n = 3$  instance

Now assume the claim is true for a specific integer  $n \geq 3$  and consider the  $n+1$  situation (see figure 13). Neglecting the top  $\sigma_1$ , there is a string of  $n$   $\sigma_1$ 's with the top segments colored with  $a', b' \in R_r$  (with  $a' = b$  and  $b' = 2b - a$ ). Hence we can apply the induction hypothesis to say that the first type III Reidemeister move introduces color  $(n+2)b' - (n+1)a'$  ( $= (n+3)b - (n+2)a$ ) and, for  $2 \leq i \leq n-1$ , the  $i$ -th type III Reidemeister move removes color  $(n+1-i)b' - (n-i)a'$  ( $= (n+2-i)b - (n+1-i)a$ ) from the right-hand side of the diagram and introduces color  $(n+1+i)b' - (n+i)a'$  ( $= (n+2+i)b - (n+1+i)a$ ). The  $n$ -th type III Reidemeister move removes color  $2b - a$  and introduces color  $(2n+2)b - (2n+1)a$ . Hence, the claim follows. ■

Proof (of Proposition 4.1): For some integer  $k > 1$ , consider a non-trivial  $(2k+1)$ -coloring of  $\widehat{\sigma_1^{2k+1}}$ , using all  $2k+1$  colors, as in the statement of the Proposition. Lemma 4.1, specialized to  $n = 2k+1$  and reading colors mod  $2k+1$ , implies that, for  $2 \leq i \leq 2k$ , the  $i$ -th type III Reidemeister move removes color  $(2k+2-i)b - (2k+1-i)a$  and introduces color  $(i+1)b - ia$ . Write the set of colors in the original coloring of  $\sigma_1^{2k+1}$  in the following way:

$$\begin{aligned} & \{a, b\} \cup \{2b - a\} \cup \{3b - 2a, 4b - 3a, \dots, kb - (k-1)a, (k+1)b - ka\} \cup \\ & \cup \{(k+2)b - (k+1)a, (k+3)b - (k+2)a, \dots, (2k-1)b - (2k-2)a, 2kb - (2k-1)a\} \end{aligned}$$

The set  $\{3b - 2a, 4b - 3a, \dots, kb - (k-1)a, (k+1)b - ka\}$  contains the colors that are introduced from the performance of type III Reidemeister moves  $i = 2$  through  $k$ ; these colors were already in

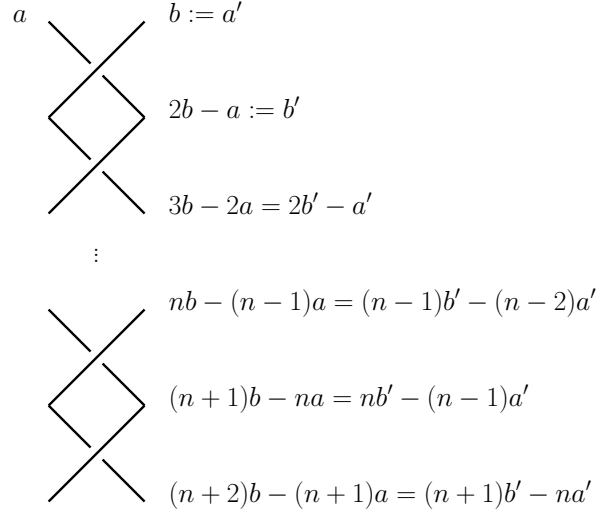

Figure 13: The assignment of colors to the  $\sigma_1^{n+1}$  braid

the diagram so after these  $k - 1$  moves there are two of each. The set  $\{(k + 2)b - (k + 1)a, (k + 3)b - (k + 2)a, \dots, (2k - 1)b - (2k - 2)a, 2kb - (2k - 1)a\}$  contains the colors that are removed from the performance of type III Reidemeister moves  $i = 2$  through  $k$ . Only one of each of the colors in this latter set was in the coloring of the diagram before the performance of these  $k - 1$  moves. Then, after these  $k - 1$  moves, there are none of these colors in the coloring of the resulting diagram. In this way, after the type III Reidemeister move corresponding to  $i = k$  is performed there are  $k - 1 = \#\{(k + 2)b - (k + 1)a, (k + 3)b - (k + 2)a, \dots, (2k - 1)b - (2k - 2)a, 2kb - (2k - 1)a\}$  less colors than in the original diagram i.e., there are only  $2k + 1 - (k - 1) = k + 2$  colors. The result follows. (Note, in passing, that, as of this  $i = k$  type III Reidemeister move, the colors removed are the ones that there are in two's and the colors introduced are the ones that were previously removed, so as of this move the number of colors in the colorings of the diagrams increases). ■

We remark that, for prime  $p = 2k + 1$  and  $r$  divisible by  $p$  then

$$\text{mincol}_r T(2, p) \leq k + 2$$

since  $\left\{0, \frac{r}{p}, 2\frac{r}{p}, \dots, (p - 1)\frac{r}{p}\right\}$  endowed with the  $a * b = 2b - a \pmod{r}$  operation is a subquandle,  $R_r^p$ , of  $R_r$  isomorphic with  $R_p$ . Moreover, if  $(n, r) > 1$  and  $\langle n, r \rangle = p (= 2k + 1)$ , for some positive integer  $k$ , then we regard  $T(2, n)$  as the closure of a stacking of  $\sigma_1^p$ 's, each one of each is non-trivially colored by  $R_r^p \subset R_r$ . Teneva Reduction (Proposition 4.1) can now be applied to each  $\sigma_1^p$  to reduce the number of colors from  $2k + 1$  to  $k + 2$ . In this way:

**Theorem 4.3** *Suppose  $r$  and  $n$  are positive integers such that  $(n, r) > 1$ .*

- *If  $\langle n, r \rangle \in \{2, 3\}$ , then:*

$$\text{mincol}_r T(2, n) = \langle n, r \rangle$$

- *If  $\langle n, r \rangle = 2k + 1$ , for some integer  $k > 1$ , then:*

$$\text{mincol}_r T(2, n) \leq k + 2$$

Proof: Omitted. ■

Furthermore, we conjecture the upper bound in Theorem 4.3 to be the actual minimum:

**Conjecture 4.1** *Suppose  $r$  and  $n$  are positive integers such that  $(n, r) > 1$ . Let  $\langle n, r \rangle = 2k + 1$ , for some integer  $k > 1$ . Then:*

$$\text{mincol}_r T(2, n) = k + 2$$

Note that we call Teneva Transformation (Lemma 4.1) a finite sequence of moves on knot diagrams endowed with colorings. This transformation introduces some colors and removes other colors in the colorings. We call this transformation Teneva Reduction (Proposition 4.1) when the net effect of the Teneva Transformation is to decrease the number of colors used in the coloring.

Note also that a Teneva Transformation can be applied to a portion of a knot diagram endowed with a coloring such that this portion of the diagram looks like a  $\sigma_1^n$  ( $\sigma_1 \in B_2$ ). If the net effect of the Teneva Transformation on the braid-like portion of the diagram is to decrease the number of colors used in the whole diagram, we call it also Teneva Reduction (see 5.2).

## 5 Another minimum.

### Illustrative examples of Teneva Reduction on rational knots.

#### 5.1 Proof of the $k = 2$ instance of Conjecture 4.1.

Our proof of the statement in the title of this subsection relies on understanding how the multiplication table of a subset of three elements from  $R_r$  can be realized for a general integer  $r > 2$ . For each of the realizations we will then inquire into whether this subset with the indicated table can give rise to a coloring of a  $T(2, n)$  or not.

Suppose we are given distinct  $a, b, c \in \{0, 1, 2, \dots, r-1\}$ . We construct their multiplication table, as a subset of  $R_r$ , by considering the four possibilities on the value of  $2b - a$ :

1.  $2b - a =_r b$  ;
2.  $2b - a =_r a$  ;
3.  $2b - a =_r c$  ;
4.  $2b - a \notin \{a, b, c\} \pmod r$

Some of these four possibilities enclose further ramifications. In the sequel we will drop the index  $r$  and the expression  $\pmod r$  but the equalities and belonging to a set are still supposed to be understood  $\pmod r$ .

1. Suppose first that  $2b - a = b$ . Then  $a = b$  which contradicts the assumption that  $a, b, c$  are distinct.

As of now we will systematically discard the possibilities of the type  $2y - x = y$  since they lead to equality between two of the given elements thus contradicting the assumption.

2. Assume now that  $2b - a = a$ . Then  $2(b - a) = 0$ . If  $r$  is odd this amounts to saying that  $a = b$  which contradicts the hypothesis. If  $r$  is **even** then we obtain  $b = a + \frac{r}{2}$ . We also obtain in this situation that  $2a - b = b$ ,  $2a = 2b$  and  $2a - c = 2b - c$ .

In the sequel, when an equation of the sort  $2(x - y) = 0$ , for even  $r$ , appears we will conclude that  $x = y + \frac{r}{2}$  plus the preceding observations without further explanations.

Let us now focus on the possibilities for  $2a - c$ .

- (a) If  $b = 2a - c = 2b - c$  then  $b = c$  which contradicts the original assumption.
- (b) If  $2a - c = c$  then  $c = a + \frac{r}{2} = b$  which again contradicts the original assumption.
- (c) So  $2a - c = 2b - c \notin \{a, b, c\}$ .

Now for the possibilities for  $2c - a$ :

- i. If  $2c - a = a$  then  $c = a + \frac{r}{2} = b$  which contradicts the assumption
- ii. If  $2c - a = b$  then  $2c - b = a$  and  $2c = a + b = 2a + \frac{r}{2}$  which implies that  $\frac{r}{2}$  has to be even in order for this equation to have non-trivial solutions. These will then be:
  - A.  $c = a + \frac{r}{4}$
  - B.  $c = a + \frac{3r}{4}$

In either case  $c \notin \{a, b\}$
- iii. If  $2c - a \notin \{a, b, c\}$  then  $2c - b \neq a$ . Moreover,  $2c - b \neq b$  for otherwise it would contradict 2c, above. So,  $2c - b \notin \{a, b, c\}$



	$a$	$b$	$c$
$a$	$a$	$a$	$b$
$b$	$b$	$b$	$a$
$c$	X	X	$c$

Table 5.1: Multiplication table for the, even  $r$ ,  $2b - a = a$  and  $2c - a = a$  case

	$a$	$b$	$c$
$a$	$a$	$a$	X
$b$	$b$	$b$	X
$c$	X	X	$c$

Table 5.2: Multiplication table for the, even  $r$ ,  $2b - a = a$  and  $2c - a$  not in  $\{a, b, c\}$  case

With this information, the multiplication table for  $\{a, b, c\}$  for the  $2b - a = a, 2c - a = b$  situation is displayed in Table 5.1, and for the  $2b - a = a, 2c - a \notin \{a, b, c\}$  situation it is displayed in Table 5.2. The symbol “X” means that the value in that box does not belong to  $\{a, b, c\}$ . Note that, in both Table 5.1 and Table 5.2, the only entry from  $\{a, b, c\}$  in the row corresponding to  $c$  is  $c$ . In terms of colorings this means that, when using these three colors in order to color a knot diagram, the color  $c$  will never be assigned to an under-arc. But in a 1-component knot any over-arc will at some point become an under-arc. Since we are assuming the three colors are being used, the current situation does not correspond to a coloring of a 1-component knot. Note that this argument applies whenever there is a row with only one entry from  $\{a, b, c\}$ . That at least one entry from this set has to appear is a consequence of the idempotency axiom ( $x * x = x$ ).

3. Consider now that  $2b - a = c$ . Then  $2b - c = a$

(a) If  $2c - a = a$  then  $r$  is even,  $c = a + \frac{r}{2}$ ,  $2a = 2c$ , and  $2a - c = c$

i. If  $2a - b = b$  then  $b = a + \frac{r}{2} = c$  which conflicts with the original assumption

ii. If  $2a - b = c$  then  $2a - c = b$  which conflicts with a conclusion in 3a

iii. Then  $2a - b \notin \{a, b, c\}$

A. If  $2c - b = b$  then  $a = c$  which contradicts the original assumption

B. If  $2c - b = a$  then  $2c - a = b$  which conflicts with a conclusion in 3a

C. Then  $2c - b \notin \{a, b, c\}$

With this information, the multiplication table for  $\{a, b, c\}$  for the  $2b - a = c, 2c - a = a$  situation is displayed in Table 5.3. The symbol “X” has the same meaning as in the

	$a$	$b$	$c$
$a$	$a$	$c$	$a$
$b$	X	$b$	X
$c$	$c$	$a$	$c$

Table 5.3: Multiplication table for the, even  $r$ ,  $2b - a = c$ , and  $2c - a = a$  case

preceding tables.

(b) If  $2c - a = b$  then  $2c - b = a$ . Moreover, adding  $2b - c = a$  and  $2c - b = a$  we obtain  $2a - b = c$  and  $2a - c = b$ ; whereas subtracting those two expressions we obtain  $0 = 3(b - c)$  which implies that  $3|r$  in order to be possible for  $b$  and  $c$  to be distinct.

The multiplication table for this situation is displayed in Table 5.4

(c) If  $2c - a \notin \{a, b, c\}$  then  $2c \neq 2a$ ,  $2c - b \neq a$

i. If  $2c - b = b$  then  $2b - c = c$  which contradicts a conclusion in 3.

	$a$	$b$	$c$
$a$	$a$	$c$	$b$
$b$	$c$	$b$	$a$
$c$	$b$	$a$	$c$

Table 5.4: Multiplication table for the  $2b - a = c$ , and  $2c - a = b$  case

- ii. So  $2c - b \notin \{a, b, c\}$ , then  $2c \neq 2b$ ,  $2c - a \neq b$
- A. If  $2a - c = c$  then  $2c - a = a$  which contradicts  $3c$ .
  - B. If  $2a - c = b$  then  $2a - b = c$ . Adding  $2b - a = c$  to  $2a - b = c$  we obtain  $2c - a = b$  which conflicts with  $3c$ .
  - C. Then  $2a - c \notin \{a, b, c\}$ , so  $2a - b \neq c$ 
    - If  $2a - b = b$  then  $2b - a = a$  which conflicts with  $3$ .
    - So  $2a - b \notin \{a, b, c\}$

The corresponding table is displayed in Table 5.5

	$a$	$b$	$c$
$a$	$a$	$c$	X
$b$	X	$b$	X
$c$	X	$a$	$c$

Table 5.5: Multiplication table for the  $2b - a = c$ , and  $2c - a$  not in  $\{a, b, c\}$  case

4. Assume finally that  $2b - a \notin \{a, b, c\}$ . Then  $2b \neq 2a$ ,  $2a - b \neq a$ , and  $2b - c \neq a$
- (a) If  $2b - c = c$  then  $r$  is **even** and  $2c - 2b = 0$ . Adding this equation to  $2b - a = e$  where  $e \notin \{a, b, c\}$  we obtain  $2c - a \notin \{a, b, c\}$ . Then  $2c \neq 2a$ ,  $2c - b \neq a$ 
    - i. If  $2a - b = c$  then  $2a - c = b$  and the multiplication table is displayed in Table 5.6

	$a$	$b$	$c$
$a$	$a$	X	X
$b$	$c$	$b$	$b$
$c$	$b$	$c$	$c$

Table 5.6: Multiplication table for the, even  $r$ ,  $2b - a$  not in  $\{a, b, c\}$ ,  $2b - c = c$ , and  $2a - b = c$  case

- ii. If  $2a - b \notin \{a, b, c\}$  then  $2a - c \neq b$ 
  - A. If  $2a - c = c$  then  $2a = 2c$  which contradicts a conclusion in 4a.
  - B. So  $2a - c \notin \{a, b, c\}$  and the multiplication table for this case is displayed in Table 5.7

	$a$	$b$	$c$
$a$	$a$	X	X
$b$	X	$b$	$b$
$c$	X	$c$	$c$

Table 5.7: Multiplication table for the, even  $r$ ,  $2b - a$  and  $2a - b$  not in  $\{a, b, c\}$ , and  $2b - c = c$  case

- (b) Finally, if  $2b - c \notin \{a, b, c\}$  then  $2c - b \neq b$ 
  - i. If  $2c - b = a$  then  $2c - a = b$

- A. If  $2a - b = c$  then  $2a - c = b$  which adding to  $2c - a = b$  yields  $2b - a = c$  and this contradicts 4
- B. If  $2a - b \notin \{a, b, c\}$  then  $2a - c \neq b$
- If  $2a - c = c$  then  $r$  is **even** and  $2c - a = a$  which contradicts a conclusion in 4(b)i
  - So  $2a - c \notin \{a, b, c\}$  and the corresponding table is displayed in Table 5.8

	$a$	$b$	$c$
$a$	$a$	X	$b$
$b$	X	$b$	$a$
$c$	X	X	$c$

Table 5.8: Multiplication table for the, even  $r$ ,  $2b - a$  and  $2b - c$  not in  $\{a, b, c\}$ , and  $2c - b = a$  case

- ii. If  $2c - b \notin \{a, b, c\}$  then  $2c - a \neq b$
- A. If  $2c - a = a$  then  $r$  is **even** and  $2a - c = c$ . Subtracting  $2c - b = e$  (for some  $e \notin \{a, b, c\}$ ) by  $2c - a = a$ , we obtain  $2a - b = e \notin \{a, b, c\}$ . The corresponding table is displayed in Table 5.9

	$a$	$b$	$c$
$a$	$a$	X	$a$
$b$	X	$b$	X
$c$	$c$	X	$c$

Table 5.9: Multiplication table for the, even  $r$ ,  $2b - a$ ,  $2b - c$  and  $2c - b$  not in  $\{a, b, c\}$ , and  $2c - a = a$

- B. If  $2c - a \notin \{a, b, c\}$  then  $2a - c \neq c$
- If  $2a - c = b$  then  $2a - b = c$  and the corresponding table is displayed in Table 5.10

	$a$	$b$	$c$
$a$	$a$	X	X
$b$	$c$	$b$	X
$c$	$b$	X	$c$

Table 5.10: Multiplication table for the  $2b - a$ ,  $2b - c$ ,  $2c - b$ , and  $2c - a$  not in  $\{a, b, c\}$ , and  $2a - c = b$  case

- If  $2a - c \notin \{a, b, c\}$  then  $2a - b \neq c$  which means  $2a - b \notin \{a, b, c\}$  from 4. The corresponding table is displayed in Table 5.11

	$a$	$b$	$c$
$a$	$a$	X	X
$b$	X	$b$	X
$c$	X	X	$c$

Table 5.11: Multiplication table for the  $2b - a$ ,  $2b - c$ ,  $2c - b$ ,  $2c - a$ , and  $2a - c$  not in  $\{a, b, c\}$  case

We note that, except for Table 5.4, all other tables have, at least, one row with only one entry from  $\{a, b, c\}$ . The fact that each of the rows has to have at least one entry from  $\{a, b, c\}$  stems from the idempotency axiom. The situation of Table 5.4 implies that  $3 \mid r$ , as was seen in the discussion leading to it. We can thus say that, together with the discussion of Tables 5.1 and 5.2, right before 3. above,

**Proposition 5.1** *If  $3 \nmid r$ , then no  $r$ -coloring of any 1-component knot can use exactly three colors from  $R_r$ .*

Proof: Omitted. ■

**Proposition 5.2** *If  $\langle n, r \rangle = 5$  then*

$$\text{mincol}_r T(2, n) = 4$$

Proof: We recall that, via the proof of Theorem 3.2, there is a coloring that uses exactly 4 colors from  $R_r$  whenever  $\langle n, r \rangle = 5$ . Corollary 4.2 shows us that  $\text{mincol}_r T(2, n)$  here cannot be 2. We will now show that  $\text{mincol}_r T(2, n)$  cannot be 3 thus concluding the proof.

Suppose  $n$  is odd. Then  $T(2, n)$  is a 1-component knot (Proposition 3.1) and according to the preceding Proposition there are no  $r$  colorings of  $T(2, n)$  using only 3 colors provided  $3 \nmid r$ . Assume now that  $3 \mid r$ . Then we are in the situation of Table 5.4. These three colors form a subquandle of  $R_r$  which is isomorphic to  $R_3$ . If there is a diagram of  $T(2, n)$  which is colored by these three colors then any other diagram of  $T(2, n)$  is colored by these three colors, since in this situation the  $a$ ,  $b$ , and  $c$  are algebraically closed under the operation. But the closure of  $\sigma_1^n$  is not colored by these three colors since  $3 \nmid n$ .

Suppose now that  $n$  is even. Then  $T(2, n)$  is a 2-component knot (Proposition 3.1). Also,  $r$  cannot be even, for otherwise  $\langle n, r \rangle = 2$ . Then the situations that give rise to Tables 5.1, 5.2, 5.3, 5.6, 5.7, 5.9 do not concern us since they have to do with even  $r$ . As for Table 5.4, it will also not concern us here because, as discussed in the preceding paragraph, if it did then both  $r$  and  $n$  would be divisible by 3 which would imply that  $\langle n, r \rangle \neq 5$ . We are thus left with situations involving Tables 5.5, 5.8, 5.10, or 5.11. In Table 5.5,  $b$  can never color an under-arc nor is it ever the product of colors distinct from itself. Therefore  $b$  colors a component of  $T(2, n)$  which is not linked to the other component. But this is impossible since according to Proposition 3.1 for even  $n$ , the two components of  $T(2, n)$  are linked. The situations giving rise to Tables 5.8, 5.10, or 5.11 are analogous to the one we just described. This concludes the proof. ■

## 5.2 Teneva Reduction on rational knots.

We will now consider applications of Teneva Reductions to rational knots. For facts and notation on rational knots we refer to [9].

We consider the rational knot  $N[[8], [-6]]$  endowed with a non-trivial 7-coloring, using all 7 colors. View Figure 14.

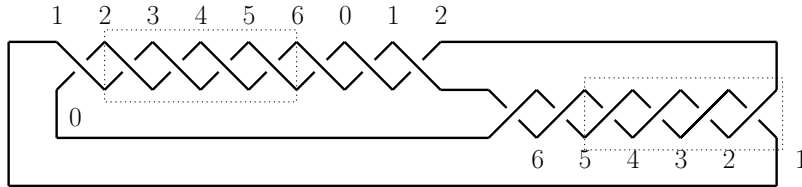

Figure 14: Non-trivial 7-coloring on  $N[[8], [-6]]$  using the 7 colors

The two portions of Figure 14 boxed by dotted lines can be regarded as  $\sigma_1^4$  - the one on the left - and  $\sigma_1^{-4}$  - the one on the right. In Figure 15 we show an instance of Teneva Reduction applied to this  $\sigma_1^{-4}$ : Note that had we continued performing type III Reidemeister moves in the Teneva Reduction we would

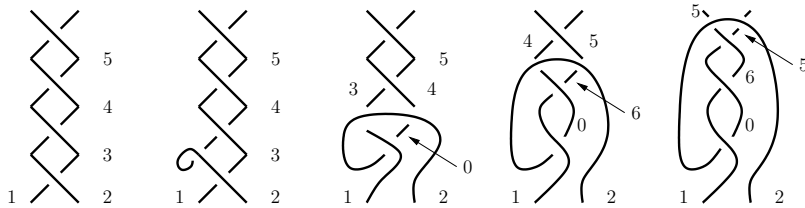

Figure 15: An instance of Teneva Reduction

have increased the number of the colors in the coloring of the rational knot.

We remark that Teneva Reduction can be applied in a similar way to the  $\sigma_1^4$  in Figure 14. With these reductions the coloring on  $N[[8], [-6]]$  depicted in Figure 14 has changed to the equivalent coloring shown in Figure 16, using only 5 colors - less 2 than the 7 colors used in Figure 14.

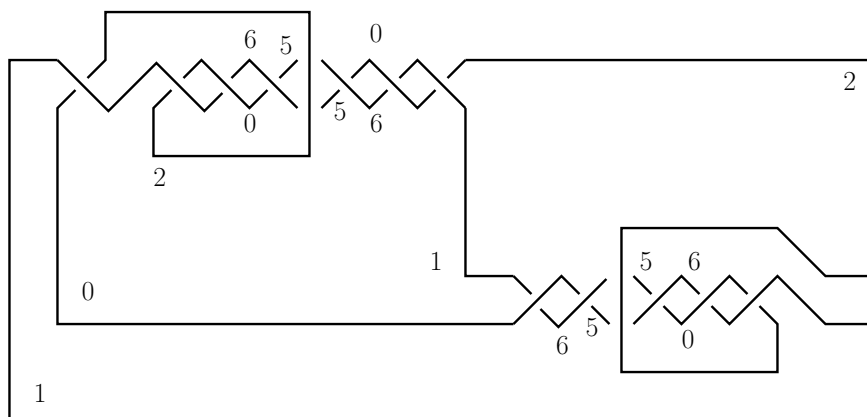

Figure 16: Reducing the colors of the non-trivial coloring from 7 to 5

We now show an example of a rational knot,  $R$ , of prime determinant,  $p$ , such that its minimum number of colors modulo  $p$  and over all diagrams is strictly less than the minimum number of colors over minimal diagrams i.e.,  $\text{mincol}_p R < \text{minmin}_p R$ . This rational knot is  $N[[8], [-9]]$ . Its determinant is the prime  $73 (= 9 \cdot 8 + 1)$ . The Teneva Reduction in this case is similar to the preceding one so we will just show the initial diagram endowed with a non-trivial 73-coloring, the portions of the diagram that will undergo Teneva Reduction (inside the boxed areas), see Figure 17; and the final diagram after Teneva Reduction has been performed on the indicated portions, see Figure 18.

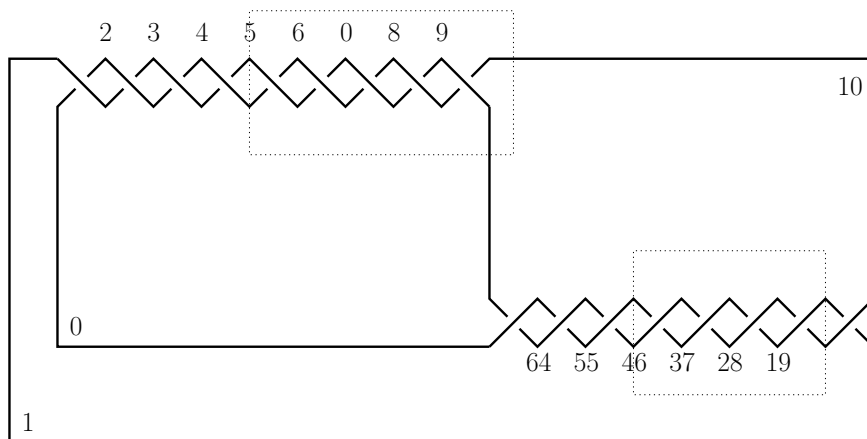

Figure 17: Non-trivial 73-coloring on  $N[[8], [-9]]$  using the  $17 = 8 + 9$  colors

In particular, note that the minimal alternating diagram on Figure 17 uses 17 colors to produce a non-trivial 73-coloring. This is in accordance with the Kauffman-Harary Conjecture (Conjecture 1.1) since this diagram has  $9 + 8 = 17$  arcs. Notwithstanding, the diagram in Figure 18 is Reidemeister equivalent to the preceding one and uses only 12 colors to produce a non-trivial 73-coloring. In this way, Conjecture 4.1 does not apply for general rational knots with “ $n$ ” replaced by “Determinant of  $R$ ”. Moreover, this example shows that, for rational knots, the minimum number of colors predicted by the Kauffman-Harary conjecture, which considers only minimal diagrams, can be further decreased using non-minimal diagrams.

## 6 Final remarks

The main accomplishments of this paper are the expression of the number of  $r$ -colorings of a torus knot  $T(2, n)$  for any integer  $r > 2$  and the reduction of the upper bounds of the minimum number of colors

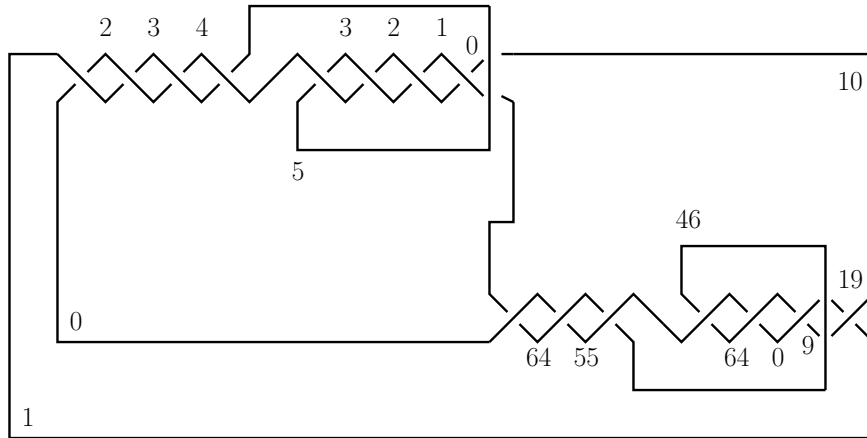

Figure 18: Non-trivial 73-coloring on  $N[[8], [-9]]$  using 12 colors

necessary to produce a non-trivial  $r$ -coloring using Teneva Transformations. A first question we would like to answer concerns the truth of our conjecture on the minimum number of colors for the  $T(2, n)$ 's.

We regard this work as a case study which motivates us to attack more general situations. In this way, we would like to consider other classes of knots, other classes of labelling quandles, inquiring into the possibility of other sorts of transformations that allow one to reduce the number of colors of a non-trivial coloring, finding techniques to compute the minima of these colors given a diagram of a knot (at least for some classes of knots), etc. We aim to address these topics in future work.

## References

- [1] M. Asaeda, J. Przytycki, A. Sikora, *Kauffman-Harary conjecture holds for Montesinos knots*, J. Knot Theory Ramifications **13** (2004), no. 4, 467-477
- [2] J. Birman, *Braids, links, and mapping class groups*, Annals of Math. Studies **82**, Princeton University Press, Princeton, N. J. (1974)
- [3] J. S. Carter, D. Jelsovsky, S. Kamada, L. Langford, M. Saito, *Quandle cohomology and state-sum invariants of knotted curves and surfaces*, Trans. Amer. Math. Soc., **355** (2003), no. 10, 3947- 3989
- [4] F. M. Dionísio, P. Lopes, *Quandles at finite temperatures II*, J. Knot Theory Ramifications, **12** (2003), no. 2, 1041-1092
- [5] R. H. Fox, *A Quick Trip Through Knot Theory*, in “Topology of 3-Manifolds and Related Topics” (Georgia, 1961), Prentice-Hall (1962) 120-167
- [6] F. Harary, L. H. Kauffman, *Knots and graphs I. Arc graphs and colorings*, Adv. in Appl. Math., **22** (1999), 312-337
- [7] D. Joyce, *A classifying invariant of knots, the knot quandle*, J. Pure Appl. Alg., **23** (1982), 37-65
- [8] L. H. Kauffman, *Knots and physics*, 3rd edition, Series on Knots and Everything **1**, World Scientific Publishing Co., River Edge, NJ (2001)
- [9] L. H. Kauffman, S. Lambropoulou, *On the classification of rational tangles*, Adv. in Appl. Math., **33** (2004), no. 2, 199-237
- [10] P. Lopes, *Quandles at finite temperatures I*, J. Knot Theory Ramifications, **12** (2003), no. 2, 159-186
- [11] S. V. Matveev, *Distributive groupoids in knot theory*, Math. USSR Sbornik, **47** (1984), no. 1, 73-83