

# Hyperplane arrangements and Lefschetz's hyperplane section theorem

Masahiko Yoshinaga  
International Centre for Theoretical Physics  
Strada Costiera 11, Trieste 34014, Italy  
email: myoshina@ictp.it

December 11, 2006

## Abstract

The Lefschetz hyperplane section theorem asserts that a complex affine variety is homotopy equivalent to a space obtained from its generic hyperplane section by attaching some cells. The purpose of this paper is to give an explicit description of attaching maps of these cells for the complement of a complex hyperplane arrangement defined over real numbers. The cells and attaching maps are described in combinatorial terms of chambers. We also discuss the cellular chain complex with coefficients in a local system and a presentation for the fundamental group associated to the minimal CW-decomposition for the complement.

**MSC-class:** 32S22 (Primary) 14F35, 32S50 (Secondary)

**Keywords:** Arrangements, Minimal CW-complex, Homotopy type.

## 1 Introduction

The Lefschetz hyperplane section theorem is a result concerning a topological relationship between an algebraic variety and its generic hyperplane section. The following is a version of the Lefschetz theorem for affine varieties. Let  $g \in \mathbb{C}[x_1, \dots, x_\ell]$  be a polynomial and  $\mathbf{M}(g) := \{x \in \mathbb{C}^\ell \mid g(x) \neq 0\}$  be the hypersurface complement defined by  $g$ .

**Theorem 1.0.1 (Affine Lefschetz Theorem [Ha, HL])** *Let  $F$  be a generic affine hyperplane in  $\mathbb{C}^\ell$ . Then the space  $\mathbf{M}(g)$  has the homotopy type of a space obtained from  $\mathbf{M}(g) \cap F$  by attaching a certain number of  $\ell$ -dimensional cells.*

The important part of the above Lefschetz theorem for affine varieties is that the cells attached to  $\mathbf{M}(g) \cap F$  all have equal dimension  $\ell$ . This makes the situation relatively simple. An immediate corollary, obtained by induction on the dimension  $\ell$ , is that  $\mathbf{M}(g)$  is homotopy equivalent to an  $\ell$ -dimensional CW-complex whose  $(\ell - 1)$ -skeleton is homotopy equivalent to  $\mathbf{M}(g) \cap F$ , and we also conclude that the number of  $\ell$ -cells is equal to  $\dim H_\ell(\mathbf{M}(g), \mathbf{M}(g) \cap F)$ . The number of  $\ell$ -cells is obviously greater than or equal to the Betti number  $b_\ell(\mathbf{M}(g))$ . More precisely, we have the following exact sequence:

$$0 \rightarrow H_\ell(\mathbf{M}(g)) \rightarrow H_\ell(\mathbf{M}(g), \mathbf{M}(g) \cap F) \rightarrow H_{\ell-1}(\mathbf{M}(g) \cap F) \xrightarrow{i_{\ell-1}} H_{\ell-1}(\mathbf{M}(g)).$$

Another corollary is

**Corollary 1.0.2** *Let  $i_p : H_p(\mathbf{M}(g) \cap F, \mathbb{C}) \rightarrow H_p(\mathbf{M}(g), \mathbb{C})$  denote the homomorphism induced from the natural inclusion  $i : \mathbf{M}(g) \cap F \hookrightarrow \mathbf{M}(g)$ , then*

$$i_p \text{ is } \begin{cases} \text{isomorphic} & \text{for } p = 0, 1, \dots, \ell - 2 \\ \text{surjective} & \text{for } p = \ell - 1. \end{cases}$$

As noted by A. Dimca, S. Papadima and R. Randell ([DP1], [Ra2]), suppose  $i_{\ell-1}$  is isomorphic, then the number of  $\ell$ -dimensional cells attached would be equal to the Betti number  $b_\ell(\mathbf{M}(g))$ . While in case of a hyperplane arrangement, that is, when  $g$  is a product of linear equations,  $i_{\ell-1}$  is indeed isomorphic (see Prop. 2.3.1), and hence the number of  $\ell$ -cells is exactly equal to  $b_\ell(\mathbf{M}(g))$ .

Repeating the same procedure inductively, we finally obtain a minimal CW decomposition.

**Theorem 1.0.3 ([DP1] [Ra2])** *Let  $\mathcal{A}$  be an affine arrangement in  $\mathbb{C}^\ell$ . Then the complement  $\mathbf{M}(\mathcal{A})$  is homotopy equivalent to a minimal CW-complex, i.e. a CW-complex whose number of  $k$ -cells is equal to  $b_k(\mathbf{M}(\mathcal{A}))$  for each  $k$ .*

Let  $\mathcal{L}$  be a rank one local system on  $\mathbf{M}(\mathcal{A})$ . Then the minimal CW-decomposition yields a cellular chain complex  $(\mathcal{C}_\bullet(\mathbf{M}(\mathcal{A}), \mathcal{L}), \partial)$  satisfying

$\dim \mathcal{C}_k(\mathbf{M}(\mathcal{A}), \mathcal{L}) = b_k(\mathbf{M}(\mathcal{A}))$  and  $H_k(\mathbf{M}(\mathcal{A}), \mathcal{L}) \cong H_k(\mathcal{C}_\bullet(\mathbf{M}(\mathcal{A}), \mathcal{L}), \partial)$ . We call this the twisted minimal chain complex. This kind of minimal complexes were first constructed by D. Cohen by using stratified Morse theory [Co1]. Properties of twisted minimal chain complexes have been studied in many papers including [Co2, CO, DP2, PS]. To describe boundary maps  $\partial : \mathcal{C}_\bullet \rightarrow \mathcal{C}_{\bullet-1}$ , some information about the attaching maps of minimal CW-complexes are required. Attaching maps for minimal CW-decompositions for  $\ell = 2$  were studied by M. Falk [Fa] based on [Ra1, Sa] (see also [Li]).

However, little is known about both the attaching maps and the boundary maps  $\partial : \mathcal{C}_\bullet \rightarrow \mathcal{C}_{\bullet-1}$  for higher dimensional cases. The purpose of this paper is to describe how  $\ell$ -cells are attached to a generic hyperplane section  $\mathbf{M}(\mathcal{A}) \cap F$  for the complement  $\mathbf{M}(\mathcal{A})$  of a real hyperplane arrangement  $\mathcal{A}$  (§5.2). Here, “real hyperplane arrangement” means that the defining polynomial  $g \in \mathbb{R}[x_1, \dots, x_\ell]$  is a product of linear equations with real coefficients. Although we have not yet obtained a complete understanding of the minimal CW-decomposition for hyperplane complements, we obtain a description of the twisted minimal chain complex  $(\mathcal{C}_\bullet(\mathbf{M}(\mathcal{A}), \mathcal{L}), \partial)$  (in §6). Our formula of the twisted boundary map contains the integers “ $\deg(C, C')$ ”. It is defined by using the topological relationship between two chambers, and its computation will be quite difficult in general. But it is computable in a certain cases. Our presentation has some applications on the structure of local system homologies, which will be discussed in a subsequent paper [Y].

The advantage of focusing our attention on real arrangements is that we can use structures of chambers, namely, the connected components of  $\mathbf{M}(\mathcal{A}) \cap \mathbb{R}^\ell$ . The study of relationships between topology of  $\mathbf{M}(\mathcal{A})$  and combinatorics of chambers is a classical topic in the theory of hyperplane arrangements. We summarize some classical results related to chamber-counting problems in §2. The number of chambers are related to Betti numbers of  $\mathbf{M}(\mathcal{A})$ . Later, in §5.1, we give a more geometric interpretation to these numerical relations between chambers and Betti numbers: chambers can be thought of as stable manifolds for a certain Morse function. This interpretation will play a crucial role in this paper. By a well-known duality between stable and unstable manifolds, the set of chambers are indexing unstable cells which appear in the minimal CW-decomposition. Thus the basis of the associated cellular chain complex is also indexed by chambers.

In §3 we review the Salvetti complex and the Deligne groupoid. They relate combinatorial structures of chambers to topological structures of the complexified complements. In particular, for the purposes of this paper, we

have to describe local systems in terms of chambers. The Deligne groupoid offers an appropriate language to deal with local systems in a combinatorial context. A local system can be interpreted as a representation of the Deligne groupoid.

In §4.1 we give a proof of the Theorem 1.0.1 for hyperplane complements. It is proved by applying Morse theory to a Morse function of the form  $|f/g|^2$ , where  $f$  is a defining equation of the generic hyperplane  $F$ . Although the proof does not involve anything new, Morse theoretic consideration in the proof will be needed later. In particular, Morse theory tells us that, under Morse-Smale condition on the gradient vector field, the unstable manifolds can be viewed as the  $\ell$ -cells attached to the generic section, and we have a homotopy equivalence

$$\mathbf{M}(\mathcal{A}) \approx (\mathbf{M}(\mathcal{A}) \cap F) \cup \bigcup_{p \in \text{Crit}(\varphi)} W_p^u,$$

where  $W_p^u$  is the unstable manifold corresponding to a critical point  $p \in \text{Crit}(\varphi)$  of the Morse function  $\varphi$ . From the Morse-Smale condition, unstable and stable manifolds define “set-theoretic” dual bases of  $H_\ell(\mathbf{M}(\mathcal{A}))$  and  $H_\ell^{lf}(\mathbf{M}(\mathcal{A}))$ , respectively, that is,

$$W_p^u \cap W_q^s = \begin{cases} W_p^u \pitchfork W_q^s = \{p\} & \text{if } p = q, \\ \emptyset & \text{if } p \neq q. \end{cases} \quad (1)$$

The main result in §4 is that the set-theoretical duality between stable and unstable manifolds characterizes the homotopy type of unstable manifolds.

As noted above, in the case of real arrangements, a stable manifold is known to be equal to a chamber. The goal of §5 is to construct cells attached to the hyperplane section  $\mathbf{M}(\mathcal{A}) \cap F$  which satisfy the set-theoretical duality condition (1) with respect to the chambers. Thanks to the result in the previous section, the cells constructed in this section are homotopy equivalent to unstable manifolds. The special case when  $\ell = 2$  offers a new presentation for the fundamental group  $\pi_1(\mathbf{M}(\mathcal{A}))$ , which is given in the appendix §7.

In §6, using the construction of the cells in the previous section, we determine the boundary map of twisted cellular complex of the minimal CW-decomposition. The essential ingredient is calculating twisted intersection numbers of the boundary of a cell and chambers. In §6.3, we introduce the concept of the degree map which associates to a pair of chambers  $(C, C')$  an integer  $\text{deg}(C, C')$ . The degree map is required for both the boundary maps

of twisted cellular chain complexes and the presentations for fundamental groups.

## 2 Combinatorics of arrangements

In this section we establish some relationships among generic subspaces, numbers of chambers and Betti numbers for complements of hyperplane arrangements.

### 2.1 Basic constructions

Let  $V$  be an  $\ell$ -dimensional vector space. A finite set of affine hyperplanes  $\mathcal{A} = \{H_1, \dots, H_n\}$  is called a *hyperplane arrangement*. Let  $L(\mathcal{A})$  be the set of nonempty intersections of elements of  $\mathcal{A}$ . Define a partial order on  $L(\mathcal{A})$  by  $X \leq Y \iff Y \subseteq X$  for  $X, Y \in L(\mathcal{A})$ . Note that this is reverse inclusion.

Define a *rank function* on  $L(\mathcal{A})$  by  $r(X) = \text{codim } X$ . Write  $L^p(\mathcal{A}) = \{X \in L(\mathcal{A}) \mid r(X) = p\}$ . We call  $\mathcal{A}$  *essential* if  $L^\ell(\mathcal{A}) \neq \emptyset$ .

Let  $\mu : L(\mathcal{A}) \rightarrow \mathbb{Z}$  be the *Möbius function* of  $L(\mathcal{A})$  defined by

$$\mu(X) = \begin{cases} 1 & \text{for } X = V \\ -\sum_{Y < X} \mu(Y), & \text{for } X > V. \end{cases}$$

The *Poincaré polynomial* of  $\mathcal{A}$  is  $\pi(\mathcal{A}, t) = \sum_{X \in L(\mathcal{A})} \mu(X)(-t)^{r(X)}$  and we also define numbers  $b_i(\mathcal{A})$  by the formula

$$\pi(\mathcal{A}, t) = \sum_{i=0}^{\ell} b_i(\mathcal{A})t^i.$$

We also define the  *$\beta$ -invariant*  $\beta(\mathcal{A})$  by

$$\beta(\mathcal{A}) = |\pi(\mathcal{A}, -1)|,$$

if  $\mathcal{A}$  is an essential arrangement, the sign can be precisely enumerated as  $\beta(\mathcal{A}) = (-1)^\ell \pi(\mathcal{A}, -1)$ .

Given a hyperplane  $H \in \mathcal{A}$ , we define other arrangements: the *deletion* of  $\mathcal{A}$  with respect to  $H$  is  $\mathcal{A}' = \mathcal{A} \setminus \{H\}$  and the *restriction* is  $\mathcal{A}'' = \{H \cap K \mid K \in \mathcal{A}'\}$ . Note that the restriction  $\mathcal{A}''$  is an arrangement in  $H$ . The Poincaré polynomials satisfy the following recursion:

$$\pi(\mathcal{A}, t) = \pi(\mathcal{A}', t) + t \cdot \pi(\mathcal{A}'', t). \quad (2)$$

## 2.2 Classical results

Let  $\mathcal{A}$  be an arrangement in a real vector space  $V_{\mathbb{R}}$ . Then the complement  $V_{\mathbb{R}} \setminus \bigcup_{i=1}^n H_i$  is a union of open, connected components called *chambers*. Let us denote the set of all chambers by  $\text{ch}(\mathcal{A})$ , and the set of relatively compact (or bounded) chambers by  $\text{bch}(\mathcal{A})$ . If  $\mathcal{A}$  is an arrangement in a complex vector space  $V_{\mathbb{C}}$ , the complement is a connected affine algebraic variety and denoted by  $\mathbf{M}(\mathcal{A})$ .

The Poincaré polynomial defined above and the geometric structure of the complement are related by the following theorem.

**Theorem 2.2.1** [OS, Za]

- (i) *Let  $\mathcal{A}$  be an essential real  $\ell$ -arrangement. The number  $|\text{ch}(\mathcal{A})|$  of chambers and the number  $|\text{bch}(\mathcal{A})|$  of bounded chambers  $|\text{bch}(\mathcal{A})|$  are given by*

$$\begin{aligned} |\text{ch}(\mathcal{A})| &= \pi(\mathcal{A}, 1) \\ |\text{bch}(\mathcal{A})| &= (-1)^\ell \pi(\mathcal{A}, -1) = \beta(\mathcal{A}). \end{aligned}$$

- (ii) *Let  $\mathcal{A}$  be a complex arrangement. Then  $b_i(\mathcal{A})$  is equal to the topological Betti number  $b_i(\mathbf{M}(\mathcal{A}))$ . In other words, the topological Poincaré polynomial  $\text{Poin}(\mathbf{M}(\mathcal{A}), t) = \sum_i b_i(\mathbf{M}(\mathcal{A}))t^i$  is given by*

$$\text{Poin}(\mathbf{M}(\mathcal{A}), t) = \pi(\mathcal{A}, t).$$

*In particular, the absolute value of the topological Euler characteristic  $|\chi(\mathbf{M}(\mathcal{A}))|$  of the complement is equal to  $\beta(\mathcal{A})$ .*

## 2.3 Generic flags

Let  $\mathcal{A}$  be an  $\ell$ -arrangement. A  $q$ -dimensional affine subspace  $\mathcal{F}^q \subset V$  is called *generic* or *transversal* to  $\mathcal{A}$  if  $\dim \mathcal{F}^q \cap X = q - r(X)$  for  $X \in L(\mathcal{A})$ . A *generic flag*  $\mathcal{F}$  is defined to be a complete flag (of affine subspaces) in  $V$ ,

$$\mathcal{F} : \emptyset = \mathcal{F}^{-1} \subset \mathcal{F}^0 \subset \mathcal{F}^1 \subset \dots \subset \mathcal{F}^\ell = V,$$

where each  $\mathcal{F}^q$  is a generic  $q$ -dimensional affine subspace.

For a generic subspace  $\mathcal{F}^q$  we have an arrangement in  $\mathcal{F}^q$

$$\mathcal{A} \cap \mathcal{F}^q := \{H \cap \mathcal{F}^q \mid H \in \mathcal{A}\}.$$

The genericity provides an isomorphism of posets

$$L(\mathcal{A} \cap \mathcal{F}^q) \cong L^{\leq q}(\mathcal{A}) := \bigcup_{i \leq q} L^i(\mathcal{A}). \quad (3)$$

In [OS] Orlik and Solomon gave a presentation of the cohomology ring  $H^*(M(\mathcal{A}), \mathbb{Z})$  in terms of the poset  $L(\mathcal{A})$  for a complex arrangement  $\mathcal{A}$ . The next proposition follows from (3).

**Propositon 2.3.1** *Let  $\mathcal{A}$  be a complex arrangement and  $\mathcal{F}^q$  a  $q$ -dimensional generic subspace. Then the natural inclusion  $i : M(\mathcal{A}) \cap \mathcal{F}^q \hookrightarrow M(\mathcal{A})$  induces isomorphisms*

$$i_k : H_k(M(\mathcal{A}) \cap \mathcal{F}^q, \mathbb{Z}) \xrightarrow{\cong} H_k(M(\mathcal{A}), \mathbb{Z}),$$

for  $k = 0, 1, \dots, q$ .

In particular, the Poincaré polynomial of  $\mathcal{A} \cap \mathcal{F}^q$  is given by

$$\pi(\mathcal{A} \cap \mathcal{F}^q, t) = \pi(\mathcal{A}, t)^{\leq q}, \quad (4)$$

where  $(\sum_{i \geq 0} a_i t^i)^{\leq q} = \sum_{i=0}^q a_i t^i$  is the truncated polynomial. These formulas and Theorem 2.2.1 prove the following result.

**Propositon 2.3.2** *Let  $\mathcal{A}$  be a real  $\ell$ -arrangement and  $\mathcal{F}$  a generic flag. Define*

$$\text{ch}_q^{\mathcal{F}}(\mathcal{A}) = \{C \in \text{ch}(\mathcal{A}) \mid C \cap \mathcal{F}^q \neq \emptyset \text{ and } C \cap \mathcal{F}^{q-1} = \emptyset\},$$

for each  $q = 0, 1, \dots, \ell$ . Then

$$(i) \quad |\text{ch}_q^{\mathcal{F}}(\mathcal{A})| = b_q(M(\mathcal{A})).$$

$$(ii) \quad \text{If } \mathcal{A} \text{ is essential, then } b_\ell(M(\mathcal{A})) = \beta(\mathcal{A} \cup \{\mathcal{F}_{\ell-1}\}),$$

where  $M(\mathcal{A})$  is the complement of the complexified arrangement of  $\mathcal{A}$  and  $\mathcal{A} \cup \{\mathcal{F}_{\ell-1}\}$  is the arrangement obtained by adding  $\mathcal{F}^{\ell-1}$  to  $\mathcal{A}$ .

**Proof.** For any chamber  $C \in \text{ch}(\mathcal{A})$ , the intersection  $C \cap \mathcal{F}^q$  is either an empty set or a chamber in  $\mathcal{A} \cap \mathcal{F}^q$ . Hence we have a bijection

$$\begin{aligned} \bigcup_{i \leq q} \text{ch}_i^{\mathcal{F}}(\mathcal{A}) &\longrightarrow \text{ch}(\mathcal{A} \cap \mathcal{F}^q) \\ C &\longmapsto C \cap \mathcal{F}^q. \end{aligned}$$

Counting the number of chambers by using Theorem 2.2.1 (i) and (4), we obtain

$$\begin{aligned}
\sum_{i \leq q} |\text{ch}_q^{\mathcal{F}}(\mathcal{A})| &= |\text{ch}(\mathcal{A} \cap \mathcal{F}^q)| \\
&= \pi(\mathcal{A} \cap \mathcal{F}^q, t)|_{t=1} \\
&= \sum_{i \leq q} b_i(\mathcal{A}).
\end{aligned}$$

Thus we have (i).

The recursion formula (2) allows us to calculate the Poincaré polynomial of  $\mathcal{A} \cup \mathcal{F}^{\ell-1}$ :

$$\begin{aligned}
\pi(\mathcal{A} \cup \{\mathcal{F}^{\ell-1}\}, t) &= \pi(\mathcal{A}, t) + t \cdot \pi(\mathcal{A} \cap \mathcal{F}^{\ell-1}, t) \\
&= \pi(\mathcal{A}, t) + t \cdot \pi(\mathcal{A}, t)^{\leq \ell-1} \\
&= \pi(\mathcal{A}, t) + t \cdot (\pi(\mathcal{A}, t) - b_\ell(\mathcal{A})t^\ell).
\end{aligned}$$

By putting  $t = -1$  we obtain (ii). □

**Example 2.3.3** Figure 1 shows an example of arrangement  $\mathcal{A}$  of three lines in  $\mathbb{R}^2$  with a generic flag  $\mathcal{F} : \mathcal{F}^0 \subset \mathcal{F}^1 \subset V$ . Note that  $\pi(\mathcal{A}, t) = 1 + 3t + 3t^2$ .

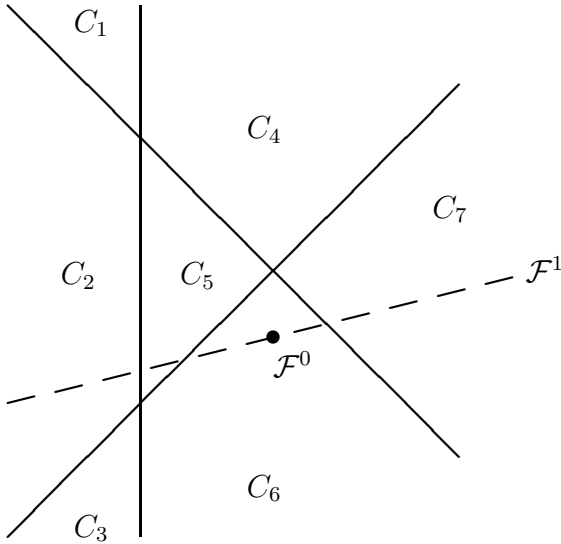

A generic flag

$$\mathcal{F} : \{\text{pt}\} = \mathcal{F}^0 \subset \mathcal{F}^1 \subset V$$

$$\text{ch}(\mathcal{A}) = \{C_1, \dots, C_7\}$$

$$\text{ch}_0^{\mathcal{F}}(\mathcal{A}) = \{C_6\}$$

$$\text{ch}_1^{\mathcal{F}}(\mathcal{A}) = \{C_2, C_5, C_7\}$$

$$\text{ch}_2^{\mathcal{F}}(\mathcal{A}) = \{C_1, C_3, C_4\}$$

Figure 1: A 2-arrangement and a generic flag



Let  $\mathcal{A}$  be a real arrangement with a generic flag  $\mathcal{F}$ . Consider the  $\ell$ -th homology, cohomology and homology with locally finite chains for the complement. Both  $H_\ell^{lf}(\mathbf{M}(\mathcal{A}), \mathbb{C})$  and  $H^\ell(\mathbf{M}(\mathcal{A}), \mathbb{C})$  are dual to  $H_\ell(\mathbf{M}(\mathcal{A}), \mathbb{C})$ . So there exists a canonical isomorphism

$$H_\ell^{lf}(\mathbf{M}(\mathcal{A}), \mathbb{C}) \xrightarrow{\cong} H^\ell(\mathbf{M}(\mathcal{A}), \mathbb{C}). \quad (5)$$

Let  $C$  be a chamber. Using the inclusion  $V_{\mathbb{R}} \hookrightarrow V_{\mathbb{C}} = V_{\mathbb{R}} \oplus \sqrt{-1}V_{\mathbb{R}}$ ,  $C$  can be considered as a locally finite  $\ell$ -dimensional cycle in  $\mathbf{M}(\mathcal{A})$  and determines an element  $[C] \in H_\ell^{lf}(\mathbf{M}(\mathcal{A}))$ .

Recall that  $C \in \text{ch}_\ell^{\mathcal{F}}(\mathcal{A})$  is a chamber satisfying  $C \cap \mathcal{F}^{\ell-1} = \emptyset$ , and that the number of such chambers is equal to the  $\ell$ -th Betti number  $b_\ell(\mathcal{A}) = \dim H_\ell^{lf}(\mathbf{M}(\mathcal{A}))$ . Later we will prove that  $\{[C] \mid C \in \text{ch}_\ell^{\mathcal{F}}(\mathcal{A})\}$  forms a basis of  $H_\ell^{lf}(\mathbf{M}(\mathcal{A}))$  (Cor. 5.1.4).

### 3 The Salvetti complex and the Deligne groupoid

In [Sa] Salvetti has given a finite regular CW-complex which carries the homotopy type of the complement  $\mathbf{M}(\mathcal{A})$  in the case where  $\mathcal{A}$  is a complexified real arrangement. In this section we review some results on the complexified complement  $\mathbf{M}(\mathcal{A})$  of a real arrangement  $\mathcal{A}$ .

#### 3.1 Complexified real arrangements

Let  $\mathcal{A}_{\mathbb{R}}$  be an arrangement in a real vector space  $V_{\mathbb{R}}$ . By definition each hyperplane  $H \in \mathcal{A}_{\mathbb{R}}$  is defined by a real equation  $\alpha_H = 0$  of degree one. The complexification  $\mathcal{A}_{\mathbb{C}}$  is a set of hyperplanes in  $V_{\mathbb{C}} = V_{\mathbb{R}} \otimes \mathbb{C}$  defined by real equations  $\alpha_H = 0$  for  $H \in \mathcal{A}_{\mathbb{R}}$ .

Since  $V_{\mathbb{C}} \cong V_{\mathbb{R}} \oplus \sqrt{-1}V_{\mathbb{R}}$ ,  $V_{\mathbb{C}}$  can be identified with the total space of the tangent bundle  $\text{TV}_{\mathbb{R}}$ . More precisely we identify as follows:

$$\begin{aligned} \text{TV}_{\mathbb{R}} &\xrightarrow{\cong} V_{\mathbb{C}} \\ (x, v) &\longmapsto (x, v)_{\mathbb{C}} = x + \sqrt{-1}v, \end{aligned} \quad (6)$$

where  $\text{TV}_{\mathbb{R}} = \{(x, v) \mid x \in V_{\mathbb{R}}, v \in T_x V_{\mathbb{R}} \cong V_{\mathbb{R}}\}$ . This identification (6) enables us to express a point in  $V_{\mathbb{C}}$  as a tangent vector on  $V_{\mathbb{R}}$ , and a path in  $V_{\mathbb{C}}$  can be expressed as a continuous family of tangent vectors along a path in  $V_{\mathbb{R}}$ , for simplicity we say a vector field along a path in  $V_{\mathbb{R}}$ .

**Example 3.1.1** The left side of Figure 2 expresses a vector field along the segment  $[-1, 1]$  in  $V_{\mathbb{R}} \cong \mathbb{R}$ . The right side expresses the corresponding path in  $V_{\mathbb{C}} \cong \mathbb{C}$ .

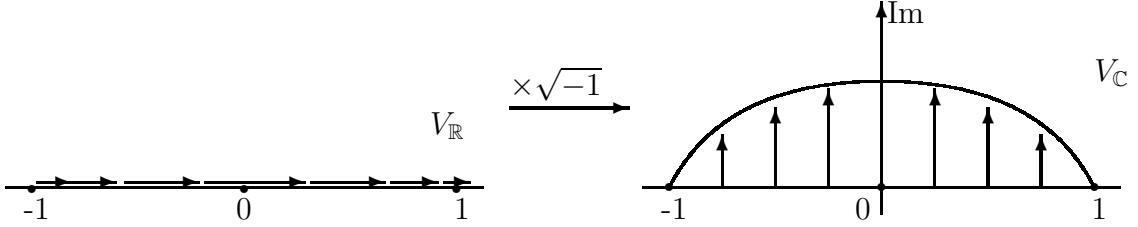

Figure 2: Vector field along the segment  $[-1, 1]$  and corresponding path

Let  $x \in V_{\mathbb{R}}$ . Then  $\alpha_H(x)$  can be expressed as  $\alpha_H(x) = a \cdot x + b$ , where  $a \in V_{\mathbb{R}}^*$  and  $b \in \mathbb{R}$ . Hence

$$\alpha_H(x + \sqrt{-1}v) = \alpha_H(x) + \sqrt{-1}a \cdot v,$$

for  $x + \sqrt{-1}v \in V_{\mathbb{C}}$ . We have

$$\alpha_H(x + \sqrt{-1}v) = 0 \iff \alpha_H(x) = 0 \text{ and } a \cdot v = 0.$$

This proves the following.

**Lemma 3.1.2** *Let  $\mathcal{A}$  be a real arrangement. For  $x \in V_{\mathbb{R}}$  we define  $\mathcal{A}_x$  to be the set  $\{H \in \mathcal{A} \mid H \ni x\}$  of all hyperplanes containing  $x$ . Then the complexified complement is*

$$M(\mathcal{A}) \cong \{(x, v)_{\mathbb{C}} \mid x \in V_{\mathbb{R}}, v \in T_x V_{\mathbb{R}} \setminus \mathcal{A}_x\}.$$

## 3.2 The Salvetti complex

We recall some notions about the Salvetti complex, for details see [BLSWZ].

**Definition 3.2.1** Let  $X \in L(\mathcal{A})$  be an intersection of a real arrangement  $\mathcal{A}$ . A connected component  $X^\circ$  of  $X \setminus \bigcup_{H \not\supseteq X} H$  is called a *face* of  $\mathcal{A}$ . The set of all faces is denoted by  $\mathcal{L}$ . Define a partial order by

$$X \leq Y \iff X \subset \bar{Y}, \text{ for } X, Y \in \mathcal{L},$$

where  $\bar{Y}$  is the closure of  $Y$  in  $V_{\mathbb{R}}$ . The ordered set  $(\mathcal{L}, \leq)$  is called the *face poset* of  $\mathcal{A}$ .

In this notation  $\text{ch}(\mathcal{A})$  is the set of maximal elements in  $(\mathcal{L}, \leq)$ .

Given a face  $X \in \mathcal{L}$  and a chamber  $C \in \text{ch}$ , the chamber  $X \circ C$  satisfying the following conditions is uniquely determined (see [BHR] for more on  $X \circ C$ ).

- (1)  $X \leq X \circ C$ , and
- (2) If  $X$  is contained in a hyperplane  $H \in \mathcal{A}$ , then  $C$  and  $X \circ C$  are on the same side with respect to  $H$ .

**Definition 3.2.2** The poset  $(\mathcal{P}(\mathcal{A}), \preceq)$  is defined as follows:

$$\begin{aligned} \mathcal{P}(\mathcal{A}) &= \{(X, C) \in \mathcal{L} \times \text{ch}(\mathcal{A}) \mid X \leq C\} \\ (X_1, C_1) \preceq (X_2, C_2) &\iff X_1 \geq X_2 \text{ and } X_1 \circ C_2 = C_1. \end{aligned}$$

**Theorem 3.2.3** *There exists a regular CW-complex  $X$ , called the Salvetti complex, such that the face poset  $\mathcal{F}(X)$  of the complex  $X$  is isomorphic to  $\mathcal{P}(\mathcal{A})$ , and  $X$  is homotopy equivalent to  $M(\mathcal{A})$ .*

**Example 3.2.4** We show some examples of low dimensional cells.

- (0-cell) In  $\mathcal{P}(\mathcal{A})$ , the 0-cells of  $X$  are corresponding to the  $(C, C) \in \mathcal{P}(\mathcal{A})$ ,  $C \in \text{ch}(\mathcal{A})$ .
- (1-cell) Two chambers  $C$  and  $C'$  are adjacent if  $\bar{C} \cap \bar{C}'$  is contained in a hyperplane and has nonempty interior in the hyperplane. The relative interior of  $\bar{C} \cap \bar{C}'$  is called the wall separating  $C$  and  $C'$ . Let  $C$  and  $C'$  be adjacent chambers separated by a wall  $X$ . Then we have two 1-cells,  $(X, C)$  and  $(X, C')$ , which connect  $(C, C)$  and  $(C', C')$ . (Figure 3)

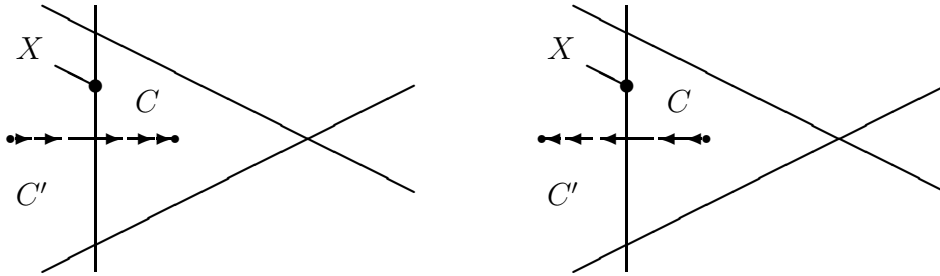

Figure 3: 1-cells corresponding to  $(X, C)$  and  $(X, C')$

- (2-cell) Let  $X \in \mathcal{L}$  be a face of codimension two with a chamber  $C_1 \geq X$ . We have a 2-cell  $(X, C_1)$ . (Figure 4)

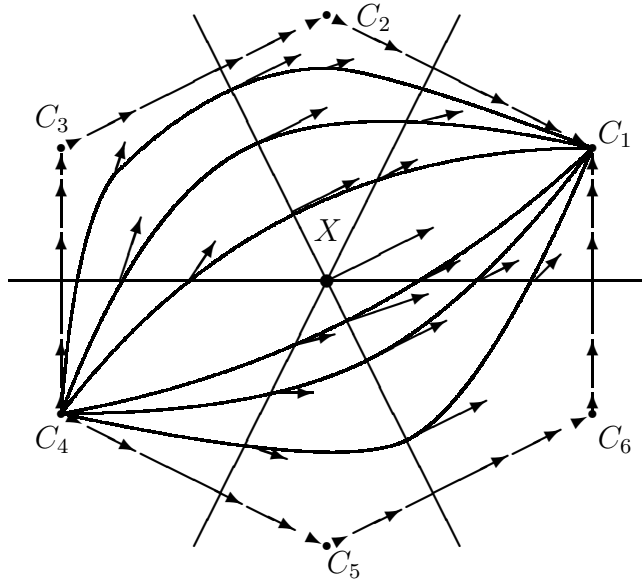

Figure 4: The 2-cell corresponding to  $(X, C_1)$

### 3.3 The Deligne groupoid and its representation

In §6 we will discuss the chain complex with coefficients in a local system. For the purposes, the structure of the fundamental group  $\pi_1(\mathbf{M}(\mathcal{A}))$  is particularly important. The concept of “the Deligne groupoid”  $\text{Gal}(\mathcal{A})$  for a real arrangement  $\mathcal{A}$ , introduced by P. Deligne [De] see also [Pa2], and its representations are good tools for extracting information about the fundamental groups and local systems.

A sequence  $C_0, C_1, \dots, C_n$  of chambers is a *gallery*  $G$  of length  $n$  (from  $C_0$  to  $C_n$ ) if  $C_i$  and  $C_{i+1}$  are adjacent for  $i = 0, 1, \dots, n-1$ . Any continuous path in  $U = V_{\mathbb{R}} \setminus \bigcup_{X \in \mathcal{L}, \text{codim } X \geq 2} X$  which is transverse to any codimension one faces determines a gallery and every gallery arises in this way. Any two chambers can be connected by galleries. The distance between two chambers  $C$  and  $C'$  is the length of a shortest gallery connecting them; equivalently, it is the number of hyperplanes separating  $C$  and  $C'$ . A gallery is said to be geodesic, or minimal, if its length is equal to the distance between the initial and terminal chambers.

**Definition 3.3.1** [De]

- (1) Let  $G = (C_0, C_1, \dots, C_m)$  and  $G' = (C'_0, C'_1, \dots, C'_n)$  be two galleries. If  $C_m = C'_0$ , define the composition of  $G$  and  $G'$  by  $GG' := (C_0, \dots, C_m = C'_0, C'_1, \dots, C'_n)$ .

- (2) Two galleries  $G$  and  $G'$  which have the same initial and terminal chambers are called *equivalent*, denoted by  $G \sim G'$ , if there exists a sequence of galleries  $G = G_0, G_1, \dots, G_N = G'$  such that for each  $i = 0, \dots, N - 1$ ,  $G_i$  and  $G_{i+1}$  have expressions

$$\begin{aligned} G_i &= E_1 F E_2 \\ G_{i+1} &= E_1 F' E_2, \end{aligned}$$

where  $F$  and  $F'$  are geodesic galleries connecting the same initial and terminal chambers.

- (3)  $\text{Gal}^+(\mathcal{A})$  is defined to be the category whose objects are chambers  $\text{ch}(\mathcal{A})$  and morphisms are

$$\text{Hom}_{\text{Gal}^+}(C, C') = \{\text{Galleries from } C \text{ to } C'\} / \sim .$$

Since a composition of galleries is compatible with  $\sim$ , compositions of  $\text{Hom}_{\text{Gal}^+}$  is well-defined.

- (4) The *Deligne groupoid* is a category  $\text{Gal}(\mathcal{A})$  with a functor  $Q : \text{Gal}^+(\mathcal{A}) \rightarrow \text{Gal}(\mathcal{A})$  such that

- $Q(s) \in \text{Hom}_{\text{Gal}}$  is an isomorphism for every  $s \in \text{Hom}_{\text{Gal}^+}$ .
- Any functor  $\Psi : \text{Gal}^+ \rightarrow \mathcal{C}$  such that  $\Psi(s)$  is an isomorphism for all  $s \in \text{Hom}_{\text{Gal}^+}$  factors uniquely through  $Q$ .

See [Pa1] and [Pa2] more on the construction of  $\text{Gal}(\mathcal{A})$ . The Deligne groupoid  $\text{Gal}(\mathcal{A})$  is, roughly, obtained from  $\text{Gal}^+(\mathcal{A})$  by inverting all morphisms. If  $\mathcal{A}$  is a simplicial arrangement, then the functor  $Q : \text{Gal}^+(\mathcal{A}) \rightarrow \text{Gal}(\mathcal{A})$  is faithful [De]. However, it is worth noting that  $Q$  is not necessarily faithful; moreover  $\text{Gal}^+$  is not cancellative. For example, consider the following two galleries

$$G := C_2 C_1 C_2 C_3 C_2 \quad \text{and} \quad G' := C_2 C_3 C_2 C_1 C_2$$

in the arrangement illustrated in Figure 1. Obviously  $G$  and  $G'$  are not equivalent in  $\text{Hom}_{\text{Gal}^+}(C_2, C_2)$ . But concatenations  $(C_5 C_2)G$  and  $(C_5 C_2)G'$

are equivalent, indeed,

$$\begin{aligned}
(C_5C_2)G &= C_5C_2C_1C_2C_3C_2 \\
&= C_5C_4C_1C_2C_3C_2 = (C_5C_4)(C_4C_1C_2C_3)(C_3C_2) \\
&= (C_5C_4)(C_4C_7C_6C_3)(C_3C_2) = (C_5C_4C_7)(C_7C_6C_3C_2) \\
&= (C_5C_6C_7)(C_7C_4C_1C_2) = (C_5C_6)(C_6C_7C_4C_1)(C_1C_2) \\
&= (C_5C_6)(C_6C_3C_2C_1)(C_1C_2) = (C_5C_6C_3)(C_3C_2C_1C_2) \\
&= (C_5C_2C_3)(C_3C_2C_1C_2) = (C_5C_2)G'.
\end{aligned}$$

Since  $(C_5C_2)$  is invertible in  $\text{Gal}(\mathcal{A})$ ,  $G$  and  $G'$  determine the same element in  $\text{Hom}_{\text{Gal}}(C_2, C_2)$ .

Let  $C, C' \in \text{ch}(\mathcal{A})$ . It follows from the definition that any geodesic connecting  $C$  to  $C'$  are equivalent to each other. So geodesics from  $C$  to  $C'$  determine an equivalence class. We denote this equivalence class by  $P^+(C, C') \in \text{Hom}_{\text{Gal}}(C, C')$ , and its inverse by  $P^-(C', C) := P^+(C, C')^{-1} \in \text{Hom}_{\text{Gal}}(C', C)$ .

**Example 3.3.2** In Figure 4 galleries  $(C_4, C_3, C_2, C_1)$  and  $(C_4, C_5, C_6, C_1)$  are geodesics. Hence they determine the same element  $P^+(C_4, C_1) \in \text{Hom}_{\text{Gal}}(C_4, C_1)$ .

Let  $\mathcal{G}$  be a groupoid and  $x$  be an object. Then  $\text{Hom}_{\mathcal{G}}(x, x)$  is a group and called the *vertex group at  $x$* . The vertex group of the Deligne groupoid  $\text{Gal}(\mathcal{A})$  at a chamber is actually isomorphic to the fundamental group of the complexified complement  $\mathbf{M}(\mathcal{A})$  [Pa1, Pa2]:

$$\text{Hom}_{\text{Gal}}(C, C) \cong \pi_1(\mathbf{M}(\mathcal{A})).$$

Moreover we have,

**Theorem 3.3.3** *Let  $X = X(\mathcal{A})$  be the Salvetti complex as in Theorem 3.2.3. Let  $\mathcal{G}(X)$  be the groupoid whose objects are 0-cells  $X_0$  and homomorphisms are the set of homotopy equivalence classes of paths between two 0-cells. Then  $\mathcal{G}(X(\mathcal{A}))$  is equivalent to the Deligne groupoid  $\text{Gal}(\mathcal{A})$ .*

Recall that a representation  $\Phi$  of a category  $\mathcal{C}$  is a functor  $\Phi : \mathcal{C} \rightarrow \text{Vect}_{\mathbb{K}}$  from  $\mathcal{C}$  to the category of  $\mathbb{K}$ -vector spaces.  $\Phi$  is given by a vector space  $\Phi_x$  for each object  $x \in \mathcal{C}$  and a linear map  $\Phi_{\rho} : \Phi_x \rightarrow \Phi_y$  for each  $\rho \in \text{Hom}_{\mathcal{C}}(x, y)$  such that  $\Phi_{\rho_1\rho_2} = \Phi_{\rho_1} \circ \Phi_{\rho_2}$ .

Let  $\mathcal{G}$  be a groupoid with a vertex group  $G_x = \text{Hom}(x, x)$ . Then the category of representations  $\text{Rep}(\mathcal{G})$  of  $\mathcal{G}$  is equivalent to the category of group

representations  $\text{Rep}(G_x)$ . Since the category of representations of the fundamental group of a topological space is equivalent to that of local systems over the space, we have the following result.

**Proposition 3.3.4** *Let  $\mathcal{A}$  be a real arrangement. Then the following categories are equivalent.*

- $\text{Rep}(\text{Gal}(\mathcal{A}))$  : the category of representations of the Deligne groupoid.
- $\text{Rep}(\pi_1(\mathbf{M}(\mathcal{A})))$  : the category of representations of the fundamental group.
- $\text{Loc}(\mathbf{M}(\mathcal{A}))$  : the category of local systems.

In §6, we will use representations of the Deligne groupoid instead of local systems to compute the boundary maps for cellular chain complexes. The following operator will be needed for the purpose of describing the cellular boundary map.

Let  $\Phi : \text{Gal}(\mathcal{A}) \rightarrow \text{Vect}_{\mathbb{K}}$  be a representation of the Deligne groupoid. Given two chambers  $C$  and  $C'$ , we have two extreme morphisms  $P^{\pm}(C, C') : C \rightarrow C'$ . Hence we have linear maps

$$\Phi_{P^{\pm}(C, C')} : \Phi(C) \longrightarrow \Phi(C').$$

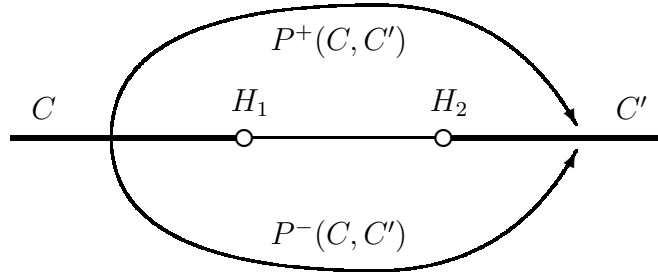

Figure 5:  $P^+(C, C')$  and  $P^-(C, C')$

**Definition 3.3.5** (The *skein operator*).

$$\Delta_{\Phi}(C, C') := \Phi_{P^+(C, C')} - \Phi_{P^-(C, C')}.$$

## 4 Morse theory on the complement

Throughout this section, we investigate complex hyperplane arrangements which do not necessarily arise from real arrangements.

### 4.1 The Lefschetz Theorem for hyperplane complements

In this section we give a proof of the Lefschetz theorem for  $\mathbf{M}(\mathcal{A})$  following Hamm and Lê [HL]. Although this is just a version of The Lefschetz Theorem for affine varieties, Morse theoretic arguments and constructions in this section will be needed in §4.3.

Let  $\mathcal{A} = \{H_1, \dots, H_n\}$  be an arrangement of hyperplanes in  $\mathbb{P}^\ell$ . Let  $\alpha_i$  be a linear form in  $\mathbb{C}[z_0, z_1, \dots, z_\ell]$  defining  $H_i$  and  $Q$  denote the product  $\alpha_1 \alpha_2 \cdots \alpha_n$  of these linear forms. Let  $V(Q)$  be the union  $\bigcup_{i=1}^n H_i$  of hyperplanes and  $\mathbf{M}(Q) = \mathbb{P}^\ell - V(Q)$  denote the complement. There exists an obvious stratification  $\Sigma(\mathcal{A})$  of the union as follows. Given an intersection  $X \in L(\mathcal{A})$  of some hyperplanes in  $\mathcal{A}$ , define

$$S_X := X - \bigcup_{H \not\supset X} H.$$

We have a partition  $\{S_X\}_{X \in L(\mathcal{A})}$  of  $\mathbb{P}^\ell$ .

**Lemma 4.1.1** *For an arrangement  $\mathcal{A}$ , the above stratification  $\Sigma(\mathcal{A}) = \{S_X\}_{X \in L(\mathcal{A})}$  is a good stratification at each point  $p \in V = V(Q)$ , i.e. there exist a neighborhood  $\mathcal{U} \ni p$  and a holomorphic function  $h$  on  $\mathcal{U}$  with  $V(h) = \mathcal{U} \cap V(Q)$  satisfying the following Thom's condition ( $a_h$ ):*

( $a_h$ ) *If  $p_i$  is a sequence of points in  $\mathcal{U} - V(h)$  such that  $p_i \rightarrow p \in S_X$  and  $T_{p_i}V(h - h(p_i))$  converges to some hyperplane  $\mathcal{T}$ , then  $T_p S_X \subset \mathcal{T}$ .*

The rest of this section is devoted to proving the following theorem ([Ha, HL, DP1, Ra2]).

**Theorem 4.1.2** (i) *Let  $F = V(f) \subset \mathbb{P}^\ell$  be a hyperplane defined by a linear form  $f$  which is transverse to each stratum. Then  $\mathbf{M}(Q)$  has the homotopy type of a space obtained from  $\mathbf{M}(Q) \cap F$  by attaching a certain number of  $\ell$ -dimensional cells.*



(ii) Moreover the number of  $\ell$ -cells is the  $\ell$ -th Betti number  $b_\ell(\mathbf{M}(Q))$ .

(ii) is proved in §1. The plan of the proof of (i) is to apply Morse theory to a function of the form

$$\varphi(x) = \left| \frac{f(x)^{\lambda_0}}{\alpha_1^{\lambda_1} \cdots \alpha_n^{\lambda_n}} \right|^2, \text{ for } x \in \mathbf{M}(g), \quad (7)$$

where  $\lambda_1, \dots, \lambda_n \in \mathbb{Z}_{>0}$  are appropriately chosen positive integers and  $\lambda_0 = \lambda_1 + \cdots + \lambda_n$ . Note that  $\varphi$  is a well-defined differentiable map from  $\mathbf{M}(Q)$  to  $\mathbb{R}_{\geq 0}$  which has the bottom  $F \cap \mathbf{M}(Q) = \varphi^{-1}(0)$ . The reason for considering this function is that the critical points are well studied, in particular, critical points are known to be nondegenerate for generic  $\lambda_1, \dots, \lambda_n$ . It was conjectured by Varchenko [Va], and proved by Orlik-Terao [OT2] and Silvotti [Si].

**Theorem 4.1.3** *Let  $\mathcal{A}$  be a complex essential affine arrangement in  $\mathbb{C}^\ell$  with defining linear equations  $f_1, \dots, f_N$ , and put*

$$\Phi_\lambda = f_1^{\lambda_1} f_2^{\lambda_2} \cdots f_N^{\lambda_N}$$

for  $\lambda = (\lambda_1, \dots, \lambda_N) \in \mathbb{C}^N$ . Then there exists a Zariski-closed algebraic proper subset  $Y$  of  $\mathbb{C}^N$ , such that for  $\lambda \in \mathbb{C}^N - Y$ ,  $\Phi_\lambda$  has only finitely many critical points, all of which are nondegenerate and the number of critical points of  $\Phi_\lambda$  is  $|\chi(\mathbf{M}(\mathcal{A}))|$ .

In our situation, since

$$\Phi_\lambda = \frac{f^{\lambda_0}}{\alpha_1^{\lambda_1} \cdots \alpha_n^{\lambda_n}} = (\alpha_1/f)^{-\lambda_1} \cdots (\alpha_n/f)^{-\lambda_n},$$

there exist  $\lambda_1, \dots, \lambda_n \in \mathbb{Z}_{>0}$  such that  $\Phi_\lambda$  has only nondegenerate critical points. Combining the above theorem with Proposition 2.3.2, the number of critical points is shown to be equal to the  $\ell$ -th Betti number  $b_\ell(\mathbf{M}(Q))$  of the complement. From the next lemma,  $\varphi = |\Phi_\lambda|$  also has only finitely many critical points all of which are nondegenerate critical points of Morse index  $\ell$ .

**Lemma 4.1.4** *Let  $\mathfrak{f}$  and  $\mathfrak{g} : U \rightarrow \mathbb{C}$  be holomorphic functions defined on a neighborhood  $U$  of  $0 \in \mathbb{C}^n$ . We assume  $\mathfrak{f}(0), \mathfrak{g}(0) \neq 0$ .*

- (i)  $0 \in U$  is a critical point of  $|f|^2$  if and only if  $0 \in U$  is a critical point of  $f$ .
- (ii) In (i),  $0 \in U$  is a nondegenerate critical point of  $|f|^2$  if and only if  $0 \in U$  is a nondegenerate critical point of  $f$ .
- (iii) If  $0 \in U$  is a nondegenerate critical point of  $|f|^2$ , then the Morse index is  $n$ .
- (iv) If  $df$  and  $d\bar{g}$  are linearly independent over  $\mathbb{C}$  at each point in  $U$ , then so are  $d|f|$  and  $d|g|$ .

**Proof.** Since  $|f|^2 = f \cdot \bar{f}$ ,  $\frac{\partial}{\partial z_i} |f|^2 = \frac{\partial f}{\partial z_i} \bar{f}$  and  $\frac{\partial}{\partial \bar{z}_i} |f|^2 = \frac{\partial \bar{f}}{\partial \bar{z}_i} f$ . Thus we have (i). Moreover the determinant of the Hessian matrix at  $0 \in U$  is

$$\begin{aligned} \det \begin{pmatrix} \frac{\partial^2 |f|^2}{\partial z_i \partial z_j} & \frac{\partial^2 |f|^2}{\partial z_i \partial \bar{z}_j} \\ \frac{\partial^2 |f|^2}{\partial \bar{z}_i \partial z_j} & \frac{\partial^2 |f|^2}{\partial \bar{z}_i \partial \bar{z}_j} \end{pmatrix} &= \det \begin{pmatrix} \frac{\partial^2 f}{\partial z_i \partial z_j} \bar{f} & \frac{\partial f}{\partial z_i} \frac{\partial \bar{f}}{\partial \bar{z}_j} \\ \frac{\partial \bar{f}}{\partial \bar{z}_i} \frac{\partial f}{\partial z_j} & \frac{\partial^2 \bar{f}}{\partial \bar{z}_i \partial \bar{z}_j} f \end{pmatrix} \\ &= |f|^2 \left| \det \begin{pmatrix} \frac{\partial^2 f}{\partial z_i \partial z_j} \end{pmatrix} \right|^2. \end{aligned}$$

(Here we use  $\frac{\partial f}{\partial \bar{z}_i} = \frac{\partial \bar{f}}{\partial z_i} = 0$ .) This proves (ii).

After a linear change of coordinates, we may assume  $f$  is expressed as

$$f(z_1, \dots, z_n) = c(1 + \sum_{i=1}^n z_i^2 + O(3))$$

with  $c \neq 0$ . Writing  $z_i = x_i + \sqrt{-1}y_i$ , we have

$$\begin{aligned} f\bar{f} &= |c|^2(1 + \sum_{i=1}^n (z_i^2 + \bar{z}_i^2) + O(3)) \\ &= |c|^2(1 + 2 \sum_{i=1}^n (x_i^2 - y_i^2) + O(3)). \end{aligned}$$

Consequently the Morse index of  $|f|^2$  at  $0$  is equal to  $n$ .

(iv) is clear from  $d(|f|^2) = (df)\bar{f} + f(d\bar{f})$ .  $\square$

Unfortunately, our Morse function  $\varphi = |\Phi_\lambda|$  is not a proper function. Hence it is necessary to study the Morse theory for a nonproper Morse function. This difficulty is directly related to the fact that  $\varphi$  has points of indeterminacy:  $V(f, Q) = \{f = Q = 0\} = V(Q) \cap F$ . To deal with the difficulty,

we have to remove a neighborhood of  $V(Q) \cap F$  for separating the zero loci and the poles of  $\varphi$ . The idea is to measure the distance from  $V_1 := V(f, Q)$ . Suppose  $p = [z_0 : \cdots : z_\ell] \in \mathbb{P}^\ell - V_1$ , and define  $h_{V_1}(p)$  as follows

$$h_{V_1}(p) = \frac{|z_0|^{\lambda_0} + |z_1|^{\lambda_0} + \cdots + |z_\ell|^{\lambda_0}}{|f|^{\lambda_0} + |\alpha_1^{\lambda_1} \cdots \alpha_n^{\lambda_n}|}.$$

Then  $h_{V_1} : (\mathbb{P}^\ell - V_1) \rightarrow \mathbb{R}_{\geq 0}$  is a well-defined map.

**Lemma 4.1.5** *Let  $M^{\leq t} := \{p \in \mathbb{P}^\ell - V_1; h_{V_1}(p) \leq t\}$ . For sufficiently large  $t \gg 0$ ,  $h_{V_1}^{-1}(t) = \partial M^{\leq t}$  is transverse to each stratum  $S \in \Sigma$  and to  $F$ . Moreover  $(\mathbb{P}^\ell - V_1, (\mathbb{P}^\ell - V_1) \cap \Sigma)$  is diffeomorphic to  $(M^{< t}, M^{< t} \cap \Sigma)$  as stratified manifolds.*

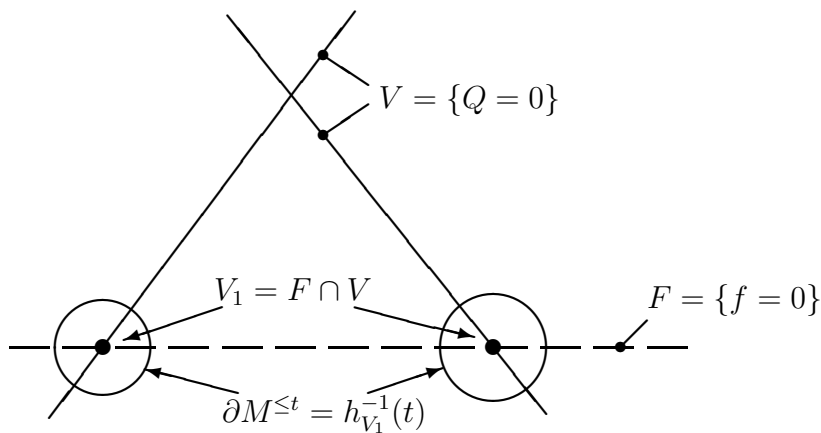

Figure 6:

**Proof.** We first observe that  $h_{V_1}$  is defined on  $\mathbb{P}^\ell - V_1$  with values in  $\mathbb{R}_{>0}$ . It is clear that for a sequence  $\{p_i\} \subset \mathbb{P}^\ell - V_1$  converging to a point  $p \in V_1$ , we have  $h_{V_1}(p_i) \rightarrow \infty$  as  $i \rightarrow \infty$ . Recall that any real polynomial function on a semi-algebraic set can have at most a finite number of critical values (see Milnor [Mi2, Cor. 2.8]). Since any restriction  $h_{V_1}|_S$  to a stratum  $S \in \Sigma$  has only finitely many critical values, we may choose  $t$  to be larger than any critical value. Suppose  $t_1$  and  $t_2$  ( $t_1 < t_2$ ) are sufficiently large. Then there exists an open neighborhood  $U$  of the compact set  $M^{[t_1, t_2]} := \{p; t_1 \leq h_{V_1}(p) \leq t_2\}$  such that the restriction of  $h_{V_1}$  to  $U \cap S$  has no critical points for any stratum  $S \in \Sigma$ .

The gradient vector field  $-\text{grad } h_{V_1}$  does not preserve the stratification in general. We modify  $-\text{grad } h_{V_1}$  so that it preserves the stratification. Let  $p \in U$  and  $S$  denote the stratum which contains  $p$ . Since  $p$  is not a critical point of  $h_{V_1}|_S$ , there exists a tangent vector  $v \in T_p S$  such that  $v \cdot \varphi < 0$ . On a small neighborhood  $U_p$  of  $p$  in  $U$ , not meeting any smaller stratum than  $S$ , we have a vector field  $\tilde{v}$  such that

- (i)  $\tilde{v}$  is tangent to each stratum  $\Sigma \cap U_p$ ,
- (ii)  $\tilde{v} \cdot \varphi < 0$ .

Note that since our strata are linear, we can take  $\tilde{v}$  as a constant vector field in a certain open set.

Using a partition of unity, we have a vector field  $\tilde{v}$  on  $U$  satisfying the conditions (i) and (ii) above. Then  $\tilde{v}/\|\tilde{v}\|$  defines a deformation retract of  $M^{<t_2}$  onto  $M^{<t_1}$ , which preserves the structure of stratification.  $\square$

Now we consider the function  $\varphi$  on  $M^{\leq t}$  and the restriction to its boundary  $\partial M^{\leq t} = h_{V_1}^{-1}(t)$ . The following lemma plays a key role in the arguments below. The assumption that  $F$  is generic is used in the proof.

**Lemma 4.1.6** *For sufficiently large  $t \gg 0$ ,  $\varphi|_{\partial M^{\leq t} \setminus (V(Q) \cup F)}$  has no critical points.*

**Proof.** Let  $p \in V_1 = V \cap F$  and  $S_X \in \Sigma$  be the stratum containing  $p$ . Note that  $X \in L(\mathcal{A})$  is the smallest intersection containing  $p$ , and it is, by definition, transverse to  $F$ . We have coordinates  $(z_1, \dots, z_\ell)$  in a neighborhood  $U$  of  $p$  with the origin at  $p$ . The transversality of  $F$  to  $\Sigma$  allows us to assume that

- (1)  $F \cap U$  is defined by a linear form  $z_\ell = 0$ .
- (2)  $X \cap U$  is defined by  $\{z_1 = z_2 = \dots = z_m = 0\}$  with  $1 \leq m < \ell$ .
- (3) Let  $H_1, \dots, H_k$  be the set of all hyperplanes in  $\mathcal{A}$  which contains  $p$ . Each  $H_i \cap U$  is defined by a linear form of the form  $a_1 z_1 + \dots + a_m z_m$ .

For simplicity, set  $g_1 = \alpha_1^{\lambda_1} \dots \alpha_k^{\lambda_k}$  and  $g_2 = z_\ell^{\lambda_0}$ . The assumptions imply that  $d|g_1|$  and  $d|g_2|$  are linearly independent at each point of  $U - (V(Q) \cup F)$ . Now  $h_{V_1}$  and  $\varphi$  are expressed as

$$\begin{aligned}
h_{V_1} &= \frac{1 + |z_1|^{\lambda_0} + \cdots + |z_\ell|^{\lambda_0}}{|g_1| + |g_2|} \\
\varphi &= \frac{|g_2|}{|g_1|}.
\end{aligned}$$

Now we prove that there exists a neighborhood  $U'$  of  $p$  such that  $dh_{V_1}$  and  $d\varphi$  are linearly independent at each point of  $U' - (V(Q) \cup F)$ .

$$d \log h_{V_1} = -\frac{d|g_1| + d|g_2|}{|g_1| + |g_2|} + d \log(1 + |z_1|^{\lambda_0} \cdots + |z_\ell|^{\lambda_0}) \quad (8)$$

$$d \log \varphi = -\frac{d|g_2|}{|g_2|} + \frac{d|g_1|}{|g_1|}. \quad (9)$$

If  $U'$  is sufficiently small, then the last term of (8) is sufficiently small. Compare the sign of coefficients of  $d|g_1|$  and  $d|g_2|$ , we conclude that  $dh_{V_1}$  and  $d\varphi$  are linearly independent. Thus for any point  $p \in F \cap V(Q)$ , there exists a neighborhood  $U_p$  in  $\mathbb{P}_{\mathbb{C}}^\ell$  such that  $d\varphi$  and  $dh_{V_1}$  are linearly independent at each point of  $U_p - (V(Q) \cup F)$ . We choose finitely many points  $p_1, \dots, p_N \in V(Q) \cap F$  with  $V(Q) \cap F \subset \bigcup_{i=1}^N U_{p_i}$  and set  $t_0 := \sup\{h_{V_1}(p); p \in \mathbb{P}_{\mathbb{C}}^\ell - \bigcup_{i=1}^N U_{p_i}\}$ . Then for  $t > t_0$ ,  $\varphi|_{\partial M^{\leq t} \setminus (V(Q) \cup F)}$  has no critical points.  $\square$

The transversality  $F \pitchfork \partial M^{\leq t}$  is also shown by observing (8). Hence a small tubular neighborhood of  $F \cap \partial M^{\leq t}$  in  $\partial M^{\leq t}$  is diffeomorphic to a disk bundle over  $F \cap \partial M^{\leq t}$ . Recall that the normal bundle of  $F$  in  $\mathbb{P}_{\mathbb{C}}^\ell$  is  $\mathcal{N}_{F/\mathbb{P}_{\mathbb{C}}^\ell} \cong \mathcal{O}_F(1)$  and is trivial on an affine open set  $F - V(Q)$ . Thus we have:

**Lemma 4.1.7** *There exists a small neighborhood  $\mathcal{T}$  of  $F$  in  $\mathbb{P}_{\mathbb{C}}^\ell$  such that*

$$\mathcal{T} \cap M^{\leq t} \cong (F \cap M^{\leq t}) \times D^2 \text{ (Diffeomorphic)}, \quad (10)$$

where  $D^2 = \{(x, y) \in \mathbb{R}^2; x^2 + y^2 < 1\}$  is the unit disk.

Now we return to the proof of Lefschetz's Theorem 4.1.2. Fix a sufficiently large  $t \gg 0$  and set  $N = M^{\leq t} \cap M(Q)$ . Consider the gradient vector field  $X = -\text{grad } \varphi$ .  $X$  is not tangent to the boundary  $\partial N$  in general, so we comb the vector field in order to make it neat as in the proof of Lemma 4.1.5.

Lemma 4.1.6 means that  $d\phi$  is not orthogonal to  $\partial N$ . Thus by an argument similar to that in the proof of Lemma 4.1.5, modifying  $X$  around  $\partial N$ , we have a vector field  $\mathcal{X}$  on  $N$  which is tangent to  $\partial N$ . Moreover, there exists a vector field  $\mathcal{X}$  which satisfies the following conditions (Fig. 7):

- (a) There exists a neighborhood  $U$  of  $\partial N \cup (N \cap F)$  such that  $\mathcal{X} = X = -\text{grad } \varphi$  outside  $U$  and  $\text{Crit}(\varphi) \cap \bar{U} = \emptyset$ , where  $\text{Crit}(\varphi)$  is the set of critical points of  $\varphi$  in  $M(Q) - F$ .
- (b)  $\mathcal{X}$  is tangent to  $\partial N$ .
- (c)  $\mathcal{X}\varphi < 0$  on  $N - (F \cup \text{Crit}(\varphi))$ .
- (d) Under the diffeomorphism (10), the vector field  $\mathcal{X}$  coincides with the negative vertical Euler vector field  $-x\frac{\partial}{\partial x} - y\frac{\partial}{\partial y}$ .

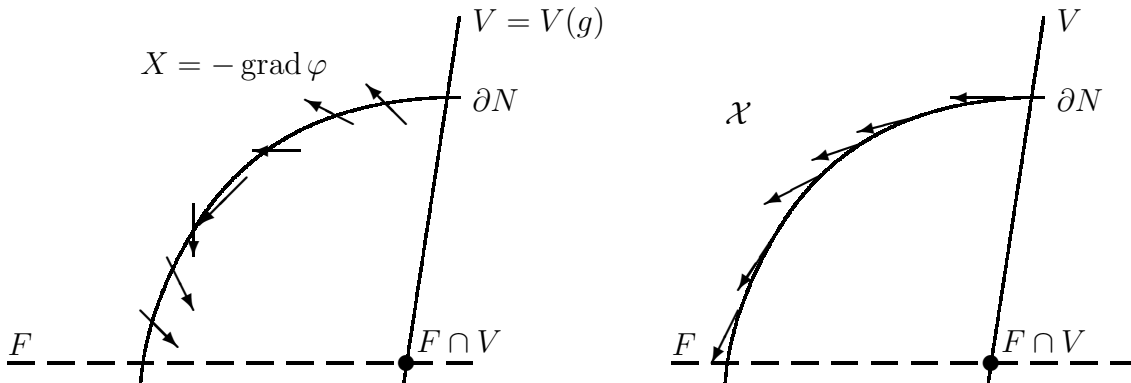

Figure 7: Modified vector field

We now complete the proof of Theorem 4.1.2. We consider  $\mathcal{X}$  as the negative gradient vector field of a Morse function on  $N$  and define

$$N^{\leq s} := \{p \in N; \varphi(p) \leq s\},$$

for  $s > 0$ . If there is no critical value in the interval  $[s_1, s_2]$ , then the vector field  $\mathcal{X}$  induces a retraction  $N^{\leq s_2} \xrightarrow{\cong} N^{\leq s_1}$ . If there is only one critical point within the interval  $[s_1, s_2]$ , then the homotopy type of  $N^{\leq s_2}$  is obtained from that of  $N^{\leq s_1}$  by attaching an  $\ell$ -cell. This completes the proof of Lefschetz's hyperplane section theorem.  $\square$

## 4.2 Stable and unstable manifolds

Consider the flow of  $\mathcal{X}$ :

$$\begin{aligned}\phi_t : N &\longrightarrow N, \quad t \in \mathbb{R} \\ \frac{\partial}{\partial t} \phi_t(x) &= \mathcal{X}_{\phi_t(x)}, \quad \phi_0 = \text{id}_N.\end{aligned}$$

If  $p \in N - F$  is a critical point of  $\varphi$ , we define the stable manifold  $W_p^s$  and unstable manifold  $W_p^u$  as

$$\begin{aligned}W_p^s &= \{x \in N; \lim_{t \rightarrow \infty} \phi_t(x) = p\} \\ W_p^u &= \{x \in N; \lim_{t \rightarrow -\infty} \phi_t(x) = p\}.\end{aligned}$$

These are  $\ell$ -dimensional (over  $\mathbb{R}$ ) submanifolds in  $N$ . Recall that the vector field  $\mathcal{X}$  is said to satisfy the *Morse-Smale condition* if the stable and unstable manifolds intersect transversely. But in our case, since any critical point in  $N - F$  has the middle index  $\ell$ , it seems reasonable to define as follows.

**Definition 4.2.1** Let  $\mathcal{X}$  be a vector field on  $N$  as in the previous section, it is said to satisfy the *Morse-Smale condition* if there does not exist a flow line connecting distinct points in  $\text{Crit}(\varphi)$ . In other words, there does not exist  $x \in N - (F \cup \text{Crit}(\varphi))$  such that both  $\lim_{t \rightarrow \infty} \phi_t(x)$  and  $\lim_{t \rightarrow -\infty} \phi_t(x)$  are contained in  $\text{Crit}(\varphi)$ .

Recall that for a critical point  $p \in \text{Crit}(\varphi)$ ,  $N^{\leq \varphi(p)+\epsilon}$  is homotopy equivalent to  $N^{\leq \varphi(p)-\epsilon} \cup W_p^u$  (see [Mi1, Thm. 3.2]) and that unstable manifolds are preserved by the action of  $\phi_t$ . Hence under the Morse-Smale condition, the boundary of an unstable manifold  $W_p^u$  should be attached to  $N^0 \subset F \cap \mathbf{M}(Q)$ . Thus we have:

**Theorem 4.2.2** *If  $\mathcal{X}$  satisfies the Morse-Smale condition, then  $\mathbf{M}(Q)$  is homotopy equivalent to*

$$(F_{\mathbb{C}} \cap \mathbf{M}(Q)) \cup \bigcup_{p \in \text{Crit}(\varphi)} W_p^u.$$

**Theorem 4.2.3**  *$\mathbf{M}(Q) - \bigcup_{p \in \text{Crit}(\varphi)} W_p^s$  is diffeomorphic to  $(\mathbf{M}(Q) \cap F_{\mathbb{C}}) \times \mathbb{D}^2$ .*

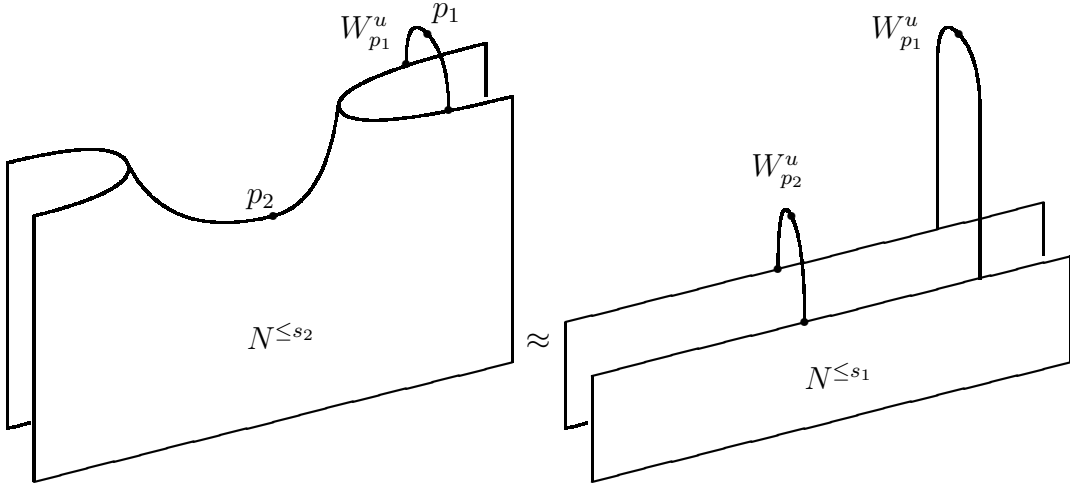

Figure 8: Unstable manifolds

**Proof.** Let  $\mathcal{T}$  be a tubular neighborhood of  $F_{\mathbb{C}} \cap \mathbf{M}(Q)$  in  $\mathbf{M}(Q)$  as in Lemma 4.1.7. Since  $\mathcal{X}$  is a complete vector field,

$$\begin{aligned} (\partial\mathcal{T} \cap N) \times \mathbb{R} &\longrightarrow N - \left( F_{\mathbb{C}} \cup \bigcup_{p \in \text{Crit}(\phi)} W_p^s \right) \\ (q, t) &\longmapsto \phi_t(q) \end{aligned}$$

defines a diffeomorphism. It is also diffeomorphic to  $(F_{\mathbb{C}} \cap N) \times (\mathbb{D}^2 - \{(0, 0)\})$ . The condition (d) on  $\mathcal{X}$  allows us to complete the proof.  $\square$

### 4.3 Homotopy types of the unstable cells

Next we characterize the homotopy types of unstable manifolds  $\{W_p^u; p \in \text{Crit}(\varphi)\}$ . The unstable manifold  $W_p^u$  corresponding to  $p \in \text{Crit}(\varphi)$  can be considered as an attached cell. There exists a continuous map  $\sigma_p : (\mathbb{D}^\ell, \partial\mathbb{D}^\ell) \rightarrow (\mathbf{M}(Q), F \cap \mathbf{M}(Q))$  such that  $\sigma_p(0) = p$  and  $\sigma_p$  induces a diffeomorphism of  $\text{int}(\mathbb{D}^\ell)$  to  $W_p^u$ . We now assume that our manifolds are oriented. Observe that  $\sigma_p$  satisfies the following properties:

- (i)  $\sigma_p(0) = p$  and  $\sigma_p(\mathbb{D}^\ell) \cap W_p^s = \{p\}$ .
- (ii)  $\sigma_p(\mathbb{D}^\ell)$  intersects  $W_p^s$  at  $p$  transversally and positively.
- (iii)  $\sigma_p(\partial\mathbb{D}^\ell) \subset F \cap \mathbf{M}(Q)$ .



(iv) If  $q \in \text{Crit}(\varphi) \setminus \{p\}$  is another critical point, then  $\sigma_p(\mathbb{D}^\ell)$  does not intersect  $W_q^s$ .

Note that (iv) is equivalent to the Morse-Smale condition ( $W_p^u \cap W_q^s = \emptyset$ ). Let us call these properties “set-theoretical duality” between cells  $\{\sigma_p\}_{p \in \text{Crit}(\varphi)}$  and stable manifolds  $\{W_p^s\}_{p \in \text{Crit}(\varphi)}$ . The main result of this section is to characterize the homotopy type of the map  $\sigma_p : (\mathbb{D}^\ell, \partial\mathbb{D}^\ell) \rightarrow (N, N \cap F)$  by set-theoretical duality for stable manifolds.

**Theorem 4.3.1** *Suppose that a continuous map  $\sigma'_p : (\mathbb{D}^\ell, \partial\mathbb{D}^\ell) \rightarrow (N, N \cap F)$  is differentiable in a neighborhood of  $0 \in \mathbb{D}^\ell$  and satisfies conditions (i) through (iv) above. Then  $\partial\sigma_p$  and  $\partial\sigma'_p : \partial\mathbb{D}^\ell \rightarrow N \cap F$  are homotopic. In particular,*

$$\mathbf{M}(\mathcal{A}) \text{ and } (\mathbf{M}(\mathcal{A}) \cap F_{\mathbb{C}}) \cup_{(\partial\sigma'_p)} \left( \coprod_{p \in \text{Crit}(\phi)} \mathbb{D}^\ell \right)$$

are homotopy equivalent.

**Proof.** The idea of the proof is simple: flowing  $\sigma'_p$  via the gradient flow  $\phi_t$ , then  $\phi_t \circ \sigma'_p$  converges to  $\sigma_p$  as  $t \rightarrow \infty$ .

From (i), we have  $\sigma'_p(0) = \sigma_p(0) = p$  and the image  $\sigma'_p(\mathbb{D}^\ell)$  is transverse to  $W_p^s$ . Note that  $\mathbb{T}_p \mathbb{P}_{\mathbb{C}}^\ell = \mathbb{T}_p W_p^u \oplus \mathbb{T}_p W_p^s$ . And the projection  $\mathbb{T}_p \mathbb{P}^\ell \rightarrow \mathbb{T}_p W_p^u$  induces an orientation preserving isomorphism  $\mathbb{T}_p \sigma'_p(\mathbb{D}^\ell) \cong \mathbb{T}_p W_p^u$ . By modifying  $\sigma'_p$  up to homotopy, we have  $\sigma''_p$  satisfying (i)  $\cdots$  (iv) and the following properties:

$$\sigma''_p(x) = \begin{cases} \sigma_p(x) & \text{if } \|x\| < \epsilon \\ \sigma'_p(x) & \text{if } 2\epsilon \leq \|x\| \leq 1, \end{cases}$$

where  $\|x\|^2 = x_1^2 + \cdots + x_\ell^2$  and  $\epsilon$  is a sufficiently small positive number. Take a tubular neighborhood  $\mathcal{T}$  of  $F \cap N$  such that  $\mathcal{T} = (F \cap N) \times \mathbb{D}^2$  as in Lemma 4.1.7. Denote by  $\pi : \mathcal{T} = (F \cap N) \times \mathbb{D}^2 \rightarrow F \cap N$  the projection. Consider  $\phi_t \circ \sigma''_p$ . If  $t \gg 0$  is sufficiently large then we may assume that  $\phi_t \circ \sigma''_p(x) \in \mathcal{T}$  for  $\epsilon \leq \|x\| \leq 1$ . By definition,  $(\pi \circ \phi_t \circ \sigma''_p)|_{\|x\|=\epsilon}$  is equal to  $\partial\sigma_p = \sigma_p|_{\partial\mathbb{D}^\ell}$  as maps  $S^\ell \rightarrow F \cap N$ , more precisely, for  $x \in \partial\mathbb{D}^\ell$ ,  $(\pi \circ \phi_t \circ \sigma''_p)(\epsilon x) = \partial\sigma_p(x)$ . Since  $(\pi \circ \phi_t \circ \sigma''_p)|_{\|x\|=1} = \partial\sigma'_p$ ,  $h_r(x) := \pi \circ \phi_t \circ \sigma''_p(r \cdot x)$  for  $\epsilon \leq r \leq 1$  defines a homotopy between  $\partial\sigma_p$  and  $\partial\sigma'_p$ .  $\square$

## 5 Construction of the cells

### 5.1 Stable manifolds for real arrangements

The Lefschetz Theorem (4.1.2) asserts that  $M(Q)$  has the homotopy type of a space obtained from  $M(Q) \cap F_{\mathbb{C}}$  by attaching some  $\ell$ -cells. The homotopy types of the attached cells are characterized by Theorem 4.3.1 under the Morse-Smale condition. In the remainder of this paper, we investigate the complexified real case, i.e., where each hyperplane  $H \in \mathcal{A}$  is defined by a linear equation with real coefficients. Let us briefly recall the set-up.

Let  $\mathcal{A} = \{H_1, \dots, H_n, H_\infty\}$  be an essential hyperplane arrangement in  $\mathbb{P}_{\mathbb{C}}^\ell$ , and  $\alpha_i$  be the defining linear form of  $H_i$  which is assumed to have real coefficients. Let  $F = \{f = 0\}$  be a generic hyperplane defined by a real linear form  $f$ . From Theorem 4.1.3, there exist positive even integers  $\lambda_0, \lambda_1, \dots, \lambda_n, \lambda_\infty \in 2\mathbb{Z}_{>0}$  such that  $\lambda_0 = \lambda_1 + \lambda_2 + \dots + \lambda_n + \lambda_\infty$  and

$$\varphi = \frac{f^{\lambda_0}}{\alpha_1^{\lambda_1} \dots \alpha_n^{\lambda_n} \alpha_\infty^{\lambda_\infty}}$$

has only nondegenerate isolated critical points.

The space  $\mathbb{P}_{\mathbb{C}}^\ell - H_\infty$  is isomorphic to the affine space  $\mathbb{C}^\ell$ . We also denote by  $\mathcal{A}$  the induced affine arrangement  $\{H_1, \dots, H_n\}$  in  $\mathbb{C}^\ell$  and by  $\alpha_i$  the defining equation ( $\deg = 1$ , with real coefficients) of  $H_i$ . Let  $\text{ch}(\mathcal{A})$  be the set of all chambers of  $\mathcal{A} \cap \mathbb{R}^\ell$  and  $\text{ch}_\ell^F(\mathcal{A})$  be the set of all chambers which do not meet  $F_{\mathbb{R}}$ . Denote by  $M(\mathcal{A})$  the complexified complement  $\mathbb{C}^\ell - \bigcup_{i=1}^n H_i$ .

Let  $C \in \text{ch}_\ell^F(\mathcal{A})$ . Then  $\varphi|_C$  is a positive real valued function and it has poles along the boundary  $\partial\bar{C}$ . Hence, for each  $C$ ,  $\varphi|_C$  has at least one critical point  $p_C \in \text{int}(C)$  in the relative interior of  $C$ . Then it follows from the Cauchy-Riemann equation that  $p_C \in M(\mathcal{A})$  is indeed a critical point of the function  $\varphi : M(\mathcal{A}) \rightarrow \mathbb{C}$ . Thus we obtain  $|\text{ch}_\ell^F(\mathcal{A})|$  many critical points. From the assumption,  $\varphi$  has only nondegenerate isolated critical points, the number of which is the Euler characteristic  $|\chi(M(\mathcal{A}) - F_{\mathbb{C}})| = b_\ell(M(\mathcal{A}))$  (see Proposition 2.3.2).

**Propositon 5.1.1** *For each chamber  $C \in \text{ch}_\ell^F(\mathcal{A})$  which does not meet  $F_{\mathbb{R}}$ , there exists only one critical point  $p_C \in C$  of  $\varphi$  in  $C$ . Conversely, any critical point is obtained in this way.*

In other words, the set of critical points  $\text{Crit}(\varphi)$  is parametrized by  $\text{ch}_\ell^F(\mathcal{A})$ . Moreover, since  $|\varphi(z_1, \dots, z_\ell)| = |\varphi(\bar{z}_1, \dots, \bar{z}_\ell)|$ , the gradient vector field

–  $\text{grad } |\varphi|$  is invariant under complex conjugation. Thus we have the following:

**Theorem 5.1.2** *The stable manifold of the critical point  $p_C$  corresponding to a chamber  $C \in \text{ch}_\ell^F(\mathcal{A})$  is  $W_{p_C}^s = C \subset \mathbf{M}(\mathcal{A})$ .*

In particular, the closure of a chamber  $C \in \text{ch}_\ell^F(\mathcal{A})$  contains only one critical point  $p_C$ . Thus we have the following result.

**Corollary 5.1.3** *The function  $\varphi$  satisfies the Morse-Smale condition.*

Let  $C \in \text{ch}_\ell^F(\mathcal{A})$  and  $p_C \in C$  the corresponding critical point. We denote the attaching map of the unstable manifold  $W_{p_C}^u$  by  $\sigma_C : (\mathbb{D}^\ell, \partial\mathbb{D}^\ell) \rightarrow (\mathbf{M}(\mathcal{A}), \mathbf{M}(\mathcal{A}) \cap F_{\mathbb{C}})$ . Since  $H_\ell(\mathbf{M}(\mathcal{A}), \mathbb{C}) \xrightarrow{\sim} H_\ell(\mathbf{M}(\mathcal{A}), \mathbf{M}(\mathcal{A}) \cap F_{\mathbb{C}}; \mathbb{C})$  is an isomorphism,  $[\sigma_C]$  can be considered as an element of  $H_\ell(\mathbf{M}(\mathcal{A}), \mathbb{C})$ . Moreover  $\{[\sigma_C]\}_{C \in \text{ch}_\ell(\mathcal{A})}$  forms a basis of  $H_\ell(\mathbf{M}(\mathcal{A}), \mathbb{C})$ . By Poincaré duality we have the following result.

**Corollary 5.1.4**  *$\{[C]\}_{C \in \text{ch}_\ell(\mathcal{A})} \subset H_\ell^{lf}(\mathbf{M}(\mathcal{A}), \mathbb{C})$  forms a basis, and under suitable orientations, it is the dual basis of  $\{[\sigma_C]\}_{C \in \text{ch}_\ell(\mathcal{A})}$ .*

Combining Theorem 5.1.2 with Theorem 4.2.3, we easily prove the following result which is well known for  $\ell = 1$  (Example 5.1.6).

**Corollary 5.1.5**  *$\mathbf{M}(\mathcal{A}) \setminus \bigcup_{C \in \text{ch}_\ell(\mathcal{A})} C$  is diffeomorphic to  $(F_{\mathbb{C}} - \mathcal{A}) \times \mathbb{D}^2$ .*

**Example 5.1.6** Assume  $\ell = 1$ . Let  $\{a_1, a_2, \dots, a_n\} \subset \mathbb{R}$  be an arrangement in  $\mathbb{R}$  (we assume  $a_1 < \dots < a_n$ ). Take a generic hyperplane (in this case, just a point)  $F \in \mathbb{R}$  such that  $a_i < F < a_{i+1}$ . Then the set of chambers which do not meet  $F$  is

$$\text{ch}_\ell(\mathcal{A}) = \{(-\infty, a_1), \dots, (a_{i-1}, a_i), (a_{i+1}, a_{i+2}), \dots, (a_n, \infty)\}.$$

Hence

$$\mathbf{M}(\mathcal{A}) \setminus \bigcup_{C \in \text{ch}_\ell(\mathcal{A})} C = \mathbb{C} - ([-\infty, a_i] \cup [a_{i+1}, \infty)),$$

which is diffeomorphic to  $\mathbb{D}^2$ .

## 5.2 Construction of the Cells

Our next task is to construct the cells in  $\mathbf{M}(\mathcal{A})$  explicitly. More precisely, for a chamber  $C \in \text{ch}_\ell^F(\mathcal{A})$  with  $C \cap F_{\mathbb{R}} = \emptyset$  and fixed  $p \in C$ , we construct a continuous map  $\sigma_C : (\mathbf{D}^\ell, \partial\mathbf{D}^\ell) \rightarrow (\mathbf{M}(\mathcal{A}), \mathbf{M}(\mathcal{A}) \cap F_{\mathbb{C}})$  which is differentiable in a neighborhood of  $0 \in \mathbf{D}^\ell$ , such that (recall the conditions in §4.3)

- (i)  $\sigma_C(0) = p$ ,  $\sigma_C(\mathbf{D}^\ell) \cap C = \{p\}$  and  $\sigma_C(\mathbf{D}^\ell)$  intersects  $C$  transversally.
- (ii)  $\sigma_C(\partial\mathbf{D}^\ell) \subset \mathbf{M}(\mathcal{A}) \cap F_{\mathbb{C}}$ .
- (iii) If  $C' \in \text{ch}_\ell^F(\mathcal{A})$  is another chamber, then  $\sigma_C(\mathbf{D}^\ell) \cap C' = \emptyset$ .

Let us choose coordinates  $(x_1, x_2, \dots, x_\ell)$  such that  $F$  is defined by  $\{x_\ell = 0\}$  and  $p$  is  $(0, 0, \dots, 0, 1)$ . Recall that  $L^{\ell-1}(\mathcal{A})$  is the set of all one-dimensional intersections of  $\mathcal{A}$ . We can find a wide cylinder of height 1 which ties up affine lines  $L^{\ell-1}(\mathcal{A})$ . More precisely, since  $F$  is generic, each line  $X \in L^{\ell-1}(\mathcal{A})$  intersects  $F_{\mathbb{R}}$  transversely. Hence

$$R = 2 \sup \left\{ \sqrt{x_1^2 + \dots + x_{\ell-1}^2} \mid (x_1, \dots, x_{\ell-1}, x_\ell) \in X \in L^{\ell-1}(\mathcal{A}), 0 \leq x_\ell \leq 1 \right\}$$

is finite. Consider the cylinder

$$\text{Cyl}(R) = \{(x_1, \dots, x_\ell) \in \mathbb{R}^\ell \mid x_1^2 + \dots + x_{\ell-1}^2 = R^2, 0 \leq x_\ell \leq 1\}$$

of radius  $R$  and height 1. The cylinder  $\text{Cyl}(R)$  is diffeomorphic to  $S^{\ell-2}(1) \times [0, 1]$  under the map

$$\begin{aligned} S^{\ell-2}(1) \times [0, 1] &\longrightarrow \text{Cyl}(R) \\ (x', t) &\longmapsto (Rx', t), \end{aligned}$$

where  $x' = (x_1, \dots, x_{\ell-1}) \in S^{\ell-2}(1) = \{(x_1, \dots, x_{\ell-1}); x_1^2 + \dots + x_{\ell-1}^2 = 1\}$ . The boundary  $\partial\text{Cyl}(R)$  of  $\text{Cyl}(R)$  is the disjoint union of two spheres  $S_0$  and  $S_1$ , where  $S_t$  is a horizontal  $(\ell - 1)$ -dimensional sphere of radius  $R$

$$\begin{aligned} S_t &= \{(x_1, \dots, x_\ell) \mid x_1^2 + \dots + x_{\ell-1}^2 = R^2, x_\ell = t\} \\ D_t &= \{(x_1, \dots, x_\ell) \mid x_1^2 + \dots + x_{\ell-1}^2 \leq R^2, x_\ell = t\}. \end{aligned} \tag{11}$$

$S_t \cap \mathcal{A}$  determines a hypersphere arrangement on  $S_t$  for  $0 \leq t \leq 1$ . Note that the combinatorial type of this arrangement is independent of  $t$ .

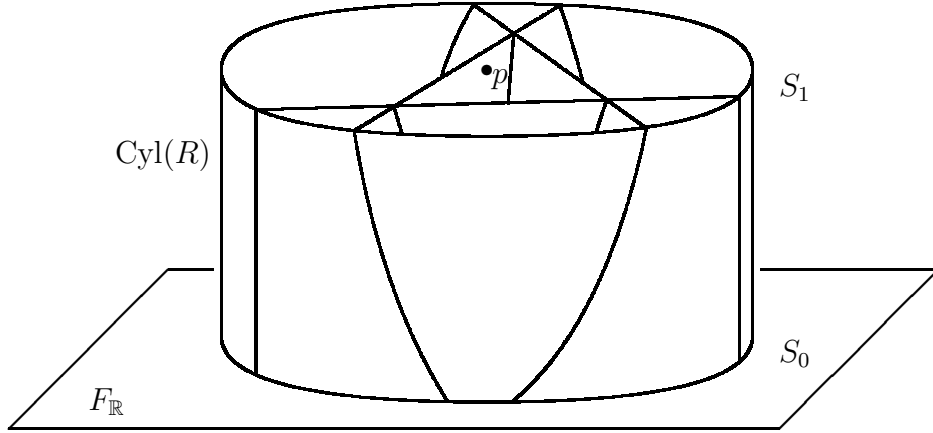

Figure 9: The cylinder

Since every  $H \in \mathcal{A}$  contains at least one affine line  $X \in L^{\ell-1}(\mathcal{A})$  and  $X$  intersects both  $D_0$  and  $D_1$ , there exists a non-horizontal tangent vector  $V_q \in T_q(\text{Cyl}(R) \cap H)$  at each  $q \in \text{Cyl}(R) \cap H$ . Using a partition of unity, we have a vector field  $\tilde{V}$  on  $\text{Cyl}(R)$  of the form

$$\tilde{V} = \frac{\partial}{\partial x_\ell} + \sum_{i=1}^{\ell-1} f_i \frac{\partial}{\partial x_i}$$

which is tangent to each hypercylinder  $\text{Cyl}(R) \cap H$ . Now consider the one-parameter flow generated by  $\tilde{V}$ . The flow determines a diffeomorphism  $\eta_t : S^{\ell-2}(1) \rightarrow S^{\ell-2}(1)$  such that  $\eta_0(x') = x'$  and

$$\frac{d}{dt}(R \cdot \eta_t(x'), t) = \tilde{V}_{(R \cdot \eta_t(x'), t)},$$

for  $0 \leq t \leq 1$  and  $x' \in S^{\ell-2}(1)$ . This determines a diffeomorphism  $\eta_t : (S_0, S_0 \cap \mathcal{A}) \xrightarrow{\cong} (S_t, S_t \cap \mathcal{A})$ .

Let  $\iota : S_1 \rightarrow S_1$  be the involution  $\iota : (x_1, \dots, x_{\ell-1}, 1) \mapsto (-x_1, \dots, -x_{\ell-1}, 1)$  and define  $I = \eta_1^{-1} \circ \iota \circ \eta_1 : S_0 \rightarrow S_0$ . The next lemma follows immediately from the construction.

**Lemma 5.2.1** *Suppose  $q \in S_0 \cap H$  with  $H \in \mathcal{A}$ , then the vectors  $\overrightarrow{qI(q)}, \overrightarrow{qp} \in T_q V_{\mathbb{R}}$  are on the same side with respect to the hyperplane  $H \subset T_q V_{\mathbb{R}}$ . The same holds for  $\overrightarrow{I(q)q}, \overrightarrow{I(q)p} \in T_{I(q)} V_{\mathbb{R}}$  when  $I(q) \in S_0 \cap H$ .*

Before defining  $\sigma_C : (D^\ell, \partial D^\ell) \rightarrow (\mathbf{M}(\mathcal{A}), \mathbf{M}(\mathcal{A}) \cap F_{\mathbb{R}})$ , we decompose the disk  $D^\ell$  into four pieces. Denote the latitude of  $v \in D^\ell$  by  $\theta$ , i.e.,  $v = (x' \cos \theta, \|x'\| \sin \theta)$ , where  $x' = (x_1, \dots, x_{\ell-1})$  with  $x_1^2 + \dots + x_{\ell-1}^2 \leq 1$ . Fix  $0 < \theta_0 < \pi/2$  so that  $\tan \theta_0 = \frac{1}{R}$ .

- (1) (The core):  $A_1 = \{v \in D^\ell \mid \|v\| \leq \frac{1}{2}\}$ .
- (2) (The northern hemisphere):  $A_2 = \{v \in D^\ell \mid \frac{1}{2} \leq \|v\| \leq 1, \theta \geq \theta_0\}$ .
- (3) (The southern hemisphere):  $A_3 = \{v \in D^\ell \mid \frac{1}{2} \leq \|v\| \leq 1, \theta \leq -\theta_0\}$ .
- (4) (The low latitudes):  $A_4 = \{v \in D^\ell \mid \frac{1}{2} \leq \|v\| \leq 1, -\theta_0 \leq \theta \leq \theta_0\}$ .

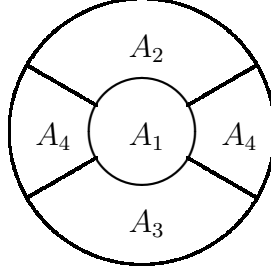

Figure 10: Decomposition of  $D^\ell$

Given  $v = (x' \cos \theta, \|x'\| \sin \theta) \in D^\ell$  with  $1/2 \leq \|x'\| \leq 1$  and  $\theta \neq 0$ , let us define  $\xi(v) \in V_{\mathbb{R}}$  by

$$\xi(v) := \left( (2\|x'\| - 1) \frac{\cos \theta}{\sin \theta} \cdot \frac{-x'}{\|x'\|}, 2 - 2\|x'\| \right). \quad (12)$$

We also give an alternative description of  $\xi(v)$ . Straightforward computation shows that the line  $p + t \cdot v$  ( $t \in \mathbb{R}$ ) intersects the hyperplane  $F_{\mathbb{R}}$  at  $q = (-x'/(\|x'\| \tan \theta), 0)$ . The point  $\xi(v)$  above divide the segment  $pq$  internally by the ratio  $p\xi(v) : \xi(v)q = (\|x'\| - \frac{1}{2}) : (1 - \|x'\|)$ .

We will define  $\sigma_i : A_i \rightarrow \mathbf{M}(\mathcal{A})$ ,  $i = 1, \dots, 4$ , separately. We use the notation in §3.1 (6) to express points in the complexified space  $V_{\mathbb{C}}$ .

- (1)  $\sigma_1(v) = (p, v)_{\mathbb{C}} = p + \sqrt{-1}v \in V_{\mathbb{C}}$ .
- (2)  $\sigma_2(v) = (\xi(v), v)_{\mathbb{C}}$  for  $v \in A_2$ . The point  $\sigma_2(v)$  is indeed contained in  $\mathbf{M}(\mathcal{A})$  because every straight line passing through  $p$  intersects each hyperplane  $H \in \mathcal{A}$  transversely.

(3)  $\sigma_3(v) = (\xi(v), v)_\mathbb{C}$  for  $v \in A_3$ .

The definition of  $\sigma_4$  on the low latitudes  $A_4$  is somewhat complicated. Let us define an annulus  $T$  by

$$T = \{x' = (x_1, \dots, x_{\ell-1}); 1/2 \leq \|x'\| \leq 1\}.$$

Then the low latitudes  $A_4$  can be expressed as

$$A_4 = \{(x' \cos \theta, \|x'\| \sin \theta) \in \mathbb{D}^\ell \mid x' \in T, -\theta_0 \leq \theta \leq \theta_0\}.$$

We extend  $\eta_t$  and  $I : S^{\ell-2}(1) \rightarrow S^{\ell-2}(1)$  to  $T$  by

$$\begin{aligned} \eta_t(x') &:= \|x'\| \cdot \eta_t\left(\frac{x'}{\|x'\|}\right), \\ I(x') &:= \eta_1^{-1}(-\eta_1(x')) \end{aligned}$$

for  $x' \in T$ . Now define

$$\gamma : T \times [0, 1] \xrightarrow{\cong} A_4$$

$$(x', t) \longmapsto (-\eta_t^{-1}(-\eta_t(x')) \cos(2t - 1)\theta_0, \|x'\| \sin(2t - 1)\theta_0).$$

Since  $\eta_t : T \rightarrow T$  is a diffeomorphism, so is  $\gamma$ . Define  $\sigma_4(\gamma(x', t)) \in V_\mathbb{C} \cong \text{TV}_\mathbb{R}$  by

$$\sigma_4(\gamma(x', t)) = ((1 - t)\xi(\gamma(x', 0)) + t\xi(\gamma(x', 1)), x' - I(x'))_\mathbb{C}. \quad (13)$$

**Lemma 5.2.2** *We have  $\sigma_4(\gamma(x', t)) \in \mathbf{M}(\mathcal{A})$ . When  $\|x'\| = 1$ ,  $\sigma_4(\gamma(x', t))$  is contained in  $F_\mathbb{C}$ , but is not contained in  $F_\mathbb{R}$ .*

**Proof.** The second part is obvious. Indeed, since  $x' - I(x')$  is a nonzero horizontal vector, it is contained in  $\text{TF}_\mathbb{R}$  when  $\|x'\| = 1$ .

Next we prove  $\sigma_4(\gamma(x', t)) \in \mathbf{M}(\mathcal{A})$  for  $(x', t) \in T \times [0, 1]$ . By definition, we have

$$\begin{aligned} \xi(\gamma(x', 0)) &= \left( (2\|x'\| - 1) \frac{x'}{\|x'\| \tan \theta_0}, 2 - 2\|x'\| \right) \in V_\mathbb{R}, \\ \xi(\gamma(x', 1)) &= \left( (2\|x'\| - 1) \frac{\eta_1^{-1}(-\eta_1(x'))}{\|x'\| \tan \theta_0}, 2 - 2\|x'\| \right) \in V_\mathbb{R}, \end{aligned}$$

for  $x' \in T$ . Hence the tangent vector  $x' - I(x') \in \text{T}_q V_\mathbb{R}$  with  $q = (1 - t)\xi(\gamma(x', 0)) + t\xi(\gamma(x', 1))$ , is parallel to  $\xi(\gamma(x', 0)) - \xi(\gamma(x', 1))$ . In order to prove this lemma, it suffices to prove that the line segment connecting  $\xi(\gamma(x', 0))$  and  $\xi(\gamma(x', 1))$  is not contained in any hyperplane  $H \in \mathcal{A}$ . So it suffices to prove the next lemma.

**Lemma 5.2.3** *If  $\xi(\gamma(x', 0))$  (resp.  $\xi(\gamma(x', 1))$ ) is contained in a hyperplane  $H \in \mathcal{A}$ , then  $\xi(\gamma(x', 1))$  (resp.  $\xi(\gamma(x', 0))$ ) and  $p$  lie on the same side with respect to  $H$ .*

**Proof.** Suppose  $\xi(\gamma(x', 0))$  is contained in a hyperplane  $H \in \mathcal{A}$ . Choose a defining equation  $\alpha_H$  of  $H$  such that  $\alpha_H(p) > 0$ . We prove

$$\alpha_H(\xi(\gamma(x', 1))) > 0. \quad (14)$$

Let us put  $q = (x'/(\|x'\| \tan \theta_0), 0) = (Rx'/\|x'\|, 0) \in F_{\mathbb{R}}$ . Since  $\xi(\gamma(x', 0))$  divides the segment  $pq$  internally, we have  $\alpha_H(q) < 0$ . By the definition of  $\eta_t$ ,  $(R\eta_t(x'/\|x'\|), t) \in V_{\mathbb{R}}$  ( $0 \leq t \leq 1$ ) is a flow which is tangent to  $H \cap \text{Cyl}_R$ . Hence  $\alpha_H(R\eta_t(x'/\|x'\|), t) < 0$  for all  $0 \leq t \leq 1$ . In particular, we have  $\alpha_H(R\eta_1(x'/\|x'\|), 1) < 0$ . Since  $p$  is the midpoint of  $(R\eta_1(x'/\|x'\|), 1)$  and  $(-R\eta_1(x'/\|x'\|), 1)$ , we have  $\alpha_H(-R\eta_1(x'/\|x'\|), 1) > 0$ . Similarly, using the flow  $\eta_t$ , we verify  $\alpha_H(R\eta_1^{-1}(-\eta_1(x'/\|x'\|), 0)) > 0$ .  $\xi(\gamma(x', 1))$  divides the segment connecting  $p$  and  $(R\eta_1^{-1}(-\eta_1(x'/\|x'\|), 0))$  internally, thus we have (14).

Similarly, if  $\alpha_H(\xi(\gamma(x', 1))) = 0$ , then we have  $\alpha_H(\sigma(\gamma(x', 0))) > 0$ .  $\square$

Now we are ready to construct the cell  $\sigma_C : (D^\ell, \partial D^\ell) \rightarrow (\mathbf{M}(\mathcal{A}), F_{\mathbb{C}} \cap \mathbf{M}(\mathcal{A}))$ . By definition, we have  $\sigma_1|_{A_1 \cap A_2} = \sigma_2|_{A_1 \cap A_2}$  and  $\sigma_1|_{A_1 \cap A_3} = \sigma_3|_{A_1 \cap A_3}$ . Hence we have a continuous map

$$\sigma_{123} : A_1 \cup A_2 \cup A_3 \longrightarrow \mathbf{M}(\mathcal{A}).$$

Unfortunately,  $\sigma_{123}$  and  $\sigma_4$  do not coincide on their boundaries. However, we can paste the pieces together. Indeed, given a point  $v = (x' \cos \theta_0, \|x'\| \sin \theta_0) \in A_2 \cap A_4$ , both  $\sigma_2(v)$  and  $\sigma_4(v)$  can be considered as elements in  $T_{\xi(v)}V_{\mathbb{R}}$ . Under the natural identification  $T_{\xi(v)}V_{\mathbb{R}} \cong V_{\mathbb{R}}$ , we have

$$\begin{aligned} \sigma_2(v) &= v \\ \sigma_4(v) &= x' - I(x'). \end{aligned}$$

Recall that  $v$  and  $x' - I(x')$  are positive multiples of  $p - \xi(v) = \overrightarrow{\xi(v)p}$  and  $\xi(\gamma(x', 0)) - \xi(\gamma(x', 1))$  respectively. Even if  $\xi(v)$  is contained in some  $H \in \mathcal{A}$ ,  $\sigma_2(v)$  and  $\sigma_4(v) \in T_{\xi(v)}V_{\mathbb{R}} \cong V_{\mathbb{R}}$  are on the same side with respect to a hyperplane  $H \subset V_{\mathbb{R}}$  from Lemma 5.2.3. We can continuously connect them by

$$\sigma_2(v) \cos \rho + \sigma_4(v) \sin \rho, \quad 0 \leq \rho \leq \frac{\pi}{2},$$



thus we have a continuous map  $\sigma_{1234} : D^\ell \rightarrow M(\mathcal{A})$  which satisfies (i) and (iii). To glue the boundary  $\partial D^\ell$  to  $F_{\mathbb{C}}$ , we apply the following lemma. Let us set

$$\text{Cyl}_{R,\varepsilon} := \{(x_1, \dots, x_\ell) \mid x_1^2 + \dots + x_{\ell-1}^2 \leq R^2, -\varepsilon \leq x_\ell \leq \varepsilon\}$$

and

$$\text{Cyl}_{R,0} := \{(x_1, \dots, x_\ell) \mid x_1^2 + \dots + x_{\ell-1}^2 \leq R^2, x_\ell = 0\}.$$

**Lemma 5.2.4** *For sufficiently small  $\varepsilon > 0$ ,  $(\text{Cyl}_{R,\varepsilon}, \text{Cyl}_{R,\varepsilon} \cap \mathcal{A})$  is diffeomorphic to  $(\text{Cyl}_{R,0}, \text{Cyl}_{R,0} \cap \mathcal{A}) \times [-\varepsilon, \varepsilon]$ .*

Denote the composite map  $\text{Cyl}_{R,\varepsilon} \rightarrow \text{Cyl}_{R,0} \times [-\varepsilon, \varepsilon] \rightarrow \text{Cyl}_{R,0}$  by  $\text{Pr}_1$ . Then, for  $v \in \partial D^\ell$ ,

$$\sigma(v) \cos \rho + \text{Pr}_1(\sigma(v)) \sin \rho, \quad 0 \leq \rho \leq \frac{\pi}{2} \quad (15)$$

connects  $\sigma(v)$  to  $\text{Pr}_1(\sigma(v)) \in T_{\sigma(v)} F_{\mathbb{R}}$ . Thus we have a map  $\sigma_C : (D^\ell, \partial D^\ell) \rightarrow (M(\mathcal{A}), M(\mathcal{A}) \cap F_{\mathbb{C}})$  which satisfies (i), (ii) and (iii). This completes the construction of the cell.

**Example 5.2.5** We illustrate the above construction for  $\ell = 2$ . Let us consider an arrangement  $\mathcal{A} = \{L_1, L_2\}$  of two lines and a generic line  $F$ ,

$$\begin{aligned} L_1 & : y = x + \frac{1}{2} \\ L_2 & : y = -x + \frac{1}{2} \\ F & : y = 0. \end{aligned}$$

In this case,  $D^2$  is decomposed by the  $A_i$  as in Figure 10. The map  $\sigma_i : A_i \rightarrow M(\mathcal{A})$  ( $i = 1, 2, 3, 4$ ) is illustrated in Figure 11.

## 6 Twisted minimal chain complexes

The explicit construction in the previous section enables us to find an presentation of the cellular chain complex associated with the minimal CW decomposition with coefficients in a local system. We demonstrate this point in this section.

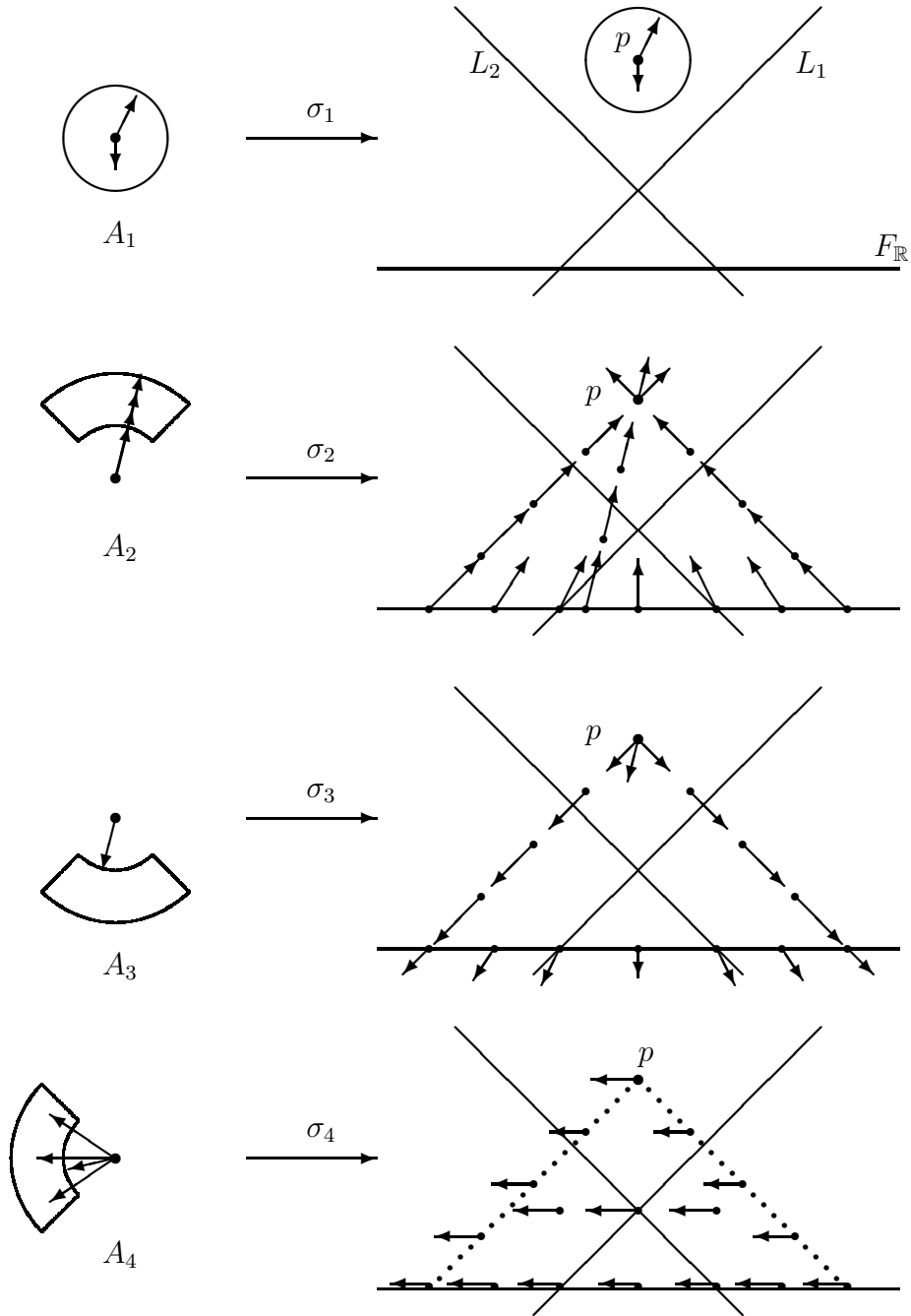

Figure 11:  $\sigma_i : A_i \rightarrow M(\mathcal{A})$

## 6.1 Flags and orientations

In order to compute the boundary map of a cellular chain complex, we have to choose an orientation for each cell. First we recall some basic notation and terminology.

Let  $X$  be a differentiable manifold of  $\dim_{\mathbb{R}} = n$  with boundary  $\partial X$ . Each orientation for  $X$  determines an orientation for  $\partial X$  as follows: Given  $x \in \partial X$  choose a positively oriented basis  $(v_1, v_2, \dots, v_n)$  for  $T_x X$  in such a way that  $v_2, \dots, v_n \in T_x(\partial X)$  and that  $v_1$  is an outward vector. Then  $(v_2, \dots, v_n)$  determines an orientation on  $\partial X$ .

Let  $X, Y$  and  $Z$  be oriented differentiable manifolds without boundary. Further assume  $X$  is compact,  $Z$  is a closed submanifold of  $Y$ , and  $\dim X + \dim Z = \dim Y$ . Let  $f : X \rightarrow Y$  be differentiable map transversal to  $Z$ , i.e.,

$$(df_x)(T_x X) + T_y Z = T_y Y$$

holds at each point  $x$  such that  $y = f(x) \in Z$ . Then  $f^{-1}(Z)$  is a closed zero-dimensional submanifold of  $X$ , hence a finite set. Let  $x \in f^{-1}(Z)$  and choose positively oriented bases  $u = (u_1, \dots, u_m)$  and  $v = (v_1, \dots, v_n)$  for  $T_x X$  and  $T_{f(x)} Z$ , respectively. Under this assumption, we can define a local intersection number  $I_x(f, Z)$  for each  $x \in f^{-1}(Z)$  as follows:

$$I_x(f, Z) = \begin{cases} 1 & \text{if } (f_* u, v) \text{ is positive for } T_{f(x)} Y \\ -1 & \text{if } (f_* u, v) \text{ is negative for } T_{f(x)} Y. \end{cases} \quad (16)$$

And we also define  $I(f, Z) := \sum_{x \in f^{-1}(Z)} I_x(f, Z)$ .

Let  $V = \mathbb{R}^\ell$  be a real  $\ell$ -dimensional vector space and

$$\mathcal{F} : \emptyset = \mathcal{F}^{-1} \subset \mathcal{F}^0 \subset \mathcal{F}^1 \subset \dots \subset \mathcal{F}^\ell = V$$

be a complete flag of affine subspaces.

**Definition 6.1.1** An *oriented flag* is a flag  $\mathcal{F}$  in  $V$  equipped with an orientation for each  $\mathcal{F}^i$ ,  $i = 1, \dots, \ell$ .

A given point  $\mathcal{F}^0 \in V$  and a basis  $v_1, \dots, v_\ell$  of  $V$  determine an oriented flag. Indeed, by defining

$$\mathcal{F}^k := \mathcal{F}^0 + \sum_{i=1}^k \mathbb{R}v_i,$$

$(v_1, \dots, v_k)$  determines an orientation of  $\mathcal{F}^k$ . Conversely, any oriented flag can be obtained in this way. Define positive and negative half subspaces,  $\mathcal{F}_+^k$  and  $\mathcal{F}_-^k$ , by

$$\begin{aligned}\mathcal{F}_+^k &= \mathcal{F}^{k-1} + \mathbb{R}_{>0}v_k \\ \mathcal{F}_-^k &= \mathcal{F}^{k-1} + \mathbb{R}_{<0}v_k,\end{aligned}$$

respectively. Next we define signature of a chamber; a map  $\text{sign} : \text{ch}^k(\mathcal{A}) \rightarrow \{\pm 1\}$ .

**Definition 6.1.2** For  $C \in \text{ch}^k(\mathcal{A})$ ,

$$\text{sign}(C) = \begin{cases} 1 & \text{if } \mathcal{F}^k \cap C \subset \mathcal{F}_+^k \\ -1 & \text{if } \mathcal{F}^k \cap C \subset \mathcal{F}_-^k. \end{cases} \quad (17)$$

**Definition 6.1.3** Let  $v_1, \dots, v_\ell$  be a basis of  $V_{\mathbb{R}}$ . We fix an orientation of  $V_{\mathbb{C}}$  by

$$(v_1, \dots, v_\ell, \sqrt{-1}v_1, \dots, \sqrt{-1}v_\ell). \quad (18)$$

Note that this orientation differs by a multiplication of  $(-1)^{\ell(\ell-1)/2}$  from the canonical orientation defined by the complex structure  $V_{\mathbb{C}} \cong \mathbb{C}^\ell$ .

## 6.2 Local systems and chambers

Recall that  $\sigma_C : (D^\ell, S^{\ell-1}) \rightarrow (\mathbf{M}(\mathcal{A}), \mathbf{M}(\mathcal{A}) \cap F_{\mathbb{C}})$  is the cell corresponding to the chamber  $C \in \text{ch}_\ell^{\mathcal{F}}(\mathcal{A})$ . We can choose an orientation of  $\sigma_C$  so that the intersection number satisfies

$$[C] \cdot [\sigma_C] = 1. \quad (19)$$

Let  $\Phi : \text{Gal}(\mathcal{A}) \rightarrow \text{Vect}_{\mathbb{C}}$  be a representation of the Deligne groupoid and  $\mathcal{L}_\Phi$  be the associated local system. Since  $C$  is a connected and simply connected subset of  $\mathbf{M}(\mathcal{A})$ , the space of flat sections  $\mathcal{L}_\Phi(C)$  is a finite dimensional vector space, and we have a natural isomorphism

$$\Phi(C) \cong \mathcal{L}_\Phi(C).$$

From the fact that  $\mathbf{M}(\mathcal{A})$  is homotopy equivalent to a space obtained from  $\mathbf{M}(\mathcal{A}) \cap F_{\mathbb{C}}$  by attaching  $\ell$ -cells  $\{\sigma_C; C \in \text{ch}_\ell(\mathcal{A})\}$ , we have also a natural isomorphism

$$H_\ell(\mathbf{M}(\mathcal{A}), \mathbf{M}(\mathcal{A}) \cap F_{\mathbb{C}}; \mathcal{L}_\Phi), \cong \bigoplus_{C \in \text{ch}_\ell(\mathcal{A})} \Phi(C) \otimes \mathbb{C}[\sigma_C], \quad (20)$$

where  $\mathbb{C}[\sigma_C]$  is a one-dimensional vector space spanned by  $[\sigma_C]$ .

**Definition 6.2.1** Let  $\mathcal{A}$ ,  $\mathcal{F}^\bullet$  and  $\Phi$  as above. Define

$$\mathcal{C}_k := \mathcal{C}_k(\mathcal{A}, \mathcal{F}, \Phi) = \bigoplus_{C \in \text{ch}_k^{\mathcal{F}}(\mathcal{A})} \Phi(C) \otimes \mathbb{C}[\sigma_C]. \quad (21)$$

From the general theory of cellular chain complexes, there exists a chain boundary map  $\partial_\Phi : \mathcal{C}_k \rightarrow \mathcal{C}_{k-1}$  such that

$$H_k(\mathcal{C}_\bullet, \partial_\Phi) \cong H_k(\mathbf{M}(\mathcal{A}), \mathcal{L}_\Phi).$$

We will give an formula for  $\partial_\Phi : \mathcal{C}_\bullet \rightarrow \mathcal{C}_{\bullet-1}$ .

Let  $\mathcal{L}$  be a local system on  $\mathbf{M}(\mathcal{A})$ . Let  $X$  be an oriented compact  $\ell$ -dimensional  $C^\infty$ -manifold with boundary  $\partial X$ , possibly  $\partial X = \emptyset$ , and

$$f : (X, \partial X) \longrightarrow (\mathbf{M}(\mathcal{A}), \mathbf{M}(\mathcal{A}) \cap F_{\mathbb{C}})$$

be a smooth map. We denote by  $f^*\mathcal{L}$  the pull back of  $\mathcal{L}$  by  $f$ . Fix  $x \in X$  and suppose  $S \subset \mathbf{M}(\mathcal{A})$  is a connected and simply connected subset containing  $f(x)$ . Then there exists a natural isomorphism

$$f_{x,S} : (f^*\mathcal{L})(x) \xrightarrow{\sim} \mathcal{L}(S).$$

Given a section  $\alpha \in (f^*\mathcal{L})(X)$  we have a morphism from the constant sheaf  $\mathbb{C}_X$  to  $f^*\mathcal{L}$  defined by  $t \mapsto t \cdot \alpha$ , and it induces a homomorphism

$$\alpha \otimes \bullet : H_\ell(X, \partial X; \mathbb{C}) \longrightarrow H_\ell(X, \partial X; f^*\mathcal{L}).$$

Denote the image of the fundamental class  $[X] \in H_\ell(X, \partial X; \mathbb{C})$  by  $\alpha \otimes [X] \in H_\ell(X, \partial X; f^*\mathcal{L})$ . Hence we have  $f_*(\alpha \otimes [X]) \in H_\ell(\mathbf{M}(\mathcal{A}), \mathbf{M}(\mathcal{A}) \cap F_{\mathbb{C}}; \mathcal{L})$ .

Next we express  $f_*(\alpha \otimes [X])$  by using the decomposition (20). Recall (5.1.4) that  $\{[C]\}_{C \in \text{ch}_\ell(\mathcal{A})} \subset H_\ell^{lf}(\mathbf{M}(\mathcal{A}), \mathbb{C})$  is the dual basis to  $\{[\sigma_C]\}_{C \in \text{ch}_\ell(\mathcal{A})} \subset H_\ell(\mathbf{M}(\mathcal{A}), \mathbb{C})$ , i.e., for  $C_1, C_2 \in \text{ch}_\ell^{\mathcal{F}}(\mathcal{A})$

$$[C_1] \cdot [\sigma_{C_2}] = \begin{cases} 1 & \text{if } C_1 = C_2 \\ 0 & \text{if } C_1 \neq C_2. \end{cases}$$

Thus we have the following lemma.

**Lemma 6.2.2** Assume that  $f^{-1}(C)$  is a finite set for each  $C \in \text{ch}_\ell(\mathcal{A})$ . Given a section  $\alpha \in (f^*\mathcal{L})(X)$ ,  $f_*(\alpha \otimes [X]) \in H_\ell(\mathbf{M}(\mathcal{A}), \mathbf{M}(\mathcal{A}) \cap F_{\mathbb{C}}; \mathcal{L})$  is expressed as

$$f_*(\alpha \otimes [X]) = (-1)^\ell \sum_{C \in \text{ch}_\ell^{\mathcal{F}}(\mathcal{A})} \sum_{x \in f^{-1}(C)} I_x(f, C) f_{x,C}(\alpha) \otimes [\sigma_C].$$

### 6.3 The degree map

For the purpose of describing the boundary map of the chain complex (21), we employ here an additional map, the degree map

$$\deg : \text{ch}_k^{\mathcal{F}}(\mathcal{A}) \times \text{ch}_{k-1}^{\mathcal{F}}(\mathcal{A}) \longrightarrow \mathbb{Z}$$

defined below. For simplicity, we shall consider only the case  $k = \ell$  and write  $\mathcal{F}^{\ell-1} = F$ .

Let  $C \in \text{ch}_\ell^{\mathcal{F}}(\mathcal{A})$  and  $C' \in \text{ch}_{\ell-1}^{\mathcal{F}}(\mathcal{A})$ . Recall (§5.2 (11)) that  $D_0$  is an  $(\ell - 1)$ -dimensional large disk in  $F_{\mathbb{R}}$  such that  $C' \cap F_{\mathbb{R}} \in \text{ch}(\mathcal{A} \cap F_{\mathbb{R}})$  is a bounded chamber if and only if  $C' \cap F_{\mathbb{R}} \subset D_0$ .

**Definition 6.3.1**

$$\mathcal{P}(C') := \overline{C'} \cap D_0.$$

In particular,  $\mathcal{P}(C')$  is equal to  $\overline{C'} \cap F_{\mathbb{R}}$  if  $C' \cap F_{\mathbb{R}}$  is a bounded chamber. The set  $\mathcal{P}(C')$  is, in any case, a convex closed subset of  $F_{\mathbb{R}}$  with piecewise smooth boundary  $\partial\mathcal{P}(C')$ . Next we consider vector fields on  $\partial\mathcal{P}(C')$  tangent to  $F_{\mathbb{R}}$ .

**Definition 6.3.2** Let  $U \in \Gamma(\partial\mathcal{P}(C'), \text{TF}_{\mathbb{R}}|_{\partial\mathcal{P}(C')})$  be a vector field on  $\partial\mathcal{P}(C')$  tangent to  $F_{\mathbb{R}}$ . Then  $U$  is said to be *directing to*  $C \in \text{ch}_\ell^{\mathcal{F}}(\mathcal{A})$  if for any point  $x \in \partial\mathcal{P}(C')$  and hyperplane  $H \in \mathcal{A}$  with  $x \in H$ ,  $U(x) \notin T_x H$  (in particular,  $U(x) \neq 0$ ) and  $U(x)$  and  $C$  are in the same half-space with respect to  $H$ . Moreover if  $x \in S_0 = \partial D_0$ , then  $U(x)$  is assumed to be an inward vector.

Now we define the degree map as the degree of a certain Gauss map.

**Definition 6.3.3** Let  $C \in \text{ch}_\ell^{\mathcal{F}}(\mathcal{A})$  and  $C' \in \text{ch}_{\ell-1}^{\mathcal{F}}(\mathcal{A})$ . Let  $U$  be a vector field on  $\partial\mathcal{P}(C')$  directing to  $C$ . Then

$$\deg(C, C') := \deg \left( \frac{U}{|U|} : \partial\mathcal{P}(C') \longrightarrow S^{\ell-2} \right).$$

We need to prove the existence of a vector field  $U \in \Gamma(\partial\mathcal{P}(C'), \text{TF}_{\mathbb{R}}|_{\partial\mathcal{P}(C')})$  directing to  $C$  and that  $\deg(C, C')$  does not depend on the choice of  $U$ . From the genericity of  $F$ , there exists a tubular neighborhood  $\mathcal{T} \subset V_{\mathbb{R}}$  of  $F_{\mathbb{R}}$  in  $V_{\mathbb{R}}$  with a diffeomorphism (see also Lemma 5.2.4)

$$\tau : (\mathcal{T}; \mathcal{A} \cap \mathcal{T}, \text{Cyl}_{R,\varepsilon} \cap \mathcal{T}) \xrightarrow{\sim} (F_{\mathbb{R}}; \mathcal{A} \cap F_{\mathbb{R}}, S_0) \times (-1, 1).$$

Fix a point  $p \in C$ . Then for  $x \in \partial\mathcal{P}(C')$ , the vector  $\overrightarrow{xp} \in T_x V_{\mathbb{R}}$  is obviously in the same half-space as  $C$  is for any  $H \in \mathcal{A}$  which contains  $x$ . The projection of this tangent vectors to  $F_{\mathbb{R}}$  satisfies the condition, more precisely,

$$U_{\tau}(x) := (\text{Pr}_1 \circ \tau)_*(\overrightarrow{xp}) \in T_x F_{\mathbb{R}} \quad (22)$$

determines a vector field on  $\partial\mathcal{P}(C')$  tangent to  $F_{\mathbb{R}}$  directing to  $C$ , where  $\text{Pr}_1$  is the first projection.

Suppose  $U$  and  $U'$  are vector fields directing to  $C$ . Let  $x \in \partial\mathcal{P}(C')$ . Consider the set  $\mathcal{A}_x$  of all hyperplanes in  $\mathcal{A}$  containing  $x$ . Then both  $U(x)$  and  $U'(x) \in T_x F_{\mathbb{R}}$  are contained in the same chamber of  $\mathcal{A}_x$  which is also contains  $C$ . Hence  $(1-t)U + tU'$  ( $0 \leq t \leq 1$ ) is a continuous family of vector fields directing to  $C$ , and the maps  $U/|U|$  and  $U'/|U'| : \partial\mathcal{P}(C') \rightarrow S^{\ell-2}$  are homotopic. Thus the degree  $\deg(C, C')$  is well-defined.

## 6.4 The boundary map

Recall that an arrangement  $\mathcal{A}$  with an oriented generic flag  $\mathcal{F} = \mathcal{F}^{\bullet}$  and a representation  $\Phi : \text{Gal}(\mathcal{A}) \rightarrow \text{Vect}_{\mathbb{C}}$  of the Deligne groupoid determine a chain complex  $(\mathcal{C}_{\bullet}, \partial_{\Phi})$  defined by

$$\mathcal{C}_k := \mathcal{C}_k(\mathcal{A}, \mathcal{F}, \Phi) = \bigoplus_{C \in \text{ch}_k^{\mathcal{F}}(\mathcal{A})} \Phi(C) \otimes \mathbb{C}[\sigma_C]$$

such that  $H_k(\mathcal{C}_{\bullet}, \partial_{\Phi}) \cong H_k(\mathbf{M}(\mathcal{A}), \mathcal{L}_{\Phi})$ . In this section we describe the boundary map  $\partial_{\Phi}$  by using the degree map.

**Theorem 6.4.1**  $\partial_{\Phi} : \mathcal{C}_k \rightarrow \mathcal{C}_{k-1}$  is expressed as follows:

$$\partial_{\Phi}(a \otimes [\sigma_C]) = -\text{sign}(C) \times \sum_{C' \in \text{ch}_{k-1}^{\mathcal{F}}(\mathcal{A})} \deg(C, C') \Delta_{\Phi}(C, C')(a) \otimes [\sigma_{C'}].$$

(For  $\Delta_{\Phi}(C, C')$ , see Definition 3.3.5.)

**Proof.** We consider only the case where  $k = \ell$ . Recall that  $D^{\ell} = \{v \in \mathbb{R}^{\ell}; \|v\| \leq 1\}$  and that the cell attaching map  $\sigma_C : (D^{\ell}, \partial D^{\ell}) \rightarrow (\mathbf{M}(\mathcal{A}), \mathbf{M}(\mathcal{A}) \cap \mathcal{F}^{\ell-1})$  was constructed in §5.2. The pull back  $\sigma_C^* \mathcal{L}_{\Phi}$  is canonically isomorphic to the trivial local system  $\Phi(C)$ . Since  $\sigma_C^* \mathcal{L}_{\Phi}|_{\partial D^{\ell}} \cong (\partial \sigma_C)^* \mathcal{L}_{\Phi}$ , we have

$$a \otimes [\partial D^{\ell}] \in H_{\ell-1}(\partial D^{\ell}, (\partial \sigma_C)^* \mathcal{L}_{\Phi}).$$

So we have to investigate the element

$$\begin{aligned} \sigma_{C*}(a \otimes [\partial D^\ell]) &\in H_{\ell-1}(\mathbf{M}(\mathcal{A}) \cap \mathcal{F}^{\ell-1}, \mathbf{M}(\mathcal{A}) \cap \mathcal{F}^{\ell-2}; \mathcal{L}_\Phi) \\ &\quad \parallel \wr \\ \mathcal{C}_{k-1} &= \bigoplus_{C' \in \text{ch}_{k-1}^{\mathcal{F}}(\mathcal{A})} \Phi(C') \otimes \mathbb{C}[\sigma_{C'}]. \end{aligned}$$

Here we recall some properties of the attaching map  $\partial\sigma_C : \partial D^\ell \rightarrow \mathbf{M}(\mathcal{A}) \cap \mathcal{F}^{\ell-1}$ . First  $\partial D^\ell$  is divided into three parts  $A'_i := A_i \cap \partial D^\ell$ ,  $i = 2, 3, 4$  (see §5.2 for the definitions of  $A_1, \dots, A_4$ ) more precisely,

- (2)  $A'_2 := \{v \in D^\ell; \|v\| = 1, \theta \geq \theta_0\}$ ,
- (3)  $A'_3 := \{v \in D^\ell; \|v\| = 1, \theta \leq -\theta_0\}$ ,
- (4)  $A'_4 := \{v \in D^\ell; \|v\| = 1, -\theta_0 \leq \theta \leq \theta_0\}$ ,

where  $\theta$  is the latitude of  $v$ , namely,  $v = (x_1, \dots, x_\ell) = (x' \cos \theta, \|x'\| \sin \theta)$ , and  $\theta_0$  is a small fixed latitude. Write  $(\partial\sigma_C)_i := (\partial\sigma_C)|_{A'_i} : A'_i \rightarrow F_{\mathbb{C}}$ .

In view of Lemma 6.2.2, we have to count intersections of the map

$$(\partial\sigma_C) : A'_2 \cup A'_3 \cup A'_4 \longrightarrow \mathcal{F}_{\mathbb{C}}^{\ell-1} \quad (23)$$

with  $C' \cap \mathcal{F}_{\mathbb{R}}^{\ell-1}$  for  $C' \in \text{ch}_{\ell-1}^{\mathcal{F}}(\mathcal{A})$ .

It follows from Lemma 5.2.2 that  $(\partial\sigma_C)_4 : A'_4 \rightarrow \mathbf{M}(\mathcal{A}) \cap \mathcal{F}_{\mathbb{R}}^{\ell-1}$  does not intersect  $C' \cap \mathcal{F}_{\mathbb{R}}^{\ell-1}$  for any chamber  $C' \in \text{ch}_{\ell-1}^{\mathcal{F}}(\mathcal{A})$ .

Suppose  $v \in A'_2$ . Recall that by the definition (12) of  $\xi$ ,  $\xi(v) \in \mathcal{F}_{\mathbb{R}}^{\ell-1}$  is the point such that the vector  $\overrightarrow{\xi(v)p}$  is proportional to  $v$ . And it is obvious that the map  $\xi_{A'_2} : A'_2 \rightarrow D_0 : v \mapsto \xi(v)$  is a diffeomorphism. The orientation on  $A'_2$  is determined by (19).  $\xi_{A'_2}$  is orientation preserving (resp. reversing) if  $\text{sign}(C) = 1$  (resp.  $\text{sign}(C) = -1$ ).  $(\partial\sigma_C)_2(v)$  can be expressed as

$$(\partial\sigma_C)_2(v) = U_\tau(\xi(v)) \in T_{\xi(v)}F_{\mathbb{R}}.$$

The vector field  $U_\tau$  is not zero on  $(\mathcal{A} \cap D_0) \cup S_0$ . Up to small perturbation, we may assume that the zero locus of  $U_\tau$  consists of a finite number of points. Intersections of  $(\partial\sigma_C)_2$  with  $\mathcal{P}(C') \subset \mathbf{M}(\mathcal{A}) \cap \mathcal{F}_{\mathbb{C}}^{\ell-1}$  can be thought of as the set of singular points of the vector field  $U_\tau$ . Hence the sum of local intersection numbers is equal to the degree of the map from the boundary  $\partial\mathcal{P}(C')$  to the sphere  $S^{\ell-2}$ . Thus we have

$$I((\partial\sigma_C)_2, \mathcal{P}(C')) = (-1)^{\ell-1} \text{sign}(C) \text{deg}(C, C').$$



Similarly,

$$(\partial\sigma_C)_3(v) = -U_\tau(\xi(v)) \in T_{\xi(v)}F_{\mathbb{R}},$$

and we have

$$I((\partial\sigma_C)_3, \mathcal{P}(C')) = (-1)^\ell \text{sign}(C) \deg(C, C').$$

By the definition of  $(\sigma_C)_2 : A_2 \rightarrow \mathbf{M}(\mathcal{A})$ ,  $(\partial\sigma_C)_{2*} : \Phi(C) \rightarrow (\partial\sigma_C)_2^* \Phi(C') \xrightarrow{\sim} \Phi(C')$  is equal to

$$\Phi_{P^-(C, C')} : \Phi(C) \longrightarrow \Phi(C').$$

Similarly,  $(\partial\sigma_C)_{3*} : \Phi(C) \rightarrow \Phi(C')$  is equal to

$$\Phi_{P^+(C, C')} : \Phi(C) \longrightarrow \Phi(C').$$

The proof is then completed by employing Lemma 6.2.2.  $\square$

## 6.5 Examples

Let  $\mathcal{A} = \{H_1, \dots, H_n\}$  be a hyperplane arrangement in  $\mathbb{R}^\ell$ . Fix a nonzero complex number  $q_i \in \mathbb{C}^*$  for each  $i = 1, \dots, n$ . Then we can define a representation  $\Phi$  of  $\text{Gal}(\mathcal{A})$  as follows. First we put

$$\Phi(C) = \mathbb{C}[\sigma_C]$$

for each  $C \in \text{ch}(\mathcal{A})$ . Given two chambers  $C, C' \in \text{ch}(\mathcal{A})$ , suppose that  $\{H_{i_1}, \dots, H_{i_k}\}$  is the set of all hyperplanes separating  $C$  and  $C'$ . Then define

$$\Phi_{P^+(C, C')} : \Phi(C) \longrightarrow \Phi(C'), \quad [\sigma_C] \longmapsto q_{i_1} q_{i_2} \cdots q_{i_k} [\sigma_{C'}].$$

By the definition of  $\text{Gal}(\mathcal{A})$  (3.3.1 (4))  $\Phi$  determines a representation  $\Phi : \text{Gal}(\mathcal{A}) \rightarrow \text{Vect}_{\mathbb{C}}$ , hence a rank one local system  $\mathcal{L}_\Phi$ , such that the local monodromy around  $H_i$  is  $q_i^2$ . Conversely any rank one local system can be obtained in this way.

Let us consider an arrangement of three lines  $\mathcal{A}$  (Fig. 12) with a generic flag  $\mathcal{F}^0 \subset \mathcal{F}^1 \subset \mathcal{F}^2 = V_{\mathbb{R}}$  oriented by  $(v_1, v_2)$  and

$$\begin{aligned} \text{ch}_0^{\mathcal{F}}(\mathcal{A}) &= \{C_0\} \\ \text{ch}_1^{\mathcal{F}}(\mathcal{A}) &= \{C_1, C_2, C_3\} \\ \text{ch}_2^{\mathcal{F}}(\mathcal{A}) &= \{C_4, C_5, C_6\}. \end{aligned}$$

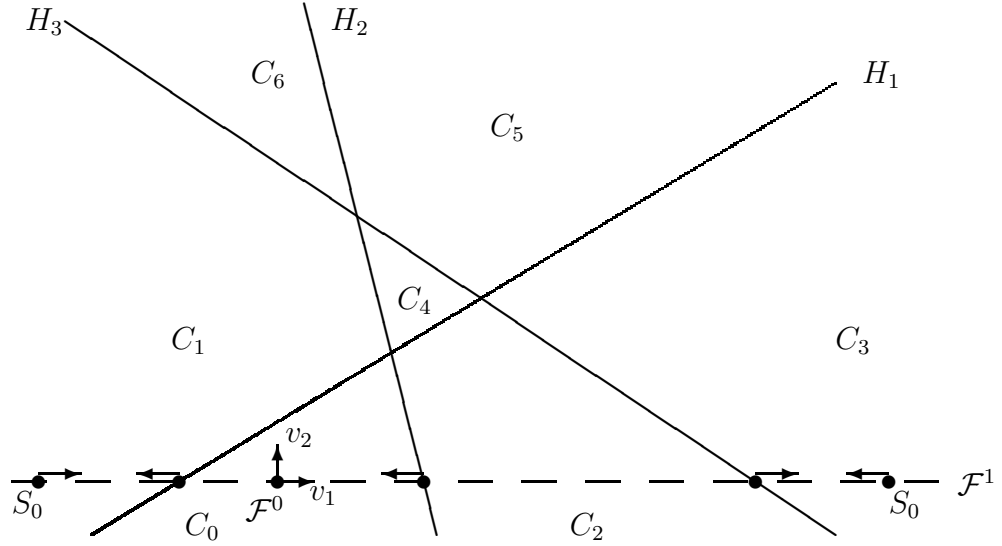

Figure 12: Three lines with flags and a vector field directing to  $C_6$

A vector field directing to  $C_6$  is also drawn in Figure 12.

Define the chain complex  $\mathcal{C}_k$  as in §6. The boundary map  $\partial_\Phi : \mathcal{C}_2 \rightarrow \mathcal{C}_1$  is, for example,

$$\begin{aligned} \partial[\sigma_6] &= -\sum_{i=1}^3 \deg(C_6, C_i) \Delta_\Phi(C_6, C_i)[\sigma_i] \\ &= -\left( -(q_3 - q_3^{-1})[\sigma_1] + (q_1 q_2 q_3 - q_1^{-1} q_2^{-1} q_3^{-1})[\sigma_2] - (q_1 q_2 - q_1^{-1} q_2^{-1})[\sigma_3] \right). \end{aligned}$$

Similarly,

$$\begin{aligned} \partial[\sigma_5] &= (q_2 q_3 - q_2^{-1} q_3^{-1})[\sigma_1] + (q_1 - q_1^{-1})[\sigma_3], \\ \partial[\sigma_4] &= (q_2 - q_2^{-1})[\sigma_1] + (q_1 - q_1^{-1})[\sigma_2]. \end{aligned}$$

$\partial : \mathcal{C}_1 \rightarrow \mathcal{C}_0$  is calculated as

$$\begin{pmatrix} \partial[\sigma_1] \\ \partial[\sigma_2] \\ \partial[\sigma_3] \end{pmatrix} = \begin{pmatrix} -(q_1 - q_1^{-1}) \\ q_2 - q_2^{-1} \\ q_2 q_3 - q_2^{-1} q_3^{-1} \end{pmatrix} [\sigma_0].$$

Then direct computations show that the local system is resonant, i.e.  $H_1(\mathcal{C}_\bullet, \partial) \neq 0$ , if and only if  $q_1^2 = q_2^2 = q_3^2 = 1$ .

If we move the hyperplane  $H_2$  so that the chamber  $C_4$  collapses, we obtain another arrangement  $\overline{\mathcal{A}}$ . In this case  $\mathcal{C}_2(\overline{\mathcal{A}})$  is generated by  $[\sigma_5]$  and  $[\sigma_6]$ . Hence the local system is resonant exactly when  $\partial[\sigma_5]$  and  $\partial[\sigma_6]$  are linearly dependent, or equivalently,  $(q_1q_2q_3)^2 = 1$ .

## 7 Appendix

From attaching maps for  $\ell = 2$ , we obtain a presentation for the fundamental group  $\pi_1(\mathbf{M}(\mathcal{A}))$ .

Let  $\mathcal{A} = \{H_1, \dots, H_n\}$  be a line arrangement in  $V = \mathbb{R}^2$ . Let  $\mathcal{F}^0 \subset \mathcal{F}^1 = F \subset V$  be an oriented generic flag. Note that  $F_{\mathbb{R}}$  is an oriented line. We may assume that the chambers are ordered as

$$\begin{aligned} \text{ch}_0^{\mathcal{F}}(\mathcal{A}) &= \{C_0\} \\ \text{ch}_1^{\mathcal{F}}(\mathcal{A}) &= \{C_1, \dots, C_n\} \\ \text{ch}_2^{\mathcal{F}}(\mathcal{A}) &= \{C_{n+1}, \dots, C_{n+b_2}\}, \end{aligned}$$

and that the ordering  $C_1, \dots, C_n$  goes along with the orientation, that is, the intervals  $C_1 \cap F_{\mathbb{R}}, \dots, C_n \cap F_{\mathbb{R}}$  are ordered from a negative place to a positive place with respect to the orientation for  $F_{\mathbb{R}}$ . The corresponding 1-cells  $\{\gamma_i = \sigma_{C_i}\}_{i=1, \dots, n}$  are illustrated in Figure 13.

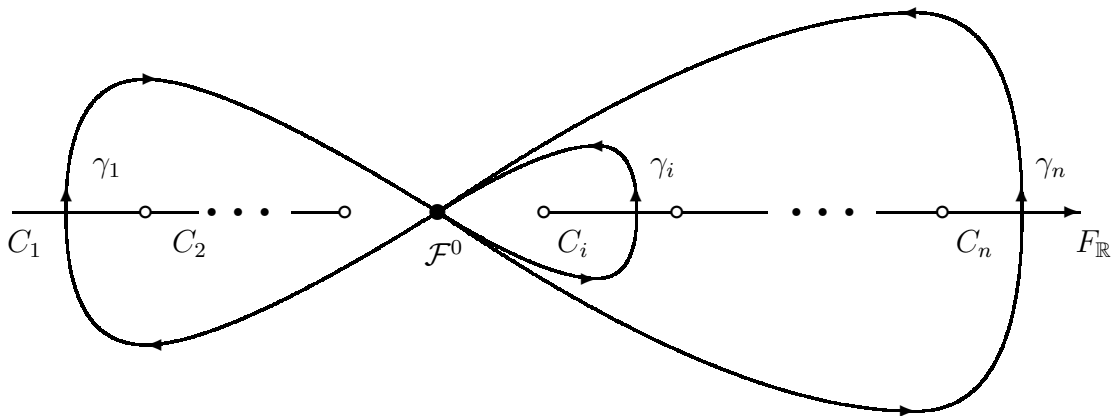

Figure 13: 1-cells in  $F_{\mathbb{R}} \otimes \mathbb{C}$

Each chamber  $C \in \text{ch}_2^{\mathcal{F}}(\mathcal{A})$  is corresponding to a 2-cell  $\sigma_C$ . Thus the boundary  $\partial\sigma_C$ , which is a word of generators  $\{\gamma_i\}$ , gives a relation in the

fundamental group. The relation is

$$R(C) := \gamma_1^{e_1} \gamma_2^{e_2} \cdots \gamma_n^{e_n} \gamma_1^{-e_1} \gamma_2^{-e_2} \cdots \gamma_n^{-e_n} = 1,$$

where

$$e_i = \deg(C, C_i).$$

**Theorem 7.0.1** *The fundamental group  $\pi_1(\mathbf{M}(\mathcal{A}))$  is presented as:*

$$\pi_1(\mathbf{M}(\mathcal{A})) \cong \langle \gamma_1, \dots, \gamma_n \mid R(C), C \in \text{ch}_2^{\mathcal{F}}(\mathcal{A}) \rangle.$$

We apply this theorem to the arrangement in Figure 12 (§6.5). Then

$$\begin{aligned} R(C_4) &= \gamma_1^{-1} \gamma_2^{-1} \gamma_1 \gamma_2 \\ R(C_5) &= \gamma_1^{-1} \gamma_3^{-1} \gamma_1 \gamma_3 \\ R(C_4) &= \gamma_1^{-1} \gamma_2 \gamma_3^{-1} \gamma_1 \gamma_2^{-1} \gamma_3. \end{aligned}$$

Hence the fundamental group is isomorphic to the abelian group

$$\pi_1(\mathbf{M}(\mathcal{A})) = \mathbb{Z}\gamma_1 \oplus \mathbb{Z}\gamma_2 \oplus \mathbb{Z}\gamma_3.$$

**Acknowledgements.** In the preparation of this paper, the author benefited from many people's advice. The author wishes to thank Manabu Akaho, David Bessis, Emanuele Delucchi, Yukihito Kawahara, Toshitake Kohno, Anatoly Libgober, Simona Settepanella, Hiroaki Terao, Lê Dũng Tráng, Ky-oji Saito and Sergey Yuzvinsky for their interests in this work, comments, helpful discussion and encouragements, Hiroyuki Yashima for discussing the Deligne groupoid. The author also thanks Eiko Fukunaga for her help on English. This research is supported by JSPS Fellowships for Young Scientists No. 16-0658.

## References

- [AF] A. Andreotti, T. Frenkel, The Lefschetz theorem on hyperplane sections. *Ann. of Math. (2)* **69** (1959) 713–717.
- [BHR] T. P. Bidigare, P. Hanlon, D. N. Rockmore, A combinatorial description of the spectrum for the Tsetlin library and its generalization to hyperplane arrangements. *Duke Math. J.* **99** (1999) 135–174.

- [BLSWZ] A. Björner, M. Las Vergnas, B. Sturmfels, Neil White, G. Ziegler, *Oriented Matroids*, Cambridge University Press, 1999.
- [Bo] R. Bott, On a theorem of Lefschetz. *Michigan Math. J.* **6** (1959) 211–216.
- [Ch] D. Cheniot, Une démonstration du théorème de Zariski sur les sections hyperplanes d’une hypersurface projective et du théorème de Van Kampen sur le groupe fondamental du complémentaire d’une courbe projective plane. *Compositio Math.* **27** (1973), 141–158.
- [Co1] D. Cohen, Cohomology and intersection cohomology of complex hyperplane arrangements. *Adv. Math.* **97** (1993), no. 2, 231–266.
- [Co2] D. Cohen, Morse inequalities for arrangements. *Adv. Math.* **134** (1998), no. 1, 43–45.
- [CO] D. Cohen, P. Orlik, Arrangements and local systems. *Math. Res. Lett.* **7** (2000), no. 2-3, 299–316.
- [De] P. Deligne, Les immeubles des groupes de tresses généralisés. *Invent. Math.* **17** (1972), 273–302.
- [DP1] A. Dimca, S. Papadima, Hypersurface complements, Milnor fibers and higher homotopy groups of arrangements. *Ann. of Math. (2)* **158**(2003), no. 2, 473–507.
- [DP2] A. Dimca, S. Papadima, Equivariant chain complexes, twisted homology and relative minimality of arrangements. *Ann. Sci. École Norm. Sup. (4)* **37** (2004), no. 3, 449–467.
- [Fa] M. Falk, Homotopy types of line arrangements. *Invent. Math.* **111** (1993), no. 1, 139–150.
- [GM] M. Goresky, R. MacPherson, *Stratified Morse theory*. *Ergebnisse der Mathematik und ihrer Grenzgebiete (3)* 14. Springer-Verlag, Berlin, 1988.
- [Ha] H. A. Hamm, Lefschetz theorems for singular varieties. *Proc. Symp. Pure Math.* **40** (1983), 547–557.

- [HL] H. A. Hamm, D. T. Lê, Un théorème de Zariski du type de Lefschetz. *Ann. Sci. École Norm. Sup.* **6** (1973), 317–355.
- [Lê] D. T. Lê, Calcul du nombre de cycles évanouissants d’une hypersurface complexe. *Ann. Inst. Fourier, Grenoble* **23** (1973), 261–270.
- [Li] A. Libgober, On the homotopy type of the complement to plane algebraic curves. *J. Reine Angew. Math.* **367** (1986), 103–114.
- [Ma] D. B. Massey, Lê cycles and hypersurface singularities. *Lecture Notes in Mathematics*, 1615. Springer-Verlag, Berlin, 1995.
- [Mi1] J. Milnor, Morse theory. *Annals of Mathematics Studies*, No. 51 Princeton University Press, Princeton, N.J.
- [Mi2] J. Milnor, Singular points of complex hypersurfaces. *Annals of Mathematics Studies*, No. 61 Princeton University Press, Princeton, N.J.
- [OS] P. Orlik, L. Solomon, Combinatorics and topology of complements of hyperplanes. *Invent. Math.* **56** (1980), 167–189.
- [OT1] P. Orlik, H. Terao, Arrangements of Hyperplanes. *Grundlehren Math. Wiss.* **300**, Springer-Verlag, New York, 1992.
- [OT2] P. Orlik, H. Terao, The number of critical points of a product of powers of linear functions. *Invent. Math.* **120** (1995), no. 1, 1–14.
- [PS] S. Papadima, A. Suciu, Higher homotopy groups of complements of complex hyperplane arrangements. *Adv. Math.* **165** (2002), no. 1, 71–100.
- [Pa1] L. Paris, The covers of a complexified real arrangement of hyperplanes and their fundamental groups. *Topology Appl.* **53** (1993), 75–103.
- [Pa2] L. Paris, On the fundamental group of the complement of a complex hyperplane arrangement. *Arrangements—Tokyo 1998*, 257–272, *Adv. Stud. Pure Math.*, **27**, Kinokuniya, Tokyo, 2000.
- [Ra1] R. Randell, The fundamental group of the complement of a union of complex hyperplanes. *Invent. Math.* **69** (1982), no. 1, 103–108.

- [Ra2] R. Randell, Morse theory, Milnor fibers and minimality of hyperplane arrangements. Proc. Amer. Math. Soc. **130** (2002), no. 9, 2737–2743.
- [Sa] M. Salvetti, Topology of the complement of real hyperplanes in  $C^N$ . Invent. Math. **88** (1987), no. 3, 603–618.
- [Si] R. Silvotti, On a conjecture of Varchenko. Invent. Math. **126** (1996), no. 2, 235–248.
- [Va] A. N. Varchenko, Critical points of the product of powers of linear functions and families of bases of singular vectors. Compositio Math. **97** (1995), no. 3, 385–401.
- [Y] M. Yoshinaga, Minimal decompositions of hyperplane complements and nonresonant local system homology. (In preparation)
- [Za] T. Zaslavsky, Facing up to arrangements: Face-count formulas for partitions of space by hyperplanes. Memoirs Amer. Math. Soc. **154** 1975.