

Uniform convergence groups: ideal boundaries of pseudo-Anosov flows and dynamical system models for weak hyperbolization

Sérgio R. Fenley ^{*†}

May 24, 2019

1 Introduction

In this article we show that a large class of pseudo-Anosov flows have strong consequences for the large scale geometry of the ambient three manifold, that is, their dynamics gives a very explicit description of weak hyperbolization for such manifolds, with several important consequences. First we consider general pseudo-Anosov flows: the orbit space of the lifted flow to the universal cover is homeomorphic to an open disk. We show that it has a natural compactification to a closed disk with an ideal circle boundary. This is group equivariant and completely determined by the dynamics of the stable/unstable foliations of the flow. Suppose then that the flow has no perfect fits between stable and unstable leaves (or no asymptotic leaves) and is not topologically conjugate to a suspension Anosov flow. In this case we show that the ideal circle of the flow as above has a quotient space which is a sphere and the fundamental group of the manifold acts naturally in this sphere. This quotient is completely determined by the structure of the stable/unstable foliations of the flow. The main result is that the action of the fundamental group on this sphere is a uniform convergence group action. A result of Bowditch then implies that the group is Gromov hyperbolic and the action on the above sphere is naturally conjugate to the action of the fundamental group on the Gromov ideal boundary of the group. The above constructed sphere also produces a compactification of the universal cover, which again is equivariantly conjugate to the Gromov compactification. Using this last fact we then show that these pseudo-Anosov flows without perfect fits are quasigeodesic flows, producing new examples of quasigeodesic flows. We also show that the stable/unstable foliations of these flows are quasi-isometric and we produce new examples of group invariant Peano curves. Finally we apply these results to the study of foliations: if a foliation is \mathbf{R} -covered or with one sided branching in an atoroidal three manifold then it is transverse to a pseudo-Anosov flow without perfect fits. The results above imply that the leaves of the foliation in the universal cover extend continuously to the sphere at infinity, proving the continuous extension property for such foliations.

There is a well established and long history in three manifold theory that topology determines geometry. The best known example of this is Thurston's proof of the geometrization conjecture in several situations where the topological structure of the manifold was used as building blocks for a hyperbolic structure [Th1, Th2, Th3, Mor, Ot1, Ot2]. Other important results were obtained by Gabai and collaborators [Ga2, GMT, Ga-Ka, Ga-Oe] and many other researchers.

The purpose of this article is to use dynamical systems to obtain geometric information. The focus will be on the large scale geometry or coarse geometry of the universal cover, group negative

^{*}Research partially supported by NSF grant DMS-0305313.

[†]Mathematics Subject Classification. Primary: 37D20, 53C23, 57R30, 37C85; Secondary: 57M50, 37D50, 58D19.

curvature, quasi objects and asymptotic behavior. In this form one has the weak hyperbolization conjecture which states that a closed irreducible three manifold with infinite fundamental group either has a $\mathbf{Z} \oplus \mathbf{Z}$ in its fundamental group or the fundamental group is Gromov hyperbolic, also called negatively curved [Gr, Gh-Ha, CDP].

We will use pseudo-Anosov flows to obtain Gromov hyperbolicity. More specifically these flows will be used to describe explicitly the Gromov ideal boundary and compactification of the universal cover using only dynamical system objects. In fact we will first construct a purely dynamical ideal boundary to the universal cover (it is a sphere), which together with the group action shows that the fundamental group is Gromov hyperbolic and a posteriori shows that this dynamical ideal boundary and compactification are equivalent to the Gromov ideal boundary and compactification. As such this is an entirely new approach to Gromov hyperbolicity. This has consequences for the quasigeodesic question for flows and the continuous extension property for foliations in manifolds with Gromov hyperbolic fundamental group. The basis of the whole analysis is a construction of an ideal circle associated to any pseudo-Anosov flow which we describe first.

Suppose that Φ is a general pseudo-Anosov flow in a closed 3-manifold M . Such flows are very common [Th4, Bl-Ca, Mo2, Mo3, Th5, Fe9, Cal2, Cal3]. The flow has associated stable and unstable (possibly singular) foliations. When there are no singularities the flow is an Anosov flow. The orbit space of the lifted flow to the universal cover of M is denoted by \mathcal{O} and is homeomorphic to an open disk [Fe3, Fe-Mo]. The fundamental group of M acts naturally in \mathcal{O} . There are induced (singular) stable/unstable foliations in \mathcal{O} . Our first result is the construction of a compactification of \mathcal{O} .

Theorem A – Let Φ be a pseudo-Anosov flow in M^3 closed. Let $\tilde{\Phi}$ be the lifted flow to the universal cover and \mathcal{O} be the the orbit space of $\tilde{\Phi}$. Then there is an ideal circle boundary $\partial\mathcal{O}$ obtained from the structure of the stable and unstable foliations in \mathcal{O} . There is also a compactification $\mathcal{D} = \mathcal{O} \cup \partial\mathcal{O}$ which is homeomorphic to a closed disk. The fundamental group acts by homeomorphisms in \mathcal{D} .

The stable/unstable foliations $\tilde{\Lambda}^s, \tilde{\Lambda}^u$ in the universal cover project to 1-dimensional perhaps singular foliations $\mathcal{O}^s, \mathcal{O}^u$ in \mathcal{O} . The possible singularities are only of p -prong type with $p \geq 3$. The foliations $\mathcal{O}^s, \mathcal{O}^u$ are transverse to each other. The prototype here is a suspension pseudo-Anosov flow – then \mathcal{O} is identified to a lift of a fiber – the fiber is a hyperbolic surface. In this case the ideal circle boundary of \mathcal{O} is identified to the circle at infinity of the lift of the fiber. We stress that in general there is no geometry (even coarse geometry) in the space \mathcal{O} .

Roughly an ideal point of \mathcal{O} is defined by a sequences of chains – a chain is a finite collection of segments alternatively in $\mathcal{O}^s, \mathcal{O}^u$ and 2 rays in these foliations which forms a properly embedded path in \mathcal{O} . The chains have to be what is called “convex”. The sequence defines a neighborhood system of the ideal point. The use of chains and not just leaves of $\mathcal{O}^s, \mathcal{O}^u$ to define ideal points is due to the existence of perfect fits as explained below. Any ray in a leaf is properly embedded in \mathcal{O} and defines an ideal point of \mathcal{O} , but there are many other points. There is a natural topology in $\mathcal{D} = \mathcal{O} \cup \partial\mathcal{O}$ which is group equivariant. The proof that \mathcal{D} is homeomorphic to a closed disk is quite involved. We show there is a natural cyclic order in $\partial\mathcal{O}$, the space $\partial\mathcal{O}$ is metrizable, connected and more importantly it is compact. We use classical point set theorems to show that $\partial\mathcal{O}$ is homeomorphic to a circle and \mathcal{D} is homeomorphic to a closed disk. This works for any pseudo-Anosov flow.

We remark that Calegari and Dunfield [Ca-Du] previously showed that if Φ is a pseudo-Anosov flow, then $\pi_1(M)$ acts nontrivially on a circle. They obtained very important consequences for the existence question for pseudo-Anosov flows in 3-manifolds [Ca-Du]. Their construction is very different than ours. They consider the space of ends of the leaf space of say $\tilde{\Lambda}^s$. They show that the space of ends is circularly ordered and maps injectively to a circle. By collapsing complementary intervals one gets an action in \mathbf{S}^1 . This is much weaker than producing a nice, natural compactification of \mathcal{O} .

For example, consider sequences of \mathcal{O} , escaping compact sets in \mathcal{O} and so that all points are in the same stable leaf. As seen in the leaf space the points do not go into any end, but they should have a convergent subsequence in a compactification of \mathcal{O} . Here we show much more, producing an actual compactification of the orbit space as a closed disk.

The main result of the article states that dynamics can be used to describe explicitly the asymptotic geometry of the universal cover in the case of pseudo-Anosov flows without perfect fits. We first define perfect fits and explain why they are so important for pseudo-Anosov flows.

Roughly an unstable leaf G of $\tilde{\Lambda}^u$ makes a perfect fit with a stable leaf F of $\tilde{\Lambda}^s$ if G and F do not intersect but any other unstable leaf sufficiently near G (and in the F side), will intersect F and vice versa. We also say that G, F are asymptotic, see detailed definition in section 2 (see figure 1, a). The same happens to projections in the orbit space. In the orbit space we can think of a perfect fit as a properly embedded rectangle with sides alternatively in stable/unstable leaves. There is one missing corner or an ideal corner. The 2 leaves with that ideal corner form a perfect fit.

Perfect fits are extremely important in the topological theory of pseudo-Anosov flows, see [Fe3, Fe4, Fe6, Fe8]. They occur for instance whenever there are closed orbits of Φ which are freely homotopic [Fe6, Fe8] or when the leaf space of $\tilde{\Lambda}^s$ or $\tilde{\Lambda}^u$ is not Hausdorff [Fe6, Fe8]. Suspensions do not have perfect fits and many other flows do not have perfect fits as will be explained below.

Perfect fits are relevant when considering ideal points of \mathcal{O} : consider all the stable leaves intersecting an unstable ray l . As the intersection with l escapes in l one naively expects that the sequence escapes compact sets in the orbit space – this occurs in the suspension case above and in many other situations. But it does not occur in general. When it does not occur, then the sequence of stable leaves limits to a leaf r' and after a few modifications we produce a stable leaf r , so that r and l form a perfect fit. Because of perfect fits one needs to consider not only sequences of stable/unstable leaves which are escaping in \mathcal{O} but rather sequences of chains when considering ideal points of \mathcal{O} . If F, L form a perfect fit then the corresponding rays in the orbit space define the same ideal point in $\partial\mathcal{O}$. Suspension Anosov flows are special and have to be treated differently, because in their case a sequence of stable leaves in $\tilde{\Lambda}^s$ escaping compact sets approaches infinitely many ideal points.

Recall that if the fundamental group of a 3-manifold is Gromov hyperbolic, then Gromov showed that the universal cover \tilde{M} has a compactification with an ideal boundary [Gr, Gh-Ha]. When M is irreducible Bestvina and Feighn showed that the ideal boundary is a sphere and the compactification is homeomorphic to a closed 3-ball [Be-Me]. Our main result is the following:

Main theorem – Let Φ be a pseudo-Anosov flow without perfect fits and not topologically conjugate to a suspension Anosov flow. Let \mathcal{O} be its orbit space and $\partial\mathcal{O}$ its ideal boundary. Let \mathcal{G} be the equivalence relation in $\partial\mathcal{O}$ generated by: two points are in the same equivalence class if they are the ideal points of the same stable or unstable leaf. Let \mathcal{R} be the set of equivalence classes with the quotient topology. Then \mathcal{R} is a 2-sphere. The fundamental group of M acts naturally on \mathcal{R} by homeomorphisms. This action is a uniform convergence group action. A theorem of Bowditch then implies that $\pi_1(M)$ is Gromov hyperbolic and the action of $\pi_1(M)$ on \mathcal{R} is topologically conjugate to the action of $\pi_1(M)$ on the Gromov ideal boundary of $\pi_1(M)$.

Any point in $\partial\mathcal{O}$ is identified to at most a bounded finitely many other points of $\partial\mathcal{O}$. This is because if x, y are related under \mathcal{G} and x, y are ideal points of the (say) same stable leaf in \mathcal{O}^s , then the no perfect fits condition implies there is no unstable leaf with ideal points x or y . Hence if p is the maximum number of prongs in singular leaves of \mathcal{O}^s (or \mathcal{O}^u), then any equivalence class of \mathcal{G} has at most p points. Using an approach similar to that of Cannon and Thurston [Ca-Th] it is not hard to show that $\partial\mathcal{O}/\mathcal{G}$ is a 2-dimensional sphere \mathcal{R} where the group $\pi_1(M)$ acts naturally. The hard part of the proof is to show that this action is a uniform convergence group action.

An important result of Bowditch [Bo1] using ideas of Gromov is the key tool here. A group Γ acts as a convergence group in a compactum Z if Γ acts properly and discontinuously in the set of distinct triples $\Theta_3(Z)$. Equivalently for any sequence $(\gamma_n), n \in \mathbf{N}$ of distinct elements in Γ , there is a subsequence $(\gamma_{n_i}), i \in \mathbf{N}$ and a source/sink pair y, x so that $(\gamma_{n_i}), i \in \mathbf{N}$ converges locally uniformly to x in $Z - \{y\}$ [Ge-Ma, Bo2]. Locally uniformly means uniform convergence in compact subsets [Tu1, Tu2, Bo1]. The action is a uniform action if the quotient of $\Theta_3(Z)$ by the action is compact. Equivalently every point of Z is a conical limit point for the action. This means that if x is in Z then there is a sequence $(\gamma_n), n \in \mathbf{N}$ in Γ with $\gamma_n(x)$ converging to a but for some point y in Z then $\gamma_n(y)$ converges to a point distinct from a .

Bowditch [Bo1], following ideas of Gromov, proved the very interesting theorem that if Γ acts as a uniform convergence group in a compactum Z , then Γ is Gromov hyperbolic, Z is homeomorphic to the Gromov ideal boundary $\partial\Gamma$ and the action on Z is equivariantly topologically conjugate to the action of Γ on its Gromov ideal boundary.

We prove the uniform convergence group property for the action of $\pi_1(M)$ on the sphere \mathcal{R} . There is a strong interplay between 2-dimensional dynamics of the action of $\pi_1(M)$ in \mathcal{R} and the action of $\pi_1(M)$ in $\partial\mathcal{O}$, which describes the other action. In other words 1-dimensional dynamics (action on a circle) completely encodes 2-dimensional dynamics. A lot of the proof can be done using only this interplay and the action in the 2-dimensional space \mathcal{O} , but as expected the 3-dimensional setting of the flow $\tilde{\Phi}$ in the universal cover of M needs to be used in some crucial steps.

Our strategy is to show the source/sink behavior for sequences in $\pi_1(M)$ and then the the conical limit point property. For the first property we break into 3 cases up to subsequences: 1) every γ_n is associated to a singular orbit of Φ , 2) every γ_n is associated to a non singular closed orbit of Φ , 3) every γ_n acts freely in \mathcal{O} . For example consider case 2). The action of γ_n in $\partial\mathcal{O}$ immediately has 4 fixed points, associated to the 2 ideal points of the stable leaf of the periodic orbit and the 2 unstable ones. By dynamics, the stable points are locally attracting for the action of γ_n in $\partial\mathcal{O}$ and the unstable ones are locally repelling. When there are no perfect fits this carries over to the whole of $\partial\mathcal{O}$. As the 2 ideal points of a stable leaf are identified in \mathcal{R} , this produces a source/sink behavior for one γ_n . An extended analysis shows the source/sink behavior for sequences.

In order to prove that an arbitrary point in \mathcal{R} is a conical limit point we consider the case that x corresponds to an ideal point of a periodic leaf of \mathcal{O}^s or \mathcal{O}^u , then the case that x is an ideal point of some leaf of $\mathcal{O}^s, \mathcal{O}^u$ and finally the remaining case which is considerably trickier. The proof of the main theorem depends very heavily on the structure of the compactification $\mathcal{O} \cup \partial\mathcal{O}$ and the relationship between the foliations $\mathcal{O}^s, \mathcal{O}^u$ and the ideal boundary $\partial\mathcal{O}$.

It is very interesting that the ideal 2-sphere S_∞^2 or \mathcal{R} can be described as a finite to one quotient of a 1-manifold ($\partial\mathcal{O}$) and in addition $\pi_1(M)$ acts equivariantly on both objects. The constructions of this article can be seen as a dynamical systems analogue to Gromov's geometric constructions.

We remark that in this setup, the fact that $\pi_1(M)$ is Gromov hyperbolic also follows from a result of Gabai-Kazez [Ga-Ka]. The reason is: if M with a pseudo-Anosov flow is toroidal, then either there is a free homotopy between closed orbits of the flow or the flow is topologically conjugate to a suspension Anosov flow [Fe10]. The second possibility is disallowed by hypothesis. If there is a free homotopy between closed orbits, then previous results on the topological theory of pseudo-Anosov flows imply that there are perfect fits [Fe6, Fe8]. It follows that M is atoroidal. The stable foliation blows up to an essential lamination which is genuine, so [Ga-Ka] implies that $\pi_1(M)$ is Gromov hyperbolic. What is new and important here is that our construction gives a very explicit description of the Gromov ideal boundary of \tilde{M} – first as a purely dynamical object and then totally relating it to the geometric situation. The result of [Ga-Ka] is an indirect way to obtain Gromov hyperbolicity. In particular it provides no direct relationship with the Gromov ideal boundary. Gabai and Kazez show that least area disks satisfy a linear isoperimetric inequality. The proof of this fact

uses the ubiquity theorem of Gabai [Ga3] – which again is very powerful but indirect and mysterious.

If Φ is a suspension (singular) pseudo-Anosov flow, the main theorem provides a new proof that if M fibers over the circle with pseudo-Anosov monodromy then $\pi_1(M)$ is Gromov hyperbolic.

We should remark that if M is closed, atoroidal and with infinite fundamental group (which is not \mathbf{Z}) then Perelman’s results [Pe1, Pe2, Pe3], if confirmed, imply that M is hyperbolic. We do not make use of Perelman’s results here. In fact the point of this article is to analyse which geometric information can be obtained solely from dynamical systems constructions.

There is a natural topology in $\widetilde{M} \cup \mathcal{R}$ making it into a compactification of \widetilde{M} . Again this uses only the dynamics of the flow Φ . There is also a natural bijection ξ between $\widetilde{M} \cup \mathcal{R}$ and $\widetilde{M} \cup S_\infty^2$, which is the identity in \widetilde{M} and the conjugacy between \mathcal{R} and S_∞^2 in \mathcal{R} . The next result extends the result of the main theorem to the 3-dimensional setting and is the analogue of the Gromov hyperbolic situation [Ge-Ma, Fr, Gr].

Theorem C – Let Φ be a pseudo-Anosov flow not topologically conjugate to a suspension and without perfect fits. Then the action of $\pi_1(M)$ on the compact space $\widetilde{M} \cup \mathcal{R}$ is a convergence group action. It follows that $\xi : \widetilde{M} \cup \mathcal{R} \rightarrow \widetilde{M} \cup S_\infty^2$ is a homeomorphism which is group equivariant. Hence the compactifications $\widetilde{M} \cup \mathcal{R}$ and $\widetilde{M} \cup S_\infty^2$ are equivariantly conjugate.

In order to prove this consider a sequence of distinct elements $(\gamma_n), n \in \mathbf{N}$ of $\pi_1(M)$. By the main theorem we already know that up to subsequence it has a source/sink pair y, x for the action restricted to \mathcal{R} . We then show that y, x is a source sink pair for the action in $\widetilde{M} \cup \mathcal{R}$. This depends on a careful analysis of neighborhoods in $\widetilde{M} \cup \mathcal{R}$ of points in \mathcal{R} . The harder case is when such a point comes from an ideal point of a leaf of \mathcal{O}^s or \mathcal{O}^u . In order to finish the proof of theorem C we show that the bijection ξ is continuous. This follows easily from the convergence group action properties for the action in $\widetilde{M} \cup \mathcal{R}$ plus the conjugacy bijection between the actions in \mathcal{R} and S_∞^2 .

We now analyse important geometric consequences of these results. We study metric property of such flows and their stable/unstable foliations. In manifolds with Gromov hyperbolic fundamental group the relation between objects in \widetilde{M} and their limit sets is extremely important [Th1, Th2, Th3, Gr, Gh-Ha, CDP] and is related to the large scale geometry in \widetilde{M} . A flow in M is *quasigeodesic* if flow lines in \widetilde{M} are uniformly efficient in measuring ambient distance up to a bounded multiplicative distortion [Th1, Gr, Gh-Ha, CDP]. This concept is extremely important in such manifolds. [Th1, Gr]. It implies that each flow line is a bounded distance from the corresponding geodesic which has the same ideal points. Quasigeodesic flows are very useful [Ca-Th, Mo1, Mo2, Fe1, Fe4, Fe7]. The main theorem and theorem C provide a new way to obtain quasigeodesic flows:

Theorem D – Let Φ be a pseudo-Anosov flow not topologically conjugate to a suspension Anosov flow and without perfect fits. By the main theorem, $\pi_1(M)$ is Gromov hyperbolic. Then Φ is a quasigeodesic flow in M . In addition Λ^s, Λ^u are quasi-isometric singular foliations in M .

In order to prove theorem D we prove the following in the compactification $\widetilde{M} \cup \mathcal{R}$: 1) Each flow line γ of $\widetilde{\Phi}$ has a unique forward ideal point γ_+ in \mathcal{R} and a backward one γ_- ; 2) For each such γ the points γ_-, γ_+ are distinct; 3) The forward (backward) ideal point map is continuous. Using theorem C which conjugates the action in $\widetilde{M} \cup \mathcal{R}$ to the action in $\widetilde{M} \cup S_\infty^2$ it follows that the same is true in $\widetilde{M} \cup S_\infty^2$. A theorem of Fenley-Mosher [Fe-Mo] then implies that Φ is quasigeodesic.

Quasi-isometric behavior for Λ^s, Λ^u means that leaves of $\widetilde{\Lambda}^s$ (or $\widetilde{\Lambda}^u$) are uniformly efficient in measuring distance in \widetilde{M} [Th1, Gr, CDP]. This is the analogue of quasigeodesic in the two dimensional setting and again it is extremely useful [Gr, Th1, Th2, Th3]. To prove the second part of theorem D: the lack of perfect fits implies that the leaf spaces of $\widetilde{\Lambda}^s, \widetilde{\Lambda}^u$ are Hausdorff [Fe6, Fe8]. Together

with the fact that Φ is quasigeodesic this now implies that Λ^s, Λ^u are quasi-isometric foliations. This provides a new way to obtain quasi-isometric singular foliations.

Finally we apply these results to foliations and their asymptotic properties and we show that pseudo-Anosov flows without perfect fits are very common. A foliation \mathcal{F} is \mathbf{R} -covered if the leaf space \mathcal{H} of $\tilde{\mathcal{F}}$ is Hausdorff or equivalently homeomorphic to the real numbers. If \mathcal{H} is not Hausdorff then it is a simply connected, non Hausdorff, 1-dimensional manifold with a countable basis. Then it is orientable. The non separated points in \mathcal{H} correspond to branching in the negative (positive) direction if they are separated on their positive (negative) sides. A foliation \mathcal{F} has one sided branching if the branching in $\tilde{\mathcal{F}}$ is only in one direction (positive or negative).

If \mathcal{F} is a Reebless foliation in M^3 with $\pi_1(M)$ Gromov hyperbolic then each leaf F of $\tilde{\mathcal{F}}$ is uniformly Gromov hyperbolic and has an ideal circle $\partial_\infty F$ compactifying it to a closed disk $F \cup \partial_\infty F$. The *continuous extension question* asks whether the proper inclusion $i : F \rightarrow \tilde{M}$ extends continuously to $i : F \cup \partial_\infty F \rightarrow \tilde{M} \cup S_\infty^2$. If so then i restricted to $\partial_\infty F$ is a continuous parametrization of the limit set of F . When this happens for all leaves of $\tilde{\mathcal{F}}$, then \mathcal{F} has the continuous extension property [Ga1, Ca-Th, Fe12]. In this way the foliation has excellent asymptotic properties. We prove:

Theorem E – Let \mathcal{F} be an \mathbf{R} -covered foliation in M^3 , acylindrical and atoroidal. Up to a double cover \mathcal{F} is transverse to a pseudo-Anosov flow Φ without perfect fits and not conjugate to a suspension Anosov flow. Then Φ is quasigeodesic and \mathcal{F} satisfies the continuous extension property.

The continuous extension property has previously been proved for: 1) fibrations in the seminal work of Cannon and Thurston [Ca-Th], 2) Finite depth foliations and some other classes by the author [Fe8, Fe12], 3) slitherings or uniform foliations by Thurston [Th5]. The methods of the proof were completely different than in this article – in the previous cases one always had a strong geometric property to start with. Theorem E implies the previous results for fibrations and slitherings.

In order to prove theorem E start with a pseudo-Anosov flow Φ transverse to \mathcal{F} as constructed in [Fe9] or [Cal2]. We then show that such a flow is not conjugate to a suspension Anosov flow and has no perfect fits. By theorem D, the flow Φ is quasigeodesic. We then use [Fe12] to show that \mathcal{F} has the continuous extension property. Finally we prove:

Theorem F – Let \mathcal{F} be a foliation with one sided branching in M^3 atoroidal, acylindrical. Then \mathcal{F} is transverse to a pseudo-Anosov flow Φ without perfect fits and not conjugate to a suspension Anosov flow. Then Φ is quasigeodesic and \mathcal{F} has the continuous extension property. If F is a leaf of $\tilde{\mathcal{F}}$ then the limit set of F is not the whole sphere.

Using these conditions Calegari [Cal3] proved that \mathcal{F} is transverse to a pseudo-Anosov flow Φ . We show that such Φ does not have perfect fits nor is conjugate to a suspension Anosov flow. By theorem D, the flow Φ is quasigeodesic. As seen before this implies that \mathcal{F} has the continuous extension property. The second statement follows from metric properties of leaves of $\tilde{\Lambda}^s, \tilde{\Lambda}^u$.

The geometric properties of flows and foliations (theorems D, E and F) are proved at the very end of the article. They are quick consequences of the main theorem, theorem C and previous results. Theorems E, F provide a large class of examples of simple pseudo-Anosov flows and also quasigeodesic flows and quasi-isometric foliations.

The remaining open case for the continuous extension question is contained in the case when \mathcal{F} branches in both directions. The case of finite depth foliations was resolved very recently in [Fe12] using work of Mosher, Gabai and the author [Mo3, Fe-Mo]. In the minimal situation Calegari [Cal5] constructed a pair of very full laminations transverse to \mathcal{F} , like the stable/unstable foliations of a flow. It is possible that in certain situations these can be blown down to produce a pseudo-Anosov flow transverse or almost transverse to \mathcal{F} [Mo3]. When the ideal dynamics of the case of a pseudo-Anosov

flow with perfect fits is better understood, then Calegari's results could be very useful.

Calegari also obtained results for general quasigeodesic flows in Gromov hyperbolic 3-manifolds [Cal4]. In this article we start with a flow with no geometric properties.

Flows without perfect fits and not topologically conjugate to suspension pseudo-Anosov flows will be called simple, see section 2.

The article is organized as follows: section 2 covers background material, section 3 introduces ideal points of \mathcal{O} and compactification proving theorem A. In section 4 we prove the main theorem and theorem C. In section 5 we prove theorem D and in section 6 we prove theorems E and F.

We thank Lee Mosher who told us about Bowditch's theorem.

2 Preliminaries: Pseudo-Anosov flows and almost pseudo-Anosov flows

Let Φ be a flow on a closed, oriented 3-manifold M . We say that Φ is a *pseudo-Anosov flow* if the following are satisfied:

- For each $x \in M$, the flow line $t \rightarrow \Phi(x, t)$ is C^1 , it is not a single point, and the tangent vector bundle $D_t\Phi$ is C^0 .

- There is a finite number of periodic orbits $\{\gamma_i\}$, called *singular orbits*, such that the flow is "topologically" smooth off of the singular orbits (see below).

- The flowlines are tangent to two singular transverse foliations Λ^s, Λ^u which have smooth leaves off of γ_i and intersect exactly in the flow lines of Φ . These are like Anosov foliations off of the singular orbits. This is the topologically smooth behavior described above. A leaf containing a singularity is homeomorphic to $P \times I/f$ where P is a p -prong in the plane and f is a homeomorphism from $P \times \{1\}$ to $P \times \{0\}$. In a stable leaf, f contracts towards towards the prongs and in an unstable leaf it expands away from the prongs. We restrict to p at least 2, that is, we do not allow 1-prongs.

- In a stable leaf all orbits are forward asymptotic, in an unstable leaf all orbits are backwards asymptotic.

Basic references for pseudo-Anosov flows are [Mo1, Mo3].

Notation/definition: The singular foliations lifted to \widetilde{M} are denoted by $\widetilde{\Lambda}^s, \widetilde{\Lambda}^u$. If $x \in M$ let $\widetilde{W}^s(x)$ denote the leaf of Λ^s containing x . Similarly one defines $\widetilde{W}^u(x)$ and in the universal cover $\widetilde{W}^s(x), \widetilde{W}^u(x)$. Similarly if α is an orbit of Φ define $W^s(\alpha)$, etc... Let also $\widetilde{\Phi}$ be the lifted flow to \widetilde{M} .

We review the results about the topology of $\widetilde{\Lambda}^s, \widetilde{\Lambda}^u$ that we will need. We refer to [Fe6, Fe8] for detailed definitions, explanations and proofs. The orbit space of $\widetilde{\Phi}$ in \widetilde{M} is homeomorphic to the plane \mathbf{R}^2 [Fe-Mo] and is denoted by $\mathcal{O} \cong \widetilde{M}/\widetilde{\Phi}$. Let $\Theta : \widetilde{M} \rightarrow \mathcal{O} \cong \mathbf{R}^2$ be the projection map. If L is a leaf of $\widetilde{\Lambda}^s$ or $\widetilde{\Lambda}^u$, then $\Theta(L) \subset \mathcal{O}$ is a tree which is either homeomorphic to \mathbf{R} if L is regular, or is a union of p -rays all with the same starting point if L has a singular p -prong orbit. The foliations $\widetilde{\Lambda}^s, \widetilde{\Lambda}^u$ induce 1-dimensional foliations $\mathcal{O}^s, \mathcal{O}^u$ in \mathcal{O} . Its leaves are $\Theta(L)$ as above. If L is a leaf of $\widetilde{\Lambda}^s$ or $\widetilde{\Lambda}^u$, then a *sector* is a component of $\widetilde{M} - L$. Similarly for $\mathcal{O}^s, \mathcal{O}^u$. If B is any subset of \mathcal{O} , we denote by $B \times \mathbf{R}$ the set $\Theta^{-1}(B)$. The same notation $B \times \mathbf{R}$ will be used for any subset B of \widetilde{M} : it will just be the union of all flow lines through points of B .

Definition 2.1. *Let L be a leaf of $\widetilde{\Lambda}^s$ or $\widetilde{\Lambda}^u$. A slice of L is $l \times \mathbf{R}$ where l is a properly embedded copy of the reals in $\Theta(L)$. For instance if L is regular then L is its only slice. If a slice is the boundary of a sector of L then it is called a line leaf of L . If a is a ray in $\Theta(L)$ then $A = a \times \mathbf{R}$ is called a half leaf of L . If ζ is an open segment in $\Theta(L)$ it defines a flow band L_1 of L by $L_1 = \zeta \times \mathbf{R}$. Same notation for the foliations $\mathcal{O}^s, \mathcal{O}^u$ of \mathcal{O} .*

If $F \in \widetilde{\Lambda}^s$ and $G \in \widetilde{\Lambda}^u$ then F and G intersect in at most one orbit. Also suppose that a leaf $F \in \widetilde{\Lambda}^s$ intersects two leaves $G, H \in \widetilde{\Lambda}^u$ and so does $L \in \widetilde{\Lambda}^s$. Then F, L, G, H form a *rectangle* in \widetilde{M}

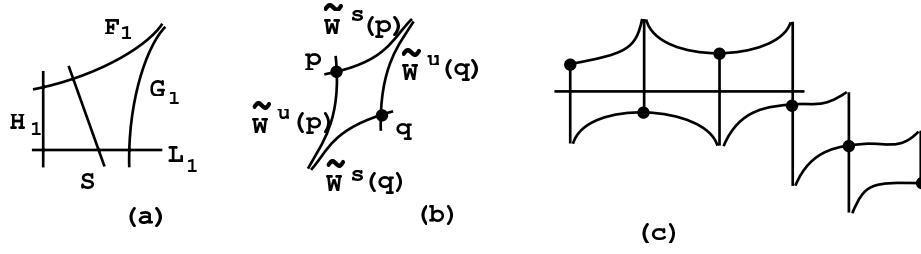

Figure 1: a. Perfect fits in \widetilde{M} , b. A lozenge, c. A chain of lozenges.

and there is no singularity in the interior of the rectangle [Fe8]. There will be two generalizations of rectangles: 1) perfect fits = rectangle with one corner removed and 2) lozenges = rectangle with two opposite corners removed. We will also denote by rectangles, perfect fits, lozenges and product regions the projection of these regions to $\mathcal{O} \cong \mathbf{R}^2$.

Definition 2.2. ([Fe4, Fe6, Fe8]) *Perfect fits* - Two leaves $F \in \widetilde{\Lambda}^s$ and $G \in \widetilde{\Lambda}^u$, form a perfect fit if $F \cap G = \emptyset$ and there are half leaves F_1 of F and G_1 of G and also flow bands $L_1 \subset L \in \widetilde{\Lambda}^s$ and $H_1 \subset H \in \widetilde{\Lambda}^u$, so that the set

$$\overline{F_1} \cup \overline{H_1} \cup \overline{L_1} \cup \overline{G_1}$$

separates M and the joint structure of $\widetilde{\Lambda}^s, \widetilde{\Lambda}^u$ in R is that of a rectangle with a corner orbit removed. The removed corner corresponds to the perfect of F and G . Specifically, a stable leaf intersects H_1 and only if it intersects G_1 and similarly for unstable leaves intersecting F_1, L_1 .

We refer to fig. 1, a for perfect fits. We also say that the leaves F, G are *asymptotic*.

Definition 2.3. ([Fe4, Fe6, Fe8]) *Lozenges* - A lozenge is a region of \widetilde{M} whose closure is homeomorphic to a rectangle with two corners removed. More specifically two points p, q form the corners of a lozenge if there are half leaves A, B of $\widetilde{W}^s(p), \widetilde{W}^u(p)$ defined by p and C, D half leaves of $\widetilde{W}^s(q), \widetilde{W}^u(q)$ so that A and D form a perfect fit and so do B and C . The region bounded by the lozenge is R and it does not have any singularities. See fig. 1, b.

There may be singular orbits on the sides of the lozenge and the corner orbits. Two lozenges are *adjacent* if they share a corner and there is a stable or unstable leaf intersecting both of them, see fig. 1, c. Therefore they share a side. A *chain of lozenges* is a collection $\{\mathcal{C}_i\}, i \in I$, where I is an interval (finite or not) in \mathbf{Z} ; so that if $i, i+1 \in I$, then \mathcal{C}_i and \mathcal{C}_{i+1} share a corner, see fig. 1, c. Consecutive lozenges may be adjacent or not. The chain is finite if I is finite.

Definition 2.4. Suppose A is a flow band in a leaf of $\widetilde{\Lambda}^s$. Suppose that for each orbit γ of $\widetilde{\Phi}$ in A there is a half leaf B_γ of $\widetilde{W}^u(\gamma)$ defined by γ so that: for any two orbits γ, β in A then a stable leaf intersects B_β if and only if it intersects B_γ . This defines a stable product region which is the union of the B_γ . Similarly define unstable product regions.

The main property of product regions is the following: for any $F \in \widetilde{\Lambda}^s, G \in \widetilde{\Lambda}^u$ so that (i) $F \cap A \neq \emptyset$ and (ii) $G \cap A \neq \emptyset$, then $F \cap G \neq \emptyset$. There are no singular orbits of $\widetilde{\Phi}$ in A .

We abuse convention and call a leaf L of $\widetilde{\Lambda}^s$ or $\widetilde{\Lambda}^u$ is called *periodic* if there is a non trivial covering translation g of \widetilde{M} with $g(L) = L$. This is equivalent to $\pi(L)$ containing a periodic orbit of Φ . In the same way an orbit γ of $\widetilde{\Phi}$ is *periodic* if $\pi(\gamma)$ is a periodic orbit of Φ .

We say that two orbits γ, α of $\widetilde{\Phi}$ (or the leaves $\widetilde{W}^s(\gamma), \widetilde{W}^s(\alpha)$) are connected by a chain of lozenges $\{\mathcal{C}_i\}, 1 \leq i \leq n$, if γ is a corner of \mathcal{C}_1 and α is a corner of \mathcal{C}_n .

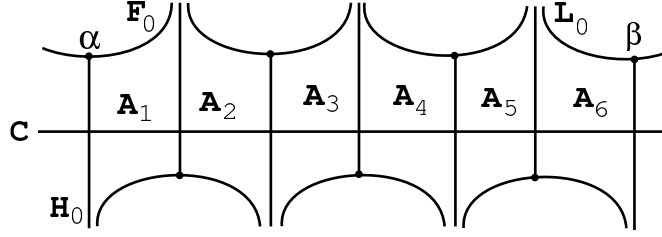

Figure 2: The correct picture between non separated leaves of $\tilde{\Lambda}^s$.

If C is a lozenge with corners β, γ and g is a non trivial covering translation leaving β, γ invariant (and so also the lozenge), then $\pi(\beta), \pi(\gamma)$ are closed orbits of $\tilde{\Phi}$ which are freely homotopic to the inverse of each other.

Theorem 2.5. [Fe6, Fe8] Let Φ be a pseudo-Anosov flow in M^3 closed and let $F_0 \neq F_1 \in \tilde{\Lambda}^s$. Suppose that there is a non trivial covering translation g with $g(F_i) = F_i, i = 0, 1$. Let $\alpha_i, i = 0, 1$ be the periodic orbits of $\tilde{\Phi}$ in F_i so that $g(\alpha_i) = \alpha_i$. Then α_0 and α_1 are connected by a finite chain of lozenges $\{C_i\}, 1 \leq i \leq n$ and g leaves invariant each lozenge C_i as well as their corners.

The main result concerning non Hausdorff behavior in the leaf spaces of $\tilde{\Lambda}^s, \tilde{\Lambda}^u$ is the following:

Theorem 2.6. [Fe6, Fe8] Let Φ be a pseudo-Anosov flow in M^3 . Suppose that $F \neq L$ are not separated in the leaf space of $\tilde{\Lambda}^s$. Then F is periodic and so is L . Let F_0, L_0 be the line leaves of F, L which are not separated from each other. Let V_0 be the sector of F bounded by F_0 and containing L . Let α be the periodic orbit in F_0 and H_0 be the component of $(\tilde{W}^u(\alpha) - \alpha)$ contained in V_0 . Let g be a non trivial covering translation with $g(F_0) = F_0, g(H_0) = H_0$ and g leaves invariant the components of $(F_0 - \alpha)$. Then $g(L_0) = L_0$. This produces closed orbits of Φ which are freely homotopic in M . Theorem 2.5 then implies that F_0 and L_0 are connected by a finite chain of lozenges $\{A_i\}, 1 \leq i \leq n$, consecutive lozenges are adjacent. They all intersect a common stable leaf C . There is an even number of lozenges in the chain, see fig. 2. In addition let $\mathcal{B}_{F,L}$ be the set of leaves non separated from F and L . Put an order in $\mathcal{B}_{F,L}$ as follows: Put an orientation in the set of orbits of C contained in the union of the lozenges and their sides. If $R_1, R_2 \in \mathcal{B}_{F,L}$ let α_1, α_2 be the respective periodic orbits in R_1, R_2 . Then $\tilde{W}^u(\alpha_i) \cap C \neq \emptyset$ and let $a_i = \tilde{W}^u(\alpha_i) \cap C$. We define $R_1 < R_2$ in $\mathcal{B}_{F,L}$ if a_1 precedes a_2 in the orientation of the set of orbits of C . Then $\mathcal{B}_{F,L}$ is either order isomorphic to $\{1, \dots, n\}$ for some $n \in \mathbf{N}$; or $\mathcal{B}_{F,L}$ is order isomorphic to the integers \mathbf{Z} . In addition if there are $Z, S \in \tilde{\Lambda}^s$ so that $\mathcal{B}_{Z,S}$ is infinite, then there is an incompressible torus in M transverse to Φ . In particular M cannot be atoroidal. Also if there are F, L as above, then there are closed orbits α, β of Φ which are freely homotopic to the inverse of each other. Finally up to covering translations, there are only finitely many non Hausdorff points in the leaf space of $\tilde{\Lambda}^s$.

Notice that $\mathcal{B}_{F,L}$ is a discrete set in this order. For detailed explanations and proofs, see [Fe6, Fe8].

Theorem 2.7. ([Fe8]) Let Φ be a pseudo-Anosov flow. Suppose that there is a stable or unstable product region. Then Φ is topologically conjugate to a suspension Anosov flow. In particular Φ is non singular.

Definition 2.8. (nsa and simple pseudo-Anosov flows) A pseudo-Anosov flow Φ in a 3-manifold is nsa if it is not topologically conjugate to a suspension Anosov flow. If Φ is nsa and there are no perfect fits between leaves of $\tilde{\Lambda}^s$ and $\tilde{\Lambda}^u$ then Φ is called simple.

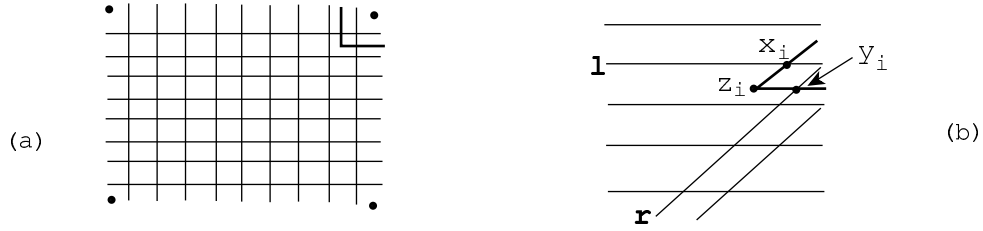

Figure 3: *Ideal points for product \mathbf{R} -covered Anosov flow, the dots represent the 4 special points, b. The picture in skewed case.*

3 Ideal boundaries of pseudo-Anosov flows

Let Φ be a pseudo-Anosov flow. The orbit space \mathcal{O} of $\tilde{\Phi}$ (the lifted flow to \tilde{M}) is homeomorphic to \mathbf{R}^2 [Fe-Mo]. We want to show there is a natural compactification of \mathcal{O} with an ideal circle $\partial\mathcal{O}$ called the ideal boundary of the pseudo-Anosov flow. We will also show that $\mathcal{D} = \mathcal{O} \cup \partial\mathcal{O}$ is homeomorphic to a closed disk. In addition covering translations of \tilde{M} , acting in \mathcal{O} extend to an action in $\mathcal{O} \cup \partial\mathcal{O}$ by homeomorphisms, which are group equivariant. This holds for general pseudo-Anosov flows in 3-manifolds – no metric (or atoroidal) assumptions on M or on the flow Φ . In addition there are no assumptions about perfect fits for Φ or topologically conjugate to a suspension Anosov flow.

Before we give the formal definition of the ideal points of \mathcal{O} we will give an idea through examples of what they should be. For every ray l of a leaf of \mathcal{O}^s or \mathcal{O}^u let l_∞ denote its “intuitive” ideal point. This will be a point in $\partial\mathcal{O}$. Given g in $\pi_1(M)$ it acts in \tilde{M} and sends flow lines of $\tilde{\Phi}$ to flow lines and hence acts in \mathcal{O} . It also preserves the foliations $\tilde{\Lambda}^s, \tilde{\Lambda}^u, \mathcal{O}^s, \mathcal{O}^u$.

1) Ideal boundary for \mathbf{R} -covered Anosov flows. The product case.

Recall the picture of product Anosov flow [Fe3, Ba]: every leaf of \mathcal{O}^s intersects every leaf of \mathcal{O}^u and vice versa. It follows that Φ is topologically conjugate to a suspension [Ba, Fe12]. Every ideal point of a ray in \mathcal{O}^s or \mathcal{O}^u should be a point of $\partial\mathcal{O}$ and they are all distinct. Furthermore there are 4 additional ideal points corresponding to escaping quadrants in \mathcal{O} , see fig. 3, a. The quadrants are bounded by a ray in \mathcal{O}^u and a ray in \mathcal{O}^s which intersect only in their common starting point (or finite endpoints). In this case it is straightforward to put a topology in \mathcal{D} so that it is a closed disk and covering transformations act in the extended object. If Λ^s, Λ^u are both transversely orientable, then: any covering translation g fixes the 4 distinguished points. It is associated to a periodic orbit if and only if fixes 4 additional ideal points: if x in \mathcal{O} with $g(x) = x$, then g fixes the ideal points of rays of $\mathcal{O}^s(x), \mathcal{O}^u(x)$. When Λ^s, Λ^u are not transversely orientable, there are other restricted possibilities.

Since we want to define a topology in \mathcal{D} using only the structure of $\tilde{\Lambda}^s, \tilde{\Lambda}^u$ in \tilde{M} , then a neighborhood basis of the ideal points has to be determined by sets in \mathcal{O} . A distinguished ideal point p has a neighborhood basis determined by (say nested) pairs of rays in $\mathcal{O}^s, \mathcal{O}^u$ intersecting at their common finite endpoint and so that the corresponding quadrants “shrink” to p . For an ordinary ideal point p , say a stable ideal point of a ray in $\mathcal{O}^s(x)$, we can use shrinking strips: the strips are bounded by 2 rays in \mathcal{O}^s and a segment in \mathcal{O}^u connecting the endpoints of the rays. The unstable segment intersects the original stable ray of $\mathcal{O}^s(x)$ and the intersections escape in that ray and also shrink in the transversal direction. Already in this case this leads to an important concept:

Definition 3.1. *A chain in \mathcal{O} is either a leaf of \mathcal{O}^s or \mathcal{O}^u or a finite collection l_1, \dots, l_n of arcs and two rays of \mathcal{O}^s or \mathcal{O}^u so that l_1 and l_n are rays in \mathcal{O}^s or \mathcal{O}^u , the other l_i are finite arcs, for $i \neq j$, l_i intersects l_j if and only if $|i - j| = 1$ and only in their finite endpoint and l_i are alternatively in \mathcal{O}^s and \mathcal{O}^u . The number n is the length of the chain.*

In the product \mathbf{R} -covered case, the exceptional ideal points need neighborhoods basis formed by chains of length 2 and all the others need chains of length 3. Notice that the definition of chains implies that it cannot close back up and bound a compact region in \mathcal{O} . This is because a stable leaf can intersect an unstable leaf in at most one point.

2) \mathbf{R} -covered Anosov flows – skewed case.

Topologically \mathcal{O} is homeomorphic to $(0,1) \times \mathbf{R}$, a subset of the plane, so that stable leaves are horizontal segments and unstable leaves are segments making a constant angle $\neq \pi/2$ with the horizontal, see fig. 3, b. A leaf of \mathcal{O}^s does not intersect every leaf of \mathcal{O}^u and vice versa [Fe3, Ba]. Here again the ideal points of rays define ideal points in \mathcal{O} . However as is intuitive from the picture, rays of $\mathcal{O}^s, \mathcal{O}^u$ which correspond to leaves of $\tilde{\Lambda}^s$ and $\tilde{\Lambda}^u$ which form a perfect fit should define the same ideal point of \mathcal{O} . In addition to these ideal points of rays in \mathcal{O}^s or \mathcal{O}^u , there should be 2 distinguished ideal points – one from the “positive” direction and one from the “negative” direction. Again it is very easy to put a topology in $\mathcal{D} = \mathcal{O} \cup \partial\mathcal{O}$ making it homeomorphic to a closed disk. In addition covering translations act as homeomorphisms of this disk – a transformation without fixed points in \mathcal{O} fixes only the 2 distinguished ideal points in $\partial\mathcal{O}$, one attracting and another repelling. If a transformation has a fixed point in \mathcal{O} , then it leaves invariant a leaf of \mathcal{O}^s or \mathcal{O}^u . If this corresponds to an orientation reversing element then there are only 4 fixed points in $\partial\mathcal{O}$. Otherwise there are infinitely many fixed points, see [Fe3, Ba].

A neighborhood basis of the distinguished ideal points can be obtained from leaves of \mathcal{O}^s or \mathcal{O}^u which escape in that direction (positive or negative). For non distinguished ideal points we get sequences of chains of length 2 escaping every compact set and “converging” to this ideal point, see fig. 3, b. More precisely if rays l, r of $\mathcal{O}^s, \mathcal{O}^u$ respectively form a perfect fit defining the ideal point p , then choose x_i in l converging to p , y_i in r converging to p and the chain of length two containing rays in the stable leaf through y_i and the unstable leaf through x_i (intersecting in z_i , see fig. 3, b).

3) Suspension pseudo-Anosov flows – singular case.

The fiber is a hyperbolic surface. The orbit space \mathcal{O} is identified with the universal cover of the fiber which is metrically the hyperbolic plane \mathbf{H}^2 . There is a natural ideal boundary S_∞^1 – the circle at infinity of \mathbf{H}^2 . Intuitively $\partial\mathcal{O}$ and S_∞^1 should be the same. But the construction of S_∞^1 uses the metric structure on the surface – in general there is no metric structure in \mathcal{O} , so again we want to define $\partial\mathcal{O}$ using only the structure of $\mathcal{O}^s, \mathcal{O}^u$. From a geometric point of view, there are some points of S_∞^1 which are ideal points of rays of leaves of \mathcal{O}^s or \mathcal{O}^u . But there are many other points in S_∞^1 . The foliations $\mathcal{O}^s, \mathcal{O}^u$ can be split into geodesic laminations (of \mathbf{H}^2) which have only complementary regions which are finite sided ideal polygons. This implies that given p in S_∞^1 there always is a sequence of leaves l_i (in \mathcal{O}^s or \mathcal{O}^u) which is nested, escapes to infinity and “shrinks” to the ideal point p . So we can obtain all ideal points using only the foliations $\mathcal{O}^s, \mathcal{O}^u$ and hence $\partial\mathcal{O} = S_\infty^1$ in this case. Also $\mathcal{O}^s, \mathcal{O}^u$ define a topology in $\mathcal{O} \cup \partial\mathcal{O}$ compatible with the metric topology.

Before defining ideal points of \mathcal{O} , we analyse the following situation: let l be a ray (say) in \mathcal{O}^s and assumed without singularity. Then take x_i in l , nested and escaping to the ideal point p in l . This p should be a point in $\partial\mathcal{O}$. For simplicity assume that the leaves g_i of \mathcal{O}^u through x_i are non singular. We would like to say that these leaves g_i “define” the ideal point p . If they escape in \mathcal{O} , then that will be the case. However it is not always true that they escape in \mathcal{O} . If they do not escape in \mathcal{O} , then they limit on a collection of unstable leaves $\{h_j \mid j \in J\}$ – maybe infinitely many. But there is one of them, call it h which makes a perfect fit with l on that side of l . The perfect fit is the obstruction to leaves g_i escaping in \mathcal{O} . Consider now e_i stable (non singular) leaves intersecting h and escaping in the direction of the perfect fit with l . Since l and e form a perfect fit, then for big enough i , the e_i and g_i intersect and form a chain of length 2. If these rays of e_i escape in \mathcal{O} ,

this should define the ideal point p , otherwise iterate this process. If this stops after a while then take chains of a fixed length. Otherwise as the chains escape in \mathcal{O} , then we use chains of bigger and bigger lengths, in order to cross over more and more of the collection of perfect fits emanating from l . Such a sequence of chains will be called a *standard sequence* for the ray l of \mathcal{O}^s or \mathcal{O}^u .

These sequences are enough to define “neighborhood basis” of ideal points of \mathcal{O} . We are now ready to define ideal points of \mathcal{O} . A *quarter* at z is a component of $\mathcal{O} - (\mathcal{O}^s(z) \cup \mathcal{O}^u(z))$. If z is non singular there are exactly 4 quarters, if z is a p -prong point there are $2p$ quarters.

Definition 3.2. (*convex chains*) A chain \mathcal{C} in \mathcal{O} is convex if there is a complementary region V of \mathcal{C} in \mathcal{O} so that at any given corner z of \mathcal{C} the local region of V near z is not a quarter at z . Let $U = \mathcal{O} - (\mathcal{C} \cup V)$. This region U is the convex region of \mathcal{O} associated to the convex chain \mathcal{C} . The definition implies that if U contains 2 endpoints of a segment in a leaf of \mathcal{O}^s or \mathcal{O}^u , then it contains the entire segment. This is why \mathcal{C} is called convex.

Definition 3.3. (*equivalent rays*) Two rays l, r of $\mathcal{O}^s, \mathcal{O}^u$ are equivalent if there is a finite collection of distinct rays $l_i, 1 \leq i \leq n$, alternatively in $\mathcal{O}^s, \mathcal{O}^u$ so that $l = l_0, r = l_n$ and l_i forms a perfect fit with l_{i+1} for $1 \leq i < n$. If $n \geq 3$ then for all $1 \leq i \leq n - 2$ the leaves l_i and l_{i+2} are non separated.

Definition 3.4. (*admissible sequences of chains*) An admissible sequence of chains in \mathcal{O} is a sequence of convex chains \mathcal{C}_i so that the associated convex regions U_i are nested and escape to infinity in \mathcal{O} . In addition we require that for any i , the 2 rays at the ends of \mathcal{C}_i are not equivalent.

Intuitively an ideal point of \mathcal{O} is determined by an admissible sequence of chains. Clearly this does not work for suspension Anosov flows because a sequence of escaping leaves of $\tilde{\Lambda}^s$ approaches infinitely many different ideal points. Hence such flows are special and we assume nsa for most of the results in this section.

Two different admissible sequences may define the same ideal point, so we first need to determine when 2 such sequences are equivalent, that is, they define the same ideal point and then we need to define a topology in $\mathcal{O} \cup \partial\mathcal{O}$. At first one might think that any 2 sequences associated to (what we intuitively think is) the same ideal point of \mathcal{O} would have to be eventually nested with each other. This would make it simple and nice. However it is easy to see that such is not the case. For example there are sequences of chains so that one end ray is always in the same leaf and they just shrink on the other side. One could then construct chains on the other side as well, making two disjoint sequences which cannot be nested. We need a couple more ideas.

Given an admissible sequence $(v_i), i \in \mathbf{N}$, since it escapes compact sets, there is a unique component of $\mathcal{O} - v_i$ denoted by \tilde{v}_i which does not contain a fixed basepoint in \mathcal{O} (if necessary eliminate a few elements of the sequence or move the basepoint). For notational simplicity many times we denote this simply by the sequence (v_i) or even v_i .

Definition 3.5. Given two admissible sequences of chains $C = (c_i), D = (d_i)$, we say that C is smaller than D , denoted by $C < D$, if: for any i there is $k_i > i$ so that $\tilde{c}_{k_i} \subset d_i$. Two admissible sequences of chains $C = (c_i), D = (d_i)$ are equivalent and denoted by $C \cong D$ if there is a third admissible sequence $E = (e_i)$ so that $C < E$ and $D < E$.

The ideal points of \mathcal{O} will be the equivalence classes of admissible sequences of chains. We have to prove that \cong is an equivalence class and several other properties. We should stress that the requirement that the chains are convex is fundamental for the whole discussion. It is easy to see in the skewed \mathbf{R} -covered Anosov case, then given any two distinct ideal points p, q on the “same side” of the distinguished ideal points the following happens: Let l, r be stable rays defining p, q respectively. Then there is a sequence of chains that escapes and so that each \tilde{c}_i contains subrays of both l and

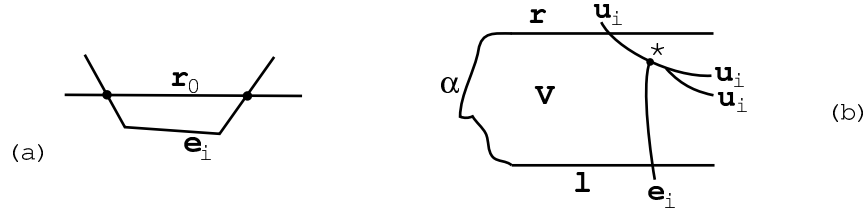

Figure 4: *a. Convexity implies connected intersection of r and B_i . b. All rays of u_i stay in V forever. There is a non convex switch at $*$.*

r . The chains can be chosen to satisfy all the properties, except that they are convex. On the other hand convexity does imply important properties as shown in the next lemma. This key lemma will be used throughout this section. After this lemma we show that \cong is an equivalence relation.

Lemma 3.6. (*fundamental lemma*) *Let Φ not topologically conjugate to a suspension Anosov flow. Let l, r be rays of \mathcal{O}^s or \mathcal{O}^u , which are not equivalent. Then there is no pair of admissible sequence of chains $E = (e_i)$, $F = (f_i)$ so that: $\tilde{e}_i \cap f_i \neq \emptyset$ (for all i) and $\tilde{e}_i \cap r \neq \emptyset$, $\tilde{f}_i \cap l \neq \emptyset$, for all i .*

Proof. We assume that both l and r are rays of \mathcal{O}^s , other cases are treated similarly. By taking subrays if necessary we may assume that l, r are disjoint, have no singularities and miss a big compact set around a base point in \mathcal{O} . Join the initial points of l, r by an arc α' missing a big compact set to produce a properly embedded biinfinite curve $\alpha = l \cup \alpha' \cup r$, see fig. 4, b. Let V be the component of $\mathcal{O} - \alpha$ which misses the basepoint.

We first show that there is no admissible sequence of chains $E = (e_i)$ such that \tilde{e}_i always intersects l and r . This implies that the phenomenon described above (in the skewed Anosov flow case) for non convex chains cannot happen for convex chains.

Suppose this is not true. Let $B_i = \tilde{e}_i \cup e_i$. Notice first that $B_i \cap r$ is connected. Otherwise there is a compact subarc r_0 of r with ∂r_0 in e_i and the rest of r_0 contained in $\mathcal{O} - B_i$, see fig. 4, a. Starting from an endpoint of r_0 and moving along e_i towards the other endpoint, the only way to intersect r again is if there is a non convex switch in e_i , contradiction. This shows that $B_i \cap r$ is connected. This also shows that \tilde{e}_i is convex as explained in definition 3.2.

Notice that $B_j \cap r$ forms a nested family of sets in r . Since B_j escapes compact sets as $j \rightarrow \infty$ and $B_j \cap r$ is connected it follows that $B_j \cap r$ is a subray of r for any j . If $e_i \cap r$ contains a non trivial segment, then by convexity again it follows that $\tilde{e}_i \cap r = \emptyset$ contradiction. It follows that e_i intersects r in a single point. Let $u'_i = \mathcal{O}^u(e_i \cap r)$, the unstable leaf through the intersection. Up to subsequence we may assume no two u'_i are the same.

Since r has no singularities there are two components of $u'_i - (u'_i \cap r)$. There is only one of them called u_i which locally enters V , see fig. 4, b. There are two possibilities: the first is that some rays of u_i stay in V for all time. By taking another bigger i we may assume that all rays of u_i stay in V forever. In that case, in order for e_i to reach l there must be a non convex switch in e_i , impossible see fig. 4, b. (the non convex switch is at $*$).

The other option is that all rays of u_i exit V . One possibility here is that all u_i intersect l . In that case let z_i be the part of u_i between l and r . If the z_i escapes compact sets, then the region between l and r is an unstable product region as in definition 2.4. Theorem 2.7 then implies that Φ is topologically conjugate to a product \mathbf{R} -covered Anosov flow. This is disallowed by hypothesis (the lemma fails for product \mathbf{R} -covered Anosov flows). Hence the u_i converges to a collection of leaves, analysed below. Another possibility is that the u_i does not intersect l – hence they intersect α' . Since l obstructs the u_i to escape compact sets, it also follows that u_i converges to a collection of leaves. Let u be one of the limit leaves.

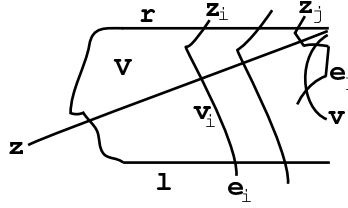

Figure 5: *Producing a perfect fits.*

Consider the set of stable leaves non separated from u and in that side of r . By theorem 2.6 there are only finitely many stable leaves between any given u and r , so we may assume that u is the closest one. If u does not make a perfect fit with r , then when considering the stable leaves intersected by u , they do not converge to r , but rather to some other stable leaf r' . The region between r, r' would then be a product region (since there are no leaves non separated from u in this region). As seen above, this would imply Φ is topologically conjugate to a suspension Anosov flow, contradiction. It follows that r, u form a perfect fit and so the rays r, u are equivalent.

Notice now u is a ray of \mathcal{O}^u and we restart the proof. There is a convex polygonal curve from r to u and so now we need to go from u to l . Notice there is a ray of u in V . Suppose first that the other ray of u is also contained in V . This occurs for instance when all u_i intersect l . The chains $\{e_i\}$ escape compact sets in \mathcal{O} and eventually have to cross over to the other side of u . Since they have to intersect l later on, they will have to cross back to the l side of u again. This would force a non convex switch, contradiction.

It follows that there is a ray of u exiting V . The same argument as above produces v_1 a ray of \mathcal{O}^s making a perfect fit with u and consequently non separated from r , see fig. 5. Now iterate to obtain v_2, \dots etc.. They are obviously nested and the sequence cannot limit on any leaf of $\mathcal{O}^s, \mathcal{O}^u$, since v_i, v_{i+2} are non separated from each other in the corresponding leaf space. Since they escape \mathcal{O} , eventually all rays of u_i are in V and there is no convex chain to l , forcing a non convex switch. This proves that no escaping sequence of convex chains can always intersect both l and r .

We now prove the more general result. For the general result assume r, l are as above and $E = (e_i), F = (f_i)$ are admissible sequences with $\tilde{e}_i \cap \tilde{f}_i \neq \emptyset, r \cap \tilde{e}_i \neq \emptyset, l \cap \tilde{f}_i \neq \emptyset$. As before consider the region V bounded by l, r and an arc connecting them. We go from r to l along e_i and then f_i . The switches are all convex, except for a single one when it moves from e_i to f_i . Once a non convex switch is used, then all subsequent switches have to be convex.

Consider the unstable leaf z_i through $e_i \cap r$. If some z_i has a ray which is entirely in V , then as seen above for $j > i$ all rays of z_j which enter V must be entirely in V . This implies that there has to be a non convex switch from e_i to f_i right in z_i . On the other hand notice that if two rays of \mathcal{O}^u are equivalent, then they are connected by a chain of consecutively non separated leaves – skip the unstable leaves in the chain between the rays. Therefore the rays never intersect the same unstable leaf. Since z_i, z_j intersect r it follows that they are not equivalent. For $k > j$, then one has to spend a non convex switch at z_k and then everything else must be convex. In particular there must be one escaping sequence of convex chains intersecting z_k and z_j . Since z_k, z_j are not equivalent, this is ruled out by the first part of the proof.

We conclude that all rays of z_i which enter V actually exit V . We now mimic the proof of the first part. The z_i converge to a leaf z of \mathcal{O}^u so that z forms a perfect fit with r . We can have a convex chain from r to z and we restart the proof with z, l .

By the above arguments we can assume that we have not spent the non convex switch to go from r to z and consequently e_i intersects z . Let v_i be the unstable leaf through $e_i \cap z$, see fig. 5.

Then z_i, v_i form a chain of length 2 connecting r, z . Suppose first that every v_i (for i sufficiently big) intersects l see fig. 5. If the region of v_i between z and l escapes in \mathcal{O} then we have a product region of \mathcal{O}^s contradiction to Φ not being a product Anosov flow, by theorem 2.7.

Hence the v_i limit to a leaf v which we can choose to make a perfect fit with z , see fig. 5. As E, F are sequences which escape in \mathcal{O} , then some e_j crosses to the other side of v . Parts of e_j and f_j form a chain that has to cross v back again, since it has to reach l . But that requires at least 2 non convex switches see fig. 5 or fig. 4, a. But only one non convex switch is allowed by hypothesis.

We conclude that there is a v_i not intersecting l . If there is some v_i with a ray entirely in V then as seen above we again produce a contradiction. The remaining option is that every ray of every v_i which enters V has to escape V . As before this produces a leaf v which makes a perfect fit with z . Iterate this process, producing leaves equivalent to v . As seen in the first part of the proof, these leaves have to escape \mathcal{O} , producing a contradiction. This finishes the proof of lemma 3.6. \square

Lemma 3.7. *Let Φ be nsa. Then \cong is an equivalence relation for admissible sequences of chains.*

Proof. Clearly \cong is reflexive and symmetric. Suppose now that $A = (a_i), B = (b_i), C = (c_i)$ are admissible sequences of chains and $A \cong B, B \cong C$. Then there is $D = (d_i)$ with $A < D, B < D$ and $E = (e_i)$ with $B < E, C < E$. If for some i, j the \tilde{d}_i and \tilde{e}_j do not intersect this contradicts $B < D, B < E$.

Claim – Fix j . Then either there is i with $\tilde{a}_i \subset \tilde{e}_j$ or there is i with $\tilde{c}_i \subset \tilde{d}_j$.

Suppose not. Then for each i , then $\tilde{a}_i \not\subset \tilde{e}_j$ and $\tilde{c}_i \not\subset \tilde{d}_j$. Clearly this implies that none of \tilde{d}_j, \tilde{e}_j is contained in the other.

Let y_1, y_2 be the rays of d_j and z_1, z_2 be the rays of e_j . There is i with

$$\tilde{b}_i \subset \tilde{e}_j \cap \tilde{d}_j = Z$$

By convexity Z is connected. Also Z is non compact and its boundary ∂Z has two rays which are contained in $y_1 \cup y_2 \cup z_1 \cup z_2$. If there are subrays of both rays in this boundary ∂Z which are contained in $y_1 \cup y_2$, then it follows that $\tilde{d}_j \cup d_j - (\tilde{e}_j \cup e_j)$ is contained in a compact set in \mathcal{O} , see fig. 6, a. Since the sequence $(\tilde{d}_i), i \in \mathbf{N}$ of open sets in \mathcal{O} escapes compact sets in \mathcal{O} , then there would be k with $\tilde{d}_k \subset \tilde{e}_j$. But then there is i with $\tilde{a}_i \subset \tilde{d}_k \subset \tilde{e}_j$ and this would yield the claim.

It follows that one and only one boundary ray of $\tilde{e}_j \cap \tilde{d}_j$ must be contained in $y_1 \cup y_2$ and one and only one boundary ray is in $z_1 \cup z_2$. This last fact also implies that if a boundary ray is contained in $y_1 \cup y_2$ then it cannot have a subray in $z_1 \cup z_2$. Let l_j be the boundary ray contained in $z_1 \cup z_2$. Then this ray is in $\tilde{d}_j \cup d_j$ and since it cannot have a subray contained in d_j it follows that it has a subray contained in \tilde{d}_j . It also follows that the other ray of e_j has to be eventually disjoint from $\tilde{d}_j \cup d_j$. Similarly there is a ray r_j of d_j contained in \tilde{e}_j , see fig. 6, b. Now consider $i \geq j$. Then

$$\tilde{d}_i \cap \tilde{e}_j \neq \emptyset \quad \text{and} \quad \tilde{d}_i \not\subset \tilde{e}_j$$

so the same analysis as above produces a ray of e_j contained in \tilde{d}_i . It can only be l_j since the other ray of e_j is disjoint from $d_j \cup \tilde{d}_j$, so certainly disjoint from $d_i \cup \tilde{d}_i$. It now follows that for any $i \geq j$ there is a subray of the fixed ray l_j which is contained in \tilde{d}_i . Similarly for any $i \geq j$ there is a subray of r_j contained in \tilde{e}_i .

The set $\tilde{d}_j \cap \tilde{e}_j$ has boundary which contains subrays of r_j, l_j . If r_j, l_j are equivalent rays then as there is i with $b_i \subset \tilde{e}_j \cap \tilde{d}_j$, the two rays of b_i would be equivalent, contradiction. Hence r_j, l_j are not equivalent. But for any $i \geq j$, then $\tilde{d}_i \cup \tilde{e}_i$ is a union of two convex regions containing subrays of l_j and r_j (j is fixed!). This is disallowed by the fundamental lemma 3.6. This proves the claim.

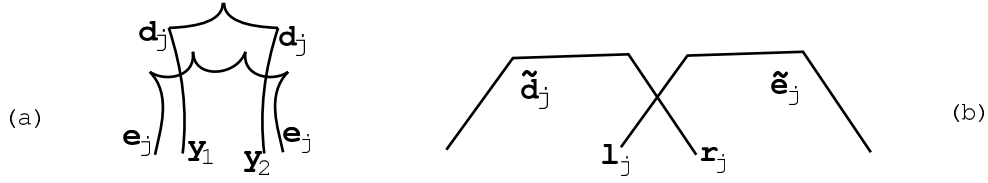

Figure 6: a. The intersection of convex neighborhoods, b. Intersecting master sequences.

Suppose then there are infinitely many j 's so that for each one of them, there is $i > j$ with $\tilde{a}_i \subset \tilde{e}_j$. Then for any k there is one such j with $j > k$ and so there is $i > j$ with $\tilde{a}_i \subset \tilde{e}_j \subset \tilde{e}_k$. This means that $A < E$ and so $A \cong C$. The other option is there are infinitely many j and for each such j there is $i \geq j$ and $\tilde{c}_i \subset \tilde{d}_j$. This now implies that $C < D$ and again $C \cong A$. This finishes the proof that \cong is an equivalence relation. \square

Given these results we now define the ideal points of \mathcal{O} . For the rest of the section we assume that Φ is nsa.

Definition 3.8. A point in $\partial\mathcal{O}$ or an ideal point of \mathcal{O} is an equivalence class of admissible sequences of chains. Let $\mathcal{D} = \mathcal{O} \cup \partial\mathcal{O}$.

Given R , an admissible sequence of chains, let \bar{R} be its equivalence class under \cong .

Lemma 3.9. For any equivalence class \bar{R} there are master sequences: An admissible sequence C defining \bar{R} is a master sequence for \bar{R} , if for any $B \cong R$, then $B < C$.

Proof. Intuitively the elements of this sequence approach the ideal points from “both sides”.

Case 1 – Suppose that for any $A = (a_i)$, $B = (b_i)$ in \bar{R} and for any i, j then $\tilde{a}_i \cap \tilde{b}_j \neq \emptyset$.

We claim that in this case any $A \cong R$ will serve as a master sequence. Let $A \cong R$ and let $B \cong R$. We want to show that $B < A$. Otherwise there is a fixed i so that for any j , $\tilde{b}_j \not\subset \tilde{a}_i$. In case 1, $\tilde{b}_j \cap \tilde{a}_i$ is not empty for any j . Since \tilde{b}_j escapes in \mathcal{O} , so does $\tilde{b}_j \cap \tilde{a}_i$. The arguments of the previous lemma show that \tilde{a}_i cannot contain subrays of both rays in b_j and in fact for j big enough, then \tilde{b}_j contains a subray of a single ray of a_i and no singular point. This implies that a_i cuts \tilde{b}_j into 2 convex regions: one contained in \tilde{a}_i and the other (call it \tilde{b}'_j) disjoint from \tilde{a}_i . It is essential here that the intersection of \tilde{b}_j and \tilde{a}_i does not contain a switch of a_i , otherwise one of the cut up regions in \tilde{a}_i may well have a non convex corner. Let b'_j be the boundary of \tilde{b}'_j defining a sequence of chains $B' = (b'_j)$. Clearly the sequence $\{b'_j\}$ is nested and escapes \mathcal{O} when $j \rightarrow \infty$. Because of the conditions above, they are also convex and therefore B' is an admissible sequence of chains. Clearly $B' < B$, hence B and B' are equivalent and so B' is contained in \bar{R} . But $\tilde{b}'_j \cap \tilde{a}_i$ (i fixed) is empty for j big enough. This violates the hypothesis in case 1. This finishes the proof in this case.

Case 2 – There are A, B in \bar{R} and i so that \tilde{a}_i, \tilde{b}_i are disjoint.

Let C be an admissible sequence with $A < C$, $B < C$. Notice that C is in \bar{R} as well – since $A < C$ implies that $A \cong C$. We claim that C is a master sequence for \bar{R} . Let $D \cong A$. Suppose that $D \not\prec C$. Hence there is i so that for no j we have $\tilde{d}_j \subset \tilde{c}_i$. As in case 1, we can chop \tilde{d}_j and produce $E = (e_j)$ so that \tilde{e}_j is disjoint from \tilde{c}_i . Up to deleting a few initial terms in the sequences we have $A \cong B \cong E$ and $\tilde{a}_1, \tilde{b}_1, \tilde{e}_1$ disjoint. Suppose without loss of generality that \tilde{b}_1 is between \tilde{a}_1 and \tilde{e}_1 – that is \tilde{e}_1 is on the \tilde{b}_1 side of \tilde{a}_1 . Notice there is $F = (f_i)$ with $A < F$, $E < F$. Since $\tilde{a}_i, \tilde{b}_i, \tilde{e}_i$ are all disjoint and \tilde{b}_1 is between \tilde{a}_1 and \tilde{c}_1 then: f_i contains subrays of the rays of b_1 . But f_i escapes compact sets in \mathcal{O} . The fundamental lemma 3.6 implies this is impossible. We conclude that C is a master sequence for the equivalence class. This finishes the proof of lemma 3.9. \square

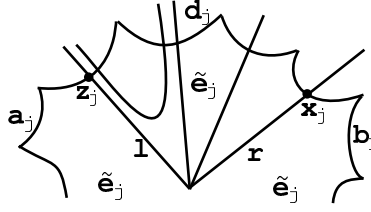
 Figure 7: *Interpolating chains that intersect to produce a new convex chain.*

By definition for any 2 master sequences A, B in the class \overline{R} , then both $A < B$ and $B < A$.

Lemma 3.10. *Let p, q in $\partial\mathcal{O}$. Then p, q are distinct if and only if there are master sequences $A = (a_i), B = (b_i)$ associated to p, q respectively with $\tilde{a}_i \cap \tilde{b}_j = \emptyset$ for some i, j . Equivalently for some other master sequences this is true for all i, j .*

Proof. (\Leftarrow) Suppose that $p = q$. Let A, B be any master sequences associated to $p = q$. Then since A, B are master sequences associated to the same equivalence class then $A < B$ and $B < A$. Therefore we can never have $\tilde{a}_i \cap \tilde{b}_j = \emptyset$. This is the easy implication.

(\Rightarrow) Suppose that for any master sequences $A = (a_i)$ and $B = (b_i)$ associated to p, q respectively and any i, j then $\tilde{a}_i \cap \tilde{b}_j \neq \emptyset$. Let A, B be such a pair and define $\tilde{c}_i = \tilde{a}_i \cap \tilde{b}_i$ and let $c_i = \partial\tilde{c}_i$. Let $C = (c_i)$. First of all $\tilde{b}_i \cap \tilde{a}_j$ can never be compact or else for some $i' > i$ then $\tilde{a}_j \cap \tilde{b}_{i'} = \emptyset$. Also the rays in c_i are subrays of rays of a_i or b_i .

Suppose first that there is i with the rays of c_i equivalent. The rays are u, v and there is a collection $\mathcal{Y} = \{u_0 = u, u_1, \dots, u_n = v\}$ so that u_k, u_{k+1} make a perfect fit for every k . Since the sequence (\tilde{c}_j) is nested with j , the rays of c_j for $j > i$ have to be in the collection \mathcal{Y} . Up to subsequence we can assume they are all subrays of fixed rays r, l . Notice that $r \neq l$, or else $\tilde{b}_j \cap \tilde{a}_j = \emptyset$ for some j . Since r, l are equivalent they cannot both be in a_j (or in b_j either). Hence up to renaming objects, a_j has a subray in r and b_j has a subray in l , for all $j > i$, see fig. 7.

Let $z_j = a_j \cap l$, $x_j = r \cap b_j$. Then z_j escapes in l and x_j escapes in r . Therefore we can connect z_j, x_j by a finite convex chain d_j which extends a_j, b_j and their union is a convex chain e_j . This chain d_j interpolates between a_j, b_j , see fig. 7. Notice that a_j has a subray of r so it goes to r , but a_j may reach r in a point different than x_j . If we just connect this to x_j and then follow b_j this will produce a non convex switch in r . That is why we use the interpolating chain d_j . Then the chains e_j are convex and one can construct the interpolating chain d_j so that e_j escapes compact sets as $j \rightarrow \infty$. Then $E = (e_j)$ defines an admissible sequence of chains. It is easy to see that $A < E$ and $B < E$ so that $A \cong B$ and $p = q$.

The remaining situation is that the rays of c_i are not equivalent for any i . Then c_i is a convex chain, non empty and C is an admissible sequence. Also $C < A$, $C < B$, which implies that $A \cong C \cong B$ and $p = q$. This proves the lemma. \square

We now define the topology in $\mathcal{D} = \mathcal{O} \cup \partial\mathcal{O}$.

Definition 3.11. *(topology in $\mathcal{D} = \mathcal{O} \cup \partial\mathcal{O}$) Let \mathcal{T} be the collection of subsets U of $\mathcal{D} = \mathcal{O} \cup \partial\mathcal{O}$ satisfying the following two conditions:*

(a) *If x is in $U \cap \mathcal{O}$, then there is an open set O in \mathcal{O} with $x \in O \subset U$.*

(b) *If p is in $U \cap \partial\mathcal{O}$ and $A = (a_i)$ is any master sequence associated to p , then there is i_0 satisfying two conditions: (1) $\tilde{a}_{i_0} \subset U \cap \mathcal{O}$ and (2) For any z in $\partial\mathcal{O}$, if it admits a master sequence $B = (b_i)$ so that for some j_0 , one has $\tilde{b}_{j_0} \subset \tilde{a}_{i_0}$ then z is in U .*

First notice that if the second requirement works for a master sequence $A = (a_i)$ with index i_0 , then for any other master sequence $C = (c_k)$ defining p , we can choose k_0 with $\tilde{c}_{k_0} \subset \tilde{a}_{i_0}$. Then $\tilde{c}_{k_0} \subset U$. If q point of $\partial\mathcal{O}$ has a master sequence $B = (b_j)$ with

$$\tilde{b}_{j_0} \subset \tilde{c}_{k_0} \quad \text{then} \quad \tilde{b}_{j_0} \subset \tilde{a}_{i_0}$$

so q is in U . Therefore (b) works for C instead of A with k_0 instead of i_0 . So we only need to check the requirements for a single master sequence.

Lemma 3.12. *The collection of sets in \mathcal{T} forms a topology in $\mathcal{D} = \mathcal{O} \cup \partial\mathcal{O}$.*

Proof. Clearly \mathcal{D}, \emptyset are in \mathcal{T} . First consider unions. If $\{U_\alpha | \alpha \in \mathcal{A}\}$ is a collection of sets in \mathcal{T} , then let U be their union. If x is in U and x is in \mathcal{O} , there is open set O in \mathcal{O} with $x \in O \subset U_\alpha$ for some index α , hence satisfying condition (a). Let now p in $U \cap \partial\mathcal{O}$. There is $\beta \in \mathcal{A}$ with $p \in U_\beta$. Let $A = (a_i)$ be a master sequence associated to p . There is i_0 with

$$\tilde{a}_{i_0} \subset U_\beta \cap \mathcal{O} \subset U \cap \mathcal{O} \subset \mathcal{O}.$$

In addition if $q \in \partial\mathcal{O}$ and q has a master sequence $B = \{b_j\}$ and j_0 with $\tilde{b}_{j_0} \subset \tilde{a}_{i_0}$ then q is in $U_\beta \subset U$. Hence this i_0 works for U as well. This proves that U is in \mathcal{T} .

Now consider intersections. Let U_1, U_2 be in \mathcal{T} and $U = U_1 \cap U_2$. Clearly $U_1 \cap U_2 \cap \mathcal{O}$ is open in \mathcal{O} . Let $u \in U_1 \cap U_2 \cap \partial\mathcal{O}$. Given a master sequence $A = (a_i)$ associated to u there is i_1 with $\tilde{a}_{i_1} \subset U_1$ and if q has master sequence $B = (b_j)$ with $\tilde{b}_{j_0} \subset \tilde{a}_{i_1}$ then q is in U_1 . Similarly considering $u \in U_2$, there is index i_2 satisfying the conditions for U_2 . Let $i_0 = \max(i_1, i_2)$. Then \tilde{a}_{i_0} is contained in U_1 and U_2 (since \tilde{a}_i are nested). If now q is in $\partial\mathcal{O}$ has a master sequence $B = (b_j)$ with $\tilde{b}_{j_0} \subset \tilde{a}_{i_0}$ for some j_0 then q is in U_1 and is in U_2 by choice of i_1, i_2 . Therefore q is in U . Hence U is in \mathcal{T} .

We conclude that \mathcal{T} is a topology in $\mathcal{O} \cup \partial\mathcal{O}$. \square

Notice that $\pi_1(M)$ preserves $\mathcal{O}^s, \mathcal{O}^u$ and sends convex chains to convex chains, etc.. Hence $\pi_1(M)$ acts by homeomorphisms in \mathcal{D} .

Lemma 3.13. *Suppose $\pi_1(M)$ preserves orientation in \mathcal{O} . Then $\partial\mathcal{O}$ has a natural cyclic order.*

Proof. Let p, q, r in $\partial\mathcal{O}$ distinct points. By lemma 3.10, there are master sequences $A = (a_i), B = (b_i), C = (c_i)$ associated to p, q, r respectively with $\tilde{a}_1, \tilde{b}_1, \tilde{c}_1$ disjoint. From a basepoint x in \mathcal{O} we can draw embedded arcs α, β, γ from x to $\tilde{a}_1, \tilde{b}_1, \tilde{c}_1$ satisfying: the arcs are disjoint except for the endpoint x . This defines a cyclic order on p, q, r . This is independent of the choice of master sequences (since they are all equivalent) and also choice of arcs. It is also invariant under the action of $\pi_1(M)$ in \mathcal{O} , since $\pi_1(M)$ preserves orientation in \mathcal{O} . This defines a natural cyclic order in $\partial\mathcal{O}$. \square

In general let \mathcal{E} be the index 2 subgroup of $\pi_1(M)$ preserving orientation of \mathcal{O} . Then \mathcal{E} preserves a cyclic order in $\partial\mathcal{O}$ and the elements in $\pi_1(M) - \mathcal{E}$ reverse this cyclic order.

Definition 3.14. *For any convex chain c there is an associated open set U_c of \mathcal{D} : let \tilde{c} be the corresponding convex set of \mathcal{O} (if c has length 1 there are two possibilities). Let*

$$U_c = \tilde{c} \cup \{x \in \partial\mathcal{O} \mid \text{there is a master sequence } A = (a_i) \text{ with } \tilde{a}_1 \subset \tilde{c}\}$$

It is easy to verify that U_c is always an open set in \mathcal{D} . In particular it is an open neighborhood of any point in $U_c \cap \partial\mathcal{O}$. The rays of c are equivalent if and only if U_c is contained in \mathcal{O} . The notation U_c will be used frequently from now on.

Lemma 3.15. *\mathcal{D} is Hausdorff.*

Proof. Any two points in \mathcal{O} are separated. If p, q are distinct in $\partial\mathcal{O}$ choose disjoint master sequences $A = (a_i)$ and $B = (b_i)$. Let U_{a_1} be the open set of \mathcal{D} associated to a_1 and U_{b_1} associated to b_1 . By definition U_{a_1} is an open neighborhood of p and likewise U_{b_1} for q . They are disjoint open sets.

Finally if p is in \mathcal{O} and q is in $\partial\mathcal{O}$, choose U a neighborhood of q as above so that $U \cap \mathcal{O}$ does not have p in its closure - always possible because master sequences are escaping sets. Hence there are disjoint neighborhoods of p, q . This finishes the proof. \square

Our goal is to show that $\partial\mathcal{O}$ is homeomorphic to \mathbf{S}^1 and that \mathcal{D} is homeomorphic to a closed disk. We need a couple simple facts:

Lemma 3.16. *For any ray l of \mathcal{O}^s or \mathcal{O}^u , there is an associated point in $\partial\mathcal{O}$. Two rays generate the same point of \mathcal{O} if and only if the rays are equivalent (as rays!).*

Proof. Given a ray l consider a standard sequence associated to it. The description of standard sequences was done just before the definition of convex chains (definition 3.2). These sequences define an ideal point of \mathcal{O} . It is clearly associated to the ray since every element in the convex chain contains a subray of the original ray.

Two such points in $\partial\mathcal{O}$ are equivalent if there is an admissible sequence of chains so that every element in the sequence contains subrays of both l, r . By the fundamental lemma, this occurs if and only if the rays are equivalent. \square

The following result is very useful.

Lemma 3.17. *Suppose that $A = (a_i)$ is an admissible sequence of chains and that all a_i have a ray in a fixed leaf l of \mathcal{O}^s or \mathcal{O}^u . Then A is associated to the ideal point of l and A is not a master sequence for this point.*

Proof. Consider $B = (b_i)$, a standard sequence associated to l . Then for each i we claim that for big enough j , then $\tilde{a}_j \subset \tilde{b}_i$. Suppose not and fix such i . Notice l contains a subray of a_j . If \tilde{a}_j is not contained in \tilde{b}_i then the other ray u of b_i has a subray contained in \tilde{a}_j . The ray u is the ray of b_i in the \tilde{a}_j side. By construction of standard sequences, it follows that the rays u and l are not equivalent. Notice then that \tilde{a}_j always contains a subray of u (as j varies), \tilde{b}_k always contains a subray of l (as k varies) and $\tilde{a}_j \cap \tilde{b}_k$ is never empty. Since u, l are not equivalent, this is disallowed by the fundamental lemma. This is impossible.

We conclude that there is j with $\tilde{a}_j \subset \tilde{b}_i$ and so $A < B$. Therefore $A \cong B$ and A is associated to the ideal point of l . In addition A is not a master sequence because using $B = (b_i)$ we can cut \tilde{b}_i along l and produce another admissible sequence in the other side of l , which is equivalent to A and disjoint from A . Hence A cannot be a master sequence. \square

Lemma 3.18. *Let $A = (a_i)$ be an admissible sequence defining a point p in $\partial\mathcal{O}$. Then one of the following mutually exclusive possibilities occurs:*

(i) *There are infinitely many i and side rays l_i of a_i which are equivalent to each other. Then p is the ideal point of any of the l_i and A is not a master sequence for p .*

(ii) *There are only finitely many sides which are equivalent to any given side and A is a master sequence for p .*

Proof. Suppose first that there are infinitely many l_i contained in a ray l . As seen in the previous lemma, this implies that p is associated to the ideal point of l and A is not a master sequence.

Next suppose there are infinitely many l_i which are distinct but equivalent. Up to discarding a few initial terms we can assume all l_i are equivalent. There is a ray l of a_1 so that all l_i are equivalent to l . Without loss of generality we can assume all l_i are in stable leaves v_i of \mathcal{O}^s . Then as the v_i are distinct, they escape compact sets of \mathcal{O} as $i \rightarrow \infty$. Also v_i separates \tilde{a}_i from a basepoint. Let $B = (b_j)$ be a standard sequence associated to the ideal point of l . Then for any j , then chain b_j intersects only finitely many of the v_i for $i \in \mathbf{N}$, so $b_j \cap v_i = \emptyset$ for i big enough which implies that $\tilde{a}_i \subset \tilde{b}_j$. It follows that $A < B$ and A is associated to the ideal point of l , or of l_k for any k . As in the previous lemma the sequence (a_i) is in only one side of l and hence it cannot be a master sequence for the ideal point of l .

The other case is that there are only finitely many sides equivalent to any given side. If A is not a master sequence for p , then there is B an admissible sequence for the same point and $B \not< A$. As in the proof of lemma 3.7 we can cut along rays of the chains to produce $D = (d_i)$ so that $\tilde{d}_i \cap \tilde{a}_i = \emptyset$ for i big enough. By hypothesis there is $k > i$ so that a_k does not have rays equivalent with rays in a_i . There is C admissible sequence for p with $A < C$, $D < C$ and C a master sequence. But \tilde{c}_k will always have to contain subrays of the inequivalent rays a_i and a_k . The fundamental lemma 3.6 shows that \tilde{c}_k cannot escape compact sets in \mathcal{O} . This is a contradiction and shows that A is a master sequence for p . This finishes the proof of the lemma. \square

Lemma 3.19. *The space \mathcal{D} is first countable.*

Proof. Let p be a point in \mathcal{D} . The result is clear if p is in \mathcal{O} so suppose that p is in $\partial\mathcal{O}$. Let $A = \{a_i\}$ be a master sequence associated to p . We claim that $\{U_{a_i}, i \in \mathbf{N}\}$ is a neighborhood basis at p . Let U be an open set containing p . By definition 3.11 there is i_0 with $\tilde{a}_{i_0} \subset U$ and if z in $\partial\mathcal{O}$ admits a master sequence $B = (b_i)$ so that for some j_0 then $\tilde{b}_{j_0} \subset \tilde{a}_{i_0}$ then z is in U . By the definition of $U_{a_{i_0}}$, it follows that $U_{a_{i_0}} \subset U$. Hence the collection $\{U_{a_i}, i \in \mathbf{N}\}$ forms a neighborhood basis at p . \square

More importantly we have the following:

Lemma 3.20. *The space $\mathcal{D} = \mathcal{O} \cup \partial\mathcal{O}$ is second countable.*

Proof. We first construct a candidate for a countable basis. Since \mathcal{O} is homeomorphic to \mathbf{R}^2 it has a countable basis. For points in $\partial\mathcal{O}$ we proceed as follows: we claim that it suffices to consider admissible sequences (b_i) where for every i the sides of b_i are in periodic leaves. Let $A = (a_i)$ be a master sequence associated to p . Consider a given i . If all sides of a_i are in periodic leaves we are done. Otherwise push them in slightly, that is, make the \tilde{a}_i smaller. First we do this for the finite sides. The obstruction to pushing it in slightly, still intersecting the same adjacent sides is that there is a singularity in this segment. But then this segment is already in a periodic leaf and we leave it as is. We push a segment slightly to produce a chain b_i . Do this for all i . Given i , then since a_j escapes in \mathcal{O} with increasing j , then it is eventually in the region \tilde{b}_i , that is $a_j \subset \tilde{b}_i$. Take a subsequence of the original sequence to make it nested and produce $B = (b_i)$ a master sequence for p .

Given i , consider one ray l of b_i and l_t , $t \geq 0$ leaves of the same foliation as l , with l_t converging to l as $t \rightarrow 0$. We want l_t intersecting the side of b_i adjacent to l . Note that this intersection of l and the adjacent side is not a singular point, otherwise we would be done. If the l_t converge to another leaf (in \tilde{b}_i or not) besides l . Then l is in a non Hausdorff leaf and theorem 2.6 implies that l is in a periodic leaf and we are done. So as $t \rightarrow 0$ then l_t converges only to the leaf containing l . There is $j > i$ so that l is not a side of b_j – otherwise $B = (b_j)$ would not be a master sequence, by lemma 3.18. Choose j big enough so that this is true. Then there is t sufficiently small so that l_t separates l from a_j . This is true because l_t does not converge to any other leaf besides l . Choose also one t for which l_t is a periodic leaf and change b_i to have this ray in l_t . With the new b_i , there is j big enough

with $b_j \subset \tilde{b}_i$. Proceeding in this way we produce a master sequence $C = (c_i)$ which is nested with A and therefore defines the same ideal point of \mathcal{O} . In addition all sides of c_i are periodic, for every i .

Since each sequence has finitely many elements and there are countably many periodic leaves, there are countably many sets of the form c_i as above. Hence there are countably many U_c with some c_i as above. The previous lemma shows that this collection forms a countable basis for the points in $\partial\mathcal{O}$. This finishes the proof of the lemma. \square

Next we show that \mathcal{D} is a regular space, which will imply that \mathcal{D} is metrizable.

Lemma 3.21. *The space \mathcal{D} is a regular space.*

Proof. Let p be a point in \mathcal{D} and V be a closed set not containing p . Suppose first that p is in \mathcal{O} . Here V^c is an open set with p in V^c , so there are open disks D_1, D_2 in \mathcal{O} , so that $p \in D_1 \subset \overline{D_1} \subset D_2 \subset V^c$, producing disjoint neighborhoods D_1 of p and $(D_2)^c$ of V .

Suppose now that p is in $\partial\mathcal{O}$. Since p is not in the closed set V , there is an open set O containing p and disjoint from V . Let $A = (a_i)$ be a master sequence associated to p . Then there is i_0 so that $U_{a_{i_0}}$ defined above is contained in O . Notice that the closure of \tilde{a}_{i_0} in \mathcal{D} is \tilde{a}_{i_0} with a_{i_0} plus the two ideal points of the rays in a_{i_0} . Clearly the closure in \mathcal{O} is just adjoining a_{i_0} . The 2 ideal points of the rays of a_i are clearly in the closure as any neighborhood contains a subray. Any other point in $\partial\mathcal{O}$, if it is in $U_{a_{i_0}}$, then we are done. Otherwise we find a master sequence disjoint from master sequences of both ideal points of a_{i_0} . Therefore they are not in the closure of \tilde{a}_{i_0} .

Choose j big enough so that the rays of a_j are not equivalent to any ray of a_{i_0} , again possible by lemma 3.18. By the above it follows that the closure of \tilde{a}_j is contained in $U_{a_{i_0}}$, hence

$$p \in U_{a_j} \subset \text{closure}(\tilde{a}_j) \subset U_{a_{i_0}} \subset O \subset V^c$$

This proves that \mathcal{D} is regular. \square

Corollary 3.22. *The space \mathcal{D} is metrizable.*

Proof. Since \mathcal{D} is second countable and regular, a classical theorem of general topology – the Urysohn metrization theorem (see [Mu] pg. 215) implies that \mathcal{D} is metrizable. \square

Therefore in order to prove that \mathcal{D} is compact it suffices to show that any sequence in \mathcal{D} has a convergent subsequence. Still it is quite tricky to get a handle on an arbitrary sequence of points in \mathcal{O} or in $\partial\mathcal{O}$ and the proof that \mathcal{D} is compact is very complicated. This is the key property of \mathcal{D} . We first analyse one case which seems very special, but which in fact implies the general case without much additional work. Its proof is very involved because there are many cases to consider.

Lemma 3.23. *Let $(l_i), i \in \mathbf{N}$ be a sequence of slices in leaves of \mathcal{O}^s (or \mathcal{O}^u). Suppose that for each i the set $\mathcal{O} - l_i$ has a component C_i so that all C_i are disjoint and the C_i are linearly ordered as seen from a basepoint in \mathcal{O} . Then in \mathcal{D} , the sequence $(C_i \cup l_i)$ converges to a point p in $\partial\mathcal{O}$.*

Proof. Suppose that l_i is always in \mathcal{O}^s , other cases are similar. If the l_i does not escape compact sets in \mathcal{O} when $i \rightarrow \infty$ then there are i_k and z_{i_k} in l_{i_k} with z_{i_k} converging to a point z . Clearly the C_{i_k} cannot all be disjoint, contradiction. Hence the (l_i) escapes in \mathcal{O} and the C_i are uniquely defined.

The order is defined as follows: Let x in \mathcal{O} be a basepoint. For each i choose an embedded path γ_i from x to l_i . We can do this inductively so that the γ_i are all disjoint except for x . The collection $\{\gamma_i, i \in \mathbf{N}\}$ now induces an order in $\{l_i, i \in \mathbf{N}\}$.

The first situation is that there is an infinite subsequence, which we assume is the original sequence so that l_i are all non separated from l_1 . Here we state a useful lemma also for future use:

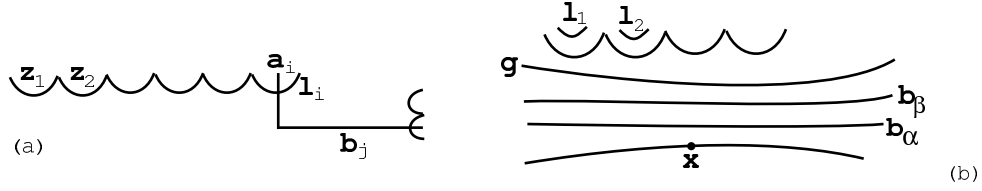

Figure 8: *a. Infinitely many non separated leaves converge to a single ideal point, b. A more interesting situation.*

Lemma 3.24. *If p is a point of $\partial\mathcal{O}$ associated to an infinite collection of non separated leaves in \mathcal{O}^s or \mathcal{O}^u , then a master sequence is obtained with 2 elements in each chain as described below.*

Proof. See fig. 8, a. Recall the structure of the set of infinitely many non separated leaves of a pseudo-Anosov flow, theorem 2.6. Let $\{z_j, j \in \mathbf{Z}\}$ be the set of leaves non separated from each other and ordered as in theorem 2.6. We can find pairs of rays a_j, b_j , a_j in \mathcal{O}^u , b_j in \mathcal{O}^s , with $a_j \cup b_j$ intersecting only in their finite boundary point and satisfying: $a_j \cup b_j$ escapes in \mathcal{O} with j and a_j, b_j are not equivalent. Also the a_j intersects z_j , see fig. 8, a. Let $d_j = a_j \cup b_j$, a convex chain and $D = (d_j)$. We can choose the a_j, b_j so that the d_j form a nested sequence. Then D is an admissible sequence of chains and defines an ideal point p in $\partial\mathcal{O}$. The collection D is also a master sequence associated to p . \square

The $\{l_i, i \in \mathbf{N}\}$ forms a subcollection of a set of leaves non separated from l_1 . Hence we can find a_j, b_j as in the lemma and for any i , l_i intersects a_j where j goes to infinity with i . As in the lemma let $d_j = a_j \cup b_j$ and $D = (d_j)$. Then D is a master sequence defining a point p in $\partial\mathcal{O}$. In addition given any j then for i big enough l_i is contained in \tilde{d}_j . Hence $l_i \cup C_i$ converges to p in \mathcal{D} .

The second possible situation is that up to subsequence, then for any distinct i, j , the l_i is separated from l_j . The procedure will be to inductively choose a leaf g_i so that the sequence $(g_i), i \in \mathbf{N}$ is nested with i and escapes compact sets in \mathcal{O} . Hence it defines an ideal point of \mathcal{O} and the $l_i \cup C_i$ will converge to it.

Fix x in \mathcal{O} . Consider the slices b of \mathcal{O}^s which separate x from ALL of the l_i . Choose x so there is at least one. The collection of slices is clearly ordered by separation properties so we can index then as $\{b_\alpha \mid \alpha \in I\}$ where I is an index set. Put an order in I so that $\alpha < \beta$ if and only if b_α separates b_β from x . Since the b_α cannot escape \mathcal{O} as α increases (they are bounded by all the l_i) then it limits to a collection of leaves and there is a single leaf g which is either equal to some l_{i_0} or separates every l_i from all other elements b_α , see fig. 8, b. In the second case let g_1 be the leaf g thus constructed.

The choice of g_1 in the first case is more complicated. Notice l_{i_0}, l_i are separated if $i \neq i_0$, so in the first case any leaf non separated from g is not equal to some l_i . Also C_i, C_{i_0} are disjoint if i, i_0 are distinct. Hence for each $i \neq i_0$ there is a leaf h_i non separated from g which separates l_i from x .

Suppose there are infinitely many distinct h_i . As seen in the first situation above the (h_i) converges to a point p in $\partial\mathcal{O}$ and by construction so does the (l_i) . This finishes the proof in this case. The remaining option is that there are only finitely many distinct h_i . So there is some h so that $h = h_i$ for infinitely many i . Let g_1 be this h . Now we are going to restart the process, but we keep only the l_i 's separated from l_{i_0} by this h – which must be all l_i for i sufficiently big since the collection $\{l_i, i \in \mathbf{N}\}$ is ordered. Now throw out the first leaf l_i still in the sequence and redo the process. This iterative process produces $(g_j), j \in \mathbf{N}$ which is a weakly nested sequence of leaves. We explain the weak behavior. For instance in the first case, after throwing out l_1 (or whatever first leaf was still present), it may be that only g_1 is a slice which separates x from all other l_i , see fig. 9, b.

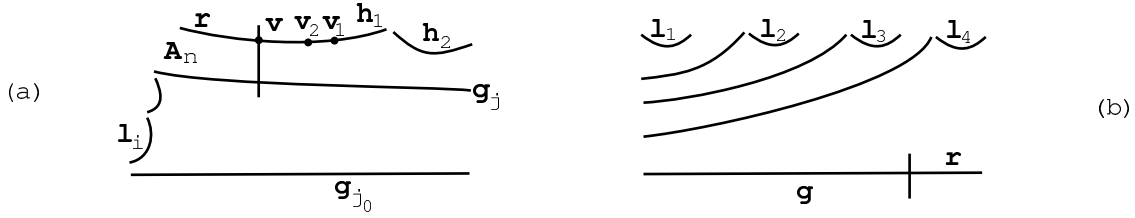

Figure 9: a. Forcing convergence on one side, b. The case that all g_j are equal.

In that case $g_2 = g_1$. So the g_j may be equal, but they are weakly monotone with j .

If the (g_j) escapes in \mathcal{O} with j then it defines a point p in $\partial\mathcal{O}$. Since each g_j separates infinitely many l_i from x we quickly obtain as before that the l_i converge to a point in $\partial\mathcal{O}$. Suppose then that the (g_j) does not escape in \mathcal{O} . The first option is that there are infinitely many distinct g_j . Up to taking a subsequence assume all g_j are distinct and let g_j converge to $H = \cup h_k$, a collection of stable leaves in \mathcal{O}^s . By construction, for each j_0 , the g_{j_0} separates some l_i from x but for a bigger j , the g_j does not separate l_i from x , see fig. 9, a. Also, for each i there is some j so that g_j separates l_i from x .

We analyse the case there are finitely many line leaves of \mathcal{O}^s in H , the other case being similar. As seen in theorem 2.6 the set of leaves in H is ordered and we choose h_1 to be the leaf closest to the l_i . Also there is a ray r of l which points in the direction of the l_i , see fig. 9, a. Let p be the ideal point of r in $\partial\mathcal{O}$. We want to show that $l_i \cup C_i$ converges to p .

Choose points v_n in r converging to p . For each n then $\mathcal{O}^u(v_n)$ intersects g_j for j big enough – since the sequence g_j converges to H . Choose one such g_j with j converging to infinity with n . We consider a convex set A_n of \mathcal{O} bounded by a subray of r starting at v_n , a segment in $\mathcal{O}^u(v_n)$ between h_1 and g_j for a suitable big j and a ray in g_j starting in $g_j \cap \mathcal{O}^u(v_n)$ and going in the direction of the l_i , see fig. 9, a. We can choose j so that the $(A_n), n \in \mathbf{N}$ forms a nested sequence. Let $a_n = \partial A_n$. Since h_1 is the first element of H it follows that (a_n) escapes compact sets in \mathcal{O} and clearly it converges to p . For each n and associated j , there is i_0 so that for $i > i_0$ then g_j separates l_i from x . It follows that $l_i \cup C_i$ is contained in A_n and therefore $(l_i \cup C_i)$ converges to p in \mathcal{D} . This finishes the proof in this case.

If H is infinite let $H = \{h_k, k \in \mathbf{Z}\}$ with k increasing as h_k moves in the direction of the l_i . Then h_i converges to a point $p \in \mathcal{O}$. A similar analysis as in the case that H is finite shows that $l_i \cup C_i$ converges to p in \mathcal{D} . Use the convex chains $a_j \cup b_j$ as described in lemma 3.24.

The final case to be considered is that up to subsequence all g_i are equal and let g be this leaf. In particular no l_i is equal to g . This can certainly occur as shown in fig. 9, b. If we remove finitely many of the l_i , then g is still the farthest leaf separating x from all the remaining l_i .

Consider the collection of leaves \mathcal{C} of \mathcal{O}^s non separated from g in the side of g containing the l_i . Let W be the component of $\mathcal{O} - \mathcal{C}$ which contains all elements of \mathcal{C} in its boundary. If \mathcal{C} has just one element let W be the component which contains the l_i .

One possibility is that there are infinitely many l_i so that each such l_i is separated from g by an element in \mathcal{C} . Here we have 2 options. The first option is that there are infinitely many distinct elements e in \mathcal{C} for which there is some l_i with e separating l_i from g , see fig. 10, a. Since the l_i are nested then as seen before this implies that the $l_i \cup C_i$ converge to some p in $\partial\mathcal{O}$. The second option here is that there is some fixed h' in \mathcal{C} which separates infinitely many l_i from g . As the sequence (l_i) is nested, this is true for all $i \geq i_0$ for some i_0 . But then h' would eventually take the place of g in the iterative process, so this cannot happen.

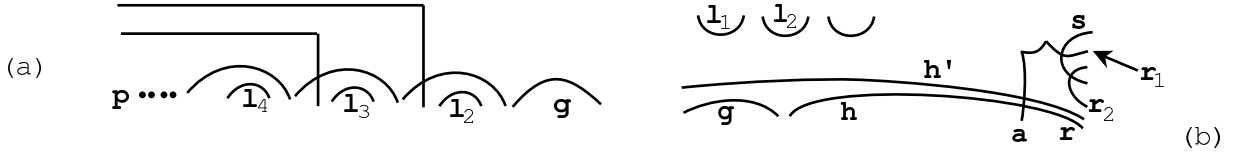

Figure 10: *a. The l_i flip to the other side of a leaf non separated from g , b. Convex neighborhood disjoint from all.*

The remaining case is that after throwing out a few initial terms then all l_i are contained W , see fig. 10, b. Fix an embedded arc γ from g to l_1 intersecting them only in boundary points and not intersecting any other l_i . Let T be the component of $\mathcal{O} - (g \cup \gamma \cup l_1)$ containing all other l_i . Put an order in \mathcal{C} so that elements of \mathcal{C} contained in T are bigger than g in this order. For simplicity assume that \mathcal{C} is finite. The case where there are infinitely many leaves non separated from g on that side is very similar with proof left to the reader. Let h be the biggest element of \mathcal{C} , which could be g itself. Let r the ray of h associated to the increasing direction of the the l_i and let p in $\partial\mathcal{O}$ be the ideal point of r . We want to show that l_i converges to p .

Let A be an arbitrary convex neighborhood of p in \mathcal{D} bounded by a convex chain a , see fig. 10, b. If A is small enough then a has a ray r_1 contained in T . The rays r, r_1 are not equivalent. Let h' leaf of \mathcal{O}^s in W sufficiently close to g . Because h is the biggest element in the ordered set \mathcal{C} then h' has to have a ray contained in A . For h' close enough to g , since the l_i are in T , then for some i_0 the leaf h' separates $l_i, 1 \leq i \leq i_0$ from g and hence from x . By the maximality property of g , then for some j the leaf h' does not separate l_j from g . Since l_j is in T this forces l_j to be contained in A . As the $\{l_i, i \in \mathbf{N}\}$ forms an ordered collection this forces l_i to be contained in A for all $i \geq j$. Since A was an arbitrary neighborhood of p this shows that $(l_i \cup C_i)$ converges to p in \mathcal{D} .

This finishes the proof of lemma 3.23. \square

This lemma was very involved because there are so many places the sequence $\{l_i\}$ can slip through.

Proposition 3.25. *The space \mathcal{D} is compact.*

Proof. Since \mathcal{D} is metrizable, it suffices to consider the behavior of sequences z_i in \mathcal{D} . Up to taking subsequences there are 2 cases:

1) Assume the z_i are all in \mathcal{O} . If there is a subsequence of z_i in a compact set of \mathcal{O} we are done. So assume that z_i escapes compact sets in \mathcal{O} . Let l_i be slice leaves of \mathcal{O}^s with z_i in l_i . Suppose there is a subsequence (l_{i_k}) converging to l and assume that all l_{i_k} are in one sector of l or in l itself. If a subsequence of (l_{i_k}) is constant and equal to l then up to another subsequence the z_i converge in \mathcal{D} to one of the ideal points of l , done. A small transversal to l in a regular unstable leaf intersects l_{i_k} for k big enough and up to subsequence assume all z_{i_k} are in one side of that unstable leaf. Suppose for simplicity there are only finitely many leaves non separated from l in the side containing the l_i . Let l' be the last one non separated from l in the side the l_{i_k} are in and let p be the ideal point of l' in that direction. The argument is similar to a previous one: let v_n in l' converging to p in \mathcal{D} with $\mathcal{O}^u(v_n)$ regular. Choose a convex chain a_n made up of the ray in l' starting in v_n and converging to p , then the segment in $\mathcal{O}^u(v_n)$ from v_n to $\mathcal{O}^u(v_n) \cap l_{i_k}$ for appropriately big k and then a ray in l_{i_k} starting in this point. As before we can choose the a_n nested and converging to p in \mathcal{D} . It follows that z_{i_k} converges to p and we are done in this case. The case of infinitely many leaves non separated from l is treated similarly as seen in the proof of lemma 3.23.

Suppose now that the sequence $(l_i), i \in \mathbf{N}$ escapes compact sets in \mathcal{O} . Fix a base point x in \mathcal{O} and assume that x is not in any l_i and define \tilde{l}_i to be the component of $\mathcal{O} - l_i$ not containing x .

Then \tilde{l}_i escapes compact sets in \mathcal{O} . If there is a subsequence (l_{i_k}) so that (l_{i_k}) is nested then this defines an admissible sequence of convex chains (of length one) converging to an ideal point p .

Otherwise there has to be i_1 so that it only has finitely many i with $\tilde{l}_i \subset \tilde{l}_{i_1}$. Choose $i_2 > i_1$ with $\tilde{l}_{i_2} \not\subset \tilde{l}_{i_1}$ and hence $\tilde{l}_{i_2} \cap \tilde{l}_{i_1} = \emptyset$ and also so that there are finitely many i with $\tilde{l}_i \subset \tilde{l}_{i_2}$. In this way we construct a subsequence $i_k, k \in \mathbf{N}$ with \tilde{l}_{i_k} disjoint from each other. The collection of leaves

$$\{\tilde{l}_{i_k} \mid k \in \mathbf{N}\}$$

is circularly ordered (as a subset of $\partial\mathcal{O}$) and if we remove one element of the sequence (say the first one) then it is ordered. As such it can be mapped into \mathbf{Q} in an order preserving way. Therefore there is another subsequence (call it still (l_{i_k})) for which (l_{i_k}) is monotone. Now apply the previous lemma and obtain that (l_{i_k}) converges to a point p in $\partial\mathcal{O}$ and hence so does z_{i_k} .

This finishes the analysis of case 1.

Case 2 – Suppose the z_i are in $\partial\mathcal{O}$.

Here we will eventually use the analysis of case 1. We may assume that the points z_i are distinct. To start we can find a convex neighborhood bounded by a convex chain a_1 so that $\overline{U_{a_1}}$ is a neighborhood of z_1 in \mathcal{D} and also it does not contain any other z_i . Otherwise there is a subsequence of (z_i) which converges to z_1 . Then find a_2 convex chain with $\overline{U_{a_2}}$ neighborhood of z_2 in \mathcal{D} disjoint from $\overline{U_{a_1}}$ and not containing any other z_i either. Inductively construct a_i convex chains with $\overline{U_{a_i}}$ neighborhood of a_i in \mathcal{D} and all $\overline{U_{a_i}}$ disjoint from each other. By taking smaller convex neighborhoods we can assume that the (U_{a_i}) escapes compact sets in \mathcal{O} as $i \rightarrow \infty$. Up to subsequence we may assume that the $\{U_{a_i}, i \in \mathbf{N}\}$ forms an ordered set as seen with respect to a collection of disjoint arcs (except for initial points) from x to a_i . Let w_i be a point in a_i . Since a_i escapes compact sets in \mathcal{O} we obtain by case 1 that there is a subsequence w_{i_k} converging to a point p in $\partial\mathcal{O}$. Consider a master sequence $B = (b_j)$ associated to p . Let j be an integer. If for all k we have that $\tilde{a}_{i_k} \not\subset \tilde{b}_j$, then \tilde{a}_{i_k} has a point w_{i_k} converging to p and also has points outside \tilde{b}_j . This contradicts the \tilde{a}_{i_k} being all disjoint since they are convex. Therefore $\tilde{a}_{i_k} \subset \tilde{b}_j$ for k big enough – this follows because the sequence \tilde{a}_{i_k} is ordered. It follows that w_{i_k} converges to p . Therefore there is always a subsequence of the original sequence which converges to a point in $\partial\mathcal{D} = \partial\mathcal{O}$.

This finishes the proof of proposition 3.25, compactness of \mathcal{D} . □

We now prove a couple of additional properties of \mathcal{D} .

Proposition 3.26. *The space $\partial\mathcal{O}$ is homeomorphic to a circle.*

Proof. The space $\partial\mathcal{O}$ is metrizable and circularly ordered. In general only an index 2 subgroup of $\pi_1(M)$ preserves the circular order. Also $\partial\mathcal{O}$ is compact, being a closed subset of a compact space – since \mathcal{O} is open in \mathcal{D} . We now show that $\partial\mathcal{O}$ is connected, no points disconnect the space and any two points disconnect the space.

Let p, q be distinct points in $\partial\mathcal{O}$. Choose disjoint convex neighborhoods $\overline{U_a}, \overline{U_b}$ of p, q defined by convex chains a, b . There are ideal points in $\overline{U_a}$ distinct from p , hence there is a point in $\partial\mathcal{O}$ between p, q . Hence any “interval” in \mathcal{O} is a linear continuum, being compact and satisfying the property that between any two points there is another point. This shows that $\partial\mathcal{O}$ is connected and also that no point in $\partial\mathcal{O}$ disconnects it. In addition as $\partial\mathcal{O}$ is circularly ordered, then any two points disconnect $\partial\mathcal{O}$. By theorem I.11.21, page 32 of Wilder [Wi], the space $\partial\mathcal{O}$ is homeomorphic to a circle. □

We are now ready to prove that \mathcal{D} is homeomorphic to a disk.

Theorem 3.27. *The space $\mathcal{D} = \mathcal{O} \cup \partial\mathcal{O}$ is homeomorphic to the closed disk D^2 .*

Proof. The proof will use classical results of general topology, namely a theorem of Zippin characterizing the closed disk \mathbf{D}^2 , see theorem III.5.1, page 92 of Wilder [Wi].

First we need to show that \mathcal{D} is a Peano continuum, see page 76 of Wilder [Wi]. A Hausdorff topological space C is a *Peano space* if it is not a single point, it is second countable, normal, locally compact, connected and locally connected. Notice that Wilder uses the term perfectly separable (definition in page 70 of [Wi]) instead of second countable. If in addition C is compact then C is a *Peano continuum*.

By proposition 3.25 our space \mathcal{D} is compact, hence locally compact. It is also Hausdorff – lemma 3.15 – hence normal. By lemma 3.20 it is second countable and it is clearly not a single point. What is left to show is that \mathcal{D} is connected and locally connected.

We first show that \mathcal{D} is connected. Suppose not and let A, B be a separation of \mathcal{D} . Since $\partial\mathcal{O}$ is connected (this is done in the proof of proposition 3.26), then $\partial\mathcal{O}$ is contained in either A or B , say it is contained in A . Then B is contained in \mathcal{O} . If B is not contained in a compact set of \mathcal{O} then there is a sequence of points in B escaping compact sets in \mathcal{O} . As \mathcal{D} is compact and metric, there is a subsequence converging in \mathcal{D} , which must converge to a point in $\partial\mathcal{O}$, contradiction to A, B forming a separation. It follows that there is a closed disk D in \mathcal{O} with B contained in the interior of D . Then $D \cap A, D \cap B$ form a separation of D , contradiction.

Next we show that \mathcal{D} is locally connected. Since $\mathcal{O} \cong \mathbf{R}^2$, then \mathcal{D} is locally connected at every point of \mathcal{O} . Let p in $\partial\mathcal{O}$ and let W be a neighborhood of p in \mathcal{D} . If $A = (a_i)$ is a master sequence associated to p , there is i with $\overline{U_{a_i}}$ contained in W and U_{a_i} is a neighborhood of p in \mathcal{D} . Now $U_{a_i} \cap \mathcal{O} = \tilde{a}_i$ is homeomorphic to \mathbf{R}^2 also and hence connected. The closure of \tilde{a}_i in \mathcal{D} is $\overline{U_{a_i}}$. Since

$$\tilde{a}_i \subset U_{a_i} \subset \overline{U_{a_i}}$$

then U_{a_i} is connected. This shows that \mathcal{D} is locally connected and that \mathcal{D} is a Peano continuum.

To use theorem III.5.1 of [Wi] we need the idea of spanning arcs. An arc in a topological space X is a subspace homeomorphic to a closed interval in \mathbf{R} . Let ab denote an arc with endpoints a, b . If K is a point set, we say that ab spans K if $K \cap ab = \{a, b\}$. We now state theorem III.5.1 of [Wi].

Theorem 3.28. (*Zippin*) *A Peano continuum C containing a 1-sphere J and satisfying the following conditions below is a closed 2-disk with boundary J :*

- (i) *C contains an arc that spans J ,*
- (ii) *Every arc that spans J separates C ,*
- (iii) *No closed proper subset of an arc spanning J separates C .*

Here E separates C mean that $C - E$ is not connected.

In our case J is $\partial\mathcal{O}$. For condition (i) let l be a non singular leaf in \mathcal{O}^s or \mathcal{O}^u . Then l has 2 ideal points in \mathcal{O} which are distinct. The closure \bar{l} is an arc that spans $\partial\mathcal{O}$. This proves (i).

We prove (ii). Let ζ be an arc in \mathcal{D} spanning $\partial\mathcal{O}$. Then $\zeta \cap \mathcal{O}$ is a properly embedded copy of \mathbf{R} in \mathcal{O} . Hence $\mathcal{O} - (\zeta \cap \mathcal{O})$ has exactly two components A_1, B_1 . In addition $\partial\mathcal{O} - (\zeta \cap \partial\mathcal{O})$ has exactly two components A_2, B_2 and they are connected, since $\partial\mathcal{O}$ is homeomorphic to a circle by proposition 3.26. If p is in A_2 there is a connected neighborhood U of p in \mathcal{D} which is disjoint from ζ – since ζ is closed in \mathcal{D} . Hence $U \cap \mathcal{O}$ is contained in either A_2 or B_2 . This also shows that a neighborhood of p in $\partial\mathcal{O}$ will also satisfy the same property. By connectedness of A_2, B_2 , then after switching A_1 with B_1 if necessary it follows that: for any $p \in A_2$ there is a neighborhood U of p in \mathcal{D} with $U \cap \zeta = \emptyset$ and $U \cap \mathcal{O} \subset A_1$. Similarly B_2 is paired with B_1 . Let $A = A_1 \cup A_2$ and $B = B_1 \cup B_2$. The arguments above show that A, B are open in \mathcal{D} and therefore they form a separation of $\mathcal{D} - \zeta$. This proves (ii).

Since $\mathcal{O} - (\zeta \cap \mathcal{O})$ has exactly two components A_1, B_1 then $\zeta \cap \mathcal{O}$ is contained in $\overline{A_1} \cap \overline{B_1}$ and so $\zeta \subset \overline{A} \cap \overline{B}$. It follows that no proper subset of ζ separates \mathcal{D} . This proves property (iii).

Now Zippin's theorem implies that \mathcal{D} is homeomorphic to a closed disk. This finishes the proof of theorem 3.27. \square

Notice that $\pi_1(M)$ acts on \mathcal{O} by homeomorphisms. The action preserves the foliations $\mathcal{O}^s, \mathcal{O}^u$ and also preserves convex chains, admissible sequences, master sequences and so on. Hence $\pi_1(M)$ also acts by homeomorphisms in \mathcal{D} . The next result is very useful in the following section.

Proposition 3.29. *Let Φ be a pseudo-Anosov flow in M^3 closed. Let p be an ideal point of \mathcal{O} . Then one of the 3 mutually exclusive options occurs:*

- 1) *There is a master sequence $L = (l_i)$ for p where l_i are slices in leaves of \mathcal{O}^s or \mathcal{O}^u .*
- 2) *p is an ideal point of a ray l of \mathcal{O}^s or \mathcal{O}^u so that l makes a perfect fit with another ray of \mathcal{O}^s or \mathcal{O}^u . There are master sequences which are standard sequences associated to a ray in \mathcal{O}^s or \mathcal{O}^u as described before definition 3.2.*
- 3) *p is an ideal point associated to infinitely many leaves non separated from each other. Then a master sequence for p is obtained as described in lemma 3.24.*

Proof. Fix a basepoint x in \mathcal{O} . Let $A = (a_i)$ be a master sequence defining p . Assume that x is not in the closure of any \tilde{a}_i . Each a_i is a convex chain, $a_i = b_1 \cup \dots \cup b_n$ where b_i is either a segment or a ray in \mathcal{O}^s or \mathcal{O}^u . For simplicity we omit the dependence of the b_j 's on the index i .

Claim – For each i there is some b_j as above, with b_j is contained in a slice z of \mathcal{O}^s or \mathcal{O}^u , so that z separates x from \tilde{a}_i .

Given j let y be an endpoint of b_j . Wlog assume b_j is in a leaf of \mathcal{O}^s and y is in b_{j+1} also.. Since \tilde{a}_i is a convex chain, we can extend b_j along $\mathcal{O}^s(y)$ beyond y and entirely outside \tilde{a}_i . The hypothesis that \tilde{a}_i is convex is necessary, for otherwise at a non convex switch any continuation of b_j along $\mathcal{O}^s(y)$ would have to enter \tilde{a}_i . If one encounters a singular point in $\mathcal{O}^s(y)$ (which could be y itself), then continue along the prong closest to b_{j+1} . This produces a slice c_j of $\mathcal{O}^s(y)$ with $b_j \subset c_j$. There is a component V_j of $\mathcal{O} - c_j$ containing \tilde{a}_i . Since we choose the prong closest to b_{j+1} then

$$\bigcap_{j=1}^n V_j = \tilde{a}_i$$

Since x is not in \tilde{a}_i , then there is j with x not in V_j and so c_j separates x from \tilde{a}_i . Let z be this slice c_j . This proves the claim.

Using the claim then for each i produce such a slice and denote it by l_i . Let \tilde{l}_i be the component of $\mathcal{O} - l_i$ containing \tilde{a}_i . Up to subsequence assume all the l_i are in (say) \mathcal{O}^s . Since A is a master sequence for p , we may also assume, by lemma 3.18, that all the l_i are disjoint from each other.

We now analyse what happens to the l_i . The first possibility is that the sequence (l_i) escapes compact sets in \mathcal{O} . Then this sequence defines an ideal point of \mathcal{O} . As $\tilde{a}_i \subset \tilde{l}_i$, it follows that $L = (l_i)$ is an admissible sequence for p . Since $A = (a_i)$ is a master sequence for p , then given \tilde{a}_i , there is $j > i$ with $l_j \subset \tilde{a}_i$. It follows that $L = (l_i)$ is also a master sequence for p . This is case 1).

Suppose from now on that for any master sequence $A = (a_i)$ for p and any (l_i) as constructed above, then (l_i) does not escape compact sets. Then (l_i) converges to a family of non separated leaves in \mathcal{O}^s : $\mathcal{C} = \{c_k, k \in J \subset \mathbf{Z}\}$. Assume \mathcal{C} is ordered as described in theorem 2.6. Here J is either $\{1, \dots, k_0\}$ or is \mathbf{Z} . Choose $x_i \in b_i = a_i \cap l_i$. Hence x_i converges to p in \mathcal{D} as $i \rightarrow \infty$. For any y in \mathcal{C} , then $y \in c_k$ for some k and $\mathcal{O}^u(y)$ intersects l_i for i big enough in a point denoted by y_i . Similarly for z in \mathcal{C} define z_i . This notation will be used for the remainder of the proof.

Situation 1 – Suppose there are $y, z \in \mathcal{C}$ so that for big enough i , x_i is between y_i and z_i in l_i .

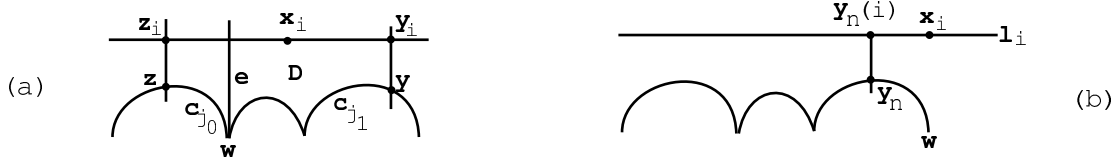

Figure 11: a. The case that x_i is between some unstable leaves, b. The case x_i escapes to one side.

We refer to fig. 11, a. Let z in c_{j_0} , y in c_{j_1} , with $j_0 \leq j_1$. If $j_0 = j_1$ then the segment u_i of l_i between z_i, y_i converges to the segment in $\mathcal{O}^s(z)$ between z and y . Then x_i does not escape compact sets, contradiction.

For any k the leaves c_k, c_{k+1} are non separated from each other and there is a leaf e of \mathcal{O}^u making perfect fits with both c_k, c_{k+1} . This defines an ideal point w of $\partial\mathcal{O}$ which is an ideal point of equivalent rays of c_k, c_{k+1} and e , see fig. 11, a ($k = j_0$ in the figure). Consider the region D of \mathcal{O} bounded by the ray of c_{j_0} defined by z and going in the y direction, the segment in $\mathcal{O}^u(z)$ from z to z_i , the segment u_i in l_i from z_i to y_i , the segment in $\mathcal{O}^u(y)$ from y_i to y , the ray in $\mathcal{O}^s(y)$ defined by y and going towards the z direction and the leaves c_k with $j_0 < k < j_1$ (this last set may be empty). By the remark above, the only ideal points of D in $\partial\mathcal{O}$, that is the set $\overline{D} \cap \partial\mathcal{O}$ (closure in \mathcal{D}), are those associated to rays of c_k with $j_0 \leq k \leq j_1$. One such point is the w defined above. It follows that x_i converges to one of these and p is one of these points. So p is an ideal point of a ray of \mathcal{O}^s or \mathcal{O}^u which makes a perfect fit with another leaf. There is a master sequence which is a standard sequence associated to p . This is case 2 of the proposition. Notice it is disjoint from case 1).

Situation 2 – For any y, z in \mathcal{C} the x_i is eventually not between the corresponding y_i, z_i .

Suppose first that \mathcal{C} is an infinite collection of non separated leaves. Let $y \in \mathcal{C}$. Then up to subsequence the x_i are in one side of y_i in l_i , say in the side corresponding to increasing k in the order of \mathcal{C} (this is in fact true for the original sequence as x_i converges in \mathcal{D}). Let w be the ideal point associated to infinitely many non separated leaves as in lemma 3.24. Let $g_m = e_m \cup f_m$ and let $G = (g_m)$ be a master sequence associated to w as in lemma 3.24. Fix m . Then x_i is eventually in \tilde{g}_m . Therefore x_i converges to w and $w = p$. Here we are in case 3). Notice all 3 cases are mutually exclusive.

Finally suppose that \mathcal{C} is finite. We may assume that x_i is closer to y_i than z_i in l_i . Let w be the ideal point of that ray of c_{k_0} . Let y_n in c_{k_0} converging to w . Let

$$y_n(i) = \mathcal{O}^u(y_n) \cap l_i$$

Fix n . Then eventually in i , the x_i is in the component of $l_i - y_n(i)$ not containing z_i . Consider a standard sequence defining w so that: it is arbitrary in the side of $\mathcal{O} - c_{k_0}$ not containing x_i and in the other side we have an arc in $\mathcal{O}^u(y_n)$ from y_n to $y_n(i)$ and then a ray in l_i – which contains x_i for i big. Since c_{k_0} is the biggest element in \mathcal{C} , there is no leaf of \mathcal{O}^s non separated from c_{k_0} in that side. Hence the l_i cannot converge (in \mathcal{O}) to anything on that side and those parts of l_i escape in \mathcal{O} . As the x_i are in these subarcs of l_i then $x_i \rightarrow w$ in \mathcal{D} and so $p = w$.

Let $r_n = \mathcal{O}^u(y_n)$. If r_n escapes compact sets in \mathcal{O} as $n \rightarrow \infty$, then it defines a master sequence for p and we are in case 1). Otherwise r_n converges to some r making a perfect fit with c_{k_0} and we are in case 2). This finishes the proof of proposition 3.29. \square

4 Flow ideal boundary and compactification of the universal cover

In this section we start with a simple pseudo-Anosov flow and using only dynamical systems tools we compactify the universal cover \widetilde{M} with a sphere at infinity where the fundamental group acts naturally. We begin with a preliminary model compactification.

Lemma 4.1. (*model pre compactification*) *Let M be a closed 3-manifold with a pseudo-Anosov flow. There is a compactification \mathcal{A}_1 of \widetilde{M} as a topological product $\mathcal{D} \times [-1, 1]$.*

Proof. Recall that \mathcal{D} is a compactification of the orbit space \mathcal{O} of $\widetilde{\Phi}$ and \mathcal{D} is homeomorphic to a closed disk. Let \mathcal{A}_1 be $\mathcal{D} \times [-1, 1]$ with the product topology. This is compact homeomorphic to a closed 3-ball. The set \widetilde{M} is homeomorphic to the interior $\mathcal{O} \times (-1, 1)$. In fact choose a cross section $f_1 : \mathcal{O} \rightarrow \widetilde{M}$ and a homeomorphism $f_2 : (-1, 1) \rightarrow \mathbf{R}$. This produces a homeomorphism

$$f : \mathcal{O} \times (-1, 1) \rightarrow \widetilde{M}, \quad f(x, t) = \widetilde{\Phi}_{f_2(t)}(f_1(t))$$

Clearly the topology in \widetilde{M} is the same as the induced topology from $\mathcal{O} \times (-1, 1)$. In this way \widetilde{M} can be seen as an open subset of \mathcal{A}_1 . \square

This construction is reminiscent of the one done by Cannon-Thurston [Ca-Th] for fibrations. The next remark is very important.

Remark – We should stress that this precompactification \mathcal{A}_1 is far from natural. The interior of \mathcal{A}_1 is homeomorphic to \widetilde{M} and this works fine. However the boundary of \mathcal{A}_1 is very unnatural. The topology in $\mathcal{D} \times \{-1, 1\}$ is what you would expect, since it is homeomorphic to the topology of \mathcal{D} , which is group equivariant. But the topology in $\partial\mathcal{O} \times [-1, 1]$ is really not well defined. Using the section f_1 we can define a trivialization of $\partial\mathcal{O} \times [-1, 1]$, connecting it to $\widetilde{M} \cong \mathcal{O} \times (-1, 1)$. The big problem here is that this is not group invariant in $\partial\mathcal{O} \times (-1, 1)$. In fact given a covering translation h of \widetilde{M} , there is no guarantee that it will extend to $\partial\mathcal{O} \times (-1, 1)$ (but it does extend naturally and continuously to $\mathcal{D} \times \{-1, 1\}$). This problem is easily seen even in the case of suspension pseudo-Anosov flows. Instead of using the lift of a fiber as a section $\mathcal{O} \rightarrow \widetilde{M}$, use a section which goes one step lower (with respect to the fiber) in certain directions. From the point of view of the new trivialization of $\mathcal{D} \times [-1, 1]$ certain covering translations will not extend to $\mathcal{D} \times [-1, 1]$.

This will not be a problem for us, because we will collapse $\partial\mathcal{A}_1$, identifying all vertical intervals $\{z\} \times [-1, 1]$ (z in $\partial\mathcal{O}$) to points. In fact one could have started with just the top and bottom $\mathcal{D} \times \{-1, 1\}$. However it is much easier to describe sets and neighborhoods in the $\mathcal{D} \times [-1, 1]$ model as above, making many arguments simpler. The topology of the quotient space will be completely independent of which section we start with and will depend only on the pseudo-Anosov flow.

Notice that the boundary of \mathcal{A}_1 is a sphere. The compactification of \widetilde{M} we desire will be a quotient of \mathcal{A}_1 , where the identifications occur only in the boundary sphere. First we work only in the boundary of \mathcal{A}_1 and later incorporate \widetilde{M} .

We will use a theorem of Moore concerning cellular decompositions. A decomposition G of a space X is a collection of disjoint nonempty closed sets whose union is X . There is a quotient space X/G and a map $\nu : X \rightarrow X/G$. The points of X/G are just the elements of G . The point $\nu(x)$ is the unique element of G containing x . The topology in X/G is the quotient topology: a subset U of X/G is open if and only if $\nu^{-1}(U)$ is open in X .

A decomposition G of X satisfies the *upper semicontinuity property* provided that, given g in G and V open in X containing g , the union of those g' of G contained in V is an open set in X . Equivalently ν is a closed map.

A decomposition G of a closed 2-manifold B is *cellular*, provided that G is upper semicontinuous and provided each g in G is compact and has a non separating embedding in the Euclidean plane E^2 . The following result was proved by R. L. Moore for the case of a sphere:

Theorem 4.2. (*approximating cellular maps, Moore's theorem*) *Let G denote a cellular decomposition of a 2-manifold B homeomorphic to a sphere. Then the identification map $\nu : X \rightarrow X/G$ can be approximated by homeomorphisms. In particular X and X/G are homeomorphic.*

Theorem 4.3. *Let Φ be a pseudo-Anosov flow in M^3 closed and $\mathcal{A}_1 = \mathcal{D} \times [-1, 1]$ the model precompactification of \widetilde{M} . Suppose that Φ is simple (not topologically conjugate to a suspension pseudo-Anosov flow and there are no perfect fits between leaves of $\widetilde{\Lambda}^s, \widetilde{\Lambda}^u$). Then $\partial\mathcal{A}_1$ has a quotient \mathcal{R} which is a 2-sphere where the group $\pi_1(M)$ acts by homeomorphisms. The space \mathcal{R} and its topology are completely independent of the model precompactification \mathcal{A}_1 and depend only on the flow Φ .*

Proof. Notice that the topology in $\mathcal{D} \times \{-1, 1\}$ is well defined. We will stress where needed that arguments are independent of the topology in $\partial\mathcal{O} \times (-1, 1)$ or its parametrization/trivialization. Recall that a pseudo-Anosov flow satisfying the hypothesis of the theorem is called simple.

We construct a cell decomposition \mathcal{G} of $\partial\mathcal{A}_1$ as follows. The cells are one of the following types:

(1) Let l be a leaf of \mathcal{O}^s with ideal points a_1, \dots, a_n in $\partial\mathcal{O}$. Consider the cell element

$$g_l = l \times \{1\} \cup \bigcup_{1 \leq i \leq n} a_i \times [-1, 1]$$

(2) Let l be a leaf of \mathcal{O}^u with ideal points b_1, \dots, b_m in $\partial\mathcal{O}$. Consider the cell element

$$g_l = l \times \{-1\} \cup \bigcup_{1 \leq i \leq m} b_i \times [-1, 1]$$

(3) Let z be a point of $\partial\mathcal{O}$ which is not an ideal point of a ray of \mathcal{O}^s or \mathcal{O}^u . Consider the cell element $g_z = z \times [-1, 1]$.

Since every point in \mathcal{O} is in a leaf of \mathcal{O}^s , then elements of type (1) cover $\mathcal{O} \times \{1\}$. Similarly elements of type (2) cover $\mathcal{O} \times \{-1\}$. Finally elements of type (3) cover the rest of $\partial\mathcal{O} \times [-1, 1]$. Cover here means the union contains the set in question. Under the hypothesis of no perfect fits, no two rays of \mathcal{O}^s or \mathcal{O}^u have the same ideal point. This implies that distinct elements of type (1), (2) or (3) are disjoint from each other. This defines the decomposition \mathcal{G} of $\partial\mathcal{A}_1$.

We now show that \mathcal{G} is a cellular decomposition of $\partial\mathcal{A}_1$. Any element of type (3) is homeomorphic to a closed interval, hence compact. An element g of type (1) is the union of finitely many closed intervals in $\partial\mathcal{O} \times [-1, 1]$ and a set $(l \cup \partial_\infty l) \times \{1\}$ in $\mathcal{D} \times \{1\}$. The set $l \cup \partial_\infty l$ (contained in \mathcal{D}) is homeomorphic to a compact p-prong in the plane. Therefore g is compact and homeomorphic to $l \cup \partial_\infty l$. In addition, any g in \mathcal{G} has a non separating embedding in the Euclidean plane.

We now show that \mathcal{G} is upper semicontinuous. Let g in \mathcal{G} and V an open set in $\partial\mathcal{A}_1$ containing g . Let V' be the union of the g' in \mathcal{G} with $g' \subset V$. We need to show that V' is open in $\partial\mathcal{A}_1$. Since g is arbitrary it suffices to show that V' contains an open neighborhood of g in $\partial\mathcal{A}_1$. We do the proof for elements of type (1) see fig. 12, the other cases being very similar.

Let g be generated by the leaf l of \mathcal{O}^s . Let l' be $l \times \{1\}$. Let a_1, \dots, a_n be the ideal points of l in $\partial_\infty\mathcal{O}$. For each i there is a neighborhood J_i of $a_i \times [-1, 1]$ in $\partial\mathcal{O}$ with $J_i \times [-1, 1]$ contained in V . This is because $\partial\mathcal{O} \times [-1, 1]$ is homeomorphic to a closed annulus. This conclusion is independent of which topology is put in $\partial\mathcal{O} \times [-1, 1]$.

Let $(p_k), k \in \mathbf{N}$ a sequence of points in $\partial(\mathcal{D} \times [-1, 1])$ converging to some point p in g . Let g_k be the element of \mathcal{G} containing p_k . We will show that for k big enough, then g_k is contained in V and therefore p_k has to be contained in V' . Hence V' contains an open neighborhood of g in $\partial\mathcal{A}_1$.

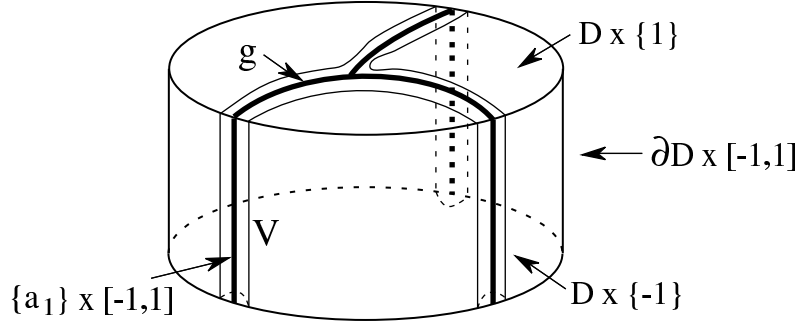

Figure 12: An element of g type (1) in $\partial\mathcal{A}_1$ and a neighborhood of it.

Up to a subsequence we may assume that all p_k are either in I) $\mathcal{O} \times \{1\}$, II) $\mathcal{O} \times \{-1\}$ or III) $\partial\mathcal{O} \times [-1, 1]$. We analyse each case separately:

I) Suppose first that p_k is in $\mathcal{O} \times \{1\}$.

Notice the topology of $\mathcal{D} \times \{1\}$ is homeomorphic to that of \mathcal{D} and it is group equivariant. Up to subsequence assume that p_k are in a sector of l' defined by $b \times \{1\}$ where b is a line leaf of l with ideal points a_1, a_2 . Then g_k is an element of type (1) and is the union

$$l_k \times \{1\} \cup \cup_j (\{w_{kj}\} \times [-1, 1])$$

where $w_{kj}, 1 \leq j \leq j_0$ are the ideal points of l_k , a leaf of \mathcal{O}^s . Notice that g_k is contained in $\mathcal{D} \times \{1\} \cup \partial\mathcal{O} \times [-1, 1]$. Assume up to subsequence that l_k are nested in \mathcal{O} . Let l'_k be $l_k \times \{1\}$. Suppose up to subsequence that g_k is not contained in V for any k . Then there are q_k in g_k with q_k not in V . Up to another subsequence assume that q_k converges to q in $\mathcal{D} \times [-1, 1]$. Suppose first that q is in $\mathcal{O} \times \{1\}$. If q is in l' , then since V is open it implies that q_k is in V for k big enough contradiction. If on the other hand q is not in l' then q is in a leaf of $\mathcal{O}^s \times \{1\}$ which is not separated from l' . This is disallowed by the no perfect fits condition, by theorem 2.6.

One other possibility is that q is in $\partial\mathcal{O} \times \{1\}$. Again if q is $(a_1, 1)$ or $(a_2, 1)$ then q is in g and hence q is in V and the above argument applies. Consider the ideal points of l_k in $\partial\mathcal{O}$. Since l_k is very near b in l , the ideal points of l_k are grouped in two collections associated to rays near the corresponding rays of b . We consider those rays which have big parts near the ray of b with ideal point a_1 . The ideal points in $\partial\mathcal{O}$ vary weakly monotonically with k .

Suppose for a moment that they do not converge to a_1 . Then they converge to c . Consider the interval (a_1, c) of $\partial\mathcal{O}$ bounded by these. Suppose first that this interval has an ideal point of a leaf e of \mathcal{O}^s or \mathcal{O}^u . Then since l_k converges to b and are all in a given side of e , it follows that l_k also converges to a leaf e_1 of \mathcal{O}^s , so that e_1 is non separated from b . This is disallowed by the non perfect fits condition. We are left with the possibility that (a_1, c) does not have an ideal point of a leaf of \mathcal{O}^s or \mathcal{O}^u . But this is impossible: let z in (a_1, c) . If z is ideal point of leaf of \mathcal{O}^s or \mathcal{O}^u we are done. Otherwise option (2) of proposition 3.29 has to occur and there is a neighborhood system of z defined by a sequence of stable leaves. This shows that any neighborhood of z has points which are ideal points of leaves of \mathcal{O}^s . Notice that option (3) of proposition 3.29 cannot occur here. These arguments show that these ideal points of l_k converge to a_1 . It follows that if q is in $\partial\mathcal{O} \times \{1\}$ then q must be $(a_1, 1)$ or $(a_2, 1)$, as desired and we are done.

The final possibility is that q is in $\mathcal{O} \times (-1, 1]$. The arguments above show that the w_{kj} are all in J_j for k big enough. This implies that q is in the same set and since this set is contained in V , this finishes the analysis in this situation (I).

The arguments above show the following result which is itself useful later on:

Lemma 4.4. *Let Φ be a simple pseudo-Anosov. Let $(l_n), n \in \mathbf{N}$ be a nested sequence of distinct leaves of \mathcal{O}^s or \mathcal{O}^u . Suppose that l_n converges to a line leaf l of \mathcal{O}^s (or \mathcal{O}^u). Then the ideal points of l_n converge to the ideal points of l .*

The next case in the proof of theorem 4.3 is:

II) Suppose that p_k is in $\mathcal{O} \times \{-1\}$.

Here g_k is contained in $(\mathcal{D} \times \{-1\}) \cup (\partial\mathcal{O} \times [-1, 1])$. Since p_k converges to p in g and g is contained in $(\mathcal{D} \times \{1\}) \cup (\partial\mathcal{O} \times [-1, 1])$, it follows that p is in $\partial\mathcal{O} \times \{-1\}$ and p is say $(a_1, -1)$, where a_1 is one of the ideal points of l .

Since a_1 is an ideal point of a ray in \mathcal{O}^s , then by proposition 3.29 there is a neighborhood system of a_1 in \mathcal{D} defined by a sequence $(r_n), n \in \mathbf{N}$ of unstable leaves. For n big enough $r_n \times \{-1\}$ is contained in V . Here g_k is of the form

$$(s_k \times \{-1\}) \cup \cup_j (\{b_{kj}\} \times [-1, 1])$$

where the s_k are leaves of \mathcal{O}^u with points converging to a_1 . By the above it follows that for k big enough $s_k \times \{-1\}$ is contained in V and the endpoints b_j have to be in J_1 for k big enough. It follows that g_k is entirely contained in V . This finishes the analysis of situation (II).

III) Suppose that p_k is in $\partial\mathcal{O} \times [-1, 1]$.

Here g_k can be type (1), (2) or (3). If g_k is of type (3) then for k big enough the g_k is contained in some $J_i \times [-1, 1]$ and hence in V . If g_k is of type (2), then as seen in II), g_k is contained in V for k big enough. If g_k is of type (1), then as seen in I), g_k is contained in V for k big enough.

This proves that V' is open. We conclude that the decomposition satisfies the upper semicontinuity property. By Moore's theorem it follows that \mathcal{R} is a sphere.

So far we have not really used the topology in $\partial\mathcal{O} \times [-1, 1]$. We still need to show that the topology of \mathcal{R} is independent of the choice of the trivialization $\partial\mathcal{O} \times [-1, 1]$ and that the fundamental group acts naturally by homeomorphisms in \mathcal{R} .

In order to see the first statement, notice that the quotient $\partial\mathcal{A}_1 = \partial(\mathcal{D} \times [-1, 1]) \rightarrow \mathcal{R}$ can be done in two steps: first collapse every vertical stalk $\{z\} \times [-1, 1]$ to a point where z is in $\partial\mathcal{O}$ and then do the remaining collapsing of leaves in $\mathcal{D} \times \{-1\}$ and $\mathcal{D} \times \{1\}$. After the first collapsing we have $\mathcal{D} \times \{1\}$ union $\mathcal{D} \times \{-1\}$ glued along the points $\{w\} \times \{-1, 1\}$. The topology now is completely determined since the topology on the top $\mathcal{D} \times \{1\}$ and the bottom $\mathcal{D} \times \{-1\}$ is completely determined by the topology in \mathcal{D} . The fundamental group acts by homeomorphisms in this object and preserves the foliations stable on the top and unstable on the bottom. Therefore the second collapse produces a sphere $\mathcal{R} = \partial\mathcal{A}_1/\mathcal{G}$. The topology in \mathcal{R} is independent of any choices. The fundamental group acts by homeomorphisms in the quotient space \mathcal{R} , since after the first collapse it acts by homeomorphisms and preserves the elements of the decomposition. This finishes the proof of the theorem 4.3. \square

We now show that the action of $\pi_1(M)$ in \mathcal{R} satisfies the uniform convergence group properties. This will allow us to show that $\pi_1(M)$ is Gromov hyperbolic and the action of $\pi_1(M)$ on \mathcal{R} is topologically conjugate to the action of $\pi_1(M)$ on its Gromov ideal boundary. First we review some basic definitions about convergence actions.

A topological space X is a *compactum* if it is a compact Hausdorff topological space. It is *perfect* if it has no isolated points. Bowditch [Bo1], following ideas of Gromov, proved that the following 2 properties topologically characterize the action of a hyperbolic group on its ideal boundary.

Theorem 4.5. (Bowditch [Bo1]) *Suppose that X is a perfect, metrisable compactum. Suppose that a group Γ acts on X , such that the induced action on the space of distinct triples is properly discontinuous and cocompact. Then Γ is a hyperbolic group. Moreover there is a natural Γ -equivariant homeomorphism of X into $\partial\Gamma$, where this last one is the Gromov ideal boundary of Γ .*

The Γ -equivariant homeomorphism $\xi : X \rightarrow \partial\Gamma$ satisfies: if f is an element of Γ and a is the attracting fixed point of the action of f in X , then $\xi(a)$ is the attracting fixed point of the action of f in $\partial\Gamma$. In our situation $X = \mathcal{R}$ and $\Gamma = \pi_1(M)$, which acts on X . The topological hypothesis on X are satisfied. We explain the action properties. Let X be a metrisable compactum and Γ a group action by homeomorphisms on X . Let $\Theta_3(X)$ be the space of distinct triples of X with topology induced from $X \times X \times X$. Then $\Theta_3(X)$ is locally compact and metrisable. There is an induced action of Γ on $\Theta_3(X)$. We say that Γ is a *convergence group action* if the action on $\Theta_3(X)$ is properly discontinuous: for any compact subset K of $\Theta_3(X)$, then the set $\{\gamma \in \Gamma \mid \gamma K \cap K \neq \emptyset\}$ is finite. The action is cocompact if $\Theta_3(X)/\Gamma$ is a compact space.

We could not verify directly whether the action of $\pi_1(M)$ on \mathcal{R} is a convergence action and is cocompact. We use an alternate form of the above theorem. The following is well known:

Proposition 4.6. ([Ge-Ma]) *Γ is a convergence group if and only if the following holds: If $(\gamma_i), i \in \mathbf{N}$ is an infinite sequence of distinct elements of Γ , then one can find points a, b in X and a subsequence $(\gamma_{i_k}), k \in \mathbf{N}$ of $(\gamma_i), i$, such that the maps $\gamma_{i_k}|X - \{a\}$ converge locally uniformly to b .*

Local uniform convergence means uniform convergence in compact sets. Notice that this is the original formulation of the notion of convergence groups by Gehring and Martin in [Ge-Ma]. Proofs of equivalences of these properties can be found in [Bo2]. Further relations with hyperbolic groups are found in Tukia [Tu1] and Freden [Fr]. Notice that it is not at all required that a, b are distinct, which in fact does not happen always: suppose that Γ is a kleinian group with a parabolic element and take for instance γ_i to be distinct powers of a fixed parabolic element.

A convergence group is *uniform* if in addition the action of Γ on $\Theta_3(X)$ is cocompact. This is associated with *conical limit points*.

Definition 4.7. (conical limit points) *Let Γ be a group action on a space X . A point z in X is a conical limit point of the action if there are distinct points a, b of X and a sequence $(\gamma_i), i \in \mathbf{N}$ in Γ such that $\gamma_i z \rightarrow a$ and $\gamma_i y \rightarrow b$ for all y in $X - \{z\}$.*

For convergence group actions, clearly the convergence of the maps $\gamma_i|X - \{z\}$ can be assumed to be locally uniform. Notice it is crucial that a, b are distinct for otherwise the convergence group property would yield the result for many points. Further discussions on conical limit points are found in [Tu2, Bo2]. We will use the following result:

Theorem 4.8. (Bowditch [Bo1]) *Suppose that X is a perfect, metrisable compactum and that Γ is a group with a convergence action on X . If every point of X is a conical limit point for the action, then Γ is a uniform convergence group (and hence Gromov hyperbolic).*

In this way, both properties concerning group actions can be checked by analysing the action on sequences of elements of Γ . In our situation the proof will use information about the action of $\Gamma = \pi_1(M)$ on the circle $\mathbf{S}^1 = \partial\mathcal{O}$ in order to obtain information about the action of Γ in \mathcal{R} . The main result is the following:

Theorem 4.9. *Let Φ be a pseudo-Anosov flow in M^3 closed so that Φ is not topologically conjugate to a suspension Anosov flow and there are no perfect fits between leaves of $\tilde{\Lambda}^s$ and $\tilde{\Lambda}^u$. Consider the induced quotient \mathcal{R} of $\partial(\mathcal{D} \times [-1, 1])$ with induced action of $\Gamma = \pi_1(M)$ in \mathcal{R} . Then Γ is a uniform convergence group. This implies that $\pi_1(M)$ is Gromov hyperbolic and the action of $\pi_1(M)$ on \mathcal{R} is naturally topologically conjugate to the action of $\pi_1(M)$ in the Gromov boundary $\partial\Gamma$.*

We split the proof of the theorem into 2 parts: We first prove that $\pi_1(M)$ acts as a convergence group in \mathcal{R} and then we show that the group action is uniform. We establish some notation which will be used throughout the proofs in this section. Recall there is a continuous quotient map $\nu : \partial(\mathcal{D} \times [-1, 1]) \rightarrow \mathcal{R}$. We can identify $\partial\mathcal{O}$ to $\partial\mathcal{O} \times \{1\}$ in $\partial\mathcal{A}_1$ and then there is an induced map:

$$\varphi : \partial\mathcal{O} \rightarrow \mathcal{R}, \quad \varphi(z) = \nu((z, 1))$$

This map φ is continuous and since every element g of \mathcal{G} contains intervals of the form $\{y\} \times [-1, 1]$ where $y \in \partial\mathcal{O}$, it follows that φ is surjective. Therefore it encodes all of the information of the map ν . In addition $\pi_1(M)$ acts in $\partial\mathcal{O}$. The map φ is group equivariant producing examples of group invariant sphere filling curves.

Remark – A very important fact is the following. Suppose that x, y distinct in $\partial\mathcal{O}$ are identified under φ , that is $\varphi(x) = \varphi(y)$. Because of the no perfect fits condition, there are no distinct leaves of $\mathcal{O}^s, \mathcal{O}^u$ sharing an ideal point in $\partial\mathcal{O}$. This implies that x, y are ideal points of the same leaf l either in \mathcal{O}^s or \mathcal{O}^u . In particular the map φ is finite to one.

Recall that $\mathcal{H}^s, \mathcal{H}^u$ are the leaf spaces of $\tilde{\Lambda}^s, \tilde{\Lambda}^u$ respectively

Notation/convention – 1) If l is a ray or leaf of \mathcal{O}^s or \mathcal{O}^u , then ∂l denotes the ideal point(s) of l in $\partial\mathcal{O}$.

2) (IMPORTANT) If γ is an element of $\pi_1(M)$ then γ acts as a homeomorphism in all of the spaces $\tilde{M}, \mathcal{O}, \partial\mathcal{O}, \mathcal{R}, \mathcal{H}^s$ and \mathcal{H}^u . For simplicity, the same notation γ will be used for all of these homeomorphisms. The context will make it clear which case is in question. With this understanding, the fact that φ is group equivariant means that for any γ in $\pi_1(M)$ then

$$\gamma \circ \varphi = \varphi \circ \gamma$$

where the first γ acts on \mathcal{R} and the second acts in $\partial\mathcal{O}$. The reader should be aware that this convention will be used throughout this section.

The next 2 lemmas show that any γ in $\pi_1(M)$, the action of γ in $\partial\mathcal{O}$ and \mathcal{R} is as expected:

Lemma 4.10. *Suppose that Φ is a nsa pseudo-Anosov flow so that there is not an infinite collection of leaves of $\tilde{\Lambda}^s$ or $\tilde{\Lambda}^u$ which are all non separated from each other. Let γ in $\pi_1(M)$ with no fixed points in \mathcal{O} . Then the action of γ in $\partial\mathcal{O}$ either has only 2 fixed points one attracting and one repelling or it has a single fixed point of parabolic type.*

Proof. This lemma is general, no assumption about perfect fits. If γ leaves invariant a leaf F in \mathcal{H}^s , then there is an orbit $\tilde{\alpha}$ in F with $\gamma(\tilde{\alpha}) = \tilde{\alpha}$. Then γ does not act freely in \mathcal{O} , contradiction.

The space \mathcal{H}^s is what is called a non Hausdorff tree [Fe10, Ro-St]. Since γ acts freely in \mathcal{H}^s then theorem A of [Fe10] implies that $\tilde{\gamma}$ has a translation axis for its action in \mathcal{H}^s . The points in the axis are exactly those leaves L of $\tilde{\Lambda}^s$ so that $\gamma(L)$ separates L from $\gamma^2(L)$. This implies that the $(\gamma^n(L)), n \in \mathbf{Z}$ form a nested collection of leaves.

The axis does not have to be properly embedded in \mathcal{H}^s . Let L be in the axis. If $(\gamma^n(L)), n \in \mathbf{N}$ does not escape compact sets in \mathcal{O} , then by the nested property, the $\gamma^n(L)$ converges to some F in $\tilde{\Lambda}^s$ as n converges to infinity. If $\gamma(F) = F$ we have an invariant leaf in $\tilde{\Lambda}^s$, contradiction. If $\gamma(F), F$ are distinct let \mathcal{B} be the set of leaves of $\tilde{\Lambda}^s$ non separated from F in the side the $\gamma^n(L)$ are limiting to. By theorem 2.6, the set \mathcal{B} is order isomorphic to either \mathbf{Z} or $\{1, \dots, n\}$ for some n . The first option is disallowed by hypothesis. Consider the second option. The transformation γ leaves \mathcal{B} invariant. If γ preserves the order in \mathcal{B} then γ will have invariant leaves in $\tilde{\Lambda}^s$, contrary to assumption. If γ

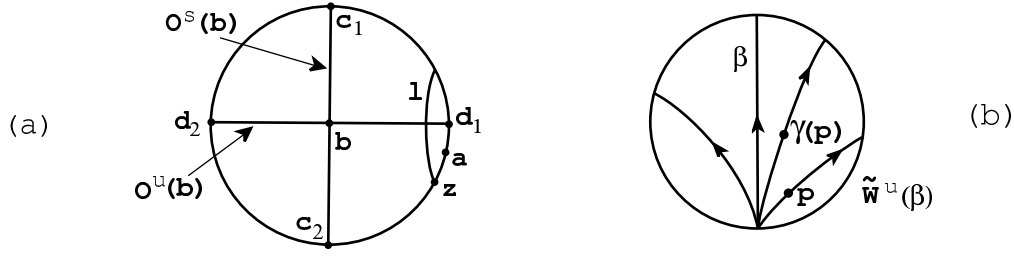

Figure 13: a. The action of γ in \mathcal{D} and $\partial\mathcal{O}$, b. Action of γ in $\widetilde{W}^u(\beta)$.

reverses order in \mathcal{B} , then there are consecutive elements F_0, F_1 in \mathcal{B} which are swapped by γ . There is a unique unstable leaf E which separates F_0 from F_1 . It makes a perfect fit with both F_0 and F_1 , see theorem 2.6. By the above this leaf E is invariant under γ again leading to a contradiction. It follows that the axis of γ is properly embedded in \mathcal{O} .

Let L_0 be in the axis of γ acting in \mathcal{H}^s . Since $\gamma(L_0)$ separates L_0 from $\gamma^2(L_0)$ then there is a unique line leaf L of L_0 so that the sector defined by L contains $\gamma(L_0)$ (of course if L_0 is non singular then L is equal to L_0). Then $(\gamma^n(\Theta(L))), n \in \mathbf{N}$ forms a nested collection of convex chains, which escapes in \mathcal{O} . It follows that this defines a unique ideal point b in $\partial\mathcal{O}$. Similarly for a possibly another line leaf V of L_0 , then $(\gamma^{-n}(\Theta(V))), n \in \mathbf{N}$ defines an ideal point a in $\partial\mathcal{O}$. Notice that

$$\gamma^n(\partial\Theta(L)) \rightarrow b \text{ as } n \rightarrow \infty \quad \text{and} \quad \gamma^n(\partial\Theta(L)) \rightarrow a \text{ as } n \rightarrow -\infty \quad (*)$$

Clearly $\gamma(a) = a$, $\gamma(b) = b$. For any other z in $\partial\mathcal{O}$, then either z is an ideal point of some $\gamma^n(L)$ or z is in an interval of $\partial\mathcal{O}$ defined by ideal points of $\gamma^n(\Theta(L))$ and $\gamma^{n+1}(\Theta(L))$ for some n in \mathbf{Z} . It follows that property (*) above also holds for z .

If a, b are distinct then the above shows that a, b form a source/sink pair for γ . If $a = b$ then γ has parabolic dynamics in $\partial\mathcal{O}$ with a its unique fixed point. This finishes the proof of the lemma. \square

Notice that if there are infinitely many leaves of $\widetilde{\Lambda}^s$ or $\widetilde{\Lambda}^u$ not separated from each other, then there are covering translations acting freely in \mathcal{O} and leaving invariant a scalloped region, see [Fe6, Fe10]. Then there will be 4 fixed points of the action of γ in $\partial\mathcal{O}$, so the hypothesis in lemma 4.10 is needed.

Lemma 4.11. *Suppose that Φ is simple. For each γ in $\pi_1(M)$, there are distinct y, x in \mathcal{R} which are the only fixed points of γ in \mathcal{R} and form a source/sink pair (y is repelling, x is attracting).*

Proof. As with almost all the proofs in this section, the proof will be a strong interplay between the pseudo-Anosov dynamics action in $\partial\mathcal{O}$ and the induced action in \mathcal{R} . Recall that the only identifications of the map φ come from the ideal points of leaves of \mathcal{O}^s or \mathcal{O}^u .

Any γ in $\pi_1(M)$ has at most one fixed point in \mathcal{O} : if γ fixes 2 points in \mathcal{O} , then it produces 2 closed orbits of Φ which are freely homotopic to each other (or maybe freely homotopic to the inverse of each other or certain powers). By theorem 2.5, the lifts of the closed orbits are connected by a chain of lozenges and this produces perfect fits in the universal cover – disallowed by hypothesis.

Suppose first that γ is associated to a periodic orbit of Φ – singular or not - γ need not be an indivisible closed orbit, it may be the same closed orbit traversed a few times. Let β orbit of $\widetilde{\Phi}$ with $\gamma(\beta) = \beta$ and $b = \Theta(\beta)$ be the single fixed point of γ in \mathcal{O} . Suppose without loss of generality that γ is associated to an orbit of Φ being traversed in the forward direction. We will show that the set of fixed points of γ (or a power of γ) in $\partial\mathcal{O}$ is the union $\partial\mathcal{O}^s(b) \cup \partial\mathcal{O}^u(b)$, the first set is attracting for γ and $\mathcal{O}^u(b)$ is the set of repelling fixed points of γ .

Assume first that γ leaves invariant the sides of $\mathcal{O}^u(b)$ and $\mathcal{O}^s(b)$ and that γ is non singular. Let c_1, c_2 in $\partial\mathcal{O}$ be the ideal points of $\mathcal{O}^s(b)$ and d_1, d_2 the ideal points of $\mathcal{O}^u(b)$, see fig. 13, a.

Notice that $\varphi(c_1) = \varphi(c_2)$ and similarly $\varphi(d_1) = \varphi(d_2)$. Let $x = \varphi(c_1), y = \varphi(d_1)$.

Clearly γ fixes c_1, c_2, d_1, d_2 . Let I be the interval of $\partial\mathcal{O}$ with endpoints c_1, d_1 and not containing d_2 . Let a be a point in the interior of I . Since there are no perfect fits, then d_1 has a neighborhood system in \mathcal{D} formed by stable leaves, all of which have to intersect $\mathcal{O}^u(b)$. Then there is a stable leaf l intersecting $\mathcal{O}^u(b)$ and with one ideal point z , so that z is in I and separates a from c_1 in I .

The action of γ in the set of orbits of $\widetilde{W}^u(\beta)$ is contracting, see fig. 13, b. Therefore $\gamma^n(l)$ converges to $\mathcal{O}^s(b)$ as n converges to infinity. It follows that $\gamma^n(z)$ converges to c_1 and so $\gamma^n(a)$ converges to c_1 . This shows that γ has only 2 fixed points in I and d_1 is repelling, c_1 is attracting. The other intervals of $\partial\mathcal{O}$ defined by $\partial\mathcal{O}^s(b) \cup \partial\mathcal{O}^u(b)$ are treated in the same fashion.

We claim that y, x form the source/sink pair for the action of γ in \mathcal{R} . Here

$$\gamma(x) = \gamma(\varphi(c_1)) = \varphi(\gamma(c_1)) = \varphi(c_1) = x$$

and similarly γ fixes y . For any other w in \mathcal{R} there is z in $\mathcal{O} - \{c_1, c_2, d_1, d_2\}$ with $w = \varphi(z)$. Without loss of generality assume that z is in I . Then $\gamma^n(z)$ converges to c_1 and

$$\gamma^n(w) = \gamma^n(\varphi(z)) = \varphi(\gamma^n(z)) \rightarrow \varphi(c_1) = x$$

Similarly $\gamma^n(w) \rightarrow y$ when $n \rightarrow -\infty$. So if γ leaves invariant the components of $\partial\mathcal{O} - \{c_1, c_2, d_1, d_2\}$ then y, x for a source/sink pair for the action of γ in \mathcal{R} .

In the general case take a power of γ so that in $\partial\mathcal{O}$ it fixes all points in $\partial\mathcal{O}^s(b), \partial\mathcal{O}^u(b)$ and preserves orientation in $\partial\mathcal{O}$. Then apply the above arguments. The arguments show that, as a set, $\partial\mathcal{O}^s(b)$ is invariant and attracting for the action of γ in $\partial\mathcal{O}$ and $\partial\mathcal{O}^u(b)$ is invariant and repelling for the action. All the points in $\partial\mathcal{O}^s(b)$ are mapped to x by φ and all points in $\partial\mathcal{O}^u(b)$ are mapped to y . Hence y, x is the source/sink pair for the action of γ in \mathcal{R} . This finishes the analysis of the case when γ does not act freely in \mathcal{O} .

We now analyse the case that γ acts freely in \mathcal{O} . We apply the previous lemma which produces a, b . Suppose first that $a = b$. Let L be a line leaf in the axis of γ acting in \mathcal{H}^s as in the lemma. Then $L, \gamma(L)$ both have rays with same ideal point a in $\partial\mathcal{O}$. By lemma 3.16 this rays are equivalent and hence connected by a chain of perfect fits. This is disallowed by hypothesis.

Hence a, b are distinct and by the previous lemma they form the source/sink pair for the action of γ in $\partial\mathcal{O}$. For any L in the axis of the action of γ in \mathcal{H}^s and $l = \Theta(L)$, then the ideal points of $\mathcal{O}^s(l)$ weakly separate a from b in $\partial\mathcal{O}$. It follows that a, b are not ideal points of a leaf of \mathcal{O}^s or \mathcal{O}^u . Then $\varphi(a), \varphi(b)$ are different. Then the source/sink property for the action of γ in $\partial\mathcal{O}$ immediately translates into a source/sink property for the action of γ in \mathcal{R} with source $\varphi(a)$ and sink $\varphi(b)$.

This finishes the proof of the lemma. □

We now prove the first part of theorem 4.9.

Theorem 4.12. *Suppose that Φ is simple. Then $\pi_1(M)$ acts on \mathcal{R} as a convergence group.*

Proof. Let γ_i be a sequence of distinct elements of Γ . Up to subsequence we can assume that either

- 1) each γ_i is associated to a singular closed orbit of Φ ;
- 2) each γ_i is associated to a non singular closed orbit of Φ ;
- 3) each γ_i is not associated to a closed orbit of Φ .

Notice that 3) is equivalent to γ_i acts freely in the orbit space \mathcal{O} . There is some similarity between cases 1) and 2) which will be explored as we go along the proof.

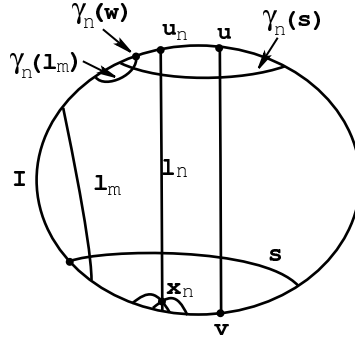

Figure 14: *The case of line leaves converging to a limit.*

Case 1 – Suppose the γ_i are all associated to singular orbits of the flow Φ .

Let α_i be orbits of Φ with $\gamma_i(\alpha_i) = \alpha_i$. Since there are only finitely many singular orbits of Φ , we may assume up to subsequence that all the orbits $\pi_1(\alpha_i)$ are the same singular orbit of Φ . Without loss of generality we may assume that γ_i are associated to (say) the positive flow direction of α_i , that is, if p_i in α_i then $\gamma_i(p_i) = \tilde{\Phi}_{t_i}(p_i)$ with t_i bigger than zero.

This first case shows clearly that the action of $\pi_1(M)$ in $\partial\mathcal{O}$ is not a convergence group action. If γ is associated to a singular orbit and $\gamma(x) = x$ with x in \mathcal{O} then some power of γ has at least 6 fixed points in $\partial\mathcal{O}$ – if that power leaves invariant all the prongs in $\mathcal{O}^s(x), \mathcal{O}^u(x)$. If the orbit is non singular there will be 4 fixed points in $\partial\mathcal{O}$. Then infinitely many powers of γ will have at least 4 fixed points in \mathcal{O} and the action in $\partial\mathcal{O}$ is not a convergence group action.

Let $x_i = \Theta(\alpha_i)$ and $l_i = \mathcal{O}^s(x_i)$. Suppose first that l_i does not escape compact sets in \mathcal{O} . It could be that up to subsequence, l_i is constant. This means that there is γ in $\pi_1(M)$ so that $\gamma_i = \gamma^{n_i}$ and $|n_i|$ converging to ∞ . By the previous lemma there is a source/sink pair for the sequence (γ_i) .

The second option is that up to subsequence all l_i are distinct and converge to a line leaf l of \mathcal{O}^s . Up to subsequence assume the l_i are nested and all in a fixed sector of l . Let u, v be the ideal points of l . Notice that as l_i is singular then it has 3 or more ideal points in $\partial\mathcal{O}$.

Claim 1 – There is an ideal point of l (say) v so that all ideal points of l_i except for one converge to v . The remaining ideal point of l_i converges to u .

Otherwise up to subsequence there are at least 2 ideal points u_i^1, u_i^2 of l_i converging to u and likewise to v . Let x_i be the singular point of l_i . There is at least one prong of $\mathcal{O}^u(x_i)$ with an ideal point in $\partial\mathcal{O}$ between u_i^1, u_i^2 very near u and similarly a prong with ideal point very near v . Together this produces a slice s_i of $\mathcal{O}^u(x_i)$ with one ideal point near u and one ideal point near v . The sequence $(s_i), i \in \mathbf{N}$ is nested and is bounded by l . Hence it converges to a leaf s of \mathcal{O}^u . By lemma 4.4 the ideal points of s_i converge to the ideal points of s and hence s has ideal points u, v . But u is also an ideal point of the line leaf l of \mathcal{O}^s . Since there are no perfect fits, no leaves of $\mathcal{O}^s, \mathcal{O}^u$ share an ideal point. This proves claim 1.

Since at least 2 ideal points of $\mathcal{O}^s(x_i)$ converge to v (as $i \rightarrow \infty$) and ideal points of $\mathcal{O}^s(x_i), \mathcal{O}^u(x_i)$ alternate in $\partial\mathcal{O}$, then at least one ideal point of $\mathcal{O}^u(x_i)$ converges to v as $i \rightarrow \infty$. Suppose for a moment that not all endpoints of $\mathcal{O}^u(x_i)$ converge to v . Then up to subsequence assume one of the endpoints converges to w distinct from v . If the $\mathcal{O}^u(x_i)$ escapes compact sets in \mathcal{O} , then there is an interval in $\partial\mathcal{O}$ defined by v, w which contains no ideal points of leaves of \mathcal{O}^u . As seen before this is disallowed. The other option is that up to subsequence the $\mathcal{O}^u(x_i)$ converges to a leaf δ of \mathcal{O}^u . By lemma 4.4 the ideal points of $\mathcal{O}^u(x_i)$ converge to the ideal point of δ and hence δ has one ideal point v . But u is also an ideal point of line leaf l of \mathcal{O}^s . Since there are no perfect fits, this is disallowed.

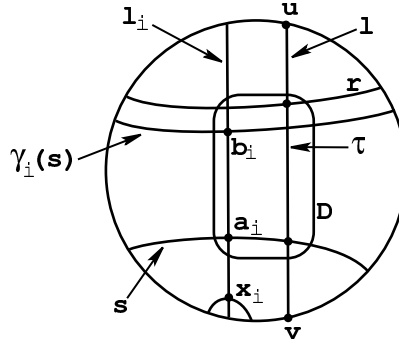

Figure 15: *a. The case when $\gamma_i(s)$ converges to a leaf r .*

We conclude that all ideal points of $\mathcal{O}^u(x_i)$ converge to v .

Let Z_i be the component of $\partial\mathcal{O} - \partial\mathcal{O}^u(x_i)$ which contains u . This is the only component which is big, all the other ones converge to v as $i \rightarrow \infty$. The Z_i are converging to $\partial\mathcal{O} - \{v\}$. Let u_i be the ideal point of $\mathcal{O}^u(x_i)$ very close to u .

Suppose first up to subsequence that $\gamma_i(Z_i)$ is not equal to Z_i for all i . Then $\gamma_i(Z_i)$ is an arbitrary small interval very close to v . This shows that $\gamma_i|(\partial\mathcal{O} - v)$ converges locally uniformly to v and so in \mathcal{R} it follows that $\gamma_i|(\mathcal{R} - \varphi(v))$ converges locally uniformly to $\varphi(v)$.

So we assume from now on that $\gamma_i(Z_i) = Z_i$ for all i and hence $\gamma_i(u_i) = u_i$. As the γ_i are associated to positive direction of the flow then the ideal points of l_i are attracting for the action of γ_i in $\partial\mathcal{O}$ (lemma 4.11).

Claim 2 – In this case $\gamma_i|(\partial\mathcal{O} - v)$ converges locally uniformly to u .

This claim has a long proof. Since v is an ideal point of a leaf of \mathcal{O}^s and Φ has no perfect fits then v has a neighborhood basis defined by unstable leaves. So it suffices to show that for fixed unstable leaf s intersecting l , then the endpoints of s converge to u under γ_i . Assume for simplicity that s is non singular. Let w be the ideal point of s in the side of l that the l_i are limiting to, see fig. 14. Let m so big that l_m is very close to l and hence u_m is very close to u . The m is chosen so that s separates $\mathcal{O}^u(x_m)$ from u . Let n much bigger than m with l_n closer to l . Let J_1 be the interval of $\mathcal{O} - \{u, v\}$ containing w and let J_2 the other one.

Suppose first that up to subsequence γ_i leaves the sectors of l_i invariant. By construction all the ideal points of l_m are in a single component I of $\partial\mathcal{O} - (\partial\mathcal{O}^u(x_n) \cup \partial\mathcal{O}^s(x_n))$. The fact that will be used here is that $\gamma_n(l_m)$ and l_m are distinct and therefore their ideal point sets cannot be linked in $\partial\mathcal{O}$. By lemma 4.11 the dynamics of γ_n in I is simple with an attracting fixed point u_n and a repelling fixed point in $\partial\mathcal{O}^u(x_n)$. It follows that all the ideal points of $\mathcal{O}^s(x_m)$ are attracted towards u_n under γ_n . Since there is an ideal point very near v (because l_m is very near l) it follows that $\gamma_n(w)$ is very near u . Hence the whole interval $J_1 - \{v\}$ is getting attracted to u under γ_n as we expected.

Let w' be the other ideal point of s . If $\gamma_i(w')$ does not converge to u then up to subsequence $\gamma_i(s)$ has one ideal point converging to u and another converging to a different point. As seen above this leads to an unstable leaf with ideal point u , which is disallowed. We conclude that $\gamma_i|(\partial\mathcal{O} - v)$ converges locally uniformly to u .

The second option is that up to subsequence the sectors of l_i are not invariant under γ_i . Notice that $\gamma_i(s)$ intersects l_i . If one endpoint of $\gamma_i(s)$ converges to u (as $i \rightarrow \infty$), then as seen above the other endpoint of $\gamma_i(s)$ also needs to converge to u and so $\gamma_i|(\partial\mathcal{O} - \{v\})$ converges locally uniformly to u as desired.

The remaining case is up to subsequence $\gamma_i(s)$ converges to a leaf r of \mathcal{O}^u . This leaf r cannot have ideal point u and hence has to intersect l . Let τ be the segment of l between s and r and D_0 a neighborhood of it in \mathcal{O} . Let D be the image of a smooth section $c_1 : D_0 \rightarrow \widetilde{M}$ of Θ restricted to D_0 . Recall α_i with $\gamma_i(\alpha_i) = \alpha_i$. Φ . Then $\widetilde{W}^s(\alpha_i) \cap D$ are segments of bounded length. Let

$$p_i = \widetilde{W}^s(\alpha_i) \cap D \cap (s \times \mathbf{R}), \quad a_i = \Theta(p_i), \quad b_i = \Theta(\gamma_i(p_i)).$$

In D we have a segment r_i of bounded length from $\widetilde{\Phi}_{\mathbf{R}}(p_i)$ to a point in $\gamma_i(\widetilde{\Phi}_{\mathbf{R}}(p_i))$. This is a segment in a stable leaf which contracts in positive flow direction. Flow forward p_i by time t_i until it is distance 1 from α_i along $\widetilde{W}^s(\alpha_i)$. Notice that p_i is far from α_i for i big since x_i escapes compact sets in \mathcal{O} . The segment r_i flows to a segment of arbitrary small length under $\widetilde{\Phi}_{t_i}$ since r_i has bounded length and t_i is very big. This is a contradiction: the endpoints of $\widetilde{\Phi}_{t_i}(r_i)$ both project in M to the same orbit in $W^s(\beta)$ and hence cannot be too close since the point $\pi(\widetilde{\Phi}_{t_i}(p_i))$ is distance 1 from β in $W^s(\beta)$. They could only be very close if their time distance in the orbit is very small. That is not the case. We conclude that this cannot happen.

It follows that $\gamma_i(s)$ cannot converge to a leaf intersecting l and so as seen before, $\gamma_i(s)$ converges to u in \mathcal{D} and the endpoints of $\gamma_i(s)$ also do. This proves claim 2.

This completes the analysis when the $l_i = \mathcal{O}^s(x_i)$ does not escape compact sets in \mathcal{O} . There is a similar proof when $\mathcal{O}^u(x_i)$ does not escape compact sets. Hence we can assume that $\mathcal{O}^s(x_i), \mathcal{O}^u(x_i)$ escape compact sets in \mathcal{O} and up to subsequence all ideal points of $\mathcal{O}^s(x_i), \mathcal{O}^u(x_i)$ converge to the point v of $\partial\mathcal{O}$.

We can assume that v has a neighborhood basis defined by (say) stable leaves. Given a compact set C in $\partial\mathcal{O} - v$ let s be a stable leaf with ideal points very close to v and separating v from C in \mathcal{D} . For i big enough all the ideal points of $\mathcal{O}^s(x_i), \mathcal{O}^u(x_i)$ are separated from C by ∂s . Then s is contained in a single interval of $\partial\mathcal{O} - (\partial\mathcal{O}^s(x_i) \cup \partial\mathcal{O}^u(x_i))$ where γ_i does not have fixed points. If γ_i leaves this interval invariant then since $\gamma_i(s)$ does not intersect s transversely, then $\gamma_i(s)$ has both ideal points closer to v than those of s and so $\gamma_i(C)$ is very close to v in \mathcal{D} . If γ_i does not leave that interval invariant then as seen above $\gamma_i(C)$ is also very close to C .

As s is arbitrary this shows $\gamma_i(C) \rightarrow v$ uniformly. Therefore in \mathcal{R} it follows that $\gamma_i|(\partial\mathcal{O} - \varphi(v))$ converges locally uniformly to $\varphi(v)$.

This finishes the analysis when γ_i is associated to singular orbits.

Case 2 – γ_i is associated to non singular periodic orbits.

This is very similar to case 1 and we can use a lot of the previous analysis. Here we will use the following fact, which is a uniform statement that orbits in leaves of Λ^u are backwards asymptotic:

Fact – Let Φ be a pseudo-Anosov flow in M^3 . For each $a_0 \geq 0$ and $\epsilon > 0$ there is time $t_0 > 0$ so that if p, z are in the same leaf of $\widetilde{\Lambda}^u$ and there is a path δ in $\widetilde{W}^u(p)$ transverse to the flow lines and with length bounded above by a_0 , then there is a path from $\widetilde{\Phi}_t(p)$ to $\widetilde{\Phi}_{\mathbf{R}}(z)$ in $\widetilde{W}^u(p)$ of length less than ϵ for all $t \leq -t_0$.

Equivalently the orbits $\widetilde{\Phi}_{\mathbf{R}}(p), \widetilde{\Phi}_{\mathbf{R}}(z)$ are ϵ close to each other backwards of $\widetilde{\Phi}_{-t_0}(p)$. This is proved in pages 486-487 of [Fe9]. Notice it is not at all implied that $\widetilde{\Phi}_{-t_0}(p)$ and $\widetilde{\Phi}_{-t_0}(z)$ are ϵ -close, which may not be true since p, z may be out of phase.

Let x_i in \mathcal{O} with $\gamma_i(x_i) = x_i$. If either $\mathcal{O}^u(x_i)$ or $\mathcal{O}^s(x_i)$ escapes in \mathcal{O} then a proof exactly as in the singular case yields the result. So assume that x_i converges to x . If $x_i = x$ for infinitely many i then lemma 4.11 finishes the proof. So we may assume up to subsequence that x_i are all non singular, distinct from each other and all in the same sectors of $\mathcal{O}^s(x)$ and $\mathcal{O}^u(x)$. This did not occur in the

previous case because the set of singular points in \mathcal{O} is a discrete subset of \mathcal{O} . Assume wlog up to subsequence that γ_i is associated to positive flow direction in α_i . Hence $\partial\mathcal{O}^s(x_i)$ is the attracting fixed point set for γ_i and $\partial\mathcal{O}^u(x_i)$ is the repelling fixed point set for the action of γ_i on $\partial\mathcal{O}$.

We will show that $\partial\mathcal{O}^u(x), \partial\mathcal{O}^s(x)$ forms a source/sink set for the sequence γ_i acting in $\partial\mathcal{O}$. Then $a = \varphi(\partial\mathcal{O}^u(x)), b = \varphi(\partial\mathcal{O}^s(x))$ forms a source/sink pair for the sequence γ_i acting in \mathcal{R} . For simplicity assume that γ_i preserves the components of $\mathcal{O}^s(x_i), \mathcal{O}^u(x_i)$. A similar proof works in the general case.

Let $\alpha_i = \{x_i\} \times \mathbf{R}$ and $\pi(\alpha_i)$ closed orbits of Φ . Assume all $\pi(\alpha_i)$ are distinct. Let v a point of $\partial\mathcal{O}^u(x)$. For any small neighborhood A of v in \mathcal{D} find l non singular stable leaf intersecting $\mathcal{O}^u(x)$ and contained in A . As $\mathcal{O}^u(x_i)$ converges to (a line leaf in) $\mathcal{O}^u(x)$ then for i big enough $\mathcal{O}^u(x_i)$ intersects l and has an ideal point v_i near v . Since v_i is a repelling fixed point for γ_i then $\gamma_i(l)$ is closer to $\mathcal{O}^s(x_i)$ than l is. Here $\mathcal{O}^s(x_i)$ is close to $\mathcal{O}^s(x)$ as well. Let $L_i = \gamma_i(l) \times \mathbf{R}$, a leaf of Λ^s .

The fact that is going to be used here is that the lengths of the periodic orbits $\pi(\alpha_i)$ converge to infinity, which occurs because they are all distinct orbits. Draw a disk D transverse to $\tilde{\Phi}$ containing segments r_i in $\tilde{W}^s(\alpha_i)$ from p_i in α_i to

$$z_i = (l \times \mathbf{R}) \cap \tilde{W}^s(p_i) \cap D$$

and r_i transverse to $\tilde{\Phi}$ in $\tilde{W}^s(\alpha_i)$. We can assume the r_i converges to r , a segment in $\tilde{W}^s(p)$ and so have length uniformly bounded above. Consider $\gamma_i(r_i)$ which are segments of length bounded above, connecting $\gamma_i(p_i)$ to $\gamma_i(z_i)$. Notice that $\gamma_i(z_i)$ is in L_i . Choose

$$t_i \in \mathbf{R} \text{ with } \gamma_i(p_i) = \tilde{\Phi}_{t_i}(p_i). \text{ Then } t_i \rightarrow \infty \text{ and } p_i = \tilde{\Phi}_{-t_i}(\gamma_i(p_i))$$

By the fact above there are segments from p_i to $\tilde{\Phi}_{\mathbf{R}}(\gamma_i(z_i))$ in $\tilde{W}^s(p_i)$ with length converging to 0 as $i \rightarrow \infty$. As the p_i are converging to a point p in $\{x\} \times \mathbf{R}$, this shows that $\gamma_i(l)$ is converging to (a line leaf of) $\mathcal{O}^s(x)$.

This shows that $\partial\mathcal{O}^u(x)$ is the repelling fixed point set for γ_i and $\partial\mathcal{O}^s(x)$ is the attracting set. This finishes the analysis of case 2.

Case 3 – All the γ_i act freely in \mathcal{O} .

By lemmas 4.10 and 4.11 the γ_i acts in $\partial\mathcal{O}$ with only two fixed points v_i, u_i forming a source/sink pair. Assume up to subsequence that u_i converges to u and v_i converges to v in $\partial\mathcal{O}$. It may be that u is equal to v . Ideally we would like to show that $\gamma_i|(\partial\mathcal{O} - v)$ converges locally uniformly to u . Very surprisingly this is not true in general, see the counterexample after the end of the proof. If on the other hand $\gamma_i|(\partial\mathcal{O} - v)$ converges locally uniformly to u then we are done since then in \mathcal{R} , $\gamma_i|(\mathcal{R} - \varphi(v))$ converges locally uniformly to $\varphi(u)$.

Assume wlog that v has a neighborhood system defined by stable leaves and let l be a stable leaf with ideal points near v , separating it from u . If for any such l the endpoints of $\gamma_i(l)$ (some subsequence) converge to u then we are done.

Suppose then up to subsequence that $\gamma_i(l)$ converges to l_0 . We may assume that the sequence $(\gamma_i(l))$ is nested. Let W be the region in \mathcal{O} bounded by l with ideal point v . There are 2 possibilities.

Case 3.1 – The point v is not an ideal point of a leaf of \mathcal{O}^u .

Then there is a neighborhood system of v defined by unstable leaves as well. Let $\partial l = \{a_1, a_2\}$. Look at the unstable leaves s intersecting l . If l is close to v then so are all the possible s as above, for otherwise taking limits as l approaches v , one produces an unstable leaf with ideal point v , contrary to assumption. In the same way if $s \cap l$ is near a_1 in \mathcal{D} then s is near a_1 in \mathcal{D} and has an ideal point near a_1 . Similarly if $s \cap l$ is near a_2 in \mathcal{D} then s is near a_2 in \mathcal{D} . It follows that there is a

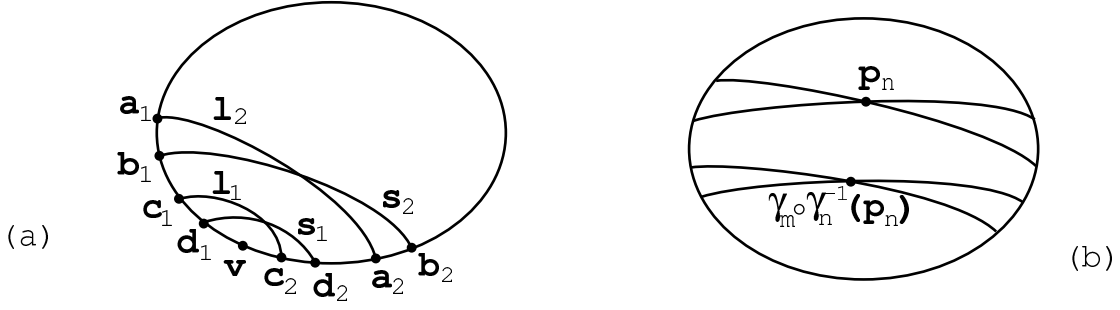

Figure 16: a. Set up in \mathcal{O} , b. Producing fixed points.

unique unstable leaf s' intersecting l so that it has at least 2 prongs going into W and enclosing v . That means that if b'_1, b'_2 are the ideal points of these 2 prongs then a_1, b'_1, v, b'_2, a_2 are all distinct and circularly ordered in $\partial\mathcal{O}$. There is then one prong of s' exiting W so that together with a prong inside W it defines a small neighborhood of v . The union of these two prongs is a slice s_1 in s' . Let $\partial s = \{b_1, b_2\}$ with b_1 an ideal point of W . Let $l_1 = l$. Redo the process to obtain a leaf l_2 of \mathcal{O}^s and a slice s_2 of \mathcal{O}^u which are closer to v . Let $\partial l_2 = \{c_1, c_2\}$ and $\partial s_2 = \{d_1, d_2\}$. We can arrange the construction so that $a_1, b_1, c_1, d_1, v, c_2, d_2, a_2, b_2$ are all distinct and circularly ordered in $\partial\mathcal{O}$, see fig. 16, a.

Then $\gamma_i(l_2), \gamma_i(s_2)$ does not escape to u , because they are bounded by l_0 . Let $j = 1, 2$. We may assume that $\gamma_i(l_j)$ converges to l'_j and $\gamma_i(s_j) \rightarrow s'_j$, as $i \rightarrow \infty$ for $j = 1, 2$. Because of the set up of the ideal points as above then l'_1 has no common ideal point with l'_2 . If for instance $\lim \gamma_i(a_1) = \lim \gamma_i(c_1)$ then it is also equal to $\lim \gamma_i(b_1)$ and one produces one unstable leaf sharing an ideal point with a stable leaf. It follows that all four limits of ideal points are distinct. Fix n very big and let $m \gg n$ very big. Since $\gamma_m(l_1), \gamma_n(l_1)$ are both very near l'_1 and $\gamma_m(s_1), \gamma_n(s_1)$ are very near s'_1 then

$$\gamma_m(l_1 \cap s_1) \text{ is very near } \gamma_n(l_1 \cap s_1) = p_n$$

Or $\gamma_m \circ \gamma_n^{-1}(p_n)$ is very near p_n , see fig. 16, b. Since γ_m, γ_n are distinct, the shadow lemma for pseudo-Anosov flows [Han, Man] implies that $\gamma_m \circ \gamma_n^{-1}$ has a fixed point very near p_n . Similarly there is a fixed point of $\gamma_m \circ \gamma_n^{-1}$ near $q_n = \gamma_n(l_2 \cap s_2)$. Since $l'_1 \cap s'_1, l'_2 \cap s'_2$ are different, it follows that for n, m sufficiently big then these two fixed points are different. But then $\gamma_m \circ \gamma_n^{-1}$ would have two distinct fixed points in \mathcal{O} – which is disallowed by the no perfect fits condition. This cannot happen. Therefore $\gamma_i(l)$ converges to u and this finishes the analysis of case 3.1.

Case 3.2 – Suppose that v is an ideal point of a leaf s of \mathcal{O}^u .

In this case we do not necessarily obtain that $\gamma_i|(\partial\mathcal{O} - v)$ converges locally uniformly to u . Suppose l is non singular. Assume as before that $\gamma_i(l)$ converges to a line leaf l^* of a leaf l_0 of \mathcal{O}^s . Let l' be any stable leaf intersecting s and closer to v than l is. Suppose for a moment that up to subsequence $\gamma_i(l')$ converges to l'_0 different from l_0 . Then l_0, l'_0 do not share an ideal point – because of the no perfect fits hypothesis. Since $\gamma_i(s)$ intersects $\gamma_i(l), \gamma_i(l')$ and $\gamma_i(l), \gamma_i(l')$ converge to l_0, l'_0 not sharing an ideal point then $\gamma_i(s)$ cannot escape in \mathcal{O} . Otherwise one produces an interval in $\partial\mathcal{O}$ without ideal points of \mathcal{O}^u , contradiction.

Hence assume $\gamma_i(s)$ converges to a leaf s_1 of \mathcal{O}^u . Notice that s_1 intersects l_0 and l'_0 for otherwise s_1 will share ideal point with at least one of l_0, l'_0 , disallowed by the no perfect fits condition. Therefore $\gamma_i(l \cap s)$ converges to $l_0 \cap s_1$ and $\gamma_i(l' \cap s)$ converges to $l'_0 \cap s_1$. As seen before, if n, m are big enough this produces 2 distinct fixed points of $\gamma_m \circ \gamma_n^{-1}$ – one near $l_0 \cap s_1$ and one near $l'_0 \cap s_1$. This is disallowed.

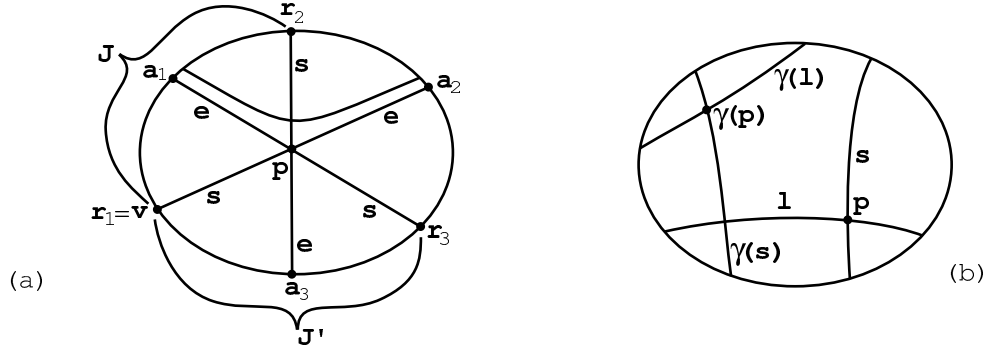

Figure 17: a. Trapping the orbits in the singular case ($n = 3$), b. An interesting counterexample.

Therefore $\gamma_i(l')$ also converges to l^* . Let w, w' be the ideal point of l^* . Let z, z' be the ideal points of l . Let I, I' be the disjoint half open intervals of $\partial\mathcal{O}$ with one ideal point in z, z' and the other in v . Suppose $\gamma_i(z)$ converges to w . The arguments above shows that $\gamma_i(I)$ converges locally uniformly to w and $\gamma_i(I')$ converges to w' . Using the no perfect fits condition we will little by little upgrade this to show that $\gamma_i|(\partial\mathcal{O} - \partial s)$ converges locally uniformly to ∂l_0 – this last one is a set, not a single point.

Consider an arbitrary unstable leaf s' intersecting l , with $s' \neq s$. Then s' has an ideal point either in I or in I' . If it has an ideal point in I then that ideal point converges to w by iteration under γ_i and since no unstable leaf has ideal point w then $\gamma_i(s')$ converges to w in \mathcal{D} . Let now $J (J')$ be the component of $(\partial\mathcal{O} - \partial s)$ containing $z (z')$ (hence $I \subset J, I' \subset J'$). The above argument shows that $\gamma_i(J)$ converges locally uniformly to w , $\gamma_i(J')$ converges to w' .

If s is non singular then we are done. This is because if v, t are the ideal points of s , then $\varphi(v) = \varphi(t)$ and let this be y . Then $\varphi^{-1}(y) = \{v, t\}$. For any compact set C in $\mathcal{R} - y$ there is a compact set V in $\partial\mathcal{O} - \{v, t\}$ with $C \subset \varphi(V)$, since $\varphi^{-1}(y) = \{v, t\}$. We can assume that V is a union of 2 compact intervals V_1, V_2 in $\partial\mathcal{O} - \{v, t\}$ so up to reordering $V_1 \subset J$ and $V_2 \subset J'$. Hence

$$\gamma_i | V_1 \text{ converges to } w \quad \text{and} \quad \gamma_i | V_2 \text{ converges to } w'.$$

Notice $\varphi(w) = \varphi(w')$ and let this be x . This shows that in \mathcal{R} , $\gamma_i|C$ converges uniformly to x . Hence y, x is the source/sink pair for γ_i . With more analysis one can show that u is not an ideal point of s and u is an ideal point of l_0 (then $w = u$). We do not provide the arguments as we will not use that.

Suppose from now on that s is singular with n prongs. Let $r_1 = v$, r_2 the other endpoint of J which is an ideal point of s not equal to v and r_n the similar endpoint of J' . In $\partial\mathcal{O}$, $\gamma_i | J \rightarrow w$ and $\gamma_i | J' \rightarrow w'$. Complete the ideal points of s circularly to r_1, \dots, r_n . Let p be the singular point in s , see fig. 17, a. Let e be the stable leaf through p . Then e has a prong with ideal point a_1 in J and one with ideal point a_n in J' . Order the other endpoints of e as a_1, \dots, a_n . Let e^* be the line leaf of e with ideal points a_1, a_n .

Suppose first that $\gamma_i(p)$ does not escape in \mathcal{O} . Up to subsequence it stays in a compact region of \mathcal{O} and converges so assume that $\gamma_i(p) = p_0$ for $i \geq i_0$. Let f be the generator of the isotropy group of p_0 fixing also the points in $\partial\mathcal{O}^s(p_0)$ and f associated to the forward direction in the orbit $\{p_0\} \times \mathbf{R}$. Since $\gamma_i(a_1)$ converges and is contained in $\partial\mathcal{O}^s(p_0)$ then for i sufficiently bigger than i_0 :

$$\gamma_i = f^{m_i} \circ \gamma_{i_0}$$

where m_i is an integer. Since the interval $\gamma_i(J)$ converges to w then w is an attracting point, so m_i converges to $+\infty$. After one applies γ_{i_0} then only positive powers of f , hence the arguments of lemma

4.11 imply that for any compact set C in $\partial\mathcal{O} - \partial s$ then $\gamma_i(C)$ is in a small neighborhood of $\partial\mathcal{O}^s(p_0)$. All points of ∂s are identified under φ and similarly for $\partial\mathcal{O}^s(p_0)$. Let $y = \varphi(\partial s)$, $x = \varphi(\partial\mathcal{O}^s(p_0))$. Then in \mathcal{R} , $\gamma_i|(\mathcal{R} - y)$ converges locally uniformly to x . This finishes the argument in this case.

Now suppose that $\gamma_i(p)$ escapes in \mathcal{O} . Since $\gamma_i(e^*)$ converges to l^* and $\gamma_i(p)$ is in $\gamma_i(l^*)$ then $\gamma_i(p)$ converges to either w or w' . Suppose without loss of generality that $\gamma_i(p)$ converges to w . Then $\gamma_i(a_n)$ converges to w' and all the ideal points a_1, \dots, a_{n-1} converge to w under γ_i . Otherwise one produces another stable leaf sharing an ideal point with l_0 , as shown in the argument of case 1.

Let J_2 be the interval of $\partial\mathcal{O}$ bounded by $v (= r_1)$ and r_n and disjoint from J' . If A is the region of J_2 between a_{n-1} and r_n then $\gamma_i(J_2 - A)$ converges to w . This occurs because the $\gamma_i(a_j)$ converge to w , $1 \leq j \leq n-1$ and γ_i acts as a homeomorphism in $\partial\mathcal{O}$. The non singular unstable leaves s' intersecting $\mathcal{O}^s(p)$ in the prong with ideal point r_{n-1} have one with ideal point in A and another ideal point in $J_2 - A$. As seen in the beginning of case 3.2 the ideal points of s' have to converge to w under γ_i . Hence $\gamma_n(J_2)$ converges locally uniformly to w . As $\gamma_i(J'_1)$ converges to w' then

$$\gamma_i | (\partial\mathcal{O} - \partial s) \text{ converges locally uniformly to } \{w, w'\}.$$

If $y = \varphi(\partial s)$ and $x = \varphi(w)$ then y, x is the source/sink pair for the sequence γ_i acting in \mathcal{R} . This finishes case 3.2.

This shows that $\pi_1(M)$ acts as a convergence group in \mathcal{R} and finishes the proof of theorem 4.12. \square

Remark – We construct an example as in case 3.2 where the sequence $(\gamma_i), i \in \mathbf{N}$ does not have source/sink pair the points v, u as naively expected in case 3.2. The tricky thing is to get γ_i to act freely in \mathcal{O} . Let $s = \mathcal{O}^u(p), l = \mathcal{O}^s(p)$ where p is periodic, non singular. Let γ in $\pi_1(M)$ with $\gamma(s)$ intersecting l and so that $\gamma(l)$ does not intersect s , see fig. 17, b. Let f be the generator of the isotropy group of $\gamma(p)$ leaving invariant all points in $\partial\mathcal{O}^s(\gamma(p)), \partial\mathcal{O}^u(\gamma(p))$ and associated to the positive direction of the flow line. Let $\gamma_i = f^i \circ \gamma$. Then $\{\gamma_i\}, i \in \mathbf{N}$ are all distinct.

Suppose that for some j , the γ_j has a fixed point. Fix j and let $h = \gamma_j$. Notice $l, h(l)$ both intersect a common unstable leaf $\gamma(s)$; $s, h(s)$ intersect the stable leaf l and $s, h(l)$ do not intersect. If $h^m(l)$ converges to r as $m \rightarrow \infty$ then $h(r) = r$ and h has a fixed point q in r . Then

$$h(\mathcal{O}^u(q)) = \mathcal{O}^u(q)$$

and $\mathcal{O}^u(q)$ intersects $h^m(l)$ for m big enough. But since h contracts $h^m(l)$ towards $\mathcal{O}^s(q)$ then it expands unstable leaves away. This contradicts the fact that $s, h(l)$ do not intersect.

It follows that each γ_i acts freely in \mathcal{O} and has 2 fixed points v_i, u_i in $\partial\mathcal{O}$. In addition as $i \rightarrow \infty$, u_i converges to an ideal point of $\gamma(l)$ and v_i converges to an ideal point of s – the one separated from $\gamma(l)$ by l . So this is exactly the situation in case 3.2 of theorem 4.12. Notice also that $\gamma_i(s) = \gamma(s)$ and $\gamma_i(l) = \gamma(l)$ so the collection $\{\gamma_i\}, i \in \mathbf{N}$ does not act properly discontinuously in \mathcal{O} .

We now prove that $\pi_1(M)$ acts as a uniform convergence group in \mathcal{R} . This means that the action on the space of distinct triples of \mathcal{R} is cocompact. We tried to analyse this directly without any success. In the case of Kleinian groups, given any 3 distinct points in S_∞^2 one easily uniquely associates a point in \mathbf{H}^3 with a direction [Th1]. There is a similar statement for Gromov hyperbolic groups [Gr, Gh-Ha]. In these cases, when the quotient is compact (in the case of manifolds) or a finite graph, it is very easy to show that the action of $\pi_1(M)$ in the space of triples is cocompact. This uses the geometry in a very strong sense, which we do not have here. In fact we want to use dynamics to get geometric information. Our approach is to show first that every point in \mathcal{R} is a conical limit point and then use theorem 4.8 to prove that the action on the space of triples is cocompact.

Theorem 4.13. *Let Φ be a simple pseudo-Anosov flow and \mathcal{R} the associated sphere quotient of $\partial\mathcal{O}$. Then every point in \mathcal{R} is a conical limit point and the action of $\pi_1(M)$ on the space of distinct triples of \mathcal{R} is cocompact. Hence $\pi_1(M)$ acts as a uniform convergence group in \mathcal{R} , $\pi_1(M)$ is Gromov hyperbolic and the action of $\pi_1(M)$ in \mathcal{R} is naturally topologically conjugate to the action of $\pi_1(M)$ in its Gromov ideal boundary S_∞^2 .*

Proof. We show that any x in \mathcal{R} is a conical limit point for the action of $\pi_1(M)$. There are 3 cases:

Case 1 – $x = \varphi(z)$ where z is the ideal point of l of \mathcal{O}^s or \mathcal{O}^u and there is γ in $\pi_1(M)$ with $\gamma(l) = l$.

Since all ideal points of l are taken to x under φ and γ permutes the ideal points of l , it follows that $\gamma(x) = x$. Assume that x is the repelling fixed point of γ – up to taking an inverse if necessary. Let $\gamma_i = \gamma^i, i \geq 0$. Then $\gamma_i(x) = x$ so $\gamma_i(x)$ converges to x . Let c be the other fixed point of g in \mathcal{R} . Then for any y distinct from x in \mathcal{R} it follows from lemma 4.11, that $\gamma_i(y) = (\gamma^i)(y)$ converges to c . Hence x is a conical limit point.

Case 2 – $x = \varphi(z)$ where z is an ideal point of l of \mathcal{O}^s or \mathcal{O}^u and l is not invariant under any γ of $\pi_1(M)$.

Suppose without loss of generality that l is an unstable leaf. Let $L = l \times \mathbf{R}$ an unstable leaf in $\tilde{\Lambda}^u$. Here $\pi(L)$ does not have a periodic orbit of Φ . Let α be an orbit of $\tilde{\Phi}$ in L . We look at the asymptotic behavior of $\pi(\alpha)$ in the negative direction (all orbits in L are backward asymptotic, so this argument is independent of the orbit α in L). If $\pi(\alpha)$ limits only in a singular orbit then $\pi(\alpha)$ must be in the unstable leaf of a singular orbit, which is not the case.

Hence there are p_i in α escaping in the negative direction and $\pi(p_i)$ converging to a non singular point in M . By discarding a number of initial terms, we can assume that all $\pi(p_i)$ are extremely close to each other. There are γ_i in $\pi_1(M)$ with $\gamma_i(p_i)$ very near p_1 . So the orbit α has a point p_1 which is very close to the point $\gamma_i(p_i)$ in the orbit $\gamma_i(\alpha)$. By the shadow lemma the γ_i correspond to closed orbits β_i of the flow Φ . In addition there are lifts $\tilde{\beta}_i$ of β_i with points very close to p_1 . It follows that we can assume no β_i is a singular orbit. Since $\tilde{\beta}_i, \gamma_i(\alpha)$ have points near p_1 , we may also assume up to subsequence that $(\tilde{\beta}_i)$ converges to an orbit τ of Φ and $(\gamma_i(\alpha))$ also converges.

Each γ_i takes p_i to a point very close to p_1 and the p_i escape in \tilde{M} with i , so up to subsequence we can assume that the γ_i are all distinct. Hence the length of β_i goes to infinity (the β_i does not have to be an indivisible closed orbit). Let $q_i = \Theta(\tilde{\beta}_i)$. Hence q_i converges to $q_0 = \pi(\tau)$. Let

$$\partial\mathcal{O}^u(q_0) = \{s, s'\}, \quad \partial\mathcal{O}^s(q_0) = \{t, t'\}, \quad \partial\mathcal{O}^u(q_i) = \{s_i, s'_i\}, \quad \partial\mathcal{O}^s(q_i) = \{t_i, t'_i\}$$

Since p_i is in the back of p_1 in α and p_i is sent near p_1 by γ_i , then γ_i corresponds to β_i being traversed in the forward direction. By lemma 4.11, $\{s_i, s'_i\}$ is the repelling set for the action of γ_i in $\partial\mathcal{O}$ and $\{t_i, t'_i\}$ is the attracting set.

This is very similar to case 2 in the proof of the convergence group property, theorem 4.12. Here $\mathcal{O}^s(q_i)$ intersects $l = \mathcal{O}^u(\alpha)$ and $\mathcal{O}^u(\gamma_i(\alpha))$ for every i . Since $\mathcal{O}^u(\gamma_i(\alpha))$ converges and the length of β_i goes to infinity, then the arguments of case 2 of the proof of theorem 4.12 show that the only possibility is that $\mathcal{O}^u(q_i)$ converges to $l = \mathcal{O}^u(\alpha)$ – otherwise l would be pushed farther and farther away from $\mathcal{O}^u(q_i)$. This shows that τ is in L and s, s' are the ideal points of l . Up to renaming $z = s$. Up to another subsequence assume that

$$s_i \rightarrow s, \quad s'_i \rightarrow s', \quad t_i \rightarrow t, \quad t'_i \rightarrow t'$$

Again the arguments in case 2 of theorem 4.12 show that in \mathcal{O} , we have $\gamma_i | (\partial\mathcal{O} - \{s, s'\})$ converges locally uniformly to the set $\{t, t'\}$. As $z = s$ then $x = \varphi(s)$ and we have in \mathcal{R} that $\gamma_i | (\mathcal{R} - \{x\})$

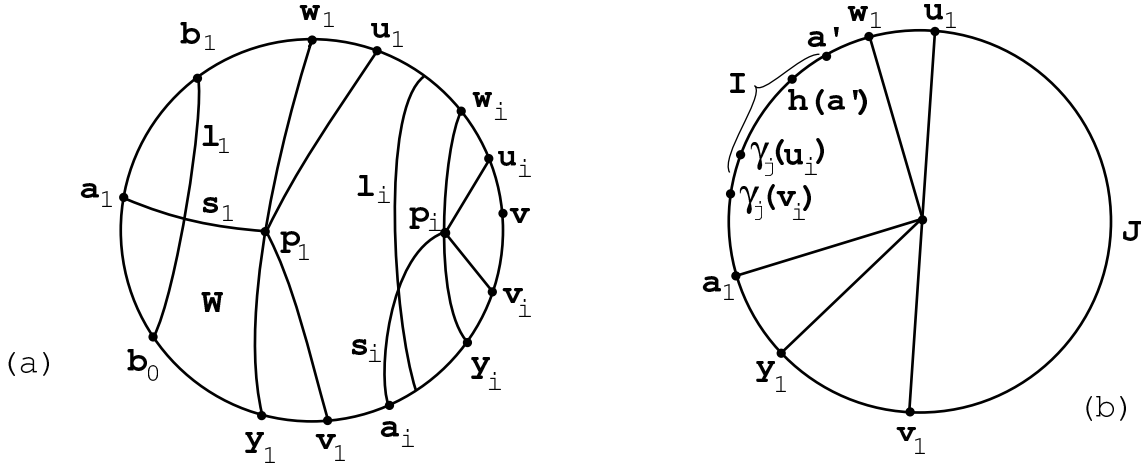

Figure 18: a. Splitting in the stable leaves, b. Mapping back to a compact region.

converges locally uniformly to $\varphi(t)$. Since the points $x = \varphi(s)$ and $\varphi(t)$ are different, this shows that x is a conical limit point.

Remark – Obviously it is crucial in this proof that z is an ideal point of a leaf of \mathcal{O}^s or \mathcal{O}^u . Since z is an unstable ideal point and we want to push points away from the unstable ideal point, then in the proof above we use γ_i associated to positive flow direction (recall lemma 4.11), while keeping track of what γ_i does to z . The only difference is that here we were careful to make sure $\gamma_i(z)$ did not converge to a certain stable ideal point in the limit. This proof does not work at all in the case z is not ideal point of a leaf of \mathcal{O}^s or \mathcal{O}^u .

Case 3 – $x = \varphi(z)$ where z is not ideal point of a leaf of \mathcal{O}^s or \mathcal{O}^u .

This case is much more interesting. Since z is not ideal point of a leaf of \mathcal{O}^s or \mathcal{O}^u then by proposition 3.29 there is a neighborhood system of z defined by a sequence of stable leaves, which can be assumed to be all non singular. Let l_1 be one of these leaves. The construction will be inductive using the hypothesis. Let W be the component of $\mathcal{O} - l_1$ which z is in its closure. Let b_0, b_1 in $\partial\mathcal{O}$ be the ideal points of l_1 . Let (b_0, z) be the interval of \mathcal{O} defined by b_0, z and not containing b_1 and similarly define (b_1, z) . Let s be a leaf of \mathcal{O}^u intersecting l_1 . If s is near b_0 then all ideal points of s are near b_0 – because of the no perfect fits condition. If s is near b_1 then all ideal points are near b_1 . The ideal points of the prongs of s entering W vary monotonically in $\partial\mathcal{O}$ as one moves s across l_1 . Since no unstable leaf has ideal point z and the leaf space of $\tilde{\Lambda}^u$ is Hausdorff, then there is a single leaf – call it s_1 intersecting l_1 and having at least a prong in W with an ideal point in (b_0, z) and another with ideal point in (b_1, z) , see fig. 18, a. Let p_1 be the singular point in this leaf which has to be in W . Let v_1 be the ideal point of $\mathcal{O}^u(p_1)$ in (b_0, z) closest to z and u_1 the one in (b_1, z) closest to z . Let a_1 be the ideal point of the prong of $\mathcal{O}^u(p_1)$ intersecting l_1 .

We can now proceed inductively: assuming that l_i, s_i, p_i have been chosen, let l_{i+1} be a stable leaf separating z from $\mathcal{O}^u(p_i)$. As before choose s_{i+1}, p_{i+1} . Let u_i be the ideal point of $\mathcal{O}^u(p_i)$ closest to z in (z, u_1) and v_i be the one closest to z in (z, v_1) , see fig. 18, a. Let w_i be the ideal point of $\mathcal{O}^s(p_i)$ in (u_i, b_1) closest to b_1 and y_i the ideal point of $\mathcal{O}^s(p_i)$ in (v_i, b_0) closest to b_0 . Let a_i be the ideal point of the prong of $\mathcal{O}^s(p_i)$ which intersects l_i .

Now up to subsequence assume the p_i are all translates of a single fixed element which we can choose to be p_1 . Hence there are γ_i in $\pi_1(M)$ with $\gamma_i(p_i) = p_1$. Up to a further subsequence assume $\gamma_i(u_i) = u_1, \gamma_i(v_i) = v_1, \gamma_i(a_i) = a_1$ and hence γ_i preserves orientation in \mathcal{O} . Then $\gamma_i(w_i) = w_1,$

$\gamma_i(y_i) = y_1$. Let (a_i, w_i) be the interval in $\partial\mathcal{O}$ defined by a_i, w_i and not containing z . Assume also up to subsequence that for $j > i$ then u_i, v_i, w_i, y_i are in (a_j, w_j) , see fig. 18, a.

Since p_1 is singular there is h non trivial in $\pi_1(M)$ with $h(p_1) = p_1$ and take h to be the generator of the isotropy group of p_1 which leaves all prongs of $\mathcal{O}^s(p_1), \mathcal{O}^u(p_1)$ invariant. We want to obtain transformations which send more and more of $\partial\mathcal{O} - \{z\}$ to a compact set in (a_1, w_1) . For each i let T_i be the interval of $\partial\mathcal{O}$ defined by u_i, v_i and not containing z – it is almost all of $\partial\mathcal{O}$. For any compact subset of $\partial\mathcal{O} - \{z\}$ then for sufficiently big i the interval T_i contains this compact set. Fix i . Let a' be a point in (a_1, w_1) . By construction for any j then $\gamma_j(u_j) = u_1, \gamma_j(a_j) = a_1$. Let $j > i$. Since u_i is in (a_j, w_j) then $\gamma_j(u_i)$ is in (a_1, w_1) . For each $j > i$ choose n_j so that

$$h^{n_j}(\gamma_j(u_i)) \quad \text{is in} \quad [a', h(a')]$$

where $[a', h(a')]$ is the subinterval of $[a_1, w_1]$ bounded by these points. Suppose that w_1 is a repelling fixed point of h (h is associated to backwards flow direction). Since γ_j is orientation preserving then $t_j = h^{n_j}(\gamma_j(v_i))$ is closer to a_1 than $h^{n_j}(\gamma_j(u_i))$ is. We claim that t_j is in a compact set of (a_1, w_1) as j varies. Otherwise we get t_j arbitrarily close to a_1 . Since

$$h^{n_j}\gamma_j(\mathcal{O}^u((p_i)))$$

is an unstable leaf with a point in $[a', h(a')]$ and another very close to a_1 , then taking a subsequence we find in the limit an unstable leaf δ with an ideal point in $[a', h(a')]$ and another in a_1 . Since δ is not $\mathcal{O}^u(p_1)$ this would force the existence of perfect fits, contradiction. Hence there is a compact interval I in (a_1, w_1) with t_j always in I . Let $\gamma_j = h^{n_j}g_j$. We have shown that

$$\gamma_j(T_i) \subset I \quad \text{for any } j > i$$

It follows that given t in $\partial\mathcal{O} - \{z\}$ then for high enough j one has $\gamma_j(t)$ is in I . Let J be the closed interval of $\partial\mathcal{O}$ bounded by u_1, v_1 and not containing a_1 . Then $\gamma_j(z)$ is in J so up to subsequence converges to a point c in J .

We first claim that $\varphi(I), \varphi(J)$ are disjoint. Suppose that $\varphi(I)$ intersects $\varphi(J)$. Then there has to be a leaf of \mathcal{O}^s or \mathcal{O}^u with ideal points in both I and J . Consider first the unstable case. The endpoints of J are ideal points of $\mathcal{O}^u(p_1)$. The other ideal points of $\mathcal{O}^u(p_1)$ are not in I – by construction of the interval I in (a_1, w_1) . Any other leaf of \mathcal{O}^u either has all ideal points in J or has no ideal point in J . Hence no unstable leaf has ideal points in I and J .

Consider now stable leaves: $\mathcal{O}^s(p_1)$ has one ideal point in J and all others in the interval of $\partial\mathcal{O}$ defined by w_1, y_1 and containing I . Hence $\mathcal{O}^s(p_1)$ it does not have an ideal point in I . Let r be any other leaf of \mathcal{O}^s . If r has an ideal point in J then r is separated from the interval I by $\mathcal{O}^s(p_1)$ – hence r cannot limit in I . We conclude that $\varphi(I), \varphi(J)$ are 2 disjoint compact subsets of \mathcal{R} .

Recall that $\gamma_n(z)$ converges to c and so in \mathcal{R} the sequence $\gamma_n(x)$ converges to $\varphi(c) \in \varphi(J)$. Any other point y in \mathcal{R} is $\varphi(t)$ for some t distinct from x . By the above $\gamma_n(y)$ is eventually in $\varphi(I)$. In theorem 4.12 we have already shown that $\pi_1(M)$ acts as a convergence group in \mathcal{R} , hence (γ_n) up to subsequence has a source/sink pair. Since $\gamma_n(x)$ is always in $\varphi(J)$ and all other points in \mathcal{R} are eventually in $\varphi(I)$, this shows that $\gamma_n | (\mathcal{R} - \{x\})$ converges locally uniformly to a point in $\varphi(I)$ which is distinct from the limit of $\gamma_n(x)$. This shows that x is a conical limit point.

This shows that all points of \mathcal{R} are conical limit points for the action of $\pi_1(M)$. Hence $\pi_1(M)$ acts as a uniform convergence group in \mathcal{R} . By theorem 4.8 this implies that $\pi_1(M)$ is Gromov hyperbolic and the action of $\pi_1(M)$ on \mathcal{R} is equivariantly conjugate to the action in the Gromov ideal boundary

S_∞^2 . Let $\zeta : \mathcal{R} \rightarrow S_\infty^2$ be the conjugacy. Notice that if x is the attracting fixed point of γ acting in \mathcal{R} then $\zeta(x)$ is the attracting fixed point of γ acting in S_∞^2 . Hence the conjugacy is uniquely defined.

This finishes the proof of the theorem 4.13. \square

As explained before there is not a natural group invariant topology in $\mathcal{D} \times [-1, 1]$, in particular no natural topology in $\partial\mathcal{D} \times [-1, 1]$. We now define a natural, group invariant topology in $\widetilde{M} \cup \mathcal{R}$. As it turns out open sets are hard to describe directly so we describe neighborhood systems instead. Recall [Ke] chapter 1 that the neighborhood system \mathcal{U}_x of a point x is a collection satisfying:

- 1) If U is in \mathcal{U}_x then x is in U .
- 2) If U, V are in \mathcal{U}_x then $U \cap V$ is in \mathcal{U}_x .
- 3) If U in \mathcal{U}_x and $U \subset V$ then V is in \mathcal{U}_x .

One then defines U to be open if U is a neighborhood of any of its points.

Before defining the neighborhood system in $\widetilde{M} \cup \mathcal{R}$ we establish some notation. Let

$$\mathcal{P} : \mathcal{A}_1 = \mathcal{D} \times [-1, 1] \rightarrow \widetilde{M} \cup \mathcal{R}$$

be the projection. Recall that $\partial\mathcal{A}_1$ is a sphere, let $\mathcal{P}_1 = \mathcal{P}|_{\partial\mathcal{A}_1}$. We identify \widetilde{M} with $\mathcal{O} \times (-1, 1)$.

Definition 4.14. (*neighborhood system in $\widetilde{M} \cup \mathcal{R}$*) Let Φ be a simple pseudo-Anosov flow.

i) If x is in \widetilde{M} then U is in \mathcal{U}_x if U contains an open set of \widetilde{M} (with its usual topology) containing x ,

ii) Let x in \mathcal{R} . Suppose that $\varphi^{-1}(x) = \{a\}$, a single point. The point a of $\partial\mathcal{O}$ is not identified to any other point, hence a is not an ideal point of a leaf of \mathcal{O}^s or \mathcal{O}^u . Then a has a neighborhood system in \mathcal{D} obtained by countable sequences of non singular stable or unstable leaves. Let l be one such leaf and U_l the corresponding open set of \mathcal{D} , as in definition 3.14, where a is in U_l . Let $V_l = U_l \times [-1, 1]$ a subset of $\mathcal{D} \times [-1, 1]$. We say that V is in \mathcal{U}_x if for some l as above then $V_l \subset \mathcal{P}^{-1}(V)$. Notice $\mathcal{P}^{-1}(V)$ is a subset of $\mathcal{D} \times [-1, 1]$.

iii) Let x in \mathcal{R} with $\varphi^{-1}(x) = \{a_1, \dots, a_n\}$. For simplicity assume they are ideal points of a stable leaf l . Let g be the cell decomposition element of \mathcal{G} of $\partial(\mathcal{D} \times [-1, 1])$ associated to l (that is $g = l \times \{1\} \cup \cup_i (\{a_i\} \times [-1, 1])$). For each i , choose r_i unstable leaves defining small neighborhoods of a_i in \mathcal{D} . Let $V_{r_i} = U_{r_i} \times [-1, 1]$ as in ii), where a_i is in U_{r_i} .

Choose now l_1, \dots, l_n stable leaves (of \mathcal{O}^s) very near each line leaf of l . Then $l_1, \dots, l_n, r_1, \dots, r_n$ bound a compact region B in \mathcal{O} . Choose any section $\tau : B \rightarrow \widetilde{M}$ of Θ restricted to B . Let H_τ be the union of $B \times \{1\}$ together with the set of points w in \widetilde{M} (or in $\mathcal{O} \times (-1, 1)$) with $\Theta(w)$ in B and $w = \widetilde{\Phi}_t(b)$ for some b in $\tau(B)$ and $t \geq 0$. Equivalently the H_τ consists of the points flow forwards from points in $\tau(B)$. Let δ denote the collection $(l_1, \dots, l_n, r_1, \dots, r_n, \tau)$. Let

$$A = A_\delta = A(l_1, \dots, l_n, r_1, \dots, r_n, \tau) = H_\tau \cup V_{r_1} \cup \dots \cup V_{r_n}$$

Let \mathcal{U}_x be the collection of the sets Z so that for some δ as above then $A_\delta \subset \mathcal{P}^{-1}(Z)$.

In the case of ideal points of unstable leaves, one switches stable and unstable objects and chooses points flow backwards from a section and backward ideal points.

We now show that \mathcal{U}_x forms a neighborhood system of x in $\widetilde{M} \cup \mathcal{R}$. For x in \widetilde{M} this is clear. In the other 2 cases it is clear that 1) and 3) are always satisfied, because the cell decomposition elements (in $\partial(\mathcal{D} \times [-1, 1])$) are always contained in the sets V_l or A_δ . We check condition 2).

For condition 2) suppose first that x is of type ii). Let V_1, V_2 in \mathcal{U}_x , with V_1 defined by l and V_2 defined by r leaves of \mathcal{O}^s or \mathcal{O}^u . Then there is l' in \mathcal{O}^s or \mathcal{O}^u so that $l' \cup \partial l'$ separates a from

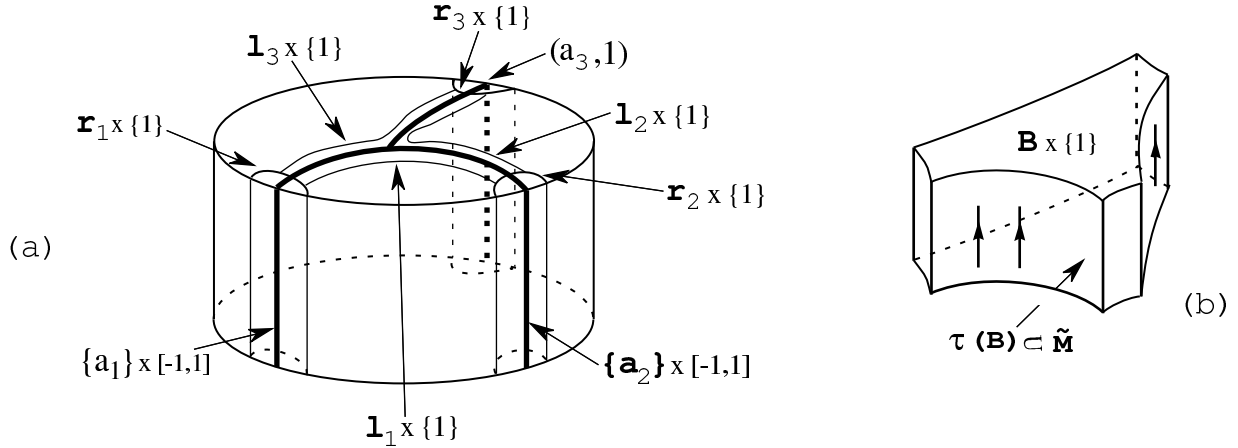

Figure 19: *a. The neighborhoods of certain points, b. Flow forward of sections.*

$r \cup l$ in \mathcal{D} . Then U_l is contained in $U_l \cap U_r$ and we are done. If x is of type iii) let A_1 defined by $(l_1^1, \dots, l_n^1, r_1^1, \dots, r_n^1, \tau_1)$, $A_2 = A(l_1^2, \dots, l_n^2, r_1^2, \dots, r_n^2, \tau_2)$. Choose l_i^3 closer to l than both l_i^1 and l_i^2 and r_i^3 closer to a_i than both r_i^1 and r_i^2 . Let B_3 be the compact region of \mathcal{O} defined by the l_i^3, r_i^3 . Choose a section τ_3 in B_3 so that in the intersection $B_3 \cap (B_1 \cup B_2)$ then τ_3 is flow forward of both τ_1 and τ_2 . Then $A_3 = A(l_1^3, \dots, l_n^3, r_1^3, \dots, r_n^3, \tau_3)$ is in \mathcal{U}_x and $A_3 \subset A_1 \cap A_2$. This shows that \mathcal{U}_x is a neighborhood system in $\widetilde{M} \cup \mathcal{R}$.

The collection $\{U_x, x \in \widetilde{M} \cup \mathcal{R}\}$ defines then a topology in $\widetilde{M} \cup \mathcal{R}$ and hence induced topologies in \widetilde{M} and \mathcal{R} . By definition it is clear that the topology induced in \widetilde{M} is the same as the original topology in \widetilde{M} . As for \mathcal{R} , let \mathcal{T} be the original topology (defined in theorem 4.3) and \mathcal{T}' the neighborhood system topology. We show they are the same. Let U in \mathcal{T} . Then $\mathcal{P}_1^{-1}(U)$ is open in $\partial\mathcal{A}_1$. Let x in U and g the cell element of \mathcal{G} associated to x (that is $g = \mathcal{P}_1^{-1}(x)$). If x is of type ii) or iii) as above then since $\mathcal{P}_1^{-1}(U)$ contains an open neighborhood of g in $\partial\mathcal{A}_1$, it follows that U is in \mathcal{U}_x (with respect to \mathcal{T}'). Hence U is in \mathcal{T}' . Conversely let U in \mathcal{T}' , y in $\mathcal{P}_1^{-1}(U)$ and $x = \mathcal{P}_1(y)$. By construction if x is of type ii) or iii) as above, then $\mathcal{P}_1^{-1}(U)$ contains an open neighborhood of y . Hence $\mathcal{P}_1^{-1}(U)$ is open in $\partial\mathcal{A}_1$ and U is in \mathcal{T} . Therefore $\mathcal{T} = \mathcal{T}'$.

Lemma 4.15. *The space $\widetilde{M} \cup \mathcal{R}$ is compact.*

Proof. Let $\{Z_\alpha\}, \alpha \in \mathcal{I}$ be an open cover of $\widetilde{M} \cup \mathcal{R}$. This provides an open cover of \mathcal{R} which is compact. Hence there is a finite subcover $Z_{\alpha_1}, \dots, Z_{\alpha_n}$ which contains \mathcal{R} . Then

$$C = \widetilde{M} \cup \mathcal{R} - \left(\bigcup_{i=1}^n Z_{\alpha_i} \right) \subset \widetilde{M}$$

is closed. Since the topology in \widetilde{M} is the same as the induced topology from $\widetilde{M} \cup \mathcal{R}$, it follows that C is closed in \widetilde{M} and hence compact and it has a finite subcover. This finishes the proof. \square

Notice that $\pi_1(M)$ acts in $\widetilde{M} \cup \mathcal{R}$: Given γ in $\pi_1(M)$ then γ takes sets of the form V_l (of ii) or iii) above) for l in \mathcal{O}^s or \mathcal{O}^u to $V_{\gamma(l)}$. Sections over compact sets in \mathcal{O} are taken to sections over compact sets by γ . Hence $\pi_1(M)$ preserves the sets described in ii), iii). Therefore it takes neighborhoods to neighborhoods and consequently $\pi_1(M)$ acts naturally by homeomorphisms in $\widetilde{M} \cup \mathcal{R}$.

Lemma 4.16. *The space $\widetilde{M} \cup \mathcal{R}$ is first countable.*

Proof. We only need to check this for x in \mathcal{R} since \widetilde{M} is open in $\widetilde{M} \cup \mathcal{R}$ and a manifold. Suppose $\varphi^{-1}(x) = \{a_1, \dots, a_{i_0}\}$, all ideal points of a stable leaf l . The other cases are either similar or simpler. For each $1 \leq i \leq i_0$ let $(t_i^n), n \in \mathbf{N}$ be a nested sequence of unstable leaves forming an admissible sequence of chains defining a_i . For each line leaf l_i of l let $(l_i^n), n \in \mathbf{N}$ be a nested sequence of regular leaves converging to l_i in that sector of l . Then for each n

$$\bigcup_{1 \leq i \leq i_0} l_i^n \cup t_i^n$$

defines a compact set B_n in \mathcal{O} . Fix a section $\tau : B_1 \rightarrow \widetilde{M}$. Choose sections $\tau_n : B_n \rightarrow \widetilde{M}$ so that the flow length from $\tau(B_n)$ to $\tau_n(B_n)$ goes to infinity uniformly in n .

Let A_n defined by $(l_1^n, \dots, l_{i_0}^n, r_1^n, \dots, r_{i_0}^n, \tau_n)$. Given the definition of the neighborhood systems in $\widetilde{M} \cup \mathcal{R}$ it is easy to check that $\{A_n\}, n \in \mathbf{N}$ forms a neighborhood basis for x . \square

We first show that the action of $\pi_1(M)$ in $\widetilde{M} \cup \mathcal{R}$ is a convergence group action.

Theorem 4.17. *Let Φ be a simple pseudo-Anosov flow. The induced action of $\pi_1(M)$ in $\widetilde{M} \cup \mathcal{R}$ is a convergence group action.*

Proof. Let $(\gamma_n), n \in \mathbf{N}$ be a sequence of distinct elements in $\pi_1(M)$. Since the action of $\pi_1(M)$ in \mathcal{R} is a convergence group action, then up to subsequence we can assume there are x, y in \mathcal{R} with (γ_n) converging locally uniformly to x in $\mathcal{R} - \{y\}$. We want to show that (γ_n) converges locally uniformly to x when acting in $(\widetilde{M} \cup \mathcal{R}) - \{y\}$. Let C be a compact set in $\widetilde{M} \cup \mathcal{R} - \{y\}$. Recall the surjective map $\varphi : \partial\mathcal{O} \rightarrow \mathcal{R}$.

Case 1 – $\varphi^{-1}(y) = \{a\}$ – a single point.

Then $\mathcal{P}^{-1}(y)$ is a vertical strip in $\partial\mathcal{O} \times I$. For any neighborhood U of y in $\widetilde{M} \cup \mathcal{R}$, there is l an unstable (or stable) leaf sufficiently near a in \mathcal{D} so that $V_l \subset \mathcal{P}^{-1}(U)$, V_l as defined previously. If C is disjoint from U then

$$\mathcal{P}^{-1}(C) \subset \mathcal{D} \times I - V_l$$

Let Z be the closure of the segment of $(\partial\mathcal{O} - \partial l)$ not containing a (this is almost all of $\partial\mathcal{O}$). By the source/sink property of y, x then $\gamma_n(Z)$ needs to be very near $\varphi^{-1}(x)$. Hence there is a single point b in $\varphi^{-1}(x)$ with $\gamma_n(Z)$ near b for n big. Then $\gamma_n(\mathcal{D} - U_l)$ is very near b in \mathcal{D} . It follows that $\gamma_n(\mathcal{D} \times I - V_l)$ is very near $\{b\} \times [-1, 1]$ and so $\gamma_n(\mathcal{P}^{-1}(C))$ is very near $\{b\} \times [-1, 1]$ (in $\mathcal{D} \times [-1, 1]$). Hence $\gamma_n(C)$ is very near x in $\widetilde{M} \cup \mathcal{R}$ as desired. This finishes this case.

Case 2 – $\varphi^{-1}(y) = \{a_1, \dots, a_{i_0}\}$, with $i_0 \geq 2$.

Suppose for simplicity that a_i are the ideal points of $\mathcal{O}^s(p) = l$. Let C be a compact set in $\widetilde{M} \cup \mathcal{R} - \{y\}$. As seen before there are $l_i, 1 \leq i \leq i_0$ regular leaves of \mathcal{O}^s very near the line leaves of l , $r_i, 1 \leq i \leq i_0$, regular leaves of \mathcal{O}^u defining small neighborhoods of a_i so that the l_i 's together with the r_i 's define a compact set B in \mathcal{O} and there is a section $\tau : B \rightarrow \widetilde{M}$ with

$$A = A(l_1, \dots, l_{i_0}, r_1, \dots, r_{i_0}, \tau) \quad \text{and} \quad \mathcal{P}^{-1}(C) \subset \widetilde{M} \cup \mathcal{R} - A$$

Assume that r_i intersects $l_i, l_{i+1} \pmod{i_0}$ and has ideal points near a_i . Since r_i, l_i are regular, choose U_{r_i} so that a_i is in U_{r_i} and U_{l_i} so that other l_j 's are not in U_{l_i} . The endpoints of l_i bound a closed

interval I_i in $\partial\mathcal{O}$ contained in the closure U_{l_i} (they do not contain a_i). Similarly the endpoints of r_i bound a very small closed interval J_i containing a_i . Let $\varphi^{-1}(x) = \{b_1, \dots, b_{j_0}\}$.

Case 2.a – The union $\cup_i \gamma_n(\partial l_i)$ is eventually always very near a single point b_1 in $\varphi^{-1}(x)$.

This clearly occurs if j_0 is equal 1. Since γ_n restricted to compact sets of $\partial\mathcal{O} - \varphi^{-1}(y)$ has to be getting closer to $\varphi^{-1}(x)$ it follows that for all i , $1 \leq i \leq i_0$ then $\gamma_n(I_i)$ is very close to b_1 . This implies that $\gamma_n(V_{l_i})$ is very close to $\{b_1\} \times [-1, 1]$. In addition since γ_n are homeomorphisms of $\partial\mathcal{O}$, then there is a single i (assume it is 1) so that $\gamma_n(J_1)$ is almost all of $\partial\mathcal{O}$ and hence $\gamma_n(\partial\mathcal{O} - J_1)$ is very close to b_1 . Notice that $\mathcal{D} \times [-1, 1] - (H_\tau \cup V_{r_1} \cup \dots \cup V_{r_n})$ is contained in

$$\left(\bigcup_{1 \leq i \leq i_0} V_{l_i} \right) \cup (\mathcal{D} \times [-1, 1] - V_{r_1})$$

By the above $\gamma_n(V_{l_i})$, $\gamma_n(\mathcal{D} \times [-1, 1] - V_{r_1})$ are both very close to $\{b_1\} \times [-1, 1]$ in $\mathcal{D} \times [-1, 1]$. It follows that $\gamma_n(C)$ is very close to x for n big. This finishes the analysis in this case.

Case 2.b – The union $\cup_i \gamma_n(\partial l_i)$ gets closer to more than one point.

We first explain why the b_i are ideal points of an unstable leaf. By hypothesis there is some $i \bmod i_0$ so that the ideal points of $\gamma_n(l_i), \gamma_n(l_{i+1})$ are not close. But $\gamma_n(r_i)$ intersects both of these leaves, hence $\gamma_n(r_i)$ has to intersect a compact set in \mathcal{O} and up to subsequence converges to a leaf s of \mathcal{O}^u . Let q in s . The source/sink property for y, x implies that the ideal points of $\gamma_n(r_i)$ have to be getting close to points in $\varphi^{-1}(x)$. It follows that $\varphi^{-1}(x) = \partial s$ as we desired to show.

For U neighborhood U of x in $\widetilde{M} \cup \mathcal{R}$ there is a set D in $\mathcal{D} \times [-1, 1]$ as in definition 4.14: D is defined by s_1, \dots, s_{j_0} regular leaves of \mathcal{O}^u near line leaves of s ; also t_1, \dots, t_{j_0} regular leaves of $\mathcal{O}^s - t_j$ defines a small neighborhood U_{t_j} of b_j in \mathcal{D} . The s_j, t_j jointly bound a compact set B' in \mathcal{O} , consider a section $\nu : B' \rightarrow \widetilde{M}$ and E_ν the set of points flow backwards from E_ν union ideal points. Let

$$D = D(s_1, \dots, s_{j_0}, t_1, \dots, t_{j_0}, \nu) = \left(\bigcup_{1 \leq j \leq j_0} V_{t_j} \right) \cup E_\nu$$

Then there is such a D so that $D \subset \mathcal{P}^{-1}(U)$. We want to show that $\gamma_n(C)$ is eventually contained in U in $\widetilde{M} \cup \mathcal{R}$. It suffices to show that $\gamma_n(\mathcal{D} \times [-1, 1] - A) \subset D$ in $\mathcal{D} \times [-1, 1]$. In this case some argument in \widetilde{M} will be needed. With the same notation as above E_τ is the set of points flow backwards from the section $\tau(B)$ union backwards ideal points, hence $B \times [-1, 1]$ is the union of E_τ, H_τ and the intersection of E_τ, H_τ is equal to $\tau(B)$. Notice that

$$\mathcal{D} \times [-1, 1] - A \subset \left(\bigcup_{1 \leq i \leq i_0} V_{l_i} \right) \cup E_\tau$$

Take leaves l_i closer to l so that the unstable length in the section $\tau(B)$ from $\tau(l_i)$ to $\tau(l_j)$ is arbitrarily small regardless of whether it goes through a singularity or not. This gives an even smaller neighborhood of y (V_{l_i} is bigger) and we show that outside this neighborhood of y everything goes near x under γ_n . The endpoints of $\gamma_n(l_i)$ and $\gamma_n(r_i)$ are converging to points in $\varphi^{-1}(x)$ so we obtain that $\gamma_n(V_{l_i})$ gets very near $\varphi^{-1}(x)$ in $\mathcal{D} \times [-1, 1]$. In order to finish the argument we need to analyse $\gamma_n(E_\tau)$. We can choose s_j close enough to s , t_j close enough to b_j and section $\nu(B')$ so that any unstable segment in $\nu(B')$ connecting $t_j \times \mathbf{R}$ to $t_k \times \mathbf{R}$ has very large length.

Suppose there are z'_n in E_τ so that $\gamma_n(z'_n)$ are not in D . The endpoints of $\gamma_n(r_i)$ are very near points in $\varphi^{-1}(x)$ in \mathcal{D} . Also $\gamma_n(z'_n)$ is in the region of \widetilde{M} bounded by $\cup_i(\gamma_n(r_i) \times \mathbf{R})$. Hence if $\gamma_n(z'_n)$ is not near $\varphi^{-1}(x) \times [-1, 1]$ in $\mathcal{D} \times [-1, 1]$ then $\gamma_n(z'_n)$ is in $B' \times [-1, 1]$. If $\gamma_n(z'_n)$ is not in

E_ν then it is flow forward from a point in $\nu(B')$. Hence flow z'_n forward to a point z_n in the section $\tau(B)$ and still $\gamma_n(z_n)$ is flow forward of a point in $\nu(B')$.

Now consider the segment v_n of $\widetilde{W}^u(z_n)$ intersected with the section $\tau(B)$. By construction this segment has arbitrarily small length and hence so does the segment $\gamma_n(v_n)$ in $\widetilde{W}^u(\gamma_n(z_n))$. Flow $\gamma_n(v_n)$ backwards until it hits the section $\nu(B')$. The unstable length gets decreased when flowing backwards so it is very small length. Since the endpoints of $\gamma_n(v_n)$ are close to $\varphi^{-1} \times [-1, 1]$ in $\mathcal{D} \times [-1, 1]$ then $\gamma_n(v_n)$ intersects distinct $t_j \times \mathbf{R}$ and $t_k \times \mathbf{R}$. The same happens for the flow back segment. But this contradicts that the unstable length in the section $\nu(B')$ between $t_j \times \mathbf{R}$ and $t_k \times \mathbf{R}$ is very large. Therefore $\gamma_n(z_n)$ has to be flow backwards from $\nu(B')$ and hence contained in E_ν . To hit $\nu(B')$ one has to flow forward and hence increase unstable length as expected.

This shows that $\gamma_n(E_\nu)$ is contained in $\mathcal{P}^{-1}(U)$. Hence in $\widetilde{M} \cup \mathcal{R}$, then $\gamma_n(\widetilde{M} \cup \mathcal{R} - \{y\})$ converges locally uniformly to x . This finishes the proof that $\pi_1(M)$ acts as a convergence group in $\widetilde{M} \cup \mathcal{R}$. \square

We now prove that this group equivariant compactification is equivariantly homeomorphic to the Gromov compactification of M . Recall that the \widetilde{M} is Gromov compactified with a sphere ideal boundary S_∞^2 . First we define a bijection

$$\xi : \widetilde{M} \cup \mathcal{R} \rightarrow \widetilde{M} \cup S_\infty^2 \quad - \quad \text{if } x \in \widetilde{M} \text{ let } \xi(x) = x, \quad \text{for } x \in \mathcal{R} \text{ let } \xi(x) = \zeta(x)$$

where ζ is the topological conjugacy given by theorem 4.13. This map is group equivariant: if γ is in $\pi_1(M)$ then $\xi(\gamma(x)) = \gamma(\xi(x))$.

Theorem 4.18. *The map $\xi : \widetilde{M} \cup \mathcal{R} \rightarrow \widetilde{M} \cup S_\infty^2$ is a group equivariant homeomorphism. The map $\varphi_1 = \xi \circ \varphi : \partial\mathcal{O} \rightarrow S_\infty^2$ is a group invariant Peano curve.*

Proof. By theorem 4.13 we only need to show that ξ is a homeomorphism. We know that \widetilde{M} is open in $\widetilde{M} \cup \mathcal{R}$ and in $\widetilde{M} \cup S_\infty^2$ and the induced topology from both of these is the original topology of \widetilde{M} . Hence ξ is continuous in \widetilde{M} . Let x in \mathcal{R} . Since $\widetilde{M} \cup \mathcal{R}$ is first countable we only need to verify what happens for sequences. Let then p_n in $\widetilde{M} \cup \mathcal{R}$ converging to x as n converges to infinity. By theorem 4.13 we may assume that p_n is in \widetilde{M} . Then there are q_n in a fixed compact set in \widetilde{M} and γ_n in $\pi_1(M)$ with $\gamma_n(q_n) = p_n$. We may assume that the γ_n are distinct otherwise up to subsequence all $\gamma_n = \gamma$ and sends q_n into a fixed compact set, contradiction.

By the convergence group action in $\widetilde{M} \cup \mathcal{R}$, theorem 4.17, there is a source/sink pair y, z for some subsequence of γ_n . Since $\pi_1(M)$ acts as a convergence group in $\widetilde{M} \cup S_\infty^2$ [Fr, Ge-Ma], then for this subsequence there is another subsequence with a source sink pair b, a for the action in $\widetilde{M} \cup S_\infty^2$. The final sequence, call it $\alpha_i = \gamma_{n_i}$. As the action of $\pi_1(M)$ in \mathcal{R} is equivariantly conjugate to the action in S_∞^2 , it follows that $\xi(y) = b$ and $\xi(z) = a$. As $p_{n_i} \rightarrow x$ in $\widetilde{M} \cup \mathcal{R}$ and $p_{n_i} = \gamma_{n_i}(q_{n_i})$ with q_{n_i} in a fixed compact set, then x is the sink of the sequence (α_i) acting in $\widetilde{M} \cup \mathcal{R}$, so $x = z$.

But $\xi(p_{n_i}) = \gamma_{n_i}(\xi(q_{n_i}))$ converges to $a = \xi(z) = \xi(x)$ so $\xi(p_{n_i})$ converges to $\xi(x)$. This shows that for any sequence p_n converging to x in $\widetilde{M} \cup \mathcal{R}$, there is a subsequence $(p_{n_i}), i \in \mathbf{N}$ with $\xi(p_{n_i})$ converging to $\xi(x)$ in $\widetilde{M} \cup S_\infty^2$. This shows that ξ is continuous at x . Hence ξ is continuous. Since $\widetilde{M} \cup \mathcal{R}$ is compact, Hausdorff; then ξ is a homeomorphism.

Using this fact the second statement follows from the fact that the map $\varphi : \partial\mathcal{O} \rightarrow \mathcal{R}$ is group equivariant. This finishes the proof of the theorem. \square

The compactification $\widetilde{M} \cup \mathcal{R}$ is obtained using only the dynamics of the pseudo-Anosov flow Φ .

5 Quasigeodesic flows and quasi-isometric singular foliations

A flow Φ in a manifold N is quasigeodesic if in \tilde{N} , distance along flow lines of $\tilde{\Phi}$ is a bounded multiplicative distortion of ambient distance. Quasigeodesic flows are extremely useful [Th1, Gr, Ca-Th, Fe-Mo]. In this section we show that if Φ is a simple pseudo-Anosov flow, then Φ is quasigeodesic. This will produce new examples of quasigeodesic pseudo-Anosov flows. A foliation \mathcal{E} (singular or not) is quasi-isometric if distance along leaves of $\tilde{\mathcal{E}}$ is a bounded multiplicative distortion of ambient distance in \tilde{N} . This property is very important [Th1, Th2, Mor, Gr, Ca-Th, Fe8]. We show that the stable/unstable foliations of simple pseudo-Anosov flows are quasi-isometric. These results are a quick consequence of theorem 4.18 and previous results.

Theorem 5.1. *Let Φ be a simple pseudo-Anosov flow. Then $\pi_1(M)$ is negatively curved and Φ is a quasigeodesic flow. In addition the foliations Λ^s, Λ^u are quasi-isometric foliations.*

Proof. Theorem 4.13 shows that $\pi_1(M)$ is negatively curved. We now show that Φ is quasigeodesic. We will prove 3 properties of the flow lines in $\tilde{M} \cup \mathcal{R}$ (and hence in $\tilde{M} \cup S_\infty^2$):

Property 1 – For each flow line α of $\tilde{\Phi}$ then it limits in a single point of \mathcal{R} denoted by α_+ and similarly for the backwards direction.

First consider α in $\mathcal{D} \times [-1, 1]$ and z the point of $\mathcal{D} \times 1$ which is the top of α . Let q in α . Let $x = \varphi(z)$ a point in \mathcal{R} . We claim that x is the limit of α in $\tilde{M} \cup \mathcal{R}$. Let g be the decomposition element of $\partial(\mathcal{D} \times [-1, 1])$ associated to z . For any neighborhood U of x in $\tilde{M} \cup \mathcal{R}$ there is a set type $A = A(l_1, \dots, l_n, r_1, \dots, r_n, \tau)$ (definition 4.14) with $A \subset \mathcal{P}^{-1}(U)$. Since z is in g any such set A contains $\tilde{\Phi}_t(q)$ for all t bigger than some t_0 . This shows that in $\tilde{M} \cup \mathcal{R}$ the flow line α forward converges to x . Similarly let α_- be the negative ideal point of α . In fact for any q in \tilde{M} with $\alpha = \tilde{\Phi}_{\mathbf{R}}(q)$, let $q_+ = \alpha_+$ and $q_- = \alpha_-$.

Property 2 – For each flow line α of $\tilde{\Phi}$, then the ideal points α_+, α_- are distinct.

Given α first see it in $\mathcal{D} \times [-1, 1]$. By the construction of theorem 4.3, a point in $\mathcal{D} \times 1$ is identified to a point in $\mathcal{D} \times \{-1\}$ then at least one of them is in $\partial\mathcal{O} \times [-1, 1]$. This is not the case here so α_+, α_- are distinct.

Property 3 – The endpoint function $\eta_+ : \tilde{M} \rightarrow \mathcal{R}$ given by $\eta_+(p) = p_+$ is continuous. Similarly for the negative endpoint function η_- .

We show that $\eta_+(p)$ varies continuously with p in \tilde{M} . First see the situation in $\mathcal{D} \times [-1, 1]$. For any neighborhood U of $\eta_+(p)$ then $\mathcal{P}^{-1}(U)$ contains a set of type $A(l_1, \dots, l_n, r_1, \dots, r_n, \tau)$. Let z in $\mathcal{O} \times \{1\}$ be the top of the orbit of α through p . For any q sufficiently near p then the forward orbit of q is eventually in $A(l_1, \dots, l_n, r_1, \dots, r_n, \tau)$ and so $\eta_+(q)$ is in U . This shows continuity of the function η_+ as a map from \tilde{M} to \mathcal{R} .

Since the map $\xi : \tilde{M} \cup \mathcal{R} \rightarrow \tilde{M} \cup S_\infty^2$ is a homeomorphism then as seen in $\tilde{M} \cup S_\infty^2$ properties 1) through 3) also hold for orbits of $\tilde{\Phi}$. This is the key fact here: properties in $\tilde{M} \cup \mathcal{R}$ get transferred to $\tilde{M} \cup S_\infty^2$. We now use a result of Fenley-Mosher [Fe-Mo] which states that if $\pi_1(M)$ is negatively curved and properties 1) through 3) hold for orbits of $\tilde{\Phi}$ then Φ is a uniform quasigeodesic flow.

We now prove that Λ^s, Λ^u are quasi-isometric singular foliations. Given that Φ is a quasigeodesic pseudo-Anosov flow, then it was proved in [Fe8] that $\tilde{\Lambda}^s$ is quasi-isometric if and only if $\tilde{\Lambda}^s$ has Hausdorff leaf space and similarly for Λ^u . Suppose that $\tilde{\Lambda}^s$ does not have Hausdorff leaf space and let F, L not separated in $\tilde{\Lambda}^s$. Theorem 2.6 shows that F, L are connected by a chain of lozenges. A lozenge has 2 perfect fits – which are disallowed by hypothesis. Hence Λ^s, Λ^u are quasi-isometric foliations. This finishes the proof of theorem 5.1. \square

6 Asymptotic properties of foliations

Here we show that \mathbf{R} -covered foliations and foliations with one sided branching in atoroidal manifolds are transverse to pseudo-Anosov flows without perfect fits and therefore satisfy the continuous extension property. This parametrizes and characterizes their limit sets. In addition this shows that simple pseudo-Anosov flows are very common.

Theorem 6.1. *Let \mathcal{F} be a Reebless \mathbf{R} -covered foliation in M^3 closed, atoroidal and not finitely covered by $\mathbf{S}^2 \times \mathbf{S}^1$. Then $\pi_1(M)$ is Gromov hyperbolic and \mathcal{F} satisfies the continuous extension property. This produces new examples of group invariant Peano curves.*

Proof. If \mathcal{F} is \mathbf{R} -covered and M is not finitely covered by $\mathbf{S}^2 \times \mathbf{S}^1$, then it was proved in [Fe9, Cal2] that either there is a $\mathbf{Z} \oplus \mathbf{Z}$ subgroup of $\pi_1(M)$ or there is a pseudo-Anosov flow Φ transverse to \mathcal{F} and regulating for \mathcal{F} . Since M is atoroidal the second option occurs. Regulating means that every orbit of Φ intersects an arbitrary leaf of $\tilde{\mathcal{F}}$ and vice versa. Therefore the orbit space of $\tilde{\Phi}$ can be identified to the set of points in a leaf F of $\tilde{\mathcal{F}}$. Using Candel's theorem [Ca] we can assume that all leaves of \mathcal{F} are hyperbolic. In this situation the set $\mathcal{D} = \mathcal{O} \cup \partial\mathcal{O}$ is naturally identified to the compactification of F with a circle at infinity $\partial_\infty F$. Here is why: The construction of Λ^s, Λ^u in [Fe9, Cal2] is obtained by blowing down 2 transverse laminations which intersect the leaves of \mathcal{F} in geodesics. Therefore there are 2 geodesic laminations (stable and unstable) in F , whose complementary regions are finite sided ideal polygons [Fe9, Cal2]. It follows that the ideal points of F are either ideal points of leaves of $\tilde{\Lambda}^s \cap F, \tilde{\Lambda}^u \cap F$ or have neighborhood systems defined by leaves of these. Hence $\partial_\infty F$ is naturally homeomorphic to $\partial\mathcal{O}$ and $F \cup \partial_\infty F$ is homeomorphic to $\mathcal{O} \cup \partial\mathcal{O}$. This works for any F in $\tilde{\mathcal{F}}$.

Suppose there is a perfect fit between a leaf L of $\tilde{\Lambda}^s$ and a leaf H of $\tilde{\Lambda}^u$. Then in \mathcal{O} we see rays of $\Theta(L), \Theta(H)$ converging to the same ideal point in $\partial\mathcal{O}$. By the above description there is a pair of geodesics in F , one stable and one unstable with the same ideal point in $\partial_\infty F$. By hyperbolic geometry considerations these 2 geodesics are asymptotic in F , so projecting to M and taking limits we obtain a leaf of $\tilde{\mathcal{F}}$ so that there is a geodesic which is a leaf of both the stable and unstable laminations. This contradicts the fact that the stable and unstable laminations are transverse.

Hence there are no perfect fits. By theorem 4.13 it follows that $\pi_1(M)$ is negatively curved (this was already known, by the Gabai-Kazez theorem [Ga-Ka]). By theorem 5.1 it follows that Φ is a quasi-geodesic pseudo-Anosov flow and in addition the map $\varphi_1 : \partial\mathcal{O} \rightarrow S_\infty^2$ is a group equivariant Peano curve. The previously known examples of such group invariant Peano curves occurred for fibrations [Ca-Th] and slitherings by work of Thurston [Th5]. The results here are useful because Calegari [Cal1], showed that there are many examples of \mathbf{R} -covered foliations in hyperbolic 3-manifolds which are not slitherings or uniform foliations. The results here imply the previous results.

Now we analyse the continuous extension property for the leaves of $\tilde{\mathcal{F}}$. Since Φ is quasigeodesic, then the main theorem in [Fe12] implies that leaves of $\tilde{\mathcal{F}}$ extend continuously to S_∞^2 . Hence \mathcal{F} has the continuous extension property. This finishes the proof of the theorem. We remark that there is a direct proof of the continuous extension property in this case since $\partial\mathcal{O}$ is naturally identified to $\partial_\infty F$. For simplicity we just quote the result of [Fe12]. Notice that the leaves of $\tilde{\mathcal{F}}$ have limit set the whole sphere, so each leaf F of $\tilde{\mathcal{F}}$ produces a sphere filling curve. \square

We now turn to foliations with one sided branching.

Theorem 6.2. *Let \mathcal{F} be a Reebless foliation with one sided branching in M^3 closed, atoroidal and not finitely covered by $\mathbf{S}^2 \times \mathbf{S}^1$. Then $\pi_1(M)$ is Gromov hyperbolic. There is a pseudo-Anosov flow Φ transverse to \mathcal{F} which is simple and hence is a quasigeodesic flow and its stable/unstable foliations are quasi-isometric. It follows that \mathcal{F} has the continuous extension property.*

Proof. Since \mathcal{F} has one sided branching it is transversely oriented. Suppose that $\tilde{\mathcal{F}}$ has branching only in the negative direction. When M is atoroidal and not finitely covered by $\mathbf{S}^2 \times \mathbf{S}^1$, Calegari [Cal3] produced a pseudo-Anosov flow Φ which is transverse to \mathcal{F} and forward regulating for \mathcal{F} . Forward regulating means that if x is in a leaf F of $\tilde{\mathcal{F}}$ and L is a leaf of $\tilde{\mathcal{F}}$, for which there is a positive transversal from F to L , then the forward orbit of x intersects L .

As in the \mathbf{R} -covered case this is obtained from 2 laminations transverse to \mathcal{F} which intersect the leaves of $\tilde{\mathcal{F}}$ in a collection of geodesics. Suppose there is G in $\tilde{\Lambda}^s$ and H in $\tilde{\Lambda}^u$ forming a perfect fit. Then G intersects F_0 leaf of $\tilde{\mathcal{F}}$ and H intersects F_1 . Since \mathcal{F} has one sided branching there is a leaf F of $\tilde{\mathcal{F}}$ with positive transversals from F_0 to F and from F_1 to F . By the above property G and H intersect F . There are rays in $\Theta(G)$ and $\Theta(H)$ with same ideal point p in $\partial\mathcal{O}$.

The ideal circle of \mathcal{O} is the same as the universal circle for the foliation \mathcal{F} in this case [Cal3]. The universal circle is obtained as the inverse limit of circles at infinity escaping in the positive direction. Given $A < B$ in $\tilde{\mathcal{F}}$ then there is a dense set of directions in A which are asymptotic to B [Cal3]. This is not symmetric – there is not a dense set of directions from B which is asymptotic to A . In our situation with $F_0 < F$ and $F_1 < F$ then the asymptotic directions from F to F_0 form an unlinked set with the asymptotic directions from F to F_1 . This implies there are natural surjective, continuous, weakly circularly monotone maps $\partial_\infty F \rightarrow \partial_\infty F$. The universal circle \mathcal{V} is obtained as an inverse limit of these maps.

The stable/unstable laminations are obtained by analysing the action of $\pi_1(M)$ in \mathcal{V} and producing laminations – that is, pairs of points in \mathcal{V} which are unlinked. The project to a collection of geodesics in leaves of $\tilde{\mathcal{F}}$ which vary continuously in the transversal direction. Therefore if rays of $\Theta(G), \Theta(H)$ define the same ideal point in $\partial\mathcal{O}$, then in F where they jointly intersect; the associated stable/unstable geodesics are asymptotic. As in the \mathbf{R} -covered case this leads to a contradiction to $\tilde{\Lambda}^s, \tilde{\Lambda}^u$ being transverse. The rest of the proof is exactly as in the \mathbf{R} -covered case. \square

The remaining open situation for the continuous extension property is that of \mathcal{F} with two sided branching. The case of finite depth foliations was recently solved in [Fe12] using completely different methods. In particular in [Fe12] one starts with strong geometric properties, namely that M is hyperbolic and there is a leaf which is quasi-isometrically embedded (the compact leaf) and this has enormous geometric consequences. The tools here are purely from dynamical systems.

Corollary 6.3. *Let \mathcal{F} be a Reebless foliation with one sided branching in M^3 atoroidal. Then $\pi_1(M)$ is Gromov hyperbolic. For any leaf F of $\tilde{\mathcal{F}}$, then the limit set of F is not the whole sphere S_∞^2 .*

Proof. Let F be a leaf in $\tilde{\mathcal{F}}$. Choose E, L in the positive side of F non separated from each other. There is an unstable boundary component s of $\Theta(L)$ which separates $\Theta(L)$ from $\Theta(E)$.

Let S be a slice leaf in a leaf of $\tilde{\Lambda}^u$ with $\Theta(S) = s$. Then the limit set of S , Λ_S is a Jordan curve C – this is shown in [Fe3, Fe8]. Since S is disjoint from F then the limit set of F is contained in the closure of one complementary component of S in S_∞^2 . Therefore Λ_F is not S_∞^2 . \square

Remarks –

1) The remaining open case for the continuous extension question is contained in the case of two sided branching.

2) Many \mathbf{R} -covered examples in hyperbolic 3-manifolds which are not slitherings were constructed by Calegari in [Cal1]. Many explicit examples of foliations with one sided braching were constructed by Meigniez in [Me].

3) Suppose that \mathcal{F} is Reebless in M^3 with $\pi_1(M)$ negatively curved. It is asked in [Fe5, Fe12]: is \mathcal{F} \mathbf{R} -covered if and only if for some F in $\tilde{\mathcal{F}}$ then the limit set $\Lambda_F = S_\infty^2$? If \mathcal{F} is \mathbf{R} -covered then $\Lambda_F = S_\infty^2$ for every F in $\tilde{\mathcal{F}}$ [Fe2]. The converse is true if there is a compact leaf in \mathcal{F} [Go-Sh, Fe5].

The previous theorem shows that if \mathcal{F} has one sided branching then Λ_F is not S_∞^2 for any F in $\tilde{\mathcal{F}}$. Therefore the remaining open case is when \mathcal{F} has 2 sided branching.

4) The results of this article show that foliations in manifolds with Gromov hyperbolic fundamental group are very similar to surface Kleinian groups: the \mathbf{R} -covered case corresponds to doubly degenerate surface Kleinian groups, where the limit sets are the whole sphere. The foliations with one sided branching correspond to singly degenerate Kleinian groups where there is a single component of the domain of discontinuity. It remains to be seen whether foliations with 2 sided branching behave like non degenerate surface Kleinian groups.

References

- [Ba] T. Barbot, *Caractérisation des flots d'Anosov pour les feuilletages*, Erg. Th. Dyn. Sys. **15** (1995) 247-270.
- [Be-Me] M. Bestvina and G. Mess, *The boundary of negatively curved groups*, Jour. Amer. Math. Soc. **4** (1991) 469-481.
- [Bl-Ca] S. Bleiler and A. Casson, *Automorphisms of surfaces after Nielsen and Thurston*, Cambridge Univ. Press, 1988.
- [Bo1] B. Bowditch, *A topological characterization of hyperbolic groups*, Jour. A.M.S. **11** (1998) 643-667.
- [Bo2] B. Bowditch, *Convergence groups and configuration spaces*, in "Group Theory Down Under", Ed. J. Cossey, C.F. Miller, W.D.Newmann, M. Shapiro, 23-54 de Gruyter Berlin 1999.
- [Cal1] D. Calegari, *\mathbf{R} covered foliations of hyperbolic 3-manifolds*, Geom. Topol. **3** (1999) 137-153.
- [Cal2] D. Calegari, *The geometry of \mathbf{R} -covered foliations*, Geom. Topol. **4** (2000) 457-515 (eletronic).
- [Cal3] D. Calegari, *Foliations with one-sided branching*, Geom. Ded. **96** (2003) 1-53.
- [Cal4] D. Calegari, *Universal circles for quasigeodesic flows*, eprint math.GT/0406040.
- [Cal5] D. Calegari, *Promoting essential laminations*, eprint math.GT/0210148.
- [Ca-Du] D. Calegari and N. Dunfield, *Laminations and groups of homeomorphisms of the circle*, Inven. Math. **152** (2003) 149-204.
- [Ca] A. Candel, *Uniformization of surface laminations*, Ann. Sci. Ecole Norm. Sup. **26** (1993) 489-516.
- [Ca-Th] J. Cannon and W. Thurston, *Group invariant Peano curves*, preprint, 1987.
- [CDP] M. Coornaert, T. Delzant and A. Papadopoulos, *Géométrie and théorie des groupes, Les groupes hyperboliques de Gromov*, Lec. Notes in Math **1441** Springer (1991).
- [Fe1] S. Fenley, *Asymptotic properties of depth one foliations in hyperbolic 3-manifolds*, Jour. Diff. Geom. **36** (1992) 269-313.
- [Fe2] S. Fenley, *Quasi-isometric foliations*, Topology **31** (1992) 667-676.
- [Fe3] S. Fenley, *Anosov flows in 3-manifolds*, Ann. of Math. **139** (1994) 79-115.
- [Fe4] S. Fenley, *Quasigeodesic Anosov flows and homotopic properties of flow lines*, Jour. Diff. Geom. **41** (1995) 479-514.
- [Fe5] S. Fenley, *Limit sets of foliations*, Topology **37** (1998) 875-894.
- [Fe6] S. Fenley, *The structure of branching in Anosov flows of 3-manifolds*, Comm. Math. Helv. **73** (1998) 259-297.
- [Fe7] S. Fenley, *Local and global properties of Anosov foliations in 3-manifolds with negatively curved fundamental group*, Trans. A.M.S. **350** (1998) 3923-3941.
- [Fe8] S. Fenley, *Foliations with good geometry*, Jour. Amer. Math. Soc. **12** (1999) 619-676.
- [Fe9] S. Fenley, *Foliations, topology and geometry of 3-manifolds: \mathbf{R} -covered foliations and transverse pseudo-Anosov flows*, Comm. Math. Helv. **77** (2002) 415-490.
- [Fe10] S. Fenley, *Pseudo-Anosov flows and incompressible tori*, Geom. Ded. **99** (2003) 61-102.
- [Fe11] S. Fenley, *Regulating flows, topology of foliations and rigidity*, to appear in Trans. A.M.S.
- [Fe12] S. Fenley, *Geometry of foliations and flows I: Almost transverse pseudo-Anosov flows and asymptotic behavior of foliations*, eprint math.GT/0502330.
- [Fe-Mo] S. Fenley and L. Mosher, *Quasigeodesic flows in hyperbolic 3-manifolds*, Topology **222** (2001) 503-537.
- [Fr] E. Freden, *Negatively curved groups have the convergence property*, Ann. Acad. Sci.Fenn. Ser. A. Math. **20** (1995) 333-348.
- [Ga1] D. Gabai, *8 problems in foliations and laminations*, in Geometric Topology, W. Kazez, ed., Amer. Math. Soc. 1987, 1-33.
- [Ga2] D. Gabai, *On the geometric and topological rigidity of hyperbolic 3-manifolds*, Jour. Amer. Math. Soc. **10** (1997) 37-74.

- [Ga3] D. Gabai, *Quasi-minimal semi-Euclidean laminations in 3-manifolds*, Surveys in differential geometry, **III** (1996) 195-242.
- [Ga-Ka] D. Gabai and W. Kazez, *Group negative curvature for 3-manifolds with genuine laminations*, Geom. Top. **2** (1998) 65-77.
- [GMT] D. Gabai, R. Meyerhoff and N. Thurston, *Homotopy hyperbolic 3-manifolds are hyperbolic*, Ann. of Math. **157** (2003) 335-431.
- [Ga-Oe] D. Gabai and U. Oertel, *Essential laminations and 3-manifolds*, Ann. of Math. **130** (1989) 41-73.
- [Ge-Ma] F. Gehring and G. Martin, *Discrete quasiconformal groups I*, Proc. London Math.Soc. bf **55** (1987) 331-358.
- [Gh-Ha] E. Ghys and P. De la Harpe, editors, *Sur les groupes hyperboliques d'après Mikhael Gromov*, Progress in Math. **83**, Birkhäuser, 1990.
- [Go-Sh] S. Goodman and S.Shields, *A condition for the stability of \mathbf{R} -covered foliations in 3-manifolds*, Trans. A.M.S. **352** (2001) 4051-4065.
- [Gr] M. Gromov, *Hyperbolic groups*, in Essays on Group theory, Springer-Verlag, 1987, pp. 75-263.
- [Han] M. Handel *Global shadowing pseudo-Anosov homeomorphisms* Erg. Th. Dyn. Sys. **5** (1985) 373-377.
- [Ke] J. Kelley, *General Topology*, Graduate Texts in Mathematics, **27**, Springer, 1955.
- [Man] B. Mangum, *Incompressible surface and pseudo-Anosov flows*, Topol. Appl. **87** (1998) 29-51.
- [Me] G. Meigniez, *Bouts d'un groupe opérant sur la droite: 2. Applications á la topologie de feuilletages*, Tôhoku Math. Jour. **43** (1991) 473-500.
- [Mor] J. Morgan, *On Thurston's uniformization theorem for 3-dimensional manifolds*, in The Smith Conjecture, J. Morgan and H. Bass, eds., Academic Press, New York, 1984, 37-125.
- [Mo1] L. Mosher, *Dynamical systems and the homology norm of a 3-manifold II*, Invent. Math. **107** (1992) 243-281.
- [Mo2] L. Mosher, *Examples of quasigeodesic flows on hyperbolic 3-manifolds*, in Proceedings of the Ohio State University Research Semester on Low-Dimensional topology, W. de Gruyter, 1992.
- [Mo3] L. Mosher, *Laminations and flows transverse to finite depth foliations*, Part I: Branched surfaces and dynamics – available from <http://newark.rutgers.edu:80/~mosher/>, Part II in preparation.
- [Mu] J. Munkres, *A first course in Topology*, Prentice Hall, 2000.
- [Ot1] J. P. Otal, *The hyperbolization theorem for fibered 3-manifolds*, SMF/AMS texts and monographs **7** 2001.
- [Ot2] J. P. Otal, *Thurston's hyperbolization theorem for Haken manifolds*, Surveys in differential geometry, **III** (1996) 77-194.
- [Pe1] G. Perelman, *The entropy formulat for the Ricci flow and its geometric applications*, eprint math.DG/0211159.
- [Pe2] G. Perelman, *Ricci flow with surgery on 3-manifolds*, eprint math.DG/0303109.
- [Pe3] G. Perelman, *Finite extinction time for the solutions to the Ricci flow in certain 3-manifolds*, eprint math.DG/0307245.
- [Ro-St] R. Roberts and M. Stein, *Group actions on order trees*, Topol. Appl. **115** (2001) 175-201.
- [Th1] W. Thurston, *The geometry and topology of 3-manifolds*, Princeton University Lecture Notes, 1982.
- [Th2] W. Thurston, *Three dimensional manifolds, Kleinian groups and hyperbolic geometry*, Bull. A.M.S. **6** (1982) 357-381.
- [Th3] W. Thurston, *Hyperbolic structures on 3-manifolds II: Surface groups and 3-manifolds that fiber over the circle*, preprint.
- [Th4] W. Thurston, *On the geometry and dynamics of diffeomorphisms of surfaces*, Bull. A.M.S. **19** (1988) 417-431.
- [Th5] W. Thurston, *3-manifolds, foliations and circles I*, preprint.
- [Tu1] P. Tukia, *Convergence groups and Gromov's metric hyperbolic spaces*, New Zealand J. Math. **23** (1994) 157-187.
- [Tu2] P. Tukia, *Conical limit points and uniform convergence groups*, J. Reine Angew. Math. **501** (1998) 71-98.
- [Wi] R. Wilder, *Topology of Manifolds*, A.M.S. Colloquium Publ. **32** (1949).