

A LOWER BOUND FOR THE NUMBER OF REIDEMEISTER MOVES OF TYPE III

J. SCOTT CARTER, MOHAMED ELHAMDADI, MASAHICO SAITO, AND SHIN SATOH

Dedicated to Professor Louis H. Kauffman for his 60th birthday

ABSTRACT. We study the number of Reidemeister type III moves using Fox n -colorings of knot diagrams.

1. INTRODUCTION

Any two oriented diagrams in the plane \mathbb{R}^2 representing the same knot or link are related by a finite sequence of Reidemeister moves of type I, II, and III and planar isotopies on the underlying graph. For instance, Figure 1 illustrates three pairs of oriented diagrams representing the (i) trefoil knot, (ii) figure-eight knot, and (iii) (2, 4)-torus link, respectively. The reader can construct such finite sequence of Reidemeister moves for each pair.

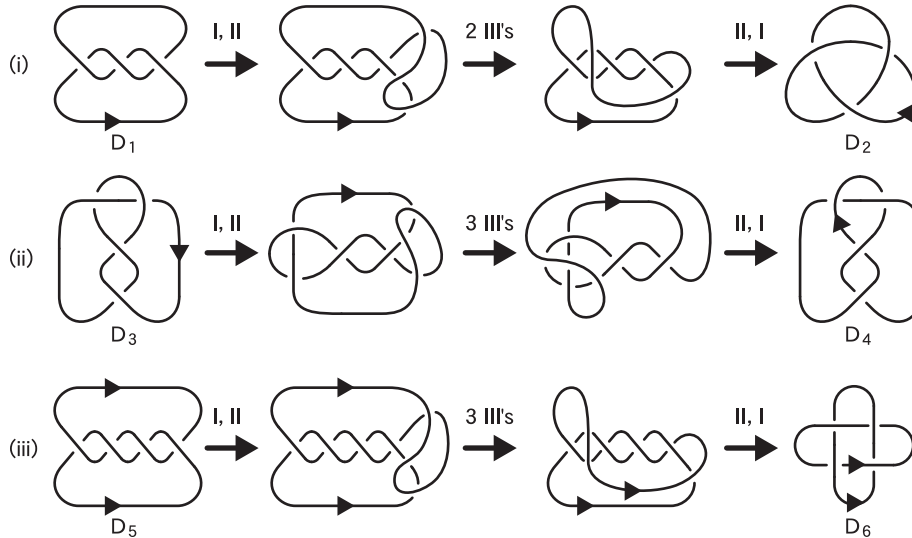

FIGURE 1.

The main topic of the paper is the minimal number of Reidemeister moves of type III for all possible sequences relating two given oriented diagrams: For a pair

2000 *Mathematics Subject Classification.* Primary 57M25.

Key words and phrases. Reidemeister type III moves, Fox colorings, quandle cocycle invariants.

of oriented diagrams (D, D') of a knot or link, we denote by $\Omega_3(D, D')$ the minimal number of type III moves connecting D and D' . Then we prove the following.

Theorem 1.1. *The oriented diagrams D_i ($i = 1, 2, \dots, 6$) in Figure 1 satisfy*

- (i) $\Omega_3(D_1, D_2) = 2$,
- (ii) $\Omega_3(D_3, D_4) = 3$, and
- (iii) $\Omega_3(D_5, D_6) = 3$.

We remark that if a diagram is considered as lying on the 2-sphere $S^2 = \mathbb{R}^2 \cup \{\infty\}$, then an outside arc of the diagram can be thrown through ∞ , see Figure 2. By allowing this move, the diagram D_{2i-1} ($i = 1, 2, 3$) in Figure 1 can be deformed into D_{2i} without any Reidemeister moves. We also remark that the number of type III moves is related to the minimal number of triple points in projections in 3-space of embedded surfaces in 4-space [7].

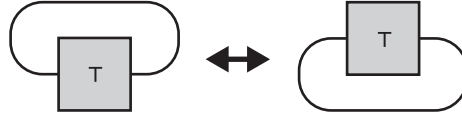

FIGURE 2.

This paper is organized as follows: In Section 2, we review the Fox coloring for diagrams, which will be used to prove Theorem 1.1 in Section 3.

2. PRELIMINARIES

Let D be a (possibly unoriented) link diagram in \mathbb{R}^2 , which is an illustration of the projection of a link with small gaps at crossings to indicate over-under information. Thus D is regarded as a disjoint union of arcs, and we denote by $\text{Arc}(D)$ the set of the arcs of D . Let n be a positive integer, and $\mathbb{Z}(n) = \{0, 1, \dots, n-1\}$ the set of integers between 0 and $n-1$ inclusive. Given a map $\varphi : \text{Arc}(D) \rightarrow \mathbb{Z}(n)$, we call $\varphi(\alpha)$ the *color* of an arc $\alpha \in \text{Arc}(D)$. We say that this map φ is a *Fox n -coloring* [4] or simply *n -coloring* for D if the equality $a + c \equiv 2b \pmod{n}$ holds at each crossing of D , where a and c are the colors of the two under-arcs, and b is the color of the over-arc at the crossing. See the right of Figure 3, where we denote by $x * y$ the integer k in $\mathbb{Z}(n)$ satisfying $k \equiv 2y - x \pmod{n}$ for $x, y \in \mathbb{Z}(n)$.

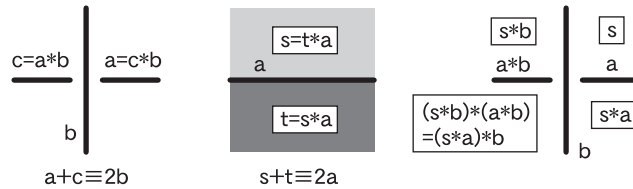

FIGURE 3.

In this paper, we use *extended n -colorings* that were originally introduced in [6] (see also [2]). Let D_* be the set of immersed circle(s) in \mathbb{R}^2 obtained from D by ignoring crossing information, and $\text{Region}(D)$ be the set of connected regions of the

complement $\mathbb{R}^2 \setminus D_*$. A map $\bar{\varphi} : \text{Arc}(D) \cup \text{Region}(D) \rightarrow \mathbb{Z}(n)$ is called an extended n -coloring if (i) $\varphi = \bar{\varphi}|_{\text{Arc}(D)}$ is the original Fox n -coloring, and (ii) the equality $s + t \equiv 2a \pmod{n}$ holds at every point on D except crossings, where s and t are the colors of the two regions around the point, and a is the color of the arc on which the point lies. See the center of Figure 3. We remark that there are no additional conditions around a crossing as shown in the right figure; indeed, it holds that

$$\begin{cases} (s * b) * (a * b) \equiv 2(2b - a) - (2b - s) \equiv -2a + 2b + s, \\ (s * a) * b \equiv 2b - (2a - s) \equiv -2a + 2b + s \end{cases}$$

modulo n , which implies that $(s * b) * (a * b) = (s * a) * b$ in $\mathbb{Z}(n)$.

Given an n -coloring φ for D and an integer $s \in \mathbb{Z}(n)$, there is a unique extended n -coloring $\bar{\varphi}$ for D such that the color of the outermost region in $\text{Region}(D)$ is s . We denote it by $\bar{\varphi} = (\varphi, s)$. We say that an extended n -coloring $\bar{\varphi} = (\varphi, s)$ is *trivial* if φ is a constant map, that is, all the arcs have the same color. Otherwise, $\bar{\varphi}$ is called *non-trivial*.

Assume that a diagram D' is obtained from D by a single Reidemeister move. If D has an extended n -coloring $\bar{\varphi}$, then there is a unique extended n -coloring $\bar{\varphi}'$ for D' such that these two colorings are coincident in the exterior of the disk where the Reidemeister move is performed. Figure 4 shows such Reidemeister moves between the pairs $(D, \bar{\varphi})$ and $(D', \bar{\varphi}')$. Note that if $\bar{\varphi} = (\varphi, s)$, then $\bar{\varphi}' = (\varphi', s)$ for some n -coloring φ' for D' ; that is, Reidemeister moves keep the color of the outermost region. Also, if $\bar{\varphi}$ is non-trivial, then so is $\bar{\varphi}'$.

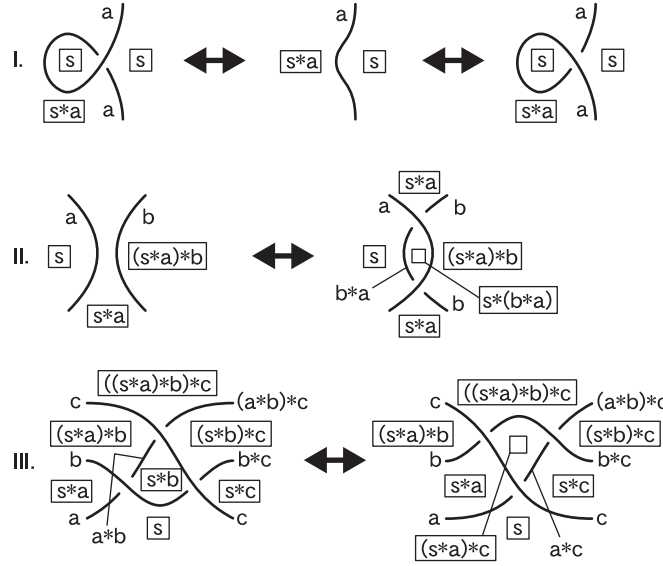

FIGURE 4.

Let $f : \mathbb{Z}(n)^3 \rightarrow \mathbb{Z}$ be a function from the set $\mathbb{Z}(n)^3 = \mathbb{Z}(n) \times \mathbb{Z}(n) \times \mathbb{Z}(n)$ to \mathbb{Z} which satisfies the condition $(\#)$ if $y = z$ then $f(x, y, z) = 0$. For a pair $(D, \bar{\varphi})$ of an oriented diagram D and its extended n -coloring $\bar{\varphi}$, we define an integer $\mathbb{W}_f(D, \bar{\varphi})$ as follows: Around a crossing τ of D , let $a_\tau \in \mathbb{Z}(n)$ be the color of the under-arc on the right side of the over-arc with respect to the orientation of the over-arc, let

$b_\tau \in \mathbb{Z}(n)$ be the color of the over-arc, and let $s_\tau \in \mathbb{Z}(n)$ be the color of the region on the right side of the over- and under-arcs both with respect to their orientations. Also, let $\varepsilon_\tau \in \{+1, -1\}$ be the sign of the crossing τ . The left and right of Figure 5 show such a triple (s_τ, a_τ, b_τ) with $\varepsilon_\tau = +1$ and -1 , respectively. Then we define $\mathbb{W}_f(D, \overline{\varphi}) = \sum_\tau \varepsilon_\tau f(s_\tau, a_\tau, b_\tau) \in \mathbb{Z}$, where the sum is taken over all the crossings τ of D .

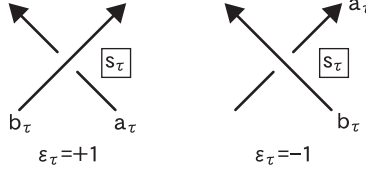

FIGURE 5.

Associated with a function $f : \mathbb{Z}(n)^3 \rightarrow \mathbb{Z}$ which satisfies the property (#), we define the function $\delta f : \mathbb{Z}(n)^4 \rightarrow \mathbb{Z}$ by

$$\begin{aligned} (\delta f)(x, y, z, w) &= f(x, z, w) - f(x, y, w) + f(x, y, z) \\ &\quad - f(x * y, z, w) + f(x * z, y * z, w) - f(x * w, y * w, z * w). \end{aligned}$$

This definition is motivated from the coboundary operator of rack and quandle homology theories [1, 3].

Lemma 2.1. *Assume that a pair $(D, \overline{\varphi})$ of an oriented diagram and its extended n -coloring is related to $(D', \overline{\varphi}')$ by a single Reidemeister move.*

- (i) *If the move is of type I or II, then $\mathbb{W}_f(D, \overline{\varphi}) = \mathbb{W}_f(D', \overline{\varphi}')$.*
- (ii) *If the move is of type III, then $\mathbb{W}_f(D, \overline{\varphi}) - \mathbb{W}_f(D', \overline{\varphi}') \in \pm \text{Im}(\delta f)$.*

Proof. (i) If the move is of type I in the first row of Figure 4, we obtain $\mathbb{W}_f(D, \overline{\varphi}) - \mathbb{W}_f(D', \overline{\varphi}') = \pm f(s, a, a) = 0$ by the condition (#). Assume that the move is of type II in the second row of the figure. If the two arcs are both oriented downward, then it holds that $\mathbb{W}_f(D, \overline{\varphi}) - \mathbb{W}_f(D', \overline{\varphi}') = \pm [f(s, b * a, a) - f(s, b * a, a)] = 0$. Other cases are similarly proved.

(ii) We may assume that the three arcs in the bottom row are oriented from left to right. Then all the crossing are positive, and it holds that

$$\begin{aligned} \mathbb{W}_f(D, \overline{\varphi}) - \mathbb{W}_f(D', \overline{\varphi}') &= \pm [f(s, a, b) + f(s * b, a * b, c) + f(s, b, c) \\ &\quad - f(s * a, b, c) - f(s, a, c) - f(s * c, a * c, b * c)] \\ &= \pm (\delta f)(s, a, b, c), \end{aligned}$$

which belongs to the set $\pm \text{Im}(\delta f)$. \square

Let D be an oriented diagram, $f : \mathbb{Z}(n)^3 \rightarrow \mathbb{Z}$ a function with the property (#), s an integer in $\mathbb{Z}(n)$, and m a non-negative integer. We define two finite sets of integers as follows:

- $\Phi_f(D, s) = \{\mathbb{W}_f(D, \overline{\varphi}) \mid \overline{\varphi} = (\varphi, s) \text{ is a non-trivial } n\text{-coloring for } D\}$.
- $\Delta_m(f) = \{k_1 + k_2 + \cdots + k_m \mid k_1, k_2, \dots, k_m \in \pm \text{Im}(\delta f)\}$.

Here we put $\Delta_0(f) = \{0\}$ for convenience.

Proposition 2.2. *Let D and D' be oriented diagrams of the same knot or link. If there is a non-trivial extended n -coloring $\bar{\varphi} = (\varphi, s)$ for D and a function $f : \mathbb{Z}(n)^3 \rightarrow \mathbb{Z}$ with the property (#) such that*

$$[\mathbb{W}_f(D, \bar{\varphi}) - \Phi_f(D', s)] \cap \Delta_i(f) = \emptyset$$

for any $i = 0, 1, \dots, m-1$, then $\Omega_3(D, D') \geq m$ holds, where $\mathbb{W}_f(D, \bar{\varphi}) - \Phi_f(D', s)$ stands for the finite set of integers $\{\mathbb{W}_f(D, \bar{\varphi}) - w \mid w \in \Phi_f(D', s)\}$.

Proof. Put $\omega = \Omega_3(D, D')$. There is a finite sequence of Reidemeister moves between D and D' , in which there are ω moves of type III. For the extended n -coloring $\bar{\varphi}' = (\varphi', s)$ for D' associated with $\bar{\varphi} = (\varphi, s)$ for D , it follows that $\mathbb{W}(D, \bar{\varphi}) - \mathbb{W}(D', \bar{\varphi}') \in \Delta_\omega(f)$ by Lemma 2.1. Hence, we have $\omega \geq m$. \square

3. PROOF OF THEOREM 1.1

(i) We take a function $\mathbb{Z}(3)^3 \rightarrow \mathbb{Z}$ defined by $f(x, y, z) = (x - y)(y - z)z$, which satisfies the condition (#). This definition of f by a polynomial is motivated from [5]. Let $\bar{\varphi} = (\varphi, 0)$ be the extended 3-coloring for D_1 as shown in the left of Figure 6. For the left crossing, say τ , we have the triple $(s_\tau, a_\tau, b_\tau) = (2, 2, 1)$ by definition. Similarly, the center and right crossings have the triples $(2, 0, 2)$ and $(2, 1, 0)$, respectively. Since the signs of these crossings are all positive, the integer $\mathbb{W}_f(D_1; \bar{\varphi})$ is calculated by

$$\begin{aligned} \mathbb{W}_f(D_1; \bar{\varphi}) &= +f(2, 2, 1) + f(2, 0, 2) + f(2, 1, 0) \\ &= (2 - 2)(2 - 1)1 + (2 - 0)(0 - 2)2 + (2 - 1)(1 - 0)0 = -8. \end{aligned}$$

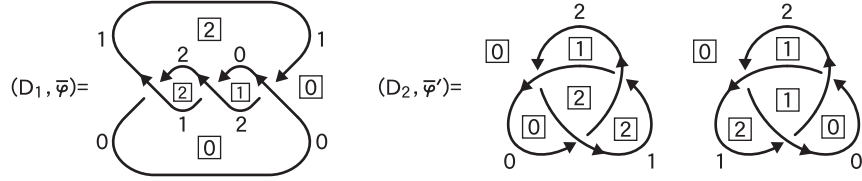

FIGURE 6.

There are two cases for non-trivial extended 3-colorings $\bar{\varphi}' = (\varphi', 0)$ for the diagram D_2 , that are shown in the right of Figure 6. The integer $\mathbb{W}_f(D_2, \bar{\varphi}')$ for each coloring is calculated by

$$\begin{cases} +f(0, 0, 1) + f(0, 1, 2) + f(0, 2, 0) = 0 + 2 + 0 = +2, \text{ and} \\ +f(0, 1, 0) + f(0, 0, 2) + f(0, 2, 1) = 0 + 0 - 2 = -2. \end{cases}$$

Thus we obtain $\Phi_f(D_2, 0) = \{\pm 2\}$ and hence,

$$\mathbb{W}_f(D_1, \bar{\varphi}) - \Phi_f(D_2, 0) = \{-10, -6\}.$$

Next we calculate the set $\text{Im}(\delta f)$ for the map f as above. Since $a * a = a$ holds for any $a \in \mathbb{Z}(3)$, we have $(\delta f)(x, y, z, w) = 0$ for $x = y$, $y = z$, or $z = w$. The calculations for $x \neq y \neq z \neq w$ are given in Table 1. For example, the calculation

for $(x, y, z, w) = (0, 1, 0, 1)$ is:

$$\begin{aligned}
 (\delta f)(0, 1, 0, 1) &= f(0, 0, 1) - f(0, 1, 1) + f(0, 1, 0) \\
 &\quad - f(0 * 1, 0, 1) + f(0 * 0, 1 * 0, 1) - f(0 * 1, 1 * 1, 0 * 1) \\
 &= f(0, 0, 1) - f(0, 1, 1) + f(0, 1, 0) \\
 &\quad - f(2, 0, 1) + f(0, 2, 1) - f(2, 1, 2) \\
 &= 0 - 0 + 0 + 2 - 2 + 2 = +2.
 \end{aligned}$$

x	y	z	w	δf
0	1	0	1	+2
			2	+7
		0	+4	
	2	0	1	-1
			2	+11
		1	+7	
1	0	1	0	+7
			2	+5
		0	-2	
	2	1	0	-4
			1	+4
		2	-4	
2	0	1	0	+2
			2	+4
		0	-7	
	1	2	1	-5
			2	-4
		0	-1	
2	1	0	-5	
		2	-4	
	2	-1		

x	y	z	w	δf
1	0	1	0	+7
			2	+5
		0	-2	
	2	1	0	-4
			1	+4
		2	-4	
2	0	1	0	+2
			2	+4
		0	-7	
	1	2	1	-5
			2	-4
		0	-1	
2	1	0	-5	
		2	-4	
	2	-1		

TABLE 1.

Hence we obtain

$$\Delta_1(f) = \pm \text{Im}(\delta f) = \{0, \pm 1, \pm 2, \pm 4, \pm 5, \pm 7, \pm 8, \pm 11\}.$$

From the above calculations, it is easy to check that

$$[\mathbb{W}_f(D_1, \bar{\varphi}) - \Phi_f(D_2, 0)] \cap \Delta_i(f) = \emptyset \text{ for } i = 0, 1.$$

It follows that $\Omega_3(D_1, D_2) \geq 2$ by Proposition 2.2. The first row of Figure 1 shows $\Omega_3(D_1, D_2) \leq 2$, which implies $\Omega_3(D_1, D_2) = 2$.

(ii) We use the function $f : \mathbb{Z}(5)^3 \rightarrow \mathbb{Z}$ defined by $f(x, y, z) = (x + y)^3(y + z)(y - z)^3z^5$. For the extended 5-coloring $\bar{\varphi} = (\varphi, 2)$ as shown in the left of Figure 7, we have

$$\begin{aligned}
 \mathbb{W}_f(D_3, \bar{\varphi}) &= -f(3, 2, 0) - f(0, 1, 3) + f(4, 1, 2) + f(4, 2, 1) \\
 &= 0 + 7776 - 12000 + 648 = -3576.
 \end{aligned}$$

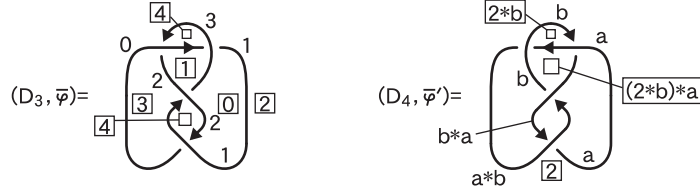

FIGURE 7.

All possible non-trivial extended 5-colorings $\bar{\varphi}' = (\varphi', 2)$ for D_4 are indicated in the right of Figure 7, where $a \neq b \in \mathbb{Z}(5)$. Then the integer $\mathbb{W}_f(D_4, \bar{\varphi}')$ is given by

$$\mathbb{W}_f(D_4, \bar{\varphi}') = +f(2 * b, a, b) + f(2 * b, b, a) - f((2 * b) * a, b, b * a) - f(2, a, a * b).$$

Table 2 shows all the values $\mathbb{W}_f(D_4, \bar{\varphi}')$ for $a \neq b \in \mathbb{Z}(5)$.

a	b	$\mathbb{W}_f(D_4, \bar{\varphi}')$	a	b	$\mathbb{W}_f(D_4, \bar{\varphi}')$	a	b	$\mathbb{W}_f(D_4, \bar{\varphi}')$
0	1	+142336	1	0	+3765221	2	0	+326080
	2	+2244931		2	+207552		1	+971928
	3	-1269944		3	+587264		3	+2937304
	4	-173800		4	-1299078		4	-1135296

a	b	$\mathbb{W}_f(D_4, \bar{\varphi}')$	a	b	$\mathbb{W}_f(D_4, \bar{\varphi}')$
3	0	-551414	4	0	-7107048
	1	+889088		1	-490872
	2	+10555072		2	-2814033
	4	-344431		3	-1919488

TABLE 2.

On the other hand, we compute the set $\text{Im}(\delta f)$ by using *Maple* and *Mathematica*, and find that it is a set consisting of 393 integers. Computer calculations also show that

$$[\mathbb{W}_f(D_3, \bar{\varphi}) - \Phi_f(D_4, 2)] \cap \Delta_i(f) = \emptyset \text{ for } i = 0, 1, 2,$$

and hence we obtain $\Omega_3(D_3, D_4) \geq 3$ by Proposition 2.2. The second row of Figure 1 shows $\Omega_3(D_3, D_4) \leq 3$, which implies $\Omega_3(D_3, D_4) = 3$.

(iii) We use the function $f : \mathbb{Z}(4)^3 \rightarrow \mathbb{Z}$ defined by $f(x, y, z) = (x+y)^2(y-z)^3z^5$. Let $\bar{\varphi} = (\varphi, 0)$ be the extended 4-coloring for D_5 as shown in the left of Figure 8. Then it holds that

$$\begin{aligned} \mathbb{W}_f(D_5, \bar{\varphi}) &= +f(2, 1, 0) + f(2, 0, 3) + f(2, 3, 2) + f(2, 2, 1) \\ &= 0 - 26244 + 800 + 16 = -25428. \end{aligned}$$

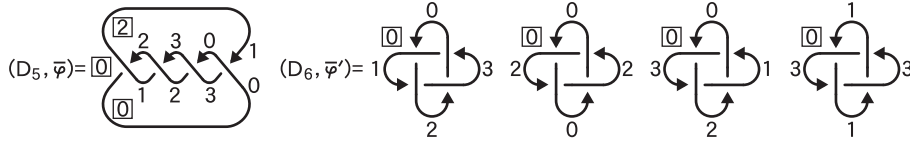

FIGURE 8.

Any non-trivial extended 4-coloring $\bar{\varphi}'$ for D_6 belongs to one of the four cases (up to rotations of D_6) as shown in the right of Figure 8. The integer $\mathbb{W}_f(D_6, \bar{\varphi}')$ for each coloring is calculated by

$$\begin{cases} +f(0, 0, 1) + f(0, 1, 2) + f(0, 2, 3) + f(0, 3, 0) = 0 - 32 - 972 + 0 = -1004, \\ +f(0, 0, 2) + f(0, 2, 0) + f(0, 0, 2) + f(0, 2, 0) = 2(0 + 0) = 0, \\ +f(0, 0, 3) + f(0, 3, 2) + f(0, 2, 1) + f(0, 1, 0) = 0 + 288 + 4 + 0 = 292, \\ +f(0, 1, 3) + f(0, 3, 1) + f(0, 1, 3) + f(0, 3, 1) = 2(-1944 + 72) = -3744. \end{cases}$$

Hence we obtain

$$\Phi_f(D_6, 0) = \{-3744, -1004, 0, 292\}$$

and

$$\mathbb{W}_f(D_5, \bar{\varphi}) - \Phi_f(D_6, 0) = \{-25720, -25428, -24424, -21684\}.$$

We note that it is not necessary, in fact, to check the second and the fourth colorings, since the coloring of the left-hand-side assigns numbers of distinct parities for each component, so that this property will be preserved on the right-hand-side.

On the other hand, we compute the set $\text{Im}(\delta f)$ by using computers again as we did for the figure-eight knot, and find that it consists of 105 integers, and also find that

$$[\mathbb{W}_f(D_5, \overline{\varphi}) - \Phi_f(D_6, 0)] \cap \Delta_i(f) = \emptyset \text{ for } i = 0, 1, 2,$$

and hence we obtain $\Omega_3(D_5, D_6) \geq 3$ by Proposition 2.2. The bottom row of Figure 1 shows $\Omega_3(D_5, D_6) \leq 3$, which implies $\Omega_3(D_5, D_6) = 3$. This completes the proof.

ACKNOWLEDGMENTS

The authors are partially supported by NSF Grant DMS #0301095, University of South Florida Faculty Development Grant, NSF Grant DMS #0301089, and JSPS Postdoctoral Fellowships for Research Abroad, respectively. The fourth author expresses his gratitude for the hospitality of the University of South Florida and the University of South Alabama.

REFERENCES

- [1] J. S. Carter; D. Jelsovsky; S. Kamada; L. Langford; M. Saito, *Quandle cohomology and state-sum invariants of knotted curves and surfaces*, Trans. Amer. Math. Soc. **355** (2003) 3947–3989.
- [2] J. S. Carter, S. Kamada and M. Saito, *Geometric interpretations of quandle homology*, J. Knot Theory Ramifications **10** (2001) 345–386.
- [3] Fenn, R.; Rourke, C.; Sanderson, B., *An introduction to species and the rack space*, Topics in knot theory (Erzurum, 1992), 33–55, NATO Adv. Sci. Inst. Ser. C Math. Phys. Sci., 399, Kluwer Acad. Publ., Dordrecht, 1993.
- [4] R. H. Fox, *A quick trip through knot theory*, in “Topology of 3-manifolds and related topics (Georgia, 1961),” Prentice-Hall (1962) 120–167.
- [5] T. Mochizuki, *Some calculations of cohomology groups of finite Alexander quandles*, J. Pure Appl. Algebra **179** (2003) 287–330.
- [6] C. Rourke; B. Sanderson, *A new classification of links and some calculations using it*, Preprint, available at: <http://xxx.lanl.gov/abs/math.GT/0006062>.
- [7] S. Satoh and A. Shima, *The 2-twist-spun trefoil has the triple point number four*, Trans. Amer. Mat. Soc. **356** (2004) 1007–1024.

DEPARTMENT OF MATHEMATICS, UNIVERSITY OF SOUTH ALABAMA, MOBILE, AL 36688, U.S.A.
E-mail address: `carter@jaguar1.usouthal.edu`

DEPARTMENT OF MATHEMATICS, UNIVERSITY OF SOUTH FLORIDA, TAMPA, FL 33620, U.S.A.
E-mail address: `emohamed@math.usf.edu`

DEPARTMENT OF MATHEMATICS, UNIVERSITY OF SOUTH FLORIDA, TAMPA, FL 33620, U.S.A.
E-mail address: `saito@math.usf.edu`

GRADUATE SCHOOL OF SCIENCE AND TECHNOLOGY, CHIBA UNIVERSITY, YAYOI-CHO 1-33, INAGE-KU, CHIBA, 263-8522, JAPAN (DEPARTMENT OF MATHEMATICS, UNIVERSITY OF SOUTH FLORIDA, APRIL 2003–MARCH 2005)

E-mail address: `satoh@math.s.chiba-u.ac.jp`