

The Khovanov Complex for Virtual Links

Vassily Olegovich Manturov

1 Introduction

In the last few years, knot theory has enjoyed a rapidly developing generalisation, the *Virtual knot theory*, proposed by Louis Kauffman in 1996, see [Kau2]. A virtual link is a combinatorial generalisation of the notion of classical links: we consider *planar diagrams* with a new crossing type allowed; this new crossing (called virtual and marked by a circle) is neither an overcrossing nor an undercrossing. It should be treated as an artefact of two branches, which do not want to intersect but can not do without. This leads to a natural generalisation of Reidemeister moves for the virtual case: besides usual ones (which should be treated as local transformation inside a small 3-dimensional domain), we also add a *detour move*, which means the following. If there is arc of the diagram between some points A and B contains only virtual crossings, it can be removed and detoured as any other path connecting A and B ; all crossings which occur in this path are set to be virtual as shown in Fig. 1.

Thus, a *virtual link* is an equivalence class of virtual diagrams modulo generalised Reidemeister moves, the latter consisting of classical Reidemeister moves and the detour move.

Remark 1. *This definition allows to generalise some classical knot invariance; herewith the invariance under the detour move often happens to follow from the*

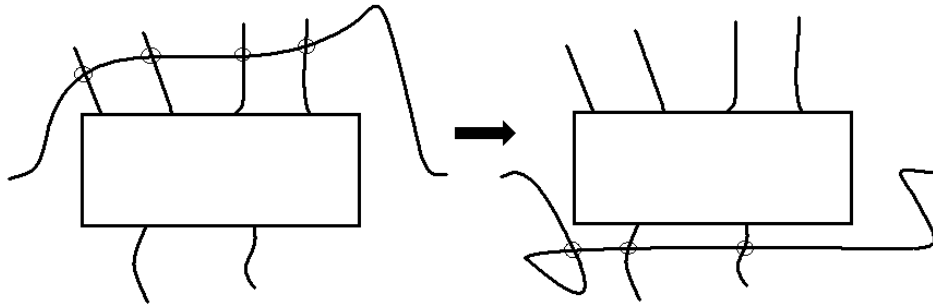

Figure 1: The detour move

definition, whence the classical move invariance repeats the invariance for the case of classical knots.

This approach leads to the following geometric definition for a virtual link: it is a link in a thickened 2-surface $S_g \times I$ considered up to homotopy and stabilisation/destabilisation; herewith virtual crossings correspond to “projection artefacts” while “projecting” the knot theory from $S_g \times I$ to $\mathbf{R}^2 \times I$ (here S_g is projected to the plane, whence the images of classical crossings represent classical crossings and intersections of branches, which do not intersect in $S_g \times I$, form virtual crossings. Thus, virtual links admit a geometrical definition, besides the combinatorial one.

Many known classical knot invariants were generalised for the virtual case, see, e.g. [Kau2, Man2, Man, Man1], in particular the Kauffman bracket and the Jones polynomial, [Kau2].

An outstanding achievement of the recent years classical knot theory of is a generalisation of the Jones polynomial (Kauffman bracket) proposed by Khovanov, [Kh1]. This generalisation is a *categorification* of the Jones polynomial in the following sense. We replace abstract polynomials by (co)homologies of graded complexes of vector spaces. Thus, with each link we associate a certain graded algebraic complex, such that all homologies of this complex are knot invariants, and the graded Euler characteristic coincides with the Jones polynomial.

In the sequel, we shall consider graded complexes $\mathcal{C} = \bigoplus_{i,j} \mathcal{C}^{i,j}$, with *height* i and *grading* j . The differential mapping is assumed to preserve the grading and shift the height by $+1$.

It would be more reasonable to call such complexes *cohomological*, but it is usual to say about *Khovanov homologies*, thus we shall say *chains*, *cycles*, *boundaries* instead of *cochains*, *cocycles*, *coboundaries*. For such complexes we define the *height shift* $\mathcal{C} \mapsto \mathcal{C}[k]$ and the *degree shift* $\mathcal{C} \mapsto \mathcal{C} \cdot \{l\}$ as follows: $(\mathcal{C}[k])^{i,j} = \mathcal{C}^{i-k,j}$; $(\mathcal{C} \cdot \{l\})^{i,j} = \mathcal{C}^{i,j-l}$. In the first case (height shift) all differentials are shifted accordingly. By *graded Euler characteristic* of a complex $\mathcal{C}^{i,j}$ is meant the alternating sum of graded dimensions of chain spaces, or, equivalently, that of homology spaces. For chain spaces we have $\chi(\mathcal{C}) = \sum_i (-1)^i q \dim \mathcal{C}^i = \sum_{i,j} (-1)^i q^j \dim \mathcal{C}^{i,j}$.

An outstanding property of the Khovanov homology is *functoriality* meaning the following. Having a cobordism in $\mathbf{R}^3 \times I$ between two links $K_1 \subset \mathbf{R}^3 \times \{0\}$ $K_2 \subset \mathbf{R}^3 \times \{1\}$, we get a natural mapping between Khovanov homologies $Kh(K_1) \rightarrow Kh(K_2)$, which represents a *cobordism invariant* (up to sign ± 1); in particular, when links K_1 K_2 are empty, the Khovanov homology gives an invariant of *2-links*, i.e. compact 2-surfaces embedded in \mathbf{R}^4 . This result was obtained independently by Khovanov, Bar-Natan, and Jacobsson. For more details see [BN2].

The aim of the present work is to generalise the Khovanov construction for the case of virtual knot. In view of Remark 1, the invariance proof for Khovanov homologies for virtual links can be simplified. Here, the most difficult part is the *definition* of the Khovanov complex to be really a graded complex (with

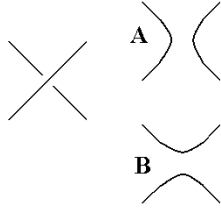

Figure 2: Two ways of smoothing

$d^2 = 0$). This work is represented in more details in the book [Man2].

We shall describe three ways for constructing the Khovanov homology for virtual links. The first one deals with arbitrary links and Khovanov homologies with \mathbf{Z}_2 -coefficients; the second approach leads to the Khovanov homologies for framed links (these homologies are constructed by doubling the initial link), the third approach is based on two-fold orienting coverings over virtual knots (in sense of atoms).

2 The Kauffman Bracket and Jones Polynomial. Atoms

Consider an oriented virtual diagram L and the diagram $|L|$ obtained from L by “forgetting” the orientation. Let us smooth classical crossings of the diagram $|L|$ according to the following rule. Each classical crossing can be *smoothed* in one of two ways: A B , see Fig. 2. The way of smoothing for all classical crossings of a diagram generates a *state* of it. Each state generates a set of curves on the plane; these curves have only virtual crossings. In other words, we have got a trivial virtual links; its components are unicursal curves.

Suppose the diagram L has n classical crossings. Let us enumerate them arbitrarily. Thus we have got 2^n states; these states are in one-to-one correspondence of the n -cube $\{0, 1\}^n$, where 0 and 1 correspond to A -smoothings and B -smoothing, respectively. Each state s has three important characteristics: the number $\alpha(s)$ of A -type smoothings, the number $\beta(s) = n - \alpha(s)$ of B -type smoothings and the number $\gamma(s)$ of link components in the corresponding state. After that, we define the Jones-Kauffman polynomial by the following formula:

$$X(L) = (-a)^{-3w(L)} \sum_s a^{\alpha(s)-\beta(s)} (-a^2 - a^{-2})^{\gamma(s)-1}, \quad (1)$$

where $w(L)$ is the linking number of the oriented diagram L (i.e. the difference between the number of positive classical crossings and the number of negative classical crossings), and $\alpha(s), \beta(s)$ are the numbers of A -type and B -type smoothings, respectively.

Figure 3: The modified Kauffman relation

The unnormalised version of the the Jones polynomial $\sum_s a^{\alpha(s)-\beta(s)} (-a^2 - a^{-2})$ is called *the Kauffman bracket*. The Kauffman bracket is defined for un-oriented links; it is invariant under the detour move, Ω_2, Ω_3 and the doubled version of the first Reidemeister move Ω_1^2 which consists in addition (removal) of two “adjacent” loops, for more details, see [Man2].

The variable change $a = \sqrt{(-q^{-1})}$ transformed the Jones polynomial to its modified version J . We shall also use a version denoted by \hat{J} . They differ by normalisation; thus, $J = 1$ on the unknot, whence $\hat{J} = 1$ on the empty unlink. Herewith, $J = \frac{\hat{J}}{(q+q^{-1})}$. Let us describe this construction in more details. Let L be an oriented virtual diagram with n classical crossings and let $|L|$ be the corresponding non-orientable virtual diagram. Let n_+ and n_- denote the numbers of positive and negative crossings of L , so that $n = n_+ + n_-$. Put

$$\hat{J}(L) = (-1)^{n-} q^{n_+ - 2n_-} \langle L \rangle, \quad (2)$$

where $\langle L \rangle$ is the modified Kauffman bracket defined according to the rule $\langle \bigcirc \rangle = 1$, and the modified Kauffman relation, see Fig. 3.

In the sequel, we shall deal with \hat{J} .

The equivalence classes of virtual diagrams modulo the detour move and the moves $\Omega_1^2, \Omega_2, \Omega_3$ are called *framed virtual links*; for framed virtual links there is a well defined operation of taking n “parallel copies”: $K \rightarrow D_n(K)$: when applying one of the moves $\Omega_1^2, \Omega_2, \Omega_3$ or the detour move (but not Ω_1) to the source diagram K , the diagram $D_n(K)$ is transformed to an equivalent diagram

The polynomial \hat{J} has a simple combinatorial description in terms of the state cub. Taking off the normalising coefficients $(-1)^{n-} q^{n_+ - 2n_-}$, we obtain a Kauffman bracket of the type $\sum_s (-q)^{\beta(s)} ((q + q^{-1})^{\gamma(s)})$, i.e. we take the sum over all vertices of the cube of $(-q)$ to the *height of the vertex* multiplied by $(q + q^{-1})$ to the number of circles corresponding to the vertex. Thus we can say that we replace each circle by $(q + q^{-1})$, then the polynomials are multiplied and “shifted” by some $\pm q^k$.

This means that the Jones polynomial can be recovered only by the information about the *numbers of vertices* in the cube state. Taking into account the information, *how the circles are reconstructed while passing from a state to an adjacent one*, we obtain the Khovanov homology.

Now, we describe an important construction that we shall use in the sequel. An *atom* is a pair (M, Γ) : compact 2-manifold M without boundary and a 4-

valent graph $\Gamma \subset M$ dividing M into cells with a fixed checkerboard colouring. The atoms are considered up to natural combinatorial equivalence: homeomorphisms of the manifolds mapping the frame to the frame and preserving the colour of cells. We shall not assume M to be connected; sometimes we shall need the case when M consists of two connected components.

Each atom (more precisely, its equivalence class) can be recovered from the following combinatorial data:

1. The frame (4-valent graph);
2. The A -structure (specifying for each vertex, which outgoing semiedges are *opposite*; this data is defined according to the local structure of opposite edges on the surface) and
3. B -structure (at each vertex we mark two pairs of adjacent (not opposite) semiedges (or, equivalently, two pairs of opposite angles) to form the local boundary of two black cells.

Starting from 1996, the author has been developing the connection between atoms and knots and virtual knots. We shall describe this connection later in the text. For more details, see [Man2].

3 The Khovanov Complex with \mathbf{Z}_2 -Coefficients]

In the present section, we present a result first proved in [Man1].

Let L be an orientable virtual link diagram. By *perestroika cube* we mean the cube $\{0, 1\}^n$ at each vertex of which we indicate the number of state (as in the state cube), and for each edge we show *how the set of circles is transformed* (new information). Associate with each circle the linear space V over \mathbf{Z}_2 generated by the two vectors v_+ and v_- , such that the grading of v_{\pm} is equal to ± 1 . To each vertex $s = \{a_1, \dots, a_n\}$ of the cube, there corresponds some number of circles to be defined by $\gamma(s)$. We replace such a vertex by the vector space $V^{\otimes \gamma(s)} \cdot \{\sum_{i=0}^n a_i\}$ which is obtained from the tensor power of the space V by a degree shift. This replacement of $(q + q^{-1})$ by V such that $\text{qdim} V = (q + q)^{-1}$ is a very important step in the categorification. Now we define the space of chains of the height k as the tensor sum of spaces related to all vertices of the height k .

Now, let us define the partial differential on the chains which act along the edges of the cube, as follows. Let an edge a correspond to the switch from a state s to a state s' ; herewith the l circles not adjacent to the crossing in question, are not changed. At the crossing of the diagram $|L|$ corresponding to the edge a , either one circle is transformed to two circles, or two circles are transformed to one circle, or one circle is transformed to one circle. In the first two cases we define the differential as before, namely, $\Delta \otimes Id^{\otimes l} \cdot \{1\}$ $m \otimes Id^{\otimes l} \cdot \{1\}$. Here the mappings $m : V \otimes V \rightarrow V$ and $\Delta : V \rightarrow V \otimes V$ are defined as follows.

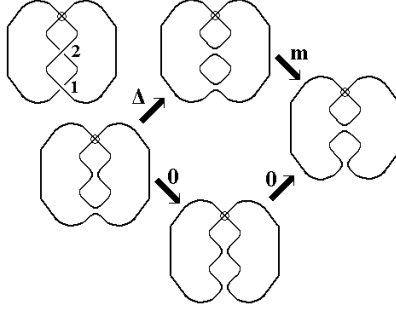

Figure 4: Checking the commutativity of a 2-face

The mapping m :

$$\begin{cases} v_+ \otimes v_- \mapsto v_-, v_+ \otimes v_+ \mapsto v_+, \\ v_- \otimes v_+ \mapsto v_-, v_- \otimes v_- \mapsto 0 \end{cases} \quad (3)$$

The mapping Δ :

$$\begin{cases} v_+ \mapsto v_+ \otimes v_- + v_- \otimes v_+ \\ v_- \mapsto v_- \otimes v_- \end{cases} \quad (4)$$

In the case of $(1 \rightarrow 1)$ -perestroika, we define the “partial differential” on the edge to map the whole space to zero. The question how to define the differential of type $(1 \rightarrow 1)$ well is the main difficulty in the common case; in the case of the field \mathbf{Z}_2 this difficulty can be overcome. Denote the obtained perestroika cube by $Q(L)$. In order for the differential to be well defined, the cube should be *commutative*, that is, for any 2-face of the cube, the composition of two mappings corresponding to one sequence of edges, should be equal to the (minus) composition corresponding to the other sequence of edges. Note that in this case (for the field \mathbf{Z}_2) the anticommutativity is equivalent to the commutativity.

Lemma 1. *The cube $Q(L)$ is commutative.*

This statement follows from a routine check analogous to that performed by Bar-Natan in [BN1]. We shall check only one case (the most interesting), see Fig. 4.

We have to show that the 2-mapping $m \circ \Delta : V \rightarrow V$ maps all space V to zero. Indeed, we have $v_- \mapsto v_- \otimes v_- \mapsto 0$, $v_+ \mapsto v_+ \otimes v_- + v_- \otimes v_+ \mapsto 2v_- = 0$ over the field \mathbf{Z}_2 .

Note that this is the only essential non-classical case, where we have a $1 \rightarrow 1$ -type perestroika. Indeed, it follows from parity, that the number of $1 - 1$ -perestroikas does not exceed two. If there are no such perestroikas at all, the question is reduced to one of the classical cases (all considered by Bar-Natan).

If there were two or four such perestroikas, then the 2-face in question

$$\begin{array}{ccc} V^{\otimes a}\{1\} & \xrightarrow{s} & V^{\otimes b}\{2\} \\ r \uparrow & & \uparrow q \\ V^{\otimes c} & \xrightarrow{p} & V^{\otimes d}\{1\} \end{array} \quad (5)$$

either each of the two compositions $q \circ p$ and $s \circ r$ contains a zero mapping $1 \rightarrow 1$ (for instance, in the case $a = b, c = d$ the mappings p and s are zeroes), or we have the case described above.

Put $\mathcal{C}(L) = Q'(|L|)\{n_+ - 2n_-\}[n_-]$. In this case $\mathcal{C}(L)$ is a well-defined complex. Denote the (bi)graded linear space of homologies for $\mathcal{C}(L)$ by $Kh(L)$ (or by $Kh_{\mathbf{Z}_2}(L)$ if we wish to underline that the Khovanov homology is considered over the field \mathbf{Z}_2).

Theorem 1. *$Kh(L)$ is an invariant of L . Furthermore, the graded Euler characteristic $\chi(Kh(L))$ equals $\hat{J}(L)$.*

The invariance of the Khovanov homology under classical Reidemeister moves is verbally the same as that proposed by Bar-Natan [BN1] for classical links; it is classical and deals with a local domain where a Reidemeister move is performed (and does not pay attention to what happens outside). The invariance under the detour move follows from the definition.

The second statement of the theorem follows from the fact that the Euler characteristic defined as the alternating sum of (graded) Betti numbers is equal the alternating sum of graded dimensions of chain spaces.

Note that the complex $\mathcal{C}(L)$ is splitted into two complexes: those of even grading and of odd grading (we remind that the differential preserves the grading).

Thus, we get **two** types of the Khovanov homology: the even one Kh^e and the odd one Kh^o .

They correspond to monomials of the Jones polynomial having degrees congruent to two modulo four (Kh^e) and monomials with degree divisible by four (Kh^o). For any classical link, we have only one of these sorts of homologies. More precisely, the following theorem holds.

Theorem 2. *For a classical even-component link, we have $Kh_o = 0$; for a classical odd-component link, we have $Kh_e = 0$.*

By a *virtualisation* we mean the following local transformation in a neighbourhood of a classical crossing, see Fig. 5.

Note that the \mathbf{Z}_2 -Khovanov complex, we have constructed is completely defined by the perestroika cube and the numbers n_+, n_- . Thus, the Khovanov homologies are invariant under virtualisations of the diagram.

In the next section, we shall give another construction of Khovanov homologies (for framed links). This approach is virtualisation-sensitive. The Khovanov complex given in this section coincides with the usual \mathbf{Z}_2 -Khovanov complex in the case of classical links; as mentioned above, it is not to handle the

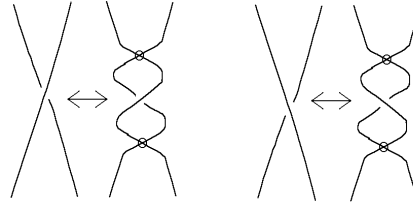

Figure 5: Two versions of virtualisation

$1 \rightarrow 1$ -differentials here. In the next two sections, we shall consider the Khovanov complex not for all virtual links, but only for “good” ones: those for which the cube has no local differentials of the type $1 \rightarrow 1$. Later on, we shall transform each virtual link (diagram) to a good diagram and observe the Khovanov homologies of the transformed diagram while performing the Reidemeister moves to the initial diagram. Thus, in the the section, we shall construct the Khovanov complex for framed links, where the good diagram is the “doubled” version of the initial diagram.

4 The Khovanov Complex for Doubled Knots

In the remaining part of the present chapter, we shall use the following construction connecting atoms and virtual links.

Given an atom V . Consider a generic embedding p of its frame in \mathbf{R}^2 preserving the A -structure of the atom. Thus we get a 4-valent graph on the plane with two types of vertices: images of atom’s vertices and “immersion artifacts”, that is, intersection of images of atom’s edges. In the first case, we mark crossings to be classical as in the case of classical knots and height atoms.

Namely, let a, b be semiedges emanating from a vertex X and forming a black angle according to the B -structure of the atom. While projecting the neighbourhood of X , denote by u the one of semiedges a, b , which is passed **before** while sweeping the angle X, a, b in the clockwise direction. The semiedge u and the semiedge opposite to it are chosen to form an undercrossing at X .

The intersection points of images of different edges are to be marked by virtual crossings. Thus we obtain a virtual link diagram to be denoted by L .

Lemma 2. *The virtual link L is defined by the atom up to detour moves and virtualisations of some classical vertices.*

Proof. While projecting a graph to the plane we respect only the structure of opposite semiedges. Suppose for some vertex A of the atom in question we have four emanating edges a, b, c, d , so that the edge c is opposite to a and the edge d is opposite to b . While immersing this to \mathbf{R}^2 the cyclic ordering (in the counterclockwise direction) may be either a, b, c, d or a, d, c, b . It is easy to see that the virtual links obtained in this way differ from each other by a virtualisation at the corresponding classical crossing (and detour moves). \square

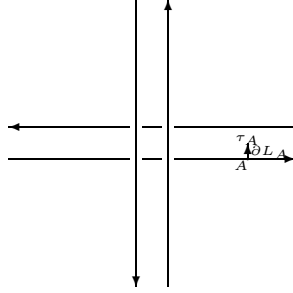

Figure 6: Local orientation of the doubled diagram

Let us mention one more important.

Lemma 3. *Let L, L' be two virtual diagrams, such that the corresponding atoms are orientable, and L' can be obtained from L by using a classical Reidemeister move. Then $Kh(L) = Kh(L')$.*

While performing the detour move, the structure of classical crossings is not change, thus we do not change the perestroika cube and the whole complex. In the case of *classical Reidemeister moves* there exists an invariance proof by Bar-Natan. It is local, i.e., it uses only the local structure of the Reidemeister move (regardless what happens outside). Thus, it works for virtual knots as well.

Proposition 1. *Let L be a virtual link diagram. Then the atom corresponding to the diagram $D_2(L)$ is orientable.*

For the proof, we shall need one more auxiliary proposition.

Given an atom V . Suppose its A -structure is such that there exists an orientation for all edges of V such that for each vertex, some two opposite (semi)edges are outgoing, and the other two are incoming. We call such an orientation of edges a *source-target structure*.

Proposition 2 ([Man2]). *An atom admitting a source-target structure is orientable.*

Then, the proof of Proposition 1 is deduced from Proposition 2 as follows. Let L be a virtual diagram. Orient the diagram $D_2(L)$ in such a way that for any point A on the diagram the reference frame $(\partial L_A, \tau_A)$ generates a positive orientation of the plane, see Fig. 6.

Here ∂L is the tangent vector for the link and τ_A is the vector perpendicular to ∂L directed from the point A to a close point on the adjacent component.

The desired source-target structure is now constructed as follows: all edges (i.e., images of edges of the corresponding atom) of the diagram $D_2(L)$ are naturally splitted into “long” ones (those corresponding to edges of L) and

“short” ones (four short edges correspond to each vertex of L , see Fig. 6). Let us change the orientation of short edges without changing that of the long ones. The obtained orientation gives a source-target structure.

Remark 2. *This structure plays a key role in some other problems of combinatorial topology, see, e.g. [Man3].*

Thus, the Khovanov complex for $D_{2n}(L) = D_2(D_n(L))$ is well defined for each ring of coefficients. The mapping $L \mapsto D_{2n}(L)$ is a framed link invariant. Thus, it is natural to expect that the Khovanov homology of the doubled link are invariants of the initial link. More precisely, the following lemma takes place.

Lemma 4. *Let L, L' be two equivalent framed virtual link diagrams. Then there exists a sequence of diagrams $D_2(L) = L_0, L_1, \dots, L_n = D_2(L')$ such that*

1. *All atoms corresponding to diagrams L_i are orientable.*
2. *For each $i = 0, \dots, n - 1$, the diagram L_{i+1} can be obtained from L_i by a detour or by a Reidemeister move.*

The proof of Lemma 4 is shown in Fig. 7.

Theorem 3. *Let n be a positive integer. Then the image of the map $L \mapsto Kh(D_{2n}(L))$ is a virtual link invariant.*

Proof. In view of Proposition 1, $\mathcal{C}(D_{2n}(L))$ is a well defined complex. Now let L, L' be two equivalent diagrams of framed virtual links. Then, by lemma 4, there exists a sequence of diagrams $D_{2n}(L) = L_0, \dots, L_n = D_{2n}(L')$ all corresponding to orientable atoms such that L_{i+1} is obtained from L_i by a generalised Reidemeister moves. Thus, in view of Lemma 3, we have $Kh(D_{2n}(L)) = Kh(L_1) = \dots = Kh(D_{2n}(L'))$. The theorem is proved. \square

Note that the doubled diagram for L and the doubled version for the diagram L' obtained from L by virtualising a crossing of L have quite different state cubes. Thus, the complex we have constructed in the present section, should be virtualisation-sensitive.

However the “doubled” Khovanov complex we have constructed conceptually differs from the usual one known for the case of classical links: here both in classical and virtual case, one should first double the diagram, and then calculated the Khovanov homologies.

A very natural question is whether the “usual” Khovanov homologies $Kh(L)$ are invariant in the case of diagrams for which the corresponding atoms are orientable. The positive answer to this question is given in the next section.

5 Atoms and the Khovanov Complex of 2-Fold Covering

The main goal of the present section is to prove the following

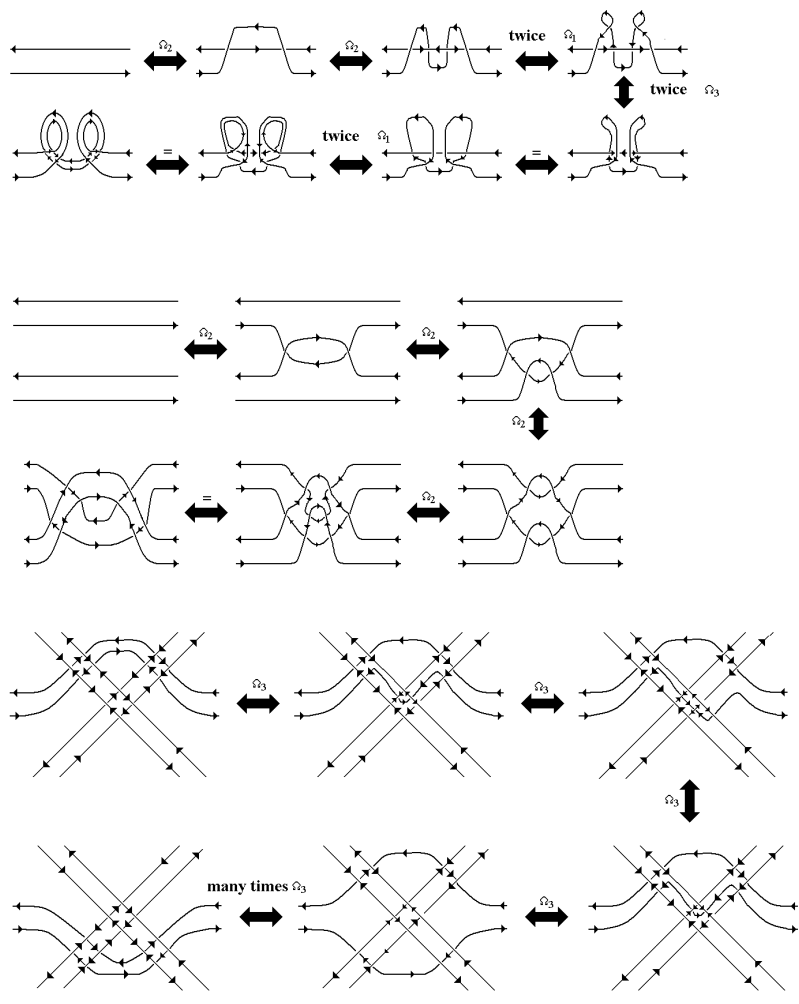

Figure 7: Doubled versions of Reidemeister moves

Theorem 4. F — . Let L, L' be two equivalent virtual diagrams such that the corresponding atoms are orientable. Then $Kh_{\mathbf{F}}(L) = Kh_{\mathbf{F}}(L')$.

The basic idea of the proof is the following. For each virtual diagram L , consider the corresponding atom $V(L)$. Then, we shall use the *orienting covering techniques*. Namely, if the atom $V(L)$ is orientable, we consider two disjoint copies of the atom $V(L)$, otherwise we consider the atom $\tilde{V}(L)$ which is the orienting double cover over $V(L)$. It is defined as the usual double cover over the correspondence 2-surface, herewith the preimage of the frame is a graph to be considered as the frame with cells colored accordingly. The obtained atom is thus either two-component or one-component depending whether the initial atom is orientable or not.

Denote the obtained atom by $V^2(L)$, and the corresponding virtual link by $K(V^2(L))$.

This construction can be treated as follows: we consider two disjoint sets of crossings of the atom with a given A -structure, and then connect some crossings by edges.

Thus, for each virtual knot, we have defined its “covered version”:

$$L \rightarrow V(L) \rightarrow V^2(L) \rightarrow Kh_{\mathbf{F}}(K(V^2(L))) \quad (6)$$

Starting from knot diagrams, this construction is described as follows. Given a virtual link diagram L with n classical crossings X_1, \dots, X_n . These crossings are connected somehow between each other. Thus we have a graph Γ immersed in \mathbf{R}^2 . Each crossing X_i has four tails $X_{i1}, X_{i2}, X_{i3}, X_{i4}$ numbered, say, clockwise; herewith the tails are connected to other tails by branches corresponding to edges of the atom. Suppose the edge l_j connects some two tails $X_{j_1 j_2}$ and $X_{j_3 j_4}$, whereas $j_2, j_4 \in \{1, 2, 3, 4\}$.

The diagram $K(V^2(L))$ is then constructed as follows. It contains $2n$ crossings $X'_1, \dots, X'_n, X''_1, \dots, X''_n$ to be connected by branches. Each branch l_j of the initial diagram has two images: l_j^1 and l_j^2 . Each of the two edges l_j^i connects one tail $X'_{j_1 j_2}$ or $X''_{j_1 j_2}$ with another tail $X'_{j_3 j_4}$ or $X''_{j_3 j_4}$. For each edge l_j^1 , we have to indicate, which types of tails it should connect (X' or X''). Here we have some description arbitrariness. The point is that before describing the edges, we have got no natural vertex ordering, that is we did not say which of the vertices X'_i and X''_i is the first, and which one is the second one. To overcome it, let us consider a maximal tree Δ in the graph Γ and decree that all edges l_j^1 corresponding to edges of Δ connect the tails $X'_{j_1 j_2}$ and $X'_{j_3 j_4}$ (thence, the edges l_j^2 connect some tails of type $X''_{j_1 j_2}, X''_{j_3 j_4}$). Another choice of the maximal tree would lead to a notation change: for some pairs, X'_j and X''_j will permute. After this, the connection rule for the remaining tails by edges l_i^1 and l_i^2 goes as follows. Again, we have some freedom: showing which pairs of tails are to be connected by an edge l_i we shall not indicate which of the two edges l_i^1 or l_i^2 is used here; the “antipodal” pair of tails obtained by permutation $X' \longleftrightarrow X''$ would be also connected by an edge; it is not important for the diagram what the name of the edge is. Also, we shall not pay attention to the disposition of edges l_i^c on the plane since the class of virtual link does not depend on that.

Thus, we have fixed a spanning tree $\Delta \subset \Gamma$. Each edge l_j not belonging to this edge generates a minimal cycle on the subgraph $\Delta \cup l_j \subset \Gamma$. In the case when this cycle is *good* (see below), we use the edge l_j^1 to connect the tails $X'_{j_1 j_2}$ and $X'_{j_3 j_4}$ and the edge l_j^2 will be used for connecting $X''_{j_1 j_2}$ and $X''_{j_3 j_4}$. In the case of bad cycle we connect by l_j^1 the tails $X'_{j_1 j_2}$ and $X''_{j_3 j_4}$, whence the tails $X''_{j_1 j_2}$ and $X'_{j_3 j_4}$ are connected by l_j^2 . The notions of *good and bad edges* result from orienting and non-orienting cycles on the atom. The covering maps any orienting cycle to a cycle and any non-orienting cycle to a path with different endpoints X'_k, X''_k . Now, we define the notion of good edge (for edges not belonging to Δ) together with the notion of orienting cycle. **A cycle is good if the number of its transverse passings through crossings is even.**

It is easy to check that this definition of a good cycle agrees with the definition coming from the atom.

Thus, we have defined the notion of orienting cycle and good edge (for edges not belonging to the tree Δ). Thus, we have completely constructed the virtual diagram $K(V^2(L))$. Note that this definition does not depend (modulo detour moves) on the choice of the tree Δ .

Moreover, by the atom $V^2(L)$, the “double-cover” link is recovered modulo virtualisation (however, this does not change Khovanov homologies); we have given an explicit way for constructing the diagram $K(V^2(L))$ by the diagram L ; this way corresponds to some immersion of the frame of $V^2(L)$ (which preserves the A -structure)

It is easy to see that if we apply the detour move to the initial diagram L , the diagram $K(V^2(L))$ would also be operated on by a detour move. Besides, we have the following

Lemma 5. *If we apply a Reidemeister move to a diagram L , then the diagram $K(V^2(L))$ will be operated on by the same move in two places.*

Proof. We shall denote links before and after the Reidemeister move by L, L' , denote the frames of the corresponding atoms by Γ, Γ' and the corresponding “covered diagrams” by \tilde{L}, \tilde{L}' , respectively.

Each Reidemeister move is a transformation of a knot diagram inside a certain domain; inside this domain, the diagram L is represented by a subdiagram P , whence L' is represented by some diagram Q . Herewith we have some tails t_1, \dots, t_n that connect the subdiagram P (of L) or the subdiagram Q (of L') with the remaining fixed part of the diagram. In the case of the first Reidemeister move we have $n = 2$, in the case of the second Reidemeister move $n = 4$, for the third Reidemeister move we have $n = 6$. For the diagrams \tilde{L} and \tilde{L}' , each tail t_i has a lift t'_i, t''_i to the covering diagram. If the diagram P (and Q) does not contain non-orienting cycle then we have two copies of P on \tilde{L} (and two copies of Q on \tilde{L}'). The claim of the theorem is that the connections of these copies agree with tails. A coordinated and a non-coordinated cases are shown in Fig. 8.

In the coordinated case, all vertices t_i, t'_i are connected coordinatedly for the lift of L and for the lift of L' . Namely, all t'_j are connected to each other, and

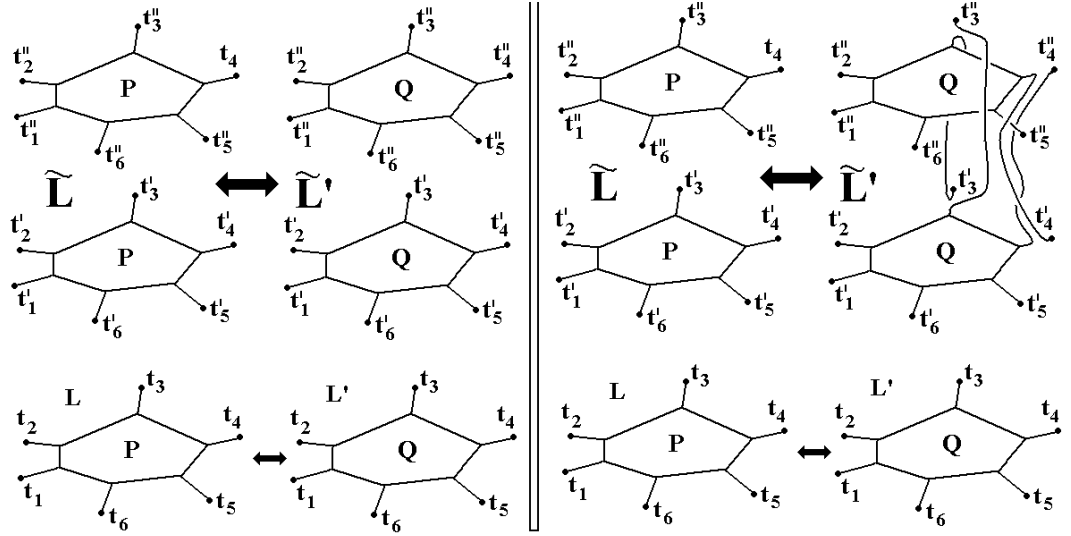

Figure 8: Coordinated and non-coordinated connection

all t_k'' are connected to each other. In the case shown in Fig. 8 the connection according to the lift of L is as before, whence the connection for the lift of L' is distinct: one copy of Q is connected to the tails $t_1', t_2', t_3', t_4', t_5', t_6'$ whence the other one connects the tails $t_1'', t_2'', t_3'', t_4'', t_5'', t_6''$. We have to show that only the first type of connection takes place.

While applying the first Reidemeister move, we get a loop consisting of one edge l_j for which the initial point (the same as the final point) divides some edge l_k . The edge l_j represents a good cycle. Besides, the edge l_k is divided into two edges l_{k_1} and l_{k_2} which are not opposite to each other in the separating vertex. Consider a cycle c of the graph Γ' containing the edge l_k . With it, one can naturally associate a cycle c' containing l_{k_1} and l_{k_2} on the graph Γ' . If c is orientable, then so is c' and vice versa. Indeed, since the edges l_{k_1} and l_{k_2} are not opposite, we have no additional transverse point. Thus we have the same parity for the cycles c and c' . So, if the edge l_k^1 of the diagram $K(V^2(L))$ connects, say, the tails X'_{pq} and X''_{rs} , then the edges $l_{k_1}^2, l_{k_2}^2$ connect the same tails X'_{pq} and X''_{rs} . This means that the two pictures before and after the Reidemeister move agree. Each of the two remaining Reidemeister moves represents a reconstruction of some “interior domain” having some tails. For the second Reidemeister move, we have four tails, for the third Reidemeister move, we have six tails.

Consider the second Reidemeister move. The diagram L' contains a bigon cd and four emanating edges a, b, e, f , see Fig. 9.

The bigon is evidently good. Thus, the whole set of edges can be uniquely lifted to the diagram $K(V^2(L'))$. Finally we get two sets of branches a', b', c', d', e', f' and a'', b'', c'', d'', e'' . The branches c', d' form a bigon which admits a decreasing Reidemeister move. The same is true about the bigon c'', d'' . Applying

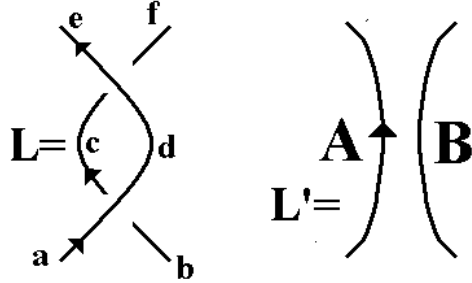

Figure 9: The second Reidemeister move

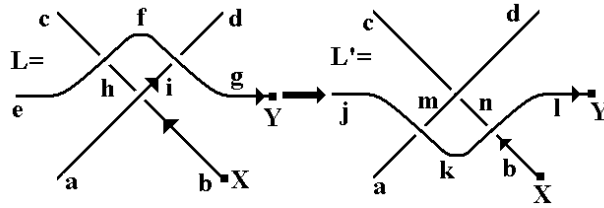

Figure 10: The third Reidemeister move

the decreasing second Reidemeister moves to these bigons, we get the diagram $K(V^2(L))$. Indeed, it suffices to show that after such Reidemeister moves the edge a' connects to the edge e' , whence the edge b' connects to f' (herewith a'' connects to e'' and b'' connects to f''). The last statement follows from the fact that each cycle of L passing through a, c, e has the same number of transverse passings as the corresponding cycle L' passing through the edge A .

In the case of the third Reidemeister move, we have one hexagon with six exterior branches for both L and L' .

Both triangles represent good cycles, since they do not connect transverse passes. Thus, the corresponding domains P and Q are lifted to two copies of P and Q , respectively. We only have to check that these two lifts agree.

To do it, we have to show that any two paths $\gamma \in L$ and $\gamma' \in L'$ connecting t_i, t_j have similar lifts to L, \tilde{L} . For instance, if one preimage $\tilde{\gamma}$ of the path γ is lifted to the path connecting t'_i, t'_j and passing inside P then each path γ' from Q having the same points as γ should have a preimage $\tilde{\gamma}'$ connecting t'_i, t'_j (and not t'_i, t''_j). In Fig. 10, we give an example of two such paths.

Namely, consider some two paths between X and Y on the diagrams L and L' . We state, that their lifts \tilde{L} and \tilde{L}' agree. This follows from the fact that the number of transverse points for these paths is the same (equal to zero). One can prove the analogous statement about paths, as shown in Fig. 10. \square

Thus, by lemma 3, the Khovanov homologies of the “doubled-covered” knot

are not changed while applying some Reidemeister moves to the initial diagram. Thus we get the following

Theorem 5. *The map $L \rightarrow Kh(K(V^2(L)))$ provides a well defined invariant of virtual link.*

Remark 3. *Note that a Reidemeister move may change the orientability of an atom. Thus, for instance, for an orientable atom $V(K)$ and the corresponding two-component atom $V^2(K)$, a second Reidemeister move applied to K may transform the atom $V(K)$ to a non-orientable one, thus connecting the two components of the atom $V^2(K)$.*

Suppose the atom corresponding to a virtual link diagram L is orientable. Then $K(V^2(L))$ consists of two copies of L . Since \mathbf{F} is a field, we have: $Kh_{\mathbf{F}}(K(V^2(L))) = Kh_{\mathbf{F}}(L)^{\otimes 2}$.

Thus, the homologies $Kh(L)$ can be recovered from $Kh(K(V^2(L)))$ by taking the tensor square root. In the case when the coefficient ring is a field, we get a 2-variable Poincaré polynomial with non-negative integer coefficients. So, we have to extract the square root of this polynomial to get a polynomial with non-negative coefficients. If it is possible, then such a polynomial is unique. This completes the proof of Theorem 4. This leads to

Theorem 6. *Let \mathbf{F} be a field and let a link L be such that $Kh_{\mathbf{F}}(K(V^2(L)))$ can not be represented as a tensor square. Then L has no diagram for which the corresponding atom is orientable. In particular, such a link L can not be classical.*

An important and interesting question is whether there exist two non-isotopic classical links L, L' that can be obtained from each other by a sequence of generalised Reidemeister moves and virtualisations. The Khovanov complex gives a partial answer to this question.

From Theorem 4 and the invariance of Khovanov homologies modulo virtualizations, we obtain the following result.

Theorem 7. *If a classical link L' can be obtained from another classical link L by using generalised Reidemeister moves and virtualisations, then L and L' have the same Khovanov homologies with coefficients in any given field.*

e-mail: vassily@manturov.mccme.ru

References

- [BN1] Bar–Natan, D. (2002), On Khovanov’s categorification of the Jones polynomial, *Algebraic and Geometric Topology*, **2**(16), pp. 337–370.
- [BN2] Bar–Natan, D. (2004), Khovanov’s homology for tangles and cobordisms, arXiv:mat.GT/0410495.

- [Jon1] Jones, V. F. R. (1985), A polynomial invariant for links via Neumann algebras, *Bull. Amer. Math. Soc.*, **129**, pp. 103–112.
- [Kau1] Kauffman, L.H. (1987), State Models and the Jones Polynomial, *Topology*, **26** (1987), pp. 395–407.
- [Kau2] Kauffman, L. H. (1999), Virtual knot theory, *European Journal of Combinatorics* **20**(7), pp. 662–690.
- [Kh1] Khovanov, M. (1997), A categorification of the Jones polynomial, *Duke Math. J.*, **101** (3), pp.359-426.
- [Kh2] Khovanov M., A functor-valued invariant of tangles, arXiv: math.QA/0103190
- [Man] Manturov V.O. (2003), Kauffman-like polynomial and curves in 2-surfaces, *Journal of Knot Theory and Its Ramifications*, **12**, (8), pp.1145-1153.
- [Man1] Manturov, V.O. (2004), The Khovanov polynomial for virtual knots, *Doklady Mathematics*.
- [Man2] Manturov, V.O. (2005), Teoriya Uzlov (Knot Theory, in Russian), *RCD*, Moscow-Izhevsk, 512 pp.
- [Man3] Manturov, V.O.. (2004), A proof of one conjecture by V.A.Vassiliev *Math. Izvestiya*, to appear.