

# ON ENVELOPES OF HOLOMORPHY OF DOMAINS COVERED BY LEVI-FLAT HATS AND THE REFLECTION PRINCIPLE

JOËL MERKER

**RÉSUMÉ.** In the present paper, we associate the techniques of the Lewy-Pinchuk reflection principle with the Behnke-Sommer continuity principle. Extending a so-called *reflection function* to a parameterized congruence of Segre varieties, we are led to studying the envelope of holomorphy of a certain domain covered by a smooth Levi-flat “hat”. In our main theorem, we show that every  $C^\infty$ -smooth CR diffeomorphism  $h : M \rightarrow M'$  between two globally minimal real analytic hypersurfaces in  $\mathbb{C}^n$  ( $n \geq 2$ ) is real analytic at every point of  $M$  if  $M'$  is holomorphically nondegenerate. More generally, we establish that the reflection function  $\mathcal{R}'_h$  associated to such a  $C^\infty$ -smooth CR diffeomorphism between two globally minimal hypersurfaces in  $\mathbb{C}^n$  ( $n \geq 1$ ) always extends holomorphically to a neighborhood of the graph of  $\bar{h}$  in  $M \times \overline{M'}$ , without any nondegeneracy condition on  $M'$ . This gives a new version of the Schwarz symmetry principle to several complex variables. Finally, we show that every  $C^\infty$ -smooth CR mapping  $h : M \rightarrow M'$  between two real analytic hypersurfaces containing no complex curves is real analytic at every point of  $M$ , without any rank condition on  $h$ .

**RÉSUMÉ.** Dans cet article, nous associons les techniques du principe de réflexion de Lewy-Pinchuk avec celles du principe de continuité de Behnke-Sommer. Après avoir prolongé holomorphiquement une fonction dite “de réflexion” à une congruence de sous-variétés de Segre, nous sommes conduits à l’étude de l’enveloppe d’holomorphie d’un domaine recouvert d’un “chapeau” Levi-plat lisse. D’après notre résultat principal, tout CR-difféomorphisme  $h : M \rightarrow M'$  de classe  $C^\infty$  entre deux hypersurfaces analytiques réelles globalement minimales de  $\mathbb{C}^n$  ( $n \geq 2$ ) est analytique réel en tout point de  $M$  si  $M'$  est holomorphiquement non-dégénérée. Plus généralement, nous établissons que la fonction de réflexion  $\mathcal{R}'_h$  associée à un tel difféomorphisme CR de classe  $C^\infty$  entre deux hypersurfaces analytiques réelles globalement minimales se prolonge toujours holomorphiquement à un voisinage du graphe de  $\bar{h}$  dans  $M \times \overline{M'}$ , sans aucune condition de non-dégénérescence sur  $M'$ . Cet énoncé fournit une nouvelle version du principe de réflexion de Schwarz en plusieurs variables complexes. Enfin, nous démontrons que toute application  $h : M \rightarrow M'$  de classe  $C^\infty$  et CR entre deux hypersurfaces analytiques réelles ne contenant pas de courbes holomorphes est analytique réelle en tout point de  $M$ , sans aucune condition de rang sur  $h$ .

## Table of contents :

§1. Introduction and presentation of the results .....	2.
§2. Description of the proof of Theorem 1.2 .....	8.
§3. Biholomorphic invariance of the reflection function .....	13.
§4. Extension across a Zariski dense open subset of $M$ .....	22.
§5. Situation at a typical point of non-analyticity .....	26.
§6. Envelopes of holomorphy of domains with Levi-flat hats .....	30.
§7. Holomorphic extension to a Levi-flat union of Segre varieties ...	34.
§8. Relative position of the neighbouring Segre varieties .....	38.
§9. Analyticity of some degenerate $C^\infty$ -smooth CR mappings .....	39.
§10. Open problems and conjectures .....	46.

*Date:* 2018-11-9.

1991 *Mathematics Subject Classification.* 32V25, 32V40, 32V15, 32V10, 32D10, 32D20.

*Key words and phrases.* Reflection principle, Continuity principle, CR diffeomorphism, Holomorphic nondegeneracy, Global minimality in the sense of Trépreau-Tumanov, Reflection function, Envelopes of holomorphy.

## §1. INTRODUCTION AND PRESENTATION OF THE RESULTS

**1.1. Main theorem.** Let  $h : M \rightarrow M'$  be a  $\mathcal{C}^\infty$ -smooth CR diffeomorphism between two geometrically smooth real analytic hypersurfaces in  $\mathbb{C}^n$  ( $n \geq 2$ ). Call  $M$  *globally minimal* (in the sense of Trépreau-Tumanov) if it consists of a single CR orbit ([Tr1,2], [Tu1,2], [Me1], [MP1]). Call  $M'$  *holomorphically nondegenerate* (in the sense of Stanton) if there does not exist any nonzero  $(1,0)$  vector field with holomorphic coefficients which is tangent to a nonempty open subset of  $M'$  ([St1,2]). Our principal result is as follows.

**Theorem 1.2.** *If  $M$  is globally minimal and if  $M'$  is holomorphically nondegenerate, then the  $\mathcal{C}^\infty$ -smooth CR diffeomorphism  $h$  is real analytic at every point of  $M$ .*

Compared to classical results of the literature, in this theorem, no pointwise, local or not propagating nondegeneracy condition is imposed on  $M'$ , like for instance  $M'$  be Levi nondegenerate, finitely nondegenerate or essentially finite at every point. With respect to the contemporary state of the art, the novelty in Theorem 1.2 lies in the treatment of the locus of non-essentially finite points, which is a proper real analytic subvariety of  $M'$ , provided  $M'$  is holomorphically nondegenerate. There is also an interesting invariant to study, more general than  $h$ , namely the *reflection function*  $\mathcal{R}'_h$ . Because the precise definition of  $\mathcal{R}'_h$  involves a concrete defining equation of  $M'$ , it must be localized around various points  $p' \in M'$ , so we refer to §1.7 below for a complete presentation. Generalizing Theorem 1.2, we show that  $\mathcal{R}'_h$  extends holomorphically to a neighborhood of each point  $(p, \overline{h(p)}) \in M \times \overline{M'}$ , assuming only that  $M$  is globally minimal and without any nondegeneracy condition on  $M'$  (Theorem 1.9). We deduce in fact Theorem 1.2 from the extendability of  $\mathcal{R}'_h$ . This strategy of proof is inspired from the deep works of Diederich-Pinchuk [DP1,2] (see also [V], [Sha], [PV]) where the extension as a mapping is derived from the extension as a correspondence.

In the sequel, we shall by convention sometimes denote by  $(M, p)$  a *small connected piece* of  $M$  localized around a “center” point  $p \in M$ . However, since all our considerations are semi-local and of geometric nature, we shall *never* use the language of germs.

**1.3. Development of the classical results and brief history.** The earliest extension result like Theorem 1.2 was found independently by Pinchuk [P3] and after by Lewy [L] : if  $(M, p)$  and  $(M', p')$  are strongly pseudoconvex, then  $h$  is real analytic at  $p$ . The classical proof in [P3] and [L] makes use of the so-called *reflection principle* which consists to *solve* first the mapping  $h$  with respect to the jets of  $\bar{h}$  (by this, we mean a relation like  $h(q) = \Omega(q, \bar{q}, j^k \bar{h}(\bar{q}))$  where  $\Omega$  is holomorphic in its arguments and  $q \in M$ , cf. (4.10) below) and to apply afterwards the one-dimensional Schwarz symmetry principle in a foliated union of transverse holomorphic discs. In 1978 and in 1982, Webster [W2,3] extended this result to Levi nondegenerate CR manifolds of higher codimension. Generalizing this principle, Diederich-Webster proved in 1980 that a sufficiently smooth CR diffeomorphism is analytic at  $p \in M$  if  $M$  is generically Levi-nondegenerate and the morphism of jets of Segre varieties of  $M'$  is injective (see §2 of the fundamental article [DW] and (1.11) below for a definition of the Segre morphism). In 1983, Han [Ha] generalized the reflection principle for CR diffeomorphisms between what is today called *finitely nondegenerate* hypersurfaces (see [BER2]). In 1985, Derridj [De] studied the reflection principle for proper mappings between some model classes of weakly pseudoconvex boundaries in  $\mathbb{C}^2$ . In 1985, Baouendi-Jacobowitz-Treves [BJT] proved that every  $\mathcal{C}^\infty$ -smooth CR diffeomorphism  $h : (M, p) \rightarrow (M', p')$  between two real analytic CR-generic manifolds in  $\mathbb{C}^n$  which extends holomorphically to a fixed wedge of edge  $M$ , is real analytic, provided  $(M', p')$  is essentially finite. After the work of Rea [R], in which holomorphic extension to one side of CR functions on a minimal real analytic hypersurface was proved (the weakly pseudoconvex case, which is not very different, was treated long before in a short note by Bedford-Fornæss [BeFo] ; see also [BT2]), after the work of Tumanov [Tu1], who proved wedge extendability in general codimension, and after the work of Baouendi-Rothschild [BR3], who proved the necessity of minimality for wedge extension (in the meanwhile, Treves provided a simpler argument of necessity), it was known that the automatic holomorphic extension

to a fixed wedge of the components of  $h$  holds *if and only if*  $(M, p)$  is minimal in the sense of Tumanov. Thus, the optimal extendability result in [Tu1] strengthened considerably the main theorem of [BJT]. In the late eighties, the research on the analyticity of CR mappings has been pursued by many authors intensively. In 1987–88, Diederich-Fornæss [DF2] and afterwards (not independently) Baouendi-Rothschild [BR1] extended this kind of reflection principle to the non diffeomorphic case, namely for a  $C^\infty$ -smooth CR mapping  $h$  between two essentially finite hypersurfaces which is locally finite to one, or locally proper. This result was generalized in [BR2] to  $C^\infty$ -smooth mappings  $h : (M, p) \rightarrow (M', p')$  whose formal Jacobian determinant at  $p$  does not vanish identically, again with  $(M', p')$  essentially finite. In 1993-6, Sukhov [Su1,2] and Sharipov-Sukhov [SS] generalized the reflection principle of Webster in [W2,3] by introducing a global condition on the mapping, called Levi-transversality. Following this circle of ideas, Coupet-Pinchuk-Sukhov have pointed out in their recent works [CPS1,2] that almost all the above-mentioned variations on the reflection principle find a unified explanation in the fact that a certain complex analytic variety  $\mathbb{V}'_p$  is zero-dimensional, which intuitively speaking means that  $h$  is *finitely determined by the jets of  $\bar{h}$* , i.e. more precisely that each components  $h_j$  of  $h$  satisfies a monic Weierstrass polynomial having analytic functions depending on a finite jet of  $\bar{h}$  as coefficients (this observation appears also in [Me3]). They stated thus a general result in the hypersurface case whose extension to a higher codimensional minimal CR-generic source  $(M, p)$  was achieved recently by Damour in [Da2]. In sum, this last clarified unification closes up what is attainable in the spirit of the so-called *polynomial identities* introduced in [BJT], yielding a quite general sufficient condition for the analyticity of  $h$ . In the arbitrary codimensional case, this general sufficient condition can be expressed simply as follows. Let  $\bar{L}_1, \dots, \bar{L}_m$  be a basis of  $T^{0,1}M$ , denote  $\bar{L}^\beta := \bar{L}_1^{\beta_1} \dots \bar{L}_m^{\beta_m}$  for  $\beta \in \mathbb{N}^m$  and let  $\rho'_j(t, \bar{t}) = 0$ ,  $1 \leq j' \leq d'$ , be a collection of real analytic defining equations for a generic  $(M', p')$  of codimension  $d'$ . Then the complex analytic variety, called the (first) *characteristic variety* in [CPS1,2], [Da1,2] :

$$(1.4) \quad \mathbb{V}'_p := \{t' \in \mathbb{C}^n : \bar{L}^\beta [\rho'(t', \bar{h}(\bar{t}))]|_{\bar{t}=\bar{p}} = 0, \forall \beta \in \mathbb{N}^m\}.$$

is always zero-dimensional at  $p' \in \mathbb{V}'_p$  in [L], [P3], [W1], [W2], [W3], [DW], [Ha], [De], [BJT], [DF2], [BR1], [BR2], [BR4], [Su1,2], [BHR], [Su1], [Su2], [SS], [BER1], [BER2], [CPS1], [CPS2], [Da] (in [P4], [DFY], [DP1,2], [V], [Sha], [PV], the variety  $\mathbb{V}'_p$  is not defined because these authors tackle the much more difficult problem where *no initial regularity assumption* is supposed on the mapping; in [DF2], some cases of non-essentially finite hypersurfaces are admitted). Importantly, the condition  $\dim_{p'} \mathbb{V}'_p = 0$  requires  $(M', p')$  to be essentially finite.

**1.5. Non-essentially finite hypersurfaces.** However, it is known that the finest CR-regularity phenomena come down to the consideration of a class of much more general hypersurfaces which are called *holomorphically nondegenerate* by Stanton [St1,2] and which are in general *not essentially finite*. In 1995, Baouendi-Rothschild [BR3] exhibited this condition as a *necessary and sufficient* condition for the algebraicity of a local biholomorphism between two real algebraic hypersurfaces. Thanks to the nonlocality of algebraic objects, they could assume that  $(M', p')$  is essentially finite after a small shift of  $p'$ , which entails again  $\dim_{p'} \mathbb{V}'_p = 0$ , thus reducing the work to the application of known techniques (even in fact simpler, in the generalization to the higher codimensional case, Baouendi-Ebenfelt-Rothschild came down to a direct application of the algebraic implicit function theorem by solving algebraically  $h$  with respect to the jets of  $\bar{h}$  [BER1]; Since then however, few works have been devoted to the study of the analytic regularity of smooth CR mapping between *non-essentially finite* hypersurfaces in  $\mathbb{C}^n$ . It is well known that the main technical difficulties in the subject happen to occur in  $\mathbb{C}^n$  for  $n \geq 3$  and that a great deal of the obstacles which one naturally encounters can be avoided by assuming that the target hypersurface  $M'$  is algebraic (with  $M$  algebraic or real analytic), see e.g. the works [MM2], [Mi1,2,3], [CPS1] (in case  $M'$  is algebraic, its Segre varieties are defined all over the compactification  $P_n(\mathbb{C})$  of  $\mathbb{C}^n$ , which helps much). Finally, we would like to mention the papers of Meylan [Mey], Maire and Meylan [MaMe], Meylan

and the author [MM1], Huang, the author and Meylan [HMM] in this respect (nevertheless, after division by a suitable holomorphic function, the situation under study in these works is again reduced to polynomial identities).

**1.6. Schwarz's reflection principle in higher dimension.** In late 1996, seeking a natural generalization of Schwarz's reflection principle to higher dimension and inspired by the article [DP1], the author (*see* [MM2], [Me3]) pointed out the interest of the so-called *reflection function*  $\mathcal{R}'_h$  associated with  $h$ . This terminology is introduced *passim* in [Hu, p. 1802]; a different definition involving one more variable is given in [Me3,5,6,7,8]; the biholomorphic invariance of  $\mathcal{R}'_h$  and the important observation that  $\mathcal{R}'_h$  should extend holomorphically *without any nondegeneracy condition* on  $(M', p')$  appeared for the first time in the preprint versions of [MM2], [Me3], which inspired the papers [Mi1,2].

Indeed, the explicit expression of this function depends on a local defining equation for  $M'$ , but its holomorphic extendability is independent of coordinates and there are canonical rules of transformation between two reflection functions (*see* §3 below). As the author believes, in the diffeomorphic case and provided  $M$  is at least globally minimal, *this function should extend without assuming any nondegeneracy condition on  $M'$ , in pure analogy with the Schwarzian case  $n = 1$* . It is easy to convince oneself that the reflection function is the right invariant to study. In fact, since then, it has been already studied thoroughly in the algebraic and in the formal CR-regularity problems, *see* [Me3,5,6,7,8], [Mi2,3,4]. For instance, the formal reflection mapping associated with a formal CR equivalence between two real analytic CR-generic manifolds in  $\mathbb{C}^n$  which are minimal in the sense of Tumanov is convergent (*see* [Mi3,4] for partial results in this direction and [Me6,7,8] for the complete statement). If  $h$  is a holomorphic equivalence between two real algebraic CR-generic manifolds in  $\mathbb{C}^n$  which are minimal at a Zariski-generic point, then the reflection mapping  $\mathcal{R}'_h$  is algebraic (*see* [Mi2] for the hypersurface case and [Me5] for arbitrary codimension). So we expect that totally similar statements hold for smooth mappings between real analytic CR manifolds.

**1.7. Analyticity of the reflection function.** For our part, we deal in this paper with smooth CR mappings between *hypersurfaces*. Thus, as above, let  $h : M \rightarrow M'$  be a  $C^\infty$ -smooth CR mapping between two connected real analytic hypersurfaces in  $\mathbb{C}^n$  with  $n \geq 2$ . We shall constantly assume that  $M$  is globally minimal. Equivalently,  $M$  is locally minimal (in the sense of Trépreau-Tumanov) at every point, since  $M$  is real analytic (however, there exist  $C^2$ -smooth or  $C^\infty$ -smooth hypersurfaces in  $\mathbb{C}^n$ ,  $n \geq 2$ , which are globally minimal but not locally minimal at many point, *see* [J], [MP1]). Postponing generalizations and refinements to further investigation, we shall assume here for simplicity that  $h$  is a CR diffeomorphism. Of course, in this case, the assumption of global minimality of  $(M, p)$  can then be switched to  $(M', p')$ . The associated reflection function  $\mathcal{R}'_h$  is a complex function which is defined in a neighborhood of the graph of  $\bar{h}$  in  $\mathbb{C}^n \times \mathbb{C}^n$  as follows. Localizing  $M$  and  $M'$  at points  $p \in M$  and  $p' \in M'$  with  $p' = h(p)$ , we choose a complex analytic defining equation for  $M'$  in the form  $\bar{w}' = \Theta'(\bar{z}', t')$ , where  $t' = (z', w') \in \mathbb{C}^{n-1} \times \mathbb{C}$  are holomorphic coordinates vanishing at  $p'$  and where the power series  $\Theta'(\bar{z}', t') := \sum_{\beta \in \mathbb{N}^{n-1}} (\bar{z}')^\beta \Theta'_\beta(t')$  vanishes at the origin and converges normally in a small polydisc  $\Delta_{2n-1}(0, \rho') = \{(\bar{z}', t') : |\bar{z}'|, |t'| < \rho'\}$ , where  $\rho' > 0$  and where  $|t'| := \max(|t'_1|, \dots, |t'_n|)$  is the polydisc norm. Here, by reality of  $M'$ , the holomorphic function  $\Theta'$  is not arbitrary, it must satisfy the power series identity  $\Theta'(\bar{z}', z', \bar{\Theta}'(z', \bar{z}', \bar{w}')) \equiv \bar{w}'$ . Conversely, such a power series satisfying this identity does define a real analytic hypersurface  $\bar{w}' = \Theta'(\bar{z}', t')$  of  $\mathbb{C}^n$  as can be verified easily ([BER2, Remark 4.2.30]). It is important to notice that once the coordinate system  $t'$  is fixed, with the  $w'$ -axis not complex tangent to  $M'$  at 0, then there is *only one* complex defining equation for  $M'$  of the form  $\bar{w}' = \Theta'(\bar{z}', t')$ .

By definition, the *reflection function*  $\mathcal{R}'_h$  associated with  $h$  and with such a local defining function for  $(M', p')$  is the following function of  $2n$  complex variables :

$$(1.8) \quad (t, \bar{\nu}') \mapsto \bar{\mu}' - \sum_{\beta \in \mathbb{N}^{n-1}} (\bar{\lambda}')^\beta \Theta'_\beta(h(t)) =: \mathcal{R}'_h(t, \bar{\nu}'),$$

where  $\bar{\nu}' = (\bar{\lambda}', \bar{\mu}') \in \mathbb{C}^{n-1} \times \mathbb{C}$ . It can be checked rigorously that this function is CR and of class  $\mathcal{C}^\infty$  with respect to the variable  $t \in M$  in a neighborhood of  $p$  and that it is holomorphic with respect to the variable  $\bar{\nu}'$  in the polydisc neighborhood  $\{|z'| < \rho'\}$  of  $\bar{p}'$  in  $\mathbb{C}^n$  (see Lemma 3.8 below). Let us call the functions  $\Theta'_\beta(h(t))$  the *components* of the reflection function. Since  $M$  is in particular minimal at the point  $p \in M$ , the components  $h_j$  of the mapping  $h$  and hence also the components  $\Theta'_\beta(h(t))$  of  $\mathcal{R}'_h$  extend holomorphically to a one-sided neighborhood  $D_p$  of  $M$  at  $p$ , obtained by gluing Bishop discs to  $(M, p)$ . Our first main result is as follows.

**Theorem 1.9.** *If  $h : M \rightarrow M'$  is a  $\mathcal{C}^\infty$ -smooth CR diffeomorphism between two globally minimal real analytic hypersurfaces in  $\mathbb{C}^n$ , then for every point  $p \in M$  and for every choice of a coordinate system vanishing at  $p' := h(p)$  as above in which  $(M', p')$  is represented by  $\bar{w}' = \Theta'(\bar{z}', t')$ , the associated reflection function  $\mathcal{R}'_h(t, \bar{\nu}') = \bar{\mu}' - \Theta'(\bar{\lambda}', h(t))$  centered at  $p \times \bar{p}'$  extends holomorphically to a neighborhood of  $p \times \bar{p}'$  in  $\mathbb{C}^n \times \mathbb{C}^n$ .*

In §3 below, we provide some foundational material about the reflection function. Especially, we prove that the holomorphic extendability to a neighborhood of  $p \times \bar{p}'$  does not depend on the choice of a holomorphic coordinate system vanishing at  $p'$ . By differentiating (1.8) with respect to  $\bar{\nu}'$ , we may observe that the holomorphic extendability of  $\mathcal{R}'_h$  to a neighborhood of  $p$  is equivalent to the following statement : *all the component functions  $\Theta'_\beta(h(t)) =: \theta'_\beta(t)$  (an infinite number) extend holomorphically to a fixed neighborhood of  $p$  and there exist constants  $C, \rho, \rho' > 0$  such that  $|t| < \rho \Rightarrow |\theta'_\beta(t)| < C(\rho')^{-|\beta|}$  (see Lemma 3.16 below).* So Theorem 1.9 may be interpreted as follows : instead of asserting that the mapping  $h$  extends holomorphically to a neighborhood of  $p$ , we state that a certain invariant infinite collection of *holomorphic functions of the components  $h_j$  of the mapping* (which depends directly on  $M'$ ) *do extend holomorphically to a neighborhood of  $p$ .* The important fact here is that we do not put any extra nondegeneracy condition on  $M'$  at  $p'$  (except minimality). Another geometric interpretation is as follows. Let  $\underline{S}'_{t'} := \{(\bar{\lambda}', \bar{\mu}') \in \mathbb{C}^n : \bar{\mu}' = \Theta'(\bar{\lambda}', t')\}$  denote the *conjugate Segre variety* associated with the fixed point having coordinates  $t'$  (usually, to define Segre varieties, one fixes instead the point  $\bar{\nu}'$ ; nevertheless conjugate Segre varieties are equally interesting, as argued in [Me4]). Then Theorem 1.9 can be interpreted as saying that the not rigorously defined intuitive “Segre mapping”  $t \mapsto \underline{S}'_{h(t)}$  extends holomorphically at  $p$ . In fact, the target value of this mapping should be thought to be represented concretely by the defining function of  $\underline{S}'_{h(t)}$ , namely this intuitive “Segre mapping” *must* (and can only) be represented by the *rigorous* reflection function  $(t, \bar{\nu}') \mapsto \bar{\mu}' - \Theta'(\bar{\lambda}', h(t))$ . In sum, Theorem 1.9 precisely asserts that the “Segre mapping” extends holomorphically to a neighborhood of  $p \times \bar{p}'$ , without any nondegeneracy condition on  $(M', p')$ . In certain circumstances, *e.g.* when  $(M', p')$  is moreover assumed to be Levi-nondegenerate, finitely nondegenerate or essentially finite, one may deduce afterwards, thanks to the holomorphic extendability of the components  $\Theta'_\beta(h(t))$ , that  $h$  itself extends holomorphically at  $p$  (*cf.* [DF2], [BR1], [DFY], [DP1,2], [V], [Sha], [PV]). Analogously, in Theorem 1.14 below, we shall derive from Theorem 1.9 above an important expected *necessary and sufficient condition* for  $h$  to be holomorphic at  $p$ .

**1.10. Applications.** We give essentially two important applications. Firstly, associated with  $M'$ , there is an invariant integer  $\kappa'_{M'}$  with  $0 \leq \kappa'_{M'} \leq n-1$ , called the *holomorphic degeneracy degree* of  $M'$ , which counts the maximal number of  $(1, 0)$  vector fields with holomorphic coefficients defined in a neighborhood of  $M'$  which are tangent to  $M'$  and which are linearly independent at a Zariski-generic point. In particular,  $M'$  is holomorphically nondegenerate if and only if  $\kappa'_{M'} = 0$ . Inspired by the geometric reflection principle developed in [DW], [DF4],

[F], we can provide another (equivalent) definition of the integer  $\kappa'_{M'}$  in terms of the morphism of jets of Segre varieties as follows (see also [Me6,7,8]; historically, finite order jets of  $\mathcal{C}^\infty$ -smooth CR mappings together with finite order jets of the Segre morphism were first studied in the reflection principle by Diederich-Fornaess in [DF4]). By complexifying the variable  $\bar{t}'$  as  $(\bar{t}')^c =: \tau'$  and by fixing  $\tau'$ , we may consider the *complexified Segre variety* which is defined by  $\mathcal{S}'_{\tau'} := \{(w', z') : w' = \bar{\Theta}'(z', \tau')\}$ . For some supplementary information about the canonical geometric correspondence between complexified Segre varieties and complexified CR vector fields, we refer the interested reader to [Me4,5]. Let  $j_{t'}^k \mathcal{S}'_{\tau'}$  denote the  $k$ -jet at the point  $t'$  of  $\mathcal{S}'_{\tau'}$ . This  $k$ -jet is in fact defined by differentiating the defining equation of  $\mathcal{S}'_{\tau'}$  with respect to  $z'$  as follows. For  $\beta \in \mathbb{N}^{n-1}$ , we denote  $|\beta| := \beta_1 + \dots + \beta_{n-1}$  and  $\partial_{z'}^\beta := \partial_{z'_1}^{\beta_1} \dots \partial_{z'_{n-1}}^{\beta_{n-1}}$ . Then the  $k$ -jet provides in fact a holomorphic mapping which is defined over the extrinsic complexification  $\mathcal{M}' := \{(t', \tau') : w' - \bar{\Theta}'(z', \tau') = 0\}$  of  $M'$  as shown in the following definition :

$$(1.11) \quad j'_k : \mathcal{M}' \ni (t', \tau') \mapsto j_{t'}^k \mathcal{S}'_{\tau'} := (t', \{\partial_{z'}^\beta [w' - \bar{\Theta}'(z', \tau')]\}_{|\beta| \leq k}) \in \mathbb{C}^{n + \frac{(n-1+k)!}{(n-1)!k!}}.$$

For  $k$  large enough, the analytic properties of these jet mappings  $j'_k$  govern the geometry of  $M'$ , as was pointed out in [DW] for the first time. For instance, Levi nondegeneracy, finite nondegeneracy and essential finiteness of  $(M', p')$  may be characterized in terms of the mappings  $j'_k$  ([DW], [DF4], [Me6,7,8]). In our case, it is clear that there exists an integer  $\chi'_{M'}$  with  $1 \leq \chi'_{M'} \leq n$  such that the generic rank of  $j'_k$  equals  $n - 1 + \chi'_{M'}$  for all  $k$  large enough, since the generic ranks increase and are bounded by  $2n - 1$ . Then the holomorphic degeneracy degree can also be defined equivalently by  $\kappa'_{M'} := n - \chi'_{M'}$ . We may notice in particular that  $M'$  is Levi-flat if and only if  $\chi'_{M'} = 1$ , since  $\bar{\Theta}'(z', \tau') \equiv \tau'_n$  in this case. Consequently, we always have  $\chi'_{M'} \geq 2$  in this paper since we constantly assume that  $M'$  is globally minimal. The biholomorphic invariance of Segre varieties makes it easy to precise in which sense the jet mapping  $j'_k$  is invariantly attached to  $M'$ , namely how it changes when one varies the coordinate system. Then the fact that  $\chi'_{M'}$  is defined in terms of the generic rank of an invariant holomorphic mapping together with the connectedness of  $M'$  explains well that the integers  $\chi'_{M'}$  and  $\kappa'_{M'}$  do not depend on the center point  $p' \in M'$  in a neighborhood of which we define the mappings  $j'_k$  (we prove this in §3). In particular, this explains why  $M'$  is holomorphically degenerate at one point if and only if it is holomorphically degenerate at every point ([BR4]). On the contrary, the direct definition of  $\kappa'_{M'}$  in terms of locally defined tangent holomorphic vector fields provided in [BR4], [BER2] makes this point less transparent, even if the two definitions are equivalent. So, we believe that the definition of  $\kappa'_{M'}$  in terms of  $j'_k$  is more adequate. Furthermore, to be even more concrete, let us add that the behavior of the map (1.11) depends mostly upon the infinite collection of holomorphic mappings  $(\bar{\Theta}'_\beta(\tau'))_{\beta \in \mathbb{N}^{n-1}}$ , since we essentially get rid of  $z'$  by differentiating  $w' - \sum_{\beta \in \mathbb{N}^{n-1}} (z')^\beta \bar{\Theta}'_\beta(\tau')$  with respect to  $z'$  in (1.11). Equivalently, after conjugating, we may consider instead the simpler holomorphic mappings  $\mathcal{Q}'_k : t' \ni \mathbb{C}^n \mapsto (\Theta'_\beta(t'))_{|\beta| \leq k} \in \mathbb{C}^{\frac{(n-1+k)!}{(n-1)!k!}}$ . Then the generic rank of  $\mathcal{Q}'_k$  is equal to the same integer  $\chi'_{M'}$ , for all  $k$  large enough. This again supports the thesis that the components  $\Theta'_\beta(t')$  occurring in the defining function of  $(M', p')$  and in the reflection function are over all important. In §3 below, some more explanations about the mappings  $\mathcal{Q}'_k$  are provided.

Let  $\chi'_{M'}$  be as above and let  $\Delta$  be the unit disc in  $\mathbb{C}$ . It is known that there exists a proper real analytic subset  $E'_{M'}$  of  $M'$  such that for each point  $q' \in M' \setminus E'_{M'}$ , there exists a neighborhood of  $q'$  in  $\mathbb{C}^n$  in which  $(M', q')$  is biholomorphically equivalent to a product  $\underline{M}'_{q'} \times \Delta^{n-\chi'_{M'}}$  of a small real analytic hypersurface  $\underline{M}'_{q'}$  contained in the smaller complex space  $\mathbb{C}^{\chi'_{M'}}$  by a  $(n - \chi'_{M'})$ -dimensional polydisc. As expected of course, the hypersurface  $\underline{M}'_{q'}$  is a *holomorphically nondegenerate* hypersurface (Lemma 3.54), namely  $\kappa'_{\underline{M}'_{q'}} = 0$ . Now, granted Theorem 1.9, we observe that the local graph  $\{(t, h(t)) : t \in (M, p)\}$  of  $h$  is clearly

contained in the following local complex analytic set passing through  $p \times p'$  :

$$(1.12) \quad \mathcal{C}'_h := \{(t, t') \in \mathbb{C}^n \times \mathbb{C}^n : \Theta'_\beta(t') = \theta'_\beta(t), \forall \beta \in \mathbb{N}^{n-1}\}.$$

It follows from the considerations of §3 below that the various local complex analytic sets  $\mathcal{C}'_h$  centered at points  $(p, h(p))$  stick together in a well defined complex analytic set, independent of coordinates. Furthermore, since the generic rank of  $\mathcal{Q}'_\infty$  is equal to  $\chi'_{M'}$ , there exists a well defined irreducible component  $\mathcal{C}''_h$  of  $\mathcal{C}'_h$  of dimension  $(2n - \chi'_{M'})$  containing the local graph of  $h$ . We deduce :

**Corollary 1.13.** *Let  $(n - \chi'_{M'})$  be the holomorphic degeneracy degree of  $M'$ . Then there exists a semi-global closed complex analytic subset  $\mathcal{C}''_h$  defined in a neighborhood of the graph of  $h$  in  $\mathbb{C}^n \times \mathbb{C}^n$  which is of dimension  $(2n - \chi'_{M'})$  and which contains the graph of  $h$  over  $M$ . In particular,  $h$  extends as a complex analytic set to a neighborhood of  $M$  if  $\chi'_{M'} = n$ , i.e. if  $M'$  is holomorphically nondegenerate.*

Of course, the most interesting case of Corollary 1.13 is when  $\chi'_{M'} = n$ . Extendability of  $h$  as an analytic set can be improved. Using the approximation theorem of Artin ([Ar]) we shall deduce the following expected result (see Lemma 4.14), which is identical with Theorem 1.2 :

**Theorem 1.14.** *Let  $h : M \rightarrow M'$  be a  $\mathcal{C}^\infty$ -smooth CR diffeomorphism between two connected globally minimal real analytic hypersurfaces in  $\mathbb{C}^n$ . If  $M'$  is holomorphically nondegenerate, then  $h$  is real analytic at every point of  $M$ .*

Of course, real analyticity of  $h$  is equivalent to its holomorphic extendability to a neighborhood of  $M$  in  $\mathbb{C}^n$ , by a classical theorem due to Severi and generalized to higher codimension by Tomassini. In particular, Theorem 1.14 entails that a pair of globally minimal holomorphically nondegenerate real analytic hypersurfaces in  $\mathbb{C}^n$  are  $\mathcal{C}^\infty$ -smoothly CR equivalent *if and only if* they are biholomorphically equivalent.

**1.15. Necessity.** Since 1995-6 (see [BR4], [BHR]), it was known that Theorem 1.14 above might provide an expected *necessary and sufficient condition* for  $h$  be analytic (provided of course that the local CR-envelope of holomorphy of  $M$ , which already contains one side  $D_p$  of  $M$  at  $p$ , does not contain the other side). Indeed, considering self-mappings of  $M'$ , we have :

**Lemma 1.16.** ([BHR]) *Conversely, if  $(M', p')$  is holomorphically degenerate and if there exists a  $\mathcal{C}^\infty$ -smooth CR function defined in a neighborhood of  $p' \in M'$  which does not extend holomorphically to a neighborhood of  $p'$ , then there exists a  $\mathcal{C}^\infty$ -smooth CR-automorphism of  $(M', p')$  fixing  $p'$  which is not real analytic at  $p'$ .*

**1.17. Organization of the paper.** To be brief, in §2 we present first a thorough intuitive description (in words) of our strategy for the proof of Theorems 1.2 and 1.9. This presentation is really important, since it helps to understand the general point of view without entering excessively technical considerations. Then §3, §4, §5, §6, §7 and §8 are devoted to complete all the proofs. We would like to mention that in the last §9, we provide a proof of the following assertion, which might be interesting in itself, because it holds without any rank assumption on  $h$ . We refer the reader to the beginning of §9 for comments, generalizations and applications.

**Theorem 1.18.** *Let  $h : M \rightarrow M'$  be a  $\mathcal{C}^\infty$ -smooth CR mapping between two connected real analytic hypersurfaces in  $\mathbb{C}^n$  ( $n \geq 2$ ). If  $M$  and  $M'$  do not contain any complex curve, then  $h$  is real analytic at every point of  $M$ .*

**1.19. Acknowledgement.** The author is very grateful to Egmont Porten, who pointed out to him the interest of gluing half-discs to the Levi flat hypersurfaces  $\Sigma_\gamma$  below. Also, the author wishes to thank Hervé Gaussier and the referee for clever and helpful suggestions concerning this paper.

## §2. DESCRIPTION OF THE PROOF OF THEOREM 1.2

**2.1. Continuity principle and reflection principle.** According to the extendability theorem proved in [R], [BT2] and generalized to only  $C^2$ -smooth hypersurfaces by Trépreau [Tr1], for every point  $p \in M$ , the mapping  $h$  in Theorems 1.9 and 1.14 already extends holomorphically to a one-sided neighborhood  $D_p$  of  $M$  at  $p$  in  $\mathbb{C}^n$ . This extension is performed by using small Bishop discs attached to  $M$  and by applying the approximation theorem proved in [BT1]. These  $D_p$  may be glued to yield a domain  $D$  attached to  $M$  which contains at least one side of  $M$  at every point. In this concern, we would like to remind the reader of the well known and somewhat “paradoxical” phenomenon of *automatic holomorphic extension of CR functions on  $M$  to both sides*, which can render the above Theorem 1.9 surprisingly trivial. Indeed, let  $U_M$  denote the (open) set of points  $q$  in  $M$  such that the envelope of holomorphy of  $D$  contains a neighborhood of  $q$  in  $\mathbb{C}^n$  (as is well known, if, for instance, the Levi form of  $M$  has one positive and one negative eigenvalue at  $q$ , then  $q \in U_M$ ; more generally, the *local envelope of holomorphy* of  $M$  or of the one-sided neighborhood  $D$  of  $M$  at an arbitrary point  $q \in M$  is always *one-sheeted*, as can be established using the approximation theorem proved in [BT1]). Then clearly, the  $n$  components  $h_1, \dots, h_n$  of our CR diffeomorphism extend holomorphically to a neighborhood of  $U_M$  in  $\mathbb{C}^n$ , as does any arbitrary CR function on  $M$ . But it remains to extend  $h$  holomorphically across  $M \setminus U_M$  and the techniques of the reflection principle are then unavoidable. *Here lies the “paradox”*: sometimes the envelope of holomorphy trivializes the problem, sometimes near some pseudoconvex points of finite D’Angelo type (but not all) it helps to control the behavior of the mapping thanks to local peak functions, sometimes it does not help at all, especially at every point of the “border” between the pseudoconvex and the pseudoconcave parts of  $M$ . In the interesting articles [DF2,3], Diederich-Fornæss succeeded in constructing the local envelope of holomorphy at many points of a real analytic non-pseudoconvex bounded boundary in  $\mathbb{C}^2$  for which the border consists of a compact maximally real submanifold and they deduced that any biholomorphic mapping between two such domains extends continuously up to the boundary as a CR homeomorphism. In general, it is desirable to describe constructively the local envelope of holomorphy at every point of the border of  $M$ . However, this general problem seems to be out of the reach of the presently known techniques of study of envelopes of holomorphy by means of analytic discs. Fortunately, in the study of the smooth reflection principle, the classical techniques usually do not make any difference between the two sets  $U_M$  and  $M \setminus U_M$  and these techniques provide a *uniform method* of extending  $h$  across  $M$ , no matter the reference point  $p$  belongs to  $U_M$  or to  $M \setminus U_M$  (see [L], [P3,4], [W1], [W2], [DW], [W3], [BJT], [BR1], [BR2], [DF2], [Su1], [Su2], [SS], [BHR], [BER1], [BER2], [CPS1], [CPS2]). Such a uniform method seems to be quite satisfactory. On the other hand, the recent far reaching works of Diederich-Pinchuk in the study of the *geometric reflection principle* show up an accurate analysis of the relative pseudo-convex(-concave) loci of  $M$ . Such an analysis originated in the works of Diederich-Fornæss [DF2,3] and in the work of Diederich-Fornæss-Ye [DFY]. In [P4], [DP1,2], [Hu], [Sha], the authors achieve the propagation of holomorphic extension of a “germ” along the Segre varieties of  $M$  (or the Segre sets), taking into account their relative position with respect to  $M$  and its local convexity. In such reasonings, various discussions concerning envelopes of holomorphy come down naturally in the proofs (which involve many sub-cases). However, comparing these two trends of thought, it seems to remain still really paradoxical that both phenomena contribute to the reflection principle, without an appropriate understanding of the general links between these two techniques. Guided by this observation, we have devised a new two-sided technique. In this article, we shall indeed perform the proof of Theorem 1.9 by *combining the technique of the reflection principle together with the consideration of envelopes of holomorphy*. Further, we have been guided by a deep analogy between the various reflection principles and the results on *propagation of analyticity for CR functions along CR curves*, in the spirit of the Russian school in the sixties, of Treves’ school, in the spirit of the works of Trépreau, of Tumanov, of Jöricke, of Porten and others : the vector fields of the complex tangent bundle  $T^cM$  being the *directions* of propagation for the one-sided holomorphic extension of CR functions, and



the Segre varieties giving these directions (because  $T_q^c M = T_q S_{\bar{q}}$  for all  $q \in M$ ), one can expect that Segre varieties *also propagate the analyticity of CR mappings*. Of course, such a propagation property is already well known and intensively studied since the historical works of Pinchuk [P1,2,3,4] and since the important more recent articles of Diederich-Fornæss-Ye [DFY] and of Diederich-Pinchuk [DP1,2]. However, in the classical works, one propagates along a single Segre variety  $S_{\bar{p}}$  and perhaps afterwards along the subsequent “Segre sets” if necessary ([BER1,2], [Me4,5,6,7,8], [Mi3,4]). As argued in [Me4,5], this terminology “Segre sets” is not the best one. But in the present article we will propagate the analytic properties along a *bundle* of Segre varieties of  $M$ , namely *along a Levi-flat union of Segre varieties*  $\Sigma_\gamma := \cup_{q \in \gamma} S_{\bar{q}}$ , parametrized by a smooth curve  $\gamma$  transversal to  $T^c M$ , in total analogy with the propagation of analyticity of CR functions, where one uses a *bundle of attached analytic discs*, parametrized by a curve transversal to  $T^c M$  (cf. Tumanov’s version of propagation [Tu2]; in this concern, we would like to mention that recently, Porten [Po] has discovered a simple strategy of proof using only CR orbits, deformations of bundles of analytic discs and Levi forms on manifolds with boundary which treats in an unified way the local ([Tu1]) and the global ([Tr2], [Tu2], [Me1], [J]) wedge extension theorem). Let us now explain our strategy in full details and describe our proof. To avoid excessive technicalities in this presentation, we shall discuss the proof of Theorem 1.2 instead of Theorem 1.9.

**2.2. Description of the proof of Theorem 1.2.** To begin with, recall from §1 that the generic rank of the locally defined holomorphic mapping  $\mathcal{Q}'_\infty : t' \mapsto (\Theta'_\beta(t'))_{\beta \in \mathbb{N}^{n-1}}$  is equal to the integer  $\chi'_{M'}$ . The generic rank of an infinite collection of holomorphic functions can always be interpreted in terms of finite subcollections  $\mathcal{Q}'_k(t') = (\Theta'_\beta(t'))_{|\beta| \leq k}$ . Of course, using the CR diffeomorphism assumption, we may prove carefully that  $\chi_M = \chi'_{M'}$  (see Lemma 4.3). It is known that  $M'$  is holomorphically nondegenerate if and only if  $\chi'_{M'} = n$ . In the remainder of §2, we shall assume that  $M'$  is holomorphically nondegenerate. Let  $q' \in M'$  be a point where the rank of  $\mathcal{Q}'_k(t')$  is equal to  $n$ , hence locally constant. In our first step, we will show that  $h$  is real analytic at the reciprocal image of each such point  $h^{-1}(q') \in M$ . In fact, these points  $q'$  are the *finitely nondegenerate* points of  $M'$ , in the sense of [BER2, §11.2]. In this case, it will appear that our proof of the first step is a reminiscence of the Lewy-Pinchuk reflection principle and in fact, it is a mild easy generalization of it, just by differentiating more than one time. Afterwards, during the second (crucial and much more delicate) step, to which §5–8 below are devoted, we shall extend  $h$  at each point  $h^{-1}(q')$ , where  $q'$  belongs to the real analytic subset  $E'_{M'} \subset M'$  where the mapping  $\mathcal{Q}'_\infty$  is not of rank  $n$ . This is where we use envelopes of holomorphy. We shall start as follows. By §3.47, there exists a proper real analytic subset  $E'_{M'}$  of  $M'$  such that the rank of the mapping  $\mathcal{Q}'_\infty$  localized around points  $p' \in M'$  equals  $n$  at each point  $q'$  close to  $p'$  not belonging to  $E'_{M'}$ . Let  $E'_{\text{na}} \subset E'_{M'} \subset M'$  (“na” for “non-analytic”) denote the closed set of points  $q' \in M'$  such that  $h$  is *not* real analytic in a neighborhood of  $h^{-1}(q')$ . By the first step,  $E'_{\text{na}}$  is necessarily contained in  $E'_{M'}$ . If  $E'_{\text{na}} = \emptyset$ , Theorem 1.9 would be proved, gratuitously. We shall therefore assume that  $E'_{\text{na}} \neq \emptyset$  and we shall endeavour to derive a contradiction in several nontrivial steps as follows. Assuming that  $E'_{\text{na}}$  is nonempty, in order to come to an absurd, it suffices to exhibit at least one point  $p'$  of  $E'_{\text{na}}$  such that  $h$  is in fact real analytic in a neighborhood of  $h^{-1}(p')$ . This is what we shall achieve and the proof is long. In analogy with what is done in [MP1,2], we shall first show that we can choose a particular point  $p'_1 \in E'_{\text{na}}$  which is nicely disposed as follows (see FIGURE 1).

**Lemma 2.3.** (cf. [MP1, Lemma 2.3]) *Let  $E' \subset M'$  be an arbitrary closed subset of an everywhere locally minimal real analytic hypersurface  $M' \subset \mathbb{C}^n$ , with  $n \geq 2$ . If  $E'$  and  $M' \setminus E'$  are nonempty, then there exists a point  $p'_1 \in E'$  and a real analytic one-codimensional submanifold  $M'_1$  of  $M'$  with  $p'_1 \in M'_1 \subset M'$  which is generic in  $\mathbb{C}^n$  and which divides  $M'$  near  $p'_1$  in two open parts  $M'_1^-$  and  $M'_1^+$  such that  $E' \setminus \{p'_1\}$  is contained in the open side  $M'_1^+$  near  $p'_1$ .*

To reach the desired contradiction, it will suffice to prove that  $h$  is analytic at the point  $h^{-1}(p'_1)$ , where  $p'_1 \in E'_{\text{na}} \cap M'_1$  is such a special point as in Lemma 2.3 above. To this aim, we shall pick a long embedded real analytic arc  $\gamma'$  contained in  $M'_1^-$  transverse to the complex

tangential directions of  $M'$ , with the “center”  $q'_1$  of  $\gamma'$  very close to  $p'_1$  (see FIGURE 1). Next, using the inverse mapping  $h^{-1}$ , we can copy back these objects on  $M$ , namely we set  $E_{\text{na}} := h^{-1}(E'_{\text{na}})$ ,  $\gamma := h^{-1}(\gamma')$ ,  $p_1 := h^{-1}(p'_1)$ ,  $q_1 := h^{-1}(q'_1)$ , whence  $M_1 := h^{-1}(M'_1)$ ,  $M_1^- = h^{-1}(M'^-_1)$  and  $M_1^+ = h^{-1}(M'^+_1)$ .

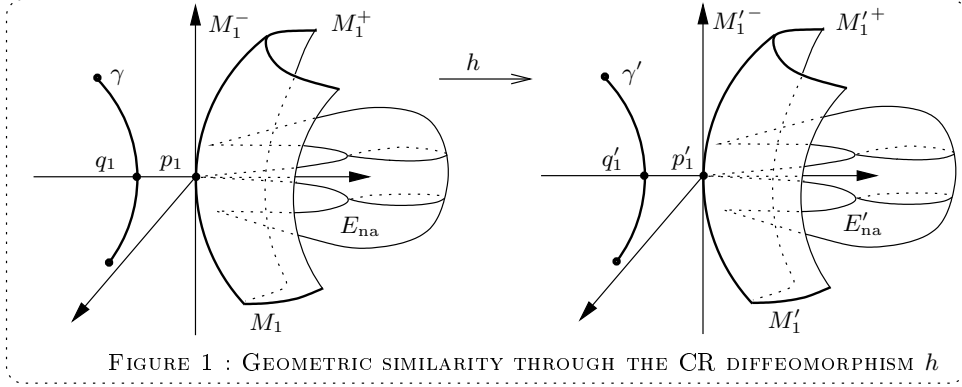

FIGURE 1 : GEOMETRIC SIMILARITY THROUGH THE CR DIFFEOMORPHISM  $h$

To the analytic arc  $\gamma'$ , we shall associate holomorphic coordinates  $t' = (z', w') \in \mathbb{C}^{n-1} \times \mathbb{C}$ ,  $w' = u' + iv'$ , such that  $p'_1 = 0$  and  $\gamma'$  is the  $u'$ -axis (in particular, some “normal” coordinates in the sense of [BJT] would be appropriate, but not indispensable) and we shall consider the reflection function  $\mathcal{R}'_h(t, \bar{v}') = \bar{\mu}' - \sum_{\beta \in \mathbb{N}^{n-1}} \bar{\lambda}'^\beta \Theta'_\beta(h(t))$  in these coordinates  $(z', w')$ . The functions  $\Theta'_\beta(h(t))$  will be called the *components of the reflection function*  $\mathcal{R}'_h$ . Next, we choose coordinates  $t \in \mathbb{C}^n$  near  $(M, p_1)$  vanishing at  $p_1$ . To the  $C^\infty$ -smooth arc  $\gamma$ , we shall associate the following  $C^\infty$ -smooth Levi-flat hypersurface :  $\Sigma_\gamma := \bigcup_{q \in \gamma} S_{\bar{q}}$ , where  $S_{\bar{q}}$  denotes the Segre variety of  $M$  associated to various points  $q \in M$  (see FIGURE 2). Let  $\Delta_n(0, \rho) := \{t \in \mathbb{C}^n : |t| < \rho\}$  be the polydisc with center 0 of polyradius  $(\rho, \dots, \rho)$ , where  $\rho > 0$ . Using the tangential Cauchy-Riemann operators to differentiate the fundamental identity which reflects the assumption  $h(M) \subset M'$ , we shall establish the following crucial observation.

**Lemma 2.4.** *There exists a positive real number  $\rho > 0$  independent of  $\gamma'$  such that all the components  $\Theta'_\beta(h(t))$  of the reflection function extend as CR functions of class  $C^\infty$  over  $\Sigma_\gamma \cap \Delta_n(0, \rho)$ .*

Furthermore, by global minimality of  $M$ , there exists a global one-sided neighborhood  $D$  of  $M$  to which all CR functions (hence the components of  $h$ ) extend holomorphically (see the details in §3.6). We now recall that, by construction of  $M'_1$ , the CR mapping  $h$  is already holomorphic in a small neighborhood of  $h^{-1}(q')$  for every point  $q' \in M'^-_1$ . It follows that the components  $\Theta'_\beta(h(t))$  of the reflection function are already holomorphic in a fixed neighborhood, say  $\Omega$ , of  $M_1^-$  in  $\mathbb{C}^n$ . Also, they are already holomorphic at each point of the global one-sided neighborhood  $D$ . In particular, they are holomorphic in a neighborhood  $\omega_\gamma \subset \Omega$  in  $\mathbb{C}^n$  of  $\gamma \subset M_1^-$ . Then according to the Hanges-Treves extension theorem [HaTr], we deduce that all the components  $\Theta'_\beta(h(t))$  of the reflection function extend holomorphically to a neighborhood  $\omega(\Sigma_\gamma)$  of  $\Sigma_\gamma$  in  $\mathbb{C}^n$ , which is a (very thin) neighborhood whose size depends of course on the size of  $\omega_\gamma$  (and the size of  $\omega_\gamma$  goes to zero without any explicit control as the center point  $q_1$  of  $\gamma$  tends towards  $p_1 \in E_{\text{na}}$ ).

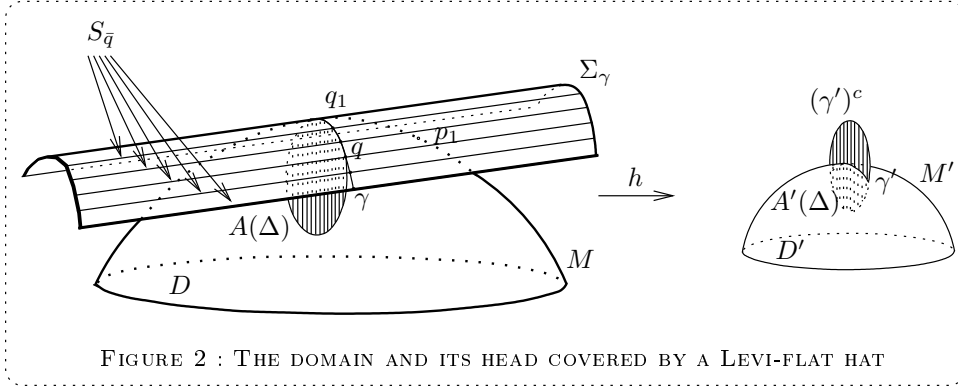

FIGURE 2 : THE DOMAIN AND ITS HEAD COVERED BY A LEVI-FLAT HAT

To achieve the final step, we shall consider the envelope of holomorphy of  $D \cup \Omega \cup \omega(\Sigma_\gamma)$  (in fact, to prevent from poly-dromy phenomena, we shall instead consider a certain subdomain of  $D \cup \Omega \cup \omega(\Sigma_\gamma)$ , see the details in §6 below), which is a kind of round domain  $D \cup \Omega$  covered by a thin Levi-flat almost horizontal “hat-domain”  $\omega(\Sigma_\gamma)$  touching the “top of the head”  $M$  along the one-dimensional arc  $\gamma$  (see FIGURE 3).

Our purpose will be to show that, if the arc  $\gamma'$  is sufficiently close to  $M'_1$  (whence  $\gamma$  is also very close to  $M_1$ ), then the envelope of holomorphy of  $D \cup \Omega \cup \omega(\Sigma_\gamma)$  contains the point  $p_1$ , even if  $\omega(\Sigma_\gamma)$  is arbitrarily thin. We will therefore deduce that all the components of the reflection function extend holomorphically at  $p_1$ , thereby deriving the desired contradiction. By exhibiting a special curved Hartogs domain, we shall in fact prove that holomorphic functions in  $D \cup \Omega \cup \omega(\Sigma_\gamma)$  extend holomorphically to the lower one sided neighborhood  $\Sigma_\gamma^-$  (the “same” side as  $D = M^-$ , see FIGURE 3); we explain below why this analysis gives analyticity at  $p_1$ , even in the (in fact simpler) case where  $p_1$  belongs to the other side  $\Sigma_\gamma^+$ .

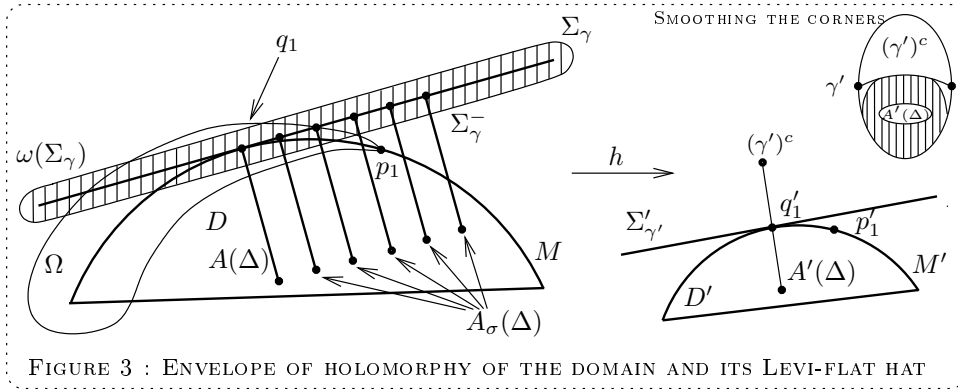

FIGURE 3 : ENVELOPE OF HOLOMORPHY OF THE DOMAIN AND ITS LEVI-FLAT HAT

Notice that, because the order of contact between  $\Sigma_\gamma$  and  $M$  is at least equal to two (because  $T_q M = T_q \Sigma_\gamma$  for every point  $q \in \gamma$ ), we cannot apply directly any version of the edge of the wedge theorem to this situation. Another possibility (which, on the contrary, might well succeed) would be to apply repeatedly the Hanges-Treves theorem, in the disc version given in [Tu2] (see also [MP1]) to deduce that holomorphic functions in  $D \cup \Omega \cup \omega(\Sigma_\gamma)$  extend holomorphically to the lower side  $\Sigma_\gamma^-$ , just by sinking progressively  $\Sigma_\gamma$  into  $D$ . But this would require a too complicated analysis for the desired statement. Instead, by performing what seems to be the simplest strategy, we shall use some deformations (“translations”) of the following half analytic disc attached to  $\Sigma_\gamma$  along  $\gamma$ . We shall consider the inverse image by  $h$  of the half-disc  $(\gamma')^c \cap D'$  obtained by complexifying  $\gamma'$  (see FIGURE 2 and FIGURE 3). Rounding off the corners and reparametrizing the disc, we get an analytic disc  $A \in \mathcal{O}(\Delta) \cap \mathcal{C}^\infty(\overline{\Delta})$  with  $A(b^+ \Delta) \subset \gamma \subset \Sigma_\gamma$ , where  $b^+ \Delta := b \Delta \cap \{\operatorname{Re} \zeta \geq 0\}$ ,  $b \Delta = \{|z| = 1\}$  and  $A(1) = q_1$ . It is this

half-attached disc that we shall “translate” along the complex tangential directions to  $\Sigma_\gamma$  as follows.

**Lemma 2.5.** *There exists a  $C^\infty$ -smooth  $(2n-2)$ -parameter family of analytic discs  $A_\sigma : \Delta \rightarrow \mathbb{C}^n$ ,  $\sigma \in \mathbb{R}^{2n-2}$ ,  $|\sigma| < \varepsilon$ , satisfying*

- (1) *The disc  $A_\sigma|_{\sigma=0}$  coincides with the above disc  $A$ .*
- (2) *The discs  $A_\sigma$  are half-attached to  $\Sigma_\gamma$ , namely  $A_\sigma(b^+\Delta) \subset \Sigma_\gamma$ .*
- (3) *The boundaries  $A_\sigma(b\Delta)$  of the discs  $A_\sigma$  are contained in  $D \cup \Omega \cup \omega(\Sigma_\gamma)$ .*
- (4) *The mapping  $(\zeta, \sigma) \mapsto A_\sigma(\zeta) \in \Sigma_\gamma$  is a  $C^\infty$ -smooth diffeomorphism from a neighborhood of  $(1, 0) \in b\Delta \times \mathbb{R}^{2n-2}$  onto a neighborhood of  $q_1$  in  $\Sigma_\gamma$ .*
- (5) *As  $\gamma = h^{-1}(\gamma')$  varies and as  $q_1$  tends to  $p_1$ , these discs depend  $C^\infty$ -smoothly upon  $\gamma'$  and properties (1-4) are stable under perturbations of  $\gamma'$ .*
- (6) *If  $\gamma(0) = q_1$  is sufficiently close to  $M_1$ , and if  $p_1 \in \Sigma_\gamma^-$  is under  $\Sigma_\gamma$  (as in FIGURE 3), then the envelope of holomorphy of (an appropriate subdomain of)  $D \cup \Omega \cup \omega(\Sigma_\gamma)$  contains  $p_1$ .*

Consequently, using these properties (1-6) and applying the continuity principle to the family  $A_\sigma$ , we shall obtain that the envelope of holomorphy of  $D \cup \Omega \cup \omega(\Sigma_\gamma)$  (in fact of a good subdomain of it, in order to assure monodromy) contains a large part of the side  $\Sigma_\gamma^-$  of  $\Sigma_\gamma$  in which  $D(= M^-)$  lies. In the case where  $p_1$  lies in this side  $\Sigma_\gamma^-$ , and provided that the center point  $q_1$  of  $\gamma$  is sufficiently close to  $p_1$ , we are done : the components of the reflection function extend holomorphically at  $p_1$  (this case is drawn in FIGURE 3). Of course, it can happen that  $p_1$  lies in the other side  $\Sigma_\gamma^+$  or in  $\Sigma_\gamma$  itself. In fact, the following tri-chotomy is in order to treat the problem. To apply Lemma 2.5 correctly, and to complete the study of our situation, we shall indeed distinguish three cases.

**Case I.** The Segre variety  $S_{\bar{p}_1}$  cuts  $M_1^-$  along an infinite sequence of points  $(q_k)_{k \in \mathbb{N}}$  tending towards  $p_1$ .

**Case II.** The Segre variety  $S_{\bar{p}_1}$  does not intersect  $M_1^-$  in a neighborhood of  $p_1$  and it goes under  $M_1^-$ , namely inside  $D$ .

**Case III.** The Segre variety  $S_{\bar{p}_1}$  does not intersect  $M_1^-$  in a neighborhood of  $p_1$  and it goes over  $M_1^-$ , namely over  $D \cup M_1^-$ .

In the first case, choosing the point  $q_1$  above to be one of the points  $q_k$  which is sufficiently close to  $p_1$ , and using the fact that  $p_1$  belongs to  $S_{\bar{q}_1}$  (because  $q_1 \in S_{\bar{p}_1}$ ), we have in this case  $p_1 \in \Sigma_\gamma$  and the holomorphic extension to a neighborhood  $\omega(\Sigma_\gamma)$  already yields analyticity at  $p_1$  (in this case, we have nevertheless to use Lemma 2.5 to insure monodromy of the extension). In the second case, we have  $S_{\bar{p}_1} \cap D \neq \emptyset$ . We then choose the center point  $q_1$  of  $\gamma$  very close to  $p_1$ . Because we have in this case a uniform control of the size of  $\omega(\Sigma_\gamma)$ , we again get that  $p_1$  always belongs to  $\omega(\Sigma_\gamma)$  and Lemma 2.5 is again used to insure monodromy. In the third (a priori more delicate) case, by a simple calculation, we shall observe that  $p_1$  always belong to the lower side  $\Sigma_\gamma^-$  (as in FIGURE 3) and Lemma 2.5 applies to yield holomorphic extension and monodromy of the extension. In sum, we are done in all the three cases : we have shown that the components  $\Theta'_\beta(h(t))$  all extend holomorphically at  $p_1$ . Finally, using a complex analytic set similar to  $\mathcal{C}'_h$  defined in (1.12) and Lemma 4.14 below, we deduce that  $h$  is real analytic at  $p_1$ .

In conclusion to this presentation, we would like to say that some unavoidable technicalities that we have not mentioned here will render the proof a little bit more complicated (especially about the choice of  $q_1$  sufficiently close to  $p_1$ , about the choice of  $\gamma$  and about the smooth dependence with respect to  $\gamma$  of  $\Sigma_\gamma$  and of  $A_\sigma$ ). The remainder of the paper is devoted to complete these technical features thoroughly. At first, we provide some necessary background material about the reflection function.

### §3. BIHOLOMORPHIC INVARIANCE OF THE REFLECTION FUNCTION

**3.1. Preliminary and notation.** Let  $p' \in M'$ , let  $t' = (z'_1, \dots, z'_{n-1}, w') = (z', w')$  be holomorphic coordinates vanishing at  $p'$  such that the projection  $T_{p'}^c M' \rightarrow \mathbb{C}_{z'}^{n-1}$  is submersive.

As in §1, we can represent  $M'$  by a complex analytic defining equation of the form  $\bar{w}' = \Theta'(\bar{z}', t')$ , where the right hand side function converges normally in the polydisc  $\Delta_{2n-1}(0, \rho')$  for some  $\rho' > 0$ . Here, by normal convergence we mean precisely that there exists a constant  $C > 0$  such that if we develop  $\Theta'(\bar{z}', t') = \sum_{\beta \in \mathbb{N}^{n-1}} \sum_{\alpha \in \mathbb{N}^n} (\bar{z}')^\beta (t')^\alpha \Theta'_{\beta, \alpha}$ , with  $\Theta'_{\beta, \alpha} \in \mathbb{C}$ , then we have

$$(3.2) \quad |\Theta'_{\beta, \alpha}| \leq C (\rho')^{-|\alpha| - |\beta|},$$

for all multi-indices  $\alpha$  and  $\beta$ . Furthermore, by the reality of  $M'$  the function  $\Theta'$  satisfies the power series identity  $\Theta'(\bar{z}', z', \bar{\Theta}'(z', \bar{z}', \bar{w}')) \equiv \bar{w}'$ . It follows from this identity that  $\Theta'_0(t')$  does not vanish identically, and in fact contains the monomial  $w' \equiv \Theta'_0(0, w')$ . We set  $p := h^{-1}(\rho')$  and similarly, we represent a local defining equation of  $M$  near  $p$  as  $\bar{w} = \Theta(\bar{z}, t)$ , where  $\Theta$  converges normally in  $\Delta_{2n-1}(0, \rho)$  for some  $\rho > 0$ . We denote the mapping by  $h := (f, g) := (f_1, \dots, f_{n-1}, g)$ . Then the assumption that  $h$  maps  $M$  into  $M'$  yields that

$$(3.3) \quad \overline{g(t)} = \Theta'(\overline{f(t)}, h(t)),$$

for all  $t \in M$  near  $p$ . For this relation to hold locally, it is convenient to assume that  $|h(t)| < \rho'$  for every  $t \in M$  with  $|t| < \rho$ .

Since by assumption the  $h_j$  are of class  $\mathcal{C}^\infty$  and CR over  $M$ , we can extend them to a neighborhood of  $M$  in  $\mathbb{C}^n$  as functions  $\tilde{h}_j$  of class  $\mathcal{C}^\infty$  with antiholomorphic derivatives  $\partial_{\bar{t}_l} \tilde{h}_j$  vanishing to infinite order on  $M$ ,  $l = 1, \dots, n$ . So, if we develop these extensions in real Taylor series at each point  $q \in M$  as follows :

$$(3.4) \quad T_q^\infty \tilde{h}_j = \tilde{h}_j(q) + \sum_{\alpha \in \mathbb{N}^n \setminus \{0\}} \partial_t^\alpha \tilde{h}_j(q) (t - q)^\alpha / \alpha! \in \mathbb{C}[[t]],$$

there are no antiholomorphic term.

The reflection function associated with such a coordinate system and with such a defining equation, namely

$$(3.5) \quad \mathcal{R}'_h(t, \bar{v}') := \bar{\mu}' - \sum_{\beta \in \mathbb{N}^{n-1}} (\bar{\lambda}')^\beta \Theta'_\beta(h(t)),$$

where  $\bar{v}' = (\bar{\lambda}', \bar{\mu}')$ , converges normally with respect to  $t \in M$  with  $|t| < \rho$  and  $\bar{v}' \in \mathbb{C}^n$  with  $|\bar{v}'| < \rho'$ , hence defines a function which is CR of class  $\mathcal{C}^\infty$  on  $M$  near  $p$  and holomorphic with respect to  $\bar{v}'$ . The main goal of this paragraph is to study its invariance with respect to changes of coordinates.

**3.6. Holomorphic extension to a one-sided neighborhood attached to  $M$ .** Before treating invariance, recall that thanks to the local minimality at every point, all CR functions on  $M$  and in particular the  $h_j$  extend holomorphically to one side of  $M$  at every point of  $M$  (the simplest proof of this result can be found in [R]; see also the excellent survey [Tr3] for a proof using Bishop discs). Of course, the side may vary. We do not require that  $M$  be orientable, but anyway the small pieces  $(M, p)$  always divide locally  $\mathbb{C}^n$  in two components  $(M, p)^\pm$ . By shrinking these one-sided neighborhoods covered by attached analytic discs, we may assume that for every point  $p \in M$ , all CR functions on  $M$  extend holomorphically to the intersection of a small nonempty open ball  $B_p$  centered at  $p$  with one of the two local open components  $(M, p)^\pm$ . Let  $D_p$  denote the resulting open side of  $M$  at  $p$ , namely  $D_p = B_p \cap (M, p)^+$  or  $D_p = B_p \cap (M, p)^-$ . Since the union of the various open sets  $D_p$  does not necessarily make a domain, we introduce the following definition. By a *global one-sided neighborhood* of  $M$  in  $\mathbb{C}^n$ , we mean a *domain*  $D$  such that for every point  $p \in M$ ,  $D$  contains a local one-sided neighborhood of  $M$  at  $p$ . In particular,  $D$  necessarily contains a neighborhood of a point  $q \in M$  if it contains the two local sides of  $M$  at  $q$ . To construct a global one-sided neighborhood to which all  $\mathcal{C}^\infty$ -smooth and even  $\mathcal{C}^0$ -smooth CR functions on  $M$  extend holomorphically, it suffices to set

$$(3.7) \quad D := \bigcup_{q \in M} D_q \bigcup_{D_p \cap D_q = \emptyset} (B_p \cap \overline{D_p} \cap \overline{D_q} \cap B_q).$$

The second part of this union consists of an open subset of  $M$  which connects every meeting pair of local one-sided neighborhoods in the case where their respective sides differ. If the radii of the  $B_p$  are sufficiently small compared to the geometric distortion of  $M$ , then the open set defined by (3.6) is a domain in  $\mathbb{C}^n$ . Moreover, using the uniqueness principle for CR functions, it is elementary to see that every CR function  $\phi$  on  $M$  extends as a unique holomorphic function globally defined over  $D$ . In this concern, we would like to mention that a more general construction in arbitrary codimension in terms of attached wedges is provided in [Me2], [MP1,2] and in [Da2].

Since each  $D_p$  is contained in some union of small Bishop discs with boundaries contained in  $(M, p)$ , it follows that the maximum modulus of the holomorphic extension of  $\phi$  to  $D_p$  is less than or equal to the maximum modulus of the CR function  $\phi$  over the piece  $(M, p)$ , which is a little bit larger than  $\overline{D_p} \cap M$ . To be precise, after shrinking  $B_p$  if necessary, we can assume that the Bishop discs covering  $D_p$  have their boundaries attached to  $M \cap \{|t| < \rho\}$ . Since  $|h(t)| < \rho'$  for  $t \in M$  with  $|t| < \rho$ , the same majoration holds for  $t \in D_p$  (maximum principle), so it follows that the series defined by (3.5) also converges normally with respect to  $t$  inside  $D_p$ . In conclusion, we have established the following.

**Lemma 3.8.** *With the above notation,  $\mathcal{R}'_h$  is defined in the set*

$$(3.9) \quad [D_p \cup (M \cap \Delta_n(0, \rho))] \times \Delta_n(0, \rho') \subset \Delta_n(0, \rho) \times \Delta_n(0, \rho').$$

*Precisely,  $\mathcal{R}'_h$  is holomorphic with respect to  $(t, \bar{v}')$  in  $D_p \times \Delta_n(0, \rho')$  and it is CR of class  $\mathcal{C}^\infty$  over the real analytic hypersurface*

$$(3.10) \quad [M \cap \Delta_n(0, \rho)] \times \Delta_n(0, \rho') \subset \Delta_n(0, \rho) \times \Delta_n(0, \rho').$$

**3.11. Characterization of the holomorphic extendability of  $\mathcal{R}'_h$ .** Let  $x \in \mathbb{C}^m$ ,  $x' \in \mathbb{C}^{m'}$  and consider a power series of the form

$$(3.12) \quad R(x, x') := \sum_{\alpha \in \mathbb{N}^m, \alpha' \in \mathbb{N}^{m'}} R_{\alpha, \alpha'} x^\alpha (x')^{\alpha'},$$

where the  $R_{\alpha, \alpha'}$  are complex coefficients. Let us assume that  $R$  converges normally in some polydisc  $\Delta_m(0, \sigma) \times \Delta_{m'}(0, \sigma')$ , for some two  $\sigma, \sigma' > 0$ . By normal convergence, we mean that there exists a constant  $C > 0$  such that the Cauchy inequalities  $|R_{\alpha, \alpha'}| \leq C (\sigma)^{-|\alpha|} (\sigma')^{-|\alpha'|}$  hold. Let us define  $R_{\alpha'}(x) := \sum_{\alpha \in \mathbb{N}^m} R_{\alpha, \alpha'} x^\alpha = \left[ \frac{1}{\alpha'!} \partial_{x'}^{\alpha'} R(x, x') \right]_{x':=0}$ . Classically in the basic theory of converging power series, it follows that for every positive  $\tilde{\sigma} < \sigma$ , there exists a constant  $C_{\tilde{\sigma}}$  which depends on  $\tilde{\sigma}$  such that for all  $x$  satisfying  $|x| < \tilde{\sigma}$ , the estimate  $|R_{\alpha'}(x)| \leq C_{\tilde{\sigma}} (\sigma')^{-|\alpha'|}$  holds. Indeed, we simply compute for  $|x| < \tilde{\sigma}$  the elementary series :

$$(3.13) \quad \begin{cases} |R_{\alpha'}(x)| \leq \sum_{\alpha \in \mathbb{N}^m} |R_{\alpha, \alpha'}| |x|^\alpha \leq \\ \leq C \sum_{\alpha \in \mathbb{N}^m} \sigma^{-|\alpha|} (\sigma')^{-|\alpha'|} \tilde{\sigma}^{|\alpha|} = C \left( \frac{\sigma}{\sigma - \tilde{\sigma}} \right)^m (\sigma')^{-|\alpha'|}. \end{cases}$$

As an application, such an inequality applies to the defining function of  $M'$  : for every positive  $\tilde{\rho}' < \rho'$ , there exists a constant  $C_{\tilde{\rho}'}$  such that for all  $|t'| < \tilde{\rho}'$  we have

$$(3.14) \quad |\Theta'_\beta(t')| \leq C_{\tilde{\rho}'} (\rho')^{-|\beta|}.$$

The estimation (3.13) also exhibits an interesting basic property. Suppose for a while that the reflection function  $\mathcal{R}'_h$  defined by (3.5) extends holomorphically to the polydisc  $\Delta_n(0, \sigma) \times \Delta_n(0, \sigma')$  for some positive  $\sigma, \sigma' > 0$  with  $\sigma < \rho$  and  $\sigma' < \rho'$ . Then the functions  $\theta'_\beta(t)$  defined by

$$(3.15) \quad \theta'_\beta(t) := \left[ \frac{1}{\beta!} \partial_{\bar{\lambda}'}^\beta \mathcal{R}'_h(t, \bar{v}') \right]_{\bar{\lambda}':=0}$$

satisfy a Cauchy estimate, namely  $|\theta'_\beta(t)| \leq C_{\tilde{\sigma}}(\sigma')^{-|\beta|}$  for all  $|t| < \tilde{\sigma} < \sigma$ . By (3.5), notice that  $\theta'_\beta(t) \equiv \Theta'_\beta(h(t))$  over  $M \cap \Delta_n(0, \rho)$  and inside  $D_p$ , so the holomorphic extendability of  $\mathcal{R}'_h$  implies that all the components  $\Theta'_\beta(h(t))$  extend holomorphically to  $\Delta_n(0, \sigma)$ . These preliminary observations are appropriate to obtain the following useful characterization of the holomorphic extendability of  $\mathcal{R}'_h$  which says in substance that it suffices that all its components  $\Theta'_\beta(h(t))$  extend at  $p$  and then afterwards the Cauchy estimate holds automatically.

**Lemma 3.16.** *The following three properties are equivalent :*

- (i) *There exists  $\sigma > 0$  with  $\sigma < \rho$  and  $\sigma < \rho'$  such that  $\mathcal{R}'_h$  extends holomorphically to the polydisc  $\Delta_n(0, \sigma) \times \Delta_n(0, \sigma)$ .*
- (ii) *There exists  $\sigma > 0$  with  $\sigma < \rho$  such that all  $C^\infty$ -smooth CR functions  $\Theta'_\beta(h(t))$  defined on  $M \cap \Delta_n(0, \rho)$  extend holomorphically to the polydisc  $\Delta_n(0, \sigma)$  as holomorphic functions  $\theta'_\beta(t)$  which satisfy the inequality  $|\theta'_\beta(t)| \leq C(\sigma')^{-|\beta|}$  for some two positive constants  $C > 0$ ,  $\sigma' < \rho'$  and for all  $|t| < \sigma$ .*
- (iii) *There exists  $\sigma > 0$  with  $\sigma < \rho$  such that all  $C^\infty$ -smooth CR functions  $\Theta'_\beta(h(t))$  defined on  $M \cap \Delta_n(0, \rho)$  extend holomorphically to the polydisc  $\Delta_n(0, \sigma)$  as holomorphic functions  $\theta'_\beta(t)$ .*

*Démonstration.* Of course, (i) implies (ii) which in turn implies (iii) trivially. Conversely, let us show that (iii) implies (ii). By (3.4) with  $q = 0$ , the Taylor series of  $h_j$  at the origin  $H_j(t) := T_0^\infty \tilde{h}_j(t)$  involves only holomorphic monomials  $t^\alpha$  and *no* antiholomorphic monomial. We notice that the Taylor series at the origin of  $\Theta'_\beta(h(t))$  coincides with the composition of formal power series  $\Theta'_\beta(H(t))$ . Consequently, by the assumption (iii), the formal power series mapping  $H(t)$  is a formal solution of some evident complex analytic equations. Indeed, we have

$$(3.17) \quad R'_\beta(t, H(t)) := \Theta'_\beta(H(t)) - \theta'_\beta(t) \equiv 0 \quad \text{in } \mathbb{C}[t],$$

for all  $\beta \in \mathbb{N}^{n-1}$ . By the Artin approximation theorem (*see* [Ar]), there exists an analytic power series  $\tilde{H}(t)$  with  $\tilde{H}(0) = 0$ , which converges normally in some polydisc, say  $\Delta_n(0, \sigma)$  with  $\sigma > 0$ , and which satisfies

$$(3.18) \quad R'_\beta(t, \tilde{H}(t)) := \Theta'_\beta(\tilde{H}(t)) - \theta'_\beta(t) \equiv 0,$$

for all  $t \in \Delta_n(0, \sigma)$ . Shrinking  $\sigma$  if necessary, we may assume that for  $|t| < \sigma$ , we have  $|\tilde{H}(t)| < \sigma' < \rho'$ . Then the Cauchy estimate (3.14) valuable for the  $\Theta'_\beta(t')$  yields by composition a Cauchy estimate for  $\Theta'_\beta(\tilde{H}(t))$  which in turn yields the desired Cauchy estimate for the  $\theta'_\beta(t)$  as stated in the end of (ii), thanks to the relations (3.18). This completes the proof.  $\square$

**3.19. Invariance of the reflection function.** Our definition of the reflection function  $\mathcal{R}'_h$  seems to be unsatisfactory, because it heavily depends on the choice of coordinates and on the choice of a local defining function for  $(M', p')$ . Our purpose is now to show that Theorem 1.9 holds true for *every* system of coordinates provided it holds for *one* such system. This requires to analyze how the components  $\Theta'_\beta(h(t))$  behave under the action of biholomorphisms. Let  $t'' = \Lambda(t')$  be a local biholomorphic mapping such that  $\Lambda(0) = 0$ , denote  $t'' = (z'', w'') = (z''_1, \dots, z''_{n-1}, w'')$  and denote  $\Lambda = (\Phi_1, \dots, \Phi_{n-1}, \Psi)$  accordingly. By the implicit function theorem, if we assume that the linear mapping  $\pi'' \circ d\Lambda : T_0^c M' \rightarrow \mathbb{C}_{z''}^{n-1}$  is bijective, where  $\pi'' : \mathbb{C}_{z'', w''}^n \rightarrow \mathbb{C}_{z''}^{n-1}$  is the projection parallel to the  $w''$  axis, then the image  $\Lambda(M')$  can also be defined locally in a neighborhood of the origin by a defining equation of the form  $\bar{w}'' = \Theta''(\bar{z}'', t'')$  similar to that of  $M'$ . Equivalently, this differential geometric condition can be expressed by the nonvanishing

$$(3.20) \quad \det \left( \bar{L}'_j \bar{\Phi}_k(0) \right)_{1 \leq j, k \leq n-1} \neq 0,$$

where the  $\bar{L}'_j$  constitute a basis for the CR vector fields on  $M'$ , namely  $\bar{L}'_j = \partial_{\bar{z}'_j} + \Theta'_{\bar{z}'_j}(\bar{z}', t') \partial_{\bar{w}'}$  for  $j = 1, \dots, n-1$ . Thus, we aim to compare the two reflection functions

$$(3.21) \quad \begin{cases} \mathcal{R}'_h(t, \bar{v}') := \bar{\mu}' - \sum_{\beta \in \mathbb{N}^{n-1}} (\bar{\lambda}')^\beta \Theta'_\beta(h(t)), \\ \mathcal{R}''_{\Lambda \circ h}(t, \bar{v}'') := \bar{\mu}'' - \sum_{\beta \in \mathbb{N}^{n-1}} (\bar{\lambda}'')^\beta \Theta''_\beta(\Lambda \circ h(t)). \end{cases}$$

Without loss of generality, we can assume that  $\Theta''$  converges normally in  $\Delta_{2n-1}(0, \rho'')$  and that  $\Lambda(\Delta_n(0, \rho'))$  is contained in  $\Delta_n(0, \rho'')$ . The following lemma exhibits the desired invariance under biholomorphic transformations fixing the center point  $p'$  and Lemma 3.37 below will show the invariance under local translations of the center point.

**Lemma 3.22.** *The following two conditions are equivalent :*

- (i) *There exists  $\sigma > 0$  with  $\sigma < \rho$  and  $\sigma < \rho'$  such that  $\mathcal{R}'_h(t, \bar{v}')$  extends holomorphically to the polydisc  $\Delta_n(0, \sigma) \times \Delta_n(0, \sigma)$ .*
- (ii) *There exists  $\sigma > 0$  with  $\sigma < \rho$  and  $\sigma < \rho''$  such that  $\mathcal{R}''_{\Lambda \circ h}(t, \bar{v}'')$  extends holomorphically to the polydisc  $\Delta_n(0, \sigma) \times \Delta_n(0, \sigma)$ .*

*Démonstration.* Of course, it suffices to prove that (i) implies (ii), because  $\Lambda$  is invertible. The proof is a little bit long and calculatory, but the principle is quite simple (in advance, the reader may skip to equation (3.35) and to the paragraph following which explain well the relation between the components of the two reflection functions). As  $\Lambda$  maps  $M'$  into  $M''$ , there exists a converging power series  $A(t', \bar{t}')$  such that the following identity holds for all  $t'$  with  $|t'| < \rho'$  :

$$(3.23) \quad \bar{\Psi}(\bar{t}') - \Theta''(\bar{\Phi}(\bar{t}'), \Lambda(t')) \equiv A(t', \bar{t}') [\bar{w}' - \Theta'(\bar{z}', t')]$$

Replacing  $\bar{w}'$  by  $\Theta'(\bar{z}', t')$  on the left hand side, we get an interesting formal power series identity at the origin in  $\mathbb{C}^{2n-1}$

$$(3.24) \quad \bar{\Psi}(\bar{z}', \Theta'(\bar{z}', t')) \equiv \Theta''(\bar{\Phi}(\bar{z}', \Theta'(\bar{z}', t')), \Lambda(t')),$$

which converges for all  $|\bar{z}'| < \rho'$  and  $|t'| < \rho'$ . Putting  $\bar{z}' = 0$ , we see first that

$$(3.25) \quad \bar{\Psi}(0, \Theta'(0, t')) \equiv \Theta''(\bar{\Phi}(0, \Theta'(0, t')), \Lambda(t')).$$

Next, we differentiate the relation (3.24) with respect to  $\bar{z}'_j$  for  $j = 1, \dots, n-1$ . Remembering that  $\bar{L}'_j = \partial_{\bar{z}'_j} + \Theta'_{\bar{z}'_j}(\bar{z}', t') \partial_{\bar{w}'}$ , we see that differentiation with respect to  $\bar{z}'_j$  is the same as applying the operator  $\bar{L}'_j$  and we get by the chain rule

$$(3.26) \quad \bar{L}'_j \bar{\Psi}(\bar{z}', \Theta'(\bar{z}', t')) \equiv \sum_{k=1}^{n-1} \bar{L}'_j \bar{\Phi}_k(\bar{z}', \Theta'(\bar{z}', t')) \frac{\partial \Theta''}{\partial \bar{z}''_k}(\bar{\Phi}(\bar{z}', \Theta'(\bar{z}', t')), \Lambda(t')).$$

Consider the following determinant, which, by the assumption (3.20) does not vanish at the origin :

$$(3.27) \quad \mathcal{D}'(\bar{z}', t') := \det \left( \bar{L}'_j \bar{\Phi}_k(\bar{z}', \Theta'(\bar{z}', t')) \right)_{1 \leq j, k \leq n-1}.$$

Shrinking  $\rho'$  if necessary, we can assume that  $\mathcal{D}'$  is nonzero at every point of  $\Delta_{2n-1}(0, \rho')$ . Then using the rule of Cramer, we can solve in (3.26) the first order partial derivatives of  $\Theta''$  with respect to the rest. We obtain an expression of the form

$$(3.28) \quad \frac{\partial \Theta''}{\partial \bar{z}''_k}(\bar{\Phi}(\bar{z}', \Theta'(\bar{z}', t')), \Lambda(t')) \equiv \frac{R_k(\{(\bar{L}')^\gamma \bar{\Lambda}_i(\bar{z}', \Theta'(\bar{z}', t'))\}_{|\gamma|=1, 1 \leq i \leq n})}{\mathcal{D}'(\bar{z}', t')}.$$

Here, for every multi-index  $\gamma \in \mathbb{N}^{n-1}$ , we denote by  $(\bar{L}')^\gamma$  the antiholomorphic derivation of order  $|\gamma|$  defined by  $(\bar{L}'_1)^{\gamma_1} \cdots (\bar{L}'_{n-1})^{\gamma_{n-1}}$ . Moreover, in (3.28), it is a fact that the terms  $R_k$  are certain universal polynomials in their  $n(n-1)$  arguments.



By differentiating again (3.28) with respect to the  $\bar{z}'_j$ , using Cramer's rule, and making an inductive argument, it follows that for every multi-index  $\beta \in \mathbb{N}^{n-1}$ , there exists a certain complicated but universal polynomial  $R_\beta$  such that the following relation holds :

$$(3.29) \quad \frac{1}{\beta!} \frac{\partial^{|\beta|} \Theta''}{\partial(\bar{z}'')^\beta} (\bar{\Phi}(\bar{z}', \Theta'(\bar{z}', t')), \Lambda(t')) \equiv \frac{R_\beta(\{(\bar{L}')^\gamma \bar{\Lambda}_i(\bar{z}', \Theta'(\bar{z}', t'))\}_{1 \leq |\gamma| \leq |\beta|, 1 \leq i \leq n})}{[\mathcal{D}'(\bar{z}', t')]^{2|\beta|-1}}.$$

Now, we put  $\bar{z}' := 0$  in these identities. An important observation is in order. The composed derivations  $(\bar{L}')^\gamma$  are certain differential operators with nonconstant coefficients. Using the explicit expression of the  $\bar{L}'_j$ , we see that all these coefficients are certain universal polynomials of the collection of partial derivatives  $\{\partial^{|\delta|} \Theta'(\bar{z}', t') / \partial(\bar{z}')^\delta\}_{1 \leq |\delta| \leq |\gamma|}$ . Thus the numerator of (3.29), after putting  $\bar{z}' := 0$ , becomes a certain holomorphic function of the collection  $\{\Theta'_\gamma(t')\}_{0 \leq |\gamma| \leq |\beta|}$  (recall  $\Theta'_\gamma(t') = \left[ \frac{1}{\gamma!} \partial^{|\gamma|} \Theta'(\bar{z}', t') / \partial(\bar{z}')^\gamma \right]_{\bar{z}'=0}$ ). A similar property holds for the denominator. In summary, we have shown that there exists an infinite collection of holomorphic functions  $S_\beta$  of their arguments such that

$$(3.30) \quad \frac{1}{\beta!} \frac{\partial^{|\beta|} \Theta''}{\partial(\bar{z}'')^\beta} (\bar{\Phi}(0, \Theta'(0, t')), \Lambda(t')) \equiv S_\beta(\{\Theta'_\gamma(t')\}_{|\gamma| \leq |\beta|}) =: s_\beta(t'),$$

where the left and right hand sides are holomorphic functions of  $t'$  running in the polydisc  $\Delta_n(0, \rho')$ . Furthermore, by Cauchy's integral formula, there exists a positive constant  $C$  such that for all  $|\bar{z}''|, |t''| < \rho''/2$ , we have the majoration

$$(3.31) \quad \left| \frac{1}{\beta!} \frac{\partial^{|\beta|} \Theta''}{\partial(\bar{z}'')^\beta} (\bar{z}'', t'') \right| \leq C (\rho''/2)^{-|\beta|}.$$

Consequently we get the estimate  $|s_\beta(t')| \leq C (\rho''/2)^{-|\beta|}$ . Now, let us rewrite the relations (3.30) in a more explicit form, taking into account that  $\Theta'(0, t') = \Theta'_0(t')$  by definition :

$$(3.32) \quad \begin{cases} \Theta''_\beta(\Lambda(t')) + \sum_{\gamma \in \mathbb{N}_*^{n-1}} (\bar{\Phi}(0, \Theta'_0(t'))^\gamma \frac{(\beta + \gamma)!}{\beta! \gamma!} \Theta''_{\beta+\gamma}(\Lambda(t')) \equiv \\ \equiv S_\beta(\{\Theta'_\delta(t')\}_{|\delta| \leq |\beta|}) =: s_\beta(t'), \end{cases}$$

where we denote  $\mathbb{N}_*^{n-1} := \mathbb{N}^{n-1} \setminus \{0\}$ . This collection of equalities may be considered as an infinite upper triangular linear system with unknowns being the functions  $\Theta''_\beta(\Lambda(t'))$ . This system can be readily inverted. Indeed, using Taylor's formula in the convergent case or proceeding directly at the formal level, it is easy to see that if we are given an infinite collection of equalities with complex coefficients and with  $\zeta \in \mathbb{N}^{n-1}$  which is of the form

$$(3.33) \quad \Theta''_\beta + \sum_{\gamma \in \mathbb{N}_*^{n-1}} \zeta^\gamma \frac{(\beta + \gamma)!}{\beta! \gamma!} \Theta''_{\beta+\gamma} = S_\beta,$$

for all multi-indices  $\beta \in \mathbb{N}^{n-1}$ , then we can solve the unknowns  $\Theta''_\beta$  in terms of the right hand side terms  $S_\beta$  by means of a totally similar formula, except for signs :

$$(3.34) \quad S_\beta + \sum_{\gamma \in \mathbb{N}_*^{n-1}} \zeta^\gamma (-1)^\gamma \frac{(\beta + \gamma)!}{\beta! \gamma!} S_{\beta+\gamma} = \Theta''_\beta,$$

for all  $\beta \in \mathbb{N}^{n-1}$ . Applying this observation to (3.32) and using the above Cauchy estimates on  $s_\beta(t')$ , we deduce the convergent representation

$$(3.35) \quad \begin{cases} \Theta''_\beta(\Lambda(t')) \equiv S_\beta(\{\Theta'_\delta(t')\}_{|\delta| \leq |\beta|}) + \\ + \sum_{\gamma \in \mathbb{N}_*^{n-1}} (\bar{\Phi}(0, \Theta'_0(t'))^\gamma (-1)^\gamma \frac{(\beta + \gamma)!}{\beta! \gamma!} S_{\beta+\gamma}(\{\Theta'_\delta(t')\}_{|\delta| \leq |\beta| + |\gamma|}), \end{cases}$$

which is valuable for  $|t'| < \rho'$ . Here, we recall that the functions  $S_\beta$  only depend on the bi-holomorphism  $\Lambda$  and that they are holomorphic with respect to their arguments. Now, we

can prove that **(i)** implies **(ii)** in Lemma 3.22. By the equivalence between **(i)** and **(ii)** of Lemma 3.16, it suffices to show that all component functions  $\Theta''_{\beta}(\Lambda(h(t)))$  extend holomorphically to a neighborhood of the origin provided all component functions  $\Theta'_{\beta}(h(t))$  extend holomorphically (by construction, the Cauchy estimates are already at hand). But this is evident by reading (3.35) after replacing  $t'$  by  $h(t)$ . This completes the proof of Lemma 3.22.  $\square$

**3.36. Translation of the center point.** We have shown that the holomorphic extendability of the reflection function  $\mathcal{R}'_h$  centered at *one* point  $p \times \overline{h(p)}$  is an invariant property. On the other hand, suppose that  $\mathcal{R}'_h$  is holomorphic in the product polydisc  $\Delta_n(0, \sigma) \times \Delta_n(0, \sigma')$ , for  $0 < \sigma < \rho$  and  $0 < \sigma' < \rho'$ . Does it follow that the reflection functions centered at points  $q \times \overline{h(q)} \in \Delta_n(0, \sigma) \times \Delta_n(0, \sigma')$  also extends holomorphically at these points? Without loss of generality, we can assume that  $h(M \cap \Delta_n(0, \rho)) \subset \Delta_n(0, \rho')$  and that  $h(M \cap \Delta_n(0, \sigma)) \subset \Delta_n(0, \sigma')$ . Let  $q \in \Delta_n(0, \sigma)$  be an arbitrary point and set  $q' := h(q)$ . Recall that as in §3.1 above, we are given coordinates  $t$  and  $t'$  centered at the origin in which the equations of  $M$  and of  $M'$  are of the form  $\bar{w} = \Theta(\bar{z}, t)$  and  $\bar{w}' = \Theta'(\bar{z}', t')$ , with  $\Theta$  converging normally in the polydisc  $\Delta_{2n-1}(0, \rho)$  and similarly for  $\Theta'$ . We can center new holomorphic coordinates at  $q$  and at  $q'$  simply by setting  $t_* := t - q$  and  $t'_* := t' - q'$ . We shall denote  $|q| =: \varepsilon$  and  $|q'| =: \varepsilon'$ . Let  $M_* := M - q$  and  $M'_* := M' - q'$  be the two new hypersurfaces obtained by such geometric translations. In the new coordinates, we naturally have two new defining equations  $w_* = \Theta_*(\bar{z}_*, t_*)$  and  $\bar{w}'_* = \Theta'_*(\bar{z}'_*, t'_*)$  for  $M_*$  and for  $M'_*$  with  $\Theta_*$  converging (at least) in  $\Delta_{2n-1}(0, \rho - \varepsilon)$  and with  $\Theta'_*$  converging (at least) in  $\Delta_{2n-1}(0, \rho' - \varepsilon')$ . The explicit expression of  $\Theta'_*$  will be computed in a while. Let  $h_*(t_*) := h(q + t_*)$ . Let  $\bar{v}'_* := (\bar{\lambda}'_*, \bar{\mu}'_*) := \bar{v}' - \bar{q}'$ . Define the transformed reflection function  $\mathcal{R}'_{*h_*}(t_*, \bar{v}'_*)$  accordingly.

**Lemma 3.37.** *If  $\varepsilon < \sigma$  and  $\varepsilon' < \sigma'$ , then the reflection function  $\mathcal{R}'_{*h_*}(t_*, \bar{v}'_*) := \bar{\mu}'_* - \Theta'_*(\bar{\lambda}'_*, h_*(t_*))$  extends holomorphically to the polydisc  $\Delta_n(0, \sigma - \varepsilon) \times \Delta_n(0, \sigma' - \varepsilon')$ .*

*Démonstration.* At first, we compute the defining equation of  $M'_*$ . To obtain the explicit expression of  $\Theta'_*$ , it suffices to transform the equation

$$(3.38) \quad \bar{w}' - \bar{w}_{q'} = \Theta'(\bar{z}', t') - \Theta'(\bar{z}'_{q'}, t'_{q'}) = \sum_{\beta \in \mathbb{N}^{n-1}} (\bar{z}')^{\beta} \Theta'_{\beta}(t') - \sum_{\beta \in \mathbb{N}^{n-1}} (\bar{z}'_{q'})^{\beta} \Theta'_{\beta}(t'_{q'})$$

in the form

$$(3.39) \quad \bar{w}'_* = \Theta'_*(\bar{z}'_*, t'_*) = \sum_{\beta \in \mathbb{N}^{n-1}} (\bar{z}'_*)^{\beta} \Theta'_{*\beta}(t'_*).$$

Differentiating with respect to  $\bar{z}'$  and setting  $\bar{z}' := \bar{z}'_{q'}$ , we obtain

$$(3.40) \quad \begin{cases} \Theta'_{*0}(t'_*) := \sum_{\gamma \in \mathbb{N}^{n-1}} (\bar{z}'_{q'})^{\gamma} \Theta'_{\gamma}(q' + t'_*) - \sum_{\gamma \in \mathbb{N}^{n-1}} (\bar{z}'_{q'})^{\gamma} \Theta'_{\gamma}(q'), \\ \Theta'_{*\beta}(t'_*) := \Theta'_{\beta}(q' + t'_*) + \sum_{\gamma \in \mathbb{N}^{n-1}} (\bar{z}'_{q'})^{\gamma} \Theta'_{\beta+\gamma}(q' + t'_*) \frac{(\beta + \gamma)!}{\beta! \gamma!}, \end{cases}$$

for all  $\beta \in \mathbb{N}_*^{n-1}$ . Now, suppose that the reflection function  $\mathcal{R}'_h(t, \bar{v}')$  in the old system of coordinates extends holomorphically to the product polydisc  $\Delta_n(0, \sigma) \times \Delta_n(0, \sigma')$  as a function that we shall denote by

$$(3.41) \quad R'(t, \bar{v}') := \bar{\mu}' - \sum_{\beta \in \mathbb{N}^{n-1}} (\bar{\lambda}')^{\beta} \theta'_{\beta}(t).$$

By Lemma 3.16, the functions  $\theta'_{\beta}(t)$  are holomorphic in  $\Delta_n(0, \sigma)$  and they extend holomorphically the  $\mathcal{C}^{\infty}$ -smooth CR functions  $\Theta'_{\beta}(h(t))$  defined on  $M \cap \Delta_n(0, \rho)$ . Immediately,  $R'$  is holomorphic in an obvious product polydisc centered at  $q \times \bar{q}'$ , namely in  $\Delta_n(q, \sigma - \varepsilon) \times \Delta_n(\bar{q}', \sigma' - \varepsilon')$ . Let  $t_* := t - q$  and  $\bar{v}'_* := \bar{v}' - \bar{q}'$ . The unique function  $R'_*(t_*, \bar{v}'_*)$  satisfying

$$(3.42) \quad R'(t, \bar{v}') = R'_*(t_*, \bar{v}'_*) = \bar{\mu}'_* - \sum_{\beta \in \mathbb{N}^{n-1}} (\bar{\lambda}'_*)^{\beta} \theta'_{*\beta}(t_*)$$

possesses coefficients necessarily given by

$$(3.43) \quad \begin{cases} \theta'_{*0}(t_*) := \sum_{\gamma \in \mathbb{N}^{n-1}} (\bar{z}'_{q'})^\gamma \theta'_\gamma(q + t_*) - \sum_{\gamma \in \mathbb{N}^{n-1}} (\bar{z}'_{q'})^\gamma \theta'_\gamma(q), \\ \theta'_{*\beta}(t_*) := \theta'_\beta(q + t_*) + \sum_{\gamma \in \mathbb{N}^{n-1}} (\bar{z}'_{q'})^\gamma \theta'_{\beta+\gamma}(q + t_*) \frac{(\beta + \gamma)!}{\beta! \gamma!}, \end{cases}$$

for all  $\beta \in \mathbb{N}_*^{n-1}$ . In the new coordinate system, the reflection function centered at  $q \times \overline{h(q)}$  can be defined as

$$(3.44) \quad \mathcal{R}'_{*h_*}(t_*, \bar{v}'_*) := \bar{\mu}'_* - \sum_{\beta \in \mathbb{N}^{n-1}} (\bar{\lambda}'_*)^\beta \Theta'_{*\beta}(h_*(t_*)),$$

for  $t_* \in M_*$  with  $|t_*| < \sigma - \varepsilon$ . Substituting  $t'_*$  by  $h_*(t_*)$  in the equations (3.40) and using afterwards that the  $\theta'_\beta(t)$  extend the  $\Theta'_\beta(h(t))$ , we deduce that the functions

$$(3.45) \quad \begin{cases} \Theta'_{*0}(h_*(t_*)) = \sum_{\gamma \in \mathbb{N}^{n-1}} (\bar{z}'_{q'})^\gamma \Theta'_\gamma(h(q + t_*)) - \sum_{\gamma \in \mathbb{N}^{n-1}} (\bar{z}'_{q'})^\gamma \Theta'_\gamma(q'), \\ \Theta'_{*\beta}(h_*(t_*)) = \Theta'_\beta(h(q + t_*)) + \sum_{\gamma \in \mathbb{N}_*^{n-1}} (\bar{z}'_{q'})^\gamma \frac{(\beta + \gamma)!}{\beta! \gamma!} \Theta'_{\beta+\gamma}(h(q + t_*)) \end{cases}$$

extend holomorphically to the polydisc  $\Delta_n(0, \sigma - \varepsilon)$  as functions of  $t_*$  given by the right hand sides of (3.43). The convergence of these series follows from the Cauchy estimates on the  $\theta'_\beta(t)$ . This completes the proof of Lemma 3.37.  $\square$

**3.46. Delocalization and propagation.** At this stage, we can summarize what the term “reflection function” really means. Let  $h : M \rightarrow M'$  be a (not necessarily local)  $\mathcal{C}^\infty$ -smooth CR mapping between two connected real analytic CR manifolds. For any product of points  $p \times \overline{h(p)}$  lying in the graph of  $\bar{h}$  in  $M \times \overline{M'}$  and for any system of coordinates  $t'$  vanishing at  $p' := h(p)$  in which the complex defining equation of  $M'$  is an uniquely defined *graph* of the form  $\bar{w}' = \Theta'(\bar{z}', t')$ , we define the associated reflection function *centered* at  $p \times \overline{p'}$  by  $\mathcal{R}_h(t, \bar{v}') := \bar{\mu}' - \Theta'(\bar{\lambda}', h(t))$ . If it exists, its holomorphic extension at  $p \times \overline{p'}$  is unique, thanks to the uniqueness principle on the boundary ([P1]). Also, its holomorphic extension does not depend on the system of coordinates  $t'$  vanishing at  $p'$ . And finally, its holomorphic extension propagates at nearby points. Although for some real analytic hypersurface  $M'$  there does not exist a *global* defining equation of the form  $\bar{w}' = \Theta'(\bar{z}', t')$ , we believe that the transformation rules explained in Lemmas 3.22 and 3.37 justify that we speak of “the” reflection function.

The two analytic relations (3.35) and (3.40) are extremely important. In §3.47 just below, we shall see that they permit to establish that certain CR geometric concepts defined in terms of the collection  $(\Theta'_\beta(t'))_{\beta \in \mathbb{N}^{n-1}}$  are biholomorphically invariant.

**3.47. The exceptional locus of  $M'$ .** As above, let  $p' \in M'$  and assume that the defining equation of  $M'$  converges normally in the polydisc  $\Delta_{2n-1}(0, \rho')$ . Let us consider the infinite Jacobian matrix of the infinite holomorphic mapping  $\mathcal{Q}'_\infty(t') = (\Theta'_\beta(t'))_{\beta \in \mathbb{N}^{n-1}}$  introduced in §1.10 :

$$(3.48) \quad \mathcal{J}_\infty(t') := (\partial \Theta'_\beta(t') / \partial t'_j)_{\beta \in \mathbb{N}^{n-1}, 1 \leq j \leq n}.$$

Concretely, by ordering the multi-indices  $\beta$ , we may think of  $\mathcal{J}_\infty(t')$  as a horizontally infinite  $\infty \times n$  complex matrix. Also, it is convenient to truncate this matrix by limiting the multi-indices to run over  $|\beta| \leq k$ . Let us denote such finite matrices by

$$(3.49) \quad \mathcal{J}_k(t') := (\partial \Theta'_\beta(t') / \partial t'_j)_{|\beta| \leq k, 1 \leq j \leq n}.$$

As a holomorphic mapping of  $t'$ , the generic rank of  $\mathcal{J}_k(t')$  increases with  $k$ . Let  $\chi'_{M'}$  denote the maximal generic rank of these finite matrices. Equivalently, there exists a minor of size  $\chi'_{M'}$  of the matrix  $\mathcal{J}_\infty$  which does not vanish identically as a holomorphic function of  $t'$ , but all minors of size  $(\chi'_{M'} + 1)$  of  $\mathcal{J}_\infty(t')$  do vanish identically. We call this integer the *generic*

rank of the infinite matrix  $\mathcal{J}_\infty(t')$ . Of course,  $\chi'_{M'}$  is at least equal to 1, because the term  $\Theta'_0(t')$  does not vanish identically and is nonconstant (see §3.1). So we have  $1 \leq \chi'_{M'} \leq n$ . Apparently, the integer  $\chi'_{M'}$  seems to depend on  $p'$  and on the choice of coordinates centered at  $p'$ , but in fact it is a biholomorphic invariant of the hypersurface  $M'$  itself, which explains in advance the notation. Recall that  $M'$  is connected, which is important. We shall check this invariance in two steps.

**Lemma 3.50.** *Let  $p' \in M'$ , let  $t'$  be a system of coordinates vanishing at  $p'$  and let  $t''$  be another system of coordinates vanishing at  $p'$  defined by  $t'' = \Lambda(t')$  as in Lemma 3.22. Then the two generic ranks of the associated infinite Jacobian matrices are identical.*

*Démonstration.* Looking at the family of relations (3.35) and applying the rank inequality for composed holomorphic mappings, we see that the generic rank of  $\mathcal{J}_\infty(t'')$  is certainly less than or equal to the generic rank of  $\mathcal{J}_\infty(t')$ . As the mapping  $\Lambda$  is invertible, a relation similar to (3.35) holds if we reverse the rôles of  $t'$  and  $t''$ , and we get the opposite inequality between generic ranks.  $\square$

**Lemma 3.51.** *Let  $p' \in M'$ , let  $q' \in M'$  be close to  $p'$  as Lemma 3.37 and consider the infinite Jacobian matrix  $\mathcal{J}_\infty(t'_*)$  associated with the functions  $\Theta'_{*\beta}(t'_*)$  defined by (3.40). Then the generic ranks of  $\mathcal{J}_\infty(t')$  and of  $\mathcal{J}_\infty(t'_*)$  coincide.*

*Démonstration.* This is immediate, because the relation (3.40) between the two collections  $(\Theta'_{*\beta}(t'_*))_{\beta \in \mathbb{N}^{n-1}}$  and  $(\Theta'_\beta(t'))_{\beta \in \mathbb{N}^{n-1}}$  is linear, upper triangular and invertible.  $\square$

So we may prove that  $\chi'_{M'}$  is a global biholomorphic invariant of the connected hypersurface  $M'$ . Indeed, any two points  $p'_1 \in M'$  and  $p'_2 \in M'$  can be connected by a finite chain of intermediate points which are contained in pairs of overlapping coordinate system for which Lemmas 3.50 and 3.51 apply directly.

Here is an interesting and useful application. Locally in a neighborhood of an arbitrary point  $p' \in M'$ , we may define a *proper complex analytic* subset of  $\Delta_n(0, \rho')$  denoted by  $\mathcal{E}'$  which is obtained as the vanishing locus of all the minors of size  $\chi'_{M'}$  of  $\mathcal{J}_\infty(t')$ . As in the proofs of Lemmas 3.50 and 3.51, by looking more closely at the two families of infinite relations (3.35) and (3.40), we observe that the set of points  $t'$  close to  $p'$  at which the rank of  $\mathcal{J}_\infty(t')$  is maximal equal to  $\chi'_{M'}$  is independent of coordinates. Consequently, the complex analytic set  $\mathcal{E}'$ , which we shall call the *extrinsic exceptional locus of  $M'$* , is an invariant complex analytic subset defined in a neighborhood of  $M'$  in  $\mathbb{C}^n$ . Moreover,  $\mathcal{E}'$  is *proper* (i.e. of dimension  $\leq n - 1$ ), because  $\chi'_{M'} \geq 1$ , so there is at least one not identically zero minor in the definition of  $\mathcal{E}'$ . The *intrinsic exceptional locus of  $M'$*  denoted by  $E'_{M'}$  is defined to be the intersection of  $\mathcal{E}'$  with  $M'$ . This is also a *proper* real analytic subset of  $M'$  (maybe empty).

**Lemma 3.52.** *If  $M'$  is globally minimal, then the real dimension of  $E'_{M'}$  is less than or equal to  $(2n - 3)$ .*

*Démonstration.* Suppose on the contrary that there exists a stratum  $S$  of real dimension  $(2n - 2)$ . This stratum cannot be generic at any point, because otherwise  $\mathcal{E}'$  which contains  $S$  would be of complex dimension  $n$ . So  $S$  is a complex hypersurface contained in  $M'$ , contradicting local minimality at every point.  $\square$

This dimension estimate should be compared to that of the Levi degeneracy locus : unless  $M'$  is everywhere Levi degenerate, the set of points at which  $M'$  is Levi degenerate is a proper real analytic subvariety, but in general of dimension less than or equal to  $(2n - 2)$ , with this bound attained. This is so because the Levi degeneracy locus is *not* contained in a complex analytic subset of a neighborhood of  $M'$ . The fact that the real codimension of  $E'_{M'}$  is at least two will be crucial for the proof of Theorems 9.2 and 9.3 below.

**3.53. Local product structure at a Zariski-generic point.** In the beginning of §4 below we shall need the following geometric straightening statement.

**Lemma 3.54.** *In a small neighborhood of an arbitrary point  $q' \in M' \setminus E'_{M'}$ , the hypersurface  $M'$  is biholomorphic to a product  $\underline{M}'_{q'} \times \Delta^{n-\chi'_{M'}}$  by a polydisc of dimension  $(n - \chi'_{M'})$ , where  $\underline{M}'_{q'}$  is a real analytic hypersurface in  $\mathbb{C}^{\chi'_{M'}}$ . Furthermore, at the point  $\underline{q}'$ , the rank of an associated infinite matrix  $\underline{\mathcal{J}}_{\infty}(\underline{t}')$ , where  $\underline{t}' \in \mathbb{C}^{\chi'_{M'}}$  are holomorphic coordinates vanishing at  $\underline{q}'$ , is maximal equal to  $\chi'_{M'}$ .*

*Démonstration.* Choose coordinates  $t'$  vanishing at  $q'$ . By assumption, the mapping  $t' \mapsto (\Theta'_{\beta}(t'))_{|\beta| \leq k}$  is of constant rank  $\chi'_{M'}$  for all  $t'$  near the origin and for all  $k$  large enough. By the rank theorem, it follows that the union of level sets  $\mathcal{F}_{r'} := \{t' : \Theta'_{\beta}(t') = \Theta'_{\beta}(r'), \forall \beta \in \mathbb{N}^{n-1}\}$  for  $r'$  running in a neighborhood of  $q'$  do constitute a local holomorphic foliation by complex leaves of dimension  $n - \chi'_{M'}$ . We can straighten this foliation in a neighborhood of  $q'$  so that (after an eventual dilatation)  $\mathbb{C}^n$  decomposes as the product  $\Delta^{\chi'_{M'}} \times \Delta^{n-\chi'_{M'}}$ , where the second term corresponds to the leaves of this foliation. In these new straightening coordinates, which we will denote by  $t''$ , we claim that the leaves of this foliation are again defined by the level sets of the functions  $\Theta''_{\beta}(t'')$ , namely  $\mathcal{F}_{r''} := \{t'' : \Theta''_{\beta}(t'') = \Theta''_{\beta}(r''), \forall \beta \in \mathbb{N}^{n-1}\}$ . This is so, thanks to the important relations (3.35). For simplicity, let us denote these coordinates again by  $t'$  instead of  $t''$ . We claim that if the point  $r'$  belongs to  $M'$ , then its leaf  $\mathcal{F}_{r'}$  is entirely contained in  $M'$  in a neighborhood of  $q'$ . Indeed, let  $s' \in \mathcal{F}_{r'}$ , so we have  $\Theta'_{\beta}(s') = \Theta'_{\beta}(r')$  for all  $\beta \in \mathbb{N}^{n-1}$  by definition. It follows first that

$$(3.55) \quad 0 = \bar{w}'_{r'} - \Theta'(\bar{z}'_{r'}, t'_{r'}) = \bar{w}'_{r'} - \Theta'(\bar{z}'_{r'}, t'_{s'}).$$

Next, thanks to the reality of  $M'$ , there exists a nonzero holomorphic function  $a'(t', \tau')$ , where  $\tau' = (\zeta', \xi') \in \mathbb{C}^{n-1} \times \mathbb{C}$ , such that

$$(3.56) \quad \xi' - \Theta'(\zeta', t') \equiv a'(t', \tau') \left[ w' - \bar{\Theta}'(z', \tau') \right],$$

for all  $t', \tau'$  running in a neighborhood of the origin. Using crucially this identity, we can transform (3.55) as follows

$$(3.57) \quad 0 = w'_{s'} - \bar{\Theta}'(z'_{s'}, \bar{t}'_{r'}).$$

Now, conjugating this new identity, we get  $\bar{w}'_{s'} - \Theta'(\bar{z}'_{s'}, t'_{r'}) = 0$  and finally, using a second time  $\Theta'_{\beta}(s') = \Theta'_{\beta}(r')$  for all  $\beta \in \mathbb{N}^{n-1}$ , we obtain

$$(3.58) \quad \bar{w}'_{s'} - \Theta'(\bar{z}'_{s'}, t'_{s'}) = 0,$$

which shows that  $s' \in M'$ , as claimed. In summary, in the straightened coordinates  $(\underline{t}', \tilde{t}') \in \mathbb{C}^{\chi'_{M'}} \times \mathbb{C}^{n-\chi'_{M'}}$ , those leaves  $\{\tilde{t}' = ct.\}$  intersecting  $M'$  are entirely contained in  $M'$ . It follows that there exists a defining equation for  $M'$  in a neighborhood of the origin which is of the form

$$(3.59) \quad \bar{w}' = \underline{\Theta}'(\bar{z}', \underline{t}'),$$

namely it is independent of the coordinates  $\tilde{t}'$ . We define  $\underline{M}'_{q'}$  to be the hypersurface of  $\mathbb{C}^{\chi'_{M'}}$  defined by the equation (3.59). The infinite Jacobian matrix  $\underline{\mathcal{J}}_{\infty}(t')$  of  $M'$  therefore coincides with the infinite Jacobian matrix of  $\underline{M}'_{q'}$ . By assumption,  $\underline{\mathcal{J}}_{\infty}(t')$  is of rank  $\chi'_{M'}$  at the origin (this means that all finite submatrices  $\underline{\mathcal{J}}_k(t')$  are of rank  $\chi'_{M'}$  for all large enough  $k$ ). So the rank at the origin of  $\underline{\mathcal{J}}_{\infty}(t')$  is also equal to  $\chi'_{M'}$ . The proof of Lemma 3.54 is complete.  $\square$

**3.60. Pointwise nondegeneracy conditions on  $M'$ .** We shall call the (always connected) hypersurface  $M'$  *holomorphically nondegenerate* if  $\chi'_{M'} = n$ . By examining the proof of Lemma 3.54, one can see that this definition coincides with the original definition of Stanton [St1,2] in terms of tangent holomorphic vector fields (*cf.* also [Me5,§9]). By §3.47 above, holomorphic nondegeneracy is a global property of  $M'$ . Furthermore, we shall say that  $M'$  is *finitely nondegenerate* at the point  $p'$  if for one (hence for all) system(s) of coordinates vanishing at  $p'$ , the rank of  $\underline{\mathcal{J}}_{\infty}(t')$  is equal to  $n$  at the origin. By the above definitions, a connected real analytic hypersurface  $M'$  is holomorphically nondegenerate if and only if there exists a proper complex analytic subset of a neighborhood of  $M'$  in  $\mathbb{C}^n$ , namely the

extrinsic exceptional locus  $\mathcal{E}'$ , such that  $M'$  is finitely nondegenerate at every point of  $M'$  not belonging to  $\mathcal{E}'$ . Also, Lemma 3.54 above may be interpreted as a sort of geometric quotient procedure : locally in a neighborhood of a Zariski-generic point  $q' \in M'$ , i.e. for  $q' \notin E'_{M'}$ , after dropping the innocuous polydisc  $\Delta^{n-\chi'_{M'}}$ , we are left with a finitely nondegenerate real analytic hypersurface  $\underline{M}'_{q'}$  in a smaller complex affine space. Finally, we shall say that  $M'$  is *essentially finite* at the point  $p'$  if for one (hence for all) system(s) of coordinates vanishing at  $p'$ , the local holomorphic mappings  $t' \mapsto (\Theta'_\beta(t'))_{|\beta| \leq k}$  are finite-to-one in a neighborhood of the origin for all  $k$  large enough. It can be checked that this definition coincides with the one introduced in [DW] and subsequently studied by many authors. We shall consider essentially finite hypersurfaces in §9 below.

**3.61. Conclusion.** All the considerations of this paragraph support well the thesis that *the collection of holomorphic functions  $(\Theta'_\beta(t'))_{\beta \in \mathbb{N}^{n-1}}$  is the most important analytic object attached to a real analytic hypersurface  $M'$  localized at one of its points.*

#### §4. EXTENSION ACROSS A ZARISKI DENSE OPEN SUBSET OF $M$

**4.1. Holomorphic extension at a Zariski-generic point.** Let  $h : M \rightarrow M'$  be a  $\mathcal{C}^\infty$ -smooth CR diffeomorphism between two connected real analytic hypersurfaces in  $\mathbb{C}^n$ .

**Lemma 4.2.** *If  $M$  is globally minimal, then  $M'$  is also globally minimal.*

*Démonstration.* Indeed, as  $h$  is CR, it sends every  $\mathcal{C}^\infty$ -smooth curve  $\gamma$  of  $M$  running into complex tangential directions diffeomorphically onto a curve  $\gamma' := h(\gamma)$  also running in complex tangential directions. Then Lemma 4.2 is a direct consequence of the definition of CR orbits. We do not enter the details.  $\square$

The starting point of the proof of Theorem 1.9 is to show that the various reflection functions already extend holomorphically to a neighborhood of  $q \times \overline{h(q)}$  for all points  $q$  running in the Zariski open subset  $M \setminus E_M$  of  $M$ , where  $E_M$  is the intrinsic exceptional locus of  $M$  defined in the end of §3.47 above. It is convenient to observe first that  $h$  maps  $E_M$  bijectively onto  $E'_{M'}$ .

**Lemma 4.3.** *A point  $q \in M$  belongs to  $M \setminus E_M$  if and only if its image  $h(q)$  belongs to  $M' \setminus E'_{M'}$ . Furthermore,  $\chi_M = \chi'_{M'}$ .*

*Démonstration.* Let  $q \in M$  be arbitrary, let  $t$  be coordinates vanishing at  $q$  and let  $t'$  be coordinates vanishing at  $q' := h(q)$  in which we have

$$(4.4) \quad \overline{g(\bar{t})} - \Theta'(\overline{f(\bar{t})}, h(t)) = a(t, \bar{t}) [\bar{w} - \Theta(\bar{z}, t)],$$

for all  $t \in M$  close to the origin and for some nonvanishing function  $a(t, \bar{t})$  of class  $\mathcal{C}^\infty$ . By developping the Taylor series of all  $\mathcal{C}^\infty$ -smooth functions in (4.4) and by polarizing, we see that the Taylor series  $H$  of  $h$  at the origin induces a formal mapping between  $(M, q)$  and  $(M', q')$ , namely there exists a formal power series  $A(t, \tau)$  with nonzero constant term such that the following identity holds between formal power series in the  $2n$  variables  $(t, \tau)$  :

$$(4.5) \quad \overline{G(\tau)} - \Theta'(\overline{F(\tau)}, H(t)) \equiv A(t, \tau) [\xi - \Theta(\zeta, t)].$$

Now, the computations of Lemma 3.22 can be performed at a purely formal level, replacing the mapping  $\Lambda$  there by the formal mapping  $H$ . We obtain a relation similar to (3.35), interpreted at the formal level, with  $\Lambda$  replaced by  $H$ . Using the invertibility of  $H$  to get a second relation like (3.35) with  $\Lambda$  replaced by  $H^{-1}$ , it then follows that the rank of the mapping  $t \mapsto (\Theta_\beta(t))_{\beta \in \mathbb{N}^{n-1}}$  at  $q$  is the same as the rank of the mapping  $t' \mapsto (\Theta'_\beta(t'))_{\beta \in \mathbb{N}^{n-1}}$  at  $h(q)$ . This property yields the desired conclusion.  $\square$

Thus, the starting point of the proof of Theorem 1.9 is the following Zariski dense holomorphic extension result.

**Lemma 4.6.** *If  $h : M \rightarrow M'$  is a  $C^\infty$ -smooth CR diffeomorphism between two globally minimal real analytic hypersurfaces in  $\mathbb{C}^n$ , then for every point  $q \in M \setminus E_M$  lying outside the intrinsic exceptional locus of  $M$  and for every choice of a coordinate system vanishing at  $q' := h(q)$  in which  $(M', q')$  is represented by  $\bar{w}' = \Theta'(\bar{z}', t')$ , the associated reflection function  $\mathcal{R}'_h(t, \bar{v}') = \bar{\mu}' - \Theta'(\bar{\lambda}', h(t))$  extends holomorphically to a neighborhood of  $q \times \bar{q}'$  in  $\mathbb{C}^n \times \mathbb{C}^n$ .*

*Démonstration.* First, by Lemma 4.3, we already know that  $q'$  does not belong to  $E'_{M'}$  and that  $\chi_M = \chi'_{M'}$ . For short, let us denote this integer by  $\chi$ . By Lemma 3.22, the holomorphic extendability of the reflection function is invariant, so let us choose adapted convenient coordinates. Using Lemma 3.54, we can find coordinates near  $q' \in M'$  of the form  $t' = (z', v', w') \in \mathbb{C}^{\chi-1} \times \mathbb{C}^{n-\chi} \times \mathbb{C}^1$  in which the equation of  $M'$  near the origin is given by  $\bar{w}' = \Theta'(\bar{z}', z', w')$ . Notice that the  $(v', \bar{v}')$  coordinates do not appear in the defining equation, because of the product structure. We do the same straightening near  $q \in M$ , so that we can split the coordinates as  $t = (z, v, w) \in \mathbb{C}^{\chi-1} \times \mathbb{C}^{n-\chi} \times \mathbb{C}^1$  in which the equation of  $M$  near the origin is also given in the form  $\bar{w} = \Theta(\bar{z}, z, w)$ . Finally, we split the mapping accordingly as  $h = (f, l, g) \in \mathbb{C}^{\chi-1} \times \mathbb{C}^{n-\chi} \times \mathbb{C}^1$ . It is important to notice that in these coordinates, the reflection function  $\mathcal{R}'_h(t, \bar{\lambda}', \bar{v}', \bar{v}') = \bar{\mu}' - \Theta'(\bar{\lambda}', f(t), g(t))$ , where  $(\bar{\lambda}', \bar{v}', \bar{v}') \in \mathbb{C}^{\chi-1} \times \mathbb{C}^{n-\chi} \times \mathbb{C}^1$ , neither depends on the  $(n - \chi)$  middle components  $(l_1, \dots, l_{n-\chi}) = (h_\chi, \dots, h_{n-1})$  of  $h$  nor on  $\bar{v}'$ . Clearly, to show that this reflection function extends holomorphically at  $q \times \bar{q}'$ , it would suffice to show that the  $\chi$  components  $(f_1, \dots, f_{\chi-1}, g) = (h_1, \dots, h_{\chi-1}, h_n)$  of  $h$  extend holomorphically to a neighborhood of the origin. We need some notation. Let  $\underline{h}$  denote these  $\chi$  special components  $(f, g)$ , let  $\underline{M}$  denote the hypersurface  $\bar{w} = \Theta(\bar{z}, z, w)$  of  $\mathbb{C}^X$  and similarly let  $\underline{M}'$  denote the hypersurface  $\bar{w}' = \Theta'(\bar{z}', z', w')$  of  $\mathbb{C}^X$ . *A priori*, it is not clear whether  $\underline{h}$  induces a  $C^\infty$ -smooth CR mapping between  $(\underline{M}, \underline{q})$  and  $(\underline{M}', \underline{q}')$ , since  $\underline{h}$  might well depend on the variables  $(v_1, \dots, v_{n-\chi})$ .

**Lemma 4.7.** *The  $\chi$  components  $(f_1, \dots, f_{\chi-1}, g)$  of  $h$  are independent of the  $(n - \chi)$  coordinates  $v$ . Consequently, the mapping  $h$  induces a well defined CR mapping  $\underline{h} : (\underline{M}, \underline{q}) \rightarrow (\underline{M}', \underline{q}')$  of class  $C^\infty$ .*

*Démonstration.* Let  $\bar{L}_1, \dots, \bar{L}_{n-1}$  be a commuting basis of  $T^{0,1}M$  with real analytic coefficients, for instance  $\bar{L}_j = \frac{\partial}{\partial \bar{z}_j} + \Theta_{\bar{z}_j}(\bar{z}, z, w) \frac{\partial}{\partial \bar{w}}$  for  $j = 1, \dots, \chi - 1$  and also  $\bar{L}_i = \frac{\partial}{\partial \bar{v}_i}$ , for  $i = 1, \dots, n - \chi$ . Notice that the  $(1, 0)$  vector field  $L_i$ ,  $i = 1, \dots, n - \chi$  commute with the  $(0, 1)$  vector fields  $\bar{L}_j$ ,  $j = 1, \dots, \chi - 1$ . Since  $h$  is a  $C^\infty$ -smooth CR diffeomorphism, after a possible linear change of coordinates, we can assume that the determinant  $\mathcal{D}(t, \bar{t}) := \det(\bar{L}_j \bar{f}_k(\bar{t}))_{1 \leq j, k \leq \chi-1}$  is nonzero at the origin. Applying the derivations  $\bar{L}_1, \dots, \bar{L}_{\chi-1}$  to the fundamental identity  $\overline{g(t)} = \Theta'(\overline{f(t)}, \underline{h}(t))$  for  $t$  on  $(M, q)$ , we get first

$$(4.8) \quad \overline{L_j g(t)} = \sum_{k=1}^{\chi-1} \overline{L_j f_k(t)} \frac{\partial \Theta'}{\partial \bar{z}'_k}(\overline{f(t)}, \underline{h}(t)).$$

Shrinking  $\sigma > 0$  if necessary, we can assume that the determinant  $\mathcal{D}(t, \bar{t})$  does not vanish for all  $|t| < \sigma$ . By Cramer's rule, we can solve in (4.8) the first order partial derivatives  $\partial_{\bar{z}'_k} \Theta'$  with respect to the other terms. As in the proof of Lemma 3.22, by induction, it follows that for every multi-index  $\beta \in \mathbb{N}^{\chi-1}$ , there exists a certain universal polynomial  $R_\beta$  such that the following relation holds for all  $t \in M$  with  $|t| < \sigma$  :

$$(4.9) \quad \frac{1}{\beta!} \frac{\partial^{|\beta|} \Theta'}{\partial (\bar{z}')^\beta}(\overline{f(t)}, \underline{h}(t)) = \frac{R_\beta(\{\overline{L}^\gamma \overline{h(t)}\}_{|\gamma| \leq |\beta|})}{[\mathcal{D}(t, \bar{t})]^{2|\beta|-1}}.$$

Next, since by assumption the point  $q'$  does not belong to  $E'_{M'}$ , the second sentence of Lemma 3.54 tells us that there exists a positive integer  $k$  such that the rank of the mapping  $\mathbb{C}^X \ni (z', w') \mapsto (\Theta'_\beta(z', w'))_{|\beta| \leq k}$  is maximal equal to  $\chi = \chi'_{M'}$ . Writing the equalities (4.9) only for  $|\beta| \leq k$  and applying the implicit function theorem, it follows finally that we can solve  $\underline{h}(t)$  with respect to the derivatives of  $\overline{h(t)}$ , namely there exist  $\chi$  holomorphic functions  $\Omega_j$  in

their variables such that for  $j = 1, \dots, \chi$  and  $t \in M$  with  $|t| < \sigma$  (shrinking  $\sigma$  if necessary), we have :

$$(4.10) \quad \underline{h}_j(t) = \Omega_j(\{(\overline{L})^\gamma \overline{h}(t)\}_{|\gamma| \leq k}) = \Omega_j(t, \bar{t}, \{\partial_{\bar{t}}^\gamma \overline{h}(t)\}_{|\gamma| \leq k}).$$

Applying now the  $n - \chi$  vector fields  $L_i = \frac{\partial}{\partial v_i}$ ,  $i = 1, \dots, n - \chi$ , to these identities, using the fact that these  $\partial_{v_i}$  do commute with the antiholomorphic derivations  $\overline{L}_1^{\gamma_1} \cdots \overline{L}_{\chi-1}^{\gamma_{\chi-1}}$ , and noticing that the  $\overline{h}(t)$  are anti-CR, we obtain that the  $\partial_{v_i} \underline{h}_j(t)$  do vanish identically on  $M$  near the origin. Since the  $\underline{h}_j(t)$  are CR and of class  $\mathcal{C}^\infty$ , we already know that the derivatives  $\partial_{\bar{v}_i} \underline{h}_j(t)$  also vanish identically on  $M$  near the origin. This proves that the  $\underline{h}_j$  are independent of the coordinates  $(v, \bar{v})$ , as desired.  $\square$

Finally, the following lemma achieves to prove that the reflection function, which only depends on  $\underline{h}$ , does extend holomorphically to a neighborhood of  $q \times \bar{q}'$ , as claimed.

**Lemma 4.11.** *The mapping  $\underline{h}$  extends holomorphically to a neighborhood of the origin.*

*Démonstration.* The proof of this lemma is an easy generalization of the Lewy-Pinchuk reflection principle and in fact, it can be argued that Lemma 4.11 is almost completely contained in [P3] (and also in [W2,3], [DW]). Formally indeed, the calculations in the proof of Lemma 4.7 above are totally similar to the ones in the Levi nondegenerate case except for the order of derivations. Of course, the interest of derivating further the equations (4.8) does not lie in this (rather evident or gratuitous) generalization of the reflection principle. Instead, the interest lies in the fact that there are large classes of everywhere Levi-degenerate hypersurfaces for which it is natural to introduce the concept of finite nondegeneracy expressed in terms of the fundamental functions  $\Theta'_\beta(t')$ . Indeed, finite nondegeneracy correspond to the (not rigorous, in the folklore) intuitive notion of “higher order Levi-forms”. Furthermore, holomorphically nondegenerate hypersurfaces are almost everywhere finitely nondegenerate. In sum, from the point of view of local analytic CR geometry, higher order derivations are very natural.

Although Lemma 4.11 is explicitly stated or covered by [DW], [Ha], [BJT], *etc.*, we shall summarize its proof for completeness. Recall that by §3.6, the components of  $h$  extend holomorphically to a global one-sided neighborhood  $D$  of  $M$  which contains one side  $D_q$  of  $M$  at  $q$ . Let  $M^-$  denote the side of  $(M, q)$  containing  $D_q$  and let  $M^+$  denote the other side. As in the Lewy-Pinchuk reflection principle, using the real analyticity of the coefficients of the  $\overline{L}_j$  and using the one-dimensional Schwarz reflection principle in the complex lines  $\{w = ct.\}$  which are transverse to  $M$  near the origin, we observe that the functions  $\Omega_j$  in the right hand side of (4.10) extend  $\mathcal{C}^\infty$ -smoothly to  $M^+$  as functions  $\omega_j$  which are partially holomorphic with respect to the transverse variable  $w$ . Since by (4.10) the values of the  $\underline{h}_j$  coincide on  $(M, q)$  with the values of the  $\omega_j$  and since the  $\underline{h}_j$  are already holomorphic inside  $D_q$ , it follows from a rather easy (because everything is  $\mathcal{C}^\infty$ -smooth) separate analyticity principle that the  $\underline{h}_j$  and the  $\omega_j$  stick together in holomorphic functions defined in a neighborhood of  $q$ . This provides the desired holomorphic extension of  $\underline{h}$  and hence the holomorphic extension of  $\mathcal{R}'_h$ . The proofs of Lemmas 4.6 and 4.11 are complete.  $\square$

**4.12. Holomorphic extension of the mapping.** We end up this paragraph by showing that Theorem 1.9 implies Theorem 1.14 (or equivalently Theorem 1.2). Under the assumptions of Theorem 1.14, let  $p \in M$  be arbitrary and let  $t$  be coordinates vanishing at  $p$ . By the holomorphic extendability of the reflection function, we know that all the  $\mathcal{C}^\infty$ -smooth CR functions  $\Theta'_\beta(h(t))$  extend as holomorphic functions  $\theta'_\beta(t)$  to a fixed neighborhood of  $p$ . Thanks to the holomorphic nondegeneracy of  $M'$ , there exist  $n$  different multi-indices  $\beta^1, \dots, \beta^n \in \mathbb{N}^{n-1}$  such that the generic rank of the holomorphic mapping  $t' \mapsto (\Theta'_{\beta^k}(t'))_{1 \leq k \leq n}$  equals  $\chi'_{M'} = n$ , or equivalently

$$(4.13) \quad \det([\partial \Theta'_{\beta^k} / \partial t'_l](t'))_{1 \leq k, l \leq n} \neq 0 \quad \text{in } \mathbb{C}\{t'\}.$$



Let  $H(t)$  denote the formal Taylor series of  $h$  at the origin. Since the Jacobian determinant of  $h$  at 0 does not vanish, it follows that (4.13) holds in  $\mathbb{C}[[t]]$  after  $t'$  is replaced by  $H(t)$ . Then the holomorphic extendability of  $h$  at the origin is covered by the following assertion.

**Lemma 4.14.** *Let  $p \in M$ , let  $t$  be coordinates vanishing at  $p$ , let  $h_1, \dots, h_n$  be CR functions of class  $C^\infty$  on  $(M, p)$  vanishing at the origin, let  $H_j(t)$  denote the formal Taylor series of  $h_j$  at 0, let  $Q'_1(t'), \dots, Q'_n(t')$  be holomorphic functions satisfying*

$$(4.15) \quad \det([\partial Q'_k / \partial t'_l](H(t)))_{1 \leq k, l \leq n} \neq 0 \quad \text{in } \mathbb{C}[[t]].$$

*Assume that there exist holomorphic functions  $q'_1(t), \dots, q'_n(t)$  defined in a neighborhood of the origin such that  $Q'_k(h(t)) \equiv q'_k(t)$  for all  $t \in (M, p)$  close to the origin. Then  $h_1(t), \dots, h_n(t)$  extend holomorphically to a neighborhood of the origin.*

*Démonstration.* Clearly, the holomorphic functions  $S'_{k,l}(t', t'_*)$  defined by the relations

$$(4.16) \quad Q'_k(t') - Q'_k(t'_*) = \sum_{l=1}^n S'_{k,l}(t', t'_*) (t'_l - t'_{*l})$$

satisfy the relation  $S'_{k,l}(t', t') = [\partial Q'_k(t') / \partial t'_l](t')$ . We first prove that the Taylor series  $H_j(t)$  are convergent. By the Artin approximation theorem ([Ar]), for every integer  $N \in \mathbb{N}_*$ , there exists a *converging* power series mapping  $\mathcal{H}(t) \in \mathbb{C}\{t\}^n$  with  $\mathcal{H}(t) \equiv H(t) \pmod{|t|^N}$  such that  $Q'_k(\mathcal{H}(t)) \equiv q'_k(t)$ . If  $N$  is large enough, it follows from the main assumption of Lemma 4.14 that the following formal determinant does not vanish identically in  $\mathbb{C}[[t]]$ :

$$(4.17) \quad \det(S'_{k,l}(H(t), \mathcal{H}(t)))_{1 \leq k, l \leq n} \neq 0.$$

Finally, by the relation

$$(4.18) \quad \begin{cases} 0 = q'_k(t) - q'_k(t) = Q'_k(H(t)) - Q'_k(\mathcal{H}(t)) = \\ = \sum_{l=1}^n S'_{k,l}(H(t), \mathcal{H}(t)) [H_l(t) - \mathcal{H}_l(t)] \end{cases}$$

and thanks to the invertibility of the matrix  $S'_{k,l}$  (see (4.17)), we deduce that  $H_j(t) = \mathcal{H}_j(t)$  is convergent, as claimed. Secondly, for  $t \in (M, p)$  close to the origin, we again use (4.16) with  $t' := h(t)$  and  $t'_* := \mathcal{H}(t)$ , which yields a relation like (4.18) with  $H(t)$  replaced by  $h(t)$ , namely

$$(4.19) \quad 0 = Q'_k(h(t)) - Q'_k(\mathcal{H}(t)) = \sum_{l=1}^n S'_{k,l}(h(t), \mathcal{H}(t)) [h_l(t) - \mathcal{H}_l(t)].$$

Then the corresponding determinant (4.17) (with  $H(t)$  replaced by  $h(t)$ ) does not vanish identically on  $(M, p)$ , because it has a nonvanishing formal Taylor series by (4.17) and because  $(M, p)$  is generic. Consequently, relation (4.19) implies that  $h_l(t) \equiv \mathcal{H}_l(t)$  for all  $t \in (M, p)$  close to the origin. This completes the proof of Lemma 4.14 (similar arguments are provided in [N]). Also, the proof of Theorem 1.14 (taking Theorem 1.9 for granted) is complete.  $\square$

## §5. SITUATION AT A TYPICAL POINT OF NON-ANALYTICITY

Thus, we already know that  $\mathcal{R}'_h$  is analytic at every point  $q \times \overline{h(q)}$  for  $q$  running in the open dense subset  $M \setminus E_M$  of  $M$ . It remains to show that  $\mathcal{R}'_h$  is analytic at all the points  $p \times \overline{h(p)}$ , where  $p \in E_M$ , which entails  $h(p) \in E'_{M'}$  by Lemma 4.3. This objective constitutes the principal task of the demonstration. In fact, we shall prove a slightly more general semi-global statement which we summarize as follows.

**Theorem 5.1.** *Let  $h : M \rightarrow M'$  be a  $C^\infty$ -smooth CR diffeomorphism between two globally minimal real analytic hypersurfaces in  $\mathbb{C}^n$ . If the local reflection mapping  $\mathcal{R}'_h$  is analytic at one point  $q \times \overline{h(q)}$  of  $M \times M'$ , then it is analytic at every point  $p \times \overline{h(p)}$  of the graph of  $\bar{h}$  in  $M \times M'$ .*

To prove Theorem 5.1, we shall proceed by contradiction. We define the following subset of  $M'$

$$(5.2) \quad \mathcal{A}' := \{p' \in M' : \mathcal{R}'_h \text{ is analytic in a neighborhood of } h^{(-1)}(p') \times \overline{p'}\}.$$

A similar subset  $\mathcal{A}$  of  $M$  such that  $h$  maps  $\mathcal{A}$  bijectively onto  $\mathcal{A}'$  can be defined, but in fact, it will be more adapted to our purposes to work in  $M'$  with  $\mathcal{A}'$ . Recall that we already know that Theorem 1.9 implies Theorem 1.2. However, for a direct proof of Theorem 1.2 (*cf.* §2), it would have been convenient to define the set  $\mathcal{A}'$  above as the set of point  $p' \in M'$  such that  $h$  is analytic in a neighborhood of  $h^{-1}(p')$ . Anyway, the set  $\mathcal{A}'$  defined by (5.2) is nonempty, by the assumption of Theorem 5.1. For the proof of Theorem 1.9,  $\mathcal{A}'$  is also nonempty, because it contains  $M' \setminus E'_{M'}$  thanks to Lemma 4.6 above. So let us start with (5.2). If  $\mathcal{A}' = M'$ , Theorem 5.1 would be proved, gratuitously. As in §2.2, we shall therefore suppose that its complement  $E'_{\text{na}} := M' \setminus \mathcal{A}'$  is nonempty and we shall endeavour to derive a contradiction. In fact, to derive a contradiction, it clearly suffices to prove that there exists at least one point  $p' \in E'_{\text{na}}$  such that  $\mathcal{R}'_h$  is analytic at  $h^{(-1)}(p') \times \overline{p'}$ . It is convenient to choose a “good” such point  $p'_1$  which is geometrically well located, namely it belongs to  $E'_{\text{na}}$  and in a neighborhood of  $p'_1$ , the closed set  $E'_{\text{na}}$  is not too pathological or wild : it lies *behind* a smooth generic “wall”  $M'_1$ .

**5.3. Construction of a generic wall.** As in Lemma 2.3, this point  $p'_1$  will belong to a generic one-codimensional submanifold  $M'_1 \subset M'$ , a kind of “wall” in  $M'$  dividing  $M'$  locally into two open sides, which will be disposed conveniently in order that one open side of the “wall”, say  $M'^{-}_1$ , will *contain only points where  $\mathcal{R}'_h$  is already real analytic*. To show the existence of such a point  $p'_1 \in E'_{\text{na}}$  and of such a manifold (“wall”)  $M'_1$ , we shall proceed similarly as in [MP1, Lemma 2.3]. The following picture summarizes how we proceed intuitively speaking.

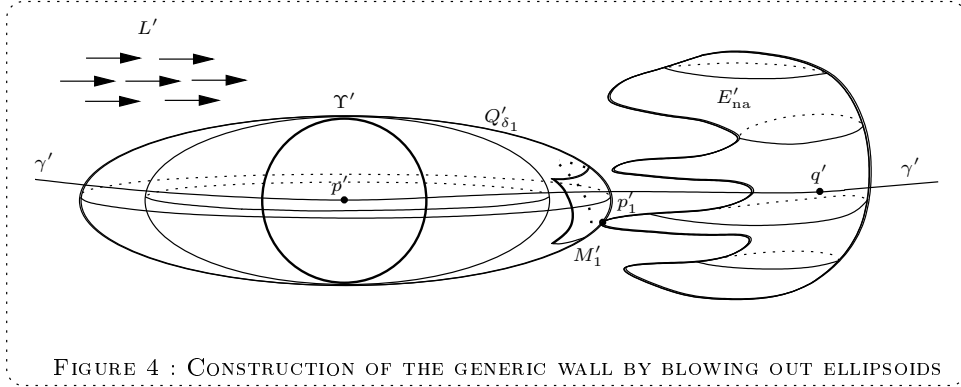

FIGURE 4 : CONSTRUCTION OF THE GENERIC WALL BY BLOWING OUT ELLIPSOIDS

**Lemma 5.4.** *There is a point  $p'_1 \in E'_{\text{na}}$  and a real analytic generic hypersurface  $M'_1 \subset M'$  passing through  $p'_1$  so that  $E'_{\text{na}} \setminus \{p'_1\}$  lies near  $p'_1$  in one side of  $M'_1$  (see FIGURE 4).*

*Démonstration.* Let  $q' \in E'_{\text{na}} \neq \emptyset$  be an arbitrary point and let  $\gamma'$  be a piecewise real analytic curve running in complex tangential directions to  $M'$  (CR-curve) linking  $q'$  with another point  $p' \in M' \setminus E'_{\text{na}}$ . Such a curve  $\gamma'$  exists because  $M'$  and  $M' \setminus E'_{\text{na}}$  are globally minimal by assumption (in fact, every open subset of  $M'$  is globally minimal, because  $M'$  is locally minimal at every point). After shortening  $\gamma'$ , we may suppose that  $\gamma'$  is a smoothly embedded segment, that  $p'$  and  $q'$  belong to  $\gamma'$  and are close to each other. Therefore  $\gamma'$  can be described as a part of an integral curve of some nonvanishing real analytic CR vector field (*i.e.* a section of  $T^c M'$ )  $L'$  defined in a neighborhood of  $p'$ .

Let  $H' \subset M'$  be a small  $(2n - 2)$ -dimensional real analytic hypersurface passing through  $p'$  and transverse to  $L'$ . Integrating  $L'$  with initial values in  $H'$  we obtain real analytic coordinates  $(u', v') \in \mathbb{R} \times \mathbb{R}^{2n-2}$  so that for fixed  $v'_0$ , the segments  $(u', v'_0)$  are contained in the trajectories

of  $L'$ . After a translation, we may assume that the origin  $(0, 0)$  corresponds to a point of  $\gamma'$  close to  $p'$  which is not contained in  $E'_{\text{na}}$ , again denoted by  $p'$ . Fix a small  $\varepsilon > 0$  and for real  $\delta \geq 1$ , define the ellipsoids (see again FIGURE 1 above)

$$Q'_\delta := \{(u', v') : |u'|^2/\delta + |v'|^2 < \varepsilon\}.$$

There is a minimal  $\delta_1 > 1$  with  $\overline{Q'_{\delta_1}} \cap E'_{\text{na}} \neq \emptyset$ . Then  $\overline{Q'_{\delta_1}} \cap E'_{\text{na}} = \partial Q'_{\delta_1} \cap E'_{\text{na}}$  and  $Q'_{\delta_1} \cap E'_{\text{na}} = \emptyset$ . Observe that every boundary  $\partial Q'_\delta$  is transverse to the trajectories of  $L'$  out off the equatorial set  $\Upsilon' := \{(0, v') : |v'|^2 = \varepsilon\}$  which is contained in  $M' \setminus E'_{\text{na}}$ . Hence  $\partial Q'_{\delta_1}$  is transverse to  $L'$  in all points of  $\partial Q'_{\delta_1} \cap E'_{\text{na}}$ . So  $\partial Q'_{\delta_1} \setminus \Upsilon'$  is generic in  $\mathbb{C}^{m+n}$ , since  $L'$  is a CR field.

To conclude, it suffices to choose a point  $p'_1 \in \partial Q'_{\delta_1} \cap E'_{\text{na}}$  and to take for  $M'_1$  a small real analytic hypersurface passing through  $p'_1$  which is tangent to  $\partial Q'_{\delta_1}$  at  $p'_1$  and satisfies  $M'_1 \setminus \{p'_1\} \subset Q'_{\delta_1}$ .  $\square$

In summary, it suffices now for our purposes to establish the following assertion.

**Theorem 5.5.** *Let  $p'_1 \in E'_{\text{na}}$  and assume that there exists a real analytic one-codimensional submanifold  $M'_1$  with  $p'_1 \in M'_1 \subset M'$  which is generic in  $\mathbb{C}^n$  such that  $E'_{\text{na}} \setminus \{p'_1\}$  is completely contained in one of the two open sides of  $M'$  divided by  $M'_1$  at  $p'_1$ , say in  $M_1'^+$ , and such that  $\mathcal{R}'_h$  is analytic at the points  $h^{-1}(q') \times \overline{q'}$ , for every point  $q'$  belonging to the other side  $M_1'^-$ . Then the reflection function  $\mathcal{R}'_h$  extends holomorphically at the point  $h^{-1}(p'_1) \times \overline{p'_1}$ .*

By the CR diffeomorphism assumption, the formal Taylor series of  $h$  at  $p_1$  induces an invertible formal CR mapping between  $(M, p_1)$  and  $(M', p'_1)$ . It is shown in [Me6,8] that the associated formal reflection function converges at  $p_1 \times \overline{p'_1}$  and (as a corollary) that there exists a local biholomorphic equivalence from  $(M, p_1)$  onto  $(M', p'_1)$ . Consequently, it would be possible to suppose, without loss of generality, that  $(M', p'_1) = (M, p_1)$  in Theorem 5.5. However, since the proof would be completely the same (except in notation), we shall maintain the general hypotheses. In coordinates  $t'$  vanishing at  $p'_1$ , we can assume that  $M'$  is given by the real equation  $\text{Im } w' = \varphi'(z', \bar{z}', \text{Re } w')$ , i.e.  $v' = \varphi'(z', \bar{z}', u')$  if  $w' := u' + iv'$ , or equivalently by the complex equation  $\bar{w}' = \Theta'(\bar{z}', t')$  with  $\Theta'$  converging in the polydisc  $\Delta_{2n-1}(0, \rho')$  and satisfying  $\bar{w}' \equiv \Theta'(\bar{z}', z', \bar{\Theta}'(z', \bar{z}', \bar{w}'))$ . In fact, given  $\varphi'$ , the function  $\Theta'$  is the unique solution of the implicit functional equation  $w' - \Theta'(\bar{z}', t') \equiv 2i\varphi'(z', \bar{z}', (w' + \Theta'(\bar{z}', t'))/2)$ . It is convenient to choose the coordinates in order that  $T_0 M' = \{w' = \bar{w}'\}$ . Moreover, an elementary reasoning using only linear changes of coordinates and Taylor's formula shows that, after a possible deformation of the manifold  $M'_1$  in a new manifold still passing through  $p'_1$  which is bent quadratically in the left side  $M_1'^-$ , we can assume for simplicity that  $M'_1$  is given by the two equations  $\bar{w}' = \Theta'(\bar{z}', t')$  and  $x'_1 = -[y_1'^2 + |z_1'|^2 + u'^2]$ , where we decompose  $z'_1 = x'_1 + iy'_1$  in real and imaginary part and where we denote  $z'_\sharp := (z'_2, \dots, z'_{n-1})$ . In this notation, the new side  $M_1'^-$  is given by :

$$(5.6) \quad M_1'^- : \{(z', w') \in M' : x'_1 < -[y_1'^2 + |z'_\sharp|^2 + u'^2]\}.$$

(Warning : For ease of readability, in Figure 5 below, we have drawn  $M'_1$  as if the defining equation of  $M'_1$  was equal to  $x'_1 = +[y_1'^2 + |z'_\sharp|^2 + u'^2]$ , so Figure 5 is slightly incorrect.) Shrinking  $\rho'$  if necessary, by Lemma 5.4, we know that  $E'_{\text{na}} \setminus \{p'_1\}$  is contained in the right open part  $M_1'^+ \cap \Delta_n(0, \rho')$ . We set  $p_1 := h^{-1}(p'_1)$  and  $M_1 := h^{-1}(M'_1)$ . Then  $M_1$  is one-codimensional generic submanifold of  $M$  which is only of class  $\mathcal{C}^\infty$ , because the CR diffeomorphism  $h$  is only of class  $\mathcal{C}^\infty$ . The reader may observe that even if we take the conclusion of the proof of Theorem 5.5 for granted, namely even if we admit that  $\mathcal{R}'_h$  is real analytic at  $h^{-1}(p'_1) \times \overline{p'_1}$ , it does not follow necessarily (unless  $M'$  is holomorphically nondegenerate) that  $h$  is real analytic (cf. Lemma 1.16), so the hypersurface  $h^{-1}(M'_1)$  is not real analytic in general. Let  $D$  be the global one-sided neighborhood of automatic extendability of CR functions on  $M$  constructed in §3.6. Let  $D_{p_1} \subset D$  be a small local one-sided neighborhood of  $(M, p_1)$ . Since we are working at  $p_1$ , we shall identify the two notations  $D_{p_1}$  and  $D$  in the sequel. By the considerations of §3.6, the reflection function  $\mathcal{R}'_h$  associated with these coordinates is already

holomorphic in  $D \times \Delta_n(0, \rho')$ , shrinking  $\rho' > 0$  if necessary. Moreover,  $\mathcal{R}'_h$  is also holomorphic at each point  $h^{-1}(q') \times \overline{q'}$ , for all  $q'$  belonging to  $M_1'^-$  in a neighborhood of the origin. Using the computation of §3.36 (especially, equations (3.40)), we can make this property more explicit. Let  $(\Psi'_{q'})_{q' \in M'}$  denote the family of biholomorphisms sending  $q' \in M'$  to 0 simply obtained by translation of coordinates  $t' \mapsto t'_* := t' - q'$ . The  $\Psi'_{q'}$  are holomorphically parametrized by  $q' \in \Delta_n(0, \rho'/2)$ . Let  $\bar{w}'_* = \Theta'_*(\bar{z}'_*, t'_*)$  denote the corresponding equation of  $\Psi'_{q'}(M')$ . Let  $h_{q'}$  denote the mapping  $h - q'$  obtained by this translation of coordinates, namely  $h_*(t) := h(t) - q'$ . Let  $q := h^{-1}(q')$ . By assuming that the reflection function extends holomorphically to a neighborhood of  $h^{-1}(q') \times \overline{q'}$  for every point  $q' \in M_1'^-$ , we mean precisely that each translated reflection function  $\mathcal{R}'_{*, h_*}$  in these coordinates vanishing at  $q'$  extends holomorphically to a neighborhood of  $q \times 0$ . By Lemma 3.22, this property is invariant under changes of coordinates fixing  $q \times 0$ . However, we need to express this property in terms of a *single* coordinate system, for instance in the system  $t'$  vanishing at  $p'_1$ , and this is not obvious.

**5.7. Holomorphic extendability in a fixed coordinate system.** This part is delicate and we begin with some heuristic explanations. As presented in §2 with a slightly different definition of  $E'_{\text{na}}$ , in the situation of Theorem 1.2 (where  $M'$  is holomorphically nondegenerate) and of the corresponding Theorem 5.5, the mapping  $h$  already extends holomorphically to a neighborhood of  $M_1^-$  in  $\mathbb{C}^n$ . However, in the situation of Theorems 1.9 and 5.5, this is untrue in general. Consequently, we raise the following question : if we fix the coordinate system  $t'$  vanishing at the point  $p'_1 \in M_1'$  of Theorem 5.5, is it also true that the components  $\Theta'_{*\beta}(h(t))$  extend holomorphically to a neighborhood of  $M_1^-$  in  $\mathbb{C}^n$ ? Let  $q' \in M_1'^-$  be close to the point  $p'_1$ , which is the origin in the coordinates  $t'$ . Let  $t'_* := t' - t'_*$  as in §3.36. Let  $\bar{w}'_* = \Theta'_*(\bar{z}'_*, t'_*)$  be the translated equation of  $M'$ . Also, denote  $h(t) - q'$  by  $h_*(t)$ . By assumption, the reflection function  $\bar{\mu}'_* - \Theta'_*(\bar{\lambda}'_*, h_*(t))$  extends holomorphically to  $\Delta_n(q, \sigma_q) \times \Delta_n(0, \sigma'_{q'})$ , for some two positive real numbers  $\sigma_q > 0$  and  $\sigma'_{q'} > 0$ . By Lemma 3.16, we have a Cauchy estimate for the holomorphic extensions  $\theta'_{*\beta}(t)$  of the components  $\Theta'_{*\beta}(h(t))$  of the reflection function, say  $|\theta'_{*\beta}(t)| \leq C(\sigma'_{q'})^{-|\beta|}$  for all  $|t - q| < \sigma_q$ . Possibly,  $\sigma'_{q'}$  is smaller than  $|q'|$ . In the previous coordinate system  $t'$ , it would be natural to deduce that the  $C^\infty$ -smooth CR functions  $\Theta'_{*\beta}(h(t))$  extend holomorphically to a neighborhood of  $q$  in  $\mathbb{C}^n$ . Unfortunately, by formulas (3.43), we would necessarily have the following representation for the desired holomorphic extensions  $\theta'_{*\beta}(t)$  of the components  $\Theta'_{*\beta}(h(t))$  of the reflection function (if the series would be convergent for  $|t - q| \leq \sigma_q$ ) :

$$(5.8) \quad \theta'_{*\beta}(t) := \theta'_{*\beta}(t) + \sum_{\gamma \in \mathbb{N}_*^{n-1}} (\bar{z}'_{q'})^\gamma (-1)^\gamma \theta'_{*\beta+\gamma}(t) \frac{(\beta + \gamma)!}{\beta! \gamma!}.$$

For this formulas to converge *normally* and to define a holomorphic function of  $t$ , it would be necessary that the modulus of  $\bar{z}'_{q'}$  be smaller than  $\sigma'_{q'}$ , which is *not a priori* true in general. This difficulty is meaningful, unavoidable and important.

At present, we may nevertheless observe a useful trick : *if  $\bar{z}'_{q'}$  vanishes, then formulas (5.8) automatically yield holomorphic functions  $\theta'_{*\beta}(t)$  in the polydisc  $\{|t - q| < \sigma_q\}$ .* Indeed, if  $\bar{z}'_{q'} = 0$ , there are no infinite series at all! Indeed,  $\theta'_{*\beta}(t) \equiv \theta'_{*\beta}(t)$ . So choosing a point  $q'$  with vanishing coordinate  $\bar{z}'_{q'}$  is a crucial observation allowing to bypass the nonconvergence of the series (5.8). Moreover, we will crucially use this trick in the proof of Lemma 7.7 (corresponding to Lemma 2.4). In sum, we have observed that Cauchy estimates might be killed after complex tangential displacement whereas they are trivially conserved after complex transversal displacement.

**5.9. Holomorphic extension to a neighborhood of  $M_1^-$ .** Fortunately, thanks to Artin's approximation theorem, we can bypass the general difficulty above and we can make  $\sigma'_{q'}$  larger than  $\bar{z}'_{q'}$  at the cost of reducing  $\sigma_q$ . In advance, the following Lemma 5.10 is adapted to its application in §7 below. Let  $q'_1 \in M'$  be close to  $p'_1$ , let  $t'$  be a fixed system of coordinates

centered at  $q'_1$ , so  $q'_1$  is identified with the origin. Without loss of generality, we can assume that  $h(M \cap \Delta_n(0, \rho/2)) \subset M' \cap \Delta_n(0, \rho'/2)$ . Let  $E \subset M \cap \Delta_n(0, \rho/2)$  be an arbitrary closed subset, not necessarily passing through the origin. Set  $E' := \overline{h(E)}$ . As in Theorem 5.5, let us assume that the reflection function centered at points  $q \times \overline{h(q)}$  is locally holomorphically extendable, for all  $q \in (M \setminus E) \cap \Delta_n(0, \rho/2)$ . Then the following holds.

**Lemma 5.10.** *In the fixed system of coordinates  $t'$  centered at  $q'_1$ , there exists a neighborhood  $\Omega$  of  $(M \setminus E) \cap \Delta_n(0, \rho/2)$  in  $\mathbb{C}^n$  to which the components  $\Theta'_\beta(h(t))$  of the reflection function extend holomorphically.*

*Démonstration.* So, let  $q \in (M \setminus E) \cap \Delta_n(0, \rho/2)$  be an arbitrary point and let  $q' := h(q)$ . As in Lemma 3.37, let  $t'_* := t' - q'$ , let  $t_* := t - q$  and let  $\bar{v}'_* - \sum_{\beta \in \mathbb{N}^{n-1}} (\bar{\lambda}'_*)^\beta \Theta'_{*\beta}(h_*(t_*))$  be the reflection function centered at  $q \times \bar{q}'$ . Here, we have  $|q| < \rho/2$  and  $|q'| < \rho'/2$ . Let  $\sigma_q > 0$  and  $\sigma'_{q'} > 0$  be such that  $\mathcal{R}'_h(t, \bar{v}')$  extends as a holomorphic function  $R'_*(t_*, \bar{v}'_*) := \bar{\mu}'_* - \sum_{\beta \in \mathbb{N}^{n-1}} (\bar{\lambda}'_*)^\beta \theta'_{*\beta}(t_*)$  for  $|t_*| < \sigma_q$  and  $|\bar{v}'_*| < \sigma'_{q'}$ . Of course, it follows that the holomorphic functions  $\theta'_{*\beta}(t_*)$  converge for  $|t_*| < \sigma_q$  and that if  $H_*(t_*)$  denotes the formal power series of  $h_*(t_*)$  at  $t_* = 0$ , then  $\Theta'_{*\beta}(H_*(t_*)) \equiv \theta'_{*\beta}(t_*)$  in  $\mathbb{C}[[t_*]]$ . By Artin's approximation theorem, there exists a holomorphic mapping  $\mathcal{H}_*(t_*)$  defined for  $|t_*| < \sigma_* < \sigma_q$  such that  $\Theta'_{*\beta}(\mathcal{H}_*(t_*)) \equiv \theta'_{*\beta}(t_*)$  in  $\mathbb{C}\{t_*\}$ . By the Cauchy estimates for  $\Theta'_\beta(t')$ , since  $|q'| < \rho'/2$ , there exists a constant  $C > 0$  such that we have  $|\Theta'_{*\beta}(t'_*)| \leq C(\rho'/2)^{-|\beta|}$  for all  $|t'_*| < \rho'/4$ . Shrinking  $\sigma_*$  if necessary, we can assume that  $|\mathcal{H}_*(t_*)| < \rho'/4$  for all  $|t_*| < \sigma_*$ . It follows that

$$(5.11) \quad |\Theta'_{*\beta}(\mathcal{H}_*(t_*))| = |\theta'_{*\beta}(t_*)| < C(\rho'/2)^{-|\beta|},$$

for all  $\beta \in \mathbb{N}^{n-1}$ . Finally, this Cauchy estimate is appropriate to deduce that the series defined in equations (5.8) do converge normally and do define holomorphic extension to the polydisc  $\Delta_n(q, \sigma_*)$  of the components of the reflection function centered at  $q_1 \times \bar{q}'_1$ . For all  $q$  running in  $(M \setminus E) \cap \Delta_n(0, \rho/2)$ , the various obtained extensions of course stick together thanks to the uniqueness principle at the boundary ([P1]). The proof of Lemma 5.10 is complete.  $\square$

In particular, in the situation of Theorem 5.5, it follows from Lemma 5.10 (with  $q_1 := p_1$ ) that we can assume that the components of the reflection function centered at  $p_1 \times \bar{p}'_1$  extend holomorphically to a neighborhood of  $(M \cap E_{\text{na}}) \cap \Delta_n(0, \rho/2)$ . Now we can begin our principal geometric constructions. As explained in §2.2, we intend to study the envelope of holomorphy of the union of  $D \cup \Omega$  together with an arbitrary thin neighborhood of a Levi-flat hypersurface  $\Sigma_\gamma$ . We need real arcs and analytic discs.

## §6. ENVELOPES OF HOLOMORPHY OF DOMAINS WITH LEVI-FLAT HATS

**6.1. A family of real analytic arcs.** To start with, we choose coordinates  $t$  and  $t'$  as above near  $M$  and near  $M'$  in which  $p_1 := h^{-1}(p'_1)$  and  $p'_1$  are the origin and in which the complex equations of  $M$  and of  $M'$  are given by  $\bar{w} = \Theta(\bar{z}, t)$  and  $\bar{w}' = \Theta'(\bar{z}', t')$  respectively. Geometrically speaking, it is convenient to assume  $T_0M = \{\text{Im } w = 0\}$  and  $T_0M' = \{\text{Im } w' = 0\}$ . We shall denote the real equations of  $M$  and of  $M'$  by  $v = \varphi(z, \bar{z}, u)$  and  $v' = \varphi'(z', \bar{z}', u')$  respectively. We assume that the power series defining  $\Theta$  and  $\Theta'$  converge normally in the polydisc  $\Delta_{2n-1}(0, \rho)$  and  $\Delta_{2n-1}(0, \rho')$  respectively. For  $q'_1 \in M'$  close to the origin in the target space, we now consider a convenient, sufficiently rich, family of embedded real analytic arcs  $\gamma'_{q'_1}(s')$ , depending on  $(2n-1)$  very small real parameters  $(z'_{q'_1}, u'_{q'_1}) \in \mathbb{C}^{n-1} \times \mathbb{R}$  satisfying  $|z'_{q'_1}| < \varepsilon'$ ,  $|u'_{q'_1}| < \varepsilon'$ , where  $\varepsilon' \ll \rho'$ , with the “time parameter”  $s'$  satisfying  $|s'| \leq \rho'/2$ , which are all transverse to the complex tangential directions of  $M'$ , and which are defined as follows :

$$(6.2) \quad \left\{ \begin{array}{l} \gamma'_{q'_1} := \left\{ (x'_{1,q'_1} - s'^2 - (y'_{1,q'_1} + s')^2 - |z'_{\sharp q'_1}|^2 - u'_{q'_1}{}^2 + i[y'_{1,q'_1} + s']), \right. \\ \left. z'_{\sharp q'_1}, u'_{q'_1} \in M' : s' \in \mathbb{R}, |s'| \leq \rho'/2 \right\}. \end{array} \right.$$

Here, in the definition of  $\gamma'_{q'_1}$ , we identify a point of  $M'$  with its  $(2n - 1)$  real coordinates  $(z', u') = (x'_1 + iy'_1, z'_\sharp, u')$ . We also recall that  $z'_\sharp = (z'_2, \dots, z'_{n-1})$  and that  $M'_1^-$  is given by (5.6). The following figure, in which we have reversed the curvature of  $M'_1$  for easier readability, explains how the  $\gamma'_{q'_1}$  and  $M'_1$  are disposed.

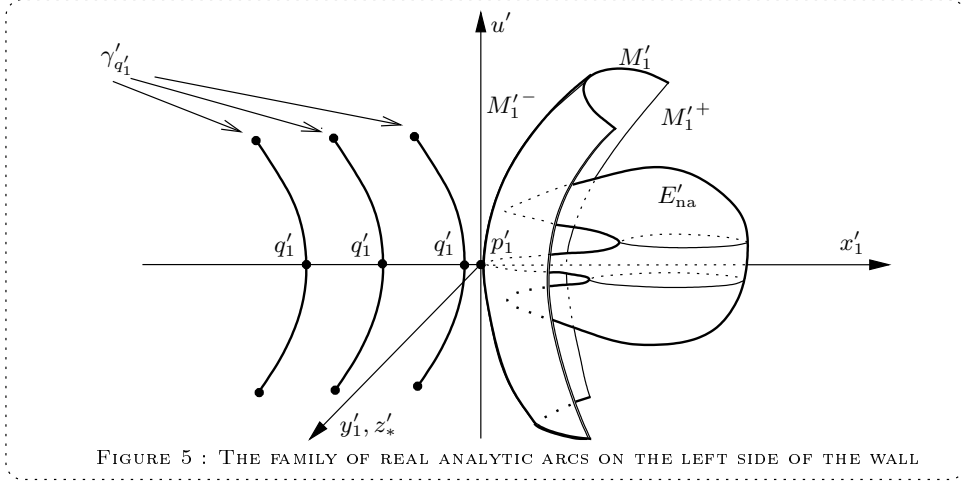

FIGURE 5 : THE FAMILY OF REAL ANALYTIC ARCS ON THE LEFT SIDE OF THE WALL

We identify the arcs  $\gamma'_{q'_1}$  with the mappings  $s' \mapsto \gamma'_{q'_1}(s')$ . It can be straightforwardly checked that the following properties hold :

- (1) *The mapping  $(z'_{q'_1}, u'_{q'_1}) \mapsto \gamma'_{q'_1}(0)$  is a real analytic diffeomorphism onto a neighborhood of 0 in  $M'$ . Furthermore, the inverse image of  $M'_1$  and of  $M'_1^-$  simply correspond to the sets  $\{x'_{1,q'_1} = 0\}$  and  $\{x'_{1,q'_1} < 0\}$ , respectively.*
- (2) *For  $x'_{1,q'_1} < 0$ , we have  $\gamma'_{q'_1} \subset \subset M'_1^-$ .*
- (3) *For  $x'_{1,q'_1} = 0$ , we have  $\gamma'_{q'_1} \cap M'_1 = \{\gamma'_{q'_1}(0)\}$ .*
- (4) *For  $x'_{1,q'_1} = 0$ , the order of contact of  $\gamma'_{q'_1}$  with  $M'_1$  at the point  $\gamma'_{q'_1}(0)$  equals 2.*
- (5) *For all  $|z'_{q'_1}|, |u'_{q'_1}| < \varepsilon'$ , we have  $\gamma'_{q'_1}([- \rho'/2, -\rho'/4]) \subset M'_1^-$  and  $\gamma'_{q'_1}([\rho'/4, \rho'/2]) \subset M'_1^-$ .*

**6.3. Inverse images.** Since  $h$  is a  $C^\infty$ -smooth CR diffeomorphism, by inverse image, we get in  $M$  a family of  $C^\infty$ -smooth arcs, namely  $h^{-1}(\gamma'_{q'_1})$ . In analogy with the notation  $\gamma'_{q'_1}(s')$ , we shall denote these arcs by  $\gamma_{q_1}(s)$ . By the index notation  $\cdot_{q_1}$ , we mean that these arcs are parametrized by the point  $q_1 := h^{-1}(q'_1) \in M$ . Of course, a point  $q_1 \in M$  can be identified with its coordinates  $(z_{q_1}, u_{q_1}) \in \mathbb{C}^{n-1} \times \mathbb{R}$ , so the arcs  $\gamma_{q_1}$  are concretely parameterized by  $(z_{q_1}, u_{q_1}) \in \mathbb{C}^{n-1} \times \mathbb{R}$  and by the “time”  $s \in \mathbb{R}$ . It is convenient to identify the point  $p_1$  with the origin (in the coordinate system  $t$ ) and the point  $q_1$  close to  $p_1$  with its coordinates  $(z_{q_1}, u_{q_1})$ . Of course, shrinking a bit  $\rho$  if necessary, there exists  $\varepsilon \ll \rho$  such that the parameters satisfy  $|z_{q_1}| < \varepsilon$ ,  $|u_{q_1}| < \varepsilon$  and  $|s| \leq \rho/2$ . Evidently, the  $C^\infty$ -smooth arcs  $\gamma_{q_1}$  satisfy four properties similar to (1–5) above with respect to  $M_1$ . Let us summarize the geometric properties that will be of important use later, when envelopes of holomorphy will appear on scene.

**Lemma 6.4.** *For all small  $x_{1,q_1} < 0$  and  $z_{\sharp,q_1}, u_{q_1}$  arbitrary, the following two properties holds :*

- (1) *The center points  $\gamma_{q_1}(0)$  of the smooth arcs  $\gamma_{q_1}$  cover diffeomorphically the left negative one-sided neighborhood  $M_1^-$  of  $M_1$  in a neighborhood of  $p_1$ .*
- (2) *The arcs  $\gamma_{q_1}$  are entirely contained in  $M_1^-$  and satisfy,  $\gamma_{q_1}([- \rho/2, -\rho/4]) \subset M_1^-$  and  $\gamma_{q_1}([\rho/4, \rho/2]) \subset M_1^-$ , even for small  $x_{1,q_1} \geq 0$ .*

**6.5. Construction of a family of Levi-flat hats.** Next, if  $\gamma$  is a  $C^\infty$ -smooth arc in  $M$  transverse to  $T^cM$  at each point, we can construct the union of Segre varieties attached to the points running in  $\gamma : \Sigma_\gamma := \bigcup_{q \in \gamma} S_{\bar{q}}$ . We remind that the Segre variety  $S_{\bar{q}}$  associated to an arbitrary point  $q$  close to the origin is the complex hypersurface of  $\Delta_n(0, \rho)$  of equation  $w = \bar{\Theta}(z, \bar{t}_q)$ . For various arcs  $\gamma_{q_1}$ , we obtain various sets  $\Sigma_{\gamma_{q_1}}$  which are in fact  $C^\infty$ -smooth Levi-flat hypersurfaces in a neighborhood of  $\gamma_{q_1}$ . The uniformity of the size of such neighborhoods follows immediately from the smooth dependence with respect to  $(z_{q_1}, u_{q_1})$ . Shrinking  $\rho$  if necessary, the Levi-flat hypersurface  $\Sigma_{\gamma_{q_1}}$  is closed in  $\Delta_n(0, \rho/3)$ . What we shall need in the sequel can then be summarized as follows.

**Lemma 6.6.** *There exists  $\varepsilon > 0$  with  $\varepsilon \ll \rho$  such that, if the parameters of  $\gamma_{q_1}$  satisfy  $|z_{q_1}|, |u_{q_1}| < \varepsilon$ , then the set  $\Sigma_{\gamma_{q_1}} \cap \Delta_n(0, \rho/3)$  is a closed  $C^\infty$ -smooth (and  $C^\infty$ -smoothly parametrized) Levi-flat hypersurface of  $\Delta_n(0, \rho/3)$ .*

**6.7. Two families of half-attached analytic discs.** Let us now define inverse images of analytic discs. Complexifying the real analytic arcs  $\gamma'_{q'_1}$ , we obtain local transverse holomorphic discs  $(\gamma'_{q'_1})^c$ , closed in  $\Delta_n(0, \rho/2)$ , of which one half part penetrates inside  $D' := h(D)$ . Uniformly smoothing out the corners of such half discs (see the right hand side of FIGURE 3), using Riemann's conformal mapping theorem and then an automorphism of  $\Delta$ , we can easily construct a real analytically parameterized family of analytic discs  $A'_{q'_1} : \Delta \rightarrow \mathbb{C}^n$  which are  $C^\infty$ -smooth up to the boundary  $b\Delta$  and are embedding of  $\bar{\Delta}$  such that, if we denote  $b^+\Delta := b\Delta \cap \{\operatorname{Re} \zeta \geq 0\}$  (and  $b^-\Delta := b\Delta \cap \{\operatorname{Re} \zeta \leq 0\}$ ), then we have  $A'_{q'_1}(1) = \gamma'_{q'_1}(0)$  and also :

$$(6.8) \quad \gamma'_{q'_1} \cap \Delta_n(0, \rho'/4) \subset A'_{q'_1}(b^+\Delta) \subset \gamma'_{q'_1} \cap \Delta_n(0, \rho'/3),$$

for all  $|z'_{q'_1}|, |u'_{q'_1}| < \varepsilon'$  (cf. FIGURES 2 and 3). Consequently, the composition with  $h^{-1}$  yields a family of analytic discs  $A_{q_1}(\zeta) := h^{-1}(A'_{q'_1}(\zeta))$  which satisfy similar properties, namely :

**Lemma 6.9.** *The mapping  $(q_1, \zeta) \mapsto A_{q_1}(\zeta)$  is  $C^\infty$ -smooth and it provides a uniform family of  $C^\infty$ -smooth embeddings of the closed unit disc  $\bar{\Delta}$  into  $\mathbb{C}^n$ . Furthermore, we have  $A_{q_1}(1) = \gamma_{q_1}(0)$  and*

$$(6.10) \quad \gamma_{q_1} \cap \Delta_n(0, \rho/4) \subset A_{q_1}(b^+\Delta) \subset \gamma_{q_1} \cap \Delta_n(0, \rho/3).$$

Finally, we have  $A_{q_1}(b^-\Delta) \subset \subset D \cup M_1^-$ .

This family  $A_{q_1}$  will be our starting point to study the envelope of holomorphy of (a certain subdomain of) the union of  $D$  together with a neighborhood  $\Omega$  of  $M_1^-$  and with an arbitrarily thin neighborhood  $\omega(\Sigma_{\gamma_{q_1}})$  of  $\Sigma_{\gamma_{q_1}}$  (see FIGURE 3 and FIGURE 6 below). At first, we must include  $A_{q_1}$  into a larger family of discs obtained by sliding the half-attached part inside  $\Sigma_{\gamma_{q_1}}$  along the complex tangential directions of  $\Sigma_{\gamma_{q_1}}$ .

**6.11. Deformation of half-attached analytic discs.** To this aim, we introduce the equation  $v = H_{q_1}(z, u)$  of  $\Sigma_{\gamma_{q_1}}$ , where the mapping  $(q_1, z, u) \mapsto H_{q_1}(z, u)$  is of course  $C^\infty$ -smooth and  $\|H_{q_1} - H_{p_1}\|_{C^\infty(z, u)}$  is very small. Further, we need some formal notation. We denote  $A_{q_1}(\zeta) := (z_{q_1}(\zeta), u_{q_1}(\zeta))$  and  $A_{q_1}(1) = \gamma_{q_1}(0) =: (z_{q_1}^1, u_{q_1}^1)$ . To deform these discs by applying the classical works on analytic discs and because Banach spaces are necessary, we shall work in the regularity class  $\mathcal{C}^{k, \alpha}$ , where  $k \geq 1$  is arbitrary and where  $0 < \alpha < 1$ , which is sufficient for our purposes. Let  $T_1$  denote the Hilbert transform vanishing at 1 (see [Tu1,2,3], [MP1,2]). By definition,  $T_1$  is the unique (bounded, by a classical result) endomorphism of the Banach space  $\mathcal{C}^{k, \alpha}(b\Delta, \mathbb{R})$ ,  $0 < \alpha < 1$ , to itself such that  $\phi + iT_1(\phi)$  extends holomorphically to  $\Delta$  and  $T_1\phi$  vanishes at  $1 \in b\Delta$ , i.e.  $(T_1(\phi))(1) = 0$ . Our next reasoning below is similar to the one in Aĭrapetyan [Aĭ] : we shall “translate” a small analytic disc which is attached to a pair of transverse hypersurfaces. We know that the disc  $A_{q_1}$  has one half of its boundary attached to the smooth hypersurface  $v = H_{q_1}(z, u)$ . After a possible linear change of coordinates, we can assume that the other half is attached to another real hypersurface  $\Lambda_{q_1}$  of

equation  $v = G_{q_1}(z, u)$  smoothly depending on the parameter  $q_1$ . Indeed, since the half disc is transverse to  $\Sigma_{\gamma_{q_1}}$  along  $b^+\Delta$  and an embedding of  $\bar{\Delta}$  into  $\mathbb{C}^n$ , there exist infinitely many such hypersurfaces  $\Lambda_{q_1}$ . Furthermore, we can assume that  $A_{q_1}$  sends neighborhoods of  $i$  and  $-i$  in  $b\Delta$  into the intersection of the two hypersurfaces  $\Sigma_{\gamma_{q_1}} \cap \Lambda_{q_1}$ . Let  $\varphi^-$  and  $\varphi^+$  be two  $\mathcal{C}^\infty$ -smooth functions on  $b\Delta$  satisfying  $\varphi^- \equiv 0$ ,  $\varphi^+ \equiv 1$  on  $b^+\Delta$  and  $\varphi^- + \varphi^+ = 1$  on  $b\Delta$ . The fact that our disc is half attached to  $\Sigma_{\gamma_{q_1}}$  and half attached to  $\Lambda_{q_1}$  can be expressed by saying that

$$(6.12) \quad v_{q_1}(\zeta) = \varphi^+(\zeta) H_{q_1}(z_{q_1}(\zeta), u_{q_1}(\zeta)) + \varphi^-(\zeta) G_{q_1}(z_{q_1}(\zeta), u_{q_1}(\zeta)),$$

for all  $\zeta \in b\Delta$ . Since the two functions  $u_{q_1}$  and  $v_{q_1}$  on  $b\Delta$  are harmonic conjugates, the following (Bishop) equation is satisfied on  $b\Delta$  by  $u_{q_1}$  :

$$(6.13) \quad u_{q_1}(\zeta) = - [T_1(\varphi^+ H_{q_1}(z_{q_1}, u_{q_1}) + \varphi^- G_{q_1}(z_{q_1}, u_{q_1}))](\zeta).$$

We want to perturb these discs  $A_{q_1}$  by “translating” them along the complex tangential directions to  $\Sigma_{\gamma_{q_1}}$ . Introducing a new parameter  $\sigma \in \mathbb{C}^{n-1}$  with  $|\sigma| < \varepsilon$ , we can indeed include the discs  $A_{q_1}$  into a larger parameterized family  $A_{q_1, \sigma}$  by solving the following perturbed Bishop equation on  $b\Delta$  with parameters  $(q_1, \sigma)$  :

$$(6.14) \quad u_{q_1, \sigma}(\zeta) = - [T_1(\varphi^+ H_{q_1}(z_{q_1} + \sigma, u_{q_1, \sigma}) + \varphi^- G_{q_1}(z_{q_1} + \sigma, u_{q_1, \sigma}))](\zeta).$$

For instance, the existence and the  $\mathcal{C}^{k, \beta}$ -smoothness (with  $0 < \beta < \alpha$  arbitrary) of a solution  $u_{q_1, \sigma}$  to (6.14) follows from Tumanov’s work [Tu3]. Clearly the solution disc  $A_{q_1, \sigma}$  is half attached to  $\Sigma_{\gamma_{q_1}}$ . Differentiating the mapping  $\mathbb{C}^{n-1} \times b^+\Delta \ni (\sigma, \zeta) \mapsto (z_{p_1}(\zeta) + \sigma, u_{p_1, \sigma}(\zeta)) \in \Sigma_{\gamma_{p_1}}$  at the point  $0 \times 1$ , using the fact that  $A_{p_1}(b^+\Delta)$  is tangent to the  $u$ -axis at  $p_1$  (since  $\gamma_{p_1}$  is tangent to the  $u$ -axis at  $p_1$ ) which gives  $[\frac{d}{d\theta}(z_{p_1}(e^{i\theta}))]_{\theta=0} = 0$ , we obtain easily property **(3)** of the next statement. Notice that since the discs are  $\mathcal{C}^{k, \beta}$  for all  $k$ , and since the solution  $u_{q_1, \sigma}$  of the modified Bishop equation (6.14) is the same in  $\mathcal{C}^{k, \beta}$  and in  $\mathcal{C}^{l, \beta}$ , the discs  $A_{q_1, \sigma}$  are in fact of class  $\mathcal{C}^\infty$  with respect to all the variables.

**Lemma 6.15.** *The  $\mathcal{C}^\infty$ -smooth deformation (“translation” type) of analytic discs  $(q_1, \sigma, \zeta) \mapsto A_{q_1, \sigma}(\zeta)$  is defined for  $|q_1| < \varepsilon$  and for  $|\sigma| < \varepsilon$  and satisfies the following three properties :*

- (1)  $A_{q_1, 0} \equiv A_{q_1}$ .
- (2)  $A_{q_1, \sigma}(b^+\Delta) \subset \Sigma_{\gamma_{q_1}}$  for all  $\sigma$ .
- (3) *The mapping  $\mathbb{C}^{n-1} \times b^+\Delta \ni (\sigma, \zeta) \mapsto A_{p_1, \sigma}(\zeta) \in \Sigma_{\gamma_{p_1}}$  is a local  $\mathcal{C}^\infty$  diffeomorphism from a neighborhood of  $0 \times 1$  onto a neighborhood of  $A_{p_1}(1) = p_1$  in  $\Sigma_{\gamma_{p_1}}$ .*

**6.16. Preliminary to applying the continuity principle.** At first, we shall let the parameters  $(q_1, \sigma)$  range in certain new precise subdomains. We choose a positive  $\delta < \varepsilon$  with the property that the range of the mapping in **(3)** above, when restricted to  $\{|\sigma| < \delta\} \times b^+\Delta$ , contains the intersection of  $\Sigma_{\gamma_{p_1}}$  with a small polydisc  $\Delta_n(0, 2\eta)$ , for some  $\eta > 0$ . Recall that  $p_1$  is identified with the origin  $0 \in \mathbb{C}^n$ . Of course, there exists a constant  $c > 1$ , depending only on the Jacobian matrix of the mapping in **(3)** at  $0 \times 1$  such that  $c^{-1} \delta \leq \eta \leq c \delta$ . Let  $\Delta(1, \delta)$  denote the disc of radius  $\delta$  centered at  $1 \in \mathbb{C}$ . Furthermore, since the boundary of the disc  $A_{p_1, 0}$  is transversal to  $T_0^c \Sigma_{\gamma_{p_1}}$ , then after shrinking a bit  $\eta$  if necessary, we can assume that the set  $\{A_{p_1, \sigma}(\zeta) : |\sigma| < \delta, \zeta \in \Delta \cap \Delta(1, \delta)\}$  contains and foliates by half analytic discs the whole lower side  $\Delta_n(0, 2\eta) \cap \Sigma_{\gamma_{p_1}}^-$  (see FIGURE 6). Of course, the side  $\Sigma_{\gamma_{p_1}}^-$  is “the same side” as  $M^-$ , i.e. the side of  $\Sigma_{\gamma_{p_1}}$  where the greatest portion of  $D$  lies. However,  $D$  is in general *not* entirely contained in  $\Sigma_{\gamma_{p_1}}^-$ , because the Segre varieties  $S_{\bar{q}}$  for  $q \in \gamma_{p_1}$  may well intersect  $D$ .

As presented in §2, we now fix a neighborhood  $\Omega$  of  $M_1^-$  in  $\mathbb{C}^n$  to which all the components of the reflection function extend holomorphically. Such a neighborhood is provided by Lemma 5.10 above. Let  $\omega(\Sigma_{\gamma_{q_1}})$  be an arbitrary neighborhood of  $\Sigma_{\gamma_{q_1}}$  in  $\mathbb{C}^n$ . Our goal is to show that the envelope of holomorphy of  $\Omega \cup D \cup \omega(\Sigma_{\gamma_{q_1}})$  contains at least the lower side  $\Delta_n(0, \eta) \cap \Sigma_{\gamma_{q_1}}^-$  for all  $q_1$  small enough. We shall apply this to the components of the reflection function in §7 below.



By construction, the half parts  $A_{q_1, \sigma}(b^+ \Delta)$  are all contained in  $\Sigma_{\gamma_{q_1}}$ . It remains now to control the half parts  $A_{q_1, \sigma}(b^- \Delta)$ . Using the last property of Lemma 6.9, namely  $A_{q_1, 0}(b^- \Delta) \subset\subset D \cup M_1^-$ , it is clear that, after shrinking  $\delta$  if necessary, then we can insure that  $A_{q_1, \sigma}(b^- \Delta) \subset\subset D \cup \Omega$  for all  $|q_1| < \varepsilon$  and all  $|\sigma| < \delta$ . Of course, this shrinking will result in a simultaneous shrinking of  $\eta$ , and we still have the important inclusion relation :  $\{A_{p_1, \sigma}(\zeta) : |\sigma| < \delta, \zeta \in \Delta \cap \Delta(1, \delta)\} \supset \Delta_n(0, 2\eta) \cap \Sigma_{\gamma_{p_1}}^-$ . Finally, shrinking again  $\varepsilon$  if necessary, we then come to a situation that we may summarize :

**Lemma 6.17.** *For all  $|q_1| < \varepsilon$  and  $|\sigma| < \delta$ , we have :*

$$(6.18) \quad \begin{cases} \{A_{q_1, \sigma}(\zeta) : |\sigma| < \delta, \zeta \in \Delta \cap \Delta(1, \delta)\} \supset \Delta_n(0, \eta) \cap \Sigma_{\gamma_{q_1}}^-, \\ A_{q_1, \sigma}(b^+ \Delta) \subset \Sigma_{\gamma_{q_1}} \quad \text{and} \quad A_{q_1, \sigma}(b^- \Delta) \subset\subset D \cup \Omega, \end{cases}$$

Shrinking  $\varepsilon$  if necessary we can also insure that the intersection of  $D$  with  $\Delta_n(0, \eta) \cap \Sigma_{\gamma_{q_1}}^-$  is *connected* for all  $|q_1| < \varepsilon$ . Implicitly, we assume that  $\varepsilon \ll \delta$ , hence also  $\varepsilon \ll \eta$ .

**6.19. Envelopes of holomorphy.** We are now in position to state and to prove the main assertion of this paragraph. Especially, the following lemma will be applied to each member of the collection  $\{\Theta'_\beta(h(t))\}_{\beta \in \mathbb{N}^{n-1}}$  in §7 below.

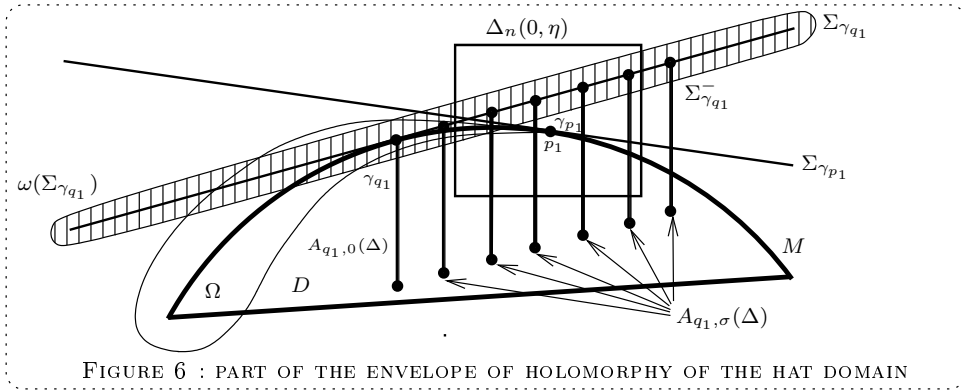

FIGURE 6 : PART OF THE ENVELOPE OF HOLOMORPHY OF THE HAT DOMAIN

**Lemma 6.20.** *Let  $\delta, \eta, \varepsilon > 0$  as above, namely satisfying  $\delta \simeq \eta$ ,  $\varepsilon \ll \delta$  and  $\varepsilon \ll \eta$ . If  $\delta > 0$  is sufficiently small, then the following holds. If a holomorphic function  $\psi \in \mathcal{O}(D \cup \Omega)$  extends holomorphically to a neighborhood  $\omega(\Sigma_{\gamma_{q_1}})$  in  $\mathbb{C}^n$ , then there exists a unique holomorphic function  $\Psi \in \mathcal{O}(D \cup [\Delta_n(0, \eta) \cap \Sigma_{\gamma_{q_1}}^-])$  such that  $\Psi|_D \equiv \psi$ .*

*Démonstration.* This is an application of the Behnke-Sommer Kontinuitätssatz (see FIGURE 6). Let  $q_1$  with  $|q_1| < \varepsilon$ . We shall explain later how we choose  $\delta > 0$  sufficiently small. Let  $\psi \in \mathcal{O}(D \cup \Omega)$ . By assumption, there exists a holomorphic function  $\psi_\omega \in \mathcal{O}(\omega(\Sigma_{\gamma_{q_1}}))$  such that  $\psi_\omega = \psi$  in a neighborhood of  $\gamma_{q_1}([- \rho/2, \rho/2]) \cap \Delta_n(0, \rho/3)$  in  $\mathbb{C}^n$ . First of all, we must construct a domain  $B_{q_1} \subset D \cup \Omega$  sufficiently large such that  $\psi$  and  $\psi_\omega$  stick together in a unique holomorphic function defined in the union  $B_{q_1} \cup \omega(\Sigma_{\gamma_{q_1}})$ . To get this extension property, we need that  $B_{q_1} \cap \omega(\Sigma_{\gamma_{q_1}})$  be connected. For this to hold, we construct (equivalently, we shrink) the neighborhood  $\omega(\Sigma_{\gamma_{q_1}})$  as a union of polydiscs of very small constant radius centered at points of  $\Sigma_{\gamma_{q_1}}$ . Next, we construct in two parts  $B_{q_1}$  as follows. The first part of  $B_{q_1}$  consists of a small neighborhood of  $A_{q_1, 0}(\overline{\Delta})$  in  $\mathbb{C}^n$ , for instance a union of small polydiscs centered at points of  $A_{q_1, 0}(\overline{\Delta})$  which are of constant very small radius in order to be contained in  $D \cup \Omega$ . The second part of  $B_{q_1}$  consists of three subparts, namely the union of polydiscs of radius  $2\delta$  centered at points of  $A_{p_1}(b^- \Delta)$ , at points of  $A_{p_1}(b^+ \Delta) \cap \gamma_{p_1}([- \rho/2, -\rho/4])$  and at points of  $A_{p_1}(b^+ \Delta) \cap \gamma_{p_1}([\rho/4, \rho/2])$ . This part is the same for all  $B_{q_1}$ . By Lemma 6.4(2), if  $\delta$  is small enough, the second part of  $B_{q_1}$  will be contained in  $D \cup \Omega$ . This is how we choose

$\delta > 0$  small enough. Moreover, because  $A_{p_1}(\overline{\Delta})$  are non-tangentially half-attached to  $\Sigma_{\gamma_{q_1}}$  along  $b^+\Delta$ , the intersection  $B_{q_1} \cap \omega(\Sigma_{\gamma_{q_1}})$  is connected. So we get a well defined semi-local holomorphic extension, again denoted by  $\psi \in \mathcal{O}(B_{q_1} \cup \omega(\Sigma_{\gamma_{q_1}}))$ . Geometrically speaking, this domain  $B_{q_1} \cup \omega(\Sigma_{\gamma_{q_1}})$  is a kind of curved Hartogs domain. We claim that such a function  $\psi$  extends holomorphically to a neighborhood of the union of disc  $A_{q_1,\sigma}(\overline{\Delta})$  for  $|\sigma| < \delta$ . Indeed, we first observe that for all  $|q_1| < \varepsilon$  and  $|\sigma| < \delta$ , the boundaries  $A_{q_1,\sigma}(b\Delta)$  are contained in this domain  $B_{q_1} \cup \omega(\Sigma_{\gamma_{q_1}})$ . This is evident for the half boundaries  $A_{q_1,\sigma}(b^+\Delta)$  which are contained in  $\Sigma_{\gamma_{q_1}}$  by Lemma 6.15(2). On the other hand, the boundaries  $A_{q_1,\sigma}(b^-\Delta)$  stay within a distance of order say  $3\delta/2$  with respect to the boundary  $A_{p_1}(b^-\Delta)$ , by the very construction of the smooth family  $A_{q_1,\sigma}$ , which proves the claim. We remind the notion of *analytic isotopy* of analytic discs ([Me2, Definition 3.1]) which is useful in applying the continuity principle. For fixed  $q_1$  and for varying  $\sigma$ , all the discs  $A_{q_1,\sigma}$  are analytically isotopic to each other with their boundaries lying in  $B_{q_1} \cup \omega(\Sigma_{\gamma_{q_1}})$ . Moreover, for  $\sigma = 0$ , we obviously see that  $A_{q_1,0}$  is analytically isotopic to a point in the domain  $B_{q_1} \cup \omega(\Sigma_{\gamma_{q_1}})$ , just by the trivial isotopy  $(r, \zeta) \mapsto A_{q_1,0}(r\zeta)$  with values in the neighborhood  $\omega(A_{q_1,0}(\overline{\Delta})) \subset B_{q_1}$ . By Lemma 3.2 in [Me2], it follows that  $\psi$  restricted to a neighborhood of  $A_{q_1,\sigma}(b\Delta)$  extends holomorphically to a neighborhood of  $A_{q_1,\sigma}(\overline{\Delta})$  in  $\mathbb{C}^n$ , for all  $|\sigma| < \delta$ . Furthermore, thanks to the fact that the map  $(\zeta, \sigma) \mapsto A_{q_1,\sigma}(\zeta)$  is an embedding, we get a well defined holomorphic extension  $\psi_{q_1}$  of  $\psi$  to the union  $C_{q_1} := \cup_{|\sigma| < \delta} A_{q_1,\sigma}(\Delta \cap \Delta(1, \delta))$ . Of course, this extension coincides with the old  $\psi \in \mathcal{O}(D \cup \Omega)$  in a neighborhood of the intersection of the half boundary  $A_{q_1,0}(b^+\Delta)$  with  $C_{q_1}$ . Since  $C_{q_1} \cap D$  is connected and since  $C_{q_1}$  contains  $\Delta_n(0, \eta) \cap \Sigma_{\gamma_{q_1}}^-$  by Lemma 6.17, after sticking  $\psi$  with  $\psi_{q_1}$ , we get the desired holomorphic extension  $\Psi \in \mathcal{O}(D \cup [\Delta_n(0, \eta) \cap \Sigma_{\gamma_{q_1}}^-])$ . The proof of Lemma 6.20 is complete.  $\square$

## §7. HOLOMORPHIC EXTENSION TO A LEVI-FLAT UNION OF SEGRE VARIETIES

**7.1. Straightenings.** For each parameter  $q'_1$ , we consider the real analytic arc  $\gamma'_{q'_1}$  defined by (6.2). To this family of analytic arcs we can associate a family of straightened coordinates as follows.

**Lemma 7.2.** *For varying  $q'_1 \in M'$  with  $|q'_1| < \varepsilon' \ll \rho'$ , there exists a real analytically parameterized family of biholomorphic mappings  $\Phi'_{q'_1}$  of  $\Delta_n(0, \rho'/2)$  sending  $q'_1$  to the origin and straightening  $\gamma'_{q'_1}$  to the  $u'$ -axis, such that the image  $M'_{q'_1} := \Phi'_{q'_1}(M')$  is a closed real analytic hypersurface of  $\Delta_n(0, \rho'/2)$  close to  $M'$  in the real analytic norm which is given by an equation of the form  $\bar{w}' = \Theta'_{q'_1}(\bar{z}', t')$ , with  $\Theta'_{q'_1}(\bar{z}', t')$  converging normally in the polydisc  $\Delta_{2n-1}(0, \rho'/2)$  and satisfying  $\Theta'_{q'_1}(0, 0, w') \equiv w'$  and  $\Theta'_{q'_1}(\bar{z}', t') = w' + \mathcal{O}(2)$ .*

**7.3. Different reflection functions.** Let us developpe these defining equations in the form :

$$(7.4) \quad \bar{w}' = \Theta'_{q'_1}(\bar{z}', t') = \sum_{\beta \in \mathbb{N}^{n-1}} (\bar{z}')^\beta \Theta'_{q'_1, \beta}(t').$$

Here,  $\Theta'_{q'_1, 0}(0, w') \equiv w'$ . We denote by  $h_{q'_1} = (f_{q'_1}, g_{q'_1})$  the mapping in these coordinate systems. To every such system of coordinates, we associate *different reflection functions* by setting :

$$(7.5) \quad \mathcal{R}'_{q'_1, h_{q'_1}}(t, \bar{v}') := \bar{\mu}' - \sum_{\beta \in \mathbb{N}^{n-1}} \bar{\lambda}'^\beta \Theta'_{q'_1, \beta}(h_{q'_1}(t)).$$

**7.6. Holomorphic extension to a Levi-flat hat.** Recall from §6.5 that the Levi-flat hypersurfaces  $\Sigma_{\gamma_{q_1}}$  are defined to be the union of the Segre varieties  $S_{\bar{q}}$  associated to points  $q$  varying in  $\gamma_{q_1}$ , intersected with the polydisc  $\Delta_n(0, \rho/3)$ . Here, we establish our main crucial observation.

**Lemma 7.7.** *If  $q_1$  with  $|q_1| < \varepsilon$  belongs to  $M_1^-$ , then all the components  $\Theta'_{q_1, \beta}(h(t))$  extend as CR functions of class  $\mathcal{C}^\infty$  over  $\Sigma_{\gamma_{q_1}} \cap \Delta_n(0, \rho/3)$ .*

*Démonstration.* Let  $\bar{L}_1, \dots, \bar{L}_{n-1}$  be the commuting basis of  $T^{0,1}M$  given by  $\bar{L}_j = \frac{\partial}{\partial \bar{z}_j} + \Theta_{\bar{z}_j}(\bar{z}, t) \frac{\partial}{\partial \bar{w}}$ , for  $1 \leq j \leq n-1$ . Clearly, the coefficients of these vectors fields converge normally in the polydisc  $\Delta_{2n-1}(0, \rho)$ . By the diffeomorphism assumption, we have  $\det(\bar{L}_j \overline{f_{q_1, k}}(0))_{1 \leq j, k \leq n-1} \neq 0$ . At points  $(t, \bar{t})$  with  $t \in M \cap \Delta_n(0, \rho/3)$ , we shall denote this determinant by :

$$(7.8) \quad \det(\bar{L}_j \overline{f_{q_1, k}}(\bar{t}))_{1 \leq j, k \leq n-1} := \underline{\mathcal{D}}(t, \bar{t}, \{\partial_{\bar{t}_l} \overline{f_{q_1, k}}(\bar{t})\}_{1 \leq l \leq n, 1 \leq k \leq n-1}).$$

Here, by its very definition, the function  $\underline{\mathcal{D}}$  is holomorphic in its variables. Replacing  $w$  by  $\bar{\Theta}(z, \bar{t})$  in  $\underline{\mathcal{D}}$ , we can write  $\underline{\mathcal{D}}$  in the form  $\mathcal{D}(z, \bar{t}, \{\partial_{\bar{t}_l} \overline{f_{q_1, k}}(\bar{t})\}_{1 \leq l \leq n, 1 \leq k \leq n-1})$ , where  $\mathcal{D}$  is holomorphic in its variables. Shrinking  $\rho > 0$  if necessary, we may assume that for all fixed point  $\bar{t}_q \in M$  with  $|\bar{t}_q| < \rho/3$ , then :

(1) *The polarization  $\mathcal{D}(z, \bar{t}_q, \{\partial_{\bar{t}_l} \overline{f_{q_1, k}}(\bar{t}_q)\}_{1 \leq l \leq n, 1 \leq k \leq n-1})$  is convergent on the Segre variety  $S_{\bar{t}_q} \cap \Delta_n(0, \rho/3) = \{(z, w) \in \Delta_n(0, \rho/3) : w = \bar{\Theta}(z, \bar{t}_q)\}$ , i.e. it is convergent with respect to  $z \in \mathbb{C}^{n-1}$  for all  $|z| < \rho/3$ .*

(2) *This expression  $\mathcal{D}(z, \bar{t}_q, \{\partial_{\bar{t}_l} \overline{f_{q_1, k}}(\bar{t}_q)\}_{1 \leq l \leq n, 1 \leq k \leq n-1})$  does not vanish at any point of the Segre variety  $S_{\bar{t}_q} \cap \Delta_n(0, \rho/3)$ , i.e. it does not vanish for all  $|z| < \rho/3$ .*

Let us choose  $q'_1$  satisfying  $\gamma'_{q'_1} \subset M_1^-$ , with  $|q'_1| < \varepsilon'$ . We pick the corresponding parameter  $q_1 := h^{-1}(q'_1)$  with  $|q_1| < \varepsilon$ . By the choice of  $\Phi'_{q'_1}$ , we then have  $f_{q'_1}(\gamma_{q'_1}(s)) = 0$  for all  $s \in \mathbb{R}$  with  $|s| \leq \rho/2$ . *This property will be really crucial.* As the mapping  $h_{q'_1}$  is of class  $\mathcal{C}^\infty$  over  $M$ , we can apply the tangential Cauchy-Riemann derivations  $\bar{L}_1^{\beta_1} \cdots \bar{L}_{n-1}^{\beta_{n-1}}$ ,  $\beta \in \mathbb{N}^{n-1}$  of order  $|\beta|$  infinitely many times to the identity :

$$(7.9) \quad \overline{g_{q'_1}}(\bar{t}) = \Theta'_{q'_1}(\overline{f_{q'_1}}(\bar{t}), h_{q'_1}(\bar{t})).$$

which holds for  $t \in M \cap \Delta_n(0, \rho)$ . To begin with, we first apply the CR derivations  $\bar{L}_j$  to this identity (7.9). This yields

$$(7.10) \quad \bar{L}_j \overline{g_{q'_1}}(\bar{t}) = \sum_{k=1}^{n-1} \bar{L}_j \overline{f_{q'_1, k}}(\bar{t}) \frac{\partial \Theta'_{q'_1}}{\partial \bar{z}'_k}(\overline{f_{q'_1}}(\bar{t}), h_{q'_1}(\bar{t})).$$

Applying Cramer's rule as in the proofs of Lemmas 3.22 and 4.7, we see that there exist holomorphic functions  $\mathcal{T}_k$  in their arguments such that

$$(7.11) \quad \frac{\partial \Theta'_{q'_1}}{\partial \bar{z}'_k}(\overline{f_{q'_1}}(\bar{t}), h_{q'_1}(\bar{t})) = \frac{\mathcal{T}_k(z, \bar{t}, \{\partial_{\bar{t}_l} \overline{h_{q'_1, j}}(\bar{t})\}_{1 \leq l, j \leq n})}{\mathcal{D}(z, \bar{t}, \{\partial_{\bar{t}_l} \overline{f_{q'_1, k}}(\bar{t})\}_{1 \leq l \leq n, 1 \leq k \leq n-1})}.$$

By CR differentiating further the identities (7.11), using Cramer's rule at each step and making inductive arguments, it follows that for every multi-index  $\beta \in \mathbb{N}_*^{n-1}$ , there exist holomorphic functions  $\mathcal{T}_\beta$  in their variables such that

$$(7.12) \quad \left\{ \begin{array}{l} \Theta'_{q'_1, \beta}(h_{q'_1}(t)) + \sum_{\gamma \in \mathbb{N}_*^{n-1}} (\overline{f_{q'_1}}(t))^\gamma \Theta'_{q'_1, \beta + \gamma}(h_{q'_1}(t)) \frac{(\beta + \gamma)!}{\beta! \gamma!} = \\ \frac{\mathcal{T}_\beta(z, \bar{t}, \{\partial_{\bar{t}_l} \overline{h_{q'_1, j}}(\bar{t})\}_{1 \leq j \leq n, |\gamma| \leq |\beta|})}{[\mathcal{D}(z, \bar{t}, \{\partial_{\bar{t}_l} \overline{f_{q'_1, k}}(\bar{t})\}_{1 \leq l \leq n, 1 \leq k \leq n-1})]^{2|\beta| - 1}}. \end{array} \right.$$

Precisely, the terms  $\mathcal{T}_\beta$  are holomorphic with respect to  $(z, \bar{t})$  and relatively polynomial with respect to the jets  $\{\partial_{\bar{t}_l} \overline{h_{q'_1, j}}(\bar{t})\}_{1 \leq j \leq n, |\gamma| \leq |\beta|}$ . Also, the variable  $t$  runs in  $M$  in a neighborhood of  $\gamma_{q_1}(s)$ . Now, we remind that by Lemma 5.10, all the functions  $t \mapsto \Theta'_{q'_1, \beta}(h_{q'_1}(t))$  are already holomorphically extendable to a neighborhood of  $\gamma_{q_1}$  in  $\mathbb{C}^n$ , since  $\gamma_{q_1} \subset M_1^-$ . Let us denote by  $\theta'_{q'_1, \beta}(t)$  these holomorphic extensions. We shall first prove Lemma 7.7 in the simpler case where  $M'$  is holomorphically nondegenerate, in which case the mapping  $h$  in fact extends holomorphically to a neighborhood of  $M_1^-$  in  $\mathbb{C}^n$ . In this case, for every point  $q \in \gamma_{q_1}$

of the form  $q = \gamma_{q_1}(s)$ , the terms in the right hand side of (7.12) extend holomorphically to a neighborhood  $(q, \bar{q})$  of the complexification  $\mathcal{M}$  of  $M$ , which is the complex hypersurface in  $\mathbb{C}^n \times \mathbb{C}^n$  given by the defining equation  $w = \bar{\Theta}(z, \tau)$ . So, for  $(t, \tau)$  close to  $(q, \bar{q})$ , we can complexify (7.12), replacing  $\bar{t}$  by  $\tau$  and  $t$  by  $(z, \bar{\Theta}(z, \tau))$ , which yields an identity between holomorphic functions :

$$(7.13) \quad \left\{ \begin{array}{l} \Theta'_{q'_1, \beta}(h_{q'_1}(z, \bar{\Theta}(z, \tau))) + \sum_{\gamma \in \mathbb{N}_*^{n-1}} (\overline{f_{q'_1}}(\tau))^\gamma \Theta'_{q'_1, \beta + \gamma}(h_{q'_1}(z, \bar{\Theta}(z, \tau))) \frac{(\beta + \gamma)!}{\beta! \gamma!} \equiv \\ \equiv \frac{\mathcal{T}_\beta(z, \tau, \{\partial_\tau^\gamma \overline{h_{q'_1, j}}(\tau)\}_{1 \leq j \leq n, |\gamma| \leq |\beta|})}{[\mathcal{D}(z, \tau, \{\partial_{\tau_i} \overline{f_{q'_1, k}}(\tau)\}_{1 \leq i \leq n, 1 \leq k \leq n-1})]^{2|\beta|-1}}. \end{array} \right.$$

Next, we put  $\tau := \bar{t}_q = \overline{\gamma_{q_1}(s)}$ , whence  $t$  belongs to the Segre variety  $S_{\bar{q}}$ , namely  $t = (z, \bar{\Theta}(z, \bar{t}_q))$ , where the variable  $z$  is free. From the important fact that  $\overline{f_{q'_1}}(\bar{t}_q) = 0$ , because  $h(q)$  belongs to  $\gamma'_{q'_1}$ , it follows that *the queue sum*  $\sum_{\gamma \in \mathbb{N}_*^{n-1}}$  in (7.13) *disappears*. Consequently, we get the following identity on  $S_{\bar{q}}$  for  $z$  close to  $z_q$  :

$$(7.14) \quad \Theta'_{q'_1, \beta}(h_{q'_1}(z, \bar{\Theta}(z, \bar{t}_q))) \equiv \frac{\mathcal{T}_\beta(z, \bar{t}_q, \{\partial_{\bar{t}}^\gamma \overline{h_{q'_1, j}}(\bar{t}_q)\}_{1 \leq j \leq n, |\gamma| \leq |\beta|})}{[\mathcal{D}(z, \bar{t}, \{\partial_{\bar{t}_i} \overline{f_{q'_1, k}}(\bar{t}_q)\}_{1 \leq i \leq n, 1 \leq k \leq n-1})]^{2|\beta|-1}}.$$

The crucial observation now is that the right hand side of (7.14) converges over a much longer part of the Segre variety  $S_{\bar{q}}$ . Indeed, by **(1)** after (7.8), it converges for  $|z| < \rho/3$ . Furthermore, the right hand side of (7.14) varies in a  $\mathcal{C}^\infty$  way when  $\bar{t}_q$  varies on  $\gamma_{q_1}$ . This proves Lemma 7.7 in the case where  $h$  extends holomorphically to a neighborhood of  $M_1^-$  in  $\mathbb{C}^n$ , which holds true for instance when  $M'$  is holomorphically nondegenerate.

In the general case, it is no longer true that  $h$  extends holomorphically to a neighborhood of  $M_1^-$  in  $\mathbb{C}^n$ , so different arguments are required. Let  $q \in \gamma_{q_1}$  be arbitrary. By assumption, the components  $\Theta'_{q'_1, \beta}(h_{q'_1}(t))$  extend holomorphically to a neighborhood of  $q$  in  $\mathbb{C}^n$  as holomorphic functions  $\theta'_{q'_1, \beta}(t)$  defined, say in the polydisc  $\{|t - t_q| < \sigma_q\}$ , for small  $\sigma_q > 0$ . By expanding  $h_{q'_1}$  in formal power series at  $q$ , we get a series  $H_{q'_1}(t_q + (t - t_q)) \in \mathbb{C}[[t - t_q]]^n$ . Also, we may expand  $\theta'_{q'_1, \beta}(t_q + (t - t_q)) \in \mathbb{C}\{t - t_q\}$ . Then we have the following formal power series identities

$$(7.15) \quad \Theta'_{q'_1, \beta}(H_{q'_1}(t_q + (t - t_q))) \equiv \theta'_{q'_1, \beta}(t_q + (t - t_q))$$

in  $\mathbb{C}[[t - t_q]]$  for all  $\beta$ . Since the Taylor series of  $(h_{q'_1}, \overline{h_{q'_1}})$  at  $(t_q, \bar{t}_q)$  induces a formal CR mapping between the complexifications  $\mathcal{M}$  centered at  $(q, \bar{q})$  and the complexification  $\mathcal{M}'$  centered at  $(q', \bar{q}')$ , it follows that we can write the following formal power series identities valuable in  $\mathbb{C}[[t - t_q, \tau - \bar{t}_q]]$  for  $(t_q + (t - t_q), \bar{t}_q + (\tau - \bar{t}_q))$  in  $\mathcal{M}$  :

$$(7.16) \quad \left\{ \begin{array}{l} \Theta'_{q'_1, \beta}(H_{q'_1}(t_q + (t - t_q))) + \\ + \sum_{\gamma \in \mathbb{N}_*^{n-1}} \Theta'_{q'_1, \beta + \gamma}(H_{q'_1}(t_q + (t - t_q))) \overline{F_{q'_1}}(\bar{t}_q + (\tau - \bar{t}_q))^\gamma \equiv \\ \equiv \frac{\mathcal{T}_\beta(z_q + (z - z_q), \bar{t}_q + \tau - \bar{t}_q, \{\partial_\tau^\gamma \overline{H_{q'_1, j}}(\bar{t}_q + (\tau - \bar{t}_q))\}_{1 \leq j \leq n, |\gamma| \leq |\beta|})}{[\mathcal{D}(z_q + (z - z_q), \bar{t}_q + (\tau - \bar{t}_q), \{\partial_{\tau_i} \overline{F_{q'_1, k}}(\bar{t}_q + (\tau - \bar{t}_q))\}_{1 \leq i \leq n, 1 \leq k \leq n-1})]^{2|\beta|-1}}. \end{array} \right.$$

Putting  $\tau := \bar{t}_q$  in (7.16), taking (7.15) into account, and using the important fact that  $\overline{F_{q'_1}}(\bar{t}_q) = 0$ , we get the formal power series identities between two holomorphic functions which are valuable for  $|z - z_q| < \sigma_q$  in  $\mathbb{C}\{z - z_q\}$  and for all  $\beta$  :

$$(7.17) \quad \left\{ \begin{array}{l} \theta'_{q'_1, \beta}(z_q + (z - z_q), \bar{\Theta}(z_q + (z - z_q), \bar{t}_q)) \equiv \\ \equiv \frac{\mathcal{T}_\beta(z_q + (z - z_q), \bar{t}_q, \{\partial_{\bar{t}}^\gamma \overline{h_{q'_1, j}}(\bar{t}_q)\}_{1 \leq j \leq n, |\gamma| \leq |\beta|})}{[\mathcal{D}(z_q + (z - z_q), \bar{t}_q, \{\partial_{\bar{t}_i} \overline{f_{q'_1, k}}(\bar{t}_q)\}_{1 \leq i \leq n, 1 \leq k \leq n-1})]^{2|\beta|-1}}. \end{array} \right.$$

Consequently, we get on  $S_{\bar{q}}$  the following identities between holomorphic functions of  $z$  valuable for  $|z - z_q| < \sigma_q$  and for all  $\beta$  :

$$(7.18) \quad \theta'_{q'_1, \beta}(z, \bar{\Theta}(z, \bar{t}_q)) \equiv \frac{\mathcal{T}_\beta(z, \bar{t}_q, \{\partial_{\bar{t}}^2 \overline{h_{q'_1, j}(\bar{t}_q)}\}_{1 \leq j \leq n, |\gamma| \leq |\beta|})}{[\mathcal{D}(z, \bar{t}_q, \{\partial_{\bar{t}_i} \overline{f_{q'_1, k}(\bar{t}_q)}\}_{1 \leq i \leq n, 1 \leq k \leq n-1})]^{2|\beta|-1}}.$$

As in the holomorphically nondegenerate case, we see that the right hand side of (7.18) converges for  $|z| < \rho/3$ , so the holomorphic functions  $\theta'_{q'_1, \beta}(z, \bar{\Theta}(z, \bar{t}_q))$  converge in a long piece of the Segre variety  $S_{\bar{q}}$ . The  $\mathcal{C}^\infty$ -smoothness of the right hand side extension over  $\Sigma_{\gamma_{q_1}} \cap \Delta_n(0, \rho/3)$  yields a CR extension to  $\Sigma_{\gamma_{q_1}}$  which is of class  $\mathcal{C}^\infty$ . This completes the proof of Lemma 7.7.  $\square$

**Lemma 7.19.** *If  $q_1$  with  $|q_1| < \varepsilon$  belongs to  $M_1^-$ , then all the components  $\Theta'_{q'_1, \beta}(h_{q'_1}(t))$  of the reflection function  $\mathcal{R}_{q'_1, h_{q'_1}}$  extend as holomorphic functions to a neighborhood  $\omega(\Sigma_{\gamma_{q_1}})$  of  $\Sigma_{\gamma_{q_1}}$  in  $\mathbb{C}^n$ .*

*Démonstration.* By the hypotheses of Theorem 5.5 and by Lemma 5.10, we remind the reader that the components  $\Theta'_{q'_1, \beta}(h_{q'_1}(t))$  already extend holomorphically to a neighborhood  $\omega(\gamma_{q_1}) \subset \Omega$  of  $\gamma_{q_1} \subset M_1^-$  in  $\mathbb{C}^n$  as the holomorphic functions  $\theta'_{q'_1, \beta}(t)$ . Thanks to Lemma 7.7, the statement follows by an application of the following known propagation result :  $\square$

**Lemma 7.20.** *Let  $\Sigma$  be a  $\mathcal{C}^\infty$ -smooth Levi-flat hypersurface in  $\mathbb{C}^n$  ( $n \geq 2$ ) foliated by complex hypersurfaces  $\mathcal{F}_\Sigma$ . If a continuous CR function  $\psi$  defined on  $\Sigma$  extends holomorphically to a neighborhood  $\mathcal{U}_p$  of a point  $p$  belonging to a leaf  $\mathcal{F}_\Sigma$  of  $\Sigma$ , then  $\psi$  extends holomorphically to a neighborhood  $\omega(\mathcal{F}_\Sigma)$  of  $\mathcal{F}_\Sigma$  in  $\mathbb{C}^n$ . The size of this neighborhood  $\omega(\mathcal{F}_\Sigma)$  depends on the size of  $\mathcal{U}_p$  and is stable under sufficiently small (even non-Levi-flat) perturbations of  $\Sigma$ .*

*Démonstration.* The first part of this statement was first proved by Hanges and Treves ([HaTr]) using microlocal concepts, the FBI transform and controlled deformations of manifolds. Interesting generalizations were given by Sjöstrand and by Trépreau ([Tr2]) in arbitrary codimension. Another proof using deformations of analytic discs has been provided by Tumanov ([Tu2]). Both proofs are constructive and the second statement about the size of the neighborhoods to which extension holds follows after a careful inspection of the techniques therein. Since it is superfluous to repeat the arguments word by word, we do not enter the details.  $\square$

## §8. RELATIVE POSITION OF THE NEIGHBOURING SEGRE VARIETIES

**8.1. Intersection of Segre varieties.** We are now in position to complete the proof of Theorem 5.5, hence to achieve the proof of Theorem 1.9. It remains to show that the functions  $\Theta'_{q'_1, \beta}$  extend holomorphically at  $p_1$ , for  $\gamma_{q_1}$  chosen conveniently. For this choice, we are led to the following dichotomy : either  $S_{\bar{p}_1} \cap M_1^- = \emptyset$  in a sufficiently small neighborhood of  $p_1$  or there exists a sequence  $(q_k)_{k \in \mathbb{N}}$  of points of  $S_{\bar{p}_1} \cap M_1^-$  tending towards  $p_1$ . In the first case, we shall distinguish two sub-cases. Either  $S_{\bar{p}_1}$  lies below  $M_1^-$  or it lies above  $M_1^-$ . Let us write this more precisely. We may choose a  $\mathcal{C}^\infty$ -smooth hypersurface  $H_1$  transverse to  $M$  at  $p_1$  with  $H_1$  satisfying  $H_1 \cap M = M_1$  and  $H_1^- \cap M = M_1^-$  (see FIGURE 7). Thus  $H_1$  together with  $M$  divides  $\mathbb{C}^n$  near 0 in four connected parts. More precisely, we say that either  $S_{\bar{p}_1} \cap H_1^-$  is contained in the lower left quadrant  $H_1^- \cap M^- = H_1^- \cap D$  or it is contained in the upper left quadrant  $H_1^- \cap M^+$ . To summarize, we have distinguished three possible cases :

**Case I.** The half Segre variety  $S_{\bar{p}_1} \cap H_1^-$  cuts  $M_1^-$  along an infinite sequence of points  $(q_k)_{k \in \mathbb{N}}$  tending towards  $p_1$ .

**Case II.** The half Segre variety  $S_{\bar{p}_1} \cap H_1^-$  does not intersect  $M_1^-$  in a neighborhood of  $p_1$  and it passes under  $M_1^-$ , namely inside  $D$ .

**Case III.** The half Segre variety  $S_{\bar{p}_1} \cap H_1^-$  does not intersect  $M_1^-$  in a neighborhood of  $p_1$  and it passes over  $M_1^-$ , namely over  $D \cup M_1^-$ .

In the first two cases, for every point  $q_1$  close enough to  $p_1$ , the Segre variety  $S_{\bar{q}_1}$  will intersect  $D \cup \Omega$  and the neighborhoods  $\omega(\Sigma_{\gamma_{q_1}})$  constructed in Lemma 7.20 will always contain the point  $p_1$  (we give more arguments below). The third case could be *a priori* the most delicate one. But we can already delineate the following crucial geometric property, which says that Lemma 6.20 will apply.

**Lemma 8.2.** *If  $S_{\bar{p}_1} \cap H_1^-$  is contained in  $M^+$ , then  $p_1$  lies in the lower side  $\Sigma_{\gamma_{q_1}}^-$  for every arc  $\gamma_{q_1} \subset M_1^-$  of the family (6.2).*

*Démonstration.* In normal coordinates  $t$  vanishing at  $p_1$ , the real equation of  $M$  is given by  $v = \varphi(z, \bar{z}, u)$ , where  $\varphi$  is a certain converging real power series satisfying  $\varphi(0) = 0$ ,  $d\varphi(0) = 0$  and  $\varphi(z, 0, u) \equiv 0$ . We can assume that  $dh(0) = \text{Id}$ . We can assume that the “minus” side  $D \equiv M^-$  of automatic extension of CR functions is given by  $\{v < \varphi(z, \bar{z}, u)\}$ . Replacing  $u$  by  $(w + \bar{w})/2$  and  $v$  by  $(w - \bar{w})/2i$ , and solving with respect to  $w$ , we get for  $M$  an equation as above, say  $w = \bar{w} + i\Xi(z, \bar{t})$ , with  $\Xi(0, \bar{t}) \equiv 0$ . We have  $\Theta(z, \bar{t}) \equiv \bar{w} + i\Xi(z, \bar{t})$  in our previous notation. We claim that every such arc  $\gamma_{q_1} \subset M_1^-$  contains a point  $p \in M_1^-$  whose coordinates are of the form  $(z_p, 0 + i\varphi(z_p, \bar{z}_p, 0))$ . Indeed, by construction, the arcs  $\gamma_{q_1}$  are all elongated along the  $u$ -coordinate axis, since it is so for  $\gamma'_{q'_1}$  and since  $dh(0) = \text{Id}$ . In normal coordinates, the Segre variety  $S_{\bar{p}_1}$  passing through the origin  $p_1$  has the simple equation  $\{w = 0\}$ . By assumption, the point  $(z_p, 0) \in S_{\bar{p}_1}$  lies over  $M$  in  $M^+$ , so we have  $\varphi(z_p, \bar{z}_p, 0) < 0$ . Then the Segre variety  $S_{\bar{p}}$  (which is a leaf of  $\Sigma_{\gamma_{q_1}}$ ), has the equation  $w = -i\varphi(z_p, \bar{z}_p, 0) + i\Xi(z, \bar{z}_p, -i\varphi(z_p, \bar{z}_p, 0))$ . Therefore, the intersection point  $\{z = 0\} \cap S_{\bar{p}} \subset \Sigma_{\gamma_{q_1}}$  has coordinates equal to  $(0, -i\varphi(z_p, \bar{z}_p, 0))$ . This point clearly lies above the origin  $p_1$ , so  $p_1$  lies in the lower side  $\Sigma_{\gamma_{q_1}}^-$ , which completes the proof of Lemma 8.2.  $\square$

**8.3. Extension across  $(M, 0)$  of the components  $\Theta'_{q'_1, \beta}$ .** We are now prepared to complete the proof of Theorems 5.5 and 1.9. We first choose  $\delta, \eta, \varepsilon$  and various points  $|q_1| < \varepsilon$  as in Lemma 6.20 and we consider the two associated arcs  $\gamma_{q_1}$  and  $\gamma'_{q'_1}$ , the associated mapping  $h_{q'_1}$  and the associated reflection function  $\mathcal{R}'_{q'_1, h_{q'_1}}$ . By Lemma 6.20, for each such choice of  $q_1$ , then all the components  $\Theta'_{q'_1, \beta}$  extend holomorphically to  $D \cup [\Sigma_{\gamma_{q_1}}^- \cap \Delta_n(0, \eta)]$ . Our goal is to show that for suitably chosen  $\gamma_{q_1}$  in Cases I, II and III, then the components  $\Theta'_{q'_1, \beta}$  extend holomorphically to a neighborhood of  $p_1$ . Afterwards, thanks to Artin’s approximation theorem, the Cauchy estimates are automatic, as explained in Lemma 3.16.

**8.4. Case I.** In Case I, we choose one of the points  $q_k \in M_1^- \cap S_{\bar{p}_1}$  which is arbitrarily close to  $p_1$  and we denote it simply by  $q_1$ . We can assume that  $|q_1| < \varepsilon$ . Next, we consider the associated arc  $\gamma_{q_1}$ . By an application of Lemma 7.19, all the components  $\Theta'_{q'_1, \beta}(h_{q'_1}(t))$  of the reflection function  $\mathcal{R}'_{q'_1, h_{q'_1}}$  extend holomorphically to a neighborhood  $\omega(\Sigma_{\gamma_{q_1}})$  of  $\Sigma_{\gamma_{q_1}}$  in  $\mathbb{C}^n$ . Of course, this neighborhood contains the point  $p_1 \in S_{\bar{q}_1} \subset \Sigma_{\gamma_{q_1}}$ . However, because of possible pluridromy, the extension at  $p_1$  might well differ from the extension in the one-sided neighborhood  $D$  near  $p_1$ . Fortunately, thanks to Lemma 6.20, all these holomorphic functions extend holomorphically in a unique way to  $D \cup [\Sigma_{\gamma_{q_1}}^- \cap \Delta_n(0, \eta)]$ . The neighborhood  $\omega(\Sigma_{\gamma_{q_1}})$  being constructed as a certain union of polydiscs of small radius, it is geometrically smooth, so its intersection with  $D \cup [\Sigma_{\gamma_{q_1}}^- \cap \Delta_n(0, \eta)]$  is connected. In sum, we get unique holomorphic extensions of the functions  $\Theta'_{q'_1, \beta}(h_{q'_1}(t))$  to the domain

$$(8.5) \quad \omega(\Sigma_{\gamma_{q_1}}) \cup D \cup [\Sigma_{\gamma_{q_1}}^- \cap \Delta_n(0, \eta)],$$

which yields the desired holomorphic extensions at  $p_1$ . Case I is achieved.

**8.6. Case II.** Case II is treated almost the same way as Case I. Since  $S_{\bar{p}_1} \cap H_1^-$  is contained in  $D$ , we can choose a fixed point  $\tilde{q}$  of  $S_{\bar{p}_1}$  which belongs to  $D$ . So there exists a radius  $\tilde{\rho} > 0$  such that the polydisc  $\Delta_n(\tilde{q}, \tilde{\rho})$  is contained in  $D$ . For  $|q_1| < \varepsilon$  sufficiently close to  $p_1$ , there exists a point  $\tilde{q}_1 \in S_{\bar{q}_1}$  sufficiently close to  $\tilde{q}$  such that the polydisc  $\Delta_n(\tilde{q}_1, \tilde{\rho}/2)$  is again

contained in  $D$ . Thanks to Lemma 7.20, if  $q_1$  is sufficiently close to  $p_1$ , the neighborhood  $\omega(\Sigma_{\gamma_{q_1}})$  constructed by deformations of analytic discs as in [Tu2] will contain the point  $p_1$ , since its size along  $S_{\tilde{q}_1}$  depends only on the fixed size of the polydisc  $\Delta_n(\tilde{q}_1, \tilde{\rho}/2)$  which is of radius at least  $\tilde{\rho}/2$  uniformly. Finally, as in Case I, the monodromy of the extension follows by an application of Lemma 6.20.

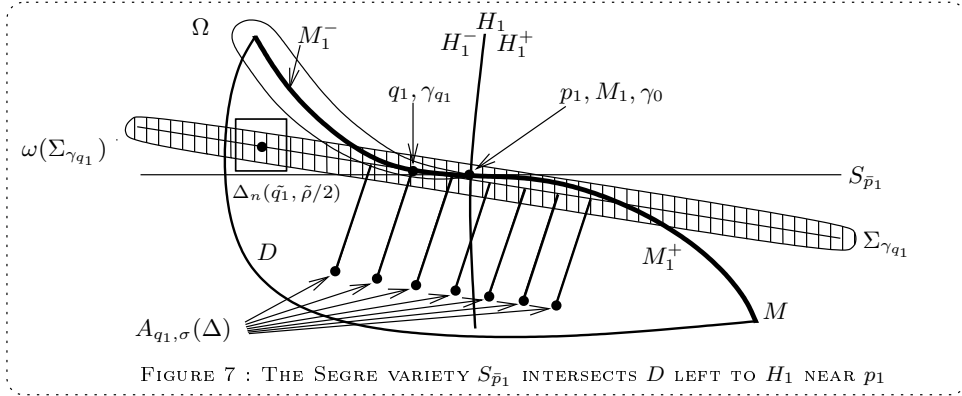

**8.7. Case III.** For Case III, thanks to Lemma 8.2, we know already that  $p_1$  belongs to the lower side  $\Sigma_{\gamma_{q_1}}^-$ . Thus Case III follows immediately from the application of Lemma 6.20 summarized in §8.3 above. Case III is achieved. The proofs of Theorems 5.5, 1.9 and 1.2 are complete.  $\square$

## §9. ANALYTICITY OF SOME DEGENERATE $C^\infty$ -SMOOTH CR MAPPINGS

**9.1. Presentation of the results.** Theorems 1.9 and 1.14 are concerned with  $C^\infty$ -smooth CR diffeomorphisms. It is desirable to remove the diffeomorphism assumption. Taking inspiration from the very deep article of Pinchuk [P4], we have been successful in establishing the following statement. We refer the reader to the work of Diederich-Fornæss [DF1] and to the book of D'Angelo [D'A] for fundamentals about complex curves contained in real analytic hypersurfaces.

**Theorem 9.2.** *Let  $h : M \rightarrow M'$  be a  $C^\infty$ -smooth CR mapping between two connected real analytic hypersurfaces in  $\mathbb{C}^n$  ( $n \geq 2$ ). If  $M$  and  $M'$  do not contain any complex curve, then  $h$  is real analytic at every point of  $M$ .*

At first, we need to recall some known facts about the local CR geometry of real analytic hypersurfaces.

- (1) If  $M$  does not contain complex curves, it is essentially finite. This is obvious, because the coincidence loci of Segre varieties are complex analytic subsets which are contained in  $M$  (cf. [DP1,2]).
- (2) If  $M$  is essentially finite at every point, it is locally minimal at every point, so it consists of a single CR orbit, namely it is globally minimal. As we have seen in §3.6 above, CR functions on  $M$  (and in particular the components of  $h$ ) extend holomorphically to a global one-sided neighborhood  $D$  of  $M$  in  $\mathbb{C}^n$ .
- (3) If  $M$  does not contain complex curves, then  $M$  is Levi nondegenerate at each point of the complement of some proper closed real analytic subset of  $M$ . On the contrary, the everywhere Levi degenerate CR manifolds are locally regularly foliated by complex leaves of dimension equal to the dimension of the kernel the Levi form, at points where this kernel is of maximal hence locally constant dimension. This may happen in the class of essentially finite hypersurfaces.

- (4) If  $M$  does not contain complex curves, then either  $h$  is constant or it is of real generic rank  $(2n - 1)$  over an open dense subset of  $M$  and its holomorphic extension is of complex generic rank  $n$  over  $D$ . This is easily established by looking at a point where  $h$  is of maximal, hence locally constant, rank.
- (5) In Theorem 9.2, there exists at least an everywhere dense open subset  $U_M$  of  $M$  such that  $h$  is real analytic at every point of  $U_M$ .

Based on these observations, Theorem 9.2 will be implied by the following more general statement to which the remainder of §9 is devoted.

**Theorem 9.3.** *Let  $h : M \rightarrow M'$  be a  $C^\infty$ -smooth CR mapping between two connected real analytic hypersurfaces in  $\mathbb{C}^n$  ( $n \geq 2$ ). If  $M$  and  $M'$  are essentially finite at every point and if the maximal generic real rank of  $h$  over  $M$  is equal to  $(2n - 1)$ , then  $h$  is real analytic at every point of  $M$ .*

In [BJT], [BR1], [BR2], an apparently similar result is proved. In these articles, it is always assumed at least that the formal Taylor series of  $h$  at every point of  $M$  has Jacobian determinant not identically zero. It follows that all the results proved in these papers are superseded by the unification provided in the recent articles [CPS1,2] and [Da2] expressed in terms of the characteristic variety (1.4). However, the difficult problem would be to treat the points of  $M$  where *nothing* is *a priori* known about the behavior of  $h$ , for instance points where all the  $h_j$  could vanish to infinite order hence have an identically zero formal Taylor series. In this case, of course, the characteristic variety is positive-dimensional. Unless  $M$  is strongly pseudoconvex or there exist local peak functions, it seems impossible to show *ab initio* that  $h$  is not flat at every point of  $M$ . Thus the strategy of working *only at one fixed "center point"* of  $M$  might well necessarily fail (*cf.* [BJT], [BR1,2,4], [BER1,2,3]). On the contrary, a strategy of propagation from nearby points as developed in [P3,4], [DFY], [DP1,2], [Sha], [V], [PV] (and also in the previous paragraphs) is really adequate. Philosophically speaking, there is no real surprise here, because the propagation along Segre varieties is a natural generalization of the weierstrassian conception of analytic continuation.

**9.4. Dense holomorphic extension.** Let  $D$  be a global one-sided neighborhood of  $M$  in  $\mathbb{C}^n$  to which CR functions extend holomorphically. It follows from the assumptions of Theorem 9.3 that the generic complex rank of  $h$  in  $D$  equals  $n$ . Recall that the two everywhere essentially finite hypersurfaces  $M$  and  $M'$  are of course holomorphically nondegenerate, namely  $\chi_M = n$  and  $\chi_{M'} = n$ . At first, we prove the following lemma. Recall that the intrinsic exceptional locus  $E_M$  defined in §3.47 is a proper real analytic subset of  $M$ . Let  $U_M$  denote the open subset consisting of points  $p \in M \setminus E_M$  at which the real rank of  $h$  equals  $(2n - 1)$ .

**Lemma 9.5.** *The open subset  $U_M$  is dense in  $M$ .*

*Démonstration.* Indeed, suppose on the contrary that  $M \setminus U_M$  contains an open set  $V$ . Then the rank of  $h$  is strictly less than  $(2n - 1)$  over  $V$ . By the principle of analytic continuation and by the boundary uniqueness theorem, it follows that  $h$  is of generic complex rank strictly less than  $n$  in the domain  $D$ , contradiction.  $\square$

**Lemma 9.6.** *The mapping  $h$  extends holomorphically to a neighborhood of every point  $p \in U_M$ .*

*Démonstration.* Indeed, at such a point  $p \in U_M$ ,  $h$  is a local CR diffeomorphism of class  $C^\infty$ . By Lemma 4.3, the image  $p' := h(p)$  of  $p$  belongs to  $M' \setminus E_{M'}$ . Then Lemma 4.11 applies directly (with  $\chi_{M'} = n$  of course) to show that  $h$  extends holomorphically at  $p$ .  $\square$

**9.7. Holomorphic and formal mappings of essentially finite hypersurfaces.** Let  $h : M \rightarrow M'$  be as in the hypotheses of Theorem 9.3. Let  $p \in M$  and let  $p' := h(p)$ . Let  $t$  be coordinates vanishing at  $p$  and let as usual a complex equation for the extrinsic complexification  $\mathcal{M}$  of  $M$  be of the form  $w = \overline{\Theta}(z, \zeta, \xi)$ , where  $t = (z, w) \in \mathbb{C}^{n-1} \times \mathbb{C}$  and  $\tau = (\zeta, \xi) \in \mathbb{C}^{n-1} \times \mathbb{C}$ . Similarly, let  $w' = \overline{\Theta}'(z', \zeta', \xi')$  be an equation of  $\mathcal{M}'$ . As



in the proof of Lemma 4.3, the  $C^\infty$ -smooth CR mapping  $h$  induces a formal CR mapping  $(H(t), \overline{H}(\tau))$  between  $(\mathcal{M}, (p, \overline{p}))$  and  $(\mathcal{M}', (p', \overline{p}'))$ . Precisely, this means that the Taylor series  $H_j(t) = \sum_{\gamma \in \mathbb{N}^n} H_{j,\gamma} t^\gamma$  of  $h_j$  at the origin and there conjugates  $\overline{H}(\tau)$  satisfy a formal power series identity of the form

$$(9.8) \quad G(t) - \overline{\Theta}'(F(t), \overline{F}(\tau), \overline{G}(\tau)) \equiv A(t, \tau) [w - \overline{\Theta}(z, \zeta, \xi)],$$

where we denote  $H = (F_1, \dots, F_{n-1}, G)$  and where  $A(t, \tau)$  is a formal power series. Without loss of generality, we can assume that the coordinates  $(z, w)$  and  $(z', w')$  are normal, namely the defining functions satisfy  $\overline{\Theta}(0, \zeta, \xi) \equiv \overline{\Theta}(z, 0, \xi) \equiv \xi$  and *idem* for  $\overline{\Theta}'$ . Such coordinates are not unique, but they specify a certain component  $H_n = G$  of the formal CR mapping  $H$  which is called a *transversal component*. In [BR2], two facts about formal CR mappings between small local pieces of real analytic hypersurfaces (and even between *formal* hypersurfaces) are established. Recall that  $M$  and  $M'$  are assumed to be essentially finite at the origin and that the coordinates are normal.

1. If the transversal power series  $G$  does not vanish identically, then  $H$  is of *finite multiplicity*, namely (cf. [BR88]), the ideal generated by the power series  $F_1(z, 0), \dots, F_{n-1}(z, 0)$  is of finite codimension in  $\mathbb{C}[[z]]$ . We denote this codimension by  $\text{Mult}(H, 0)$ . It is independent of normal coordinates.
2. If  $H$  is of finite multiplicity, then a formal Hopf Lemma holds at the origin, which tells us that the induced formal mapping  $T_0M/T_0^cM \rightarrow T_0M'/T_0^cM'$  represented by  $G(0, w)$  is of formal rank equal to 1. Equivalently,  $(\partial G/\partial w)(0) \neq 0$ .

The multiplicity  $\text{Mult}(H, 0)$  is independent of normal coordinates, so it is a meaningful invariant of  $h$  at an arbitrary point of  $M$ . In normal coordinates, essential finiteness of  $M$  at  $p$  is characterized by the finite codimensionality in  $\mathbb{C}\{t\}$  of the ideal generated by the  $\Theta_\beta(t)$  for all  $\beta \in \mathbb{N}^{n-1}$ . This codimension is independent of coordinates and denoted by  $\text{Ess Type}(M, p)$ . Recall that  $M \setminus E_M$  is defined to be the set of points  $q \in M$  at which the mapping  $t \mapsto (\Theta_\beta(t))_{\beta \in \mathbb{N}^{n-1}}$  is of rank  $n$  in coordinates vanishing at  $q$ . Consequently

**Lemma 9.9.** *For every  $q \in M \setminus E_M$ , we have  $\text{Ess Type}(M, q) = 1$ .*

A refinement of the analytic reflection principle proved in [BR1] is as follows ([BR2, Theorem 6]).

**Lemma 9.10.** *The  $C^\infty$ -smooth CR mapping  $h$  extends holomorphically to a neighborhood of a point  $q \in \mathbb{C}^n$  provided that in normal coordinates centered at  $q$  and at  $q' = h(q)$ , the normal component  $g$  of  $h$  is not flat at the origin, namely its formal power series  $G$  does not vanish identically.*

Furthermore, in the case where the mapping  $h$  extends holomorphically at one point, four interesting nondegeneracy properties hold :

**Lemma 9.11.** *With the same assumptions as in Theorem 9.3, let  $q \in M$ , let  $q' := h(q)$  and assume that  $h$  extends holomorphically to a neighborhood of  $q$ . Then*

- (1) *The induced differential  $dh : T_qM/T_q^cM \rightarrow T_{q'}M'/T_{q'}^cM'$  is of rank 1.*
- (2) *The mapping  $h$  is of finite multiplicity  $m := \text{Mult}(h, q) < \infty$  and  $h$  is a local  $m$ -to-one holomorphic mapping in a neighborhood of  $q$ .*
- (3) *We have the multiplicative relation*

$$(9.12) \quad \text{Ess Type}(M, q) = \text{Mult}(h, q) \cdot \text{Ess Type}(M', q').$$

- (4) *If  $q \in M \setminus E_M$ , then  $h$  is a local biholomorphism at  $q$ .*

**9.13. Installation of the proof of Theorem 9.3.** Let  $E_{\text{na}}$  be the closed set of points of  $M$  at which the mapping  $h$  is not real analytic. By Lemma 9.6, the complement  $M \setminus E_{\text{na}}$  is nonempty and in fact dense in  $M$ . If  $E_{\text{na}}$  is empty, then Theorem 9.3 is proved, gratuitously. As in §2 and §5 above, we shall assume that  $E_{\text{na}}$  is nonempty and we shall construct a contradiction by showing that there exists in fact a point  $p_1$  of  $E_{\text{na}}$  at which  $h$  is real analytic. By Lemma 5.4, we are reduced to the following statement, which is analogous to Theorem 5.5.

**Theorem 9.14.** *Let  $p_1 \in E_{\text{na}}$  and assume that there exists a real analytic one-codimensional submanifold  $M_1$  of  $M$  with  $p_1 \in M_1$  which is generic in  $\mathbb{C}^n$  such that  $E_{\text{na}} \setminus \{p_1\}$  is completely contained in one of the two open sides of  $M$  divided by  $M_1$ , say in  $M_1^+$ , and such that  $h$  is real analytic at every point  $q \in M \setminus E_{\text{na}}$ . Then  $h$  is real analytic at  $p_1$ .*

To prove this theorem, we shall start as follows. We remind that the intrinsic exceptional locus  $E_M$  of  $M$  is of real codimension at least two in  $M$ . At each point  $q \in M \setminus E_M$ , the hypersurface  $M$  is finitely nondegenerate. It follows from Lemma 9.11(4) that at each point  $q \in M \setminus (E_M \cup E_{\text{na}})$ , the mapping  $h$  extends as a local biholomorphism from a neighborhood of  $q$  in  $\mathbb{C}^n$  onto a neighborhood of  $h(q)$  in  $\mathbb{C}^n$ . Consider the relative disposition of the center point  $p_1$  with respect to  $E_M$ . In principle, there are two cases to be considered. Either  $p_1 \in E_M$  or  $p_1 \in M \setminus E_M$ . In both cases, we have the following useful existence property.

**Lemma 9.15.** *There exists a small two-dimensional open real analytic manifold  $K$  passing through  $p_1$  and contained in  $M$  such that*

- (1)  $K$  is transversal to  $M_1$ .
- (2)  $K \cap E_M = \{p_1\}$  and the line  $T_{p_1}K \cap T_{p_1}M_1$  is not contained in  $T_{p_1}^c M$ .

*Démonstration.* Indeed, introducing real analytic coordinates on  $M$ , this follows from a more general statement. Given a locally defined real analytic set  $E$  in  $\mathbb{R}^\nu$  of dimension  $1 \leq \mu \leq \nu - 1$  passing through the origin, then for almost all  $(\nu - \mu)$ -dimensional linear planes  $K$  passing through the origin, the intersection of  $K$  with  $E$  consists of the singleton  $\{0\}$  in a neighborhood of the origin.  $\square$

It follows from Lemma 9.15 that the intersection  $K \cap M_1$  coincides with a geometrically smooth real analytic arc  $\gamma_1$  passing through  $p_1$  which is not complex tangential at  $p_1$ . By construction,  $\gamma_1 \setminus \{p_1\}$  is contained in the locus  $M \setminus E_{\text{na}}$  where  $h$  is already real analytic. Moreover,  $\gamma_1 \setminus \{p_1\}$  is also contained in  $M \setminus E_M$ . Its complexification  $(\gamma_1)^c$  is a complex disc transversal to  $M$  with  $(\gamma_1)^c \cap M = \gamma_1$ . Recall that  $h$  already extends holomorphically to a one-sided neighborhood  $D$  of  $M$ . To fix ideas, we can assume that  $D$  is in the lower side  $M^-$  of  $M$  in  $\mathbb{C}^n$ . Moreover,  $h$  extends holomorphically to an open neighborhood  $\Omega$  of  $M \setminus E_{\text{na}}$  in  $\mathbb{C}^n$ . We choose *normal* coordinates  $t$  vanishing at  $p_1$  in which the equation of  $M$  is of the form  $\bar{w} = \Theta(\bar{z}, t)$ , with  $\Theta(0, t) \equiv w$ . Especially, we choose such coordinates in order that  $\gamma_1$  coincides with a small neighborhood of the origin in the  $u$ -axis in these normal coordinates, which is possible. Also, we choose some arbitrary *normal* coordinates  $t'$  vanishing at  $p'_1 := h(p_1)$  in which the equation of  $M'$  is of the form  $\bar{w}' = \Theta'(\bar{z}', t')$ , with  $\Theta'(0, t') \equiv w'$ . We denote the mapping by  $h = (f, g) = (f_1, \dots, f_{n-1}, g)$  in these coordinates.

Suppose for a while that we have proved that the normal component  $g$  of the mapping extends holomorphically to a neighborhood of the point  $p_1$  in the transverse holomorphic disc  $(\gamma_1)^c$ , which coincides with a small neighborhood of the origin in the  $w$ -axis. Notice that we speak only of holomorphic extension to the single transverse holomorphic disc passing through  $p_1$ , because our method below will not give more. Then we claim that the proofs of Theorems 9.14 and 9.3 are achieved. Indeed, it suffices to show that the holomorphic extension  $g(0, w)$  at  $w = 0$  does not vanish identically, since then it follows afterwards that the Taylor series  $G$  at the origin of the normal component  $g$  does not vanish identically, whence  $h$  extends holomorphically at  $p_1$  thanks to Lemma 9.10. To prove that the extension  $g(0, w)$  is nonzero, we reason as follows. According to Lemma 9.11(1), at every point  $q \in \gamma_1$  sufficiently close to  $p_1$  and different from  $p_1$ , the induced differential  $dh : T_q M / T_q^c M \rightarrow T_q M' / T_q^c M'$  is of rank one. This entails that the differential  $\partial_w g(0, w)$  is nonzero at  $w := w_q$ , which shows that the holomorphic extension  $g(0, w)$  does not vanish identically, as desired. In summary, to prove Theorems 9.14 and 9.3, it remains to establish the following crucial statement.

**Lemma 9.16.** *The  $C^\infty$ -smooth restrictions  $f_1|_{\gamma_1}, \dots, f_{n-1}|_{\gamma_1}$  and  $g|_{\gamma_1}$  extend holomorphically to a small neighborhood of  $p_1$  in the complex disc  $(\gamma_1)^c$ .*

**9.17. Holomorphic extension to a transverse holomorphic disc.** This subsection is devoted to the proof of Lemma 9.16. Using the manifold  $K$  of Lemma 9.15, we can include  $\gamma_1$

into a one-parameter family  $\gamma_s$  of real analytic arcs, with  $s_1 < s \leq 1$ , contained in  $K$  which foliate  $K \cap M_1^-$  for  $s_1 < s < 1$ . Since for  $s_1 < s < 1$ , the arcs  $\gamma_s$  are contained in  $M_1^-$ , we have  $\gamma_s \cap E_{\text{na}} = \emptyset$ . By Lemma 9.15, we also have the important property  $\gamma_s \cap E_M = \emptyset$ . We consider the complexifications  $(\gamma_s)^c$ , which are transversal to  $M$ . One half of the complex discs  $(\gamma_s)^c$  is contained in  $D$ . The crucial Lemma 9.19 below is extracted from [P4, Lemma 3.1] and is particularized to our  $\mathcal{C}^\infty$ -smooth situation. In the sequel, it will be applied to the one-dimensional domains of the complex plane  $\mathbb{C}$  defined by

$$(9.18) \quad U_s := (\gamma_s)^c \cap D \cap \{|w| < r\},$$

where  $r > 0$  is sufficiently small and to certain antiholomorphic functions to be defined later. First of all, we introduce some notation. As the complex disc  $(\gamma_s)^c$  is transverse to  $M$  and almost parallel to the  $w$ -axis, it follows that  $U_s$  is a small one-dimensional simply connected domain in  $(\gamma_s)^c$  bounded by two real analytic parts which we shall denote by  $\delta_s \subset \gamma_s$  and by  $\beta_s \subset \{|w| = r\} \cap (\gamma_s)^c \cap D$ . These two real analytic arcs join together at two points  $q_s^+ \in \gamma_s$  and  $q_s^- \in \gamma_s$ , namely  $\{q_s^-, q_s^+\} = \gamma_s \cap \{w = r\} = \delta_s \cap \beta_s$ . Then the boundaries  $\delta_s$  and  $\gamma_s$  depend real analytically on  $s$ , even in a neighborhood of  $s = 1$ . We consider the two *open* real analytic arcs  $\delta_s^\circ := \delta_s \setminus \{q_s^-, q_s^+\}$  and similarly for  $\beta_s^\circ$ . Here is the lemma.

**Lemma 9.19.** *Let  $U_s \subset \mathbb{C}$  be a one-parameter family of bounded simply connected domains in  $\mathbb{C}$  having piecewise real analytic boundaries with two open pieces  $\delta_s^\circ$  and  $\beta_s^\circ$  depending real-analytically on a real parameter  $s_1 < s \leq 1$ , let  $\varphi_s, \psi_s$  be antiholomorphic functions defined in  $U_s$  which depend  $\mathcal{C}^\infty$ -smoothly on  $s$  and set  $\theta_s := \varphi_s/\psi_s$ . Assume that the following four conditions hold.*

- (1) *For  $s < 1$ , the two functions  $\varphi_s$  and  $\psi_s$  extend antiholomorphically to a certain neighborhood of  $\overline{U_s}$  in  $\mathbb{C}$  and there exists a point  $p_1 \in \delta_1^\circ$  so that  $\varphi_1$  and  $\psi_1$  extend antiholomorphically to a neighborhood of  $\overline{U_1} \setminus \{p_1\}$  in  $\mathbb{C}$  and  $\mathcal{C}^\infty$ -smoothly up to the open arc  $\delta_1^\circ$ .*
- (2) *The quotient  $\theta_1 := \varphi_1/\psi_1$  is of class  $\mathcal{C}^\infty$  over  $\delta_1^\circ$ .*
- (3) *For  $s < 1$ , the function  $\psi_s$  does not vanish on  $\partial U_s$  and there exists a constant  $C > 0$  such that  $|\theta_s| \leq C$  on  $\partial U_s$  for all  $s_1 < s < 1$ .*
- (4) *The function  $\psi_1$  does not vanish on  $\overline{U_1} \setminus \{p_1\}$ .*

*Then the quotient  $\theta_1$  satisfies  $|\theta_1| \leq C$  on  $U_1$  and it extends as an antiholomorphic function to  $U_1$  which is of class  $\mathcal{C}^\infty$  up to the open real analytic piece  $\delta_1^\circ$  of the boundary.*

*Démonstration.* In view of the nonvanishing of  $\psi_s$  in  $\partial U_s$ , the function  $\psi_s$  has in  $U_s$  a certain number  $m$  (counting multiplicities) of zeros which is constant for all  $s_1 < s < 1$ . Using a conformal isomorphism of  $U_s$  with the unit disc and an antiholomorphic Blaschke product, we can construct an antiholomorphic function  $b_s$  on  $U_s$  extending  $\mathcal{C}^\infty$ -smoothly to the boundary with  $|b_s| = 1$  on  $\partial U_s$  such that the  $m$  zeros of  $b_s$  coincide with the  $m$  zeros of  $\psi_s$ . Then  $b_s \theta_s$  is holomorphic in  $U_s$  for  $s_1 < s < 1$ . It follows from the maximum principle that  $|b_s \theta_s| \leq C$  on  $\overline{U_s}$  for all  $s_1 < s < 1$ . Since  $\psi_1 \neq 0$  in  $\overline{U_1} \setminus \{p_1\}$ , when  $s \rightarrow 1$ , all zeros of the function  $\psi_s$  converge to the single point  $p_1 \in \partial U_1$ . From the form of a Blaschke product, we observe that  $\lim_{s \rightarrow 1} |b_s(z)| = 1$  for every point  $z \in U_1$ . Therefore, for  $z \in U_1$ , we have

$$(9.20) \quad |\theta_1(z)| = \lim_{s \rightarrow 1} |\theta_s(z)| = \lim_{s \rightarrow 1} |b_s(z) \theta_s(z)| \leq C.$$

So the function  $\theta_1$  is bounded in  $U_1$ . Since its boundary value  $\varphi_1/\psi_1$  is of class  $\mathcal{C}^\infty$  on  $\delta_1^\circ$ , it follows that the antiholomorphic function  $\theta_1$  extends  $\mathcal{C}^\infty$ -smoothly up to  $\delta_1^\circ \cup \beta_1^\circ$ . The proof of Lemma 9.19 is complete.  $\square$

We can now begin the proof of Lemma 9.16. Let  $\overline{L}_1, \dots, \overline{L}_{n-1}$  denote the commuting basis of  $T^{0,1}M$  given by  $\overline{L}_j = \frac{\partial}{\partial \bar{z}_j} + \Theta_{\bar{z}_j}(\bar{z}, t) \frac{\partial}{\partial \bar{w}}$ , for  $j = 1, \dots, n-1$ . In a neighborhood of the arc  $\gamma_s$  for  $s < 1$ , the mapping  $h$  extends holomorphically as a local biholomorphism. It follows that the determinant

$$(9.21) \quad \det(\overline{L}_j \overline{f}_k(\bar{t}))_{1 \leq j, k \leq n-1} := \mathcal{D}(z, \bar{t}, \{\partial_{\bar{t}_l} \overline{f}_k(\bar{t})\}_{1 \leq l \leq n, 1 \leq k \leq n-1})$$

does not vanish for  $t \in M$  in a neighborhood of  $\gamma_s$ . Also, it extends as a certain antiholomorphic function to the domain  $U_s$ . Let us denote this extension by  $\psi_s$ . In order that the function  $\psi_s$  satisfies the assumption (4) of Lemma 9.19, we first observe that the determinant (9.21) does not vanish on the part  $\delta_1 \setminus \{p_1\}$  of  $\partial U_1 \setminus \{p_1\}$ . Indeed, since  $h$  is real analytic at every point of  $\delta_1 \setminus \{p_1\}$  and since  $\delta_1 \setminus \{p_1\}$  is contained in  $M \setminus E_M$ , this follows from Lemma 9.11 (4). For the second part  $\beta_1$  of  $\partial U_1$ , we observe that for every small  $r > 0$  as in (9.18), the determinant (9.10), extends as an antiholomorphic function to  $U_1$  and is in fact real analytic in a neighborhood of  $\beta_1$ . Since the determinant (9.21) does not vanish on  $\delta_1 \setminus \{p_1\}$ , there exist arbitrarily small  $r > 0$  such that  $\psi_1$  does not vanish over  $\beta_1$ . Shrinking  $s_1$ , we can assume that  $\psi_s$  does not vanish on  $\beta_s$  for all  $s_1 < s \leq 1$ . Finally, we know already that for  $s < 1$ , the function  $\psi_s$  does not vanish on  $\delta_s$ , thanks to the fact that  $\gamma_s \cap E_M$  is empty. Since  $\psi_s$  does not vanish on the boundary  $\partial U_s$  for all  $s_1 < s < 1$ , it follows from Rouché's theorem that the number of zeros of  $\psi_s$  in  $U_s$  is constant equal to  $m$  (counting multiplicities). Therefore, even for  $s = 1$ , the function  $\psi_1$  has in  $U_1$  not more than  $m$  zeros. Decreasing  $r > 0$  once more, we can assume that  $\psi_1$  does not vanish in  $U_1$ . This shows that  $\psi_s$  satisfies all the assumptions of Lemma 9.19.

Next, as the mapping  $h$  is of class  $\mathcal{C}^\infty$  over  $M$ , we can apply the tangential Cauchy-Riemann derivations  $\overline{T}_1^{\beta_1} \cdots \overline{T}_{n-1}^{\beta_{n-1}}$ ,  $\beta \in \mathbb{N}^{n-1}$ , of order  $|\beta|$  infinitely many times to the identity

$$(9.22) \quad \overline{g(\bar{t})} = \Theta'(\overline{f(\bar{t})}, h(\bar{t})),$$

which holds for all  $t \in M$  in a neighborhood of  $p_1$ . As in §7 above, using the nonvanishing of the determinant we get for all  $\beta \in \mathbb{N}^{n-1}$  and for all  $t \in \gamma_s$  with  $s < 1$  the following identities

$$(9.23) \quad \frac{1}{\beta!} \frac{\partial^{|\beta|} \Theta'}{\partial (z')^\beta} (\overline{f(\bar{t})}, h(\bar{t})) = \frac{\mathcal{T}_\beta(z, \bar{t}, \{\partial_{\bar{t}}^\gamma \overline{h_j(\bar{t})}\}_{1 \leq j \leq n, |\gamma| \leq |\beta|})}{[\mathcal{D}(z, \bar{t}, \{\partial_{\bar{t}_i} f_k(\bar{t})\}_{1 \leq l \leq n, 1 \leq k \leq n-1})]^{2|\beta|-1}}.$$

Precisely, the  $\mathcal{T}_\beta$ 's are holomorphic with respect to  $(z, \bar{t})$  and relatively polynomial with respect to the jets  $\{\partial_{\bar{t}}^\gamma \overline{h_j(\bar{t})}\}_{1 \leq j \leq n, |\gamma| \leq |\beta|}$ . It follows that the numerator  $\mathcal{T}_\beta$  extends antiholomorphically to  $U_s$  for every  $s_1 < s \leq 1$  as a certain function which we shall denote by  $\varphi_{\beta,s}$ . We set  $\psi_{\beta,s} := [\psi_s]^{2|\beta|-1}$ . For  $t \in \gamma_s \subset M$  with  $s < 1$ , let us rewrite (9.23) as follows :

$$(9.24) \quad (1/\beta!) [\partial^{|\beta|} \Theta' / \partial (z')^\beta] (\overline{f(\bar{t})}, h(\bar{t})) = \varphi_{\beta,s}(\bar{t}) / \psi_{\beta,s}(\bar{t}).$$

As the left hand side of (9.24) is of class  $\mathcal{C}^\infty$  on  $\gamma_s$ , it follows that the right hand side is of class  $\mathcal{C}^\infty$  on  $\delta_s^\circ$ , for all  $s \leq 1$ . By construction, for all  $\beta \in \mathbb{N}^{n-1}$ , the function  $\psi_{\beta,s}$  has no zeros on the boundary  $\partial U_s$  for  $s < 1$  and it also has no zeros on  $\partial U_1 \setminus \{p_1\}$ . Furthermore, these two functions  $\varphi_{\beta,s}$  and  $\psi_{\beta,s}$  both extend antiholomorphically to a neighborhood of  $\overline{U_s}$  in  $(\gamma_s)^c$  for  $s < 1$  and to a neighborhood of  $\overline{U_1} \setminus \{p_1\}$  for  $s = 1$ . Let us define  $\theta_{\beta,s} := \varphi_{\beta,s} / \psi_{\beta,s}$ . By Lemma 9.19, for  $s = 1$ , the functions  $\theta_{\beta,1}$  extend antiholomorphically to  $U_1$  as bounded functions and  $\mathcal{C}^\infty$ -smoothly up to the open real analytic arc  $\delta_1^\circ$ . In summary, we have shown that for all  $\beta \in \mathbb{N}^{n-1}$ , there exist functions  $\theta_{\beta,1}(\bar{t})$  defined for  $t \in \delta_1$  and extending as antiholomorphic functions to  $U_1$  which are of class  $\mathcal{C}^\infty$  up to  $\delta_1^\circ$  such that the following identities hold on  $\delta_1$  :

$$(9.25) \quad (1/\beta!) [\partial^{|\beta|} \Theta' / \partial (z')^\beta] (\overline{f(\bar{t})}, h(\bar{t})) = \theta_{\beta,1}(\bar{t}).$$

Next, we may derive some polynomial identities in the spirit of [BJT], [BR1]. By the relation (9.25) written for  $t := p_1 \in \delta_1^\circ$ , we see that  $\theta_{\beta,1}(\bar{p}_1) = 0$ , because  $h(p_1) = p'_1$  sends the origin  $p_1$  (in the coordinate system  $t$ ) to the origin  $p'_1$  (in the coordinate system  $t'$ ) and because the coordinates are normal. As  $M'$  is essentially finite at the origin, there exists an integer  $\kappa \in \mathbb{N}_*$  such that the ideal  $(\Theta'_\beta(t'))_{|\beta| \leq \kappa}$  is of finite codimension in  $\mathbb{C}\{t'\}$ . It follows from (9.24) and from a classical computation (cf. [BJT], [BR1]) that there exist analytic coefficients  $A_{j,k}$  in their variables which vanish at the origin and integers  $N_j \geq 1$  such that, after possibly shrinking  $r > 0$ , we have

$$(9.26) \quad h_j^{N_j}(t) + \sum_{k=1}^{N_j} A_{j,k}(\overline{f(\bar{t})}, \{\theta_{\beta,1}(\bar{t})\}_{|\beta| \leq \kappa}) h_j^{N_j-k}(t) = 0,$$

for all  $t \in \delta_1$ . It follows that these coefficients  $A_{j,k}$ , considered as functions of one real variable in  $\delta_1$ , extend as antiholomorphic functions to  $U_1$ . In summary, we have constructed some polynomial identities for the components of the mapping  $h$  with antiholomorphic coefficients which hold only on the single transverse half complex disc  $U_1 = (\gamma_1)^c \cap D$  in a neighborhood of  $p_1$ . These polynomial identities are crucial to show that the mapping  $h$  restricted to  $(\gamma_1)^c \cap D$  extends holomorphically to a neighborhood of  $p_1$  in  $(\gamma_1)^c$ .

Indeed, by following the last steps of the general approach of [BJT], [BR1,§7], we deduce that the reflection function (as denoted in equation (8.1) of [BR1,§8]) extends holomorphically to a neighborhood of the point  $p_1$  in  $(\gamma_1)^c$  as a function of one complex variable  $w$  (remember that  $(\gamma_1)^c$  is contained in the  $w$ -axis). We would like to mention that in the strongly pseudoconvex case, such a holomorphic extension to a single transverse holomorphic disc was first derived by Pinchuk in [P4] in the more general case where  $h$  is only continuous at  $p_1$  and real analytic in  $M \setminus E_{\text{na}}$ . Finally, using the real analyticity of the reflection function, using the  $C^\infty$ -smoothness of  $h|_{\gamma_1}$  and using Puiseux series as in [BJT], we deduce that  $h|_{\gamma_1}$  is real analytic at  $p_1$ . The proof of Theorem 9.3 is complete.  $\square$

A careful inspection of the above arguments shows that there is no obvious possibility to get an extension to the complex discs  $(\gamma_s)^c$  with a uniform control of the size of the domains of extension. Only the extension to the limit complex disc  $(\gamma_1)^c$  can be obtained.

**9.27. Strong uniqueness principle for CR mappings.** We end up this section by an application of Theorem 9.2. A similar application of Theorem 9.3 may be stated.

**Theorem 9.28.** *Let  $h : M \rightarrow M'$  and  $h^* : M \rightarrow M'$  be two  $C^\infty$ -smooth CR mappings between two connected, real analytic hypersurfaces in  $\mathbb{C}^n$  and let  $p \in M$ . If  $M$  and  $M'$  do not contain complex curves, then there exists an integer  $\kappa \in \mathbb{N}_*$  which depends only on  $p$ , on  $M$  and on  $M'$  such that if the two  $\kappa$ -jets of  $h$  and  $h^*$  coincide at  $p$ , then  $h \equiv h^*$  over  $M$ .*

*Démonstration.* By Theorem 9.2, we can assume that  $h$  and  $h^*$  are both holomorphic in a neighborhood of  $p$  and nonconstant. By Lemma 9.11, the two mappings  $h$  and  $h_*$  satisfies the Hopf Lemma at  $p$  and are of finite multiplicity. It follows from a careful inspection of the analytic versions of the reflection principle given in [BR1], [BR2] that if  $\kappa$  is large enough, then the two mappings  $h$  and  $h^*$  coincide in a neighborhood of  $p$ . In fact, the complete arguments already appeared in a more general context in [BER3, Theorem 2.5]. Then  $h \equiv h^*$  all over  $M$  by analytic continuation. For the particular case of germs, Theorem 9.28 is conjectured in [BER4, p. 238].  $\square$

## §10. OPEN PROBLEMS AND CONJECTURES

In the celebrated article [DP2], the following conjecture stated *without pseudoconvexity assumption*, was solved in the case  $n = 2$ .

**Conjecture 10.1.** *Let  $h : D \rightarrow D'$  be a proper holomorphic mapping between two bounded domains in  $\mathbb{C}^n$  ( $n \geq 2$ ) having real analytic and geometrically smooth boundaries. Then  $h$  extends holomorphically to an open neighborhood of  $\overline{D}$  in  $\mathbb{C}^n$ .*

To the author's knowledge, the conjecture is open for  $n \geq 3$ . In fact, among other conjectures, it has been conjectured for a long time that every such proper holomorphic mapping  $h : D \rightarrow D'$  extends *continuously* to the boundary  $M$  of  $D$  and that in this case,  $h$  is real analytic at every point of  $M$ . In the much easier case where  $h$  extends  $C^\infty$ -smoothly up to  $M$ , Theorem 9.2 above, in which no formal rank assumption is imposed on the Taylor series of  $h$  at points of  $M$ , provides a positive answer. Analogously, in Theorems 1.2 and 1.9, it would be very desirable to remove the diffeomorphism assumption and also the  $C^\infty$ -smoothness assumption. We have strongly used these two assumptions in the proof and we have found no way to do without. Nevertheless, inspired by above conjectures, it is natural to suggest the following two open problems.

**Conjecture 10.2.** *Let  $h : M \rightarrow M'$  be a continuous CR mapping between two globally minimal real analytic hypersurfaces in  $\mathbb{C}^n$  ( $n \geq 2$ ) and assume that the holomorphic extension of  $h$  to a global one-sided neighborhood  $D$  of  $M$  in  $\mathbb{C}^n$  is of generic rank equal to  $n$ . Then the reflection function extends holomorphically to a neighborhood of every point  $p \times \overline{h(p)}$  in the graph of  $\bar{h}$ .*

The rank assumption is really necessary, as shown by the following trivial example. Let  $M \subset \mathbb{C}^4$  be the product of  $\mathbb{C}_{z_2}^1 \times \mathbb{C}_{z_3}^1$  with the unbounded representation of the 3-sphere given by the equation  $w = \bar{w} + iz\bar{z}$ , let  $M' \subset \mathbb{C}^4$  be given by  $w' = \bar{w}' + iz'_1\bar{z}'_1 + iz'_2\bar{z}'_2 + iz'_3\bar{z}'_3$ , let  $h_2(z_1, w)$  be a CR function on  $M$  independent of  $(z_2, z_3)$ , of class  $C^\infty$ , which does not extend holomorphically to the pseudoconcave side of  $M$  at any point. Then the degenerate mapping  $(z_1, z_2, z_3, w) \mapsto (z_1, h_2(z_1, w), 0, w)$  maps  $M$  into  $M'$  but does not extend holomorphically to a neighborhood of  $M$  in  $\mathbb{C}^2$ . Suppose by contradiction that the globally defined reflection function  $\mathcal{R}'_h(t, \bar{v}') = \bar{\mu}' - w - i\bar{\lambda}'_1 z_1 - i\bar{\lambda}'_3 h_2(z_1, w)$  extends holomorphically to a neighborhood of  $0 \times 0$  in  $\mathbb{C}^4 \times \mathbb{C}^4$ . Differentiating with respect to  $\bar{\lambda}'_3$ , we deduce that  $h_2(w_1, z)$  extends holomorphically at the origin in  $\mathbb{C}^4$ , contradiction. In fact, to speak of the extendability of the reflection function, one has to choose for  $M'$  the *minimal for inclusion* real analytic subset containing the image  $h(M)$ , as argued in [Me5]. In the case where the generic complex rank of  $h$  over  $D$  equals  $n$ , then  $M'$  necessarily is the minimal for inclusion real analytic set containing  $h(M)$ . This explains the rank assumption in Conjecture 10.2.

Finally, in the holomorphically nondegenerate case, we expect that  $h$  be holomorphically extendable to a neighborhood of  $M$ .

**Conjecture 10.3.** *Let  $h : M \rightarrow M'$  be a continuous CR mapping between two globally minimal real analytic hypersurfaces in  $\mathbb{C}^n$  ( $n \geq 2$ ), assume that the holomorphic extension of  $h$  to a global one-sided neighborhood  $D$  of  $M$  in  $\mathbb{C}^n$  is of generic complex rank equal to  $n$  and assume that  $M'$  is holomorphically nondegenerate. Then  $h$  is real analytic at every point of  $M$ .*

#### RÉFÉRENCES

- [A] AĪRAPETYAN, R.A. : *Extension of CR-functions from piecewise smooth CR manifolds*, Mat. Sb. **134(176)** (1987), no.1, 108–118. English transl. in Math. USSR-Sb. **62** (1989), no.1, 111–120.
- [Ar] ARTIN, M. : *On the solutions of analytic equations*, Invent. Math. **5** (1968), 277–291.
- [BER1] BAOUENDI, M.S.; EBENFELT, P.; ROTHSCHILD, L.P. : *Algebraicity of holomorphic mappings between real algebraic sets in  $\mathbb{C}^n$* , Acta Math. **177** (1996), no.2, 225–273.
- [BER2] BAOUENDI, M.S.; EBENFELT, P.; ROTHSCHILD, L.P. : *Real submanifolds in complex space and their mappings*. Princeton Mathematical Series, **47**, Princeton University Press Princeton, NJ, 1999, xii+404 pp.
- [BER3] BAOUENDI, M.S.; EBENFELT, P.; ROTHSCHILD, L.P. : *Convergence and finite determinacy of formal CR mappings*, J. Amer. Math. Soc. **13** (2000), no.4, 697–723.
- [BER4] BAOUENDI, M.S.; EBENFELT, P.; ROTHSCHILD, L.P. : *Local geometric properties of real submanifolds in complex space*, Bull. Amer. Math. Soc. **37** (2000), no.3, 309–336.
- [BHR] BAOUENDI, M.S.; HUANG, X.; ROTHSCHILD, L.P. : *Regularity of CR mappings between algebraic hypersurfaces* Invent. Math. **125** (1996), no.1, 13–36.
- [BJT] BAOUENDI, M.S.; JACOBOWITZ, H.; TREVES, F. : *On the analyticity of CR mappings*, Ann. Math **122** (1985), no.2, 365–400.
- [BR1] BAOUENDI, M.S.; ROTHSCHILD, L.P. : *Germs of CR maps between real analytic hypersurfaces*, Invent. Math. **93** (1988), no.3, 481–500.
- [BR2] BAOUENDI, M.S.; ROTHSCHILD, L.P. : *Geometric properties of mappings between hypersurfaces in complex space*, J. Differential Geom. **31** (1990), no.2, 473–499.
- [BR3] BAOUENDI, M.S.; ROTHSCHILD, L.P. : *Cauchy-Riemann functions on manifolds of higher codimension in complex space*, Invent. Math. **101** (1990), no.1, 45–56.
- [BR4] BAOUENDI, M.S.; ROTHSCHILD, L.P. : *Mappings of real algebraic hypersurfaces*, J. Amer. Math. Soc. **8** (1995), no.4, 997–1015.
- [BT1] BAOUENDI, M.S.; TREVES, F. : *A property of the functions and distributions annihilated by a locally integrable system of complex vector fields*, Ann. of Math. **113** (1981), no.2, 387–421.

- [BT2] BAOUENDI, M.S.; TREVES, F : *About the holomorphic extension of CR functions on real hypersurfaces in complex space*, Duke Math. J. **51** (1984), no.1, 77–107.
- [BeFo] BEDFORD, E.; FORNÆSS, J.E. : *Local extension of CR functions from weakly pseudoconvex boundaries*, Michigan Math. J. **25** (1978), no.3, 259–262.
- [BePi] BEDFORD, E.; PINCHUK, S. : *Analytic continuation of biholomorphic maps*, Michigan Math. J., **28** (1987), no.3, 405–408.
- [CMS] COUPET, B.; MEYLAN, F.; SUKHOV, A. : *Holomorphic maps of algebraic CR manifolds*, Internat. Math. Res. Notices **1999**, no.1, 1–29.
- [CPS1] COUPET, B.; PINCHUK, S.; SUKHOV, A. : *On partial analyticity of CR mappings*, Math. Z. **235** (2000), 541–557.
- [CPS2] COUPET, B.; PINCHUK, S.; SUKHOV, A. : *Analyticité des applications CR*, C. R. Acad. Sci. Paris Sér. I Math. **329** (1999), no.6, 489–494.
- [D'A] D'ANGELO, J. P. : *Several Complex Variables and the Geometry of Real Hypersurfaces*, Studies in Advanced Mathematics. CRC Press, Boca Raton, FL, 1993.
- [Da1] DAMOUR, S. : *Sur l'algébricité des applications holomorphes*, C. R. Acad. Sci. Paris Sér. I Math. **332** (2001), no.6, 491–496.
- [Da2] DAMOUR, S. : *On the analyticity of smooth CR mappings between real analytic CR manifolds*, Michigan Math. J. **49** (2001), no.3, 583–603.
- [De] DERRIDJ, M. : *Le principe de réflexion en des points de faible pseudoconvérité pour des applications holomorphes propres*, Invent. Math. **79** (1985), no.1, 197–215.
- [DF1] DIEDERICH, K.; FORNÆSS, J.E. : *Pseudoconvex domains with real analytic boundary*, Ann. of Math. **107** (1978), no.2, 371–384.
- [DF2] DIEDERICH, K.; FORNÆSS, J.E. : *Biholomorphic maps between certain real analytic domains in  $\mathbb{C}^2$* , Math. Ann. **245** (1979), no.3, 255–272.
- [DF3] DIEDERICH, K.; FORNÆSS, J.E. : *Biholomorphic mappings between two-dimensional Hartogs domains with real analytic boundaries*, Recent Developments in Several Complex Variables (Fornæss, J. E., ed.), pp. 133–150, Ann. Math. Studies, vol. 100, Princeton University Press, Princeton N.J., 1981.
- [DF4] DIEDERICH, K.; FORNÆSS, J.E. : *Proper holomorphic mappings between real-analytic pseudoconvex domains in  $\mathbb{C}^n$* , Math. Ann **282** (1988), no.4, 681–700.
- [DFY] DIEDERICH, K.; FORNÆSS, J.E.; YE, Z. : *Biholomorphisms in dimension 2*, J. Geom. Anal. **4** (1994), no.4, 539–552.
- [DP1] DIEDERICH, K.; PINCHUK, S. : *Proper holomorphic maps in dimension 2 extend*, Indiana Univ. Math. J. **44** (1995), no.4, 1089–1126.
- [DP2] DIEDERICH, K.; PINCHUK, S. : *Reflection principle in higher dimensions*, Proceedings of the International Congress of Mathematicians, Vol II (Berlin 1998), Doc. Math. 1998, Extra Vol. II, 703–712.
- [DW] DIEDERICH, K.; WEBSTER, S.M. : *A reflection principle for degenerate real hypersurfaces*, Duke Math. J. **47** (1980), no.4, 835–843.
- [F] FORSTNERIC, F. : *Extending proper holomorphic mappings of positive codimension*, Invent. Math., **95** (1989), no.1, 31–62.
- [Ha] HAN, C.K. : *Analyticity of CR equivalences between some real analytic hypersurfaces in  $\mathbb{C}^n$  with degenerate Levi-forms*, Invent. Math **73** (1983), no.1, 51–69.
- [HaTr] HANGES, N.; TREVES, F. : *Propagation of holomorphic extendability of CR functions*, Math. Ann. **263** (1983), no.2, 157–177.
- [Hu] HUANG, X. : *Schwarz reflection principle in complex spaces of dimension two*, Comm. Partial Differential Equations **21** (1996), no.11–12, 1781–1828.
- [HMM] HUANG, X.; MERKER, J.; MEYLAN, F. : *Mappings between degenerate real analytic hypersurfaces in  $\mathbb{C}^n$* , Analysis, geometry, number theory : the mathematics of Leon Ehrenpreis (Philadelphia, PA, 1998), 321–338. Contemp. Math., **251**, Amer. Math. Soc., Providence, RI, 2000.
- [J] JÖRNICKE, B. : *Deformation of CR-manifolds, minimal points and CR-manifolds with the microlocal analytic extension property*, J. Geom. Anal. **6** (1996), no.4, 555–611.
- [L] LEWY, H. : *On the boundary behaviour of holomorphic mappings*, Contrib. Centro Linceo Inter. Sc. Mat. e Loro Appl. No. 35, Accad. Naz. Lincei (1977), 1–8.
- [MaMe] MAIRE, H.; MEYLAN, F. : *Extension of smooth CR mappings between non-essentially finite hypersurfaces in  $\mathbb{C}^3$* , Ark. Math. **35** (1997), no.1, 185–199.

- [Ma] MALGRANGE, B. : *Ideals of Differentiable Functions*, Tata Institute of Fundamental Research Studies in Mathematics, No.3, Tata Institute of Fundamental Research, Bombay ; Oxford University Press, London, 1967, vii+106 pp.
- [Me1] MERKER, J. : *Global minimality of generic manifolds and holomorphic extendibility of CR functions*, Internat. Math. Res. Notices **1994**, no.8, 329 ff., approx. 14 pp. (electronic), 329–342.
- [Me2] MERKER, J. : *On removable singularities for CR functions in higher codimension*, Internat. Math. Res. Notices **1997**, no.1, 21 ff., approx. 36 pp. (electronic), 21–56.
- [Me3] MERKER, J. : *On the Schwarz symmetry principle in three-dimensional complex euclidean space*, Prépublication École Normale Supérieure, **25** (1997), 62 pp.
- [Me4] MERKER, J. : *Vector field construction of Segre sets*, Preprint 1998, augmented in 2000. Downloadable at [arXiv.org/abs/math.CV/9901010](http://arXiv.org/abs/math.CV/9901010).
- [Me5] MERKER, J. : *On the partial algebraicity of holomorphic mappings between two real algebraic sets in the complex euclidean spaces of different dimensions*, Bull. Soc. Math. France **129** (2001), no.4, 547–591.
- [Me6] MERKER, J. : *Étude de la régularité analytique de l'application de symétrie CR formelle*, Preprint, June 2000. e-print : [arXiv.org/math/abs/0005290](http://arXiv.org/math/abs/0005290).
- [Me7] MERKER, J. : *Convergence of formal invertible CR mappings between minimal holomorphically nondegenerate real analytic hypersurfaces*, Int. J. Math. Math. Sci., **26** (2001), no.5, 281–302.
- [Me8] MERKER, J. : *Étude de la régularité analytique de l'application de symétrie CR formelle*, C. R. Acad. Sci. Paris Sér. I Math. **333** (2001), no.3, 165–168.
- [MM1] MERKER, J.; MEYLAN, F. : *Extension de germes de difféomorphismes CR pour une classe d'hypersurfaces analytiques réelles non essentiellement finies dans  $\mathbb{C}^3$* , Complex variables Theory Appl. **40** (1999), no.1, 19–34.
- [MM2] MERKER, J.; MEYLAN, F. : *On the Schwarz symmetry principle in a model case*, Proc. Amer. Math. Soc. **127**, (1999), no.4, 1097–1102.
- [MP1] MERKER, J.; PORTEN, E. : *On removable singularities for integrable CR functions*, Indiana Univ. Math. J. **48** (1999), no.3, 805–856.
- [MP2] MERKER, J.; PORTEN, E. : *On wedge extendability of CR-meromorphic functions*, Math. Z. (to appear).
- [Mey] MEYLAN, F. : *The reflection principle in complex space*, Indiana Univ. Math. J. **44** (1995), no.3, 783–796.
- [Mi1] MIR, N. : *An algebraic characterization of holomorphic nondegeneracy for real algebraic hypersurfaces and its application to CR mappings*, Math. Z. **231**, (1999), no.1, 189–202.
- [Mi2] MIR, N. : *Germes of holomorphic mappings between real algebraic hypersurfaces*, Ann. Inst. Fourier **48** (1998), no.3, 1025–1043.
- [Mi3] MIR, N. : *On the convergence of formal mappings*, Comm. Anal. Geom. (to appear).
- [Mi4] MIR, N. : *Formal biholomorphic maps of real analytic hypersurfaces*, Math. Res. Letters **7** (2000), no.2-3, 343–359.
- [N] NEELON, T.S. : *On solutions of real analytic equations*, Proc. Amer. Math. Soc. **125** (1997), no.3, 2531–2535.
- [P1] PINCHUK, S. : *A boundary uniqueness theorem for holomorphic functions of several complex variables*, Mat. Zametki **15** (1974), 205–212.
- [P2] PINCHUK, S. : *On proper holomorphic mappings of strictly pseudoconvex domains*, (Russian), Sibirsk. Mat. Z. **15** (1974), 909–917.
- [P3] PINCHUK, S. : *On the analytic continuation of holomorphic mappings* (Russian), Mat. Sb. (N.S.) **98(140)** (1975) no.3(11), 375–392, 416–435, 495–496.
- [P4] PINCHUK, S. : *Holomorphic mappings of real-analytic hypersurfaces* (Russian), Mat. Sb. (N.S.) **105(147)** (1978), no. 4 574–593, 640.
- [PV] PINCHUK, S.; VERMA, K : *Analytic sets and the boundary regularity of CR mappings*, Proc. Amer. Math. Soc. **129** (2001), no.9, 2623–2632.
- [Po] PORTEN, E. : *Habilitationsschrift* (In preparation).
- [R] REA, C. : *Prolongement holomorphe des fonctions CR, conditions suffisantes*, C. R. Acad. Sci. Paris Sér I Math. **297** (1983), no.3, 163–165.
- [Sha] SHAFIKOV, R. : *Analytic continuation of germs of holomorphic mappings between real hypersurfaces in  $\mathbb{C}^n$* , Michigan Math. J. **47** (2000), no.1, 133–149.
- [SS] SHARIPOV, R.; SUKHOV, A. : *On CR mappings between algebraic Cauchy-Riemann manifolds and separate algebraicity for holomorphic functions*, Trans. Amer. Math. Soc. **348** (1996), no.2, 767–780.



- [St1] STANTON, N. : *Infinitesimal CR automorphisms of rigid hypersurfaces of the space of  $n$  complex variables*, Amer. J. Math., **117** (1995), no.1, 141-167.
- [St2] STANTON, N. : *Infinitesimal CR automorphisms of real hypersurfaces*, Amer. J. Math. **118** (1996), no.1, 209-233.
- [Su1] SUKHOV, A. : *On the mapping problem for quadric Cauchy-Riemann manifolds*, Indiana Univ. Math. J. **42** (1993), no.1, 27-36.
- [Su2] SUKHOV, A. : *On CR mappings of real quadric manifolds*, Michigan Math. J. **41** (1994), no.1, 143-150.
- [Tr1] TRÉPREAU, J.-M. : *Sur le prolongement holomorphe des fonctions CR définies sur une hypersurface réelle de classe  $C^2$  dans  $\mathbb{C}^n$* , Invent. Math. **83** (1986), 583-592.
- [Tr2] TRÉPREAU, J.-M. : *Sur la propagation des singularités dans les variétés CR*, Bull. Soc. Math. Fr. **118** (1990), no.4, 403-450.
- [Tr3] TRÉPREAU, J.-M. : *Holomorphic extension of CR functions : a survey*, Partial differential equations and mathematical physics (Copenhagen, 1995 ; Lund 1995), 333-355, Progr. Nonlinear Differential Equations Appl., 21, Birkhäuser Boston, Boston, MA, 1996.
- [Tu1] TUMANOV, A.E. : *Extending CR functions on a manifold of finite type over a wedge*, (Russian), Mat. Sb. (N.S.) **136(178)** (1988), no.1, 128-139. English transl. in Math. USSR-Sb. **64** (1989) no.1, 129-140.
- [Tu2] TUMANOV, A.E. : *Connections and propagation of analyticity for CR functions*, Duke Math. J. **73** (1994), no.1, 1-24.
- [Tu3] TUMANOV, A.E. : *On the propagation of extendibility of CR functions*, Complex analysis and geometry (Trento, 1993), 479-498, Lecture Notes in Pure and Appl. Math., **173**, Dekker, New York, 1996.
- [V] VERMA, K : *Boundary regularity of correspondences in  $\mathbb{C}^2$* , Math. Z. **231** (1999), no.2, 253-299.
- [W1] WEBSTER, S.M. : *On the mapping problem for algebraic real hypersurfaces*, Invent. Math. **43** (1977), no.1, 53-68.
- [W2] WEBSTER, S.M. : *On the reflection principle in several complex variables*, Proc. Amer. Math. Soc. **71** (1978), no. 1, 26-28.
- [W3] WEBSTER, S.M. : *Holomorphic mappings of domains with generic corners*, Proc. Amer. Math. Soc. **86** (1982), no.2, 236-240.