

Strebel differentials on stable curves and Kontsevich's proof of Witten's conjecture

Dimitri Zvonkine*

November 2, 2018

Abstract

We define Strebel differentials for stable complex curves, prove the existence and uniqueness theorem that generalizes Strebel's theorem for smooth curves, prove that Strebel differentials form a continuous family over the moduli space of stable curves, and show how this construction can be applied to clarify a delicate point in Kontsevich's proof of Witten's conjecture.

1 Introduction

1.1 Motivation

The main motivation of this paper is to clarify a delicate point in Kontsevich's proof of the Witten conjecture [10]. The conjecture concerns the intersection numbers of the first Chern classes of some line bundles L_1, \dots, L_n over the Deligne-Mumford compactification $\overline{\mathcal{M}}_{g,n}$ of the moduli space of n -pointed genus g curves.

The proof by Kontsevich uses in an essential way the cell decomposition of the space $\mathcal{M}_{g,n} \times \mathbb{R}_+^n$ given by Strebel differentials. This cell decomposition has a natural closure, and it is necessary to know the relation between this closure and the Deligne-Mumford compactification of the moduli space. In his paper Kontsevich gives the answer, but the proof is only briefly sketched.

*Institut für Mathematik, Universität Zürich, Winterthurerstrasse 190, CH-8057 Zürich, Switzerland. e-mail: zvonkine@math.unizh.ch

A full proof was provided in a very thorough paper by E. Looijenga [11] (and here we give a new proof). However many people are not sure what the exact implications of Looijenga's results are. In particular, S. P. Novikov still insists that there is a gap in Kontsevich's proof. Therefore we think that it is useful to give a complete account of the situation. This paper is essentially an overview, although it contains some new results (Theorems 3 and 4 as well as a new proof of Theorem 5).

We assume that the notion of moduli space $\mathcal{M}_{g,n}$ of Riemann surfaces of genus g with n marked and numbered points is known, as well as the notion of a stable curve and that of the Deligne-Mumford compactification $\overline{\mathcal{M}}_{g,n}$ of the moduli space. We also use the standard notation L_i for the line bundle over $\overline{\mathcal{M}}_{g,n}$ whose fiber over a point $x \in \overline{\mathcal{M}}_{g,n}$ representing a stable curve C_x is the cotangent line to C_x at the i th marked point.

1.2 The main steps of the argument

Here is a sketch of what is to be or has been done to justify Kontsevich's expressions of the first Chern classes of the bundles L_i .

1. A quotient $K\overline{\mathcal{M}}_{g,n}$ of the Deligne-Mumford compactification $\overline{\mathcal{M}}_{g,n}$ by some equivalence relation is constructed. The quotient is a compact Hausdorff topological orbifold. The line bundles L_i on $\overline{\mathcal{M}}_{g,n}$ are pull-backs of some line bundles over $K\overline{\mathcal{M}}_{g,n}$, which we will also denote by L_i . The quotient $K\overline{\mathcal{M}}_{g,n}$ has only singularities of real codimension at least 2. Therefore its fundamental homology class is well-defined. The fundamental homology class of $\overline{\mathcal{M}}_{g,n}$ is sent to the fundamental homology class of $K\overline{\mathcal{M}}_{g,n}$ under the factorization.

All these facts are quite simple once the equivalence relation is given. They are formulated in Kontsevich's original paper, except for the fact that $K\overline{\mathcal{M}}_{g,n}$ is Hausdorff, which was proved by Looijenga.

2. $K\overline{\mathcal{M}}_{g,n} \times \mathbb{R}_+^n$ is homeomorphic to a cell complex A . There is a piecewise affine projection from A to \mathbb{R}_+^n that commutes with the projection from $K\overline{\mathcal{M}}_{g,n} \times \mathbb{R}_+^n$ to \mathbb{R}_+^n .

The cell complex and the homeomorphism were constructed by Kontsevich, but he omitted the proof of continuity. The proof is one of the main results of Looijenga's paper. Here we give a different proof.

3. For each line bundle L_i , one constructs a cell complex \mathcal{B}_i together with a projection $\mathcal{B}_i \rightarrow A$ satisfying the following properties. Each fiber of the projection is homeomorphic to a circle. The (real) spherization $(L_i^* \setminus$

zero section)/ \mathbb{R}_+ of the dual line bundle L_i^* is isomorphic to the circle bundle \mathcal{B}_i .

The bundles \mathcal{B}_i were constructed by Kontsevich, the isomorphism of the two bundles is immediate.

4. A connection on the bundle \mathcal{B}_i can be explicitly given. Its curvature represents the first Chern class of the bundle.

The connection and the curvature were written out by Kontsevich. However, they are only piecewise smooth forms defined on a cell complex that is not homeomorphic to a smooth orbifold. Therefore one should explain why (and in what sense) the curvature indeed represents the first Chern class correctly. This issue does not seem to have been raised in the literature. We deal with it here in Section 5.

Thus the goal of this paper is to give a complete proof of the following theorem.

Consider a point $\mathbf{p} = (p_1, \dots, p_n) \in \mathbb{R}_+^n$. Denote by $A_{\mathbf{p}}$ the preimage of \mathbf{p} under the projection from A to \mathbb{R}_+^n . Then $A_{\mathbf{p}}$ is also a cell complex.

Theorem 1 *To each bundle L_i one can assign a piecewise smooth 2-form ω_i on the cell complex A in such a way that*

$$\int_{\overline{\mathcal{M}}_{g,n}} c_1(L_1)^{d_1} \dots c_1(L_n)^{d_n} = \int_{\substack{\text{cells of top} \\ \text{dimension of } A_{\mathbf{p}}}} \omega_1^{d_1} \dots \omega_n^{d_n}$$

for every $\mathbf{p} \in \mathbb{R}_+^n$.

1.3 The organization of the paper

This paper is organized as follows.

In Section 2 we review the notion of Strebel differentials for smooth curves and give, without proof, two examples of its degeneration as a curve tends to a singular stable curve in $\overline{\mathcal{M}}_{g,n}$.

In Section 3 we review the notion of dualizing sheaf for a stable curve and define Strebel differentials for nonsmooth stable curves. We show that Strebel differentials with given perimeters p_1, \dots, p_n form a continuous section of the vector bundle of quadratic differentials over $\overline{\mathcal{M}}_{g,n}$. This theorem does not, as far as we know, appear in the literature.

In Section 4 we describe the compactification $K\overline{\mathcal{M}}_{g,n}$ and the cell complex A homeomorphic to $K\overline{\mathcal{M}}_{g,n} \times \mathbb{R}_+^n$. We prove that they are indeed homeomorphic, and also briefly sketch Looijenga's proof [11].

In Section 5 we describe a framework that allows one to work with differential forms on cell complexes. The forms representing the connections on the bundles \mathcal{B}_i and their curvatures fit into this framework and thus their use is justified.

1.4 Acknowledgements

I am grateful to E. Looijenga for pointing out the references [11], [8], and [9], to M. Kontsevich, S. Lando, C. Maclean, G. Shabat, and K. Strebel for useful discussions and for their interest in the subject, and to A. Zvonkin for his remarks on the text.

2 Strebel's theorem

2.1 The case of smooth curves: a review

Let C be a Riemann surface. A *simple differential* on C is a meromorphic section of its cotangent bundle. In a local coordinate z , it can be written as $f(z)dz$, where f is a meromorphic function. A *quadratic differential* is a meromorphic section of the tensor square of the cotangent bundle. In a local coordinate z , it can be written as $f(z)dz^2$.

Let φ be a quadratic differential and $z_0 \in C$ a point that is neither a pole nor a zero of φ . Then φ has a square root in the neighborhood of z_0 : it is a simple differential γ , unique up to a sign, such that $\gamma^2 = \varphi$. The integral

$$\int_{z_0}^z \gamma$$

is a biholomorphic mapping from a neighborhood of z_0 in C to a neighborhood of 0 in \mathbb{C} . The preimages of the horizontal (vertical) lines in \mathbb{C} under this mapping are called *horizontal (vertical) trajectories* of the quadratic differential φ . Because γ is defined up to a sign these trajectories do not have a natural orientation.

If z_0 is a double pole, then in the neighborhood of z_0 the quadratic differential φ has an expansion

$$\varphi = a \frac{dz^2}{(z - z_0)^2} + \dots$$

The complex number a is called the *residue* of the double pole and does not depend on the choice of the local coordinate.

By a local analysis, it is easy to see that if z_0 is a d -tuple zero of φ , then there are $d + 2$ horizontal trajectories issuing from z_0 . Further, if z_0 is a simple pole, then there is a unique horizontal trajectory issuing from z_0 . Finally, if z_0 is a double pole whose residue is a negative real number $a = -(p/2\pi)^2$, then z_0 is surrounded by closed horizontal trajectories (see Figure 5 (b)). These trajectories, together with z_0 , form a topological open disc in C . In the metric $|\varphi|$ all these trajectories have the same length p . The other possible cases are the case of a double pole with a positive real or a nonreal residue and the case of poles of order greater than 2. We will not need them, so we leave them to the reader.

Now we are ready to formulate Strebel's theorem.

Let C be a connected (not necessarily compact) Riemann surface without boundary with $n \geq 1$ distinct marked and numbered points z_1, \dots, z_n . We will be interested only in the case where C is a surface of genus g with a finite number of punctures. (The punctures and the marked points are two different things and are pairwise distinct.) However Theorem 2 below is applicable to any hyperbolic surface C , i.e., whenever the universal covering of $C \setminus \{z_1, \dots, z_n\}$ is the Poincaré disc. For example, C can be a ring, a torus with a puncture, a surface of genus 2 with a hole, or a surface of infinite genus.

In his book on quadratic differentials Strebel proves the following theorem ([13], Theorem 23.5 and Theorem 23.2 for $n = 1$).

Theorem 2 *For any positive real numbers p_1, \dots, p_n there exists a unique quadratic differential φ on C satisfying the following conditions. (i) It has double poles at the marked points and no other poles. (ii) The residue at z_i equals $-(p_i/2\pi)^2$. (iii) If we denote by D_i the disc domain formed by the closed horizontal trajectories of φ surrounding z_i , then*

$$\bigcup_i \overline{D_i} = C.$$

Definition 2.1 A quadratic differential satisfying the above conditions is called a *Strebel differential*.

If C is a compact surface of genus g , then the nonclosed horizontal trajectories of a Strebel differential φ form a connected graph embedded into C . All its vertices (situated at the zeroes of φ) have degrees ≥ 3 . Its edges have natural lengths (measured with the length measure $\sqrt{|\varphi|}$). Its faces are the disc domains D_i and are in a one-to-one correspondence with the marked points. The perimeter of the i th face equals p_i . Each face D_i , punctured at its marked point, has a natural flat Riemannian metric $|\varphi|$. In this metric it is isometric to a semi-infinite cylinder whose base is a circle of length p_i .

Definition 2.2 An *embedded* or *ribbon* graph is a connected graph endowed with a cyclic order of the half-edges issuing from each vertex.

It is a standard fact that any given cyclic order allows one to construct a unique embedding of the graph into a surface. If an abstract graph is embedded into a surface, the cyclic order of the half-edges adjacent to a vertex is just the counterclockwise order.

On the set H of the half-edges of the graph we introduce three permutations: σ_0 is the product of the cyclic permutations assigned to the vertices, σ_1 is the involution without fixed points that exchanges the half-edges of each edge, $\sigma_2 = \sigma_0^{-1}\sigma_1$ is the permutation whose cycles correspond to the faces of the ribbon graph. These permutations sum up all the information about the ribbon graph.

Proposition 2.3 *If we are given a ribbon graph with n numbered faces, endowed with edge lengths, and such that each vertex has a degree at least 3, then there is a unique way to recover a Riemann surface C with n marked points and to determine the perimeters p_i in such a way that the ribbon graph is the graph of nonclosed horizontal trajectories of the corresponding Strebel differential.*

The construction given in the proof is described, for example, in [10], Section 2.2.

Proof of Proposition 2.3. To find the perimeters p_i we just add up the lengths of the edges surrounding each face.

The Riemann surface is obtained in the following way. To every oriented edge of the ribbon graph we assign a strip $[0, l] \times [0, +i\infty[$ in the complex

plane, where l is the length of the edge. This strip inherits the standard complex structure from the complex plane. Now we construct our surface by gluing together the strips corresponding to all the oriented edges (Figure 1).

First, for every edge, we glue together the two strips that correspond to the two ways of orienting this edge. The segment $[0, l]$ is identified with $[l, 0]$ and the complex structure is extended in the natural way. Now we glue together, along the sides $[0, +i\infty[$, the strips that correspond to neighboring edges in the same face. The complex structure is extended naturally to $]0, +i\infty[$. It remains to extend the complex structure to the vertices of the ribbon graph and to the n punctured points.

At a vertex of degree k there are $2k$ right angles of strips that meet together, that is, in whole, an angle of $k\pi$. Let us place the vertex at the origin of the complex plane and put the strips on the plane one after another around the vertex (so that the 5th strip will overlap with the 1st one, the 6th one with the 2nd one, and so on). If z is the coordinate on the complex plane, we introduce a local coordinate at the neighborhood of the vertex using the function $z^{2/k}$.

Finally, consider a marked point and the semi-infinite cylinder formed by the strips that surround it. Let h be the height of a point in this cylinder and $\theta \in [0, 2\pi[$ its argument (the origin of the angles can be chosen arbitrarily). Then $e^{i\theta-h}$ is a local coordinate in the neighborhood of the marked point.

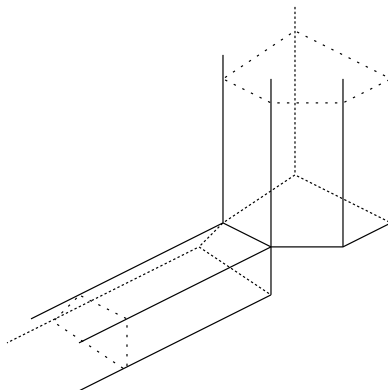

Figure 1: Gluing a Riemann surface from strips.

The uniqueness of the Riemann surface is proved in the following way. Consider a Strebel differential on a Riemann surface. Let us cut the Riemann

surface along the nonclosed horizontal trajectories of the Strebel differential and along its vertical trajectories joining the marked points to the vertices of the ribbon graph (the zeroes of the differential). We obtain the set of strips described above. Therefore our Riemann surface is necessarily glued of strips as in the above construction. \diamond

Denote by B_i the polygon (the face of the graph) that forms the boundary of the i th disc domain D_i . (If D_i is adjacent to both sides of an edge e , this edge appears twice in the polygon B_i .) Further, denote by T_i the complex line tangent to C at z_i and by $ST_i = (T_i \setminus \{0\})/\mathbb{R}_+$ its real spherization. (Here and below \mathbb{R}_+ is the set of positive real numbers.) Then there exists a canonical identification

$$B_i = ST_i.$$

Indeed, given a direction $u \in ST_i$, there is a unique vertical trajectory of φ issued from z_i in the direction u . This trajectory meets the polygon B_i at a unique point, and this point will be identified with u .

Thus Strebel's theorem allows us to define n polygonal bundles \mathcal{B}_i over $\mathcal{M}_{g,n} \times \mathbb{R}_+^n$ and these bundles can be identified with the circle bundles obtained by a real spherization of the complex line bundles L_i^* . (Recall that the fiber of the bundle L_i is the cotangent line to C at z_i .)

We are going to show that these polygonal bundles can be extended to $\overline{\mathcal{M}}_{g,n} \times \mathbb{R}_+^n$, where $\overline{\mathcal{M}}_{g,n}$ is the Deligne-Mumford compactification, so that the identification above is preserved.

2.2 Two examples

To extend the bundles \mathcal{B}_i over $\overline{\mathcal{M}}_{g,n}$, we need to extend to stable curves the notion of Strebel differentials. The construction is carried out in the next section. Here we just give two examples, without any proofs.

Example 2.4 Consider the case of a torus with one marked point that degenerates into a sphere with one marked point and two identified points (see Figure 2; the marked point is represented as a black dot). Fix a positive real number p . On every torus there exists a unique Strebel differential with residue $-(p/2\pi)^2$ at the marked point. It determines a 1-faced embedded (ribbon) graph composed of the nonclosed horizontal trajectories. This graph is either a hexagon whose opposite edges are glued together in pairs,

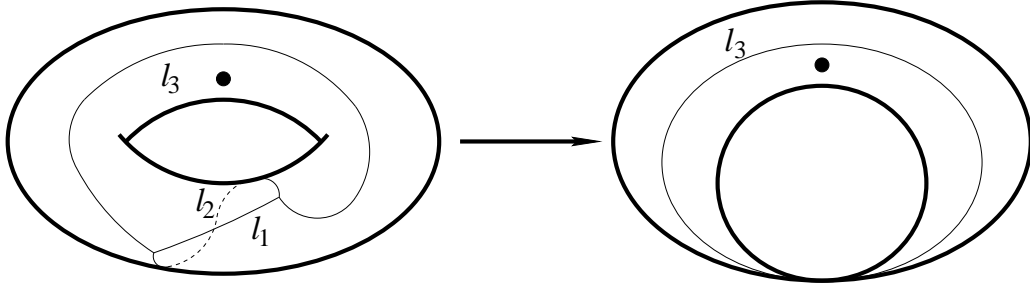

Figure 2: A torus degenerating into a sphere with two identified points.

or a quadrilateral whose opposite edges are glued together in pairs. In the figure we represented a hexagon.

Now, when the torus degenerates into a sphere, the lengths of the edges l_1 and l_2 tend to 0. Thus, on the sphere we obtain a graph with only one edge of length $l_3 = p/2$. This edge joins the two identified points. If we put the identified points at 0 and ∞ , and the marked point at 1, then the limit Strebel differential on the sphere equals

$$\varphi = -(p/2\pi)^2 \frac{dz^2}{z(z-1)^2}.$$

It has simple poles at the identified points 0 and ∞ .

Example 2.5 Now consider a sphere with four marked points that degenerates into a reducible curve consisting of two spherical components intersecting at one point (Figure 3). Assume that the first component contains the marked points z_1 and z_2 , while the second component contains the marked points z_3 and z_4 . Fix 4 positive real numbers p_1, p_2, p_3, p_4 . We will assume that $p_1 > p_2$, but $p_3 = p_4$ (in order to obtain two different pictures on the two components).

For any positions of the fixed points on the sphere \mathbb{CP}^1 , there is a unique Strebel differential with residues $-(p_i/2\pi)^2$ at the marked points z_i . This differential determines a 4-faced graph on \mathbb{CP}^1 . As the curve approaches the degeneration described above, this graph necessarily becomes of a particular form. Namely, it will contain a simple cycle, formed by several edges, separating the marked points z_1 and z_2 from the marked points z_3 and z_4 . In other words, the faces number 1 and 2 become adjacent as well as the faces 3

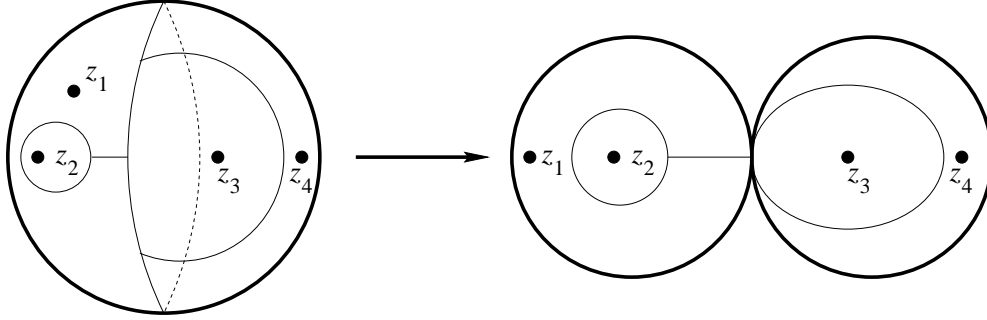

Figure 3: A sphere degenerating into a curve with two spherical components.

and 4. When the curve degenerates, the lengths of all the edges in the above cycle tend to 0.

On the first component we obtain a graph with 2 vertices. The vertex at the nodal point has degree 1, the second vertex has degree 3. The corresponding quadratic differential has a simple pole at the nodal point and a simple zero at the other vertex (and, of course, double poles at the marked points).

On the second component we obtain a graph with a unique vertex of degree 2 at the nodal point. The corresponding quadratic differential does not have zeros or poles (except the double poles at the marked points).

3 Simple, quadratic, and Strebel differentials on nonsmooth stable curves

3.1 Simple differentials

Definition 3.1 Let C be a stable curve with n marked points z_i . A *simple differential* γ on C is a meromorphic differential defined on each component of C and satisfying the following properties. (i) It has at most simple poles at the marked points and at the nodal points, but no other poles. (ii) For each nodal point, the sum of the residues of the poles of γ on the two components meeting at this point vanishes.

One can readily check that simple differentials form a vector space V of dimension $g + n - 1$ (if $n \geq 1$) for any stable curve of arithmetic genus g , whether it is smooth or not.

Indeed, consider a stable curve with several irreducible components C_i . Suppose C_i is of genus g_i , has n_i marked points and m_i nodal points. Then we have

$$n = \sum n_i, \quad 2 - 2g = \sum (2 - 2g_i - m_i)$$

Now, according to the Riemann-Roch theorem, the dimension of the space of sections of a line bundle with first Chern class c , such that at most simple poles are allowed at k fixed points, is equal to $c + k + 1 - g$, whenever $c + k \geq 2g - 1$. In our case, on C_i , $c = 2g_i - 2$ (the first Chern class of the cotangent line bundle) and $k = n_i + m_i$. Thus the dimension of the space of sections equals $g_i + n_i + m_i - 1$. Adding these numbers for all the irreducible components C_i and subtracting the total number $\frac{1}{2} \sum m_i$ of nodal points (because each nodal point gives a linear relation on the residues) we obtain $g + n - 1$.

Because the dimensions of the spaces V are the same, these spaces form a holomorphic vector bundle \overline{V} over the space $\overline{\mathcal{M}}_{g,n}$. This follows immediately from algebro-geometric arguments. Indeed, denote by $\overline{\mathcal{C}}_{g,n}$ the universal curve over $\overline{\mathcal{M}}_{g,n}$. Then simple differentials form a sheaf on $\overline{\mathcal{C}}_{g,n}$. It is called the *relative dualizing sheaf* and is the sheaf of sections of a line bundle (the relative cotangent line bundle) over $\overline{\mathcal{C}}_{g,n}$. (See, for example, [6], Chapter III, Theorem 7.11, where it is proved that the dualizing sheaf is the sheaf of sections of a line bundle for any algebraic variety that is locally a complete intersection, and an explicit construction of the sheaf is given. See also [5], Chapter 3, Section A.) The direct image of the relative dualizing sheaf on $\overline{\mathcal{M}}_{g,n}$ has the property that the dimensions of its fibers are the same. Therefore the direct image is itself the sheaf of sections of a vector bundle (see [6], Exercise 5.8).

The fact that the spaces V form a holomorphic vector bundle can also be understood more intuitively. The space of pairs (C, γ) , where C is a stable curve and γ a simple differential on it, can be given a complex structure in the following way. For any pair (C, γ) , one can calculate the integral of γ over any closed loop that does not contain marked or nodal points. The complex structure is introduced by requiring that these integrals be meromorphic functions on the space of pairs (C, γ) . (That these integrals can have poles is shown by the following example. Consider a torus whose meridian is

contracted, so that it degenerates into a sphere with two identified points. Then the integral of a simple differential over the parallel will tend to ∞ .)

3.2 Quadratic differentials

Now we repeat the above construction for quadratic differentials.

Definition 3.2 Let C be a stable curve with n marked points z_i . A *quadratic differential* φ on C is a meromorphic quadratic differential defined on each component of C and satisfying the following properties. (i) It has at most double poles at the marked points and at the nodal points, but no other poles. (ii) For each nodal point, the residues of the poles of φ on the two components meeting at this point are equal.

Remark 3.3 The residue of a quadratic differential at a pole of order at most 2 is equal to the coefficient of dz^2/z^2 (for any local coordinate z). If the order of the pole is actually less than 2, we let the residue be equal to 0.

As above, the dimension of the space W of quadratic differentials is the same for any stable curve C and equals $3g - 3 + 2n$.

Indeed, if C_i is an irreducible component of C , that has genus g_i and contains n_i marked points and m_i nodal points, then the dimension of the space of quadratic differentials on it is $3g_i - 3 + 2n_i + 2m_i$. Adding these numbers for all the components and subtracting the total number $\frac{1}{2} \sum m_i$ of the nodal points (because each nodal point gives a linear relation on the residues), we obtain $3g - 3 + 2n$.

Since the dimensions of the spaces W are the same, they form a holomorphic vector bundle \overline{W} over $\overline{\mathcal{M}}_{g,n}$. This follows from the same arguments as for simple differentials. The quadratic differentials form a sheaf on the universal curve $\overline{\mathcal{C}}_{g,n}$: the sheaf of sections of the tensor square of the relative cotangent line bundle. The direct image of this sheaf on $\overline{\mathcal{M}}_{g,n}$ has the property that all its fibers are of the same dimension. Therefore it is a sheaf of sections of a holomorphic vector bundle.

3.3 Strebel differentials

Here we define Strebel differentials on stable curves.

Let C be a stable curve with n marked points. Suppose we are given n positive real numbers p_1, \dots, p_n .

Definition 3.4 We say that an irreducible component of a stable curve C is *marked* if it contains at least one marked point and *unmarked* if it contains no marked points.

Definition 3.5 A *Strebel differential* φ on a stable curve C is a quadratic differential on C satisfying the following properties. (i) It has double poles at the marked points, at most simple poles at the nodal points, and no other poles. (ii) The residue of the pole at the i th marked point z_i equals $-(p_i/2\pi)^2$. (iii) The differential φ vanishes identically on the unmarked components. (iv) Let C' be a marked component of C . Let us puncture C' at the nodal points. For $z_i \in C'$, denote by D_i the disc domain formed by the closed horizontal trajectories of φ surrounding z_i . Then we have

$$C' = \bigcup_{i|z_i \in S} \overline{D}_i.$$

Remark 3.6 Strebel differentials have at most simple poles at the nodes of C (unlike generic quadratic differentials, that have double poles). Therefore the condition that the residues of the poles on the two components meeting at a nodal point must be equal is automatically satisfied, since both residues vanish.

Remark 3.7 It follows from Strebel's theorem, that (once the positive numbers p_1, \dots, p_n are given) there exists a unique Strebel differential φ on any stable curve C . Its restriction to unmarked components vanishes. Its restriction to each marked component C' is the Strebel differential on C' with punctures at the nodal points. Indeed, it is easy to see that when we put the punctures back into the component C' , the corresponding Strebel differential will have at most simple poles at these points, because there is only a finite number of nonclosed horizontal trajectories issuing from them.

Remark 3.8 Let C_1 be a smooth compact Riemann surface with n marked points, and let C_2 be obtained by puncturing C_1 at a finite number of points (different from the marked points). Given a list of positive real parameters p_1, \dots, p_n , there is a unique Strebel differential φ_1 on C_1 and a unique Strebel differential φ_2 on C_2 . At first sight, one could think that they are the same; but, in general, this is not true. Indeed, if we restrict φ_1 to C_2 , we will see that the disc domains of φ_1 contain punctures at their interior, which is not allowed for a Strebel differential. Conversely, if we try to extend φ_2 to C_1 by

putting back the punctured points, we will, in general, obtain simple poles at these points. Again, a Strebel differential is not allowed to have poles outside the marked points.

Thus in the condition (iv) in Definition 3.5 above, it is important to puncture each component C' at the nodal points.

As in the case of smooth compact Riemann surfaces, the nonclosed horizontal trajectories of a Strebel differential on a stable curve form a graph, embedded into the stable curve. More precisely, it is embedded into the union of the marked components of the stable curve. The vertices of the graph are of degrees ≥ 3 , except for the vertices that lie at the nodal points and can have any degree ≥ 1 . Its edges have natural lengths (measured, as before, with $\sqrt{|\varphi|}$). Its faces are in a one-to-one correspondence with the marked points, and the perimeter of the i th face equals p_i . As before, if we denote by B_i the polygon surrounding the i th face of the graph, by T_i the complex line tangent to the marked point z_i , and by $ST_i = (T_i \setminus \{0\})/\mathbb{R}_+$ its real spherization, we have a canonical identification

$$B_i = ST_i.$$

3.4 Stable ribbon graphs

In Section 4 we will need a formal definition of a graph formed by the non-closed horizontal trajectories of a Strebel differential on a stable curve. We give the definition here.

To understand the definition below one must imagine that we have contracted to a point each unmarked component of the stable curve. Thus we have obtained a graph embedded into a new (usually singular) curve.

The unmarked components of the initial stable curve form a not necessarily connected subcurve in it. Each connected component of this subcurve is contracted to a vertex of our graph. On each such vertex we will mark the arithmetic genus of the corresponding contracted component.

If a vertex v of the graph lies at a node of the curve, there is no longer any natural cyclic order on the half-edges issuing from it. Instead, we will have a permutation (with several cycles) acting on these half-edges. Each cycle of this permutation corresponds to a component of the curve at the neighborhood of v . The cycle determines the counterclockwise cyclic order of the half-edges on the corresponding component.

Definition 3.9 A *stable ribbon graph* is a connected graph endowed with the following structure. (i) A non-negative integer (a *genus defect*) is assigned to each vertex. (ii) A permutation acting on the set of half-vertices issuing from each vertex is given.

There are two types of vertices whose genus defect cannot be equal to 0: first, the vertices of degree 1, second, the vertices of degree two such that the corresponding permutation of the two half-edges is a transposition.

Kontsevich ([10], Appendix B) gives an equivalent definition of stable ribbon graphs. A stable ribbon graph is represented in Figure 4. Its surface of embedding (that can be uniquely reconstructed from the stable ribbon graph structure) is shown in dotted lines.

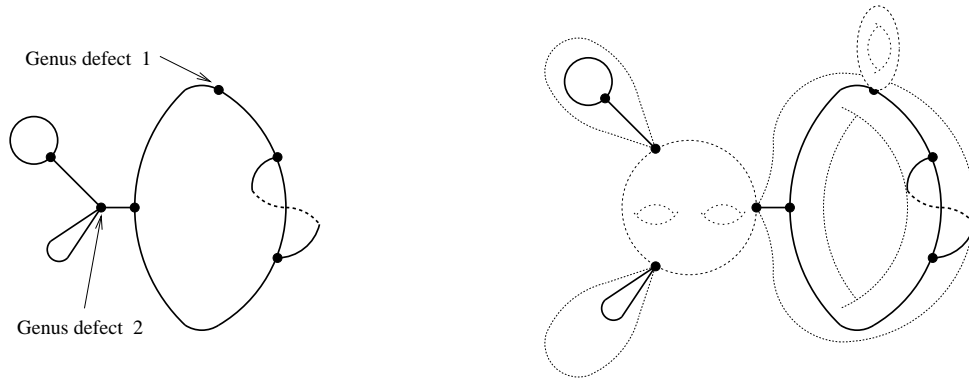

Figure 4: A stable ribbon graph and its surface of embedding.

It is easy to define faces of a stable graph. Let H be the set of all the half-edges of the graph, σ_0 the product of all the permutations (with disjoint supports) assigned to the vertices, and σ_1 the involution without fixed points that switches two half-edges of each edge. Then a face is a cycle of the permutation $\sigma_2 = \sigma_0^{-1}\sigma_1$. The permutations σ_0 , σ_1 , and σ_2 sum up all the structure of a stable ribbon graph, except the genus defect function. We will usually consider stable graphs with n numbered faces.

The *genus* of a stable ribbon graph is the arithmetic genus of its surface of embedding, plus the sum of genus defects of all its vertices.

In Section 4 we will see that stable graphs are obtained from ordinary ribbon graphs by edge contractions.

Proposition 3.10 *Given a stable ribbon graph with n numbered faces and endowed with edge lengths, we can find a set of perimeters p_1, \dots, p_n and a stable curve such that the stable ribbon graph is the graph of nonclosed horizontal trajectories of the corresponding Strebel differential. The marked components of the curve are uniquely determined.*

Proof. To find the perimeters we simply add up the lengths of the edges surrounding each face. To construct a stable curve we carry out the same operations of strip gluings as in the proof of Proposition 2.3. This gives us the complex structure on the marked components. That it is unique is shown as in Proposition 2.3. As for the unmarked components, their arithmetic genera are given by the genus defect function of the stable ribbon graph, but their complex structures and even their topologies can be chosen arbitrarily. \diamond

3.5 Strebel differentials form a continuous family

Here we prove the continuity of the map that assigns to a stable curve and a list of perimeters in $\overline{\mathcal{M}}_{g,n} \times \mathbb{R}_+^n$ the corresponding Strebel differential in the total space of the vector bundle $\overline{\mathcal{W}}$ of quadratic differentials over $\overline{\mathcal{M}}_{g,n}$. In particular, Strebel differentials with fixed perimeters form a continuous section of the vector bundle $\overline{\mathcal{W}}$ over $\overline{\mathcal{M}}_{g,n}$. This fact does not seem to be stated explicitly in the literature, although it would not be a surprise for a specialist in Teichmüller spaces.

We will need a rather well-known characterization of convergence in $\overline{\mathcal{M}}_{g,n}$ and in the total space of the vector bundle $\overline{\mathcal{W}}$ of quadratic differentials.

We view a complex structure on a surface as an operator J that multiplies each tangent vector by i . We also remind the reader that quadratic differentials have at most double poles at the marked points, at most double poles with equal residues at the nodes, and no other poles.

Definition 3.11 A continuous map $f : C_1 \rightarrow C_2$ from a stable curve to another one is called a *deformation* if (i) the preimage of any node of C_2 is either a node of C_1 or a simple loop in the smooth part of C_1 , (ii) f is an orientation-preserving diffeomorphism outside the nodes and loops, and (iii) f sends the marked points to the marked points preserving their numbers.

For a summary of various properties of deformations and their relations with augmented Teichmüller spaces see [2]. See also [1] for related questions

on the topology of the Teichmüller spaces.

Proposition 3.12 *Let $(C_m, \varphi_m) \rightarrow (C, \varphi)$ be a converging sequence in $\overline{\mathcal{W}}$ and denote by J_m and J the complex structures on C_m and C . Starting from some m there exists a sequence of deformations $f_m : C_m \rightarrow C$ such that:*

- (i) *on any compact set $K \subset (C \setminus \text{nodes})$ the sequence of complex structures $(f_m)_* J_m$ converges uniformly to J ;*
- (ii) *on any compact set $K \subset (C \setminus \text{nodes and marked points})$ the sequence of complex-valued symmetric 2-forms $(f_m)_* \varphi_m$ converges uniformly to φ .*

Sketch of a proof. Consider a point $x \in \overline{\mathcal{M}}_{g,n}$ and the corresponding stable curve with marked points C_x . Let $(U, \text{Stab } x)$ be a sufficiently small chart containing x , where U is an open ball in \mathbb{C}^{3g-3+n} and $\text{Stab } x$ a finite group acting on U and stabilizing x . The neighborhood of x in $\overline{\mathcal{M}}_{g,n}$ is identified with $U/\text{Stab } x$. Consider the part of the universal curve $\overline{\mathcal{C}}_U$ that lies over U . It is a fiber bundle over U whose fibers are stable curves parameterized by the points of U . Even as a smooth manifold $\overline{\mathcal{C}}_U$ is, of course, not a direct product with U , because its fibers have different topologies. However, there exists a continuous function $f : \overline{\mathcal{C}}_U \rightarrow C_x$ with the following properties. (i) The restriction of f to any fiber C_y is a deformation $C_y \rightarrow C_x$ in the sense of Definition 3.11. (ii) The function f is smooth on $\overline{\mathcal{C}}_U$ outside the preimages of the nodes of C_x . (iii) The restriction of f to C_x is the identity map.

The function f is a kind of universal family of deformations over the open set U . Such a function can be constructed, for example, in the following way. First of all, let us choose the loops to be contracted by f in each fiber C_y . Their free homotopy types are uniquely determined by the property that we must obtain the curve C_x by pinching all these loops. We choose the loops themselves to be the shortest geodesics inside the corresponding homotopy classes, with respect to the unique complete metric of curvature -1 on C_y , compatible with the conformal structure. Erasing all the loops and the nodes in each fiber we obtain a locally trivial fiber bundle over a contractible base U . Therefore we can trivialize it by a diffeomorphism

$$(\overline{\mathcal{C}}_U \setminus \text{nodes and loops}) \rightarrow U \times (C_x \setminus \text{nodes})$$

commuting with the projections to U . We take f to be the second component of this diffeomorphism and we extend it to the loops in every fiber C_y by sending them to the corresponding nodes of C_x .

For m big enough, C_m lies in U (or, more precisely, in $U/\text{Stab } x$, but we can choose any lifting of C_m to U). For a compact set $K \subset (C \setminus \text{nodes})$ there is, on the whole set $f^{-1}(K)$, a smooth linear operator J_U acting on tangent planes to the fibers of $\overline{\mathcal{C}}_U$. Therefore the sequence $f_* J_m$ converges uniformly on K to the complex structure J of the stable curve C_x . This proves Assertion (i) of the proposition.

Now consider a holomorphic section of the vector bundle $\overline{\mathcal{W}}_U$ over U . It is represented by a holomorphic section of a line bundle over the universal curve $\overline{\mathcal{C}}_U$, namely, of the tensor square of the relative dualizing bundle. Almost each fiber of this line bundle is naturally identified with the tensor square of the cotangent line to the corresponding stable curve at the corresponding point. The only exceptions are the fibers over the marked and the nodal points. First assume for simplicity that our sequence (C_m, φ_m) belongs to (or, more precisely, is a restriction of) some holomorphic section of $\overline{\mathcal{W}}_U$. Then, exactly as before, we conclude that if $K \subset (C_x \setminus \text{nodes and marked points})$ is a compact set, the sequence of quadratic differentials $f_* \varphi_m$ converges uniformly on K to the quadratic differential φ . In general, the sequence (C_m, φ_m) does not belong to a holomorphic section of $\overline{\mathcal{W}}_U$. Then we have to consider a family of $\text{rk } \overline{\mathcal{W}}$ holomorphic sections of $\overline{\mathcal{W}}_U$ over U , forming a basis of each of its fibers. The coordinates of the elements of the sequence (C_m, φ_m) in the basis formed by the sections converge to the coordinates of (C, φ) . Applying to each section of the family the above argument, we conclude that sequence $f_* \varphi_m$ converges to φ uniformly on K . This proves Assertion (ii) of the proposition. \diamond

Theorem 3 *The Strebel differentials with fixed parameters p_1, \dots, p_n form a continuous nonvanishing section of the vector bundle $\overline{\mathcal{W}}$ of quadratic differentials over the Deligne-Mumford compactification $\overline{\mathcal{M}}_{g,n}$.*

Proof. Let us fix a stable curve C and consider a sequence of smooth curves C_m that tends to C in $\overline{\mathcal{M}}_{g,n}$ as m tends to ∞ . By Strebel's theorem (Theorem 2) and Remark 3.7 there is a unique Strebel differential φ_m on each curve C_m and a unique Strebel differential φ on C . We will prove that φ_m tends to φ in the vector bundle $\overline{\mathcal{W}}$, as m tends to ∞ . This is enough to prove the theorem, since smooth curves form an open dense subset of $\overline{\mathcal{M}}_{g,n}$.

First of all, the sequence of quadratic differentials φ_m is bounded, therefore it has at least one limit point $\tilde{\varphi}$. We will prove that $\tilde{\varphi} = \varphi$, which implies that the limit point is unique and is therefore a true limit. To do

that, we study the limit quadratic differential $\tilde{\varphi}$ and prove that it has all the properties of a Strebel differential.

For shortness we will call just “trajectories” the horizontal trajectories of the differentials.

1. The nonclosed trajectories of $\tilde{\varphi}$ have a finite total length.

Let $x \in C$ be a regular point that is neither a zero nor a pole of $\tilde{\varphi}$. Let $x_m \in C_m$ be a sequence of points of the curves C_m that tends to x in the universal curve $\overline{\mathcal{C}}_{g,n}$ over $\overline{\mathcal{M}}_{g,n}$. By moving each x_m slightly inside C_m we can assume that each x_m belongs to a closed horizontal trajectory of φ_m , because the union of closed trajectories is dense in each curve C_m . Moreover, by extracting a subsequence we can assume that all these closed trajectories belong to the disc domains D_i for the same i . Therefore each closed trajectory has the same length p_i . We will prove that x is contained either in a closed trajectory or in a nonclosed trajectory shorter than p_i .

Suppose that moving along the trajectory through $x \in S$ we have covered a segment of length $l > p_i$ without encountering a nonregular point (a pole, a node, or a zero) and without passing twice through the same point. The above segment has a compact neighborhood K that does not contain marked points, nodes of C , or zeroes of $\tilde{\varphi}$. Using Proposition 3.12 we can construct a sequence of deformations $f_m : C_m \rightarrow C$ in such a way that the sequences of complex structures $(f_m)_* J_m$ and of quadratic differentials $(f_m)_* \varphi_m$ converge uniformly on K . Therefore, for m big enough, the trajectory through x_m of the quadratic differential φ_m will also have a segment of length greater than p_i . This is a contradiction. Thus, if x is a regular point of $\tilde{\varphi}$, the trajectory through x is either closed or nonclosed of finite length.

By compactness of C , a nonclosed trajectory of finite length necessarily has two endpoints in C . These endpoints can be zeroes of $\tilde{\varphi}$, simple poles of $\tilde{\varphi}$ (including possible simple poles at the nodes of C), or nodes of C at which $\tilde{\varphi}$ has no poles. Since the number of such points is finite and there is only a finite number of nonclosed trajectories issuing from each of them, it follows that the total number of nonclosed trajectories is finite.

2. Each closed trajectory of $\tilde{\varphi}$ bounds a disc with a unique marked point inside it.

If the trajectory α through x is closed, consider a compact tubular neighborhood K of α that does not contain marked points, nodes of C , and zeroes of $\tilde{\varphi}$. We construct a sequence of deformations $f_m : C_m \rightarrow C$ as in Proposition 3.12.

For m big enough $f_m^{-1}(K)$ contains a closed trajectory α_m of the Strebel

differential φ_m . Indeed, let l be a real number greater than any of the perimeters p_i . If we choose m big enough and a point $x_m \in C_m$ close enough to $f_m^{-1}(x)$, a segment of length l of the trajectory of φ_m through x_m will be entirely contained in $f_m^{-1}(K)$. But for a generic choice of x_m the trajectory through x_m is closed of length less than l . Therefore we have obtained a closed trajectory α_m entirely contained in $f_m^{-1}(K)$. Its homotopy type is uniquely determined by K . Indeed, α_m can neither bound a small disc inside $f_m^{-1}(K)$ (because φ_m has no poles inside $f_m^{-1}(K)$), nor have self-intersections.

We know that this closed trajectory belongs to a disc domain D of φ_m and that the restriction of f_m to D is a diffeomorphism. Thus α , just as α_m , surrounds a disc that contains a unique marked point.

Note that we have always assumed that x is not a zero of $\tilde{\varphi}$. Therefore we still know nothing about the existence of irreducible components of C on which $\tilde{\varphi}$ vanishes identically.

3. The poles of $\tilde{\varphi}$ at the nodes of C are at most simple.

Consider a nodal point x of C , and let us prove that the pole of $\tilde{\varphi}$ at x is not double, as for a generic quadratic differential, but at most simple (on both components meeting at x). Suppose that this is not true, and both poles of $\tilde{\varphi}$ are double (and have the same residue, as is always the case for quadratic differentials). Then the common residue is necessarily a negative real number. Indeed, otherwise a neighborhood of x entirely consists of non-closed trajectories of $\tilde{\varphi}$ of infinite lengths (see Figure 5a), which contradicts 1. If the common residue is a negative real number, then the point x is surrounded (on both components) by concentric closed trajectories (Figure 5b). Each of these trajectories must surround a unique marked point. But this would mean that C is composed of 2 spherical irreducible components with one marked point and one nodal point of each. This is impossible because the curve C is stable. Thus $\tilde{\varphi}$ cannot have double poles at nodal points.

To get a better insight why double poles are impossible at the nodes of C , we have represented (Figures 6 and 7) two families of curves with quadratic differentials, degenerating to a nodal curve C on which the limit quadratic differential has a double pole at a node. All the quadratic differentials in question have only a finite number of nonclosed horizontal trajectories. However, in the first case, the limit curve C is not stable, while in the second case, the quadratic differentials before the limit have cylindrical domains.

4. On components without marked points we have $\tilde{\varphi} = 0$.

Now consider an unmarked component C' of C (see Definition 3.4). Suppose $\tilde{\varphi}$ is not identically equal to zero on this component. Then $\tilde{\varphi}$ has only a

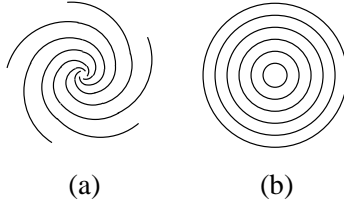

Figure 5: Horizontal trajectories near a double pole for: (a) not a real negative residue; (b) a real negative residue.

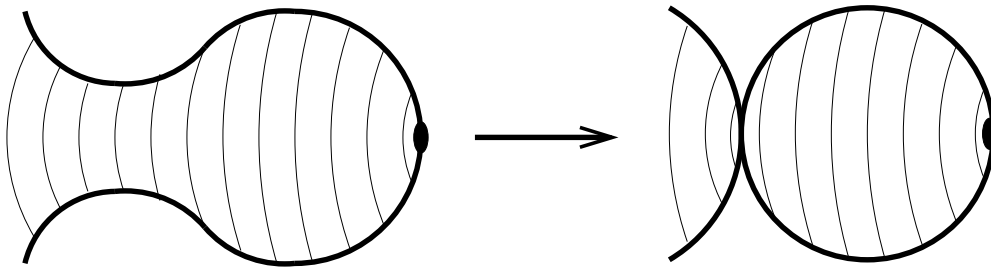

Figure 6: Double poles at a nodal point cannot arise from a disc domain because it would mean that the curve C is not stable.

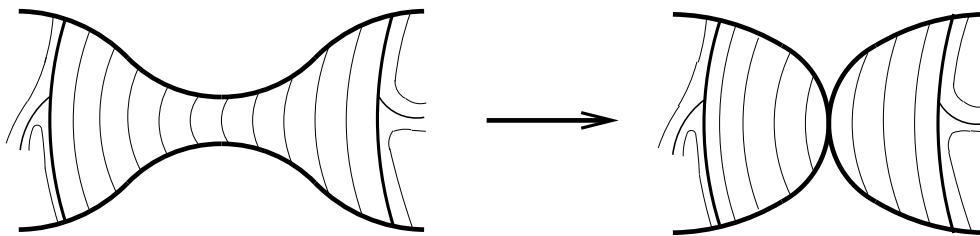

Figure 7: Double poles at a nodal point cannot arise from a cylindrical domain because the Strebel differentials φ_m do not have cylindrical domains.

finite number of nonclosed trajectories on C' and these are of finite lengths. But, on the other hand, $\tilde{\varphi}$ has no closed trajectories, because each closed trajectory surrounds a marked point and C' contains no marked points. This is a contradiction.

5. The marked components are covered by the closures of the disc domains of $\tilde{\varphi}$.

Finally, consider the restriction of $\tilde{\varphi}$ to a marked component C' (see Definition 3.4). It has double poles with residues $-(p_i/2\pi)^2$ at the marked points (and therefore it does not vanish). It has at most simple poles at the nodal points. Each of its closed trajectories surrounds a unique marked point and therefore belongs to a disc domain. The total length of its nonclosed trajectories is finite and therefore C' is covered by the closures of the disc domains. Thus (by Strebel's theorem) $\tilde{\varphi}$ is the unique Strebel differential on $(C' \setminus \text{nodes})$ with parameters p_i .

We have proved that $\tilde{\varphi} = \varphi$.

This completes the proof. ◇

Theorem 4 *The map $\overline{\mathcal{M}}_{g,n} \times \mathbb{R}_+^n \rightarrow \overline{\mathcal{W}}$ that assigns to a stable curve and a list of perimeters the corresponding Strebel differential is continuous.*

Proof. We consider a sequence of smooth curves C_m tending to a stable curve C , together with a sequence of n -tuples of positive real numbers $(p_1^{(m)}, \dots, p_n^{(m)})$ tending to an n -tuple (p_1, \dots, p_n) of positive real numbers. Now we repeat the proof of Theorem 3 without modifications. ◇

Remark 3.13 K. Strebel ([13], Theorem 23.3) proves that Strebel differentials on any connected, not necessarily compact Riemann surface (of finite type and without boundary) with n marked points depend continuously on the parameters p_1, \dots, p_n , in the topology of uniform convergence on compact sets outside the marked points.

4 The “minimal reasonable compactification” of $\mathcal{M}_{g,n}$

Here we describe a compactification of $\mathcal{M}_{g,n}$ that is different from the Deligne-Mumford one. This compactification, multiplied by \mathbb{R}_+^n , is isomorphic (as

a topological orbifold) to a natural closure of the cell decomposition of $\mathcal{M}_{g,n} \times \mathbb{R}_+^n$ given by Strebel differentials.

4.1 Cell complexes

Strebel's theorem allows one to divide the space $\mathcal{M}_{g,n} \times \mathbb{R}_+^n$ into cells: two Riemann surfaces endowed with perimeters $(C; p_1, \dots, p_n)$ and $(C'; p'_1, \dots, p'_n)$ belong to the same cell if the nonclosed horizontal trajectories of the corresponding Strebel differentials form isomorphic ribbon graphs (without taking into account the lengths of the edges). The cell corresponding to a ribbon graph G whose set of edges is E , is isomorphic to $\mathbb{R}_+^E / \text{Aut}(G)$, where $\text{Aut}(G)$ is the (finite) group of automorphisms of the ribbon graph. A cell Δ_1 is a face of another cell Δ_2 iff the corresponding graph G_1 can be obtained from the graph G_2 by contracting several edges. Gluing such cells together we obtain an orbifold cell complex homeomorphic to $\mathcal{M}_{g,n} \times \mathbb{R}_+^n$.

Now we construct a bigger cell complex whose cells correspond to stable ribbon graphs of genus g with n numbered faces. Let us first define the operation of edge contracting in stable ribbon graphs. A cell Δ_1 of our new cell complex will be a face of another cell Δ_2 iff the corresponding stable graph G_1 can be obtained from the stable ribbon graph G_2 by contracting several edges.

All the graphs considered below are stable ribbon graphs of genus g with n numbered faces (see Definition 3.9). Ordinary ribbon graphs with n numbered faces and such that their vertices have degrees at least 3 are particular cases of stable ribbon graphs (the genus defect at all vertices being equal to 0).

Let G be a stable ribbon graph and e its edge. We suppose that e does not constitute a face on its own. Recall that σ_0 is the permutation of the half-edges obtained by multiplying all the permutations assigned to vertices; σ_1 is the involution exchanging the half-edges of each edge; $\sigma_2 = \sigma_0^{-1}\sigma_1$ is the permutation whose cycles correspond to faces.

Definition 4.1 The *contraction of the edge e* in the stable ribbon graph G gives the following stable ribbon graph.

The underlying combinatorial graph is just the underlying graph of G with the edge e contracted.

If the edge e is not a loop (Figure 8a), then the genus defect assigned to the vertex obtained by its contraction is the sum of the genus defects of

the two initial vertices of e . If e is a loop based at a vertex v and the two half-edges of e belong to the same cycle of the permutation σ_0 (Figure 8b), then the genus defect of v does not change after the contraction. If e is a loop and the half-edges of e belong to two different cycles of σ_0 (Figure 8c), then the genus defect increases by 1.

Finally, the new permutations $\sigma'_0, \sigma'_1, \sigma'_2$ are defined as follows. Let h be a half-edge. Then the half-edge $\sigma'_2(h)$ is the first among the half-edges $\sigma_2(h), \sigma_2^2(h), \dots$ that is not a half-edge of e . (In other words, from the point of view of a face whose boundary included the edge e , this edge simply got contracted.) The permutation σ'_1 is defined in the obvious way (by excluding from σ_1 the cycle corresponding to e). The permutation σ'_0 equals $\sigma'_1\sigma'_2^{-1}$.

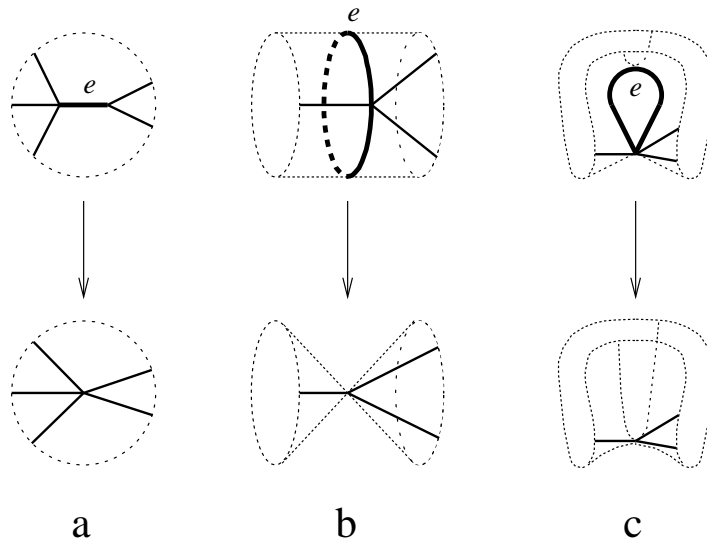

Figure 8: Contracting an edge e of G . We have represented the neighborhood of the edge e in the involved component of the surface of embedding of G .

This operation of edge-contracting might look complicated, but actually it is quite natural and describes what happens to the graph of nonclosed horizontal trajectories of a Strebel differential as the length of one of its edges e tends to 0. From the point of view of each polygon B_i surrounding a face nothing special happens: if e was part of B_i it simply gets contracted. Simple topological considerations allow one to find what happens to the genus defect. The precise statement of this is given in Theorem 5 below.

Note that if an edge e is the unique edge that surrounds a face, then it cannot be contracted, because its length must remain equal to the perimeter p_i of the corresponding face.

The two propositions below are simple combinatorial exercises.

Proposition 4.2 *Edge contracting is commutative, in other words the result of a contraction of two edges does not depend on the order in which they are performed.*

Thus it makes sense to talk about contracting a subset of the set of edges of a stable ribbon graph.

Consider a stable ribbon graph G . Let E be the set of its edges, H the set of its half-edges, and $\sigma_0, \sigma_1, \sigma_2$ its structural permutations. Decompose E into a disjoint union $E = E_c \sqcup E_r$. We are going to describe the result of the contraction of the edges of E_c .

Decompose E_c into the union of connected components, $E_c = E_1 \sqcup \dots \sqcup E_k$. First we introduce a structure of a stable ribbon graph on each of the E_i . The underlying graph is just the subgraph of G with edges E_i . The permutation $\sigma_1^{(i)}$ is the restriction of σ_1 to the half-edges of E_i . The image of a half-edge h under $\sigma_0^{(i)}$ is the first half-edge among $\sigma_0(h), \sigma_0^2(h), \dots$ to belong to an edge of E_i . Finally, $\sigma_2^{(i)} = ((\sigma_0)^{(i)})^{-1} \sigma_1^{(i)}$. The genus defect function is the restriction of the genus defect function of G to the subgraph.

Now we can introduce a structure of a stable ribbon graph on the set of remaining edges E_r . The underlying graph is obtained from G by contracting the edges of E_c . The permutation σ_1' is the restriction of σ_1 to the half-edges of E_r . The image of a half-edge h under σ_2' is the first half-edge among $\sigma_2(h), \sigma_2^2(h), \dots$ to belong to an edge of E_r . Finally, $\sigma_0' = \sigma_1' \sigma_2'^{-1}$. If a vertex of the new graph is the result of the contraction of E_i , then its genus defect is equal to the genus of the stable ribbon graph E_i . The genus defects of the other vertices are the same as they were in the graph G .

Proposition 4.3 *The stable ribbon graph E_r described above is the result of a contraction of the edges E_c in the stable ribbon graph G .*

Now, using stable ribbon graphs, we can construct a new orbifold cell complex.

Definition 4.4 Denote by A the following orbifold cell complex. Its cells are in a one-to-one correspondence with stable ribbon graphs with n numbered

faces. If G is such a graph and E the set of its edges, the corresponding cell Δ is isomorphic to $\mathbb{R}_+^E/\text{Aut}(G)$, where $\text{Aut}(G)$ is the (finite) group of automorphisms of G . A cell Δ_1 is a boundary cell of the cell Δ_2 if the corresponding stable ribbon graph G_1 can be obtained from the stable ribbon graph G_2 by contracting several edges e_1, \dots, e_k . The cell Δ_1 is then glued to Δ_2 along $e_1 = \dots = e_k = 0$.

Definition 4.5 Denote the \mathcal{B}_i the orbifold cell complex of pairs (G, x) , where G is a stable graph with n numbered faces and x a point lying on its i th face B_i .

The fact that \mathcal{B}_i indeed has a natural structure of a cell complex can be seen in the following way.

Consider a cell Δ of A . Its preimage in the total space of \mathcal{B}_i (under the projection to A forgetting the point x) is naturally subdivided into cells. Each cell is composed of the points (G, x) such that x lies on some given edge of the polygon B_i , or such that x coincides with one of the vertices of B_i . These cells are then glued to each other in the obvious way.

4.2 Factorizing $\overline{\mathcal{M}}_{g,n}$

In Section 3.3 we saw that a Strebel differential on a stable curve vanished identically on the irreducible components that do not contain marked points. Therefore it is a good idea to contract such components.

Let C be a stable curve with n marked points. Consider the curve \tilde{C} obtained from C by contracting to a point each unmarked component (i.e., an irreducible component of C that does not contain marked points).

On the curve \tilde{C} we can define a genus defect function. It is a function with a finite support and with positive integer values, defined in the following way.

Consider the subcurve of C composed of its unmarked components. Each connected component of this subcurve is contracted to a point of \tilde{C} and we assign to this point the arithmetic genus of the corresponding contracted component (cf. Definition 3.9).

Definition 4.6 We call the curve \tilde{C} endowed with the genus defect function the *contraction* of C .

Definition 4.7 We call the *minimal reasonable* compactification of $\mathcal{M}_{g,n}$ (denoted by $K\overline{\mathcal{M}}_{g,n}$) the quotient of the Deligne-Mumford compactification $\overline{\mathcal{M}}_{g,n}$ by the following equivalence relation: two points $x, y \in \overline{\mathcal{M}}_{g,n}$ are equivalent if the corresponding contractions \tilde{C}_x and \tilde{C}_y are isomorphic.

This compactification was defined in Kontsevich's original paper [10]. Looijenga ([11], Lemma 3.1) shows that it is a compact Hausdorff topological orbifold. It is not known whether it can be given a natural algebraic structure.

Note that we have constructed $K\overline{\mathcal{M}}_{g,n}$ together with a projection

$$\overline{\mathcal{M}}_{g,n} \rightarrow K\overline{\mathcal{M}}_{g,n}.$$

This projection contracts some subvarieties of $\overline{\mathcal{M}}_{g,n}$ of complex codimension at least 1. Therefore the fundamental homology class of $\overline{\mathcal{M}}_{g,n}$ is sent to the fundamental homology class of $K\overline{\mathcal{M}}_{g,n}$.

Proposition 4.8 *The line bundles L_i over $\overline{\mathcal{M}}_{g,n}$ are pull-backs of some complex line bundles over $K\overline{\mathcal{M}}_{g,n}$, that we will also denote by L_i .*

Proof. This is almost obvious. Indeed, if two curves C_1 and C_2 are equivalent in the sense of Definition 4.7, then the cotangent lines L_i to marked points on both curves are naturally identified. \diamond

Proposition 4.9 *The intersection numbers of the first Chern classes $c_1(L_i)$ are the same on any compactification X of $\mathcal{M}_{g,n}$ that can be projected on $K\overline{\mathcal{M}}_{g,n}$ in such a way that the line bundles L_i are obtained by pull-back from $K\overline{\mathcal{M}}_{g,n}$ and the fundamental class of X is sent to the fundamental class of $K\overline{\mathcal{M}}_{g,n}$.*

Proof. This is again obvious. Instead of calculating the intersection numbers on X we can calculate them on $K\overline{\mathcal{M}}_{g,n}$ and pull them back on X . \diamond

In particular all the intersection numbers are the same on $\overline{\mathcal{M}}_{g,n}$ and $K\overline{\mathcal{M}}_{g,n}$.

It is not known whether the compactifications $K\overline{\mathcal{M}}_{g,n}$ can be endowed with the structure of singular algebraic varieties. It had been conjectured that this can be achieved using the semi-ampleness of the line bundles L_i

over $\overline{\mathcal{M}}_{g,n}$. However, Sean Keel showed in [8], Section 3 that the semi-ampleness fails for $g \geq 3$ (although in finite characteristic it holds for any g and n , see [9]).

For $g = 0$, the algebraic version of the minimal reasonable compactification $K\overline{\mathcal{M}}_{0,n}$ was constructed by Marco Boggi [3]. He described it as a solution to a moduli problem using the construction that we give below. He also gave a description of $K\overline{\mathcal{M}}_{0,n}$ using blow-ups of a projective space and studied the action of the symmetric group on it.

The space $K\overline{\mathcal{M}}_{0,n}$ was also defined and used in [4] V. Goryunov and S. Lando, although the authors did not know its exact interpretation as a moduli space.

Let us sum up the algebraic construction of $K\overline{\mathcal{M}}_{0,n}$. Consider a smooth rational curve with n marked points $(\mathbb{CP}^1, x_1, \dots, x_n) \in \mathcal{M}_{0,n}$. Consider a degree 1 rational function f_i on \mathbb{CP}^1 having its pole at x_i and such that

$$f_i(x_1) + \dots + f_i(x_{i-1}) + f_i(x_{i+1}) + \dots + f_i(x_n) = 0.$$

Such a function is unique, up to a multiplicative constant, therefore its values

$$\left(f_i(x_1), \dots, f_i(x_{i-1}), f_i(x_{i+1}), \dots, f_i(x_n) \right)$$

yield a map $F_i : \mathcal{M}_{0,n} \rightarrow \mathbb{CP}^{n-3}$. Putting together such maps for all i , we obtain a map $F : \mathcal{M}_{0,n} \rightarrow (\mathbb{CP}^{n-3})^n$. We claim that the closure of the image of F in $(\mathbb{CP}^{n-3})^n$ is an algebraic model of the minimal reasonable compactification. More precisely, F can be naturally extended to a holomorphic map $F : \overline{\mathcal{M}}_{0,n} \rightarrow (\mathbb{CP}^{n-3})^n$ that sends two stable curves to the same point if and only if their contractions (Definition 4.6) are isomorphic.

Let us sketch the proof of this fact. First of all, the family of functions f_i can be extended to a family of functions on the compactification $\overline{\mathcal{M}}_{0,n}$. The function f_i on a stable curve C with n marked points is defined as follows. It is constant on each irreducible component of C that does not contain x_i . On the component that contains x_i , the function f_i is of degree 1 and has a simple pole at x_i . And, as before, we have

$$f_i(x_1) + \dots + f_i(x_{i-1}) + f_i(x_{i+1}) + \dots + f_i(x_n) = 0.$$

Such a function f_i is, again, unique, up to a multiplicative constant. It is easy to see that the values of the function f_i at the points $x_j, j \neq i$ allow one

to reconstitute the complex structure on the component of C that contains x_i , but not on the other components.

Thus the function F can be extended to $\overline{\mathcal{M}}_{0,n}$ and a point $F(C)$ allows one to reconstitute the complex structure of the marked components of C , but not that of the unmarked components.

4.3 A homeomorphism between $K\overline{\mathcal{M}}_{g,n} \times \mathbb{R}_+^n$ and the cell complex of stable ribbon graphs

Consider two stable curves C_1 and C_2 that are mapped to the same point of $K\overline{\mathcal{M}}_{g,n}$. Let p_1, \dots, p_n be a given list of perimeters (positive real numbers). It is clear that the stable ribbon graphs formed by the nonclosed horizontal trajectories of the Strebel differentials on C_1 and C_2 are the same, including the edge lengths. We can therefore define a map h from $K\overline{\mathcal{M}}_{g,n} \times \mathbb{R}_+^n$ to the cell complex A of stable ribbon graphs with n numbered faces and endowed with edge lengths (see Definition 4.4).

Theorem 5 *The map*

$$h : K\overline{\mathcal{M}}_{g,n} \times \mathbb{R}_+^n \rightarrow A$$

is an isomorphism of topological orbifolds. The polygonal bundles \mathcal{B}_i over A are naturally identified with the real spherizations $(L_i^ \setminus \text{zero section})/\mathbb{R}_+$ of the complex line bundles L_i^* dual to L_i .*

This theorem was formulated by M. Kontsevich without a proof. It follows from the main theorem (Theorem 8.6) of E. Looijenga's paper [11]. Here we give a different proof.

Proof of Theorem 5. The identification of $(L_i^* \setminus \text{zero section})/\mathbb{R}_+$ with \mathcal{B}_i is immediate (see the discussion in the end of Section 3.3).

The bijectivity of h is a reformulation of Proposition 3.10.

The continuity of h and that of h^{-1} are equivalent. Indeed, both spaces $K\overline{\mathcal{M}}_{g,n} \times \mathbb{R}_+^n$ and A have natural proper projections to \mathbb{R}_+^n . We know that the map h is a bijection that commutes with the projections. Therefore if h or its inverse is continuous, then h is a homeomorphism.

Thus the main task is to prove the continuity of h , which we will do using Theorem 4 and Proposition 3.12.

1. A sequence of Strebel differentials.

Consider a sequence of stable curves C_m tending to a stable curve C , together with a sequence of n -tuples $p^{(m)} = (p_1^{(m)}, \dots, p_n^{(m)})$ of positive real numbers tending to an n -tuple $p = (p_1, \dots, p_n)$ of positive real numbers.

From Theorem 4 we know that in the vector bundle $\overline{\mathcal{W}}$ of quadratic differentials, the sequence of the corresponding Strebel differentials φ_m on C_m tends to the Strebel differential φ on C . Moreover, according to Proposition 3.12, there is a sequence of deformations $f_m : C_m \rightarrow C$ such that the sequence $(f_m)_*\varphi_m$ converges to φ , uniformly on any compact set $K \subset (C \setminus \text{marked poles and nodes})$.

We must prove that in the cell complex A , the sequence of stable graphs with edge lengths corresponding to φ_m tends to the stable graph with edge lengths corresponding to φ .

2. For m big enough, a disc domain of φ_m contains any compact set inside the corresponding disc domain of φ .

Let $z = z_i$ be one of the marked points in the curve C , let D be the corresponding disc domain consisting of closed horizontal trajectories, and let $K \subset D$ be any compact set. Then, for m big enough, $f_m^{-1}(K)$ is contained in the disc domain of φ_m surrounding the marked point $f_m^{-1}(z)$. Indeed, consider a compact annulus K' surrounding K . We suppose that K' is composed of closed trajectories of the disc domain D and that $K \cap K' = \emptyset$. The annulus K' does not contain nodes of C , nor zeroes or poles of φ .

In the proof of Theorem 3, paragraph **2**, we proved that, for m big enough, $f_m^{-1}(K')$ necessarily contains a closed horizontal trajectory of φ_m that makes exactly one turn around $f_m^{-1}(K')$. This trajectory surrounds $f_m^{-1}(K)$ entirely. Thus $f_m^{-1}(K)$ lies inside a disc domain of φ_m .

3. Cutting the curve C into pieces.

For shortness, we call a *disc neighborhood* of a point $x \in C$ any neighborhood of x homeomorphic to an open disc.

To every marked point z_i on C we assign a disc neighborhood $U_i \subset C$.

To every vertex v of the stable graph of the differential φ we assign an open set $U_v \subset C$ as follows. If v is a zero of φ at a regular point of C , then U_v is just a disc neighborhood of v . If v is a node of C such that both irreducible components intersecting at v are marked (contain marked points), then U_v is the union of two disc neighborhoods of v on both components. If v is obtained by contracting one or more unmarked irreducible components of C , then U_v is the union of these unmarked components and of the disc neighborhoods of all the nodes at which they meet marked components.

Finally, to every edge e we assign a compact set $K_e \subset C$. It is homeomor-

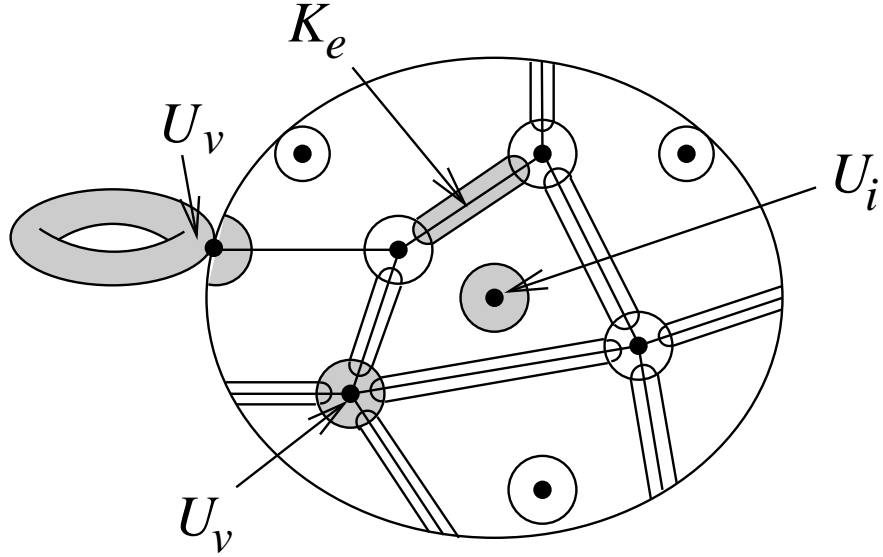

Figure 9: The sets U_i , U_v , and K_e .

phic to a closed disc and contains in its interior the part of e that lies outside U_v and $U_{v'}$, where v and v' are the vertices of e . Moreover, we suppose that K_e does not intersect the vertical trajectories of φ that join marked points to the vertices v and v' .

All these sets are represented in Figure 9.

All the disc neighborhoods above can be chosen arbitrarily small.

We denote by $G = \text{Gr}(\varphi)$ the stable ribbon graph endowed with edge lengths, assigned to the Strebel differential φ . Similarly, $G_m = \text{Gr}(\varphi_m)$ is the stable ribbon graph with edge lengths assigned to φ_m .

5. For m big enough, the vertices of G_m in C_m lie inside the union of the sets $f_m^{-1}(U_v)$ over all the vertices v of G .

Indeed, consider the compact set $K \subset C$ obtained from C by taking away all the open sets U_i and U_v . There are no zeroes or poles of φ nor nodes of C in K . Therefore, for m big enough, there are no vertices of G_m in $f_m^{-1}(K)$. On the other hand, according to **3**, there are no vertices of G_m in $f_m^{-1}(U_i)$, because $f_m^{-1}(U_i)$ belongs to the i th disc domain of φ_m . Thus every vertex of G_m lies inside $f_m^{-1}(U_v)$ for some vertex v of G .

Conversely, let us prove, that each set $f_m^{-1}(U_v)$ contains at least one vertex of G_m .

Suppose v is a k -tuple zero of φ at a regular point of C . Then we consider a circle surrounding v and lying inside U_v . As we go around this circle, the horizontal trajectories of φ make $-k$ half-turns with respect to the tangent line to the circle. Therefore the same is true for the horizontal trajectories of φ_m , for m big enough. Thus $f_m^{-1}(U_v)$ contains one or several zeroes of φ_m whose sum of multiplicities equals k .

Suppose U_v contains at least one node of C . If $f_m^{-1}(U_v)$ also contains a node of C_m there is nothing to prove, because this node is necessarily a vertex of G_m . Suppose that $f_m^{-1}(U_v)$ does not contain nodes. Then it is a smooth Riemann surface with holes. We must prove that φ_m has at least one zero on this surface.

First of all, if we are given a quadratic differential without poles on a Riemann surface S of genus g with d holes, the number of its zeroes (taking their multiplicities into account) equals

$$|\text{zeroes}| = 4g - 4 + 2d - 2|\text{turns}|,$$

where $|\text{turns}|$ is the total number of turns that the horizontal trajectories make with respect to the tangent lines to the boundary circles.

Recall that U_v contains several unmarked components of C and several small discs surrounding nodes of marked components. As above, we draw a circle inside each such small disc, surrounding the corresponding node. If the node is a vertex of degree k , then, as we go around the circle, the horizontal trajectories make $-k$ half-turns with respect to the tangent lines to the circle. Therefore the same is true for $(f_m)_*\varphi_m$, for m big enough. Since $f_m^{-1}(U_v)$ has either a positive genus or at least two holes, and since the number of turns is always negative, φ_m has at least one zero in $f_m^{-1}(U_v)$.

6. An injection from the set of edges of G to the set of edges of G_m .

Let e be an edge of G . We will assign to e an edge of G_m . Later we will see that one obtains G by contracting the edges of G_m that are not assigned to any edge of G .

A vertical trajectory of a Strebel differential usually joins two marked points (that can happen to be the same) and crosses exactly one nonclosed horizontal trajectory. (The exceptions are those vertical trajectories that join a marked point to a zero of the differential or to a node of the curve.)

Two vertical trajectories intersect the same nonclosed horizontal trajectory if and only if they join the same pair of marked points and, moreover,

bound a region in the stable curve, that does not contain zeroes of poles of the Strebel differential, nor nodes of the curve.

Consider the vertical trajectory α of φ through any point $x \in K_e$. By the choice of K_e , we know that α does not end at a vertex of G . Therefore it joins some marked points z_i and z_j (it can happen that $z_i = z_j$). Denote by α_m the vertical trajectory of φ_m through $f_m^{-1}(x)$. For m big enough, $f_m(\alpha_m)$ follows α closely enough to enter the neighborhoods U_i and U_j . Therefore it necessarily joins z_i and z_j , just as α does (because $f_m^{-1}(U_i)$ and $f_m^{-1}(U_j)$ lie inside the corresponding disc domains). According to the above remark, the vertical trajectory α_m crosses exactly one nonclosed horizontal trajectory of φ_m , in other words, exactly one edge of G_m . We denote this edge by e_m and assign it to the edge e of G .

For m big enough, the resulting edge does not depend on the choice of $x \in K_e$. Indeed, two vertical trajectories of φ_m through two points of $f_m^{-1}(K_e)$ bound a region in C_m , that does not contain zeroes or poles of φ_m or nodes of C_m . Therefore these two vertical trajectories cross the same edge of G_m .

Let us prove that $e \mapsto e_m$ is an injection. Consider two vertical trajectories of α_m through $x \in f_m^{-1}(K_e)$ and α'_m through $x' \in f_m^{-1}(K_{e'})$, where e and e' are two different edges. Let us prove that they cannot intersect the same edge of G_m . If they cross the same edge of G_m , it means that they join the same pair of marked points and, moreover, bound a region in C_m , that does not contain zeroes or poles of φ_m or nodes of C_m . It is easy to see that, if α_m and α'_m join the same pair of marked points and bound a region in C_m , then this region contains at least one set $f_m^{-1}(U_v)$ for some vertex v of G . But, according to **4**, this set contains at least one vertex of G_m . Thus α_m and α'_m correspond to different edges of G_m . This proves the injectivity of the map $e \mapsto e_m$.

Each edge e_m lies entirely inside $f_m^{-1}(K_e \cup U_v \cup U_{v'})$, where v and v' are the vertices of e . Indeed, e_m is entirely contained inside the union of sets $f_m^{-1}(K_*)$ and $f_m^{-1}(U_*)$ over all edges and vertices of G , because the complement of this union is covered by disc domains of φ_m . On the other hand, e_m does not meet $f_m^{-1}(K_{e'})$ for any edge $e' \neq e$, because otherwise it would cross a vertical trajectory of φ_m that it should not cross. Thus e_m is contained in $f_m^{-1}(K_e \cup U_v \cup U_{v'})$, because only $f_m^{-1}(U_v)$ and $f_m^{-1}(U_{v'})$ have common points with $f_m^{-1}(K_e)$.

For the same reason, an edge of G_m that does not correspond to an edge of G lies entirely in $f_m^{-1}(U_v)$ for some vertex v .

7. The difference of lengths between an edge e of G and the

corresponding edge e_m of G_m is less than ε . The other edges of G_m are shorter than ε .

At present, we have proved the following. To each edge e of G joining to vertices v and v' we can assign an edge e_m of G_m joining some points inside $f_m^{-1}(U_v)$ and $f_m^{-1}(U_{v'})$. The image of e_m under f_m is contained inside the union of K_e , U_v , and $U_{v'}$. An edge of G_m that does not correspond to an edge of G lies inside $f_m^{-1}(U_v)$ for some vertex v . All this, of course, is only true starting from some m .

Consider an edge e and let l_e be its length. If we choose the disc neighborhoods U_v of the vertices small enough, the length of the part of e that lies outside the neighborhoods U_v is greater than $l_e - \varepsilon$. Consider the line $f_m(e_m)$, more precisely, its part lying in K_e . By choosing K_e small enough and m big enough, we see that the length of $f_m(e_m) \cap K_e$ measured with the differential $(f_m)_*\varphi_m$ differs from the length of $e \cap K_e$ measured with φ by less than ε . Thus the length of e_m is greater than $l_e - 2\varepsilon$.

But the total sum of lengths of the edges of G_m is fixed: it is equal to the sum of the perimeters $\sum_i p_i^{(m)}$, which is arbitrarily close to $\sum_i p_i$. Therefore, for m big enough, the length of each edge e_m is arbitrarily close to that of e , while the lengths of the edges of G_m that do not correspond to edges of G are arbitrarily small.

8. The genus defect function.

The genus defect assigned to a vertex v of G is equal to the arithmetic genus of the open set U_v , which is actually a singular noncompact complex curve. Using Proposition 4.3, it is easy to see that this genus defect is indeed obtained by contracting the edges of G_m that lie in $f_m^{-1}(U_v)$.

9. Conclusion.

Thus, for m big enough, the stable ribbon graph G is obtained from G_m by contracting some edges of length less than ε and by changing the lengths of the other edges by less than ε . This means that the graph G_m lies in an ε -neighborhood of G in the cell complex A . Since ε can be chosen arbitrarily small, the sequence G_m tends to G in A . ◇

4.4 Looijenga's results

This section is a very brief review of Looijenga's paper [11]. We follow, as closely as possible, the notation introduced there.

Looijenga's main result is the continuity of a map similar to the map h^{-1} in our Theorem 5. In other words, he proves that when one changes continu-

ously the stable ribbon graph with edge lengths, the corresponding Riemann surface glued from strips also changes continuously. The main problem is that if we consider a sequence of ordinary ribbon graphs G_m converging in A , the corresponding sequence of smooth curves does not necessarily converge in the Deligne-Mumford compactification $\overline{\mathcal{M}}_{g,n}$, but only in the quotient $K\overline{\mathcal{M}}_{g,n}$. However, there is no simple criterion of convergence in $K\overline{\mathcal{M}}_{g,n}$. To solve this problem, Looijenga constructs a more complicated cell complex, that turns out to be homeomorphic to $\overline{\mathcal{M}}_{g,n} \times \mathbb{R}_+^n$. This is done roughly as follows. Consider a stable ribbon graph G and normalize its edge lengths (by multiplying them by a constant) so that their sum equals 1. Choose a subset E_1 of the set of edges E , and suppose the lengths of the edges of E_1 tend to 0. Instead of forgetting everything about the lengths of the edges of E_1 (as we do when we contract them to obtain a new stable ribbon graph), we normalize their lengths anew, so that their sum equals 1. Among the edges of E_1 their can now be a new subset of edges E_2 whose lengths still tend to 0. We normalize them once again, so that their sum equals 1. And so on. Using all this information, we can construct a cell complex with a projection onto A , and such that a converging sequence in this complex induces a converging sequence of stable curves.

Looijenga's construction is a little more general than what is needed for Kontsevich's proof, because he allows the perimeters p_1, \dots, p_n to vanish (but under the above normalization their sum remains equal to 2, so at least one perimeter must remain positive) and studies what happens to Strebel differentials and stable ribbon graphs in that case. Therefore his definitions of stable graphs and of the minimal reasonable compactification are slightly different from ours.

Suppose the set of marked points $\{1, \dots, n\}$ is divided into two disjoint parts: $V \sqcup Q$, $Q \neq \emptyset$. Here V is the set of points such that the corresponding perimeters vanish, while Q is the set of points such that the corresponding perimeters do not vanish.

Stable ribbon graphs. The natural modification of the notion of Strebel differentials to this case is to consider the Strebel differentials on our surface punctured at the points of the set V (and with double poles with given residues at the points of Q). It is easy to see that if one puts the points of V back into the surface, the Strebel differential will have at most simple poles at these points. Therefore they will be vertices of the graph of nonclosed

horizontal trajectories. Thus the new stable graphs, instead of having n numbered faces, have n numbered faces or vertices. We do not give the precise definition of a stable ribbon graph in this setting; it is a formalization of the properties of the graph of nonclosed horizontal trajectories of a Strebel differential.

Minimal reasonable compactifications. In our definition of the minimal reasonable compactification, two points $x, y \in \overline{\mathcal{M}}_{g,n}$ are identified if the stable curves C_x and C_y give the same curve when one contracts each of their components that do not contain marked points. Analogously, $K_Q \overline{\mathcal{M}}_{g,n}$ is the quotient of $\overline{\mathcal{M}}_{g,n}$ in which two points $x, y \in \overline{\mathcal{M}}_{g,n}$ are identified if the stable curves C_x and C_y give the same curve when one contracts each of their components that do not contain the marked points of the set Q .

Teichmüller spaces. Looijenga works with Teichmüller spaces rather than moduli spaces. The advantage of this approach is that the spaces considered are not orbifolds, but usual topological space. However one has to work with non locally compact topological spaces.

Let $\mathcal{T}_{g,n}$ be the Teichmüller space of Riemann surfaces of genus g with n marked points. Its quotient by the action of the mapping class group Γ is the moduli space $\mathcal{M}_{g,n}$. Looijenga uses an augmented Teichmüller space $\widehat{\mathcal{T}}_{g,n}$ constructed by Harvey [7]. The space $\widehat{\mathcal{T}}_{g,n}$ is endowed with a proper action of the mapping class group Γ and there is a natural Γ -invariant surjective projection from $\widehat{\mathcal{T}}_{g,n}$ onto the Deligne-Mumford compactification $\overline{\mathcal{M}}_{g,n}$.

The space $\widehat{\mathcal{T}}_{g,n}$ is constructed as follows. Let C be a smooth genus g Riemann surface with n punctures. We can choose $3g - 3 + n$ simple loops in C in such a way that they cut C into $2g - 2 + n$ “pants” (3-holed spheres). In the free homotopy class of each loop we can choose the shortest geodesic with respect to the unique complete metric of curvature -1 on C , compatible with the conformal structure. To each geodesic we can assign its length $l \in \mathbb{R}_+$ and the angle $\theta \in \mathbb{R}$, with respect to some chosen gluing, at which the two pants adjacent to it are glued to each other. These lengths and angles are called the *Fenchel-Nielsen coordinates* in the Teichmüller space. It is well-known that they determine a real analytic diffeomorphism of the Teichmüller space onto the open octant $\mathbb{R}_+^{3g-3+n} \times \mathbb{R}^{3g-3+n}$ (see, for example, [1]). Now we simply add to the octant the boundary hyperplanes and endow the obtained closed octant with the usual topology. This corresponds to pinching the

geodesics, but retaining the angles at which the adjacent pants were glued to each other. This operation can be carried out for all possible choices of $3g-3+n$ geodesics and the points we adjoin to the Teichmüller space add up into the augmented Teichmüller space $\widehat{\mathcal{T}}_{g,n}$. For a smooth surface S with n marked points we define a *stable complex structure* to be a complex structure J defined on $S \setminus L$, where $L \subset (S \setminus \text{marked points})$ is a finite set of simple loops, such that pinching the loops we obtain a stable curve. Then, as a set, $\widehat{\mathcal{T}}_{g,n}$ can be identified with the set of all stable complex structures on a given smooth surface S with n marked points, up to diffeomorphisms homotopic to the identity, relatively to the marked points.

Looijenga uses the following criterion of convergence on $\widehat{\mathcal{T}}_{g,n}$. Let J_m be a sequence of complex structures on a smooth surface S with n marked points and let J be a stable complex structure on $S \setminus L$. If J_m converges to J uniformly on every compact set $K \subset (S \setminus L)$, then the sequence of curves (S, J_m) converges to (S, J) in the space $\widehat{\mathcal{T}}_{g,n}$.

Starting from $\widehat{\mathcal{T}}_{g,n}$, one can construct the analog of minimal reasonable compactifications for Teichmüller spaces. Indeed, there is a Γ -invariant map $\widehat{\mathcal{T}}_{g,n} \rightarrow K_Q \overline{\mathcal{M}}_{g,n}$ for any subset Q of the set of marked points. We denote by $K_Q \mathcal{T}_{g,n}$ the space obtained from $\widehat{\mathcal{T}}_{g,n}$ by contracting to one point each connected component of the preimage of each point under this map. This space is still endowed with an action of Γ , although it is not proper any longer.

The simplicial complex of stable graphs. Let S be a fixed surface with n marked points. Consider the following infinite simplicial complex $A_{\mathcal{T}}$.

Consider the set of homotopy classes (relatively to the marked points) of simple non-oriented arcs in S joining two (possibly coinciding) marked points and avoiding the other marked points. The homotopy class is called trivial if the corresponding arc is contractible in S punctured at the marked points.

A vertex of $A_{\mathcal{T}}$ is a nontrivial homotopy class as above. A set of homotopy classes forms a simplex if the homotopy classes can be realized by loops that do not intersect (except at their endpoints).

There is a natural action of the mapping class group Γ on $A_{\mathcal{T}}$. The quotient of $A_{\mathcal{T}}$ by this action is a finite orbifold simplicial complex. One can prove that the quotient complex $A_{\mathcal{T}}/\Gamma$ is isomorphic to the complex A defined by stable ribbon graphs. (If a stable graph is a just a ribbon graph with n numbered faces and with degrees of vertices ≥ 3 , then the corresponding set

of arcs is obtained by considering the dual graph: joining by arcs the centers of adjacent faces. When we contract an edge in the stable ribbon graph we must erase the corresponding arc.)

Thus there are two equivalent ways of defining the same simplicial complex A . The definition with isotopy classes of arcs is certainly more elegant, but stable ribbon graphs are needed anyway to make the connection with Strebel differentials.

A quotient of $\widehat{\mathcal{T}}_{g,n} \times \mathbf{simplex}$. Finally, let Δ_n be the standard n -simplex. We consider the topological space $|K_\bullet \mathcal{T}|$ obtained from $\widehat{\mathcal{T}}_{g,n} \times \Delta_n$ by the following factorization. Consider a point x in Δ_n and let Q be the set of its nonzero coordinates (a subset of $\{1, \dots, n\}$). Then the “layer” $\widehat{\mathcal{T}}_{g,n} \times \{x\}$ is factorized so as to obtain $K_Q \mathcal{T} \times \{x\}$.

Theorem 6 [11] *There is a natural bijective continuous map from the complex $A_{\mathcal{T}}$ to $|K_\bullet \mathcal{T}|$. It is Γ -invariant and commutes with the projections of both spaces on the simplex Δ_n .*

The above mapping is not a homeomorphism, but if we quotient both spaces by the action of Γ it becomes a homeomorphism, because a continuous bijection between two compact topological spaces is necessarily a homeomorphism. If, in both spaces, we take the preimage of the interior of the simplex Δ_n we immediately obtain Theorem 5.

Looijenga proves Theorem 6 by constructing an explicit trivialization of families of Riemann surfaces as a ribbon graph tends to a stable ribbon graph and using the convergence criterion that we formulated in the paragraph on Teichmüller spaces.

5 The Chern classes $c_1(\mathbf{L}_i)$

Here we recall Kontsevich’s expression for the first Chern classes $c_1(\mathbf{L}_i)$. Theorem 5 allows us to work on the cell complex A . Kontsevich’s expressions are cellwise smooth continuous differential forms, and we explain the framework in which such forms can be used.

5.1 A connection on the bundles \mathcal{B}_i

Once we have found a homeomorphism h between $K\overline{\mathcal{M}}_{g,n} \times \mathbb{R}_+^n$ and the cell complex A , we will no longer use the smooth structure of $K\overline{\mathcal{M}}_{g,n}$ (defined outside the singularities). Instead, we use the natural piecewise smooth structure of the cell complex A . The relation between the two is rather delicate and we won't discuss it here.

Thus we have n polygonal bundles \mathcal{B}_i over the cell complex A and we want to find their first Chern classes.

(We remind the reader how to define the first Chern class of a topological oriented circle bundle over any topological space X homotopically equivalent to a cell complex. There exists a continuous map f from X to the infinite projective space $\mathbb{C}P^\infty$ such that the circle bundle over X is isomorphic to the pull-back under f of the canonical circle bundle over $\mathbb{C}P^\infty$. The first Chern class of the bundle is the pull-back under f of the natural 2-cohomology class of $\mathbb{C}P^\infty$. It is an element of $H^2(X, \mathbb{Z})/\text{torsion}$.)

Consider one of the polygonal bundles $\mathcal{B} = \mathcal{B}_i$. Kontsevich constructs an explicit 1-form α on each cell of the total space of \mathcal{B} , claiming that $d\alpha$ represents the first Chern class of the line bundle L_i over $\overline{\mathcal{M}}_{g,n} \times \mathbb{R}_+^n$ (see [10], Lemma 2.1). The 1-form in question is the following.

Let p be the perimeter of the polygon B , k its number of vertices, and

$$0 \leq \phi_1 < \dots < \phi_k < p$$

the distances from the distinguished point of the polygon to its vertices (as we go around the polygon counterclockwise). Moreover, denote by l_i , $1 \leq i \leq k$, the length of the edge that follows the i th vertex. Then we have

$$\alpha = \sum_{i=1}^k \frac{l_i}{p} d\left(\frac{\phi_i}{p}\right).$$

5.2 Differential geometry on polytopal complexes

Here we introduce a framework for working with cellwise smooth differential forms on cell complexes. It has appeared, for example, in Sullivan's work [14], but we give a complete exposition here, adapted to our needs.

The results of this section can be considered as a far-reaching generalization of the fact that the Newton-Leibniz formula $\int_a^b f'(t)dt = f(b) - f(a)$

holds not only for differentiable functions f , but also for continuous piecewise differentiable ones.

First we define polytopal complexes, which are simply spaces glued from affine polytopes.

Definition 5.1 A *polytope* in a real vector space is an intersection of a finite number of open or closed half-spaces such that its interior is non-empty. Replacing, in the above intersection, some of the closed half-spaces by their boundary hyperplanes, we obtain a *face* of the polytope.

Thus a polytope is always convex, but not necessarily closed or bounded. A face is a subset of the polytope.

Definition 5.2 A *polytopal complex* is a finite set X of polytopes in real vector spaces, together with gluing functions satisfying the following conditions. (i) Each gluing function is an affine map that identifies a polytope $P_1 \in X$ with a face of another polytope $P_2 \in X$. (For brevity, we will say that P_1 is a face of P_2 .) (ii) If P_1 is a face of P_2 , which is a face of P_3 , then P_1 is a face of P_3 , and the corresponding gluing functions form a commutative diagram. (iii) If $P_1 \in X$ is identified with a face of $P_2 \in X$, no other polytope $P'_1 \in X$ can be identified with the same face of P_2 .

Now we define differential forms on polytopal complexes. A differential form on a polytope is simply a differential form with smooth coefficients defined in some neighborhood of the polytope in the ambient vector space.

Definition 5.3 A *differential k -form* on a polytopal complex is a set of differential k -forms defined on all the polytopes such that restricting the k -form to a face of a polytope coincides with the k -form on the face.

Example 5.4 Consider two squares lying in the half-planes $x \geq 0$ and $x \leq 0$ and having a common side on the y axis. They form a polytopal complex. A differential 1-form on this complex can be given, for example, by $dx + dy$ in the right-hand square, $-2dx + dy$ in the left-hand square, and dy on their common edge. Moreover, we could have added to our complex a third square (or another polygon) such that the three of them would share a common edge. The 1-form can then be extended to this new polygon.

This example shows that k -forms in two adjacent polytopes sharing a common face of dimension $\geq k$ are not independent: they must coincide on the common face.

Definition 5.5 The exterior product and the differential d of differential forms on polytopal complexes are defined polytope-wise.

It is obvious that we have

$$d^2\alpha = 0 \quad \text{and} \quad d(\alpha \wedge \beta) = (d\alpha) \wedge \beta + (-1)^{\deg \alpha} \alpha \wedge (d\beta),$$

because these identities are true on each polytope. Therefore each polytopal complex possesses a de Rham complex and the de Rham cohomology forms an algebra.

Proposition 5.6 *The de Rham cohomology groups of a polytopal complex X are canonically identified, as real vector spaces, with its usual cohomology groups over \mathbb{R} .*

Proof. The de Rham complex can be considered as a complex of sheaves on the polytopal complex X . It suffices to prove that it is a flasque resolution of the constant sheaf \mathbb{R} on X . In other words, we must prove that locally each closed differential form is exact (except for the constant functions considered as 0-forms). Consider a point $x \in X$ and a closed k -form α defined in a sufficiently small neighborhood U of x . We will construct a $(k-1)$ -form β in U , such that $d\beta = \alpha$. The value of β on $k-1$ vectors tangent to one of the polytopes is obtained by the following standard procedure. We construct on the $k-1$ vectors a small parallelepiped P that fits entirely into the polytope. Then we consider the cone with vertex x and with base P . The integral of β over P is, by definition, equal to the integral of α over the cone. By letting the sides of P tend to 0 we find the value of β on the $k-1$ vectors. It is obvious that β is a $(k-1)$ -form on the polytopal complex in the neighborhood of x (in the sense of Definition 5.3). It is easy to check that if $d\alpha = 0$, then $d\beta = \alpha$. \diamond

Now the main task is to prove that the Stokes formula is still true for differential forms on polytopal complexes.

Definition 5.7 A k -piece in a polytopal complex X is an affine map from a compact k -dimensional polytope to a polytope of X . A k -chain in a polytopal complex X is a finite linear combination C of k -pieces with real coefficients. The *boundary* of a chain and the integral of a k -form over a k -chain are defined in the obvious way.

Proposition 5.8 (Stokes formula) *Let X be a polytopal complex, C a k -chain in X , and α a $(k - 1)$ -form on X . Then*

$$\int_C d\alpha = \int_{\partial C} \alpha.$$

Proof. The formula is obvious if C is composed of a unique k -piece, because in that case the piece is contained in a unique polytope of X . In the general case the formula is obtained by summing over the pieces of C . \diamond

Proposition 5.9 *The algebra structure of the de Rham cohomology of a polytopal complex X (given by the multiplication of forms) coincides with the usual algebra structure of the cohomology of X .*

Proof. Recall the usual definition of the product in the space of cohomologies (see [12], chapter XIII). Let X be a polytopal complex and consider the polytopal complex $X \times X$ with the two projections, p_1 and p_2 , on X . For $u, v \in H^*(X, \mathbb{R})$ one defines $u \otimes v \in H^*(X \times X, \mathbb{R})$ by the formula

$$(u \otimes v)(a \times b) = (-1)^{\deg v \deg a} u(a)v(b),$$

where a and b are two cycles in X . The product cycles $a \times b$ span the whole homology group of $X \times X$, therefore the above formula defines the class $u \otimes v$ unambiguously. It is clear that if differential forms α and β on X represent the classes u and v , then the form $p_1^* \alpha \wedge p_2^* \beta$ represents the class $u \otimes v$. Now, the product uv is defined by taking the restriction of $u \otimes v$ to the diagonal of $X \times X$. Thus it is represented by $\alpha \wedge \beta$. \diamond

Now we will consider a polytopal equivalent of a circle bundle and prove that its first Chern classes can be expressed as the “curvature” of a cellwise smooth “connection”.

Definition 5.10 A *morphism* of polytopal complexes $F : X_1 \rightarrow X_2$ is a set F of affine maps $f : P_1 \rightarrow P_2$, where P_1 is a polytope of X_1 and P_2 a polytope of X_2 . This set must satisfy the following natural conditions. At least one map should be defined on every polytope of X_1 . For every map $f \in F$ its restrictions to the faces of P_1 must belong to F . If the image of P_1 under f belongs to a face of P_2 , the map from P_1 to this face should also belong to F . If a point of P_1 has two different images under maps of F , these images should be identified by gluing functions of the complex X_2 .

Note that the image of each polytope under a morphism lies in a unique polytope of the target complex.

Let $F : X \rightarrow Y$ be a morphism of polytopal complexes such that the preimage of each point of Y is homeomorphic to a circle. (Each such circle is naturally subdivided into 0-cells and 1-cells, and we do not require that these subdivisions be the same for different fibers.) Suppose that the circle bundle thus obtained is oriented. Let α be a 1-form on the polytopal complex X such that its integral over each fiber of F equals 1 and such that $d\alpha$ is a pull-back under F of a 2-form ω on Y . The Stokes formula allows one to prove that ω represents the first Chern class of the bundle. More precisely:

Proposition 5.11 *If S is a polytopal complex homeomorphic to a compact 2-dimensional manifold without boundary, and $G : S \rightarrow Y$ a morphism of complexes, then $\int_S G^*\omega$ is equal to the first Chern class of the pull-back to S of the circle bundle over Y .*

Proof. We can assume that S is connected. Denote by G^*X the pull-back to S of the bundle X . Denote by a the corresponding first Chern class. One can easily construct a section of G^*X over the surface S punctured at one point. Over the punctured point the section will wind a times around the fiber. Such a section is a sub-complex of G^*X , homeomorphic to a 2-dimensional surface with boundary. The integral of α over the boundary equals a . Thus, according to the Stokes formula, the integral of $d\alpha$ over the whole section also equals a . But the integral of $d\alpha$ over the section equals the integral of ω over S . \diamond

5.3 Back to the first Chern classes of \mathbf{L}_i

The complex A of stable ribbon graphs and the total space of the polygonal bundle \mathcal{B} are obviously polytopal complexes. The projection $\mathcal{B} \rightarrow A$ is a morphism of complexes as in Proposition 5.11.

It is straightforward to check that the 1-form α defined in Section 5.1 is a 1-form on the total space of \mathcal{B} in the sense of Definition 5.3.

Thus it remains to check that α satisfies the conditions of Proposition 5.11.

Proposition 5.12 [10]

- (i) *The integral of α over any fiber of \mathcal{B} equals -1 .*
- (ii) *The 2-form $d\alpha$ is the lifting of a 2-form ω from the base A .*

Proof.

(i) As we go around the fiber, the distinguished point goes around the polygon B counterclockwise. The coefficients l_i/p remain constant, while each ϕ_i decreases from its initial value to 0 and then from p back to its initial value. Thus the integral over the fiber of each $d(\phi_i/p)$ equals -1 and the sum of the coefficients l_i/p equals 1.

(ii) A simple calculation gives

$$\omega = d\alpha = \sum_{1 \leq i < j \leq k-1} d\left(\frac{l_i}{p}\right) \wedge d\left(\frac{l_j}{p}\right)$$

on each cell. This 2-form depends only on the lengths l_i but not on the ϕ_i s. Therefore it is a lifting of a 2-form from the base A . \diamond

Thus ω is a 2-form on the polytopal complex A that represents minus the first Chern class of the bundle \mathcal{B} . To calculate the intersection numbers of these Chern classes one can multiply the 2-forms ω and integrate them over the cells of highest dimension.

This finishes the proof of Theorem 1.

References

- [1] **W. Abikoff.** *The real analytic theory of Teichmüller space.* – Lecture Notes in Mathematics, **820** (1980), Springer-Verlag.
- [2] **L. Bers.** *On spaces of Riemann surfaces with nodes.* – Bulletin of the American Mathematical Society, **80** (1974), 1219–1222.
- [3] **M. Boggi.** *Compactifications of configurations of points on \mathbb{P}^1 and quadratic transformations of projective space.* – Indagationes Mathematicae, **10** (1999), no. 2, 191–202.
- [4] **V. V. Goryunov, S. K. Lando.** *On enumeration of meromorphic functions on the line.* – The Arnoldfest: Proceedings of the Conference in Honour of V. I. Arnold for his 60th Birthday, Toronto 1997, E. Bierstone, B. Khesin, A. Khovanskii, J. E. Marsden, editors, American Mathematical Society, Providence, RI 1999, 209–223.
- [5] **J. Harris, I. Morrison.** *Moduli of Curves.* Springer-Verlag, 1998.

- [6] **R. Hartshorne.** *Algebraic Geometry*. Springer-Verlag, Graduate texts in mathematics, **52**, 1977.
- [7] **W. J. Harvey.** *Boundary structure of the modular group*. – Riemann surfaces and related topics (I. Kra and B. Maskit, eds.), Annals of Mathematics Studies, Princeton University Press, 1981, 245–251.
- [8] **S. Keel.** *Basepoint freeness for nef and big line bundles in positive characteristic*. – Annals of Mathematics, **149** (1999), 253–286, [arXiv: math.AG/9901149](#).
- [9] **S. Keel.** *Polarized pushouts over finite fields*. – Communications in Algebra, **31** (2003), no. 8, 3955–3982, [arXiv: math.AG/0204243](#).
- [10] **M. Kontsevich.** *Intersection theory on the moduli space of curves and the matrix Airy function*. Communications in Mathematical Physics, **147** (1992), 1–23.
- [11] **E. Looijenga.** *Cellular decompositions of compactified moduli spaces of pointed curves*. – The Moduli Space of Curves (R. Dijkgraaf et al., eds), Birkhäuser, Basel, 1995, 369–400.
- [12] **W. S. Masey.** *A basic course in algebraic topology*. – Graduate texts in mathematics, **127** (1991), Springer-Verlag.
- [13] **K. Strebel.** *Quadratic Differentials*. Springer-Verlag, 1984.
- [14] **D. Sullivan.** *Infinitesimal computations in topology*. – Publication Mathématiques de l’Institut des Hautes Études Scientifiques, **47** (1977), 269–331.