

Reformulating the Map

Louis H. Kauffman

Department of Mathematics, Statistics and Computer Science
University of Illinois at Chicago
851 South Morgan Street
Chicago, IL, 60607-7045

Abstract

This paper discusses reformulations of the problem of coloring plane maps with four colors. We include discussion of the Eliahou-Kryuchkov conjecture, the Penrose formula, the vector cross product formulation and the reformulations in terms of formations and factorizations due to G. Spencer-Brown.

1 Introduction

In this paper we give a concise introduction to the work of G. Spencer-Brown [1] on the Four-Color Theorem and some of the consequences of this work in relation to other reformulations of the four color problem. This work involves a rewriting of the coloring problem in terms of two-colored systems of Jordan curves in the plane. These systems, called *formations*, are in one-to-one correspondence with cubic plane graphs that are colored with three edge colors so that three distinct colors are incident to each vertex of the graph. It has long been known that the four color problem can be reformulated in terms of coloring such cubic graphs.

We first concentrate on proving two key results. The first is a Parity Lemma due to G. Spencer-Brown [1]. This lemma is also implied by work of Tutte [2] via translation from edge colorings to formations. The second result, depending on the Parity Lemma is a proof that a certain principle of irreducibility for formations is *equivalent* to the Four-Color Theorem.

Spencer-Brown takes this principle of irreducibility (here called the *Primality Principle*) to be axiomatic and hence obtains a proof of the Four-Color Theorem that is based upon it. He also gives proofs of the Primality Principle (See Theorem 17 [1], p. 168-170) that depend upon a subtle notion of inverse distinction. This work of Spencer-Brown deserves careful consideration.

The present paper is an expansion of [4]. In that paper we also prove the parity lemma and discuss the primality principle. However, the discussion of factorizability of formations is imprecise in [4] and I have taken the opportunity of this paper to rectify that fault. I hope that this paper attains the desired clarity in regard to parity and primality. In the author's opinion these concepts are central to understanding the nature of the four color theorem, and it is worth a second try at explication.

There are six sections to the present paper. In the first section we give the basics about cubic maps and formations. In the second section we prove the Parity Lemma. In the third section we give the equivalence of the Four-Color Theorem and the Primality Principle. In the fourth section we discuss an algorithm, the Parity Pass, discovered by Spencer-Brown. The Parity Pass is an algorithm designed to color a map that has been colored except for a five sided region. The language of the algorithm is in terms of formations. It is an extraordinarily powerful algorithm and may in itself constitute a solution to the four color problem. It is worth conjecturing that this is so. In the fifth section we discuss an application of formations to the workings of a chromatic counting formula due to Roger Penrose. In section six we apply ideas from formations to the Kryuchkov-Eliahou conjecture, showing that it can be reformulated in terms of coloring and re-coloring trees, and in terms of the vector cross product reformulation of the four color theorem.

Acknowledgement. It gives the author pleasure to thank James Flagg and Karanbir Sarkaria for helpful conversations in the course of constructing this paper.

2 Cubic Graphs and Formations

A *graph* consists in a vertex set V and an edge set E such that every edge has two vertices associated with it (they may be identical). If a vertex is in

the set of vertices associated with an edge, we say that this vertex *belongs* to that edge. If two vertices form the vertex set for a given edge we say that that edge *connects* the two vertices (again the two may be identical). A *loop* in a graph is an edge whose vertex set has multiplicity one. In a *multi-graph* it is allowed that there may be a multiplicity of edges connecting a given pair of vertices. All graphs in this paper are multi-graphs, and we shall therefore not use the prefix "multi" from here on.

A *cubic graph* is a graph in which every vertex either belongs to three distinct edges, or there are two edges at the vertex with one of them a loop. A *coloring* (proper coloring) of a cubic graph G is an assignment of the labels r (red), b (blue), and p (purple) to the edges of the graph so that three distinct labels occur at every vertex of the graph. This means that there are three distinct edges belonging to each vertex and that it is possible to label the graph so that three distinct colors occur at each vertex. Note that a graph with a loop is not colorable.

The simplest uncolorable cubic graph is illustrated in Figure 1. For obvious reasons, we refer to this graph as the *dumbbell*. Note that the dumbbell is planar.

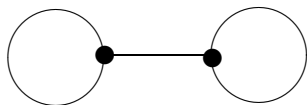

Figure 1 — The Simplest Uncolorable Cubic Graph

An edge in a plane graph is said to be an *isthmus* if the deletion of that edge results in a disconnected graph. It is easy to see that a connected plane cubic graph without isthmus is loop-free.

Heawood reformulated the four-color conjecture (which we will henceforth refer to as the *Map Theorem*) for plane maps to a corresponding statement about the colorability of plane cubic graphs. In this form the theorem reads

Map Theorem for Cubic Graphs. A plane cubic graph without isthmus is properly edge-colorable with three colors.

We now introduce a diagrammatic representation for the coloring of a cubic graph. Let G be a cubic graph and let $C(G)$ be a coloring of G . Using the colors r , b and p we will write purple as a formal product of red and blue:

$$p = rb.$$

One can follow single colored paths on the coloring $C(G)$ in the colors red and blue. Each red or blue path will eventually return to its starting point, creating a circuit in that color. The red circuits are disjoint from one another, and the the blue circuits are disjoint from one another. Red circuits and blue circuits may meet along edges in the G that are colored purple ($p = rb$). In the case of a plane graph G , a meeting of two circuits may take the form of one circuit crossing the other in the plane, or one circuit may share an edge and then leave on the same side of the other circuit. We call these two planar configurations a *cross* and a *bounce* respectively.

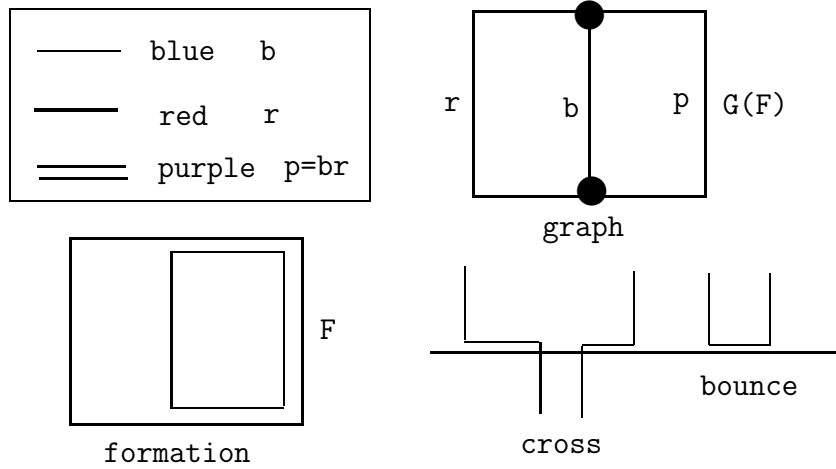

Figure 2 — Coloring and Formation

Definition. A *formation* [1] is a collection of simple closed curves, with each curve colored either red or blue such that the red curves are disjoint from one another, the blue curves are disjoint from one another and red and blue curves can meet in a finite number of segments (as described above for the circuits in a coloring of a cubic graph).

Associated with any formation F there is a well-defined cubic graph $G(F)$, obtained by identifying the shared segments in the formation as edges in the graph, and the endpoints of these segments as vertices. The remaining (unshared) segments of each simple closed curve constitute the remaining edges of $G(F)$. A formation F is said to be a formation for a cubic graph G if $G = G(F)$. We also say that F *formates* G .

A *plane formation* is a formation such that each simple closed curve in the formation is a Jordan curve in the plane. For a plane formation, each shared segment between two curves of different colors is either a bounce or a crossing (see above), that condition being determined by the embedding of the formation in the plane.

Since the notion of a formation is abstracted from the circuit decomposition of a colored cubic graph, we have the proposition:

Proposition. Let G be a cubic graph and $Col(G)$ be the set of colorings of G . Then $Col(G)$ is in one-to-one correspondence with the set of formations for G .

In particular, the Map Theorem is equivalent to the

Formation Theorem. Every cubic, isthmus free plane graph has a formation.

This equivalent version of the Map Theorem is due to G. Spencer-Brown [1]. The advantage of the Formation Theorem is that, just as one can enumerate graphs, one can enumerate formations. In particular, plane formations are generated by drawing systems of Jordan curves in the plane that share segments according to the rules explained above. This gives a new way to view the evidence for the Map Theorem, since one can enumerate formations and observe that all the plane cubic graphs are occurring in the course of the enumeration! See Figures 2 and 3 for illustrations of the relationship of formation with coloring.

Remark. In the figures the reader will note that graphs are depicted with horizontal and vertical edges. This means that some edges have corners. These corners, artifacts of this form of representation, are not vertices of the graph. In depicting formations, we have endeavored to keep the shared seg-

ments slightly separated for clarity in the diagram. These separated segments are amalgamated in the graph that corresponds to the formation.

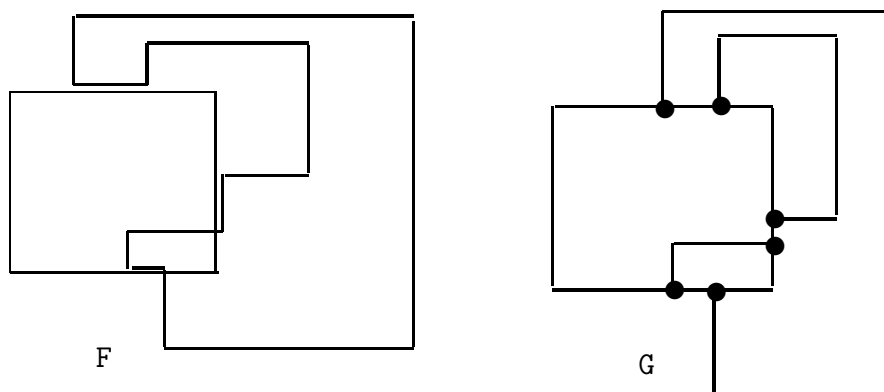

Figure 3 – Second Example of Coloring and Formation

3 Simple Operations and the Parity Lemma

Recall that a *circuit* in a graph G is a subgraph that is equivalent to a circle graph (i.e. homeomorphic to a circle).

Let G be a cubic graph. Suppose that C is a coloring of G with three colors (so that three distinct colors are incident at each vertex of G). Let the colors be denoted by r (red), b (blue) and p (purple). Then we can classify circuits in G relative to the coloring C . We shall be concerned with those circuits that contain exactly two colors. The possible two-color circuits are $r - b$ (red-blue), $r - p$ (red-purple) and $b - p$ (blue-purple). Let $\Delta(G, C)$ denote the number of distinct two-color circuits in G with the coloring C .

Definition. Call the *parity* of the coloring C , denoted $\pi(G, C)$, the parity of the number of distinct two-color circuits, $\Delta(G, C)$.

Definition. If C is a coloring of G and d is a two-color circuit in G , then we can obtain a new coloring $C' = C$ of G by interchanging the colors on d . Call

the operation of switching colors on a two color circuit a *simple operation* on the coloring C .

In this section we will prove a basic Parity Lemma and due to Spencer-Brown [1] in the category of formations. A similar result due to W. T. Tutte [2] in the category of plane cubic graphs implies the Parity Lemma, but is proved by a different method. The lemma states that simple operations on planar graphs or planar formations preserve parity. Note that by the results of section one, colorings of cubic graphs and formations for cubic graphs are in one-to-one correspondence. The proof of the parity lemma given here is due to the author of this paper.

Note that for a formation F composed of red and blue loops, the two color circuits are counted by $\Delta(F) = R + B + Alt$ where R denotes the number of red loops, B denotes the number of blue loops, and Alt denotes the number of red-blue alternating circuits in the corresponding coloring. These red-blue circuits are characterized in the formation as the circuits that avoid the places where there is a superposition of red and blue (these places correspond to purple edges in the coloring). The red loops in the formation correspond to red-purple circuits in the coloring, and the blue loops in the formation correspond to blue-purple circuits in the coloring.

Each formation has a corresponding coloring. Simple operations on the coloring induce new formations for the underlying graph. Simple operations can be described directly on a formation via a graphical calculus. This calculus is based on the principle of *idemposition* that *superposition of segments of the same color results in the cancellation of those segments*. The result of an idemposition of loops of the same color is a mod-2 addition of the loops. Two loops of the same color that share a segment are joined at the junctions of the segment, and the segment disappears. In order to perform a simple operation on a blue loop, superimpose a red loop upon it and perform the corresponding idemposition with the other red loops that impinge on this red loop along the blue loop. Similarly, in order to perform a simple operation on a red loop, superimpose a blue loop on it and idempose this blue loop with the blue loops that impinge on the red loop. Finally, in order to perform a simple operation on an alternating circuit in a formation, superimpose a red and a blue loop on this circuit and perform the corresponding idempositions. These instructions for performing simple operations are illustrated in Figure

4.

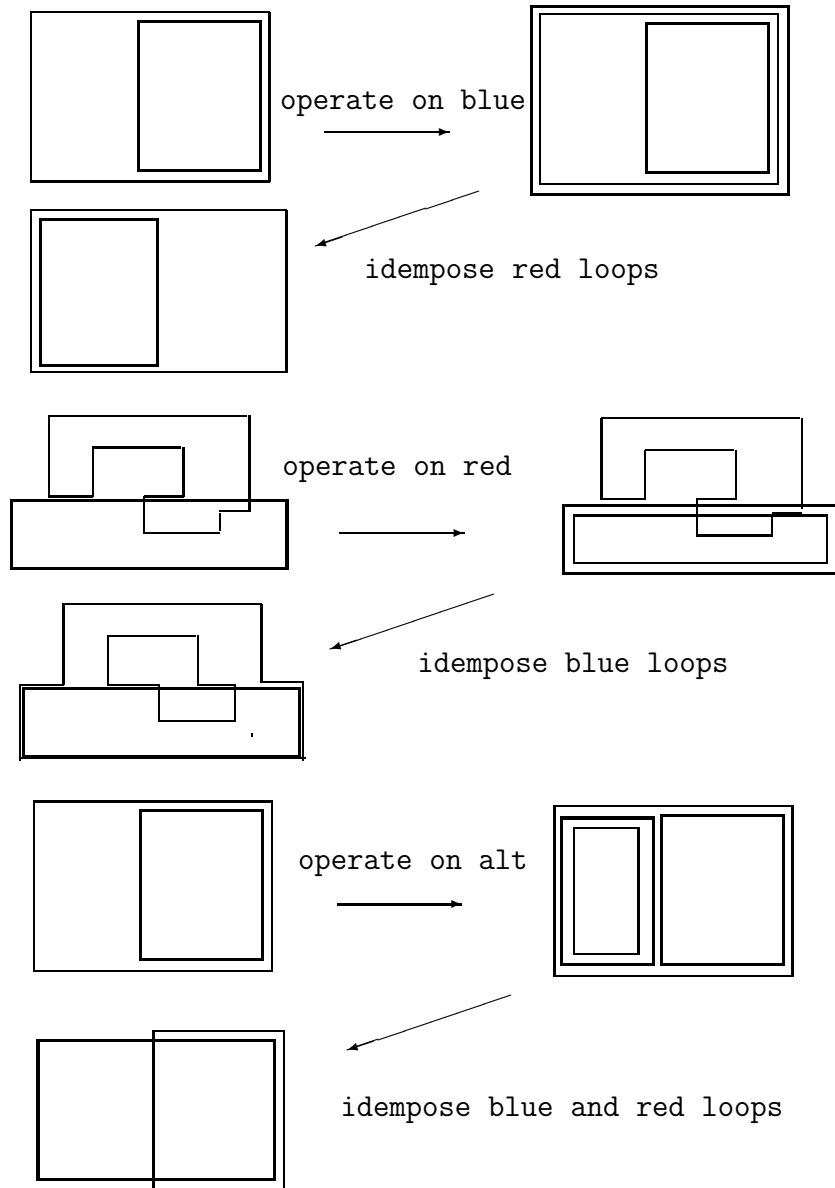
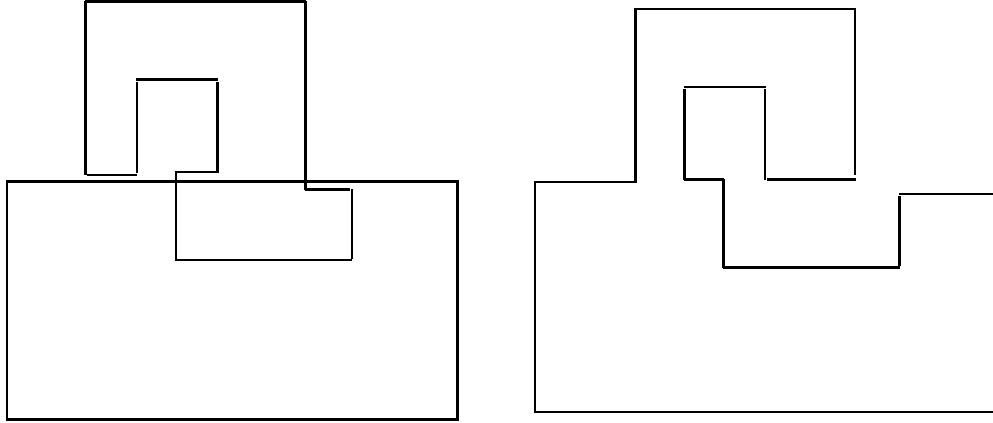

Figure 4 – Simple Operations

Parity Lemma. If C' and C are colorings of a planar cubic graph G with C' obtained from C by a simple operation, then the parity of C' is equal to the parity of C , $\pi(C') = \pi(C)$. Equivalently, parity is preserved under simple operations on planar formations.

In order to prove the Parity Lemma, we need to consider elementary properties of idempositions of loops in the plane.

First consider the idemposition of two loops of the same color, as illustrated in Figure 5. We can distinguish three types of interaction that I denote by L (Left), R (Right) and B (bounce). A bounce (B) is when the second curve shares a segment with the first curve, but does not cross the first curve. Crossing interactions are classified as left and right according as the person walking along the first curve first encounters the second curve on his right (R) or on his left (L). After an encounter, there ensues a shared segment that then leaves in the direction of the opposite hand. Let $|L|$ denote the number of left crossings between the first and second curves, $|R|$ the number of right crossings, and $|B|$ the number of bounces. (Note the $|L|$ and $|R|$ depend upon the choice of direction for the walk along the first curve. Let $P(A, A')$ denote the parity of $(|L| - |R|)/2 + |B|$ for an interaction of curves A and A' .



$$(|L|-|R|)/2 + |B| = (1-1)/2 + 1 = 1$$

Figure 5 – Idempotization

Idempotization Lemma. Let A and A' be two simple closed curves in the plane of the same color. The parity of the number of simple closed curves resulting from the idempotization of A and A' is equal to $P(A, A') = (|L| - |R|)/2 + |B| \pmod{2}$ where the terms in this formula are as defined above.

Proof. The proof is by induction on the number of crossing interactions between the two curves. It is easy to see that the removal of a bounce changes the parity of the idempotization. See Figure 6. Figure 7 illustrates a collection of unavoidable crossing interactions between two curves. That is, if there are crossing interactions, then one of the situations in Figure 7 must occur. (To see this note that if you follow curve A' and cross curve A , then there is a first place where A' crosses A again. The unavoidable configurations are a list of the patterns of crossing and crossing again.) It is then clear from Figure 7, by counting parity after the indicated idempotizations, that the result follows by induction. //

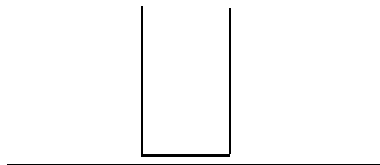

Figure 6 – Bounce

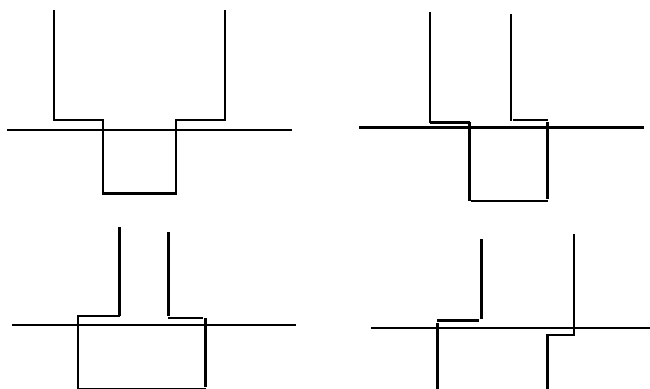

Figure 7 – Innermost Cross and Recross

Proof of the Parity Lemma. Consider a formation F consisting of one red loop A that is touched by a set of n disjoint blue loops. It is clear by construction that the number of alternating (red/blue) circuits in F is equal to the number of loops in the idemposition obtained after letting all the blue loops become red (so that they cancel with the original red loop where blue meets red). As a result, we can apply the Idemposition Lemma to conclude that

$$\Delta(F) = 1 + n + (|L| - |R|)/2 + |B|(\text{mod}2)$$

where $|L|, |R|$ and $|B|$ denote the total number of left, right and bounce interactions between the red curve and the blue curves and n is the number of blue curves. (Apply the Lemma to each blue curve one at a time.) The main

point is that the parity of F is determined by a count of local interactions along the red curve A . In this case, when we perform a simple operation on A , the curve count does not change. We simply interchange the roles of blue circuits (i.e. blue/purple circuits) and alternating circuits (i.e. red/blue circuits). Thus in this case we have that $\Delta(F) = \Delta(F')$ where F' is obtained by a simple operation on the curve A in F . Hence parity is certainly preserved.

In the general case we have a red curve A that interacts with a collection of blue curves, and these blue curves interact with the rest of the formation. Call the whole formation F , and let G denote the subformation consisting of the curve A and all the blue curves that interact with A . If F' is the result of operating on A in F , then F' will contain G' , the result of operating on A in G . G' will consist in the curve A plus all blue curves in F' that touch the curve A in F' . In counting the change of Δ from $\Delta(F)$ to $\Delta(F')$, we actually count the change in the count of blue curves and the change in the count of alternating circuits. Each of these changes can be regarded as the result of a single color idemposition originating at A . The change in Δ from F to F' is the sum of the change in blue curves and the change in alternating circuits. Each of these changes is determined by local interactions along the curve A . The parity of the change depends only on these local interactions. Since the transformation from G to G' has identical local interactions, and since G and G' have the same Δ and hence the same parity, it follows that F and F' have the same parity. (See Figure 8 for an example where the curve count does change while retaining parity.) This completes the proof of the Parity Lemma. //

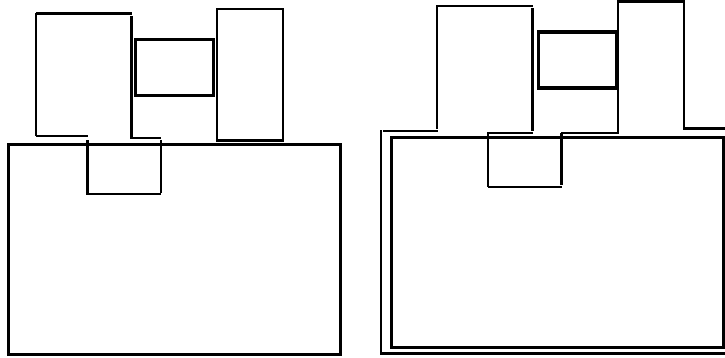

Figure 8 – Changing Curve Count Under Simple Operation

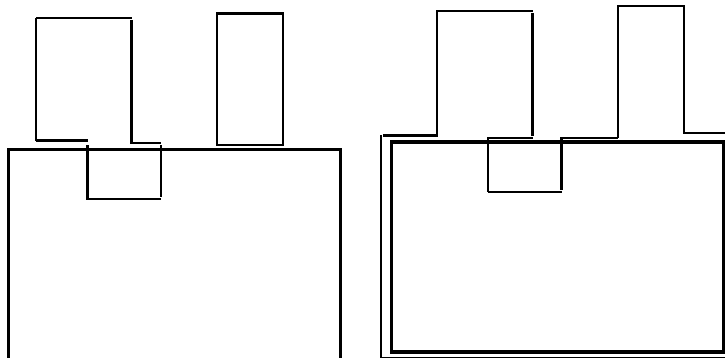

Figure 9 – Unchanging Curve Count Under Simple Operation

Remark. The parity lemma can fail for a non-planar formation. For example, consider the formation in Figure 10. This is a formation for a Petersen graph with one edge removed. As the Figure indicates, parity is not preserved on a simple operation on this graph. The curve count in the first formation is five and the curve count in the second formation (after the simple operation) is four. This shows that the underlying graph of these two formations is non-planar.

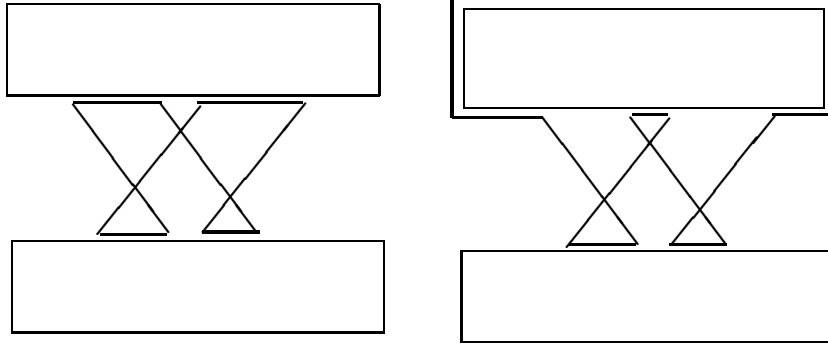

Figure 10 – Parity Reversed in the One-deleted Petersen

4 A Principle of Irreducibility

The main result of this section is the equivalence of the Four Color Theorem with a property of formations that I call the *Primality Principle*. In order to state this property we need to explain the concept of a *trail* in a formation, and how a trail can facilitate or block an attempt to extend a coloring.

Consider a formation with two blue loops and a single red loop that interacts with the two blues. See Figure 11 for an illustration of this condition. I shall call the red loop a *trail* between the two blues. Call the blue loops the *containers* or *contextual loops* for the trail. Call the *graph of the trail* T the cubic graph $G(T)$ corresponding to the formation consisting in the two blues and the red loop between them as in Figure 12. In Figure 11 we have also indicated a double arrow pointing between the two blue loops and disjoint from the trail. The double arrow is meant to indicate an edge that we would like to color, extending the given formation to a new formation that includes this edge. We shall refer to this double arrow as the *empty edge*. In the example shown in Figure 13 we obtain this extension by drawing a purple (blue plus red) loop that goes through the empty edge. The part of the purple loop that is not on the arrow is a pathway in the given formation from one arrow-tip to the other that uses only two colors (red and blue). After

idemposition, this purple loop effects a two-color switch along this pathway and the formation is extended as desired.

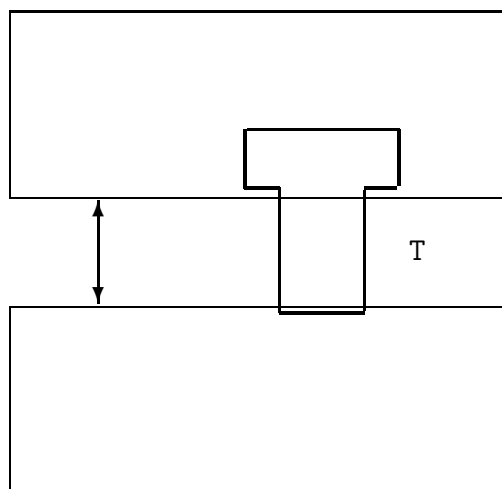

Figure 11 – A Trail Between Two Blue Loops

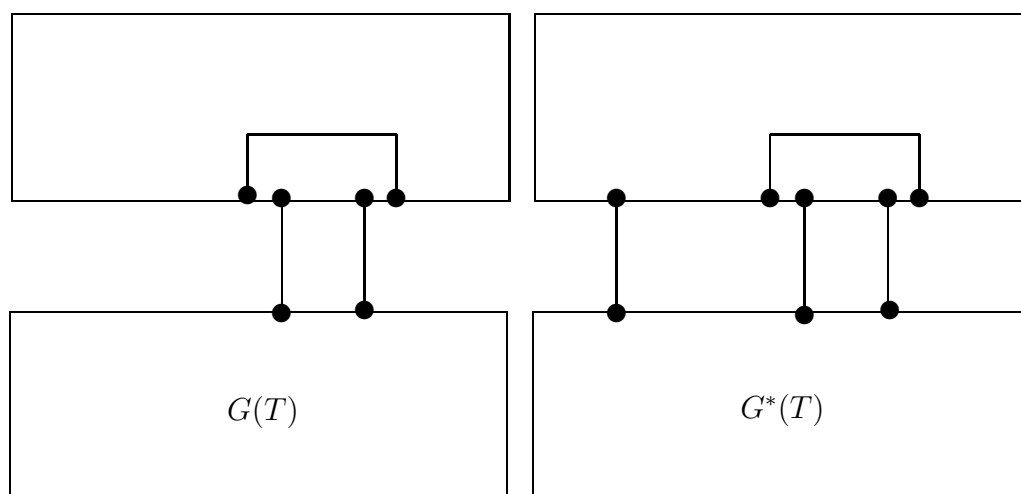

Figure 12 – The Graphs $G(T)$ and $G^*(T)$

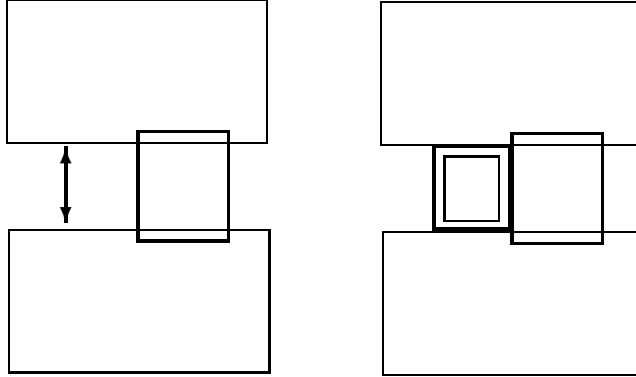

Figure 13 – A Colorable Trail

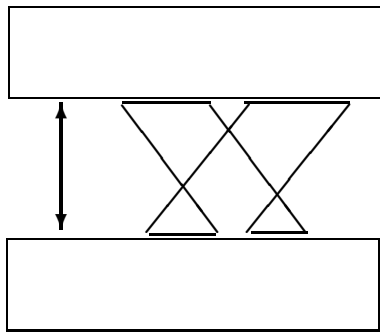

Figure 14 – The Petersen Trail

Another example of a trail is shown in Figure 14. Here no extension is possible since the extended graph is the Petersen graph, a graph that does not admit a coloration.

In a trail the endpoints of the empty edge are specified, since one would like to complete the formation over the empty edge. The simplest example of uncolorability is just two loops and an empty edge. Then no matter how the loops are colored there is no way to extend the formation over the empty edge.

There are two cases in the structure of a trail: The two contextual loops have the same color or they have different colors. We shall distinguish these two cases by *defining* the colors of the contextual loops to be the colors incident at the endpoints of the empty edge. Note that when we refer to a loop in a formation we mean either a blue loop, a red loop or a cycle that alternates in red and blue when we are performing a parity count. On the other hand one can also consider purple loops, but these will appear in the formation as alternations of purple with blue or red at those sites where the purple is idemposed with red or blue respectively. When counting loops, we shall only count blue, red and alternating (red and blue).

We first consider contextual loops of the same color. Suppose that both contextual loops are purple. Then any trail between them must be drawn either in blue or in red. It will be called a *non-purple trail*. Thus one could insert a Petersen trail drawn as a red loop and then idemposed between the purple loops, or a Petersen trail drawn as a blue loop and then idemposed between the two purples. We will say that a trail between two loops of the same color (red,blue or purple) is *factored* if after removing the two contextual loops (by idemposing them with loops of the some color) the remaining trail structure has multiple components.

See Figure 15 for an illustration of this removal process. This means that the “trail” that we uncover by the removal process is *not* the color of the two loops and it does not touch the endpoints of the empty edge. In Figure 15 we illustrate a trail between two purples. That is, each empty edge touches the color purple. In the second part of the figure we reveal the purples so that an idemposition of this figure gives the first part and a removal of the two purple loops gives the single trail component. This trail is not factored.

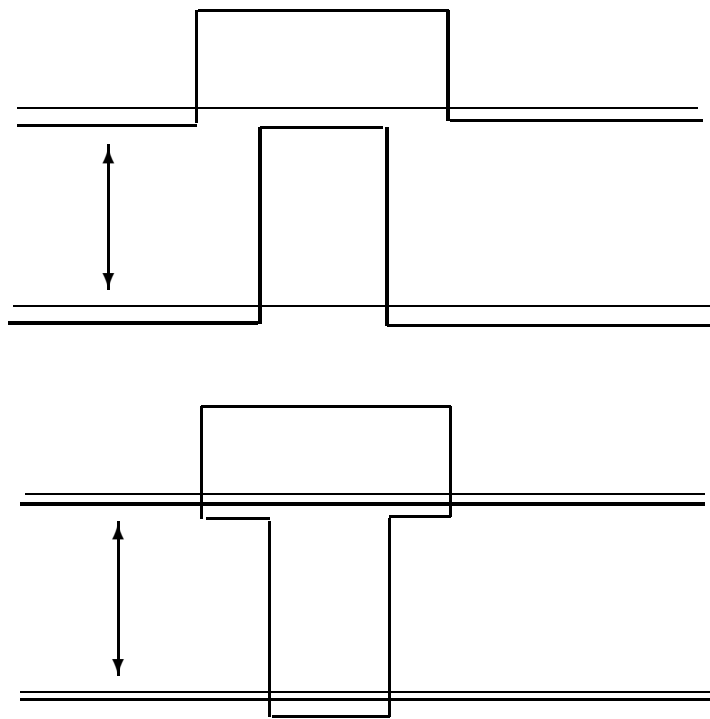

Figure 15 — A Trail Between Two Purples

For the case where both contextual loops have the same color there is no loss in generality in assuming that the two conceptual loops are both red or both blue. Then any extra loops in a factorization can be seen directly, in their appearance as alternating, blue or red.

Secondly, suppose that the two contextual loops have different colors. And suppose that the formation has a non-empty trail structure between the two loops. We say that this formation is *factored* with respect to the empty edge if there is a loop in the formation that does not pass through either endpoint of the empty edge. For example, operate on the Petersen trail as in Figure 14, making the top loop purple (at an endpoint of the empty edge). Note that in this example every loop in the formation passes through one of the endpoints of the empty edge, so it is not factored. Second example: Operate on the top loop in Figure 11. You will find that this produces a red loop that is isolated from the empty edge, giving a factorization.

We shall say that a formation is *unfactored* if it is not factorized.

We shall say that a trail T *factorizes* if there is a formation for the graph $G(T)$ (see definition above) of this trail that is factored. Note that we do not require that the original version of the trail be factored. A new version can be obtained by simple operations on the original formation, or by more complicated re-colorings. A trail is said to be *prime* if it does not admit a factorization.

Sometimes a trail can factorize by simple operations as in the example in Figure 16. In the example in Figure 16 we perform a simple operation on the upper blue loop. Note that in the resulting factorization the arrow is now between a lower blue loop and a part of the upper blue loop that has a superimposed red segment from one of the factors. The Petersen trail of Figure 14 is a significant example of a prime trail. Simple operations on the formation of this trail just return the Petersen trail in slightly disguised form.

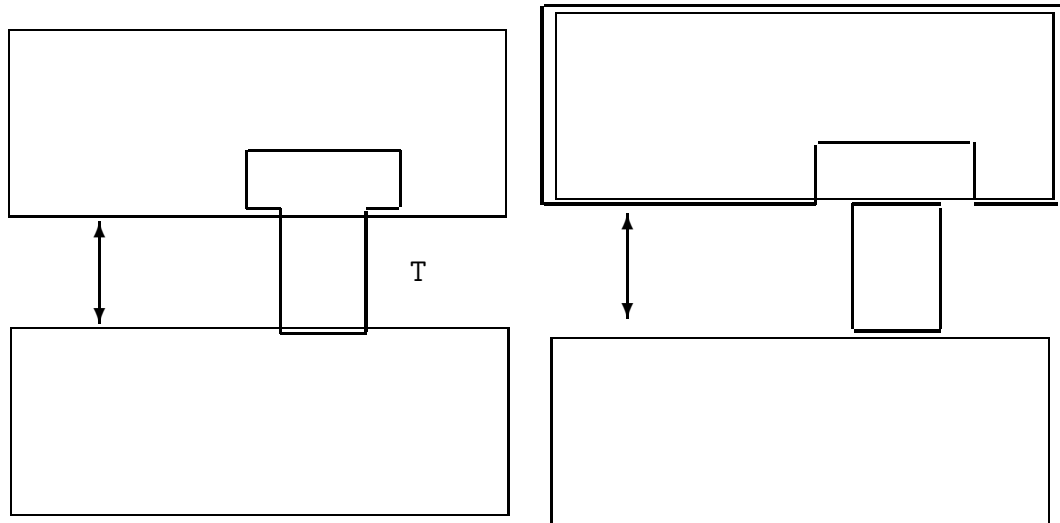

Figure 16 – A Factorizable Trail

A trail is said to be *uncolorable* if the graph $G^*(T)$ obtained from $G(T)$ by adding the edge corresponding to the double arrow is an uncolorable graph.

Thus the Petersen trail is uncolorable since $G^*(T)$ is the Petersen graph. A trail is said to be a *minimal uncolorable* trail if the graph $G^*(T)$ is a smallest uncolorable graph. Now the Petersen graph is the smallest possible uncolorable graph other than the dumbbell shown in Figure 1. In particular, the Petersen is the smallest non-planar uncolorable. This does not, in itself, rule out the possibility of planar uncolorables other than the dumbbell (that is the essence of the Four Color Theorem). Hence we can entertain the *possibility* of planar minimal uncolorable trails.

Now we can state the

Primality Principle. A planar minimal (non-empty) uncolorable trail is prime.

In other words, this principle states that there is no possibility to make a planar minimal uncolorable trail that is factorized into smaller planar trails. The principle lends itself to independent investigation since one can try combining trails to make a possibly uncolorable formation (i.e. that the graph $G^*(T_1, \dots, T_n)$ is uncolorable where this graph is obtained from the formation consisting in the trails T_1, \dots, T_n placed disjointly between two blue loops.) The combinatorics behind this principle are the subject of much of the research of G. Spencer-Brown. Spencer-Brown regards the Primality Principle as *axiomatic* (See [1] page 169). It is one purpose of this paper to point out the equivalence of the Four Color Theorem and the Primality Principle.

Theorem. The Primality Principle is *equivalent* to the Four Color Theorem.

Proof. First suppose the Primality Principle - that minimal uncolorable trails are prime. Let T be a minimal uncolorable non-empty planar trail. Without loss of generality T is defined by a formation consisting in a single red loop (the trail) drawn between two disjoint blue loops. We call this formation $F(T)$, the formation induced by the trail T . It can be depicted so that the two blue loops appear as parallel lines (to be completed to circuits (above for the top line and below for the bottom line) and the trail T interacting between the two parallel blue lines. In this depiction, we can set a double arrow indicator between the two parallel lines and entirely to the left of T . This double-arrow represents an edge that we would like to complete to form a larger formation/ coloring. Uncolorability of the trail means that

there is no coloring of the graph obtained by adding an edge corresponding to the double arrow to the underlying graph of $F(T)$.

Note that an uncolorable trail is necessarily incompletable (across the empty edge) by simple operations. This implies that there is no two-color pathway in the given formation of the trail from one endpoint of the empty edge to the other endpoint. We can use these facts to count the number of loops in a minimal uncolorable trail.

First consider a prime uncolorable trail with two blue contextual loops, and an existing trail between them in red. This trail must consist in a single red loop. There can be no other red loops in the formation. There is an alternating loop incident to each endpoint of the empty edge. Thus there are at most two alternating loops, one for each endpoint of the empty edge. (Other alternating loops would become red components after the removal of the contextual loops.) If there is one alternating loop, then there is a two-color pathway between the endpoints of the empty edge, and the formation is completable over this edge. Hence there is only one alternating loop. Thus we see that the loop count (two red, one blue, two alternating) for a prime uncolorable formation with two blue contextual loops is *five*.

Second, consider a prime, uncolorable trail with one purple contextual loop and one blue contextual loop. The trail structure will then consist in red loops woven between the two contextual loops. Once these red loops are idemposed with the purple, the formation can be regarded as two blue loops with the trail structure passing through (say) the upper endpoint of the empty edge, so that this upper endpoint rests on purple. Such a formation is unfactored when all loops pass through the endpoints of the empty edge. Thus we have a single blue loop and a single alternating loop passing through the lower endpoint, and one red loop and one blue loop passing through the upper endpoint. This makes a total of two blues, one red and one alternator, hence a loop count of *four* for a prime uncolorable formation with contextual loops of different colors.

Now consider a planar formation $F(T)$ that is minimal, prime and uncolorable. Suppose that it has contextual loops of the same color. Thus it has loop count five by the above reasoning. By performing a simple operation on one of the conceptual loops, we obtain a formation F' with contextual loops of

different colors. The loop count of F' cannot be four, since four and five have different parity. Therefore the loop count of F' must be five or greater and we conclude that F' is factorized. Similarly, if we begin with a formation that is uncolored and incompletable between two loops of different color, then by operating on one of them we obtain a formation between loops of the same color. The original loop count is four and the new loop count, being of the same parity, is either less than five (and hence solvable) or greater than five (and hence factored). This shows that there does not exist a minimal prime uncolorable (incompletable over the empty edge) planar trail $F(T)$. If there are uncolorables then there are minimal uncolorables. Therefore, no minimal uncolorable planar trail is prime. (The trail factors cannot themselves be uncolorable, since this would contradict minimality.) But this is a direct contradiction of the primality principle. Hence the primality principle implies that there are no uncolorable non-empty planar trails.

Now consider a minimal uncolorable cubic graph. Such a graph entails the possible construction of a minimal uncolorable non-empty trail. (Drop an edge from the graph and color the deleted graph. The missing edge cannot be on a single loop in the corresponding formation since that will allow the filling in of the missing edge and a coloration of an uncolorable. Therefore we may take the missing edge to be between two blues. If there is more than one trail factor between these two blues then we would have a factored minimal uncolorable trail. Primality implies that there is only one factor. Therefore the Primality Principle in conjunction with the Parity Lemma implies the non-existence of a minimal uncolorable cubic graph with a non-empty trail in the coloration of the deletion (by one edge) of the graph. The only remaining possibility is that after deleting one edge, the graph is identical to two loops. The dumbbell (See Figure 1) is the only such graph. Therefore the primality principle implies the Four Color Theorem.

Conversely, assume the Four Color Theorem. Then indeed there does not exist a minimal uncolorable non-empty planar prime trail (since it by definition implicates an uncolorable plane cubic graph with no isthmus). Hence the statement of the Primality Principle is true. This completes the proof of the Theorem.//

Remark. This Theorem constitutes a reformulation of the Four Color Theorem, in terms of the Primality Principle. This reformulation takes the col-

oring problem into a new domain. In the work of G. Spencer-Brown this reformulation has been investigated in great depth. The capstone of this work is an algorithm called the *parity pass* ([1] pp. 182-183) that is intended to extend formations across an uncompleted five-region whenever the given formation does not already solve by simple operations. Spencer-Brown has stated repeatedly that this approach gives a proof of the Four-Color Theorem. It is not the purpose of this paper to give full review of that work. We recommend that the reader consult Spencer-Brown [1].

5 The Parity Pass

In the previous section we showed that the Four Color Theorem was equivalent to the Primality Principle which states that one cannot build planar uncolorable 1-deficient formations by combining colorable trail factors. Experience in working with the calculus of formations tends to bolster one's belief in this principle. There is another approach to coloring, also due to Spencer-Brown that sheds light on this issue. It is well known since Kempe [5] that if one could give an algorithm that would color a cubic map in the plane when a coloring was given at all but one five-sided region, then any map could be colored with four colors. In this section, we describe an algorithm (The Parity Pass) that is designed to handle the five region in the context of formations. Spencer-Brown asserts that *given a planar formation that is 1-deficient at a five-region, it is either completable by simple operations, or some stage in the parity pass algorithm is completable by simple operations.* We refer the reader to [1] for more details about the context and possible proof of this algorithm. The purpose of this section is to give a condensed description of the Parity Pass, and to urge the reader to try it out on 'hard' examples.

View Figure 17. This Figure contains a complete diagrammatic summary of the Parity Pass. There is an initial diagram and four successive transformations (A, B, C, D) to related diagrams. The last diagram is locally identical to the first diagram. Each transformation consists in a single idemposition of a closed loop on the given formation. In some cases this loop goes through one of the empty edges, coloring it, while transforming one of the edges at the five-region into an empty edge. We call this a *complex op-*

eration. In other cases the transformation is a simple operation on the given formation. In fact A , C and D are complex operations, while B and E are simple operations. Each operation can be performed if the given formation is not completable by simple operations at the five region. We leave it as an (easy!) exercise for the reader to deduce from each transformed diagram the locus of the putative operation that produces it. This locus, and the type of operation can be deduced by comparing the changes between the diagram and its transform. We also leave to the reader the verification that *when a transform cannot be accomplished, then the domain formation can be completed by simple operations originating at the five region.*

It is a fascinating exercise to perform this algorithm on examples. Success consists in being *unable* to apply one of the four operations of the parity pass, since this inability implicates a solvable formation. Figures 18 and 19 give two examples for the reader to examine. These exercises involve quite a bit of diagrammatic work, but it is worth the effort.

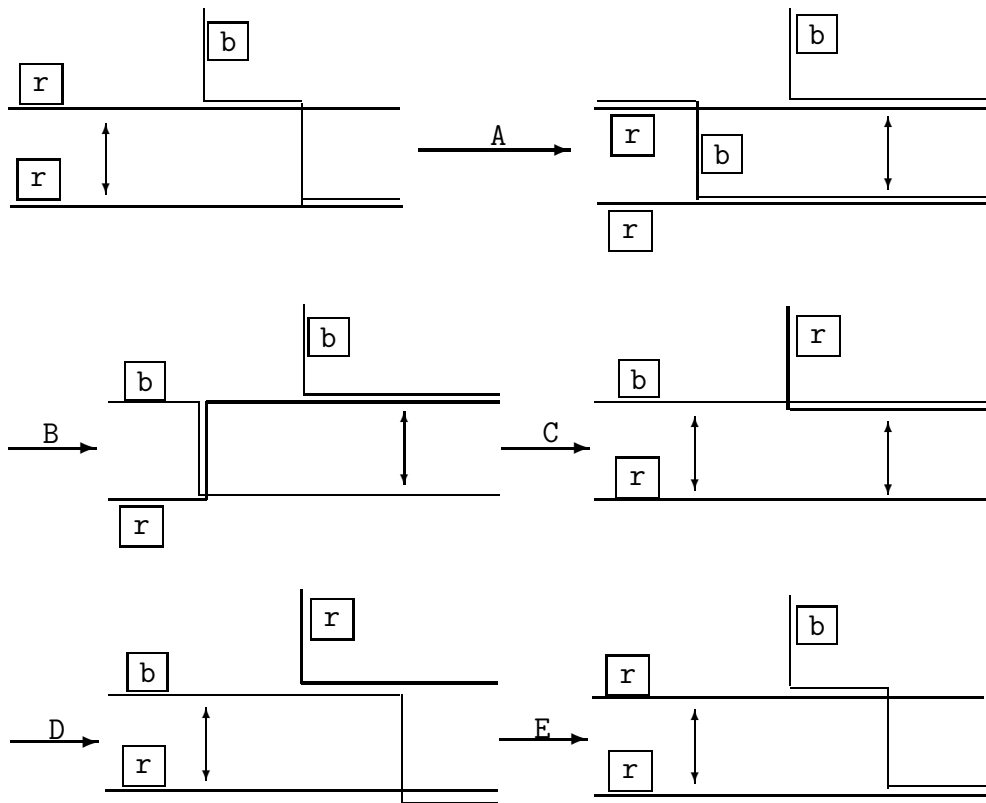

Figure 17 - The Parity Pass

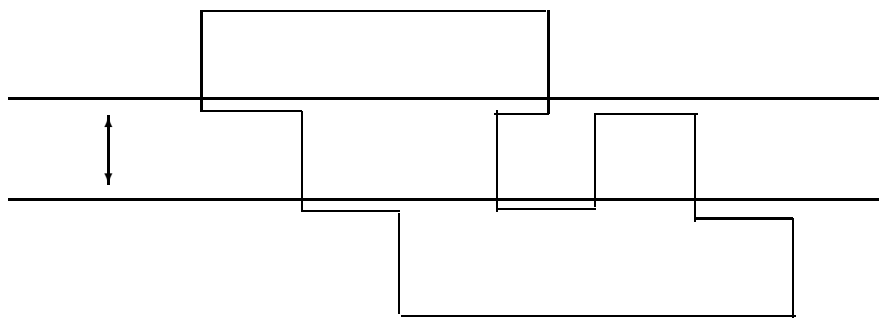

Figure 18 - Culprit Number One

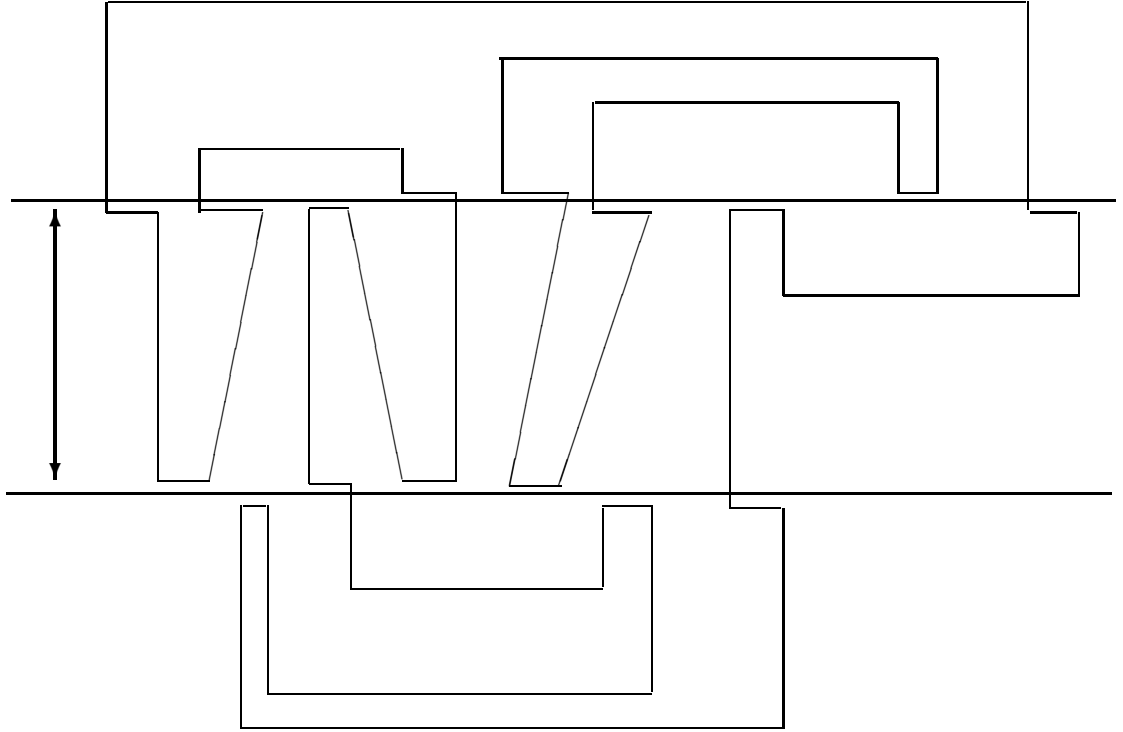

Figure 19 - Culprit Number Two

In these examples, Culprit Number One (Figure 18) will solve via parity pass after application of A , B and C . Culprit Number Two (Figure 19) will solve via parity pass after application of A and B . Culprit Number Two is an example of a “good try” at making a factorized minimal uncolorable in the plane. As we mentioned in the last section, Spencer-Brown asserts that either the parity pass solves a five region extension problem, or the problem could have been solved by simple operations at the outset.

6 The Penrose Formula

Roger Penrose [6] gives a formula for computing the number of proper edge 3-colorings of a plane cubic graph G . In this formula each vertex is associated with the “epsilon” tensor

$$P_{ijk} = \sqrt{-1}\epsilon_{ijk}$$

as shown in Figure 20.

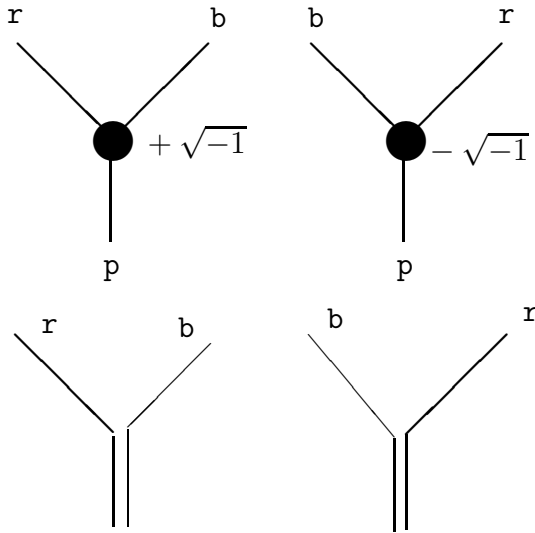

Figure 20 - Epsilon Tensor

One takes the colors from the set $\{1, 2, 3\}$ and the tensor ϵ_{ijk} takes value 1 for $ijk = 123, 231, 312$ and -1 for $ijk = 132, 321, 213$. The tensor is 0 when ijk is not a permutation of 123. One then evaluates the graph G by taking the sum over all possible color assignments to its edges of the products of the P_{ijk} associated with its nodes. Call this evaluation $[G]$. It follows from this description that only proper colorings of G contribute to this summation and that each such coloring contributes a product of $\pm\sqrt{-1}$ from the tensor evaluations at the nodes of the graph. In order to see that $[G]$ is equal to the number of colorings for a plane graph, one must see that each such contribution is equal to $+1$. The proof of this assertion is given in Figure 21 where we see that in a formation for a coloring each bounce contributes $+1 = -\sqrt{-1}\sqrt{-1}$ while each crossing contributes -1 . Since there are an even number of crossings among the loops in the formation, it follows that the total product is equal to $+1$.

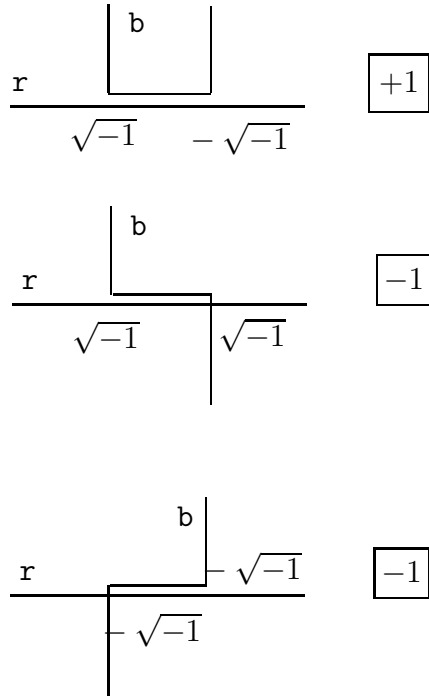

Figure 21 - Cross and Bounce

It is easy to see from properties of the epsilon tensor that this coloring evaluation $[G]$ satisfies the recursive identity shown in Figure 22. Here we have that $[O] = 3$ where O denotes an isolated loop, and the recursive formula includes graphs with extra crossings as shown in the Figure. This use of formations gives an exceptionally easy access to the theory of the Penrose formula.

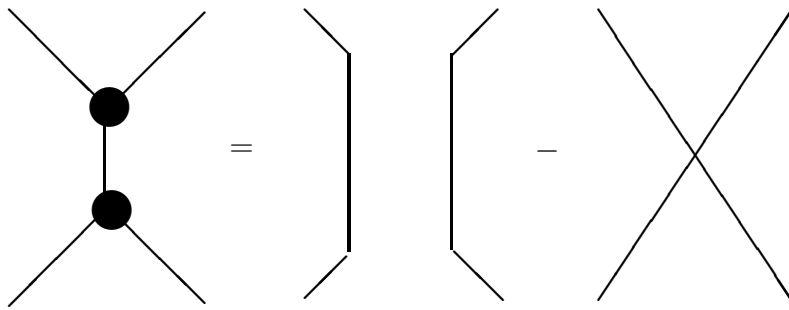

Figure 22 - Penrose Formula

7 The Kryuchkov-Eliahou Conjecture

The Kryuchkov-Eliahou Conjecture [7, 8] is about “reassociating” signed trees. The basic reassociation pattern is shown in Figure 23. One allows this move inside a larger tree with the stipulation that the two adjacent vertices in the reassociation are assigned the same sign and that they both receive the opposite of this sign after the reassociation. The conjecture then states that *given any two trees (with cubic vertices) and the same number of twigs, then there exist assignments of signs to their vertices so that one signed tree can be transformed to the other signed tree by a series of signed reassociation moves.* We shall refer to this conjecture as the KE conjecture.

It was known to the authors of this conjecture that the four color theorem follows from it. In [9] it has been shown that in fact the KE conjecture is equivalent to the four color theorem. We mention the KE conjecture here to point out that it says that one can edge color the two trees so that one tree can be obtained from the other by reassociation moves on the colorings as shown in Figure 23 using formations. The formations make the nature of the reassociation move clear. It is remarkable that the four color theorem is equivalent to this very specific statement about coloring trees.

We can see just how the KE conjecture is related to the vector cross product reformulation of the four color theorem [3]. In the vector cross product reformulation of the four color theorem, we are given two associated products of the same ordered sets of variables. The *vector product conjecture* then states that there exist assignments to the variables from the set of generators $\{i, j, k\}$ of the vector cross product algebra in three dimensional space such that each product is non-zero in this algebra. (This is sufficient to make the two products equal since if they are non-zero then all partial products are non-zero and hence each product may be viewed in the quaternions. Since the quaternions are associative, it follows that the two products are equal.)

Let the two associations of the product of n variables be denoted L and R .

The KE conjecture tells us that there exists a solution to the equation $L = R$ in the vector cross product algebra that is equipped with a series of algebraic reassociations taking L to R such that all of the intermediate

terms in the sequence of reassociations are non-zero (evaluated as vector cross products).

The proof of this assertion is easy to see using the formalism of formations. This extra texture in the vector cross product formulation, and its relationship with the quaternions may provoke us to new algebraic insight into the nature of the four color theorem.

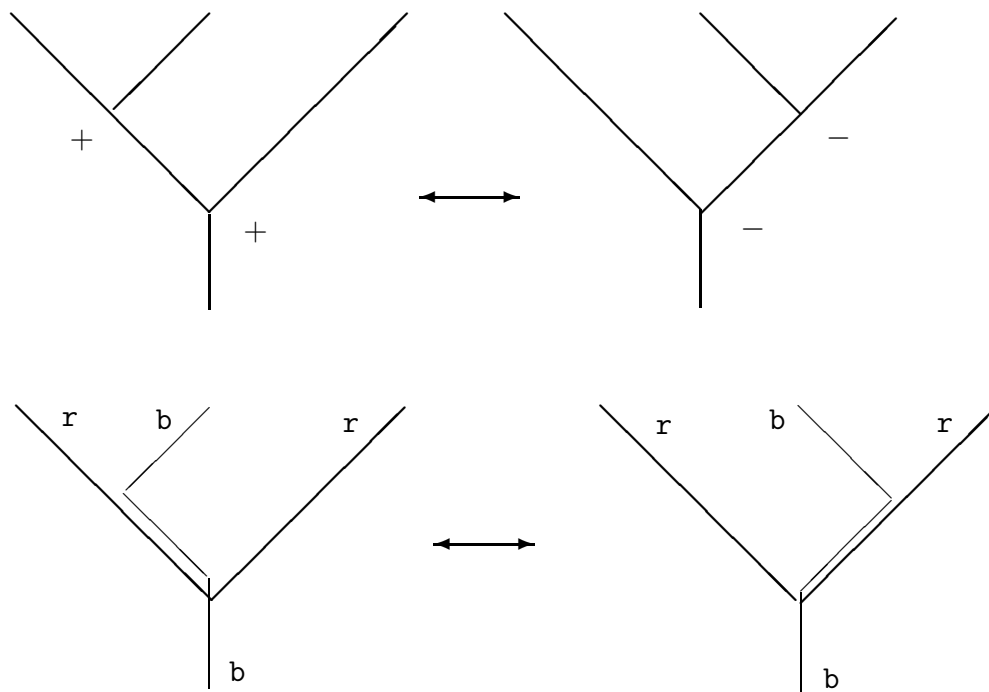

Figure 23 - Signed Reassociation

References

- [1] G. Spencer-Brown, *Laws of Form, Gesetze der Form*, Bohmeier Verlag and Spencer-Brown Publishing (1997),
- [2] W. T. Tutte, On the Four-Color Conjecture, *Proc London Math Soc*, Ser. 2, Vol. 50 (1948) 137-149.
- [3] L. H. Kauffman, Map coloring and the vector cross product *J Comb Theo B* vol 48, no 2, April (1990) 145-154.
- [4] L. H. Kauffman, On the Map Theorem *Discrete Math* 229 (2001) 171-184.
- [5] A.B. Kempe, On the geographical problem of the four colors, *Am J Math* 2 (1879) 193-201.
- [6] R. Penrose, Applications of negative dimensional tensors *Combinatorial Mathematics and Its Applications* edited by D. J. A. Welsh, Acad Press (1971).
- [7] S. I. Kryuchkov, The four color theorem and trees. I. V. Kruchatov Institute of Atomic Energy, Moscow (1992) - IAE-5537/1.
- [8] S. Eliahou, Signed diagonal flips and the four color theorem. *Europ J Comb* 20 (1999) 641-646.
- [9] S. Gravier and C. Payan. Flips signes et triangulations d'un polygone *Laboratoire Leibniz-IMAG, Grenoble, France*, preprint Sept. 2000.