

THINNING GENUS TWO HEEGAARD SPINES IN S^3

MARTIN SCHARLEMANN AND ABIGAIL THOMPSON

ABSTRACT. We study trivalent graphs in S^3 whose closed complement is a genus two handlebody. We show that such a graph, when put in thin position, has a level edge connecting two vertices.

1. INTRODUCTION

We briefly review the terminology of Heegaard splittings, referring the reader to [Sc] for a more complete description. A *Heegaard splitting* of a closed 3-manifold M is a division of M into two handlebodies by a connected closed surface, called the Heegaard surface or the splitting surface. A *spine* for a handlebody H is a graph $\Gamma \subset \text{interior}(H)$ so that H is a regular neighborhood of Γ . A *Heegaard spine* in M is a graph $\Gamma \subset M$ whose regular neighborhood $\eta(\Gamma)$ has closed complement a handlebody. Equivalently, $\partial\eta(\Gamma)$ is a Heegaard surface for M . We say that Γ is of genus g if $\partial\eta(\Gamma)$ is a surface of genus g .

Any two spines of the same handlebody are equivalent under edge slides (see [ST1]). It's a theorem of Waldhausen [Wa] (see also [ST2]) that any Heegaard splitting of S^3 can be isotoped to a standard one of the same genus. An equivalent statement, then, is that any Heegaard spine for S^3 can be made planar by a series of edge slides.

On the other hand, without edge slides, Heegaard spines in S^3 can be quite complicated, even for genus as low as two. For example, let L be a 2-bridge knot or link in bridge position and γ be a level arc that connects the top two bridges. Then it's easy to see that the graph $L \cup \gamma$ is a Heegaard spine since, once γ is attached, the arcs of Γ descending from γ can be slid around on γ until the whole graph is planar. More generally, a knot or link is called *tunnel number one* if the addition of a single arc turns it into a Heegaard spine. For Heegaard spines constructed in this way, it was shown in [GST] that the picture for the two-bridge knot is in some sense the standard picture. That is, if L is a tunnel number one knot or link put in minimal bridge position, and γ is an unknotting tunnel, then γ may be slid on L and isotoped in S^3 until it is a level arc. The ends of γ may then be at

Date: November 2, 2018.

Research supported in part by NSF grants and by the generous support of RIMS, Kyoto.

the same point of K (so γ becomes an unknotted loop) or at different points (so γ becomes a level edge). It can even be arranged that, when γ is level, the ends of γ lie on one or two maxima (or minima). Finally, in [GST] the notion of *width* for knots was extended to trivalent graphs, and it was shown that this picture of $L \cup \gamma$ is in some sense natural with respect to this measure of complexity. Specifically, if γ is slid and isotoped to make the graph Γ as thin as possible without moving L , then γ will be made level.

This raises a natural question. As we've seen, choosing γ to make $L \cup \gamma$ as thin as possible reveals that γ can actually be made level. So suppose Γ is an arbitrary Heegaard spine of S^3 (but trivalent so the notion of thin position is defined) and we allow no edge slides at all. Suppose a height function is given on S^3 and we isotope Γ in S^3 to make it as thin as possible. What can then be said about the positioning of Γ ? We will answer the question for genus two Heegaard spines by showing this: once a trivalent genus 2 Heegaard spine Γ is put in thin position, some simple edge (that is, an edge not a loop) will be level. It is an intriguing question whether there is any analogous result for higher genus Heegaard spines.

Here is an outline of the rest of the paper. In Section 2, we give some definitions and we prove a preliminary proposition (Proposition 2.4) generalizing a theorem of Morimoto, and a preliminary lemma (Lemma 2.13) for eyeglass graphs. In section 3 we state and prove the two main theorems of the paper (Theorems 3.1 and 3.3) together with Corollary 3.4 which gives the result stated in the abstract. In section 4 we state and prove a technical lemma (Lemma 4.1) needed in the proof of Theorem 3.3.

2. PRELIMINARIES

Definition 2.1. *Let $\Gamma \subset S^3$ be a trivalent graph. Suppose a height function is defined on S^3 . A cycle in Γ is vertical if it has exactly one minimum and one maximum. Γ is in bridge position if every minimum lies below every maximum. A regular minimum or maximum is one that does not occur at a vertex. A trivalent graph is in extended bridge position (Figure 1) if any minimum lying above a regular maximum (resp. maximum lying below a regular minimum) is a Y -vertex at the minimum (resp. λ -vertex at the maximum) of a vertical cycle.*

Definition 2.2. *Suppose $\Gamma \subset S^3$ is a trivalent graph and H is a regular neighborhood. Let μ_1, μ_2 be two meridians of H corresponding to points p_1, p_2 on Γ . Then a path α between the μ_i is regular if it is parallel in $H - (\mu_1 \cup \mu_2)$ to an embedded path in Γ . That is, it intersects each meridian of H in at most one point.*

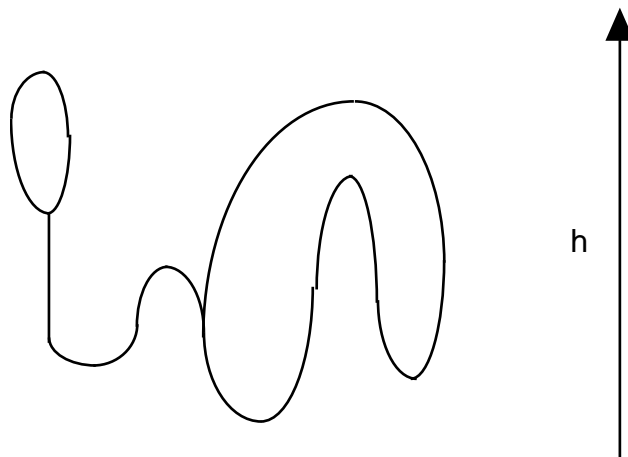

FIGURE 1. extended bridge position

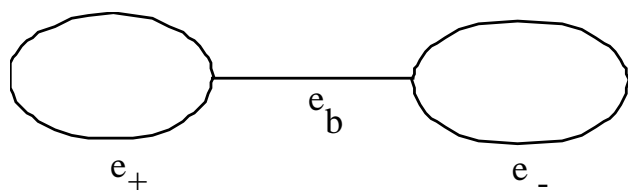

FIGURE 2. eyeglass graph

Definition 2.3. An eyeglass graph (Figure 2) is a graph consisting of two cycles e_{\pm} connected by an edge e_b , called the bridge edge.

We extend a theorem of Morimoto [Mo] that extends earlier work of Gordon-Reid [GR]:

Proposition 2.4. Let Γ be a trivalent Heegaard spine in S^3 whose regular neighborhood H is a genus two handlebody. Suppose Q is a collection of spheres in general position with respect to Γ , so Q intersects H in a collection of meridians, each corresponding to a point in $\Gamma \cap Q$. Suppose $Q - H$ is incompressible in the complement of H and no component is a disk. Then either:

1. each component of $Q \cap \partial H$ is a non-separating curve and each component of $Q - H$ is parallel in $S^3 - H$ to a component of $\partial H - Q$
2. each component of $Q \cap \partial H$ is a separating curve, and each component of $Q - H$ is parallel in $S^3 - H$ to a component of $\partial H - Q$. (Each component of $Q - H$ is then necessarily an annulus).

3. $Q \cap \partial H$ contains both separating and non-separating curves. Then there is a disk $F \subset S^3$ whose interior is disjoint from $H \cup Q$ and $\partial F = \alpha \cup \beta$, where $\alpha \subset \partial H$, $\beta \subset Q$. Either
- (a) α is a regular path on ∂H that is disjoint from some meridian corresponding to a point in e_b or
 - (b) α has both ends at the same separating meridian and intersects some non-separating meridian in exactly one point.

Remark: Of course, unless Γ is an eyeglass whose bridge edge is intersected by Q , only the first possibility is relevant. Notice also that in case 1) or case 2) then automatically there is a disk as described in item (3a).

Proof. The first two cases are proven by Morimoto [Mo]. So we assume Γ is an eyeglass graph. The proof will be by induction on $Q \cap e_b$; when $Q \cap e_b = \emptyset$ the result follows from case 1), so we assume $Q \cap e_b \neq \emptyset$.

Let E be an essential disk in the closed complement of H . We can assume that some component of $Q \cap H$ is a separating meridian, or else item 1) would apply. We can assume that $E \cap Q \neq \emptyset$ or else some component of Q with a separating meridian would be compressible. Let E_0 be an outermost arc of E cut off by Q . Let $\alpha = E_0 \cap \partial H$, $\beta = E_0 \cap Q$. We can assume there are no disks of intersection between E_0 and Q since Q is incompressible. If α connects distinct meridians of H we are done, for α is disjoint from the meridian corresponding to any point in $Q \cap e_b$, so E_0 serves for F in (3a). So we will suppose both ends of α lie at the same meridian μ of Q . A counting argument on the number of intersection points between ∂E and the three natural meridian curves on $\partial \Gamma$ shows that μ cannot be non-separating.

So suppose μ is separating and α intersects a meridian of e_+ non-trivially. Join the ends of α together on μ to get a closed curve α_+ lying on the boundary of a solid torus (essentially a neighborhood of e_+) and bounding a disk in its complement (the disk is the union of E_0 and a disk in Q). Hence α_+ is a longitude and we have item 3b); a meridian of e_+ is the meridian intersected once.

The interesting case is when μ is separating and α is a “wave” at an end of e_b , that is, α is disjoint from a meridian of each cycle (Figure 3). In this case, modify Q by “splitting” the end of e_b to which ∂E_0 is incident. Equivalently, push out that meridian of Q past the end of e_b so that it splits into two meridians of, say, e_- (Figure 4). Call the new collection of spheres Q' . The splitting converts E_0 into a compressing disk for Q' . Let Q_0 be the collection of spheres obtained by compressing Q' along that disk.

Obviously $Q_0 \cap e_b$ has one less point than $Q \cap e_b$. We claim that Q_0 is incompressible. To verify this, consider the tube dual to the compression disk (that is, Q' is recovered by tubing together two components of Q_0 along this tube). The tube is parallel to a regular arc γ in ∂H connecting the two

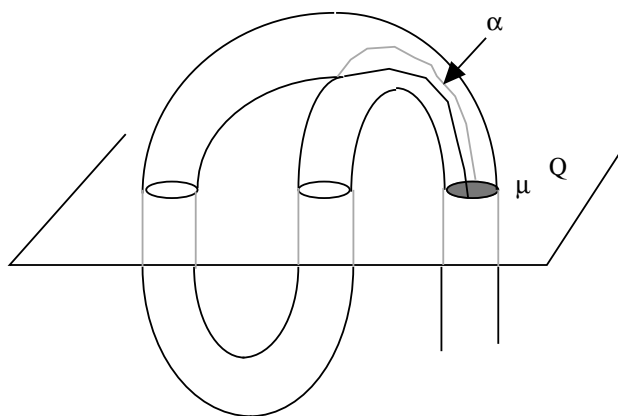

FIGURE 3. wave

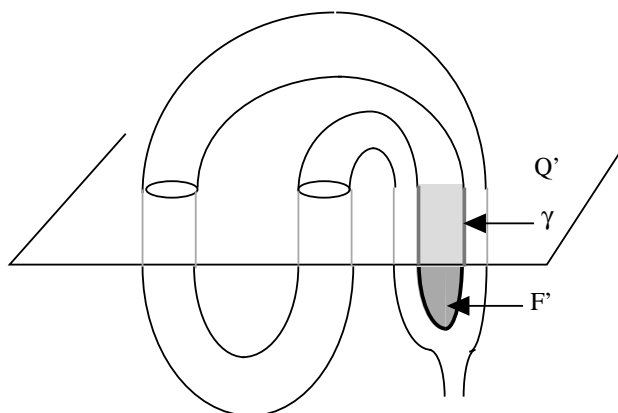
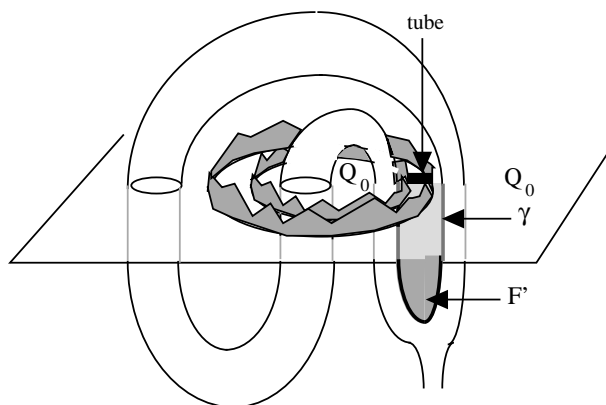

FIGURE 4. Splitting along a wave

new components of Q_0 . (The regular arc is one which intersects the curve α in a single point.) Let F' be the disk of parallelism, so $\partial F'$ is the union of γ and an arc in Q' that crosses the compressing disk exactly once. If there were a further compression of Q_0 possible, it would have to fall on the same side of Q_0 as F' . Then note that F' could be used to push the compressing disk off the tube. That is, the compression could have been done to Q , which is impossible. See Figure 5.

So the induction hypothesis applies to Q_0 . Since the first two possibilities of the lemma imply (the first case of) the third, we may as well take F to be a disk as in the third possibility. Note specifically that if $Q_0 \cap e_b = \emptyset$ then we can use item 1) to choose for F a disk that is disjoint from e_b . When comparing the curves $\alpha = F \cap H$ and $\gamma = F' \cap H$, we can arrange

FIGURE 5. Tubing the spheres Q_0 to get back Q

that $\alpha \cap \gamma = \emptyset$ by pushing any intersection points to the point where the tube is attached (to recover Q' from Q_0) and moving α across the attaching disks. Note also that at most one end of $\alpha \subset \partial F$ lies on the new meridians of Q_0 since these two meridians lie on different components of Q_0 . By general position (make the tube thin) the interior of F intersects Q' only in meridians of the attaching tube. Moreover, since F is disjoint from γ , all intersections of F with F' can be pushed via F' across the tube so that, in the end, the interior of F is entirely disjoint from Q' and from F' . Now use F' to ∂ -compress Q' to recover Q , leaving F as a disk satisfying the lemma for Q . \square

We recall the definition of width for a graph; for further details see [GST]. Let Γ be an eyeglass graph or theta graph in S^3 . As in [GST], choose a height function h from S^3 with two points removed to \mathbb{R} , and let $S(t) = h^{-1}(t)$. Assume that Γ is in Morse position with respect to h , that is, the critical points of Γ with respect to h occur at distinct values of t and these values are distinct from the values of h at the vertices of Γ . Further assume that a vertex v of Γ is either a Y-vertex (where exactly two edges of Γ lie above v) or a λ -vertex (where exactly two edges of Γ lie below v).

Definition 2.5. Let $t_0 < t_1 < \dots < t_n$ be the successive critical heights of Γ and suppose t_j and t_k are the two levels at which the vertices occur. Let $s_i, 1 \leq i \leq n$ be generic levels chosen so that $t_{i-1} < s_i < t_i$. Define the width of Γ with respect to h to be

$$W_h(\Gamma) = 2(\sum_{i \neq j, k} |S(s_i) \cap (\Gamma)|) + |S(s_j) \cap (\Gamma)| + |S(s_k) \cap (\Gamma)|$$

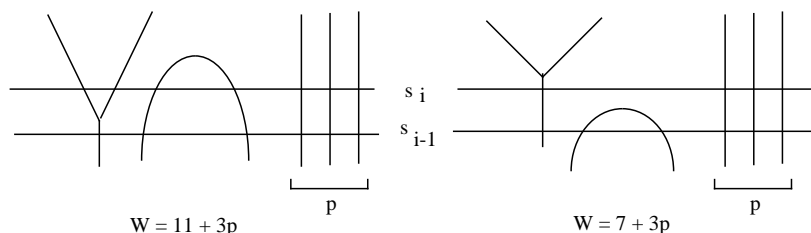

FIGURE 6. Reducing the width by 4 via Counting Rule 1 case 4

We say that Γ is in thin position with respect to h if has been isotoped to the generic position which minimizes W_h .

Example 2.6. If Γ is a knot, then this definition of width is simply twice the width as defined by Gabai.

Example 2.7. Suppose e_- is a knot in S^3 , in generic position with respect to h . Suppose P is a generic level sphere that intersects e_- in p points. Construct an eyeglass graph in S^3 by attaching to e_- the union of an edge e_b and a loop e_+ both lying in P . Then when Γ is made generic by tilting $e_b \cup e_+$,

$$W_h(\Gamma) = W_h(e_-) + 4p + 5.$$

Indeed, two vertices and a regular maximum (say) are added. Level spheres just below the vertices add p and $p + 1$ to the width. That just below the regular maximum adds $2p + 4$.

We will mostly be concerned with how the width changes under isotopies of Γ , but it will be important to identify precise rules. It is simple to check the following (see Figure 6 for a sample argument):

- Counting Rule 1.**
1. As a maximum (either a regular maximum or a λ -vertex) is pushed below (or above) another maximum, the width does not change.
 2. As a minimum (either a regular minimum or a Y -vertex) is pushed below (or above) another minimum, the width does not change.
 3. As a regular minimum is pushed above a regular maximum, the width decreases by 8.
 4. As a regular minimum is pushed above a λ vertex, or a regular maximum is pushed below a Y -vertex, the width decreases by 4.
 5. As a Y vertex is pushed above a λ vertex, or, equivalently, a λ vertex is pushed below a Y -vertex, the width decreases by 2.
 6. Suppose between level spheres P_{\pm} there are exactly two critical points, a regular minimum and a regular maximum on the same arc. Then

replacing that arc by a vertical arc reduces the width by $4|P_+ \cap \Gamma| + 4 = 4|P_- \cap \Gamma| + 4$.

Definition 2.8. *Two embeddings of a trivalent graph in S^3 , both generic with respect to a height function on S^3 , are width-equivalent if there is a generic isotopy from one embedding to the other so that the width is constant throughout the isotopy.*

It's obvious that any birth-death singularity during the isotopy will change the width, so the only non-generic embeddings during a width-equivalence isotopy will be ones at which two critical points are at the same level. Note that, from Counting Principle 1, the two critical points must both be maxima or both minima. In other words, if two embeddings are width-equivalent then there is an isotopy from one to the other that perhaps pushes maxima past maxima and minima past minima, but never maxima past minima.

Definition 2.9. *Suppose Γ' is a subgraph of a trivalent graph Γ and $i_1 : \Gamma \subset S^3$ is generic with respect to the height function $h : S^3 \rightarrow \mathbb{R}$. We say that Γ' is levellable if there is an embedding $i_2 : \Gamma' \rightarrow \mathbb{R}^3$ so that*

- $i_2(\Gamma')$ is level. That is, $hi_2(\Gamma') = t, t \in \mathbb{R}$
- i_1 is width-equivalent to an embedding obtained by perturbing i_2

For example, suppose $\Gamma \subset S^3$ is an eyeglass graph in generic position with respect to h , except that one cycle e_\pm in Γ is level, e. g. $h(e_+) = t$. There is a natural way to make Γ generic, namely tilt e_+ slightly so that it is vertical, i. e. so that e_+ has a single maximum (perhaps a λ vertex) and a single minimum (perhaps a Y -vertex) and one of these is the vertex of Γ lying in e_+ . The choice of whether the vertex is at the minimum or at the maximum of e_+ is determined by whether the end of the edge e_b lies below or above the vertex. The resulting generic embedding of Γ is one for which e_+ is levellable. In fact, using this convention, we can extend the notion of width so that it is defined when either or both of e_\pm are level. An easy application of Counting Rule 1 shows:

Counting Rule 2. *Suppose that e_+ is level and the end of e_b at e_+ lies below the vertex.*

1. *If e_+ is kept level while being moved below a regular maximum, the width increases by 4.*
2. *If e_+ is kept level while being moved below a λ vertex, the width increases by 2.*
3. *If e_+ is kept level while being moved above a regular minimum, the width increases by 8.*
4. *If e_+ is kept level while being moved above a Y vertex, the width increases by 4.*

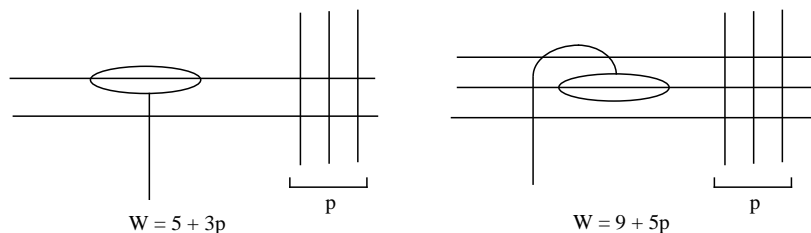

FIGURE 7. Increasing W by “wagging” the end of e_b

Of course the same rules apply when it is e_- that is level, and symmetric rules hold if the end of e_b at the vertex lies above the vertex. There is one final case:

Counting Rule 3. *Suppose that e_+ is level, with $h(e_+) = t$, and the end of e_b at e_+ lies below the vertex. Let $p = |S(t) \cap (e_- \cup e_b)|$. If the end of e_b at e_+ is moved above e_+ (introducing a new regular maximum in e_b) then the width is increased by $2p + 4$.*

Proof. See Figure 7 □

Lemma 2.10. *Let Γ be a Heegaard spine eyeglass graph in S^3 , in generic position with respect to the height function h . Suppose e_+ lies entirely above or entirely below e_- . Then Γ is planar (i.e. can be isotoped to lie in a level sphere).*

Proof. The edge e_b defines a Heegaard splitting of the reducible manifold $S^3 - \eta(e_+ \cup e_-) \cong (S^3 - \eta(e_+)) \# (S^3 - \eta(e_-))$. By Haken’s theorem there is some reducing sphere that intersects e_b in a single point; planarity of Γ (as well as the unknottedness of e_{\pm}) follows immediately. □

Lemma 2.11. *Let Γ be the eyeglass graph described in example 2.7 and suppose Γ is a Heegaard spine. Suppose there is a maximum of e_- below P and let Q be a level sphere just above the highest such maximum. Suppose $|Q \cap \Gamma| = |Q \cap e_-| = q$. Then the width of Γ can be reduced by at least $4q$. (The symmetric statement hold if there is a minimum above P .)*

Proof. The proof is by induction on q . Let Q' be the collection of spheres obtained by maximally compressing Q in the complement of H . Note that Q' intersects Γ only in e_- , so Proposition 2.4 case 1 applies. The disk F given by the proposition describes an isotopy that can be used to slide some part of an edge to Q' . Hence, by avoiding the disks in Q' that are the results of the compressions, the edge is brought down (or up) to Q . The isotopy possibly passes through Q on the way, but at the end β can be taken to lie just below (resp. above) Q . In particular, the arc moves down past a minimum

(or at least past $e_b \cup e_+$) or it moves up past a maximum. This decreases q by 2 and the width by at least 8. This would complete the inductive step unless the arc contains the maximum just below Q (which would disrupt the induction) then the arc contains at least two minima as well as that maximum. For the purposes of calculation of the resulting effect on width, we could imagine moving one of the contiguous minima up to just below the maximum (this will not thicken Γ) and then cancelling the minimum and maximum, thereby reducing the width by $4q + 4$, thereby accomplishing the required reduction. \square

For a similar but more delicate argument that will soon follow we will need to identify particularly important level spheres.

Definition 2.12. *Suppose $\Gamma \subset S^3$ is in generic position with respect to the height function h . A Y -vertex at the minimum (or a λ -vertex at the maximum) of a vertical cycle is called an exceptional critical point. A generic level sphere $h^-(t)$ is thin if the lowest critical point above it is a minimum and the highest critical point below it is a maximum. A thin level sphere is exceptional if one (or both) of these critical points lying above or below it is exceptional.*

Lemma 2.13. *Let Γ be a Heegaard spine eyeglass graph in S^3 , in generic position with respect to the height function h . Suppose e_+ is a vertical cycle with its minimum a Y -vertex v and suppose that no critical height of Γ occurs between the heights of its minimum and maximum. Suppose there is some minimum of Γ above e_+ and P is the sphere just below the lowest such minimum.*

Then either Γ is planar or the width of Γ can be reduced by at least $2|\Gamma \cap P|$.

The symmetric statement is true for vertical cycles whose maximum is a λ -vertex.

*Proof. **Special case:** e_- is disjoint from P .*

Following Lemma 2.10 we may assume that e_- does not lie entirely above P , so e_b intersects P in at least two points. The proof in this case is by induction on $|\Gamma \cap P|$, and directly mimics the proof of Lemma 2.11. Let P' be the collection of spheres obtained by maximally compressing P in the complement of H . Since P' intersects Γ only in e_b , Proposition 2.4 case 2 applies. The disk F given by the proposition describes an isotopy that can be used to slide some part of e_b to P' . Hence, by avoiding the disks in P' that are the results of the compressions, the edge is brought down (or up) to P . In particular, the arc moves down past a minimum or it moves up past a maximum. This decreases $|\Gamma \cap P|$ by 2 and the width by at least 4. This completes the inductive step unless the arc contains the minimum just above

P (which would disrupt the induction). But in this case the arc contains at least two maxima as well as that minimum. For the purposes of calculation of the resulting effect on width, we could imagine moving one of the contiguous maxima down to just above the minimum (this will not thicken Γ) and then cancelling the minimum and maximum, thereby reducing the width by $4|\Gamma \cap P| + 4$, via Counting Rule 1 case 6, thereby accomplishing more than the required reduction, in this case.

So henceforth we assume that e_- intersects P . The structure of the argument will again mimic the proof of Lemma 2.11, though the details are a bit more complicated. Let Q_1, \dots, Q_n , numbered from bottom to top, be the non-exceptional thin spheres for Γ . That is, just above each Q_i is a minimum that is not the Y -vertex minimum of a vertical cycle, and just below each Q_i is a maximum that is not the λ -vertex maximum of a vertical cycle. So in particular P is among these spheres. Let $Q = Q_1 \cup \dots \cup Q_n$. The proof will be by induction on $\Gamma \cap Q$. Explicitly, we will show that given any counterexample, one can find a counterexample with fewer such intersection points.

Let Q' be the collection of spheres obtained by maximally compressing Q in the complement of H . Note that Q' is disjoint from e_+ . Let F be the disk given by Proposition 2.4. There are two cases to consider:

Case 1: α is a regular arc on ∂H , disjoint from some meridian of e_b .

Then F describes an isotopy that can be used to slide some part e_0 of an edge to Q' . As usual, we can view this as bringing e_0 down (or up) to Q so, at the end of the move, e_0 can be taken to lie just above (resp. below) the Q_i to which e_0 was adjacent. In particular, the e_0 moves down past a minimum or up past a maximum. If $\alpha = \partial F \cap \Gamma$ does not go through a vertex (so $\alpha = e_0$), this reduces the width by at least 4 (8 if the critical point it passes is not a vertex) and it reduces $\Gamma \cap Q_i$ by 2. If α does pass through a vertex (so $e_0 \subset \alpha$) the width drops by at least 2 and $\Gamma \cap Q_i$ by 1. Note that α lies between Q_i and one of $Q_{i\pm 1}$ so, unless $P = Q_i$ or Q_{i-1} , the move can have no effect on whether P remains as described, or on $\Gamma \cap P$. So unless $P = Q_i$ or Q_{i-1} we are done, by induction. In fact, even if $P = Q_i$ or Q_{i-1} the result of the move gives a counterexample with $Q \cap \Gamma$ reduced, so long as P remains as described. That is, so long as a minimum remains just above P .

So suppose the slide or isotopy of e_0 to $\beta \subset Q_i$ removes the last minimum above P and suppose first that $P = Q_{i-1}$. The effect is to remove Q_{i-1} from Q so the old Q_i now serves as P . We compute. Let p be the number of maxima between Q_{i-1} and Q_i before the move (counting any λ vertex as $1/2$ a maximum) and let r be the number of minima (counting any Y vertex as $1/2$ a minimum). Then $|Q_{i-1} \cap \Gamma| - |Q_i \cap \Gamma| = 2p - 2r$. We need to show that the move just described thins Γ by at least twice that much, plus 4 if α doesn't pass through a vertex (so $\Gamma \cap Q_i$ is reduced by two further

points) or plus 2 if α does pass through a vertex. The computation is most obvious if α is a single minimum with both ends on Q_i , so $r = 1$ or $1/2$. Then since this minimum passes p maxima the width is reduced by at least $4p$ if the minimum is regular (even if the only maximum it passes is a λ -vertex) and also $4p$ if the minimum is a Y -vertex, since we know that then all vertices are accounted for and the maxima are regular. In any case, we have $4p \geq 2(2p - 2) + 4$, completing the computation in this case.

When α is more complicated, containing several minima, the only difference is an even greater thinning: for computational purposes one can imagine first moving a regular minimum in e_0 above all but its contiguous maxima, then cancelling the minimum with one of those contiguous maxima. By Counting Rule 1 case 6, this already thins Γ sufficiently; the actual isotopy would thin it even further.

The computation when $P = Q_i$ is similar. In this case, if the last minimum above P is removed, Q_{i+1} becomes the new P and we need to show that the width is reduced by at least $2(|Q_i \cap \Gamma| - |Q_{i+1} \cap \Gamma|)$. (We do not need to add 4 or 2, since the move leaves $\Gamma \cap Q_{i+1}$ unchanged.) If Q_i was the highest non-exceptional thin sphere then, for these computational purposes, substitute a sphere above Γ for Q_{i+1} . Again let p and r be the number of maxima and minima in the relevant region, that is, between Q_i and Q_{i+1} (again, a λ vertex or Y vertex counts as only half a maximum or minimum respectively.) Since the last minimum above P is being eliminated by pulling α down to P , a minimum of α has two contiguous maxima, which we may as well take to be the highest two maxima between the spheres. Then, for computational purposes, we can imagine eliminating that minimum first, dragging it past all but the two contiguous maxima, and then cancelling it with one of the contiguous maxima. The result is to thin by at least $4p$ (in fact $8p$ if all relevant critical points are regular) and this more than suffices.

Case 2: α passes exactly once through a meridian of e_+ and has its ends at the same point of $e_b \cap Q_i$.

Then $P = Q_i$ or Q_{i+1} . Suppose first that $P = Q_i$. Then F can be used to isotope the cycle e_+ so that it lies in Q_i , but now with the end of e_b incident to it lying above Q_i . When genericity is restored, e_+ is still vertical, but with its maximum now a λ -vertex. The simplest case to compute is when α runs through a single minimum of e_b , a minimum that lies just below v . Then the move described eliminates that regular minimum, so one less term appears in the calculation of width. This is the reverse of the operation described in Counting Rule 3, so the width is decreased by $2|Q_i \cap \Gamma| + 4 = 2|P \cap \Gamma| + 4$, immediately confirming the lemma. If the end of e_b near e_+ is more complicated, the thinning is even greater.

Finally suppose that $P = Q_{i+1}$. In this case the isotopy given by F pulls e_+ down to Q_i . Again consider the simplest case: the end segment of e_b

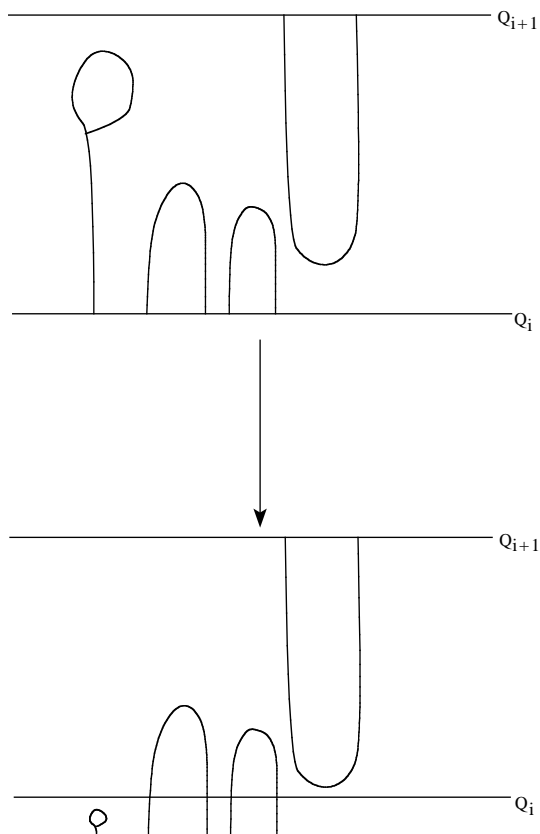

FIGURE 8.

eliminated by the move is a simple vertical arc between Q_i and e_+ . Then F pulls e_+ past p maxima and r minima, changing the width by $4p - 8r$, essentially by Counting Rule 2. (Again a λ vertex and Y vertex count as only half a maximum or minimum respectively.) On the other hand, $|Q_i \cap \Gamma|$ differs from $|Q_{i+1} \cap \Gamma|$ by $2p - 2r$ and $4p - 8r < 2(2p - 2r)$. So, after the move, we have an even more extreme counterexample, and one with fewer points of intersection with Q . Furthermore, if e_b is in fact more complicated than a simple vertical arc, then even more thinning would have been done. Now apply the inductive hypothesis and the contradiction completes the proof. \square

3. MAIN THEOREMS

Theorem 3.1. *Let Γ be a tri-valent graph that is a genus two Heegaard spine in S^3 . If Γ is in thin position then it is in extended bridge position.*

Proof. Suppose Γ is not in extended bridge position. As previously, let Q_1, \dots, Q_n , numbered from bottom to top, be the non-exceptional thin spheres and let $H = \eta(\Gamma)$.

Suppose some Q_i intersects H only in non-separating meridians. Then the argument is much as in the Special Case of Lemma 2.13: Let Q' be the collection of spheres obtained by maximally compressing Q_i in the complement of H . By Proposition 2.4 each component of Q' is parallel to a component of $\partial H - Q'$. So in particular, there is a disk $F \subset S^3$ whose interior is disjoint from $H \cup Q'$ and $\partial F = \alpha \cup \beta$, where $\alpha \subset \partial H$, $\beta \subset Q'$ and α is a regular path on ∂H (not intersecting some meridian of e_b , if Γ is an eyeglass). Since α is disjoint from $\partial Q' = \partial Q_i$, α lies entirely above or below, say above, the level of Q_i . Then F describes an isotopy that can be used to slide some part e_0 of an edge down to Q_i . The isotopy possibly passes through Q_i on the way, but at the end e_0 can be taken to lie just above Q_i . In particular, e_0 either lies below the minimum just above Q_i or the arc containing that minimum has been changed to one with a single maximum just above Q_i . In any case, the graph is thinned, a contradiction.

So assume every Q_i intersects H in some separating meridians, that is, Γ is an eyeglass graph and for each i , $Q_i \cap e_b \neq \emptyset$.

If any Q_i is disjoint from both of e_{\pm} , we use the same argument as in the Special Case of Lemma 2.13, with Q_i playing the role of Q .

So assume every Q_i intersects either e_+ or e_- as well as e_b . If each e_{\pm} intersects some Q_i , we use the same argument as above, via Proposition 2.4 case 3. We are left with the case that e_+ , say, is disjoint from all Q_i , whereas e_- intersects every Q_i . So suppose e_+ lies between Q_i and Q_{i+1} and, for concreteness and with no loss of generality (by symmetry) assume that the point q of $Q \cap e_b$ that is closest to e_+ lies in Q_i , some $1 \leq i \leq n$. (Here if $i = n$, Q_{i+1} is taken to be a level sphere above Γ .)

Claim: e_+ is a vertical cycle lying above some maximum of Γ that lies between Q_i and Q_{i+1} . The minimum of e_+ is a Y -vertex.

Proof of claim Let Q' , as before, be the collection of spheres obtained by maximally compressing Q_i in the complement of H . As we have argued, Proposition 2.4 shows that there is a disk F for Q' as given in item 3b of that Proposition. That is, ∂F consists of an arc β on Q_i with both ends at q and an arc α on $\partial H - Q$ parallel to a cycle with both ends at q and running once around e_+ . F can be used to pull the component of $\Gamma - Q_i$ that contains e_+ down to Q_i . For computational purposes we can picture this done in three stages: e_+ is replaced by a vertical cycle with its minimum

(resp. maximum) at the minimum (resp. maximum) of e_+ ; the end of e_b between Q_i and e_+ is replaced by a vertical arc terminating at the minimum of e_+ ; and then e_+ and the end of e_b are pulled down to Q_i . The first two steps cannot make Γ thicker and will make it thinner unless in fact it leaves the height function on Γ unchanged. The third move will not thicken Γ if the original e_+ has a minimum below all the maxima (e. g. there is a regular minimum of e_+) and in fact must thin Γ unless e_+ lies above some maximum. So, since Γ cannot be thinned, e_+ must be a cycle containing no regular minima and lying entirely above some maximum. This proves the claim.

Having established the claim, Lemma 2.13 applied to $P = Q_{i+1}$ implies that $i = n$ so $\Gamma \cap P = \emptyset$. But even then, the *argument* of Lemma 2.13 still suffices to display the same contradiction: The effect of pulling e_+ to Q_i is to alter the width by adding at most $4p - 8r$. On the other hand, after the move, Q_i is then suitable (when pushed just above e_+) for applying Lemma 2.13. (See Figure 8.) This lemma says that Γ can be thinned by $2|Q_i \cap \Gamma| = 4p - 4r > 4p - 8r$. \square

Definition 3.2. *Suppose Γ is in bridge position. Then a level sphere separating the minima from the maxima is called a dividing sphere for Γ .*

If Γ is not in bridge position, but is in extended bridge position, then a dividing sphere is a level sphere P for which every minimum above P is the Y -vertex of a vertical cycle and every maximum below P is the λ -vertex of a vertical cycle.

Theorem 3.3. *Let Γ be a tri-valent graph that is a genus two Heegaard spine in S^3 . If Γ is in thin position then it is in extended bridge position. Either Γ is planar or some dividing sphere is disjoint from a simple (i. e. non-loop) edge of Γ .*

Proof. Following Theorem 3.1 we can assume that Γ is in extended bridge position. If Γ is in (non-extended) bridge position, the proof (and Corollary 3.4) will conclude much as in Theorems [GST, 5.3, 5.14]. We note that were we content to find *either* a level edge *or* an unknotted cycle in Γ , we would be done following this case. However the pursuit of a simple edge requires more persistence. Since the delicate points in the argument will need to be repeated in the case of extended bridge position we only summarize the proof when Γ is in bridge position:

There is a dividing sphere Q between the lowest maximum and the highest minimum that cuts off both an upper disk and a lower disk. If an edge running between distinct vertices lies above or below Q we are done. So we can assume that each component of $\Gamma - Q$ is either an arc or a 3-prong.

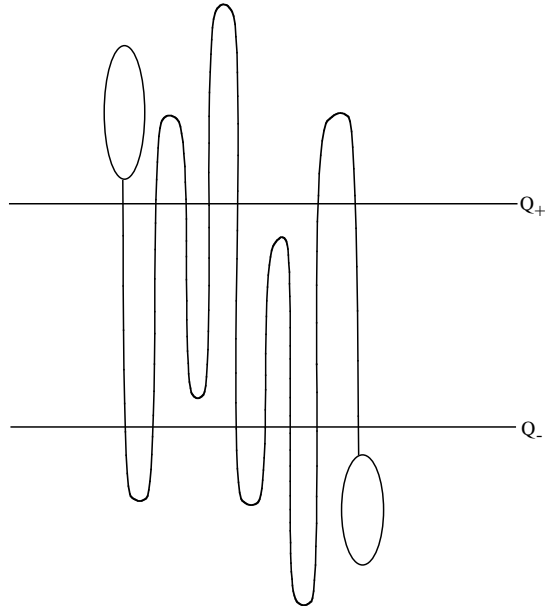

FIGURE 9.

(This fact makes some of the complications in the proof of [GST, 5.3] irrelevant.) There is an argument to show that we can find such upper and lower disks so that their interiors are disjoint from Q and that neither intersects Q in a loop. Each is incident to exactly two points of $\Gamma \cap Q$ and it is shown that at least one point, and perhaps both, are the same for both upper and lower disks.

If both upper and lower disks are incident to the same pair of points, then these disks can be used to make a cycle (either a loop or a 2-cycle) level. The argument of [GST, 5.14] shows that if the cycle is a loop then either Γ could be thinned (a contradiction to hypothesis) or e_b is already disjoint from the dividing sphere and we are done. Essentially the same argument applies in the case of a level 2-cycle, unless the third edge too can be moved into the sphere. In the latter case, the graph is planar.

If the upper and lower disks are incident to only one point of $\Gamma \cap Q$ in common, then they may be used either to thin Γ or to make that edge level, lying in Q . In this case, too, Γ may be thinned, or another edge brought to Q (creating a level 2-cycle) this time by using an outermost disk of a meridian E for $S^3 - H$, cut off of E by $Q - H$. For details see [GST, 6.1, Subcases 3a, 3b].

So now assume that Γ is not in bridge position, but only in extended bridge position. In particular, all thin spheres are exceptional and there is at least one exceptional thin sphere.

Claim 1: There is exactly one exceptional thin sphere and it intersects exactly one of the loops e_{\pm} .

Proof of Claim 1: Since there are at most two vertical cycles, there are at most two exceptional thin spheres. If there are two, denote them by Q_{\pm} , with Q_+ lying above Q_- (Figure 9). Consider the lowest minimum above Q_+ and the highest maximum below Q_- . It can't be that neither of these critical point is exceptional, for then Γ would not be in extended bridge position. If both critical points are exceptional, then Γ is planar by Lemma 2.10. So we may as well assume that both exceptional vertices are exceptional minima, one just above Q_- and one just above Q_+ . But then Q_- intersects Γ only in e_b , contradicting thin position, via Proposition 2.4 case 2.

Having established that there is exactly one exceptional thin sphere, the same argument shows that it cannot be disjoint from both e_{\pm} .

With no loss of generality, suppose e_+ but not e_- is disjoint from the exceptional thin sphere Q .

Claim 2: The loop e_+ can be isotoped to lie in Q , without increasing the width of Γ .

Proof of Claim 2: Maximally compress the exceptional level sphere Q in the complement of H and call the result Q' . Apply Lemma 2.4 to deduce that there is a disk F as in item 3. Since it cannot describe a way to slide an edge segment of $\Gamma - Q$ to the level of Q (that would make Γ thinner), $\partial(F)$ must be disjoint from e_- and run around e_+ . F can then be used to isotop e_+ , as required. Since the vertex of the loop is immediately adjacent to Q , this does not thicken Γ .

Following the isotopy of Claim 2, e_+ divides Q into two disks, Q_1 and Q_2 . Consider the intersection of these Q_i with a meridian disk E of $S^3 - H$. Note that there can be no closed components of intersection, since an innermost one, if essential in $Q_i - \Gamma$, could be used to push part of Γ through Q_i , thinning Γ . (It is thinned, per Counting Rule 2, because an upper cap would contain no minima, and a lower cap would contain more minima than maxima). Similarly, an outermost arc of $E - Q_i$ can't cut off a disk lying entirely above Q , for it could be used to thin and, indeed, unless Q and e_b are disjoint, so could a lower one, essentially by Counting Rule 3 applied in reverse.

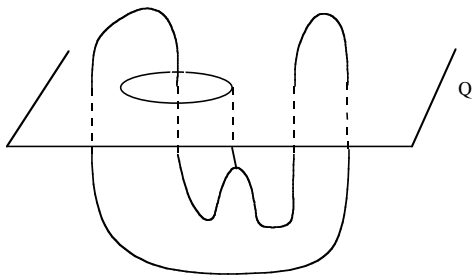

FIGURE 10.

So we may as well assume that $e_b \cap Q = \emptyset$. We know that a maximum lies just below Q . One possibility is that there is a regular maximum below Q . Another is that the only maximum below Q is a λ -vertex (Figure 10).

In the second case, if the end of e_b is incident to the λ -vertex from above, then e_b is monotonic (for otherwise an internal maximum would lie below Q or e_b would intersect Q , both possibilities we are not considering). Then e_b is disjoint from the level sphere (a dividing sphere) just below the λ -vertex, and we are done. So either there is a regular maximum below Q or the λ -vertex below Q has the end of e_b incident to the vertex from below. In particular, a level sphere just below either sort of maximum would cut off an upper disk. So, as is now standard, some dividing sphere P can be placed so that it simultaneously cuts off both an upper disk D_u and a lower disk D_l . As noted above, we can assume that neither disk has a closed curve of intersection with Q . We now proceed to duplicate, in this context, the proof of [GST, 5.3]. The added difficulties here are apparent even at the first step. We will consider the intersections of the interiors of D_u and D_l with P .

Claim 3: (cf. [GST, Claim 5.5]) There cannot be both an upper cap and a lower cap whose boundaries are disjoint.

Proof of Claim 3: Let C_u and C_l denote the caps. They bound disjoint disks P_u and P_l in P . If the end segment of e_b at e_+ is not incident to P_u the proof is natural: pushing C_u down to P_u and C_l up to P_l will thin Γ . So assume that e_+ does lie between C_u and P_u . If any maximum is incident to P_u and is lower than the height of Q (i. e. the height of e_+) then Γ could be thinned by just pushing that maximum down while pushing C_l up. So any maximum lying between C_u and P_u is higher than e_+ . On the other hand, if any maximum *not* between C_u and P_u were above e_+ it could be pushed lower (since its easy to make the descending disk from that maximum disjoint from C_u . This too would thin Γ . Hence we see that

the $p \geq 0$ maxima that are lower than e_+ are precisely those that don't lie between C_u and P_u .

Now consider the effect of pushing C_u down to P_u while simultaneously pushing C_l up to P_l . Apply Counting Rule 2: Pushing e_+ past p maxima increases the width by $4p$ whereas pushing up the $r \geq 1$ minima between C_l and P_l reduces the width by $8r$. (Here, as was usual in such counting above, a λ -vertex or Y vertex counts as only half a maximum or minimum). The result is that, after the push, the width is increased by at most $4p - 8r$. On the other hand, after the push, P would satisfy the hypotheses of Lemma 2.13. It's easy to calculate $P \cap \Gamma$: it's $2p - 2r$. Then according to that lemma, Γ could be thinned by a further $4p - 4r > 4p - 8r$, a contradiction establishing the claim.

Claim 4: (cf. [GST, Claim 5.6]) If there is an upper disk and a disjoint lower cap, then we can find such a pair for which the interior of the upper disk is disjoint from P . (The symmetric statement is of course also true.)

Proof of Claim 4: Let B_u and B_l denote the balls above and below the dividing sphere P respectively. The proof would follow just as in [GST] if we could find a complete collection Δ of descending disks for $\Gamma \cap B_u$ such that the boundaries of Δ and D_u intersect only on P . We do not need to worry here, as we did there, about components of $\Gamma \cap B_u$ that contain two vertices for if such a component exists the lemma is proven. What we do need to worry about is that any maxima that are higher than the loop e_+ have no descending disks at all (or rather, their descending disks encounter e_+ at Q and do not descend to P , else we could thin Γ .) But because we have established above that D_u is disjoint from Q there is an easy fix. The graph Γ intersects the region $S_P^Q \cong S^2 \times I$ between Q and P in a collection of maxima and a collection of vertical arcs. At the top of one vertical arc ε_b (an end of e_b) we see the bottom half of the loop e_+ . Let T be the union of two trees in $Q - e_+$, each having a root at the vertex in e_+ , each on opposite sides of e_+ and together containing all the other points of $\Gamma \cap Q$. (These points are just the tops of the vertical arcs of $\Gamma \cap S_P^Q$.) Denote the edges of T by E_T . Finally, let $C \subset S_P^Q$ be the vertical cylinder $e_+ \times I$, intersecting Γ exactly in $\varepsilon_b \cup e_+$. Define Δ to be this collection of disks: $\{E_T\} \times I$, $C - \eta(\varepsilon_b)$, and a set of descending disks for all maxima in S_P^Q , these chosen to be disjoint from the other disks in Δ . Clearly Δ cuts S_P^Q up into a collection of balls. See Figure 11.

Now observe that D_u cannot involve the maxima that are higher than Q , else Γ could be thinned. Hence the part of the boundary of D_u that lies on Γ either lies on a maximum in S_P^Q or on the component containing e_+ . In

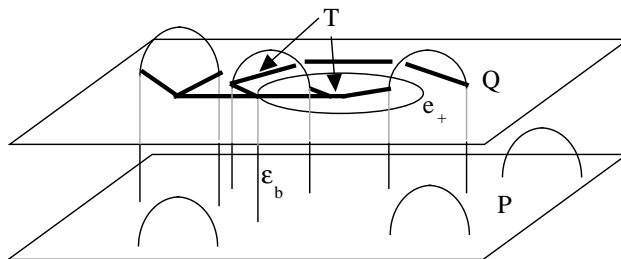

FIGURE 11.

either case it is easily made disjoint from $\partial\Delta$ so that $\partial D_u \cap \partial\Delta$ lies entirely in P . The proof now follows as in [GST, Claim 5.6].

With one exception, the proof of Theorem 3.3 is now little different from the flow of the proof of [GST, Theorem 5.3]: ultimately we get upper and lower disks which can be used to push part of $\Gamma \cap B_l$ up while pushing part of $\Gamma \cap B_u$ down. Unless the latter is the component containing e_+ , this immediately thins Γ . So suppose D_u does push down e_+ ; let p denote the point in e_b where that component is cut off. Unless D_l pushes up a segment incident to p , the proof follows by a width count and Lemma 2.13 just as in the proof of Claim 3. If the segment incident to p that D_l pushes up is a simple minimum (i. e. it does not contain the other end of e_b) then that push eliminates a critical point which we may take to lie just below P . In particular, for P_+ a level sphere just above P , the move reduces the width by $2|\Gamma \cap P_+| + 4$ via Counting Rule 2, and this is enough again to ensure that after the move the graph is thinner.

Finally, suppose that D_l is incident to p and pushes up the other end of e_b . (This implies in particular that $e_b \cap P = \{p\}$.) Then after the move both the edges $e_b \cup e_+$ are level and lie in P . But, as usual, the move may thicken Γ and this time there is no immediate cancellation of a critical point since e_b was monotonic before the move, just as it would be again when genericity is restored. The thickening occurs, as usual, because the Y -vertex minimum of e_+ may be pulled down past m maxima, in which case the width increases by $4m$. But, unless $m = 0$, this leads to a contradiction: Consider the cylinder C that is swept out by e_+ as it is pulled down to P (effectively, this is just another way of viewing the upper disk D_u) and apply the technical Lemma 4.1 that follows. The resulting graph could in fact be thinned by a further $4m + 4$, leaving it thinner than we started. So we conclude that $m = 0$ and the move can be made without any thickening at all.

Once $e_b \cup e_+$ is level, tilt it slightly, creating two Y -vertices, say, one at each end of e_b , so e_+ is vertical with its maximum a regular maximum.

FIGURE 12. Tilting $e_b \cup e_+$ 

FIGURE 13. Levellable edge or subgraph

Then a level sphere passing through the middle of e_+ is a dividing sphere that is disjoint from e_b , as required. See Figure 12. \square

Corollary 3.4. *Let Γ be a tri-valent graph that is a Heegaard spine in S^3 and suppose that Γ is in thin position. Then at least one simple edge is levellable (cf Definition 2.9). To be specific, either Γ is planar or (see Figure 13):*

1. *If Γ is in bridge position then there is a simple edge $e \subset \Gamma$ so that*
 - *the knot or link $K = \Gamma - \text{interior}(e)$ is in bridge position and*
 - *e is levellable and its ends lie at distinct maxima or at distinct minima of K*
2. *If Γ is not in bridge position then Γ is an eyeglass graph. For some loop (say e_-) in Γ*
 - *e_- is in bridge position and*
 - *the subgraph $e_b \cup e_+$ is levellable and is incident to either a maximum or minimum of e_- .*

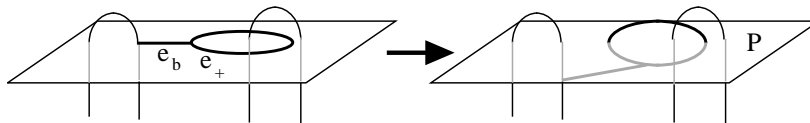
Proof. We assume Γ is not planar and first suppose Γ is in bridge position. Let P be a dividing sphere disjoint from a non-loop edge e of Γ guaranteed by Theorem 3.3. With no loss of generality the edge e lies above P . Let Γ_u denote the part of Γ lying above P . Since there are no minima above P , a family of descending disks for Γ_u describes a parallelism between Γ_u and a subgraph of P . In particular, e can be viewed as a perturbed level edge.

Suppose next that Γ is not in bridge position. We know from Theorem 3.1 that Γ is extended bridge position so in particular Γ is an eyeglass graph. Let P be a dividing sphere disjoint from the edge e_b , as guaranteed by Theorem 3.3. We may as well assume e_b lies above P , so one end of e_b descends from the minimum of a vertical loop, say e_+ . Since e_b is disjoint from the dividing sphere P it contains no minimum and its other end ascends from a

λ -vertex, hence from a maximum of e_- . Raise that maximum along e_b until it is the critical point just below the Y -vertex. Let Q be a level plane that intersects the monotonic edge e_b in a single point. Maximally compress Q in the complement of Γ and let the result be Q' . As has been argued repeatedly above, if we apply Proposition 2.4 to Q' the only conclusion that does not violate thinness is possibility 3.b. In that case, the disk F describes how to isotope $e_b \cup e_+$ to lie in P . Since there are no critical points between the heights of the ends of e_b this has no effect on width. \square

4. TECHNICAL LEMMA

For the following technical lemma we return to the context of Example 2.7 and Lemma 2.11. That is, e_- is generic with respect to a height function on S^3 and the subgraph $e_b \cup e_+$ is level with respect to the height function, at a height that is generic for e_- . Width is calculated by tilting $e_b \cup e_+$ slightly to restore genericity. This is independent of the direction of tilting.

Lemma 4.1. *Suppose Γ is a non-planar eyeglass graph that is a Heegaard spine of S^3 . Suppose there is a height function on S^3 and a dividing sphere P for e_- that contains both the edges e_b and e_+ . Suppose Q is a level sphere above P and there is a properly embedded annulus C such that*

1. C spans the region $S_P^Q \cong S^2 \times I$ that lies between Q and P
2. $\partial C \cap P = e_+$ and
3. $C \cap \Gamma = e_+$.

Let $m > 0$ be the number of maxima of e_- in S_P^Q . Then Γ can be isotoped so that $e_b \cup e_+$ is again level, but the width of Γ has been reduced by at least $4m + 4$.

Proof. The cycle e_+ divides P into two disks $P_1 \cup P_2$. Without loss of generality, assume that e_b lies in P_2 . Let $S_{P_i}^Q, i = 1, 2$ denote the component of S_P^Q lying above P_i .

Case 1: Some maximum (resp. minimum) of e_- can be pushed down (resp. up) past P .

Note that a plane just above or below P intersects e_- in at least $2m$ points. If the maximum that is pushed down is not the maximum contiguous to the end of e_b then the move instantly reduces the width of Γ by 8, per 2.7. More importantly, after the move Γ is in a position to apply Lemma 2.11, and so we can reduce the width by at least a further $4(2m - 2)$. Thus the total width is reduced by at least $8m \geq 4m + 4$.

If the maximum that is pushed down is contiguous to the end of e_b , the effect on width is to first push a regular maximum down past a Y -vertex (on e_+) and then to convert the regular maximum and the Y -vertex on e_- into a

single λ vertex on e_- . The first move reduces the width by 4 and the second move (eliminating a critical point) reduces it by at least a further $4m + 2$.

Case 2: Some maximum of e_- lies in $S_{P,1}^Q$.

The descending disk of any maximum in this region can't intersect the end $C \cap Q$, since that end is too high. Hence the intersection of such a descending disk with C consists entirely of components that are inessential in C . It follows that a disk in $S_{P,1}^Q$ can be found that isotopes a maximum of e_- in $S_{P,1}^Q$ down to a level below P , returning us to Case 1.

Let H be a regular neighborhood of Γ and continue to call P_i the disks obtained by removing the boundary collars given by $H \cap P_i$. Then each P_i is a disk punctured by meridians of H associated with points on e_- . Since P was a dividing sphere for e_- , there are an odd number p of such meridians (the point of e_- at the end of e_b does not, of course, give rise to such a meridian). P divides ∂H into $p + 1$ components; $p - 1$ of them are annuli A_1, \dots, A_{p-1} lying between meridian disks associated to points in $e_- \cap P$. Two components, U_\pm are pairs of pants, with boundary of each consisting of $\partial P_1, \partial P_2$ and the boundary of a meridian associated to a point of $e_- \cap P$. Choose notation so that U_+ lies above P , the meridian curves in ∂H associated to points of $e_- \cap P$ occur in order μ_1, \dots, μ_p along e_- , with $\mu_1 \subset \partial U_+$ and $\mu_p \subset \partial U_-$ and, finally, $\partial A_i = \mu_i \cup \mu_{i+1}$.

Not surprisingly, we consider how a meridian disk E of $S^3 - H$ intersects P . It will eventually be useful to have chosen E , among all possible meridian disks, to minimize $|E \cap P|$. Of course if E is disjoint from P then its boundary can't be a meridian curve of e_- (every sphere in S^3 separates) so it must be parallel to ∂P_1 . But then it's easy to see that Γ is in fact planar, contradicting hypothesis. If there are any closed components of $E \cap (P_1 \cup P_2)$ then an innermost one on E can be used to push a maximum below P or a minimum above P . Then we are in Case 1 and the argument is complete. A similar argument applies if an outermost disk E_0 cut off from E by P_i is incident to one of the A_i . We conclude that $E \cap P$ consists entirely of arcs and, furthermore, each outermost disk is incident only to one of U_\pm . Let E_0 be any such outermost disk, with boundary the union of two arcs $\alpha \subset \partial \eta(H) \cap E$ and $\beta \subset P \cap E$ in E . Consider the possibilities for α .

Case 3: One or both ends of α is incident to ∂P_2 .

The other end of α can't be incident to ∂P_1 , for the arc $\beta = E_0 \cap P$ lies either in P_1 or P_2 . If the other end is incident to μ_1 then it can be used to pull the maximum of e_- contiguous to the end of e_b down below P , again placing us in Case 1. Similarly if the other end of α is incident to μ_p . In fact,

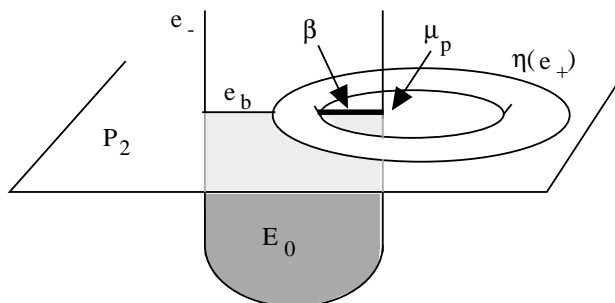

FIGURE 14. Case 4

if both ends of α lie on ∂P_2 we can accomplish the same thing, essentially using E_0 much like a cap.

Case 4: Exactly one end of α is incident to ∂P_1 .

Again, the other end of α can't be incident to ∂P_2 . Suppose it is incident to μ_p . Then, since an arc in a pair of pants is determined up to proper isotopy by its end points, the arc α runs once along the length of e_b , then over the minimum of e_- that is adjacent to the end of e_b and ends in $\mu_p \subset P_1$. The disk E_0 can be used to slide e_b , keeping the end at e_+ fixed, until e_b becomes the arc $\beta \subset P_1$. See Figure 14. Afterwards, the width is unaffected, but all m maxima now lie in the component $S_{P_2}^Q$ that no longer contains e_b . In effect, we are in Case 2 and so we are finished once again. The same argument applies if the other end of α is at μ_1 : Since the interior of E_0 is disjoint from Γ the slide of e_b to β has no effect on the maxima in $S_{P_2}^Q$, or on the cylinder C . (The edge e_b just passes through C).

Case 5: Both ends of α are incident to ∂P_1 .

Suppose, to be concrete, that E_0 lies above P , so it forms a kind of cap or shroud over the part e_0 of e_- that lies between e_b and μ_1 . Let A denote the annulus half of $\partial\eta(e_b \cup e_+)$ that lies above P and let P_u denote the plane $P_1 \cup A \cup P_2$. Then $\partial E_0 \subset P_u$ consists of two arcs, $\alpha \subset A$ and $\beta \subset P_1$. A descending disk for the maximum e_0 also has boundary consisting of two arcs, one being e_0 itself and the other an arc in P_u . A standard innermost disk, outermost arc argument shows that such a disk D can be found disjoint from E_0 , so ∂D lies in the disk in P_u bounded by ∂E_0 . In fact, E_0 can be used to remove (by piping to E_0 and then over it) any arc of $\partial D \cap A$ which is parallel to α in the punctured annulus $A - e_0$. The upshot is that, if we choose D so that the arc $\delta = \partial D \cap P_u$ intersects A in a minimal number of

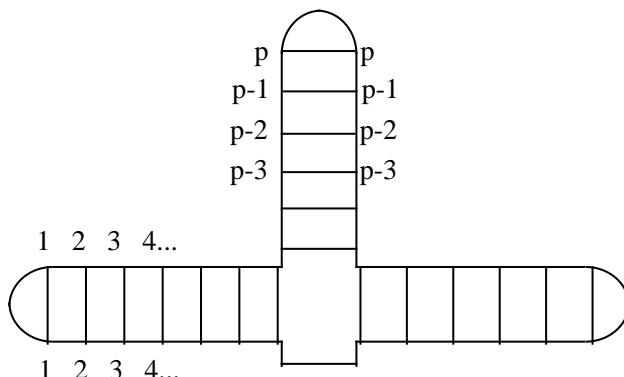

FIGURE 15.

components, then in fact δ consists of a single arc in A (running from the end of e_0 to ∂P_1) and a single arc in P_1 . Once this is accomplished, the disk D can be used instead of E_0 in the proof of Case 4, completing the argument in this case.

Case 6: The general case.

Following cases 3 to 6, the only remaining case to consider is one in which *every* outermost arc cut off by $P_1 \cup P_2$ has both ends incident to μ_1 (when the disk it cuts off lies above P) or both ends incident to μ_p (when the disk it cuts off lies below P). Notice that, in either case, the outermost arc forms a loop in P with both ends either at μ_1 or at μ_p .

Claim: For any $\mu_i, 1 \leq i \leq p$, there is an arc of $E \cap P$ forming a loop at μ_i .

The proof of the claim is a particularly easy application of outermost forks. Cf [Sc] for details beyond this sketch: Label the ends of arcs of $P \cap E$ in ∂E that lie on the meridians μ_1, \dots, μ_p by the number of the corresponding meridian. We have just demonstrated that each outermost arc has either both ends labelled 1 or both ends labelled p . To the collection of arcs $E \cap P$ there is naturally associated a tree in E , with a vertex in each component of $E - P$ and an edge connecting any vertices corresponding to adjacent components. Consider an outermost fork of this tree. Two adjacent tines of this fork have ends labelled $(1, 1)$ or (p, p) . In order to get from one labelling to the other, the arc of ∂E that lies between the ends of the two adjacent tines must go sequentially through every label from 1 to p (perhaps more than once). Since each arc of $E \cap P$ it passes by is parallel to an outermost arc, its labels must be the same. The result is a collection of arcs containing all labels $1, \dots, p$ and having the same label at each end. (See Figure 15). These arcs, when considered in P , form loops at every meridian μ_p .

Having established the claim, consider this consequence: An innermost such loop contains no meridian in its interior. This means that an innermost loop can be used to ∂ -compress E to ∂H , dividing E into two disks, at least one of which is still a meridian disk and each of which intersects P in fewer arcs. Since E was initially chosen to minimize $E \cap P$, this is impossible. \square

REFERENCES

- [GST] H. Goda, M. Scharlemann and A. Thompson, *Levelling an unknotting tunnel*, Geometry and Topology **4** (2000) 243–275.
- [GR] C. Gordon and A. Reid, *Tangle decompositions of tunnel number one knots and links*, J. Knot Rami. **4** (1995) 389–409.
- [Mo] K. Morimoto, *Planar surfaces in a handlebody and a theorem of Gordon-Reid*, Proc. Knots '96, ed.S.Suzuki, World Sci.Publ.Co.,Singapore (1997), 127–146.
- [Sc] M. Scharlemann *Outermost forks and a theorem of Jaco*, Combinatorial methods in topology and algebraic geometry (Rochester 1982), Contemp. Math. **44** (1985) 189–193.
- [ST1] M. Scharlemann and A. Thompson *Heegaard splittings of $(\text{surface}) \times I$ are standard* Math. Ann. **295** (1993) 549–564.
- [ST2] M. Scharlemann and A. Thompson *Thin position and Heegaard splittings of the 3-sphere* Jour. Diff. Geom. **39** (1994) 343–357.
- [Wa] F. Waldhausen, *Heegaard-Zerlegungen der 3-Sphäre*, Topology, **7** (1968), 195–203.

MATHEMATICS DEPARTMENT, UNIVERSITY OF CALIFORNIA, SANTA BARBARA, CA 93106, USA

E-mail address: mgscharl@math.ucsb.edu

MATHEMATICS DEPARTMENT, UNIVERSITY OF CALIFORNIA, DAVIS, CA 95616, USA

E-mail address: thompson@math.ucdavis.edu