

Generalized Takahashi manifolds *

Michele Mulazzani Andrei Vesnin

October 24, 2018

Abstract

We introduce a family of closed 3-dimensional manifolds, which are a generalization of certain manifolds studied by M. Takahashi. The manifolds are represented by Dehn surgery with rational coefficients on \mathbf{S}^3 , along an n -periodic $2n$ -component link. A presentation of their fundamental group is obtained, and covering properties of these manifolds are studied. In particular, this family of manifolds includes the whole class of cyclic branched coverings of two-bridge knots. As a consequence we obtain a simple explicit surgery presentation for this important class of manifolds.

Mathematics Subject Classification 2000: Primary 57M12, 57R65; Secondary 20F05, 57M05, 57M25.

Keywords: 3-manifolds, branched coverings, cyclically presented groups, Dehn surgery, Kirby calculus, 2-bridge knots.

1 Introduction

Takahashi manifolds are closed orientable 3-manifolds introduced in [21] by Dehn surgery with rational coefficients on \mathbf{S}^3 , along the $2n$ -component link \mathcal{L}_n of Figure 1, which is a closed chain of $2n$ unknotted components. These manifolds have been intensively studied in [11], [12], [18] and [20]. In particular, a topological characterization of all Takahashi manifolds as two-fold

*Work performed under the auspices of G.N.S.A.G.A. of C.N.R. of Italy and supported by the University of Bologna, funds for selected research topics. The second named author was supported by RFBR (grant no. 98-01-00699).

coverings of \mathbf{S}^3 , branched over the closure of certain rational 3-string braids, is given in [12] and [20].

A Takahashi manifold is said to be *periodic* when the surgery coefficients have the same cyclic symmetry of order n of the link \mathcal{L}_n , i.e. the coefficients are $p_k/q_k = p/q$ and $r_k/s_k = r/s$ alternately, for $k = 1, \dots, n$. Several important classes of 3-manifolds, such as (fractional) Fibonacci manifolds [7, 12] and Sieradski manifolds [2], represent notable examples of periodic Takahashi manifolds. More generally, all cyclic branched coverings of two-bridge knots of genus one are periodic Takahashi manifolds [11]. A characterization of periodic Takahashi manifolds as n -fold cyclic coverings of the connected sum of two lens spaces, branched over a knot, is given in [18].

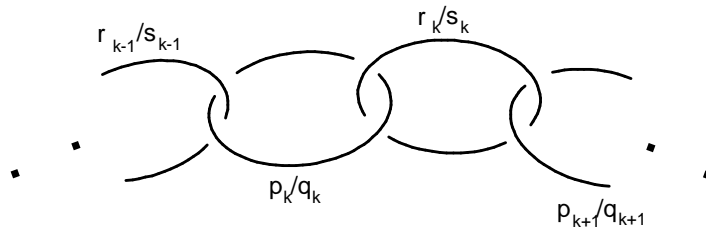

Figure 1: Surgery presentation for Takahashi manifolds.

In this paper we generalize the family of Takahashi manifolds, as well as periodic Takahashi manifolds, considering surgery along a more general family of links (see Figure 2). We obtain a presentation for the fundamental groups (Theorem 1) and study covering properties of these manifolds. The generalized Takahashi manifolds are described as 2-fold branched coverings of \mathbf{S}^3 (Theorem 3) and the generalized periodic Takahashi manifolds are described as the n -fold cyclic branched coverings of the connected sum of lens spaces (Theorem 6). In particular, we show that the family of generalized periodic Takahashi manifolds contains all cyclic coverings of two-bridge knots (Corollary 9), thus obtaining a simple explicit surgery presentation for this important class of manifolds (Figure 8). This shows that our generalization of Takahashi manifolds is, in this sense, really natural. As a further result, we give cyclic presentations (in the sense of [9]) for the fundamental groups of all cyclic branched coverings of two-bridge knots (Theorem 10).

2 Construction of the manifolds

In this section we define a family of manifolds which generalizes Takahashi manifolds. For any pair of positive integers m and n , we consider the link $\mathcal{L}_{n,m} \subset \mathbf{S}^3$ with $2mn$ components presented in Figure 2. All its components $c_{i,j}$, $1 \leq i \leq 2n$, $1 \leq j \leq m$, are unknotted circles and they form $2n$ subfamilies of m unlinked circles $c_{i,j}$, $1 \leq j \leq m$, with a common center. We observe that $\mathcal{L}_{n,1}$ is the link \mathcal{L}_n discussed above. The link $\mathcal{L}_{n,m}$ has a cyclic symmetry of order n which permutes these $2n$ subfamilies of circles.

Consider the manifold obtained by Dehn surgery on \mathbf{S}^3 , along the link $\mathcal{L}_{n,m}$, such that the surgery coefficients $p_{k,j}/q_{k,j}$ correspond to the components $c_{2k-1,j}$ and $r_{k,j}/s_{k,j}$ correspond to the components $c_{2k,j}$, where $1 \leq k \leq n$ and $1 \leq j \leq m$ (see Figure 2). Without loss of generality, we can always suppose $\gcd(p_{k,j}, q_{k,j}) = 1$, $\gcd(r_{k,j}, s_{k,j}) = 1$ and $p_{k,j}, r_{k,j} \geq 0$.

We will denote the resulting 3-manifold by $T_{n,m}(p_{k,j}/q_{k,j}; r_{k,j}/s_{k,j})$. This manifold will be referred to as a *generalized Takahashi manifold*, since for $m = 1$ we get the Takahashi manifolds introduced in [21].

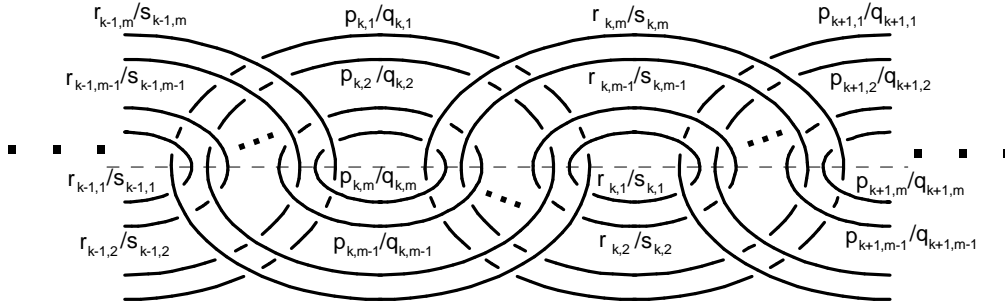

Figure 2: Surgery presentation for generalized Takahashi manifolds.

The following theorem generalizes the result obtained in [21] for Takahashi manifolds.

Theorem 1 *The fundamental group of the generalized Takahashi manifold $T_{n,m}(p_{k,j}/q_{k,j}; r_{k,j}/s_{k,j})$ has the following balanced presentation with $2nm$ generators $A = \{a_{i,j}\}_{1 \leq i \leq 2n, 1 \leq j \leq m}$ and $2nm$ relations:*

$$\langle A \mid \begin{aligned} a_{2k-1,j}^{-p_{k,j}} &= a_{2k-2,j}^{s_{k-1,j}} a_{2k-2,j+1}^{s_{k-1,j+1}} \cdots a_{2k-2,m}^{s_{k-1,m}} a_{2k,m}^{-s_{k,m}} \cdots a_{2k,j+1}^{-s_{k,j+1}} a_{2k,j}^{-s_{k,j}}, \\ a_{2k,j}^{-r_{k,j}} &= a_{2k+1,j}^{q_{k+1,j}} a_{2k+1,j-1}^{q_{k+1,j-1}} \cdots a_{2k+1,1}^{q_{k+1,1}} a_{2k-1,1}^{-q_{k,1}} \cdots a_{2k-1,j-1}^{-q_{k,j-1}} a_{2k-1,j}^{-q_{k,j}}, \\ &1 \leq k \leq n, 1 \leq j \leq m \rangle. \end{aligned}$$

Proof. Let $X = \{x_{k,j}\}_{1 \leq k \leq n, 1 \leq j \leq m}$ and $Y = \{y_{k,j}\}_{1 \leq k \leq n, 1 \leq j \leq m}$ be sets of Wirtinger generators of $\pi_1(\mathbf{S}^3 \setminus \mathcal{L}_{n,m})$, according to Figure 3.

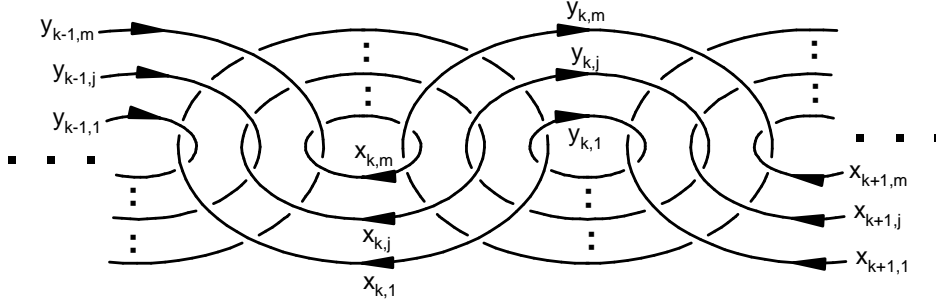

Figure 3: Generators of $\pi_1(\mathbf{S}^3 \setminus \mathcal{L}_{n,m})$.

Applying the Wirtinger algorithm we get the following presentation for $\pi_1(\mathbf{S}^3 \setminus \mathcal{L}_{n,m})$:

$$\langle X \cup Y \mid \begin{aligned} y_{k,j} \cdots y_{k,m} y_{k-1,m}^{-1} \cdots y_{k-1,j}^{-1} x_{k,j} y_{k-1,j} \cdots y_{k-1,m} y_{k,m}^{-1} \cdots y_{k,j}^{-1} &= x_{k,j}, \\ x_{k,j} \cdots x_{k,1} x_{k+1,1}^{-1} \cdots x_{k+1,j}^{-1} y_{k,j} x_{k+1,j} \cdots x_{k+1,1} x_{k,1}^{-1} \cdots x_{k,j}^{-1} &= y_{k,j}; \\ &1 \leq k \leq n, 1 \leq j \leq m \rangle. \end{aligned}$$

For every $k = 1, \dots, n$ and $j = 1, \dots, m$, let $h_{k,j}$ and $l_{k,j}$ be the longitudes associated to the components of $\mathcal{L}_{n,m}$ corresponding to the meridians $x_{k,j}$ and $y_{k,j}$ respectively (as usual we consider longitudes which are homologically trivial in the complement of the relative component). Then we have the relations:

$$h_{k,j} = y_{k-1,j} y_{k-1,j+1} \cdots y_{k-1,m} y_{k,m}^{-1} \cdots y_{k,j+1}^{-1} y_{k,j}^{-1},$$

and

$$l_{k,j} = x_{k+1,j} x_{k+1,j-1} \cdots x_{k+1,1} x_{k,1}^{-1} \cdots x_{k,j-1}^{-1} x_{k,j}^{-1}.$$

Introducing $H = \{h_{k,j}\}_{1 \leq k \leq n, 1 \leq j \leq m}$ and $L = \{l_{k,j}\}_{1 \leq k \leq n, 1 \leq j \leq m}$, we obtain the following new presentation for $\pi_1(\mathbf{S}^3 \setminus \mathcal{L}_{n,m})$:

$$\langle X \cup Y \cup H \cup L \mid \begin{aligned} [x_{k,j}, h_{k,j}] &= 1, & h_{k,j} &= y_{k-1,j} \cdots y_{k-1,m} y_{k,m}^{-1} \cdots y_{k,j}^{-1}, \\ [y_{k,j}, l_{k,j}] &= 1, & l_{k,j} &= x_{k+1,j} \cdots x_{k+1,1} x_{k,1}^{-1} \cdots x_{k,j}^{-1}; \\ & & & 1 \leq k \leq n, 1 \leq j \leq m \end{aligned} \rangle.$$

Therefore, the fundamental group of $T_{n,m}(p_{i,j}/q_{i,j}; r_{i,j}/s_{i,j})$ admits the presentation:

$$\langle X \cup Y \cup H \cup L \mid \begin{aligned} [x_{k,j}, h_{k,j}] &= 1, & h_{k,j} &= y_{k-1,j} \cdots y_{k-1,m} y_{k,m}^{-1} \cdots y_{k,j}^{-1}, \\ [y_{k,j}, l_{k,j}] &= 1, & l_{k,j} &= x_{k+1,j} \cdots x_{k+1,1} x_{k,1}^{-1} \cdots x_{k,j}^{-1}; \\ x_{k,j}^{p_{k,j}} h_{k,j}^{q_{k,j}} &= 1, & y_{k,j}^{r_{k,j}} l_{k,j}^{s_{k,j}} &= 1, & 1 \leq k \leq n, 1 \leq j \leq m \end{aligned} \rangle.$$

Since $\gcd(p_{k,j}, q_{k,j}) = 1$ and $\gcd(r_{k,j}, s_{k,j}) = 1$, there exist certain integers $u_{k,j}, v_{k,j}, w_{k,j}$ and $z_{k,j}$ such that $q_{k,j}u_{k,j} - p_{k,j}v_{k,j} = 1$ and $s_{k,j}w_{k,j} - r_{k,j}z_{k,j} = 1$.

For $k = 1, \dots, n$ and $j = 1, \dots, m$ we define

$$a_{2k-1,j} = x_{k,j}^{u_{k,j}} h_{k,j}^{v_{k,j}}, \quad a_{2k,j} = y_{k,j}^{w_{k,j}} l_{k,j}^{z_{k,j}}.$$

Since $x_{k,j}$ and $h_{k,j}$ (resp. $y_{k,j}$ and $l_{k,j}$) commute, we have

$$\begin{aligned} a_{2k-1,j}^{q_{k,j}} &= x_{k,j}^{q_{k,j}u_{k,j}} (x_{k,j}^{p_{k,j}v_{k,j}} h_{k,j}^{q_{k,j}v_{k,j}}) = x_{k,j}^{q_{k,j}}, \\ a_{2k-1,j}^{-p_{k,j}} &= (x_{k,j}^{-p_{k,j}u_{k,j}} h_{k,j}^{-q_{k,j}u_{k,j}}) h_{k,j} = h_{k,j}, \\ a_{2k,j}^{s_{k,j}} &= y_{k,j}^{s_{k,j}w_{k,j}} (y_{k,j}^{r_{k,j}z_{k,j}} h_{k,j}^{s_{k,j}z_{k,j}}) = y_{k,j}^{s_{k,j}}, \\ a_{2k,j}^{-r_{k,j}} &= (y_{k,j}^{-r_{k,j}w_{k,j}} l_{k,j}^{-s_{k,j}w_{k,j}}) l_{k,j} = l_{k,j}. \end{aligned}$$

Using these relations we can eliminate all the generators of the previous presentation of $T_{n,m}(p_{k,j}/q_{k,j}; r_{k,j}/s_{k,j})$, replacing them with the set $\{a_{i,j}\}_{1 \leq i \leq 2n, 1 \leq j \leq m}$. The first four types of relations of the above presentation disappear and the statement is obtained. ■

When the surgery coefficients are n -periodic, i.e. $p_{k,j} = p_j$, $q_{k,j} = q_j$, $r_{k,j} = r_j$, and $s_{k,j} = s_j$, the resulting manifold $T_{n,m}(p_j/q_j; r_j/s_j)$ is said to be a *generalized periodic (n -periodic) Takahashi manifold*.

Corollary 2 *The fundamental group of the generalized periodic Takahashi manifold $T_{n,m}(p_j/q_j; r_j/s_j)$ admits the presentation*

$$\langle \{a_{i,j}\}_{1 \leq i \leq 2n, 1 \leq j \leq m} \mid \begin{aligned} a_{2k-1,j}^{-p_j} &= a_{2k-2,j}^{s_j} \cdots a_{2k-2,m}^{s_m} a_{2k,m}^{-s_m} \cdots a_{2k,j}^{-s_j}, \\ a_{2k,j}^{-r_j} &= a_{2k+1,j}^{q_j} \cdots a_{2k+1,1}^{q_1} a_{2k-1,1}^{-q_1} \cdots a_{2k-1,j}^{-q_j}; \\ & 1 \leq k \leq n, 1 \leq j \leq m \end{aligned} \rangle.$$

3 Covering properties of generalized Takahashi manifolds

We will define a new family of links in \mathbf{S}^3 . For any pair of integers $n, m > 0$ consider two pairs of coprime integers $(p_{k,j}, q_{k,j})$ and $(r_{k,j}, s_{k,j})$, where $k = 1, \dots, n$ and $j = 1, \dots, m$. Let $\mathcal{K}_{n,m}(p_{k,j}/q_{k,j}; r_{k,j}/s_{k,j})$ be the closure of the rational braid on $2m+1$ strings with rational tangles [1] $p_{k,j}/q_{k,j}$ and $r_{k,j}/s_{k,j}$ indicated in Figure 4.

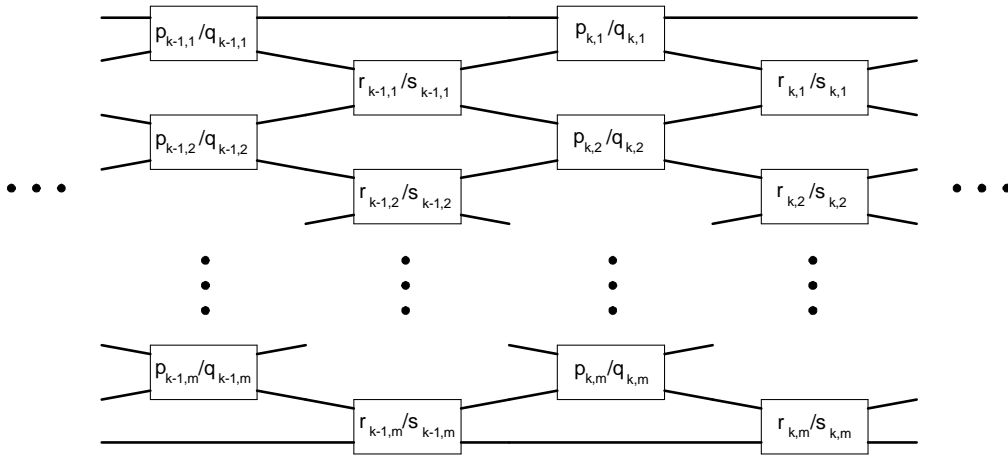

Figure 4: The link $\mathcal{K}_{n,m}(p_{k,j}/q_{k,j}; r_{k,j}/s_{k,j})$.

As a generalization of the results from [12, 20, 21], we get:

Theorem 3 *The generalized Takahashi manifold $T_{n,m}(p_{k,j}/q_{k,j}; r_{k,j}/s_{k,j})$ is the 2-fold covering of \mathbf{S}^3 , branched over the link $\mathcal{K}_{n,m}(p_{k,j}/q_{k,j}; r_{k,j}/s_{k,j})$.*

Proof. From Figure 2 we see that the link $\mathcal{L}_{n,m}$ admits a strongly invertible involution τ whose axis (pictured with dashed line) intersects each component of the link in two points. Thus, in virtue of the Montesinos theorem [16], the manifold $T_{n,m}(p_{k,j}/q_{k,j}; r_{k,j}/s_{k,j})$ can be obtained as the 2-fold covering of \mathbf{S}^3 , branched over some link.

Applying the Montesinos algorithm, we get the link depicted in Figure 5. Obviously, this branching set is equivalent to the link presented in Figure 4.

■

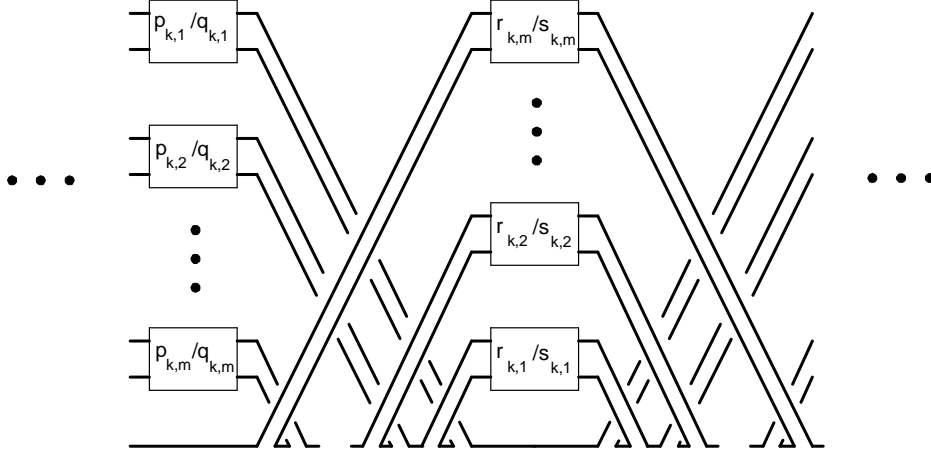

Figure 5:

In particular, if the surgery coefficients are n -periodic, i.e. $p_{k,j} = p_j$, $q_{k,j} = q_j$, $r_{k,j} = r_j$, and $s_{k,j} = s_j$, the link $\mathcal{K}_{n,m}(p_j/q_j; r_j/s_j)$ is also n -periodic. Note that $\mathcal{K}_{n,1}(1; -1)$ is an alternating link with $2n$ double-crossings, which is the closure of a 3-string braid, referred to as a Turk head link in [14]: $\mathcal{K}_{2,1}(1; -1)$ is the figure-eight knot and $\mathcal{K}_{3,1}(1; -1)$ are the Borromean rings.

Corollary 4 *The generalized periodic Takahashi manifold $T_{n,m}(p_j/q_j; r_j/s_j)$ is the 2-fold covering of \mathbf{S}^3 , branched over the periodic link $\mathcal{K}_{n,m}(p_j/q_j; r_j/s_j)$.*

In other words, $T_{n,m}(p_j/q_j; r_j/s_j)$ is the \mathbf{Z}_2 -covering of the orbifold $\mathbf{S}^3(\mathcal{K}_{n,m}(p_j/q_j; r_j/s_j))$ whose underlying space is \mathbf{S}^3 and whose singular set is $\mathcal{K}_{n,m}(p_j/q_j; r_j/s_j)$, with singularity indices 2. Since the singular set of the orbifold is n -periodic, there is a natural action of a cyclic group \mathbf{Z}_n such that the quotient orbifold is $\mathbf{S}^3(\mathcal{Q}_{n,m}(p_j/q_j; r_j/s_j))$, where the singular set is the link pictured in Figure 6 and the indices of singularity are: 2 on the components which are images of $\mathcal{K}_{n,m}(p_j/q_j; r_j/s_j)$ and n on the unknotted component. Note that the part of the singular set having index 2 can be obtained as a connected sum of $2m$ two-bridge links corresponding to the rational tangles $p_1/q_1, r_1/s_1, \dots, p_m/q_m, r_m/s_m$.

Therefore we get the following statement.

Corollary 5 *The generalized periodic Takahashi manifold $T_{n,m}(p_j/q_j; r_j/s_j)$ is the $\mathbf{Z}_2 \oplus \mathbf{Z}_n$ -covering of the orbifold $\mathbf{S}^3(\mathcal{Q}_{n,m}(p_j/q_j; r_j/s_j))$.*

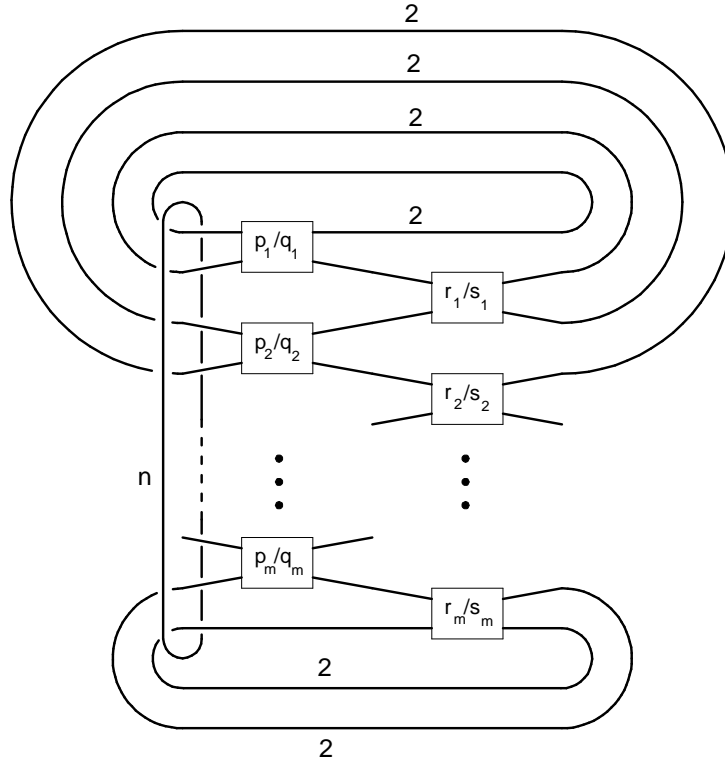

Figure 6: The link $\mathcal{Q}_{n,m}(p_j/q_j; r_j/s_j)$.

The following theorem extends to generalized periodic Takahashi manifolds the result given in [18] for periodic Takahashi manifolds.

Theorem 6 *The generalized periodic Takahashi manifold $T_{n,m}(p_j/q_j; r_j/s_j)$ is the n -fold cyclic covering of the connected sum of $2m$ lens spaces $L(p_1, q_1) \# L(r_1, s_1) \# \cdots \# L(p_m, q_m) \# L(r_m, s_m)$, branched over a knot which does not depend on n .*

Proof. Both the link $\mathcal{L}_{n,m}$ and the surgery coefficients defining the manifold $T_{n,m}(p_j/q_j; r_j/s_j)$ (and so, also the manifold) are invariant with respect to an obvious rotation symmetry ρ of order n . Denote by $\langle \rho \rangle$ the cyclic group of order n generated by this rotation. Observe that the fixed-point set of the action of $\langle \rho \rangle$ on \mathbf{S}^3 is a trivial knot disjoint from $\mathcal{L}_{n,m}$. Therefore, we have an action of $\langle \rho \rangle$ on $T_{n,m}(p_j/q_j; r_j/s_j)$, with a knot $K = K(\rho)$ as fixed-point

set. The underlying space of the quotient orbifold $T_{n,m}(p_j/q_j; r_j/s_j)/\langle \rho \rangle$ is precisely the manifold $T_{1,m}(p_j/q_j; r_j/s_j)$, which can be obtained by Dehn surgery on \mathbf{S}^3 , with coefficients p_j/q_j and r_j/s_j , $j = 1, \dots, m$, along the $2m$ -component link $\mathcal{L}_{1,m}$ depicted in Figure 7.

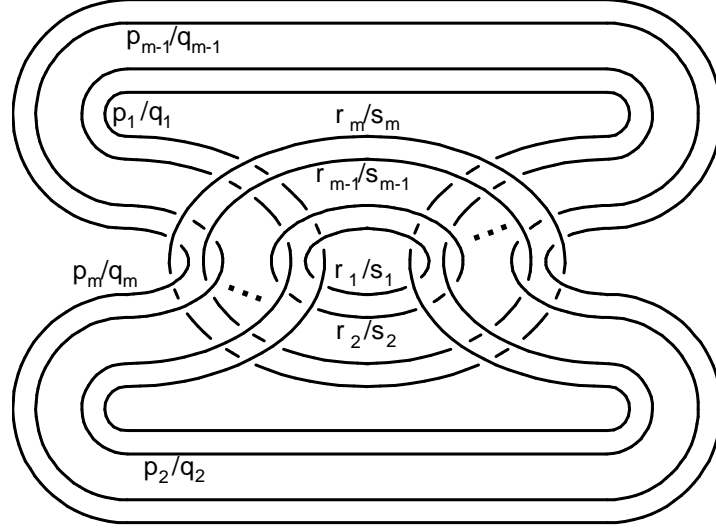

Figure 7: The link $\mathcal{L}_{1,m}$.

The components of $\mathcal{L}_{1,m}$ are unlinked, unknotted, and form a trivial link with $2m$ components. Therefore the underlying space of the quotient orbifold is homeomorphic to the connected sum of $2m$ lens spaces $L(p_1, q_1) \# L(r_1, q_1) \# \dots \# L(p_m, q_m) \# L(r_m, s_m)$ (see [19, p. 260]). Moreover, it is obvious from the action of ρ that the singular set K of the quotient orbifold is a knot which does not depend on n . ■

Denote by $\mathcal{O}_{n,m}(p_j/q_j; r_j/s_j) = T_{n,m}(p_j/q_j; r_j/s_j)/\langle \rho \rangle$ the orbifold from the proof of Theorem 6, whose underlying space is the connected sum of $2m$ lens spaces $L(p_1, q_1) \# L(r_1, s_1) \# \dots \# L(p_m, q_m) \# L(r_m, s_m)$.

Corollary 7 *The following commutative diagram holds for each generalized periodic Takahashi manifold.*

$$\begin{array}{ccc}
& T_{n,m}(p_j/q_j; r_j/s_j) & \\
& \swarrow 2 \quad \searrow n & \\
\mathbf{S}^3(\mathcal{K}_{n,m}(p_j/q_j; r_j/s_j)) & & \mathcal{O}_{n,m}(p_j/q_j; r_j/s_j) \\
& \swarrow n \quad \searrow 2 & \\
& \mathbf{S}^3(\mathcal{Q}_{n,m}(p_j/q_j; r_j/s_j)) &
\end{array}$$

Proof. From Figure 2 we see that $\mathcal{L}_{n,m}$ admits an invertible involution τ whose axis intersects each component in two points and the rotation symmetry ρ of order n which was discussed in Theorem 6. These symmetries induce symmetries (also denoted by τ and ρ) of the generalized periodic Takahashi manifold $T = T_{n,m}(p_j/q_j; r_j/s_j)$, such that $\langle \tau, \rho \rangle \cong \langle \tau \rangle \oplus \langle \rho \rangle \cong \mathbf{Z}_2 \oplus \mathbf{Z}_n$. As mentioned above, ρ induces the symmetry (also denoted by ρ) of the orbifold $T/\langle \tau \rangle$ (whose singular set is given by Corollary 4), and the covering $T \rightarrow (T/\langle \tau \rangle)/\langle \rho \rangle$ is given by Corollary 5. The covering $T \rightarrow T/\langle \rho \rangle$ is given by Theorem 6. As we see from Figure 7, τ induces the strongly invertible involution (also denoted by τ) of the link $\mathcal{L}_{1,m}$. Using the Montesinos algorithm we see that $(T/\langle \rho \rangle)/\langle \tau \rangle = \mathbf{S}^3(\mathcal{Q}_{n,m}(p_j/q_j; r_j/s_j))$ (note that the part of the singular set of $\mathbf{S}^3(\mathcal{Q}_{n,m}(p_j/q_j; r_j/s_j))$ having index 2 can be obtained as a connected sum of $2m$ two-bridge links corresponding to the rational tangles $p_1/q_1, r_1/s_1, \dots, p_m/q_m, r_m/s_m$). ■

4 Cyclic branched coverings of 2-bridge knots

In this section we show that generalized periodic Takahashi manifolds contain the whole class of cyclic branched coverings of two-bridge knots. In the following we use the Conway notation for two-bridge knots (see [4]).

Theorem 8 *The generalized periodic Takahashi manifold $T_{n,m}(1/q_j; 1/s_j)$ is the n -fold cyclic branched covering of the two-bridge knot corresponding to the Conway parameters $[-2q_1, 2s_1, \dots, -2q_m, 2s_m]$.*

Proof. From Theorem 6, $T_{n,m}(1/q_j; 1/s_j)$ is the n -fold cyclic covering of \mathbf{S}^3 , branched over a knot K . Figures 9–15 shows how to deform K

to a Conway's normal form of a two-bridge knot with Conway parameters $[-2q_1, 2s_1, \dots, -2q_m, 2s_m]$ by ambient isotopy (from Figure 9 to Figure 12) and surgery calculus [19] (from Figure 13 to Figure 15). ■

Remark As a consequence of Theorem 8, the generalized periodic Takahashi manifold $T_{n,m}(1/q_j; 1/s_j)$ is homeomorphic to the Lins-Mandel manifold $S(n, a, b, 1)$ [13, 17], the Minkus manifold $M_n(a, b)$ [15] and the Dunwoody manifold $M((a-1)/2, 0, 1, b/2, n, -q_\sigma)$ [5, 6], where a/b is defined by (1).

Because every 2-bridge knot admits a Conway representation with an even number of even parameters (see, Exercise 2.1.14 of [10]), we have the following property.

Corollary 9 *The family of generalized periodic Takahashi manifolds contains all cyclic branched coverings of two-bridge knots.*

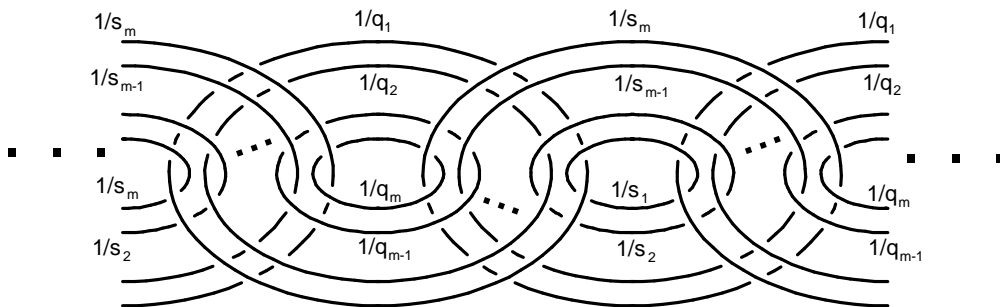

Figure 8: Surgery presentation for $\widehat{C}_n(-2q_1 + \frac{1}{2s_1 + \dots + \frac{1}{-2q_m + 2s_m}})$.

From Theorem 8 we can easily get the surgery presentation for the n -fold cyclic branched covering $\widehat{C}_n(a/b)$ of the two-bridge knot, with Conway parameters $[-2q_1, 2s_1, \dots, -2q_m, 2s_m]$, depicted in Figure 8.

5 Cyclically presented fundamental groups

A cyclic presentation for the fundamental groups of cyclic branched coverings of two-bridge knots is obtained by J. Minkus (see Theorem 10 of [15]). Corollary 2 and Theorem 8 allow us to obtain a different cyclic presentation for

such groups. Note that explicit cyclic presentations different from the above are listed in the Appendix of [3], for two-bridge knots up to nine crossings.

Theorem 10 *Let $\widehat{C}_n(a/b)$ be the n -fold cyclic branched covering of the two-bridge knot $\mathbf{b}(a/b)$, with a/b given by formula (1). Then its fundamental group has the following cyclic presentation:*

$$\pi_1(\widehat{C}_n(a/b)) = \langle x_1, \dots, x_n \mid w_{a/b}(x_i, \dots, x_{i+n-1}) = 1, \quad i = 1, \dots, n \rangle,$$

where

$$w_{a/b}(x_i, \dots, x_{i+n-1}) = b_{i+1,m}^{-s_m} d_{i+1} b_{1,m}^{s_m}$$

for $i = 1, \dots, n$ (indices mod n). The right parts of these formulas are defined by the recurrent rule

$$d_{k,j} = b_{k,j-1}^{-s_{j-1}} d_{k,j-1} b_{k-1,j-1}^{s_{j-1}}, \quad b_{k,j} = d_{k,j}^{q_j} b_{k,j-1} d_{k+1,j}^{-q_j}, \quad j = 2, \dots, m$$

and

$$b_{k,1} = d_{k,1}^{q_1} d_{k+1,1}^{-q_1},$$

where $x_k = d_{k,1}$, for $k = 1, \dots, n$.

Proof. From Corollary 2 and Theorem 8, the group $\pi_1(\widehat{C}_n(a/b))$ is generated by the $2nm$ elements $\{a_{i,j}\}_{i=1,\dots,2n, j=1,\dots,m}$ and has relations of two types:

$$\begin{aligned} a_{2k-1,j}^{-1} &= \left(a_{2k-2,j}^{s_j} a_{2k-2,j+1}^{s_{j+1}} \cdots a_{2k-2,m}^{s_m} \right) \cdot \left(a_{2k,j}^{s_j} a_{2k,j+1}^{s_{j+1}} \cdots a_{2k,m}^{s_m} \right)^{-1}, \\ a_{2k,j}^{-1} &= \left(a_{2k+1,j}^{q_j} a_{2k+1,j-1}^{q_{j-1}} \cdots a_{2k+1,1}^{q_1} \right) \cdot \left(a_{2k-1,j}^{q_j} a_{2k-1,j-1}^{q_{j-1}} \cdots a_{2k-1,1}^{q_1} \right)^{-1}, \end{aligned}$$

where $k = 1, \dots, n$ and $j = 1, \dots, m$, and all the indices are taken mod $2n$ and m respectively. Denote $b_{k,j} = a_{2k,j}$ and $d_{k,j} = a_{2k-1,j}$ for $k = 1, \dots, n$ and $j = 1, \dots, m$. Then we have $2nm$ relations of the two following types:

$$d_{k,j} = b_{k,j}^{s_j} b_{k,j+1}^{s_{j+1}} \cdots b_{k,m}^{s_m} b_{k-1,m}^{-s_m} \cdots b_{k-1,j+1}^{-s_{j+1}} b_{k-1,j}^{-s_j}$$

and

$$b_{k,j} = d_{k,j}^{q_j} d_{k,j-1}^{q_{j-1}} \cdots d_{k,1}^{q_1} d_{k+1,1}^{-q_1} \cdots d_{k+1,j-1}^{-q_{j-1}} b_{k+1,j}^{-q_j}.$$

Therefore, the defining relations for the group are:

$$b_{k,m}^{-s_m} d_{k,m} b_{k-1,m}^{s_m} = 1, \quad d_{k,j+1} = b_{k,j}^{-s_j} d_{k,j} b_{k-1,j}^{s_j}, \quad j = 1, \dots, m-1,$$

and

$$b_{k,1} = d_{k,1}^{q_1} d_{k+1,1}^{-q_1}, \quad b_{k,j} = d_{k,j}^{q_j} b_{k,j-1} d_{k+1,j}^{-q_j}, \quad j = 2, \dots, m,$$

for $k = 1, \dots, n$. Denoting $x_k = d_{k,1}$, $k = 1, \dots, n$, we will eliminate all other generators in the following order: $b_{k,1}, d_{k,2}, b_{k,2}, \dots, d_{k,m}, b_{k,m}$ according to the above formulae. At the end of this process we will get n relations arising from $b_{k,m}^{-s_m} d_{k,m} b_{k-1,m}^{s_m} = 1$. That completes the proof. ■

We will illustrate the obtained result for the cases $m = 1$ and $m = 2$.

If $m = 1$, then $a/b = -2q + \frac{1}{2s}$, and $\widehat{C}_n(a/b) = T_{n,1}(1/q, 1/s)$. This case, corresponding to a Takahashi manifold, was discussed in [11] and [12]. Using notations $b_k = b_{k,1}$ and $d_k = d_{k,1}$ for $k = 1, \dots, n$, we get

$$\begin{aligned} \pi_1(T_{n,1}(1/q, 1/s)) = \\ \langle b_1, \dots, b_n, d_1, \dots, d_n \mid b_k^{-s} d_k b_k^s = 1, \quad b_k = d_k^q d_{k+1}^{-q}, \quad k = 1, \dots, n \rangle. \end{aligned}$$

Hence

$$\pi_1(T_{n,1}(1/q, 1/s)) = \langle x_1, \dots, x_n \mid (x_k^q x_{k+1}^{-q})^{-s} x_k (x_{k-1}^q x_k^{-q})^s = 1, \quad k = 1, \dots, n \rangle.$$

For example, if $q = -1$ and $s = 1$ then $a/b = 5/2$, that corresponds to the figure-eight knot 4_1 [1]. So, its n -fold cyclic branched covering has the fundamental group with the cyclic presentation

$$\pi_1(T_{n,1}(-1, 1)) = \langle x_1, \dots, x_n \mid x_{k+1}^{-1} x_k^2 x_{k-1}^{-1} x_k = 1, \quad k = 1, \dots, n \rangle$$

(compare with [3, 11, 12]).

For $m = 2$ we get

$$\begin{aligned} \pi_1(T_{n,2}(1/q_1, 1/q_2; 1/s_1, 1/s_2)) = \\ \langle b_{1,1}, \dots, b_{n,1}, b_{1,2}, \dots, b_{n,2}, d_{1,1}, \dots, d_{n,1}, d_{1,2}, \dots, d_{n,2} \mid \\ b_{k,2}^{-s_2} d_{k,2} b_{k-1,2}^{s_2} = 1, \quad d_{k,2} = b_{k,1}^{-s_1} d_{k,1} b_{k-1,1}^{s_1}, \quad b_{k,1} = d_{k,1}^{q_1} d_{k+1,1}^{-q_1}, \\ b_{k,2} = d_{k,2}^{q_2} b_{k,1} d_{k+1,2}^{-q_2}, \quad k = 1, \dots, n \rangle. \end{aligned}$$

Denote $x_k = d_{k,1}$, then $b_{k,1} = x_{k,1}^{q_1} x_{k+1}^{-q_1}$. Therefore

$$d_{k,2} = (x_k^{q_1} x_{k+1}^{-q_1})^{-s_1} x_k (x_{k-1}^{q_1} x_k^{-q_1})^{s_1}$$

and

$$b_{k,2} = \left[(x_k^{q_1} x_{k+1}^{-q_1})^{-s_1} x_k (x_{k-1}^{q_1} x_k^{-q_1})^{s_1} \right]^{q_2} (x_k^{q_1} x_{k+1}^{-q_1}) \left[(x_{k+1}^{q_1} x_{k+2}^{-q_1})^{-s_1} x_{k+1} (x_k^{q_1} x_{k+1}^{-q_1})^{s_1} \right]^{-q_2}.$$

Define

$$\begin{aligned} w_{a/b}(x_{k-2}, x_{k-1}, x_k, x_{k+1}, x_{k+2}) = & \\ & \left[\left[(x_k^{q_1} x_{k+1}^{-q_1})^{-s_1} x_k (x_{k-1}^{q_1} x_k^{-q_1})^{s_1} \right]^{q_2} x_k^{q_1} x_{k+1}^{-q_1} \left[(x_{k+1}^{q_1} x_{k+2}^{-q_1})^{-s_1} x_{k+1} (x_k^{q_1} x_{k+1}^{-q_1})^{s_1} \right]^{-q_2} \right]^{-s_2} \\ & \cdot (x_k^{q_1} x_{k+1}^{-q_1})^{-s_1} x_k (x_{k-1}^{q_1} x_k^{-q_1})^{s_1} \\ \cdot & \left[\left[(x_{k-1}^{q_1} x_k^{-q_1})^{-s_1} x_{k-1} (x_{k-2}^{q_1} x_{k-1}^{-q_1})^{s_1} \right]^{q_2} x_{k-1}^{q_1} x_k^{-q_1} \left[(x_k^{q_1} x_{k+1}^{-q_1})^{-s_1} x_k (x_{k-1}^{q_1} x_k^{-q_1})^{s_1} \right]^{-q_2} \right]^{s_2}. \end{aligned}$$

Therefore, we get the following cyclic presentation for the fundamental group of the n -fold cyclic branched covering of the two-bridge knot $\mathbf{b}(a/b)$ corresponding to $[-2q_1, 2s_1, -2q_2, 2s_2]$:

$$\pi_1(T_{n,2}(1/q_1, 1/q_2; 1/s_1, 1/s_2)) =$$

$$\langle x_1, \dots, x_n \mid w_{a/b}(x_{k-2}, x_{k-1}, x_k, x_{k+1}, x_{k+1}) = 1, \quad k = 1, \dots, n \rangle,$$

where all the indices are mod n .

For example, for $q_1 = q_2 = -1$ and $s_1 = s_2 = 1$ we get $a/b = 29/12$, that corresponds to the knot 8_{12} . So, its n -fold cyclic branched covering has the fundamental group with the following cyclic presentation:

$$\langle x_1, \dots, x_n \mid \begin{aligned} & x_{k+1}^{-1} x_k x_{k+1}^{-2} x_{k+2} x_{k+1}^{-1} x_k x_{k+1}^{-1} x_k^2 x_{k-1}^{-1} x_k x_{k+1}^{-1} \\ & \cdot x_k^2 x_{k-1}^{-1} x_k x_{k-1}^{-1} x_{k-2} x_{k-1}^{-2} x_k x_{k-1}^{-1} x_k x_{k+1}^{-1} x_k^2 x_{k-1}^{-1} x_k = 1, \quad k = 1, \dots, n \end{aligned} \rangle.$$

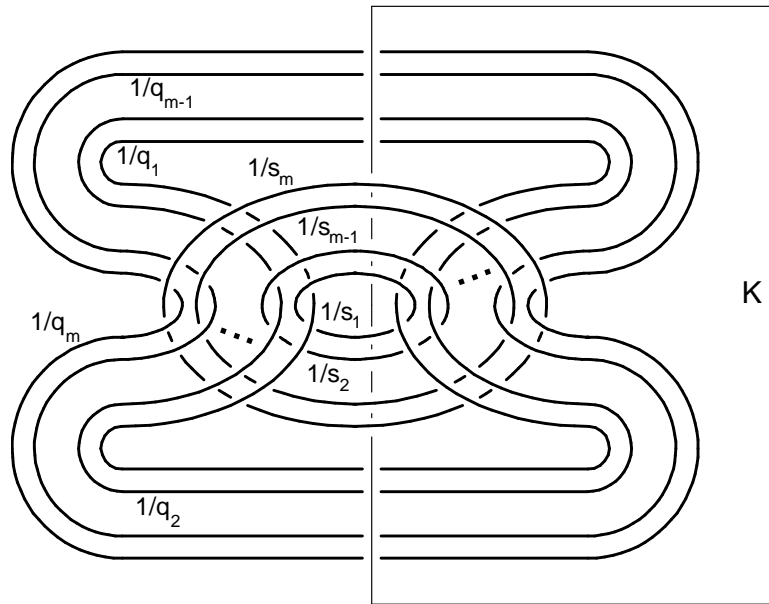

Figure 9: $\mathcal{L}_{1,m} \cup K$.

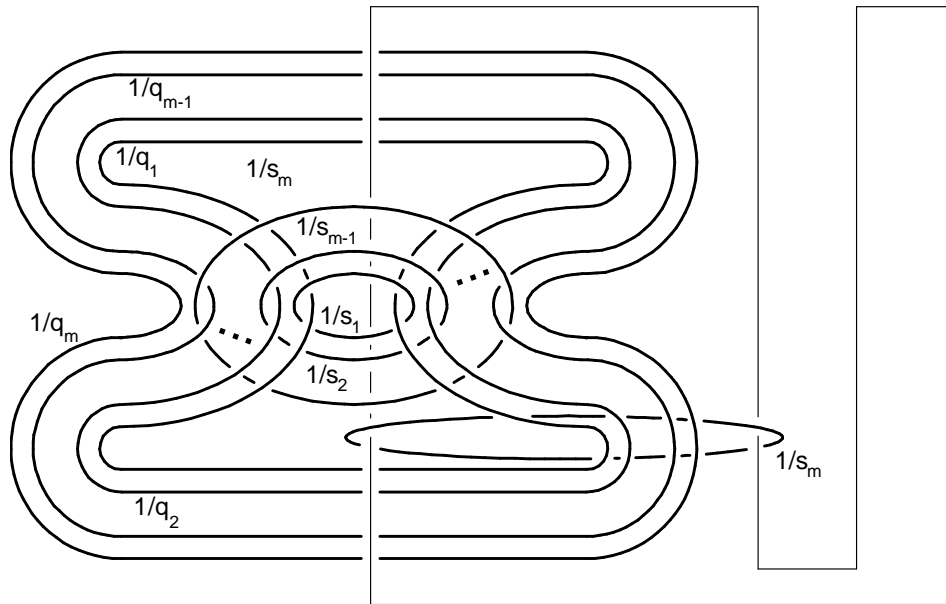

Figure 10:

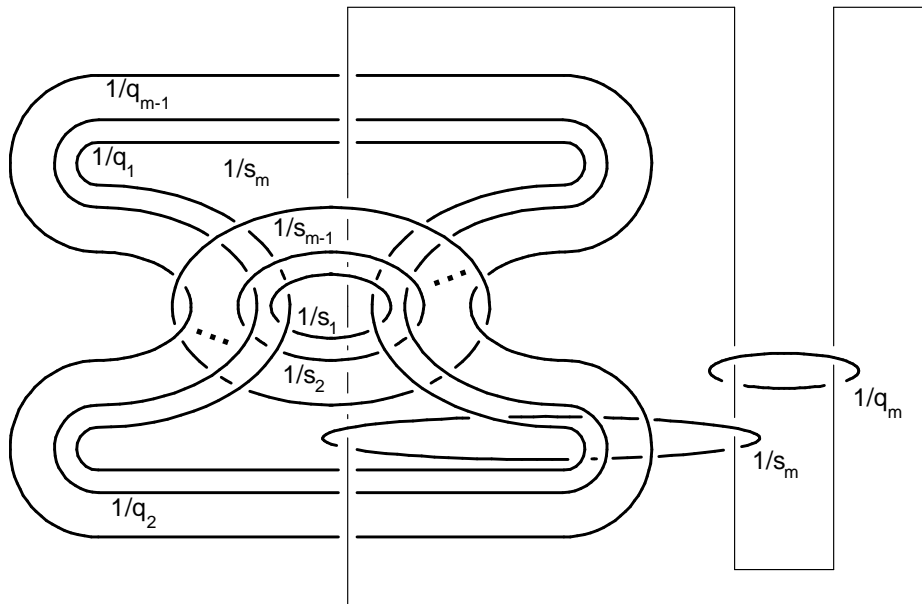

Figure 11:

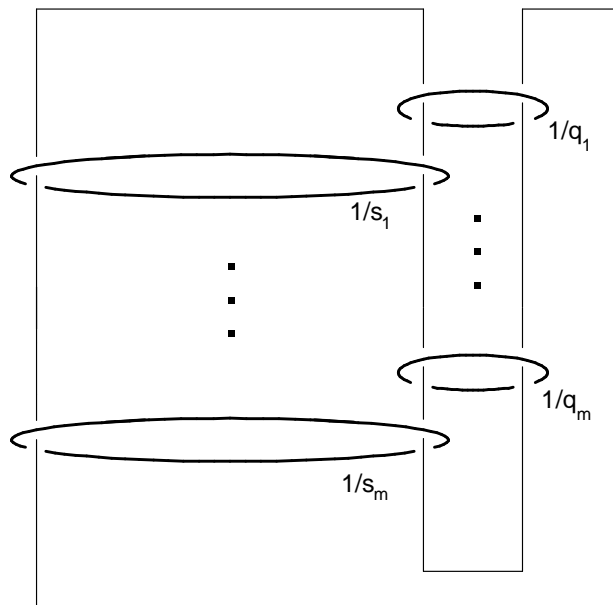

Figure 12:

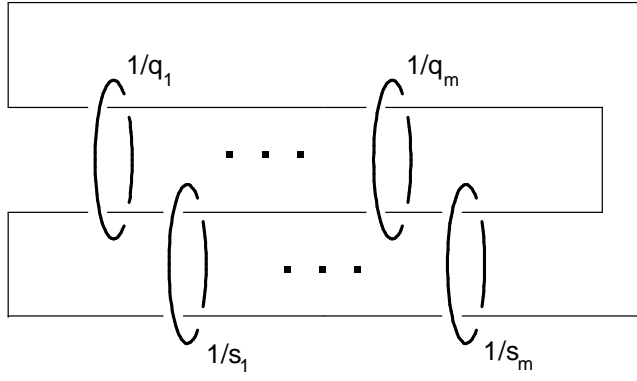

Figure 13:

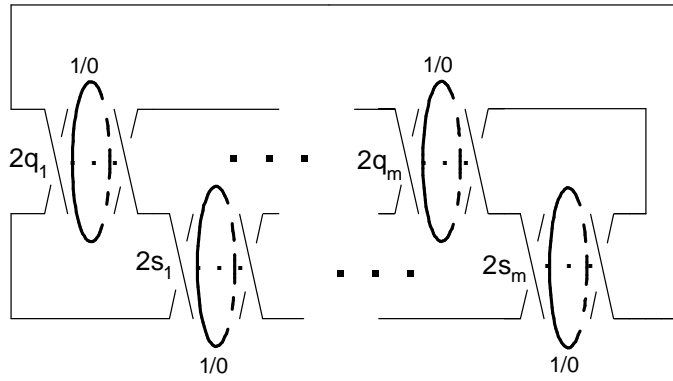

Figure 14:

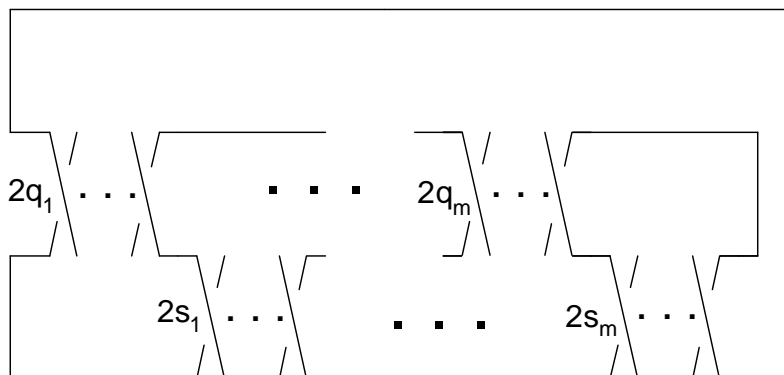

Figure 15:

References

- [1] Burde, G., Zieschang, H.: Knots. de Gruyter Studies in Mathematics, **5**, Berlin–New York, 1985.
- [2] Cavicchioli, A., Hegenbarth F., Kim, A.C.: A geometric study of Sieradski groups. Algebra Colloq. **5** (1998), 203–217.
- [3] Cavicchioli, A., Ruini, B., Spaggiari, F.: Cyclic branched coverings of 2-bridge knots. Revista Mat. Compl. **12** (1999), 383–416.
- [4] Conway, J.H.: An enumeration of knots and links and some of their related properties. In: Computational problems in Abstract Algebra, Proc. Conf. Oxford 1967 (ed. J.Leech), Pergamon Press (1969), 329–358.
- [5] Dunwoody, M.J.: Cyclic presentations and 3-manifolds. In: Proc. Inter. Conf., Groups-Korea '94, Walter de Gruyter, Berlin-New York (1995), 47–55.
- [6] Grasselli, L., Mulazzani, M.: Genus one 1-bridge knots and Dunwoody manifolds. Forum Math. **13** (2001), 379–397.
- [7] Helling, H., Kim, A.C., Mennicke, J.L.: A geometric study of Fibonacci groups. J. Lie Theory **8** (1998), 1-23.

- [8] Hodgson, C., Rubinstein, J.H.: Involutions and isotopies of lens spaces. In: Knot theory and manifolds - Vancouver 1983, Lect. Notes Math. **1144**, Springer (1985), 60–96.
- [9] Johnson, D.L.: Topics in the theory of group presentations. London Math. Soc. Lect. Note Ser., vol. 42, Cambridge Univ. Press, Cambridge, U.K., 1980.
- [10] Kawachi, A: A survey of knot theory. Birkhauser Verlag, Basel, 1996.
- [11] Kim, A.C., Kim, Y., Vesnin, A.: On a class of cyclically presented groups. In: Proc. Inter. Conf., Groups-Korea '98, Walter de Gruyter, Berlin-New York (2000), 211–220.
- [12] Kim, A.C., Vesnin, A.: The fractional Fibonacci groups and manifolds. Sib. Math. J. **39** (1998), 655–664.
- [13] Lins, S., Mandel, A.: Graph-encoded 3-manifolds. Discrete Math. **57** (1985), 261–284.
- [14] Mednykh, A., Vesnin, A.: Fibonacci manifolds as two-fold coverings over the three-dimensional sphere and the Meyerhoff – Neumann conjecture. Sib. Math. J. **37** (1996), 461–467.
- [15] Minkus, J.: The branched cyclic coverings of 2 bridge knots and links. Mem. Am. Math. Soc. **35** Nr. 255 (1982), 1–68.
- [16] Montesinos, J.M.: Surgery on links and double branched covers of S^3 . In: Knots, Groups, and 3-Manifolds, Edited by L.P. Neuwirth, Princeton University Press, Princeton, (1975), 227–259.
- [17] Mulazzani, M.: All Lins-Mandel spaces are branched cyclic coverings of S^3 . J. Knot Theory Ramifications **5** (1996), 239–263.
- [18] Mulazzani, M.: On periodic Takahashi manifolds. To appear in Tsukuba Journal of Mathematics.
- [19] Rolfsen, D.: Knots and Links. Publish or Perish Inc., Berkeley Ca., 1976.
- [20] Ruini, B., Spaggiari, F.: On the structure of Takahashi manifolds. Tsukuba J. Math. **22** (1998), 723–739.

- [21] Takahashi, M.: On the presentations of the fundamental groups of 3-manifolds. Tsukuba J. Math. **13** (1989), 175-189.

MICHELE MULAZZANI, Department of Mathematics, University of Bologna, I-40127 Bologna, ITALY, and C.I.R.A.M., Bologna, ITALY. E-mail: mulazza@dm.unibo.it

ANDREI VESNIN, The Sobolev Institute of Mathematics, Novosibirsk, 630090 Russia. E-mail: vesnin@math.nsk.ru