

# TORUS ACTIONS, COMBINATORIAL TOPOLOGY AND HOMOLOGICAL ALGEBRA

VICTOR M. BUCHSTABER AND TARAS E. PANOV

ABSTRACT. The paper surveys some new results and open problems connected with such fundamental combinatorial concepts as polytopes, simplicial complexes, cubical complexes, and subspace arrangements. Particular attention is paid to the case of simplicial and cubical subdivisions of manifolds and, especially, spheres. We describe important constructions which allow to study all these combinatorial objects by means of methods of commutative and homological algebra. The proposed approach to combinatorial problems relies on the theory of moment-angle complexes, currently being developed by the authors. The theory centres around the construction that assigns to each simplicial complex  $K$  with  $m$  vertices a  $T^m$ -space  $\mathcal{Z}_K$  with a special bigraded cellular decomposition. In the framework of this theory, the well-known non-singular toric varieties arise as orbit spaces of maximally free actions of subtori on moment-angle complexes corresponding to simplicial spheres. We express different invariants of simplicial complexes and related combinatorial-geometrical objects in terms of the bigraded cohomology rings of the corresponding moment-angle complexes. Finally, we show that the new relationships between combinatorics, geometry and topology result in solutions to some well-known topological problems.

## CONTENTS

Introduction	2
1. Algebraic, combinatorial and geometrical background	3
1.1. Polytopes	3
1.2. Simplicial complexes: topology and combinatorics	12
1.3. Simplicial complexes: commutative algebra	16
1.4. Homological properties of face rings (Stanley–Reisner rings)	19
1.5. Cubical complexes and cubical maps	24
2. Toric and quasitoric manifolds	29
2.1. Toric varieties	29
2.2. Quasitoric manifolds	33
2.3. Stably complex structures and quasitoric representatives in cobordism classes	38
2.4. Combinatorial formulae for Hirzebruch genera of quasitoric manifolds	41
2.5. The classification problem for quasitoric manifolds over a given simple polytope	47
3. Moment-angle complexes	48
3.1. Moment-angle manifolds $\mathcal{Z}_P$ defined by simple polytopes	48

---

1991 *Mathematics Subject Classification*. 52B70, 57Q15, 57R19, 14M25, 52B05, 13F55, 05B35.

Partially supported by the Russian Foundation for Fundamental Research, grant no. 99-01-00090.

3.2.	General moment-angle complexes	51
3.3.	Cellular structures on moment-angle complexes	52
3.4.	Borel construction and Stanley–Reisner space	54
3.5.	Generalisations, analogues and additional comments	57
4.	Cohomology of moment-angle complexes and combinatorics of simplicial manifolds	58
4.1.	Eilenberg–Moore spectral sequence	58
4.2.	Cohomology of moment-angle complex $\mathcal{Z}_K$ : the case of general $K$	60
4.3.	Cohomology of moment-angle complex $\mathcal{Z}_K$ : the case of spherical $K$	67
4.4.	Partial quotients of manifold $\mathcal{Z}_P$	69
4.5.	Bigraded Poincaré duality and analogues of Dehn–Sommerville equations for simplicial manifolds	73
5.	Subspace arrangements and cohomology rings of their complements	77
5.1.	Summary of results on the cohomology of general arrangement complements	77
5.2.	Coordinate subspace arrangements and cohomology of $\mathcal{Z}_K$ .	79
5.3.	Diagonal subspace arrangements and cohomology of loop space $\Omega\mathcal{Z}_K$ .	84
	References	86

## INTRODUCTION

We survey the results and open problems in the vast field, which was being shaped during the last two decades and incorporated various aspects of combinatorics of polytopes, combinatorial and algebraic topology, homological algebra, group actions on topological spaces, algebraic geometry of toric varieties and symplectic geometry. The main aim of this review is to show that the theory of moment-angle complexes proposed by the authors allows to substantially extend the relationships between the above listed branches of mathematical science and thereby obtain solutions to some well-known problems. Each section of the survey refers to a separate subject and contains the necessary introductory remarks. Below we schematically overview the contents of the article; this can be considered as the guide to the whole survey.

Chapter 1 contains the necessary combinatorial, geometrical and topological facts about polytopes, simplicial and cubical complexes and manifolds. We describe both classical and original constructions, which allow to study the combinatorial objects by methods of commutative and homological algebra.

Section 1 of chapter 2 is the overview of constructions and results on algebraic toric varieties and related combinatorial objects, which are necessary for the rest of the paper. In section 2.2 we describe the topological analogues of toric varieties, the quasitoric manifolds introduced by Davis and Januszkiewicz. The main construction and results about the quasitoric manifolds can be also found there. In section 2.3 we present the solution to the quasitoric analogue of the Hirzebruch problem about connected representatives in the cobordism classes of stably complex manifolds, which was recently obtained by Buchstaber and Ray. In section 2.4 we give the obtained by Panov combinatorial formulae for Hirzebruch genera of quasitoric manifolds. The last section of chapter 2 describes the known results on the classification of toric and quasitoric manifolds over a given simple polytope.

The theory of moment-angle complexes being developed by the authors is the subject of chapters 3 and 4. To each simplicial complex  $K$  with  $m$  vertices there is assigned the moment-angle complex  $\mathcal{Z}_K$  (see section 3.2). The complex  $\mathcal{Z}_K$  carries a canonical action of the torus  $T^m$  with quotient the cone over  $K$  and possesses the canonical bigraded cellular decomposition (see section 3.3). A series of important results of the theory arises from the fact that  $\mathcal{Z}_K$  is a manifold provided that  $K$  is a simplicial sphere. At the same time in the more general case of simplicial manifold  $K$  the singular points of  $\mathcal{Z}_K$  form an orbit of the torus action, and the complement of the neighbourhood of this orbit is a manifold with boundary. Using the bigraded cellular structure, in chapter 4 we calculate the bigraded cohomology ring of the moment-angle complex  $\mathcal{Z}_K$ . This calculation reveals new relationships with some well-known constructions from homological algebra and opens the way to solution of many combinatorial problems.

In chapter 5 we apply the theory of moment-angle complexes to the well-known problem of calculation the cohomology of subspace arrangement complements. We concentrate on coordinate subspace arrangements and diagonal subspace arrangements (sections 5.2 and 5.3 correspondingly) and survey the results obtained by the authors in this direction. In particular, we calculate the cohomology ring of the complement of a coordinate subspace arrangement by reducing to the cohomology of the moment-angle complex  $\mathcal{Z}_K$ . We also reduce the problem of calculating the cohomology of the diagonal subspace arrangement complement to calculating the cohomology of the loop space  $\Omega\mathcal{Z}_K$ .

Almost all new concepts in our survey are provided by the corresponding examples. We also give a lot of examples of particular computations, which illustrate the general theorems. All the results in our paper are of three types. Firstly, interpretations of classical results, which sometimes are given without references. Secondly, results of other authors, which are always provided by the corresponding references. And thirdly, results that either have been obtained recently by the present authors, or are extensions of results from the authors papers [19]–[23], [68], [69] and papers [25], [26] by N. Ray and the first author.

The authors wish to express special thanks to Levan Alania, Yusuf Civan, Natalia Dobrinskaya, Nikolai Dolbilin, Mikhail Farber, Ivan Izmetiev, Oleg Musin, Sergey Novikov, Nigel Ray, Elmer Rees, Mikhail Shtan'ko, Mikhail Shtogrin, Vladimir Smirnov, Neil Strickland, Sergey Tarasov, Victor Vassiliev, Volkmar Welker, Sergey Yuzvinsky, Günter Ziegler for the insight gained from numerous discussions of different questions relevant to the survey. We also grateful to all participants of the seminar “Topology and computational geometry” being held by O. R. Musin and the authors at the Department of Mathematics and Mechanics, Moscow State University.

## 1. ALGEBRAIC, COMBINATORIAL AND GEOMETRICAL BACKGROUND

**1.1. Polytopes.** Both combinatorial and geometrical aspects of the theory of convex polytopes are exposed in a vast number of textbooks, monographs and papers. We just mention Ziegler’s book [89], where a host of further references can be found. In this section we review some basic concepts and constructions used in the rest of the paper.

There are two different ways to define a convex polytope in  $n$ -dimensional affine space  $\mathbb{R}^n$ .

**Definition 1.1.1.** A *convex polytope* is the convex hull of a finite set of points in some  $\mathbb{R}^n$ .

**Definition 1.1.2.** A *convex polyhedron*  $P$  is an intersection of finitely many half-spaces in some  $\mathbb{R}^n$ :

$$(1) \quad P = \{ \mathbf{x} \in \mathbb{R}^n : \langle \mathbf{l}_i, \mathbf{x} \rangle \geq -a_i, i = 1, \dots, m \},$$

where  $\mathbf{l}_i \in (\mathbb{R}^n)^*$ ,  $i = 1, \dots, m$ , are some linear functions and  $a_i \in \mathbb{R}$ . A (*convex*) *polytope* is a bounded convex polyhedron.

Nevertheless, the above two definitions produce the same geometrical object, i.e. the subset of  $\mathbb{R}^n$  is a convex hull of a finite point set if and only if it is a bounded intersection of finitely many half-spaces. This fact is proved in many textbooks on polytopes and convex geometry, see e.g. [89, Theorem 1.1].

The *dimension* of a polytope is the dimension of its affine hull; without loss of generality we may consider only  $n$ -dimensional polytopes  $P^n$  in  $n$ -dimensional space  $\mathbb{R}^n$ . A *supporting hyperplane* of  $P^n$  is an affine hyperplane  $H$  which intersects  $P^n$  and for which the polytope is contained in one of the two closed half-spaces determined by the hyperplane. The intersection  $P^n \cap H$  is a *face* of the polytope. We also regard the polytope  $P^n$  itself as a face; other faces are called *proper faces*. The *boundary*  $\partial P^n$  is the union of all proper faces of  $P^n$ . Each face of  $n$ -dimensional polytope  $P^n$  is itself a polytope of dimension  $\leq n$ . 0-dimensional faces are called *vertices*, 1-dimensional faces are called *edges*, and codimension one faces are called *facets*. The faces of  $P^n$  of all dimensions form a partially ordered set (*poset*) with respect to the inclusion. This poset is called the *face lattice* of  $P^n$ .

Two polytopes  $P_1 \in \mathbb{R}^{n_1}$  and  $P_2 \in \mathbb{R}^{n_2}$  of the same dimension are said to be *affinely equivalent* if there is an affine map  $\mathbb{R}^{n_1} \rightarrow \mathbb{R}^{n_2}$  taking one polytope to another. Two polytopes are *combinatorially equivalent* if there is a bijection between their faces that preserves the inclusion relation. In other words, two polytopes are combinatorially equivalent if their face lattices are isomorphic as posets.

**Example 1.1.3** (simplex and cube). An  $n$ -dimensional *simplex*  $\Delta^n$  is the convex hull of  $(n + 1)$  points of  $\mathbb{R}^n$  that do not lie on a common affine hyperplane. All faces of an  $n$ -simplex are simplices of dimension  $\leq n$ . All  $n$ -simplices are affinely equivalent. The *standard*  $n$ -simplex is the convex hull of points  $(1, 0, \dots, 0)$ ,  $(0, 1, \dots, 0), \dots, (0, \dots, 0, 1)$ , and  $(0, \dots, 0)$  in  $\mathbb{R}^n$ . Alternatively, the standard  $n$ -simplex is defined by  $(n + 1)$  inequalities

$$(2) \quad x_i \geq 0, i = 1, \dots, n, \quad \text{and} \quad -x_1 - \dots - x_n \geq -1.$$

The *regular*  $n$ -simplex is the convex hull of  $n + 1$  points  $(1, 0, \dots, 0)$ ,  $(0, 1, \dots, 0)$ ,  $\dots$ ,  $(0, \dots, 0, 1)$  in  $\mathbb{R}^{n+1}$ .

The *standard*  $q$ -cube is the convex polytope  $I^q \subset \mathbb{R}^q$  defined by

$$(3) \quad I^q = \{ (y_1, \dots, y_q) \in \mathbb{R}^q : 0 \leq y_i \leq 1, i = 1, \dots, q \}.$$

Alternatively, the standard  $q$ -cube is the convex hull of  $2^q$  points in  $\mathbb{R}^q$  having only zero and unit coordinates.

The following construction identifies a convex  $n$ -polytope with  $m$  facets as the intersection of the positive cone

$$(4) \quad \mathbb{R}_+^m = \{ (y_1, \dots, y_m) \in \mathbb{R}^m : y_i \geq 0, i = 1, \dots, m \} \subset \mathbb{R}^m$$

with a certain  $n$ -dimensional plane.

**Construction 1.1.4.** Let  $P \in \mathbb{R}^n$  be a convex  $n$ -polytope given by (1) with some  $\mathbf{l}_i \in (\mathbb{R}^n)^*$ ,  $a_i \in \mathbb{R}$ ,  $i = 1, \dots, m$ . Introduce  $n \times m$ -matrix  $L$  whose columns are vectors  $\mathbf{l}_i$  written in the standard basis of  $(\mathbb{R}^n)^*$ , i.e.  $(L)_{ji} = (\mathbf{l}_i)_j$ . Note that  $L$  is of rank  $n$ . Likewise, let  $\mathbf{a} = (a_1, \dots, a_m)^t \in \mathbb{R}^m$  be the column vector with entries  $a_i$ . Then (1) shows that

$$(5) \quad P = \{ \mathbf{x} \in \mathbb{R}^n : (L^t \mathbf{x} + \mathbf{a})_i \geq 0, i = 1, \dots, m \},$$

where  $L^t$  is the transposed matrix and  $\mathbf{x} = (x_1, \dots, x_n)^t$  is the column vector. Consider the affine map

$$(6) \quad A_P : \mathbb{R}^n \rightarrow \mathbb{R}^m, \quad A_P(\mathbf{x}) = L^t \mathbf{x} + \mathbf{a} \in \mathbb{R}^m.$$

Its image is an  $n$ -dimensional plane in  $\mathbb{R}^m$ , and (5) shows that  $A_P(P)$  is the intersection of this plane with the positive cone  $\mathbb{R}_+^m$ . Now, let  $W$  be an  $m \times (m - n)$ -matrix of rank  $(m - n)$  such that  $LW = 0$ . Then it is easy to see that

$$A_P(P) = \{ \mathbf{y} \in \mathbb{R}^m : W^t \mathbf{y} = W^t \mathbf{a}, y_i \geq 0, i = 1, \dots, m \}.$$

Note that the polytopes  $P$  and  $A_P(P)$  are affinely equivalent.

**Example 1.1.5.** Consider the standard  $n$ -simplex  $\Delta^n \subset \mathbb{R}^n$  defined by inequalities (2). It has  $m = n + 1$  facets, and  $\mathbf{l}_1 = (1, 0, \dots, 0)^t, \dots, \mathbf{l}_n = (0, \dots, 0, 1)^t, \mathbf{l}_{n+1} = (-1, \dots, -1)^t, a_1 = \dots = a_n = 0, a_{n+1} = 1$  (see (1)). One can take  $W = (1, \dots, 1)^t$  in Construction 1.1.4. Hence,  $W^t \mathbf{y} = y_1 + \dots + y_m, W^t \mathbf{a} = 1$ , and we have

$$A_{\Delta^n}(\Delta^n) = \{ \mathbf{y} \in \mathbb{R}^{n+1} : y_1 + \dots + y_{n+1} = 1, y_i \geq 0, i = 1, \dots, n \}.$$

This is the regular  $n$ -simplex in  $\mathbb{R}^{n+1}$ .

*Remark.* Convex polytopes introduced in definitions 1.1.1 and 1.1.2 are *geometrical* objects. However, one could also consider *combinatorial* polytopes which are classes of combinatorially equivalent polytopes. In fact, a combinatorial polytope is the face lattice (regarded as a poset) of a (geometrical) polytope. In this review we deal with both geometrical and combinatorial polytopes.

Two different definitions of a convex polytope lead to two different notions of *generic* polytopes.

A set of  $m > n$  points in  $\mathbb{R}^n$  is in *general position* if no  $(n + 1)$  of them lie on a common affine hyperplane. From the viewpoint of Definition 1.1.1, the convex polytope is generic if it is the convex hull of a set of points in general position. This implies that all proper faces of the polytope are simplices, i.e. every facet has the minimal number of vertices (namely,  $n$ ). Such polytopes are called *simplicial*.

A set of  $m > n$  hyperplanes  $\langle \mathbf{l}_i, \mathbf{x} \rangle = -a_i, \mathbf{l}_i \in (\mathbb{R}^n)^*, \mathbf{x} \in \mathbb{R}^n, a_i \in \mathbb{R}, i = 1, \dots, m$ , is in *general position* if no point lies in more than  $n$  of them. From the viewpoint of Definition 1.1.2, the convex polytope  $P^n$  is generic if its bounding hyperplanes (see (1)) are in general position, i.e. there exactly  $n$  facets meet at each vertex of  $P^n$ . Such polytopes are called *simple*.

For any convex polytope  $P \subset \mathbb{R}^n$  define its *polar set*  $P^* \subset (\mathbb{R}^n)^*$  as

$$P^* = \{ \mathbf{x}' \in (\mathbb{R}^n)^* : \langle \mathbf{x}', \mathbf{x} \rangle \geq -1 \text{ for all } \mathbf{x} \in P \}.$$

*Remark.* Our definition of the polar set is that used in the algebraic geometry of toric varieties, not the classical one from the convex geometry. The latter is obtained by replacing the inequality “ $\geq -1$ ” above by “ $\leq 1$ ”. One polar set is taken into another by the symmetry with centre in 0.

It is well known in convex geometry that the polar set  $P^*$  is a convex polytope in the dual space  $(\mathbb{R}^n)^*$  and  $(P^*)^* = P$  provided that  $0 \in P$ . The polytope  $P^*$  is called the *polar* (or *dual*) of  $P$ . Moreover, there is a one-to-one order reversing correspondence between face lattices of  $P$  and  $P^*$ . In particular, if  $P$  is simple, then  $P^*$  is simplicial, and vice versa.

**Example 1.1.6.** Any polygon (2-polytope) is simple and simplicial at the same time. In dimensions  $\geq 3$  only polytope that is simultaneously simple and simplicial is the simplex. The cube is a simple polytope. The polar of a simplex is again a simplex. The polar of the cube is called the *cross-polytope*. The 3-dimensional cross-polytope is the octahedron.

In the sequel simple polytopes are denoted by the Latin letters  $P, Q$  etc., while simplicial ones are denoted by the same letters with asterisque:  $P^*, Q^*$  etc.

Each face of a simple polytope is a simple polytope. The *product*  $P_1 \times P_2$  of two simple polytopes  $P_1$  and  $P_2$  is a simple polytope as well. Let  $P_1^*$  and  $P_2^*$  be the corresponding polar simplicial polytopes. Then  $P_1^* \circ P_2^* := (P_1 \times P_2)^*$  is again a simplicial polytope. The operation  $\circ$  on simplicial polytopes can be directly described as follows. Realise  $P_1^*$  in  $\mathbb{R}^{n_1}$  and  $P_2^*$  in  $\mathbb{R}^{n_2}$  in such way that  $0 \in P_1^*$  and  $0 \in P_2^*$ . Then  $P_1^* \circ P_2^* \subset \mathbb{R}^{n_1} \times \mathbb{R}^{n_2}$  is the convex hull of the union of  $P_1^* \subset \mathbb{R}^{n_1} \times 0$  and  $P_2^* \subset 0 \times \mathbb{R}^{n_2}$ .

**Construction 1.1.7** (Connected sum of two simple polytopes). Suppose we are given two simple polytopes  $P^n$  and  $Q^n$ , both of dimension  $n$ , with distinguished vertices  $v$  and  $w$  respectively. The informal way to get the *connected sum*  $P^n \#_{v,w} Q^n$  of  $P^n$  at  $v$  and  $Q^n$  at  $w$  is as follows. We “cut off”  $v$  from  $P^n$  and  $w$  from  $Q^n$ ; then, after a projective transformation, we can “glue” the rest of  $P^n$  to the rest of  $Q^n$  along the new facets to obtain  $P^n \#_{v,w} Q^n$ . Below we give the formal definition, following [26, §6]; this definition will be used later.

First, we introduce an  $n$ -polyhedron  $\Gamma^n$ , which will be used as a template for the construction; it arises by considering the standard  $(n-1)$ -simplex  $\Delta^{n-1}$  in the subspace  $\{x : x_1 = 0\}$  of  $\mathbb{R}^n$ , and taking its cartesian product with the first coordinate axis. The facets  $G_r$  of  $\Gamma^n$  therefore have the form  $\mathbb{R} \times D_r$ , where  $D_r$ ,  $1 \leq r \leq n$ , are the faces of  $\Delta^{n-1}$ . Both  $\Gamma^n$  and the  $G_r$  are divided into positive and negative halves, determined by the sign of the coordinate  $x_1$ .

We order the facets of  $P^n$  meeting in  $v$  as  $E_1, \dots, E_n$ , and the facets of  $Q^n$  meeting in  $w$  as  $F_1, \dots, F_n$ . Denote the complementary sets of facets by  $\mathcal{C}_v$  and  $\mathcal{C}_w$ ; those in  $\mathcal{C}_v$  avoid  $v$ , and those in  $\mathcal{C}_w$  avoid  $w$ .

We now choose projective transformations  $\phi_P$  and  $\phi_Q$  of  $\mathbb{R}^n$ , whose purpose is to map  $v$  and  $w$  to  $x_1 = \pm\infty$  respectively. We insist that  $\phi_P$  embeds  $P^n$  in  $\Gamma^n$  so as to satisfy two conditions; firstly, that the hyperplane defining  $E_r$  is identified with the hyperplane defining  $G_r$ , for each  $1 \leq r \leq n$ , and secondly, that the images of the hyperplanes defining  $\mathcal{C}_v$  meet  $\Gamma^n$  in its negative half. Similarly,  $\phi_Q$  identifies the hyperplane defining  $F_r$  with that defining  $G_r$ , for each  $1 \leq r \leq n$ , but the images of the hyperplanes defining  $\mathcal{C}_w$  meet  $\Gamma^n$  in its positive half. We define the *connected sum*  $P^n \#_{v,w} Q^n$  of  $P^n$  at  $v$  and  $Q^n$  at  $w$  to be the simple convex  $n$ -polytope determined by the images of the hyperplanes defining  $\mathcal{C}_v$  and  $\mathcal{C}_w$  and hyperplanes defining  $G_r$ ,  $r = 1, \dots, n$ . It is defined only up to combinatorial equivalence; moreover, different choices for either of  $v$  and  $w$ , or either of the orderings for  $E_r$  and  $F_r$ , are likely to affect the combinatorial type. When

the choices are clear, or their effect on the result irrelevant, we use the abbreviation  $P^n \# Q^n$ .

The related construction of connected sum  $P \# Q^*$  of a simple polytope  $P$  and a simplicial polytope  $Q^*$  is described in [89, Example 8.41].

A simplicial polytope  $P^*$  is called *k-neighbourly* if any  $k$  vertices span a face of  $P^*$ . Likewise, a simple polytope  $P$  is called *k-neighbourly* if any  $k$  facets of  $P$  have non-empty intersection (i.e. share a common codimension- $k$  face). Obviously, every simplicial (or simple) polytope is 1-neighbourly. It can be shown ([18, Corollary 14.5], see also Example 1.1.15 below) that if  $P^*$  is a *k-neighbourly* simplicial  $n$ -polytope and  $k > \lfloor \frac{n}{2} \rfloor$ , then  $P^*$  is an  $n$ -simplex. In particular, any 2-neighbourly simplicial 3-polytope is a simplex. However, there exist simplicial  $n$ -polytopes with any number of vertices which are  $\lfloor \frac{n}{2} \rfloor$ -neighbourly. Such polytopes are called *neighbourly*. In particular, there exist a simplicial 4-polytope (different from 4-simplex) any two vertexes of which are connected by an edge.

**Example 1.1.8** (neighbourly 4-polytope). Let  $P = \Delta^2 \times \Delta^2$  be the product of two triangles. Then  $P$  is a simple polytope, and it is easy to see that any two facets of  $P$  share a common 2-face. Hence,  $P$  is 2-neighbourly. The polar  $P^*$  is a neighbourly simplicial 4-polytope.

More generally, it is easy to see that if a simple polytope  $P_1$  is  $k_1$ -neighbourly and a simple polytope  $P_2$  is  $k_2$ -neighbourly, then the product  $P_1 \times P_2$  is a  $\min(k_1, k_2)$ -neighbourly simple polytope. It follows that  $(\Delta^n \times \Delta^n)^*$  and  $(\Delta^n \times \Delta^{n+1})^*$  provide examples of neighbourly simplicial  $2n$ - and  $(2n + 1)$ -polytopes. Another example of neighbourly polytopes, with arbitrary number of vertices, is as follows.

**Example 1.1.9** (cyclic polytopes). Define the *moment curve* in  $\mathbb{R}^n$  as

$$\mathbf{x} : \mathbb{R} \longrightarrow \mathbb{R}^n, \quad t \mapsto \mathbf{x}(t) = (t, t^2, \dots, t^n) \in \mathbb{R}^n.$$

For any  $m > n$  define the *cyclic polytope*  $C^n(t_1, \dots, t_m)$  as the convex hull of  $m$  distinct points  $\mathbf{x}(t_i)$ ,  $t_1 < t_2 < \dots < t_m$ , on the moment curve. It follows from the Vandermonde determinant identity that no  $n + 1$  points on the moment curve lie on a common affine hyperplane. Hence,  $C^n(t_1, \dots, t_m)$  is a simplicial  $n$ -polytope. It can be shown (see [89, Theorem 0.7]) that  $C^n(t_1, \dots, t_m)$  has exactly  $m$  vertices  $\mathbf{x}(t_i)$ , the combinatorial type of cyclic polytope does not depend on the specific choice of the parameters  $t_1, \dots, t_m$ , and  $C^n(t_1, \dots, t_m)$  is a neighbourly simplicial  $n$ -polytope. We denote the combinatorial cyclic  $n$ -polytope with  $m$  vertices by  $C^n(m)$ .

Let  $P$  be a simple  $n$ -polytope. Denote by  $f_i$  the number of faces of  $P$  of codimension  $(i + 1)$  (i.e. of dimension  $(n - i - 1)$ ). In particular,  $f_0$  is the number of facets of  $P$ , which we will denote  $m(P)$  or just  $m$ .

**Definition 1.1.10.** The integer vector  $\mathbf{f}(P) = (f_0, \dots, f_{n-1})$  is called the *f-vector* of simple polytope  $P$ . The integer vector  $(h_0, h_1, \dots, h_n)$  whose components  $h_i$  are defined from the equation

$$(7) \quad h_0 t^n + \dots + h_{n-1} t + h_n = (t - 1)^n + f_0 (t - 1)^{n-1} + \dots + f_{n-1}$$

is called the *h-vector* of  $P$ . Finally, the integer vector  $(g_0, g_1, \dots, g_{\lfloor \frac{n}{2} \rfloor})$ , where  $g_0 = 1$ ,  $g_i = h_i - h_{i-1}$ ,  $i > 0$ , is called the *g-vector* of  $P$ .

We also put  $f_{-1} = 1$ , which means that the polytope itself is a face of codimension 0. The  $f$ -vector and the  $h$ -vector determine each other by means of linear relations, namely

$$(8) \quad h_k = \sum_{i=0}^k (-1)^{k-i} \binom{n-i}{n-k} f_{i-1}, \quad f_{n-1-k} = \sum_{q=k}^n \binom{q}{k} h_{n-q}, \quad k = 0, \dots, n.$$

In particular,  $h_0 = 1$  and  $h_n = (-1)^n (1 - f_0 + f_1 + \dots + (-1)^n f_{n-1})$ . By Euler's theorem,

$$(9) \quad f_0 - f_1 + \dots + (-1)^{n-1} f_{n-1} = 1 + (-1)^{n-1},$$

which is equivalent to  $h_n = 1 = h_0$ . In the case of simple polytopes Euler's theorem admits the following generalisation.

**Theorem 1.1.11** (Dehn–Sommerville relations). *The  $h$ -vector of any simple  $n$ -polytope is symmetric, i.e.*

$$h_i = h_{n-i}, \quad i = 0, 1, \dots, n.$$

There are a lot of different ways to prove the Dehn–Sommerville equation. We present a proof which uses a Morse-theoretical argument, firstly appeared in [18]. We will return to this argument in chapter 2.

*Proof of Theorem 1.1.11.* Let  $P^n \subset \mathbb{R}^n$  be a simple polytope. Choose a linear function  $\varphi : \mathbb{R}^n \rightarrow \mathbb{R}$  which is generic, that is, it takes different values at all vertices of  $P^n$ . For this  $\varphi$  there is a vector  $\boldsymbol{\nu}$  in  $\mathbb{R}^n$  such that  $\varphi(\boldsymbol{x}) = \langle \boldsymbol{\nu}, \boldsymbol{x} \rangle$ . Note that  $\boldsymbol{\nu}$  is parallel to no edge of  $P^n$ . Now we view  $\varphi$  as a height function on  $P^n$ . Using  $\varphi$ , we make the 1-skeleton of  $P^n$  a directed graph by orienting each edge in such a way that  $\varphi$  increases along it (this can be done since  $\varphi$  is generic). For each vertex  $v$  of  $P^n$  define its index,  $\text{ind}(v)$ , as the number of incident edges that point towards  $v$ . Denote the number of vertices of index  $i$  by  $I_\nu(i)$ . We claim that  $I_\nu(i) = h_{n-i}$ . Indeed, each face of  $P^n$  has a unique top vertex (a maximum of the height function  $\varphi$  restricted to the face) and a unique bottom vertex (the minimum of  $\varphi$ ). Let  $F^k$  be a  $k$ -face of  $P^n$ , and  $v_F$  its top vertex. Since  $P^n$  is simple, there exactly  $k$  edges of  $F^k$  meet at  $v_F$ , whence  $\text{ind}(v_F) \geq k$ . On the other hand, each vertex of index  $q \geq k$  is the top vertex for exactly  $\binom{q}{k}$  faces of dimension  $k$ . It follows that  $f_{n-1-k}$  (the number of  $k$ -faces) can be calculated as

$$f_{n-1-k} = \sum_{q \geq k} \binom{q}{k} I_\nu(q).$$

Now, the second identity from (8) shows that  $I_\nu(q) = h_{n-q}$ , as claimed. In particular, the number  $I_\nu(q)$  does not depend on  $\boldsymbol{\nu}$ . On the other hand, since  $\text{ind}_\nu(v) = n - \text{ind}_{-\nu}(v)$  for any vertex  $v$ , one has

$$h_{n-q} = I_\nu(q) = I_{-\nu}(n-q) = h_q.$$

□

Using (8), we can rewrite the Dehn–Sommerville equations in terms of the  $f$ -vector as follows

$$(10) \quad f_{k-1} = \sum_{j=k}^n (-1)^{n-j} \binom{j}{k} f_{j-1}, \quad k = 0, 1, \dots, n.$$



The Dehn–Sommerville equations were established by Dehn for  $n \leq 5$  in 1905, and by Sommerville in the general case in 1927 (see [77]) in the form similar to (10).

**Example 1.1.12.** Let  $P_1^{n_1}$  and  $P_2^{n_2}$  be simple polytopes. Any face of  $P_1 \times P_2$  is the product of a face of  $P_1$  and a face of  $P_2$ , whence

$$f_k(P_1 \times P_2) = \sum_{i=-1}^{n_1-1} f_i(P_1) f_{k-i-1}(P_2), \quad k = -1, 0, \dots, n_1 + n_2 - 1.$$

Set  $h(P; t) = h_0 + h_1 t + \dots + h_n t^n$ . Then it follows from the above formula and (7) that

$$(11) \quad h(P_1 \times P_2; t) = h(P_1; t) h(P_2; t).$$

**Example 1.1.13.** Let us express the  $f$ -vector and the  $h$ -vector of the connected sum  $P^n \# Q^n$  in terms of that of  $P^n$  and  $Q^n$ . It follows from Construction 1.1.7 that

$$\begin{aligned} f_i(P^n \# Q^n) &= f_i(P^n) + f_i(Q^n) - \binom{n}{i+1}, \quad i = 0, 1, \dots, n-2; \\ f_{n-1}(P^n \# Q^n) &= f_{n-1}(P^n) + f_{n-1}(Q^n) - 2 \end{aligned}$$

(note that  $\binom{n}{i+1} = f_i(\Delta^{n-1})$ ). Then it follows from (8) that

$$\begin{aligned} h_0(P^n \# Q^n) &= h_n(P^n \# Q^n) = 1; \\ h_i(P^n \# Q^n) &= h_i(P^n) + h_i(Q^n), \quad i = 1, 2, \dots, n-1. \end{aligned}$$

Thus,  $h_i$ ,  $i = 1, \dots, n-1$ , define integer-valued functions on the set of simple polytopes which are linear with respect to the connected sum operation.

**Problem 1.1.14.** Describe all integer-valued functions on the set of simple polytopes which are linear with respect to the connected sum operation.

The  $f$ -vector of a simplicial polytope  $P^*$  is defined as  $\mathbf{f}(P^*) = (f_0, f_1, \dots, f_{n-1})$ , where  $f_i$  is the number of  $i$ -faces ( $i$ -simplices) of  $P^*$ . The  $h$ -vector  $h(P^*) = (h_0, h_1, \dots, h_n)$  is determined by identity (7). Note that if  $P^*$  is the simplicial polytope polar to a simple polytope  $P$ , then  $f_i(P^*) = f_i(P)$ . In particular, the Dehn–Sommerville equations hold for simplicial polytopes as well.

**Example 1.1.15.** Suppose  $P^*$  is a  $q$ -neighbourly simplicial  $n$ -polytope. Then  $f_{k-1}(P^*) = \binom{m}{k}$ ,  $k \leq q$ . From (8) we obtain

$$(12) \quad h_k(P^*) = \sum_{i=0}^k (-1)^{k-i} \binom{n-i}{k-i} \binom{m}{i} = \binom{m-n+k-1}{k}, \quad k \leq q.$$

(The last identity is obtained by calculating the coefficient of  $t^k$  from two sides of  $\frac{1}{(1+t)^{n-k+1}}(1+t)^m = (1+t)^{m-n+k-1}$ .) Suppose that  $P^*$  is not a simplex. Then  $m > n+1$ , which together with (12) gives  $h_0 < h_1 < \dots < h_q$ . It follows from the Dehn–Sommerville equations that  $q \leq \lfloor \frac{n}{2} \rfloor$ .

A natural question arises: which integer vectors may appear as the  $f$ -vectors of simple (or, equivalently, simplicial) polytopes? The Dehn–Sommerville relations provide a necessary condition.

**Proposition 1.1.16** ([52]). *The Dehn–Sommerville relations are the most general linear equations satisfied by the  $f$ -vectors of all simple (or simplicial) polytopes.*

*Proof.* In [52] the statement was proved directly, using  $f$ -vectors. Instead, we use  $h$ -vectors, which somewhat simplifies the proof. It is sufficient to prove that the affine hull of the  $h$ -vectors  $(h_0, h_1, \dots, h_n)$  of simple  $n$ -polytopes is an  $\lfloor \frac{n}{2} \rfloor$ -dimensional plane. Set  $Q_k := \Delta^k \times \Delta^{n-k}$ ,  $k = 0, 1, \dots, \lfloor \frac{n}{2} \rfloor$ . Since  $\mathbf{h}(\Delta^k) = 1 + t + \dots + t^k$ , the formula (11) gives

$$\mathbf{h}(Q_k) = \frac{1 - t^{k+1}}{1 - t} \cdot \frac{1 - t^{n-k+1}}{1 - t}.$$

It follows that  $\mathbf{h}(Q_{k+1}) - \mathbf{h}(Q_k) = t^{k+1} + \dots$ ,  $k = 0, 1, \dots, \lfloor \frac{n}{2} \rfloor - 1$ . Therefore, the vectors  $\mathbf{h}(Q_k)$ ,  $k = 0, 1, \dots, \lfloor \frac{n}{2} \rfloor$ , are affinely independent.  $\square$

We mention also that the identity (9) is the only linear relation satisfied by the vectors of face numbers of *general* convex polytopes.

The conditions characterising the  $f$ -vectors of simple (or simplicial) polytopes, now known as the  $g$ -theorem, were conjectured by McMullen [58] in 1970 and proved by Stanley [79] (necessity) and Billera, Lee [13] (sufficiency) in 1980. Besides the Dehn–Sommerville equations, the  $g$ -theorem contains two groups of inequalities, one linear and one non-linear. To state the  $g$ -theorem completely, we need the following construction. For any two positive integers  $a, i$  there exists a unique *binomial  $i$ -expansion* of  $a$  of the form

$$a = \binom{a_i}{i} + \binom{a_{i-1}}{i-1} + \dots + \binom{a_j}{j},$$

where  $a_i > a_{i-1} > \dots > a_j \geq j \geq 1$ . Define

$$a^{(i)} = \binom{a_i+1}{i+1} + \binom{a_{i-1}+1}{i} + \dots + \binom{a_j+1}{j+1}, \quad 0^{(i)} = 0.$$

**Theorem 1.1.17** ( $g$ -theorem). *An integer vector  $(f_0, f_1, \dots, f_{n-1})$  is the  $f$ -vector of a simple  $n$ -polytope if and only if the corresponding sequence  $(h_0, \dots, h_n)$  determined by (7) satisfies the following three conditions:*

- (a)  $h_i = h_{n-i}$ ,  $i = 0, \dots, n$  (the Dehn–Sommerville equations);
- (b)  $h_0 \leq h_1 \leq \dots \leq h_{\lfloor \frac{n}{2} \rfloor}$ , i.e.  $g_i \geq 0$ ,  $i = 0, 1, \dots, \lfloor \frac{n}{2} \rfloor$ .
- (c)  $h_0 = 1$ ,  $h_{i+1} - h_i \leq (h_i - h_{i-1})^{(i)}$ , i.e.  $g_{i+1} \leq g_i^{(i)}$ ,  $i = 1, \dots, \lfloor \frac{n}{2} \rfloor - 1$ .

*Remark.* Obviously, the same conditions characterise the  $f$ -vectors of *simplicial* polytopes.

An integral sequence  $(k_0, k_1, \dots, k_r)$  satisfying  $k_0 = 1$  and  $0 \leq k_{i+1} \leq k_i^{(i)}$  for  $i = 1, \dots, r-1$  is called an  $M$ -vector (after M. Macaulay). Conditions (b) and (c) from the  $g$ -theorem imply that the  $g$ -vector  $(g_0, g_1, \dots, g_{\lfloor \frac{n}{2} \rfloor})$  of a simple  $n$ -polytope is an  $M$ -vector. On the other hand, the notion of  $M$ -vector appears in the following classification result of commutative algebra.

**Theorem 1.1.18** (Macaulay). *An integral sequence  $(k_0, k_1, \dots, k_r)$  is an  $M$ -vector if and only if there exists a commutative graded algebra  $A = A^0 \oplus A^2 \oplus \dots \oplus A^{2r}$  over a field  $\mathbf{k} = A^0$ , generated (as an algebra) by degree-two elements, such that the dimension of  $2i$ -th graded component of  $A$  equals  $k_i$ , i.e.  $\dim_{\mathbf{k}} A^{2i} = k_i$ ,  $i = 1, \dots, r$ .*

The proof can be found in [78].

To prove the sufficiency of the  $g$ -theorem, Billera and Lee presented a remarkable combinatorial-geometrical construction of a simplicial polytope with any prescribed  $M$ -sequence as its  $g$ -vector. Stanley's proof of the necessity of  $g$ -theorem (i.e. that

the  $g$ -vector of a simple polytope is an  $M$ -vector) relies upon deep results from algebraic geometry: the Hard Lefschetz theorem for the cohomology of toric varieties. We give the ideas of Stanley’s proof in section 2.1. After 1995 several more elementary combinatorial proofs of the  $g$ -theorem appeared. The first elementary proof by McMullen [59], which uses the *polytope algebra* instead of the cohomology algebra of toric variety, was still very involved. Recently Timorin [85] found much more simple elementary proof of the  $g$ -theorem, which relies on the interpretation of McMullen’s polytope algebra as the algebra of differential operators (with constant coefficients) vanishing on the *volume polynomial* of the polytope.

It follows from the results of [13] that the part (b) of the  $g$ -theorem, i.e. the inequalities

$$(13) \quad h_0 \leq h_1 \leq \dots \leq h_{\lfloor \frac{n}{2} \rfloor},$$

give the most general linear inequalities satisfied by the  $f$ -vectors of simple (or simplicial) polytopes. These inequalities are now known as the *Generalised Lower Bound Theorem* (GLBT) for simple (simplicial) polytopes. During the last two decades a lot of work was done and progress achieved in extending the Dehn–Sommerville equations, GLBT, and  $g$ -theorem to more general objects than simplicial polytopes. However, there are still a lot of intriguing open problems here. Some of them are presented in the survey article by Stanley [82]. In the present paper we also review some related questions (see the comments in the next section).

The  $g$ -theorem has the following important corollary.

**Theorem 1.1.19** (Upper Bound Theorem (UBT) for simplicial polytopes, [89, Theorem 8.23, Corollary 8.38]). *From all simplicial  $n$ -polytopes  $P^*$  with  $m$  vertices the cyclic polytope  $C^n(m)$  (Example 1.1.9) has the maximal number of  $i$ -faces,  $2 \leq i \leq n - 1$ . That is, if  $f_0(P^*) = m$ , then*

$$f_i(P^*) \leq f_i(C^n(m)), \quad 2 \leq i \leq n - 1.$$

Note that  $f_i(C^n(m)) = \binom{m}{i+1}$  for  $0 \leq i < \lfloor \frac{n}{2} \rfloor$ . The above theorem was conjectured by Motzkin in 1957. It was proved by McMullen in 1970 and motivated him to conjecture the  $g$ -theorem. McMullen showed also that the Upper Bound theorem is equivalent to the following inequalities for the  $h$ -vector  $\mathbf{h}(P^*) = (h_0, h_1, \dots, h_n)$ :

$$h_i(P^*) \leq \binom{m-n+i-1}{i}, \quad 0 \leq i \leq \lfloor \frac{n}{2} \rfloor$$

(compare this with Example 1.1.15).

To conclude these remarks about polytopes, we introduce an important algebraic invariant of a (combinatorial) simple polytope, which appears many times throughout this review. Let  $P$  be a simple  $n$ -polytope with  $m$  facets  $F_1, \dots, F_m$ . Fix a commutative ring  $\mathbf{k}$  with unit. Let  $\mathbf{k}[v_1, \dots, v_m]$  be the polynomial algebra over  $\mathbf{k}$  on  $m$  generators. We make it a graded algebra by setting  $\deg(v_i) = 2$ .

**Definition 1.1.20.** The *face ring* (or the *Stanley–Reisner ring*) of a simple polytope  $P$  is the quotient ring

$$\mathbf{k}(P) = \mathbf{k}[v_1, \dots, v_m] / \mathcal{I}_P,$$

where  $\mathcal{I}_P$  is the ideal generated by all square-free monomials  $v_{i_1} v_{i_2} \dots v_{i_s}$ ,  $i_1 < \dots < i_s$ , such that  $F_{i_1} \cap \dots \cap F_{i_s} = \emptyset$  in  $P$ .

Obviously,  $\mathbf{k}(P)$  is a graded  $\mathbf{k}$ -algebra.

We mention that the Stanley–Reisner ring, the  $f$ -vector, and the  $h$ -vector are invariants of a *combinatorial* simple polytope: they depend only on the face lattice and do not depend on a particular geometrical realisation.

**1.2. Simplicial complexes: topology and combinatorics.** Let  $[m]$  denote the index set  $\{1, \dots, m\}$ . For any subset  $I \subset [m]$  denote by  $\#I$  its cardinality.

**Definition 1.2.1.** An (abstract) *simplicial complex* on the set  $[m]$  is a collection  $K = \{I\}$  of subsets of  $[m]$  such that for each  $I = \{i_1, \dots, i_k\} \in K$  all subsets of  $I$  (including  $\emptyset$ ) also belong to  $K$ . Subsets  $I \in K$  are called (abstract) *simplices* of  $K$ .

Similarly one defines a simplicial complex on any set  $\mathcal{S}$ . One-element subsets from  $K$  are called *vertices* of  $K$ . If  $K$  contains all one-element subsets of  $[m]$ , then we say that  $K$  is a simplicial complex *on the vertex set*  $[m]$ . The *dimension* of an abstract simplex  $I = \{i_1, \dots, i_k\} \in K$  is its cardinality minus one, i.e.  $\dim I = \#I - 1$ . The dimension of an abstract simplicial complex is the maximal dimension of its simplices.

**Definition 1.2.2.** A *geometrical simplicial complex* (or *polyhedron*) is a subset  $\mathcal{P} \subset \mathbb{R}^n$  represented as a union of simplices of any dimensions in such a way that the intersection of any two simplices is a face of each. (By simplices here we mean convex polytopes defined in Example 1.1.3.)

In the sequel we denote by  $\Delta^{m-1}$  both the abstract simplex (i.e. the simplicial complex consisting of *all* subsets of  $[m]$ ) and the corresponding polyhedron.

*Remark.* The notion of polyhedron from Definition 1.1.2 is not the same as that from the above definition. The first meaning of the term “polyhedron” (i.e. the “unbounded polytope”) is adopted in the convex geometry, while the second one (i.e. the “geometrical simplicial complex”) is used in the combinatorial topology. Since both meanings became classical in the appropriate science, we do not change their names. In this review, by “polyhedron” we will usually mean a geometrical simplicial complex. The “unbounded polytope” will be referred to as “convex polyhedron”. Anyway, it will be always clear from the context which “polyhedron” is under consideration.

Only finite geometrical simplicial complexes (polyhedrons) are considered in this review. The dimension of a polyhedron is the maximal dimension of its simplices. It is a classical fact [71] that any  $n$ -dimensional abstract simplicial complex  $K$  admits a *geometrical realisation*  $|K|$  as an  $n$ -dimensional polyhedron in  $\mathbb{R}^{2n+1}$  (abstract simplices of  $K$  correspond to (polytopal) simplices of  $|K|$ ). A geometrical realisation  $|K|$  of an abstract simplicial complex  $K$  is unique up to a piecewise-linear homeomorphism.

**Construction 1.2.3.** One can construct a geometric realisation of a simplicial complex  $K$  on the vertex set  $[m]$  in  $m$ -dimensional space as follows. Let  $e_i$  denote the  $i$ -th unit coordinate vector in  $\mathbb{R}^m$ . For each subset  $I \subset [m]$  denote by  $\Delta_I$  the convex hull of vectors  $e_i$  with  $i \in I$ . Obviously,  $\Delta_I$  is a (geometric) simplex. Then one has

$$|K| = \bigcup_{I \in K} \Delta_I \subset \mathbb{R}^m.$$

A *simplicial map*  $f : |K_1| \rightarrow |K_2|$  of two polyhedrons is any mapping of the set of vertices of  $|K_1|$  to the vertices of  $|K_2|$ , extended linearly on simplices of  $|K_1|$  to

the whole of  $|K_1|$ . A polyhedron  $|K'|$  is called a *subdivision* of polyhedron  $|K|$  if each simplex of  $|K|$  is a union of finitely many simplices of  $|K'|$ . A *piecewise linear (PL) map*  $f : |K_1| \rightarrow |K_2|$  is a map that is simplicial between some subdivisions of  $|K_1|$  and  $|K_2|$ . The standard reference for the *PL* topology is [74].

**Example 1.2.4** (associated simplicial complex). Let  $K$  be a simplicial complex on the set  $[m]$ . Suppose that  $K$  is not the  $(m - 1)$ -simplex. Define

$$\widehat{K} := \{I \subset [m] : [m] \setminus I \notin K\}.$$

Obviously,  $\widehat{K}$  is a simplicial complex on  $[m]$ . It is called the *simplicial complex associated with  $K$* .

**Construction 1.2.5** (join of simplicial complexes). Let  $K_1, K_2$  be simplicial complexes on  $[m_1]$  and  $[m_2]$  respectively. Identify  $[m_1] \cup [m_2]$  with  $[m_1 + m_2]$ . The *join* of  $K_1$  and  $K_2$  is the simplicial complex

$$K_1 * K_2 := \{I \subset [m_1 + m_2] : I = I_1 \cup I_2, I_1 \in K_1, I_2 \in K_2\}$$

on the set  $[m_1 + m_2]$ .

**Example 1.2.6.** 1. If  $K_1 = \Delta^{m_1-1}, K_2 = \Delta^{m_2-1}$ , then  $K_1 * K_2 = \Delta^{m_1+m_2-1}$ .

2. The simplicial complex  $\Delta^0 * K$  (the join of  $K$  and a point) is called the *cone* over  $K$  and denoted  $\text{cone}(K)$ .

3. Let  $S^0$  be disjoint union of two vertices. Then  $S^0 * K$  is called the *suspension* over  $K$  and denoted  $\Sigma K$ .

The geometric realisation of  $\text{cone}(K)$  (of  $\Sigma K$ ) is the topological cone (suspension) over  $|K|$ .

The *barycentric subdivision* of an abstract simplicial complex  $K$  is the simplicial complex  $\text{bs}(K)$  on the set  $\{I, I \in K\}$  of simplices of  $K$  such that  $\{I_1, \dots, I_r\} \in \text{bs}(K)$  if and only if  $I_1 \subset I_2 \subset \dots \subset I_r$  (after possible re-ordering). The *barycentre* of a (polytopal) simplex  $\Delta^n \in \mathbb{R}^n$  with vertices  $v_1, \dots, v_{n+1}$  is the point  $\text{bc}(\Delta^n) = \frac{1}{n+1}(v_1 + \dots + v_{n+1}) \in \Delta^n$ . The *barycentric subdivision* of a polyhedron  $\mathcal{P}$  is the polyhedron  $\text{bs}(\mathcal{P})$  defined as follows. The vertices of  $\text{bs}(\mathcal{P})$  are barycentres of simplices of  $\mathcal{P}$  of all dimensions. The set of vertices  $\{\text{bc}(\Delta_1^{i_1}), \dots, \text{bc}(\Delta_r^{i_r})\}$  spans a simplex of  $\text{bs}(\mathcal{P})$  if and only if  $\Delta_1^{i_1} \subset \dots \subset \Delta_r^{i_r}$  in  $\mathcal{P}$ . Obviously, one has  $|\text{bs}(K)| = \text{bs}(|K|)$  for any abstract simplicial complex  $K$ .

**Example 1.2.7** (order complex of a poset). Let  $(\mathcal{S}, \prec)$  be any poset. Define  $K(\mathcal{S})$  to be the set of all chains  $x_1 \prec x_2 \prec \dots \prec x_k, x_i \in \mathcal{S}$ . It is easy to see that  $K(\mathcal{S})$  is a simplicial complex. This complex is called the *order complex* of the poset  $(\mathcal{S}, \prec)$ . In particular, if  $(\mathcal{S}, \varsubsetneq)$  is the face poset (face lattice) of a simplicial complex  $K$ , then  $K(\mathcal{S})$  is the barycentric subdivision of  $K$ .

The *missing face* of simplicial complex  $K$  on the set  $[m]$  is a subset  $I \subset [m]$  such that  $I \notin K$ , but every proper subset of  $I$  is a simplex of  $K$ . A *flag complex* is a simplicial complex for which every missing face has two elements. Order complexes of posets (in particular, barycentric subdivisions) are flag complexes due to the transitivity relation.

For any subset  $I \subset [m]$  denote by  $K_I$  the subcomplex of  $K$  consisting of all simplices  $J \in K$  such that  $J \subset I$ . The *link* of a simplex  $I$  of simplicial complex  $K$  is the subcomplex  $\text{link}_K I \subset K$  consisting of all simplices  $J \in K$  such

that  $I \cup J \in K$  and  $I \cap J = \emptyset$ . For any vertex  $\{i\} \in K$  the cone over  $\text{link}_K\{i\}$  (with vertex  $\{i\}$ ) is naturally a subcomplex of  $K$ , which is called the *star* of  $\{i\}$  and denoted  $\text{star}_K\{i\}$ . The polyhedron  $|\text{star}_K\{i\}|$  consists of all (polytopal) simplices of  $|K|$  that contain  $\{i\}$ . When it is clear from the context which  $K$  is under consideration we write  $\text{link } I$  and  $\text{star}\{i\}$  instead of  $\text{link}_K I$  and  $\text{star}_K\{i\}$  respectively. Define  $\text{core}[m] = \{i \in [m] : \text{star}\{i\} \neq K\}$ . The *core* of  $K$  is the subcomplex  $\text{core } K = K_{\text{core}[m]}$ . Thus, the core is the maximal subcomplex containing all vertices whose stars do not coincide with  $K$ .

**Example 1.2.8.** 1.  $\text{link}(\emptyset) = K$ .

2. Let  $K$  be the simplex on four vertices 1, 2, 3, 4, and  $I = \{1, 2\}$ . Then  $\text{link}(I)$  is a subcomplex consisting of two vertices 3 and 4.

3. Let  $K$  be the cone over  $K'$  with vertex  $p$ . Then  $\text{link}\{p\} = K'$ ,  $\text{star}\{p\} = K$ , and  $\text{core } K \subset K'$ .

A *simplicial  $n$ -sphere* is a simplicial complex homeomorphic to  $n$ -sphere  $S^n$ . (Here and below by saying “simplicial complex  $K$  is homeomorphic to  $X$ ” we mean that the geometric realisation  $|K|$  is homeomorphic to  $X$ .) A *PL (piecewise-linear) sphere* is a simplicial sphere which is piecewise-linear homeomorphic to the boundary of a simplex. The boundary of a simplicial  $n$ -polytope is an  $(n - 1)$ -dimensional *PL sphere*. *PL spheres* that can be obtained in such way are called *polytopal spheres*. Hence, we have the following inclusions of classes of combinatorial objects:

$$\text{polytopal spheres} \subset \text{PL spheres} \subset \text{simplicial spheres}.$$

In dimension 2 any simplicial sphere is polytopal (see e.g. [89, Theorem 5.8]). However, in higher dimensions both above inclusions are strict. First examples of *non-polytopal PL 3-spheres* were found by Grünbaum, and the smallest such sphere has 8 vertices. Good description of these examples can be found in [9]. A *non-PL simplicial sphere* is presented in Example 1.2.10 below.

The  $f$ -vector and the  $h$ -vector of an  $(n - 1)$ -dimensional simplicial complex  $K^{n-1}$  are defined in the same way as for simplicial polytopes:  $\mathbf{f}(K^{n-1}) = (f_0, f_1, \dots, f_{n-1})$ , where  $f_i$  is the number of  $i$ -dimensional simplices of  $K^{n-1}$ , and  $\mathbf{h}(K^{n-1}) = (h_0, h_1, \dots, h_n)$ , where  $h_i$  are determined by (7). Here we also assume  $f_{-1} = 1$ . If  $K^{n-1} = \partial P^*$  is the boundary of a simplicial  $n$ -polytope  $P^*$ , then one obviously has  $\mathbf{f}(K^{n-1}) = \mathbf{f}(P^*)$ .

Since the  $f$ -vector of a polytopal sphere coincides with the  $f$ -vector of the corresponding (simplicial) polytope, the  $g$ -theorem (Theorem 1.1.17) holds for polytopal spheres. So, it is natural to ask whether the  $g$ -theorem extends to simplicial spheres. This question was posed by McMullen [58] as an extension of his conjecture for simplicial polytopes. After 1980, when the proof of McMullen’s conjecture for simplicial polytopes was found by Billera, Lee, and Stanley, the following became perhaps the main open combinatorial-geometrical problem concerning the  $f$ -vectors of simplicial complexes.

**Problem 1.2.9** ( *$g$ -conjecture for simplicial spheres*). *Does the  $g$ -theorem (Theorem 1.1.17) hold for simplicial spheres?*

The  $g$ -conjecture is open even for *PL spheres*. We note that only the necessity of  $g$ -theorem (i.e. that the  $g$ -vector is an  $M$ -vector) should be verified for simplicial spheres. If correct, the  $g$ -conjecture would imply a characterisation of  $f$ -vectors of simplicial spheres.

The first part of Theorem 1.1.17 (the Dehn–Sommerville equations) is known to be true for simplicial spheres (see Corollary 1.4.15 below). The first inequality  $h_0 \leq h_1$  from the second part of  $g$ -theorem is equivalent to  $1 \leq f_0 - n$ , which is obvious. The inequality  $h_1 \leq h_2$  ( $n \geq 4$ ) is equivalent to the lower bound  $f_1 \geq nf_0 - \binom{n+1}{2}$  for the number of edges, which is also known for simplicial spheres (see [10], in fact, the proof of the lower bound for the number of edges of simplicial polytopes can be adapted for simplicial spheres). All these facts together imply that the  $g$ -conjecture is true for simplicial spheres of dimension  $\leq 4$ . The inequality  $h_2 \leq h_3$  ( $n \geq 6$ ) from the GLBT (the second part of Theorem 1.1.17) is open. A lot of attempts to prove the  $g$ -conjecture were made during the last two decades. Though unsuccessful, these attempts resulted in some very interesting reformulations of the  $g$ -conjecture. We just mention the results of Pachner [66], [67] reducing the  $g$ -conjecture (for  $PL$ -spheres) to some properties of *bistellar moves*, and the results of [84] showing that the conjecture follows from the *skeletal  $r$ -rigidity* of simplicial  $(n - 1)$ -sphere for  $r \leq \lfloor \frac{n}{2} \rfloor$ . It was shown independently by Kalai and Stanley [80, Corollary 2.4] that the GLBT holds for the boundary of an  $n$ -dimensional ball that is a subcomplex of the boundary complex of a simplicial  $(n + 1)$ -polytope. However, it is not clear now which simplicial complexes occur in this way. The lack of progress in proving the  $g$ -conjecture motivated Björner and Lutz to launch the computer-aided seek for counter examples [15]. Though their computer program, BISTELLAR, allowed to obtain many remarkable results on triangulations of manifolds, no counter examples to  $g$ -conjecture were found. For more history of  $g$ -theorem and related questions see [81], [82], [89, Lecture 8].

A simplicial complex  $K$  is called a *simplicial manifold* (or *triangulated manifold*) if the polyhedron  $|K|$  is a topological manifold. All manifolds considered in this review are compact, connected and closed (unless otherwise stated). If  $K^q$  is a simplicial manifold, then  $\text{link}(I)$  has the homology of a  $(q - \#I)$ -sphere for each non-empty simplex  $I \in K^q$  (see Theorem 1.2.11 below). A  $q$ -dimensional *PL manifold* (or *combinatorial manifold*) is a simplicial complex  $K^q$  such that  $\text{link}(I)$  is a  $PL$  sphere of dimension  $(q - \#I)$  for each non-empty simplex  $I \in K^q$ .

*Remark.* If  $K^q$  is a  $PL$  manifold, then for each vertex  $\{i\} \in K^q$  the  $PL$   $(q - 1)$ -sphere  $\text{link}\{i\}$  bounds the open neighbourhood  $U_i$  which is  $PL$ -homeomorphic to a  $q$ -ball. Since any point of  $|K^q|$  is contained in  $U_i$  for some  $i$ , this defines a  $PL$ -atlas on  $|K^q|$ .

**Example 1.2.10** (non- $PL$  simplicial 5-sphere). Let  $S_H^3$  be any homology, but not topological, 3-sphere, i.e. a non-simply-connected manifold with the same homology as the ordinary 3-sphere  $S^3$ . The *Poincaré sphere*  $\Sigma = SO(3)/A_5$  provides an example of such a manifold. By Cannon’s theorem [27], the double suspension  $\Sigma^2 S_H^3$  is homeomorphic to  $S^5$ . However,  $\Sigma^2 S_H^3$  can not be  $PL$ , since  $S_H^3$  appears as the link of some 1-simplex in  $\Sigma^2 S_H^3$ .

The following theorem gives a combinatorial characterisation of simplicial complexes which are simplicial manifolds of dimension  $\geq 5$  and generalises the mentioned above result by Cannon.

**Theorem 1.2.11** (Edwards [38]). *For  $q \geq 5$  the polyhedron of a simplicial complex  $K^q$  is a topological  $q$ -manifold if and only if  $\text{link } I$  has the homology of a  $(q - \#I)$ -sphere for each non-empty simplex  $I \in K^q$  and  $\text{link}\{i\}$  is simply connected for each vertex  $\{i\} \in K$ .*

Which topological manifolds can be triangulated is the question of great importance for combinatorial topologists. Any smooth manifold can be triangulated by Whitney's theorem. All topological 2- and 3-dimensional manifolds can be triangulated as well (for 2-manifolds this is almost obvious, for 3-manifolds see [60]). Moreover, since the link of a vertex in a simplicial 3-sphere is a 2-sphere (and 2-sphere is always *PL*), all 2- and 3-manifolds are *PL*. However, in dimension 4 there exist topological manifolds that do not admit a *PL*-triangulation (e.g. Freedman's fake  $\mathbb{C}P^2$ ). Moreover, there exist topological 4-manifolds that *do not admit any triangulation* (e.g. Freedman's topological 4-manifold with the intersection form  $E_8$ ). Both examples can be found in [3]. In dimensions  $\geq 5$  we have the famous combinatorial-topological problem:

**Problem 1.2.12** (Triangulation Conjecture). *Is it true that every topological manifold of dimension  $\geq 5$  can be triangulated?*

Another well-known problem of *PL*-topology concerns the uniqueness of a *PL* structure on the topological sphere.

**Problem 1.2.13.** *Is a *PL* manifold homeomorphic to the topological 4-sphere necessarily a *PL* sphere?*

Four is only dimension where the uniqueness of a *PL* structure for the topological sphere is open. For dimensions  $\leq 3$  the uniqueness was proved by Moise [60], and for dimensions  $\geq 5$  it follows from the work of Kirby and Siebenmann [51]. In dimension 4 the category of *PL* manifolds is equivalent to the smooth category, hence, the above problem is equivalent to if there exists an exotic 4-sphere.

More information about recent developments and open problems in combinatorial and *PL* topology can be found in [61], [72].

**1.3. Simplicial complexes: commutative algebra.** The commutative algebra can be applied to combinatorics of simplicial complexes and related objects. The main tool for translating combinatorial results and problems to the algebraic language is the Stanley–Reisner ring of simplicial complex. This approach was outlined by R. Stanley at the beginning of 1970's.

Remember that  $\mathbf{k}[v_1, \dots, v_m]$  denotes the graded polynomial algebra over a commutative ring  $\mathbf{k}$  with unit,  $\deg(v_i) = 2$ .

**Definition 1.3.1.** The *face ring* (or the *Stanley–Reisner ring*) of a simplicial complex  $K$  with  $m$  vertices is the quotient ring

$$\mathbf{k}(K) = \mathbf{k}[v_1, \dots, v_m] / \mathcal{I}_K,$$

where  $\mathcal{I}_K$  is the homogeneous ideal generated by all square-free monomials  $v_{i_1} v_{i_2} \cdots v_{i_s}$ ,  $i_1 < \cdots < i_s$ , such that  $I = \{i_1, \dots, i_s\}$  is not a simplex of  $K$ .

Note that the ideal  $\mathcal{I}_K$  has basis consisting of square-free monomials  $v_{i_1} v_{i_2} \cdots v_{i_s}$  such that  $I = \{i_1, \dots, i_s\}$  is a missing face of  $K$ . Ideals in the polynomial ring that admit a basis of monomials are called *monomial*.

**Proposition 1.3.2.** *Any square-free monomial ideal of the polynomial ring has the form  $\mathcal{I}_K$  for some simplicial complex  $K$ .*

*Proof.* For any subset  $I = \{i_1, \dots, i_k\} \subset [m]$  denote by  $v_I$  the square-free monomial  $v_{i_1} \cdots v_{i_k}$ . Let  $\mathcal{I}$  be a square-free monomial ideal. Set

$$K = \{I \subset [m] : v_{[m] \setminus I} \in \mathcal{I}\}.$$



Then one easily checks that  $K$  is a simplicial complex and  $\mathcal{I} = \mathcal{I}_K$ . □

Let  $P$  be a simple  $n$ -polytope, and  $P^*$  its polar simplicial polytope. Denote by  $K_P$  the boundary of  $P^*$ . Then  $K_P$  is a polytopal simplicial  $(n - 1)$ -sphere. Obviously, the face ring of  $P$  from Definition 1.1.20 coincides with that of  $K_P$  from Definition 1.3.1:  $\mathbf{k}(P) = \mathbf{k}(K_P)$ .

Let  $M = M^0 \oplus M^1 \oplus \dots$  be a graded  $\mathbf{k}$ -module. The series

$$F(M; t) = \sum_{i=0}^{\infty} (\dim_{\mathbf{k}} M^i) t^i$$

is called the *Poincaré series* of  $M$ .

*Remark.* In the algebraic literature the series  $F(M; t)$  is known as the *Hilbert series* or *Hilbert–Poincaré series*.

The following lemma establishes the connection between two combinatorial invariants of a simplicial complex: the face ring and the  $f$ -vector (or the  $h$ -vector).

**Lemma 1.3.3** (Stanley [81, Theorem II.1.4]). *The Poincaré series of  $\mathbf{k}(K^{n-1})$  can be calculated as*

$$F(\mathbf{k}(K^{n-1}); t) = \sum_{i=-1}^{n-1} \frac{f_i t^{2(i+1)}}{(1-t^2)^{i+1}} = \frac{h_0 + h_1 t^2 + \dots + h_n t^{2n}}{(1-t^2)^n},$$

where  $(f_0, \dots, f_{n-1})$  is the  $f$ -vector and  $(h_0, \dots, h_n)$  is the  $h$ -vector of  $K^{n-1}$ .

Note that the second identity from Lemma 1.3.3 is an obvious corollary of (8).

**Example 1.3.4.** 1. Let  $K = \Delta^n$  (the  $n$ -simplex). Then  $f_i = \binom{n+1}{i+1}$  for  $-1 \leq i \leq n$ ,  $h_0 = 1$ , and  $h_i = 0$  for  $i > 0$ . Since any subset of  $[n + 1]$  is a simplex of  $\Delta^n$ , one has  $\mathbf{k}(\Delta^n) = \mathbf{k}[v_1, \dots, v_{n+1}]$ . Then  $F(\mathbf{k}(\Delta^n); t) = \frac{1}{(1-t^2)^{n+1}}$ , which agrees with Lemma 1.3.3.

2. Let  $K$  be the boundary of an  $n$ -simplex. Then  $h_i = 1$ ,  $i = 0, 1, \dots, n$ , and  $\mathbf{k}(K) = \mathbf{k}[v_1, \dots, v_{n+1}]/(v_1 v_2 \dots v_{n+1})$ . Hence,

$$F(\mathbf{k}(K); t) = \frac{1 + t^2 + \dots + t^{2n}}{(1-t^2)^n}.$$

Now suppose  $\mathbf{k}$  is a field. Let  $A$  be a graded algebra over  $\mathbf{k}$ . The *Krull dimension* of  $A$  (denoted  $\text{Kd } A$ ) is the maximal number of algebraically independent elements of  $A$ . A sequence  $\theta_1, \dots, \theta_n$  of  $n = \text{Kd } A$  homogeneous elements of  $A$  is called a *hsop* (homogeneous system of parameters) if the Krull dimension of the quotient  $A/(\theta_1, \dots, \theta_n)$  is zero. Equivalently,  $\theta_1, \dots, \theta_n$  is a hsop if  $n = \text{Kd } A$  and  $A$  is a finitely-generated  $\mathbf{k}[\theta_1, \dots, \theta_n]$ -module. The elements of a hsop are algebraically independent.

**Lemma 1.3.5** (Noether normalisation lemma). *For any finitely-generated graded algebra  $A$  there exists a hsop. If  $\mathbf{k}$  is of zero characteristic and  $A$  is generated by degree-two elements, then one can choose a degree-two hsop.*

Below in this section we assume that  $\mathbf{k}$  is of zero characteristic. A sequence  $\theta_1, \dots, \theta_k$  of homogeneous elements of  $A$  is called a *regular sequence* if  $\theta_{i+1}$  is not a zero divisor in  $A/(\theta_1, \dots, \theta_i)$  for  $0 \leq i < k$  (i.e. the multiplication by  $\theta_{i+1}$  is a monomorphism of  $A/(\theta_1, \dots, \theta_i)$  into itself). Equivalently,  $\theta_1, \dots, \theta_k$  is a regular sequence if  $\theta_1, \dots, \theta_k$  are algebraically independent and  $A$  is a *free*  $\mathbf{k}[\theta_1, \dots, \theta_k]$ -module.

*Remark.* Regular sequences can be also defined in non-finitely-generated graded algebras and in algebras over any integral domain. Regular sequences in the graded polynomial ring  $R[a_1, a_2, \dots]$ ,  $\deg a_i = -2i$ , on infinitely many generators, where  $R$  is a subring of the field  $\mathbb{Q}$  of rationals, are used in the algebraic topology for constructing complex cobordism theories with coefficients, see [54].

Any two maximal regular sequences have the same length, which is called the *depth* of  $A$  and denoted  $\text{depth } A$ . Obviously,  $\text{depth } A \leq \text{Kd } A$ .

**Definition 1.3.6.** Algebra  $A$  is called *Cohen–Macaulay* if it admits a regular sequence  $\theta_1, \dots, \theta_n$  of length  $n = \text{Kd } A$ .

Any regular sequence  $\theta_1, \dots, \theta_n$  of length  $n = \text{Kd } A$  is a hsop. It follows that  $A$  is Cohen–Macaulay if and only if there exists a hsop  $\theta_1, \dots, \theta_n$  such that  $A$  is a finitely-generated free  $\mathbf{k}[\theta_1, \dots, \theta_n]$ -module. If in addition  $A$  is generated by degree-two elements, then one can choose  $\theta_1, \dots, \theta_n$  to be of degree two. In this case for the Poincaré series of  $A$  holds

$$F(A; t) = \frac{F(A/(\theta_1, \dots, \theta_n); t)}{(1 - t^2)^n},$$

where  $F(A/(\theta_1, \dots, \theta_n); t) = h_0 + h_1 t^2 + \dots$  is a polynomial. The finite vector  $(h_0, h_1, \dots)$  is called the *h-vector* of  $A$ .

A simplicial complex  $K^{n-1}$  is called *Cohen–Macaulay* (over  $\mathbf{k}$ ) if its face ring  $\mathbf{k}(K)$  is Cohen–Macaulay. Obviously,  $\text{Kd } \mathbf{k}(K) = n$ . Lemma 1.3.3 shows that the *h-vector* of  $\mathbf{k}(K)$  coincides with the *h-vector* of  $K$ .

**Theorem 1.3.7** (Stanley). *If  $K^{n-1}$  is a Cohen–Macaulay simplicial complex, then  $\mathbf{h}(K^{n-1}) = (h_0, \dots, h_n)$  is an  $M$ -vector (see section 1.2).*

*Proof.* Let  $\theta_1, \dots, \theta_n$  be a regular sequence of degree-two elements of  $\mathbf{k}(K)$ . Then  $A = \mathbf{k}(K)/(\theta_1, \dots, \theta_n)$  is a graded algebra generated by degree-two elements, and  $\dim_{\mathbf{k}} A^{2i} = h_i$ . Now the result follows from Theorem 1.1.18.  $\square$

The following fundamental theorem characterises Cohen–Macaulay complexes.

**Theorem 1.3.8** (Reisner [73]). *A simplicial complex  $K$  is Cohen–Macaulay over  $\mathbf{k}$  if and only if for any simplex  $I \in K$  (including  $I = \emptyset$ ) and  $i < \dim(\text{link } I)$ ,  $\tilde{H}_i(\text{link } I; \mathbf{k}) = 0$ . (Here  $\tilde{H}_i(\cdot; \mathbf{k})$  denotes the  $i$ -th reduced homology group with coefficients in  $\mathbf{k}$ .)*

In particular, a simplicial sphere is a Cohen–Macaulay complex. Then Theorem 1.3.7 shows that the *h-vector* of a simplicial sphere is an  $M$ -vector. This fact allowed Stanley to extend the UBT (Theorem 1.1.19) to simplicial spheres.

**Corollary 1.3.9** (Stanley). *The Upper Bound Theorem holds for simplicial spheres. That is, if  $(h_0, h_1, \dots, h_n)$  is the *h-vector* of a simplicial  $(n - 1)$ -sphere  $K^{n-1}$  with  $m$  vertices, then*

$$h_i(K^{n-1}) \leq \binom{m-n+i-1}{i}, \quad 0 \leq i < \lfloor \frac{n}{2} \rfloor.$$

*Proof.* Since  $\mathbf{h}(K^{n-1})$  is an  $M$ -vector, there exists a graded algebra  $A = A^0 \oplus A^2 \oplus \dots \oplus A^{2n}$  generated by degree-two elements such that  $\dim_{\mathbf{k}} A^{2i} = h_i$  (Theorem 1.1.18). In particular,  $\dim_{\mathbf{k}} A^2 = h_1 = m - n$ . Since  $A$  is generated by  $A^2$ , the number  $h_i$  can not exceed the total number of monomials of degree  $i$  in  $(m - n)$  variables. The latter is exactly  $\binom{m-n+i-1}{i}$ .  $\square$

**1.4. Homological properties of face rings (Stanley–Reisner rings).** We start with reviewing some homology algebra. All modules in this section are assumed to be finitely-generated graded  $\mathbf{k}[v_1, \dots, v_m]$ -modules,  $\deg v_i = 2$ , unless otherwise stated.

A *finite free resolution* of a module  $M$  is an exact sequence

$$(14) \quad 0 \rightarrow R^{-h} \xrightarrow{d} R^{-h+1} \xrightarrow{d} \dots \rightarrow R^{-1} \xrightarrow{d} R^0 \xrightarrow{d} M \rightarrow 0,$$

where the  $R^{-i}$  are finitely-generated free modules and the maps  $d$  are degree-preserving. The minimal number  $h$  for which a free resolution (14) exists is called the *homological dimension* of  $M$  and denoted  $\text{hd } M$ . By the Hilbert syzygy theorem,  $\text{hd } M \leq m$ . A resolution (14) determines the free *bigraded differential module*  $[R, d]$ , where  $R = \bigoplus R^{-i,j}$ ,  $R^{-i,j} := (R^{-i})^j$  (the  $j$ -th graded component of the free module  $R^{-i}$ ). The cohomology of  $[R, d]$  is zero in non-zero dimensions, while  $H^0[R, d] = M$ . Conversely, a free bigraded differential module  $[R = \bigoplus_{i,j \geq 0} R^{-i,j}, d : R^{-i,j} \rightarrow R^{-i+1,j}]$  with  $H^0[R, d] = M$  and  $H^{-i}[R, d] = 0$  for  $i > 0$  defines a free resolution (14) with  $R^{-i} := R^{-i,*} = \bigoplus_j R^{-i,j}$ .

*Remark.* For reasons specified below we numerate the terms of a free resolution by *non-positive* numbers, thus making it a *cochain* complex.

The Poincaré series of  $M$  can be calculated from any free resolution (14).

**Theorem 1.4.1.** *Suppose that the free  $\mathbf{k}[v_1, \dots, v_m]$ -module  $R^{-i}$  in (14) is generated by elements of degrees  $d_{1i}, \dots, d_{q_i i}$ , where  $q_i = \text{rank } R^{-i}$ ,  $i = 1, \dots, h$ . Then*

$$(15) \quad F(M; t) = (1 - t^2)^{-m} \sum_{i=0}^h (-1)^i (t^{d_{1i}} + \dots + t^{d_{q_i i}}).$$

**Example 1.4.2** (minimal resolution). For different reasons it is convenient to have a resolution (14) for which each term  $R^{-i}$  has the smallest possible rank. The following definition is taken from Adams' paper [2]. Let  $M, M'$  be two modules. Set  $\mathcal{J}(M) = v_1 M + v_2 M + \dots + v_m M \subset M$ . A map  $f : M \rightarrow M'$  is called *minimal* if  $\text{Ker } f \subset \mathcal{J}(M)$ . A resolution (14) is called *minimal* if all maps  $d$  are minimal. Then it is easy to see that each  $R^{-i}$  has the smallest possible rank.

A minimal resolution can be constructed as follows. Take a *minimal set of generators*  $a_1, \dots, a_{k_0}$  for  $M$  and define  $R^0$  to be the free  $\mathbf{k}[v_1, \dots, v_m]$ -module with  $k_0$  generators. Then take a minimal set of generators  $a_1, \dots, a_{k_1}$  in the kernel of natural epimorphism  $R^0 \rightarrow M$  and define  $R^{-1}$  to be the free  $\mathbf{k}[v_1, \dots, v_m]$ -module with  $k_1$  generators, and so on. On the  $i$ -th step we take a minimal set of generators in the kernel of the previously constructed map  $d : R^{-i+1} \rightarrow R^{-i+2}$  and define  $R^{-i}$  to be the free module with the corresponding generators. Note that a minimal resolution is unique up to an isomorphism.

**Example 1.4.3** (Koszul resolution). Let  $M = \mathbf{k}$ . The  $\mathbf{k}[v_1, \dots, v_m]$ -module structure on  $\mathbf{k}$  is defined by the map  $\mathbf{k}[v_1, \dots, v_m] \rightarrow \mathbf{k}$  that sends each  $v_i$  to 0. Let  $\Lambda[u_1, \dots, u_m]$  denote the exterior algebra on  $m$  generators. The tensor product  $R = \Lambda[u_1, \dots, u_m] \otimes \mathbf{k}[v_1, \dots, v_m]$  (here and below  $\otimes$  denotes  $\otimes_{\mathbf{k}}$ ) becomes a *differential bigraded algebra* by setting

$$(16) \quad \begin{aligned} \text{bideg } u_i &= (-1, 2), & \text{bideg } v_i &= (0, 2), \\ du_i &= v_i, & dv_i &= 0, \end{aligned}$$

and requiring that  $d$  be a derivation of algebras. It can be shown (see [56, §7.2]) that  $H^{-i}[R, d] = 0$  for  $i > 0$  and  $H^0[R, d] = \mathbf{k}$ . Since  $\Lambda[u_1, \dots, u_m] \otimes \mathbf{k}[v_1, \dots, v_m]$  is a free  $\mathbf{k}[v_1, \dots, v_m]$ -module, it determines a free resolution of  $\mathbf{k}$ . This resolution is called the *Koszul resolution*. More precisely, it has the following form

$$\begin{aligned} 0 \rightarrow \Lambda^m[u_1, \dots, u_m] \otimes \mathbf{k}[v_1, \dots, v_m] &\longrightarrow \cdots \\ &\longrightarrow \Lambda^1[u_1, \dots, u_m] \otimes \mathbf{k}[v_1, \dots, v_m] \longrightarrow \mathbf{k}[v_1, \dots, v_m] \longrightarrow \mathbf{k} \rightarrow 0, \end{aligned}$$

where  $\Lambda^i[u_1, \dots, u_m]$  is the submodule of  $\Lambda[u_1, \dots, u_m]$  spanned by the monomials of length  $i$ . Thus, in notations of (14) we have  $R^{-i} = \Lambda^i[u_1, \dots, u_m] \otimes \mathbf{k}[v_1, \dots, v_m]$ .

Let  $N$  be another module; then applying the functor  $\otimes_{\mathbf{k}[v_1, \dots, v_m]} N$  to (14) we obtain the following cochain complex of graded modules:

$$0 \longrightarrow R^{-h} \otimes_{\mathbf{k}[v_1, \dots, v_m]} N \longrightarrow \cdots \longrightarrow R^0 \otimes_{\mathbf{k}[v_1, \dots, v_m]} N \longrightarrow 0$$

and the corresponding bigraded differential module  $[R \otimes N, d]$ . The  $(-i)$ -th cohomology module of the above cochain complex is denoted  $\mathrm{Tor}_{\mathbf{k}[v_1, \dots, v_m]}^{-i}(M, N)$ , i.e.

$$\begin{aligned} \mathrm{Tor}_{\mathbf{k}[v_1, \dots, v_m]}^{-i}(M, N) &:= H^{-i}[R \otimes_{\mathbf{k}[v_1, \dots, v_m]} N, d] \\ &= \frac{\mathrm{Ker}[d : R^{-i} \otimes_{\mathbf{k}[v_1, \dots, v_m]} N \rightarrow R^{-i+1} \otimes_{\mathbf{k}[v_1, \dots, v_m]} N]}{d(R^{-i-1} \otimes_{\mathbf{k}[v_1, \dots, v_m]} N)}. \end{aligned}$$

Since  $R^{-i}$  and  $N$  are graded modules, one has

$$\mathrm{Tor}_{\mathbf{k}[v_1, \dots, v_m]}^{-i}(M, N) = \bigoplus_j \mathrm{Tor}_{\mathbf{k}[v_1, \dots, v_m]}^{-i,j}(M, N),$$

where

$$\mathrm{Tor}_{\mathbf{k}[v_1, \dots, v_m]}^{-i,j}(M, N) = \frac{\mathrm{Ker}[d : (R^{-i} \otimes_{\mathbf{k}[v_1, \dots, v_m]} N)^j \rightarrow (R^{-i+1} \otimes_{\mathbf{k}[v_1, \dots, v_m]} N)^j]}{d(R^{-i-1} \otimes_{\mathbf{k}[v_1, \dots, v_m]} N)^j}.$$

Thus, we have a *bigraded*  $\mathbf{k}[v_1, \dots, v_m]$ -module

$$\mathrm{Tor}_{\mathbf{k}[v_1, \dots, v_m]}(M, N) = \bigoplus_{i,j} \mathrm{Tor}_{\mathbf{k}[v_1, \dots, v_m]}^{-i,j}(M, N).$$

The following properties of  $\mathrm{Tor}_{\mathbf{k}[v_1, \dots, v_m]}^{-i}(M, N)$  are well known (see e.g. [56]).

**Proposition 1.4.4.** (a) *The module  $\mathrm{Tor}_{\mathbf{k}[v_1, \dots, v_m]}^{-i}(M, N)$  does not depend, up to isomorphism, on the choice of resolution (14).*

(b) *Both  $\mathrm{Tor}_{\mathbf{k}[v_1, \dots, v_m]}^{-i}(\cdot, N)$  and  $\mathrm{Tor}_{\mathbf{k}[v_1, \dots, v_m]}^{-i}(M, \cdot)$  are covariant functors.*

(c)  $\mathrm{Tor}_{\mathbf{k}[v_1, \dots, v_m]}^0(M, N) \cong M \otimes_{\mathbf{k}[v_1, \dots, v_m]} N$ .

(d)  $\mathrm{Tor}_{\mathbf{k}[v_1, \dots, v_m]}^{-i}(M, N) \cong \mathrm{Tor}_{\mathbf{k}[v_1, \dots, v_m]}^{-i}(N, M)$ .

One can also define the  $A$ -modules  $\mathrm{Tor}_A(M, N)$  for any finitely-generated graded commutative algebra  $A$  and (finitely-generated graded)  $A$ -modules  $M, N$ . Though an  $A$ -free resolution (14) of  $M$  may fail to exist, there always exists a *projective* resolution of  $M$ , which allows to define  $\mathrm{Tor}_A(M, N)$  in the same way as above. Note that projective modules over polynomial algebra are free. This was known as the *Serre problem*, now solved by Quillen and Suslin. However, for graded modules this fact is not hard to prove. In our paper modules  $\mathrm{Tor}_A(M, N)$  for algebras  $A$  different from the polynomial ring appear only in sections 4.1 and 5.3.

Now let  $K^{n-1}$  be a simplicial complex on  $m$  vertices,  $M = \mathbf{k}(K)$  and  $N = \mathbf{k}$ . Since  $\deg v_i = 2$ , we have

$$\mathrm{Tor}_{\mathbf{k}[v_1, \dots, v_m]}(\mathbf{k}(K), \mathbf{k}) = \bigoplus_{i,j=0}^m \mathrm{Tor}_{\mathbf{k}[v_1, \dots, v_m]}^{-i,2j}(\mathbf{k}(K), \mathbf{k})$$

(i.e. non-zero elements of  $\mathrm{Tor}_{\mathbf{k}[v_1, \dots, v_m]}(\mathbf{k}(K), \mathbf{k})$  have even second degree). Define the *bigraded Betti numbers* of  $\mathbf{k}(K)$  as

$$(17) \quad \beta^{-i,2j}(\mathbf{k}(K)) := \dim_{\mathbf{k}} \mathrm{Tor}_{\mathbf{k}[v_1, \dots, v_m]}^{-i,2j}(\mathbf{k}(K), \mathbf{k}), \quad 0 \leq i, j \leq m.$$

Suppose that (14) is a *minimal* free resolution of  $M = \mathbf{k}(K)$ . Then  $R^0 \cong \mathbf{k}[v_1, \dots, v_m]$  is a free  $\mathbf{k}[v_1, \dots, v_m]$ -module with one generator of degree 0. The basis of  $R^{-1}$  (the minimal generator set for  $\mathrm{Ker}[\mathbf{k}[v_1, \dots, v_m] \rightarrow \mathbf{k}(K)]$ ) consists of elements  $v_{i_1, \dots, i_k}$ ,  $\deg v_{i_1, \dots, i_k} = 2k$ , such that  $\{i_1, \dots, i_k\}$  is a missing face of  $K$ . The map  $d : R^{-1} \rightarrow R^0$  takes  $v_{i_1, \dots, i_k}$  to  $v_{i_1} \cdots v_{i_k}$ . Since the maps  $d$  in (14) are minimal, all differentials in the cochain complex

$$0 \longrightarrow R^{-h} \otimes_{\mathbf{k}[v_1, \dots, v_m]} \mathbf{k} \longrightarrow \cdots \longrightarrow R^0 \otimes_{\mathbf{k}[v_1, \dots, v_m]} \mathbf{k} \longrightarrow 0$$

are trivial. Hence, for the minimal resolution of  $\mathbf{k}(K)$  holds

$$(18) \quad \begin{aligned} \mathrm{Tor}_{\mathbf{k}[v_1, \dots, v_m]}^{-i}(\mathbf{k}(K), \mathbf{k}) &\cong R^{-i} \otimes_{\mathbf{k}[v_1, \dots, v_m]} \mathbf{k}, \\ \beta^{-i,2j}(\mathbf{k}(K)) &= \mathrm{rank} R^{-i,2j} (= \dim_{\mathbf{k}[v_1, \dots, v_m]} R^{-i,2j}). \end{aligned}$$

The Betti numbers  $\beta^{-i,2j}(\mathbf{k}(K))$  are important combinatorial invariants of the simplicial complex  $K$ . Some results describing these numbers were obtained in [81]. The following important theorem (which was proved by combinatorial methods) reduces the calculation of numbers  $\beta^{-i,2j}(\mathbf{k}(K))$  to calculating the homology groups of subcomplexes of  $K$ .

**Theorem 1.4.5** (Hochster [46]). *The following formula holds for the Poincaré series of the module  $\mathrm{Tor}_{\mathbf{k}[v_1, \dots, v_m]}^{-i}(\mathbf{k}(K), \mathbf{k})$ :*

$$\sum_j \beta^{-i,2j}(\mathbf{k}(K)) t^{2j} = \sum_{I \subset [m]} (\dim_{\mathbf{k}} \tilde{H}_{\#I-i-1}(K_I)) t^{2(\#I)},$$

where  $K_I$  is the subcomplex of  $K$  consisting of all simplices with vertices in  $I$ .

We mention that calculations using this theorem become very involved even for small  $K$ . In chapter 4 we show that the numbers  $\beta^{-i,2j}(\mathbf{k}(K))$  equal the bigraded Betti numbers of the moment-angle complex  $\mathcal{Z}_K$  associated with the simplicial complex  $K$ . This provides the alternative (topological) way for calculating the numbers  $\beta^{-i,2j}(\mathbf{k}(K))$ .

Now we look at the Koszul resolution (Example 1.4.3).

**Lemma 1.4.6.** *For any module  $M$  holds*

$$\mathrm{Tor}_{\mathbf{k}[v_1, \dots, v_m]}(M, \mathbf{k}) \cong H[\Lambda[u_1, \dots, u_m] \otimes M, d],$$

where  $H[\Lambda[u_1, \dots, u_m] \otimes M, d]$  is the cohomology of the bigraded differential module  $\Lambda[u_1, \dots, u_m] \otimes M$  and  $d$  is defined as in (16).

*Proof.* Using the Koszul resolution  $[\Lambda[u_1, \dots, u_m] \otimes \mathbf{k}[v_1, \dots, v_m], d]$  for the definition of  $\mathrm{Tor}_{\mathbf{k}[v_1, \dots, v_m]}(\mathbf{k}, M)$  we calculate

$$\begin{aligned} \mathrm{Tor}_{\mathbf{k}[v_1, \dots, v_m]}(M, \mathbf{k}) &\cong \mathrm{Tor}_{\mathbf{k}[v_1, \dots, v_m]}(\mathbf{k}, M) \\ &= H[\Lambda[u_1, \dots, u_m] \otimes \mathbf{k}[v_1, \dots, v_m] \otimes_{\mathbf{k}[v_1, \dots, v_m]} M] \cong H[\Lambda[u_1, \dots, u_m] \otimes M]. \end{aligned}$$

□

Suppose now that the  $\mathbf{k}[v_1, \dots, v_m]$ -module  $M$  is a  $\mathbf{k}$ -algebra. Then the cohomology of  $[\Lambda[u_1, \dots, u_m] \otimes M, d]$  is an algebra as well. Lemma 1.4.6 allows to invest  $\mathrm{Tor}_{\mathbf{k}[v_1, \dots, v_m]}(M, \mathbf{k})$  with the canonical structure of a finite-dimensional bigraded  $\mathbf{k}$ -algebra. We refer to this bigraded algebra as the *Tor-algebra* of  $M$ . The Tor-algebra of a simplicial complex  $K$  is the Tor-algebra of the face ring  $\mathbf{k}(K)$ .

*Remark.* For general  $N \neq \mathbf{k}$  the module  $\mathrm{Tor}_{\mathbf{k}[v_1, \dots, v_m]}(M, N)$  has no canonical structure of an algebra even if both  $M$  and  $N$  are algebras.

**Construction 1.4.7** (multigraded structure in the Tor-algebra). Invest the polynomial ring  $\mathbf{k}[v_1, \dots, v_m]$  with the multigraded (more precisely,  $\mathbb{N}^m$ -graded) structure by setting  $\mathrm{mdeg} v_i = (0, \dots, 0, 2, 0, \dots, 0)$ , where 2 stands at the  $i$ -th place. Then the multidegree of monomial  $v_1^{i_1} \cdots v_m^{i_m}$  is  $(2i_1, \dots, 2i_m)$ . Suppose that the algebra  $M$  is the quotient of the polynomial ring by a monomial ideal. Then the multigraded structure descends to  $M$  and to the terms of resolution (14). We may assume that the differentials in the resolution preserve the multigraded structures. Then the module  $\mathrm{Tor}_{\mathbf{k}[v_1, \dots, v_m]}(M, N)$  acquires the canonical  $\mathbb{N} \oplus \mathbb{N}^m$ -grading, i.e.

$$\mathrm{Tor}_{\mathbf{k}[v_1, \dots, v_m]}(M, \mathbf{k}) = \bigoplus_{i \geq 0, j \in \mathbb{N}^m} \mathrm{Tor}_{\mathbf{k}[v_1, \dots, v_m]}^{-i, j}(M, \mathbf{k}).$$

In particular, the Tor-algebra of  $K$  can be canonically made an  $\mathbb{N} \oplus \mathbb{N}^m$ -graded algebra.

*Remark.* According to our agreement the first degree in the Tor-algebra is *non-positive*. (Recall that we numerate the terms of Koszul  $\mathbf{k}[v_1, \dots, v_m]$ -free resolution of  $\mathbf{k}$  by non-positive integers.) In such notations the Koszul complex  $[M \otimes \Lambda[u_1, \dots, u_m], d]$  becomes a *cochain* complex, and  $\mathrm{Tor}_{\mathbf{k}[v_1, \dots, v_m]}(M, \mathbf{k})$  is its *cohomology*, not the homology as usually regarded. This is the standard trick used for applying the Eilenberg–Moore spectral sequence, see section 4.1. It also explains why we write  $\mathrm{Tor}_{\mathbf{k}[v_1, \dots, v_m]}^{*,*}(M, \mathbf{k})$  instead of usual  $\mathrm{Tor}_{*,*}^{\mathbf{k}[v_1, \dots, v_m]}(M, \mathbf{k})$ .

The upper bound  $\mathrm{hd} M \leq m$  from the Hilbert syzygy theorem can be replaced by the following sharper result.

**Theorem 1.4.8** (Auslander and Buchsbaum).  $\mathrm{hd} M = m - \mathrm{depth} M$ .

From now on we assume that  $M$  is generated by degree-two elements and the  $\mathbf{k}[v_1, \dots, v_m]$ -module structure on  $M$  is defined by an epimorphism  $p : \mathbf{k}[v_1, \dots, v_m] \rightarrow M$  (both assumptions are satisfied by definition when  $M = \mathbf{k}(K)$  for some  $K$ ). Suppose that  $\theta_1, \dots, \theta_k$  is a regular sequence of degree-two elements of  $M$ . Let  $\mathcal{J} := (\theta_1, \dots, \theta_k) \subset M$  be the ideal generated by  $\theta_1, \dots, \theta_k$ . Choose degree-two elements  $t_i \in \mathbf{k}[v_1, \dots, v_m]$  such that  $p(t_i) = \theta_i$ ,  $i = 1, \dots, k$ . The ideal in  $\mathbf{k}[v_1, \dots, v_m]$  generated by  $t_1, \dots, t_k$  will be also denoted  $\mathcal{J}$ . Then  $\mathbf{k}[v_1, \dots, v_m]/\mathcal{J} \cong \mathbf{k}[w_1, \dots, w_{m-k}]$ . Under these assumptions we have the following reduction lemma.

**Lemma 1.4.9.** *The following isomorphism of algebras holds:*

$$\mathrm{Tor}_{\mathbf{k}[v_1, \dots, v_m]}(M, \mathbf{k}) = \mathrm{Tor}_{\mathbf{k}[v_1, \dots, v_m]/\mathcal{J}}(M/\mathcal{J}, \mathbf{k}).$$

In order to prove the lemma we need the following fact from the homology algebra.

**Theorem 1.4.10** ([28, p.349]). *Let  $\Lambda$  be an algebra,  $\Gamma$  its subalgebra, and  $\Omega = \Lambda/\Gamma$  the quotient algebra. Suppose that  $\Lambda$  is a free  $\Gamma$ -module and we are given an  $\Omega$ -module  $A$  and a  $\Lambda$ -module  $C$ . Then there exists a spectral sequence  $\{E_r, d_r\}$  such that*

$$E_r \Rightarrow \mathrm{Tor}_\Lambda(A, C), \quad E_2 = \mathrm{Tor}_\Omega(A, \mathrm{Tor}_\Gamma(C, \mathbf{k})).$$

*Proof of Lemma 1.4.9.* Set  $\Lambda = \mathbf{k}[v_1, \dots, v_m]$ ,  $\Gamma = \mathbf{k}[t_1, \dots, t_k]$ ,  $A = \mathbf{k}$ ,  $C = M$ . Then  $\Lambda$  is a free  $\Gamma$ -module and  $\Omega = \Lambda/\Gamma = \mathbf{k}[v_1, \dots, v_m]/\mathcal{J}$ . Therefore, Theorem 1.4.10, gives a spectral sequence

$$E_r \Rightarrow \mathrm{Tor}_{\mathbf{k}[v_1, \dots, v_m]}(M, \mathbf{k}), \quad E_2 = \mathrm{Tor}_\Omega(\mathrm{Tor}_\Gamma(M, \mathbf{k}), \mathbf{k}).$$

Since  $\theta_1, \dots, \theta_k$  is a regular sequence,  $M$  is a free  $\Gamma$ -module. Therefore,

$$\mathrm{Tor}_\Gamma(M, \mathbf{k}) = M \otimes_\Gamma \mathbf{k} = M/\mathcal{J} \quad \text{and} \quad \mathrm{Tor}_\Gamma^q(M, \mathbf{k}) = 0 \quad \text{for } q \neq 0.$$

It follows that  $E_2^{p,q} = 0$  for  $q \neq 0$ . Thus, the spectral sequence collapses at the  $E_2$  term, and we have

$$\mathrm{Tor}_{\mathbf{k}[v_1, \dots, v_m]}(M, \mathbf{k}) = \mathrm{Tor}_\Omega(\mathrm{Tor}_\Gamma(M, \mathbf{k}), \mathbf{k}) = \mathrm{Tor}_{\mathbf{k}[v_1, \dots, v_m]/\mathcal{J}}(M/\mathcal{J}, \mathbf{k}),$$

which concludes the proof.  $\square$

It follows from Lemma 1.4.9 that if  $M$  is Cohen–Macaulay of Krull dimension  $n$ , then  $\mathrm{depth} M = n$ ,  $\mathrm{hd} M = m - n$ , and  $\mathrm{Tor}_{\mathbf{k}[v_1, \dots, v_m]}^{-i}(M, \mathbf{k}) = 0$  for  $i > m - n$ .

**Definition 1.4.11.** Suppose  $M$  is a Cohen–Macaulay algebra of Krull dimension  $n$ . Then  $M$  is called a *Gorenstein algebra* if  $\mathrm{Tor}_{\mathbf{k}[v_1, \dots, v_m]}^{-(m-n)}(M, \mathbf{k}) \cong \mathbf{k}$ .

Following Stanley [81], we call a simplicial complex  $K$  *Gorenstein* if  $\mathbf{k}(K)$  is a Gorenstein algebra. Further,  $K$  is called *Gorenstein\** if  $\mathbf{k}(K)$  is Gorenstein and  $K = \mathrm{core} K$  (see section 1.2). The following theorem characterises Gorenstein\* simplicial complexes.

**Theorem 1.4.12** ([81, §II.5]). *A simplicial complex  $K$  is Gorenstein\* over  $\mathbf{k}$  if and only if for any simplex  $I \in K$  (including  $I = \emptyset$ ) the subcomplex  $\mathrm{link} I$  has the homology of a sphere of dimension  $\dim(\mathrm{link} I)$ .*

In particular, simplicial spheres and simplicial homology spheres (simplicial manifolds with the homology of a sphere) are Gorenstein\* complexes. Note, however, that a Gorenstein\* complex is not necessarily a simplicial manifold (links of vertices are not necessarily simply connected, compare with Theorem 1.2.11).

**Theorem 1.4.13** ([81, §II.5]). *Suppose  $K^{n-1}$  is a Gorenstein\* complex. Then the following identities hold for the Poincaré series of  $\mathrm{Tor}_{\mathbf{k}[v_1, \dots, v_m]}^{-i}(\mathbf{k}(K), \mathbf{k})$ ,  $0 \leq i \leq m - n$ :*

$$F\left(\mathrm{Tor}_{\mathbf{k}[v_1, \dots, v_m]}^{-i}(\mathbf{k}(K), \mathbf{k}); t\right) = t^{2m} F\left(\mathrm{Tor}_{\mathbf{k}[v_1, \dots, v_m]}^{-(m-n)+i}(\mathbf{k}(K), \mathbf{k}); \frac{1}{t}\right).$$

**Corollary 1.4.14.** *If  $K^{n-1}$  is Gorenstein\* then*

$$F(\mathbf{k}(K), t) = (-1)^n F(\mathbf{k}(K), \frac{1}{t}).$$

*Proof.* We apply Theorem 1.4.1 to a minimal resolution of  $\mathbf{k}(K)$ . It follows from (18) that the numerators of the summands in the right hand side of (15) are exactly  $F(\mathrm{Tor}_{\mathbf{k}[v_1, \dots, v_m]}^{-i}(\mathbf{k}(K), \mathbf{k}); t)$ ,  $i = 1, \dots, m - n$ . Hence,

$$F(\mathbf{k}(K); t) = (1 - t^2)^{-m} \sum_{i=0}^{m-n} (-1)^i F(\mathrm{Tor}_{\mathbf{k}[v_1, \dots, v_m]}^{-i}(\mathbf{k}(K), \mathbf{k}); t).$$

Using Theorem 1.4.13 we get

$$\begin{aligned} F(\mathbf{k}(K); t) &= (1 - t^2)^{-m} \sum_{i=0}^{m-n} (-1)^i t^{2m} F(\mathrm{Tor}_{\mathbf{k}[v_1, \dots, v_m]}^{-(m-n)+i}(\mathbf{k}(K), \mathbf{k}); \frac{1}{t}) \\ &= (1 - (\frac{1}{t})^2)^{-m} (-1)^m \sum_{j=0}^{m-n} (-1)^{m-n-j} F(\mathrm{Tor}_{\mathbf{k}[v_1, \dots, v_m]}^{-j}(\mathbf{k}(K), \mathbf{k}); \frac{1}{t}) \\ &= (-1)^n F(\mathbf{k}(K); \frac{1}{t}). \end{aligned}$$

□

**Corollary 1.4.15.** *The Dehn–Sommerville relations  $h_i = h_{n-i}$ ,  $0 \leq i \leq n$ , hold for any Gorenstein\* complex  $K^{n-1}$  (in particular, for any simplicial sphere).*

*Proof.* This follows from Lemma 1.3.3 and Corollary 1.4.14. □

As it was pointed out by Stanley in [80], Gorenstein\* complexes are the most general objects appropriate for the generalisation of the  $g$ -theorem. (As we have seen, polytopal spheres,  $PL$  spheres, simplicial spheres and simplicial homology spheres are particular cases of Gorenstein\* complexes).

The Dehn–Sommerville equations can be generalized even beyond Gorenstein\* complexes. In [52] Klee reproved the Dehn–Sommerville equations in the form (10) in the more general context of *Eulerian manifolds*. In particular, this implies that equations (10) (with the exception of  $k = 0$ ) hold for any simplicial manifold  $K$  of dimension  $n - 1$ . (In the case  $k = 0$  equation (10) expresses that  $\chi(K^{n-1}) = \chi(S^{n-1})$ .) Analogues of equations (10) were obtained by Bayer and Billera [12] (for *Eulerian posets*) and Chen and Yan [30] (for arbitrary polyhedra).

In section 4.5 we obtain (by topological methods) the following form of the Dehn–Sommerville equations for simplicial manifolds:

$$h_{n-i} - h_i = (-1)^i (\chi(K^{n-1}) - \chi(S^{n-1})) \binom{n}{i}, \quad i = 0, 1, \dots, n.$$

where  $\chi(K^{n-1}) = f_0 - f_1 + \dots + (-1)^{n-1} f_{n-1} = 1 + (-1)^{n-1} h_n$  is the Euler characteristic of  $K^{n-1}$  and  $\chi(S^{n-1}) = 1 + (-1)^{n-1}$  is that of sphere. Note that if  $K$  is a simplicial sphere or has odd dimension, then the above equations reduce to the classical  $h_{n-i} = h_i$ .

**1.5. Cubical complexes and cubical maps.** Define a  $q$ -dimensional *combinatorial-geometrical cube* as a polytope combinatorially equivalent to the standard  $q$ -cube (3). In this section cubes are combinatorial-geometrical cubes.

**Definition 1.5.1.** A *cubical complex* is a subset  $\mathcal{C} \subset \mathbb{R}^n$  represented as a union of cubes of any dimensions in such a way that the intersection of any two cubes is a face of each.



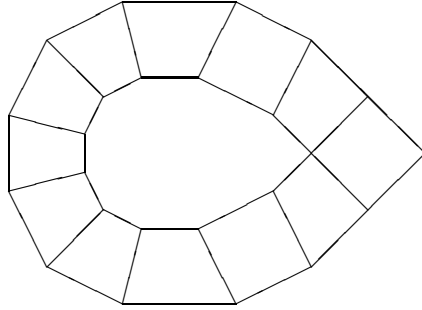

FIGURE 1. Cubical complex not embedable into cubical lattice

*Remark.* The above definition of cubical complex is similar to Definition 1.2.2 of geometrical simplicial complex. One could also define an *abstract cubical complex*, however this definition is more subtle (and we do not need it).

A *face* of a cubical complex  $\mathcal{C}$  is a face of a cube from  $\mathcal{C}$ . The *dimension* of  $\mathcal{C}$  is the maximal dimension of its faces. The *f-vector* of a cubical complex  $\mathcal{C}$  is defined in the standard way ( $f_i$  is the number of  $i$ -faces). Some problems concerning the  $f$ -vectors of cubical complexes are discussed in [82].

Obviously, the standard cube  $I^q$  (together with all its faces) is a  $q$ -dimensional cubical complex, which we also denote  $I^q$ . Any face of  $I^q$  has the form

$$(19) \quad C_{I \subset J} = \{(y_1, \dots, y_q) \in I^q : y_i = 0 \text{ for } i \in I, y_i = 1 \text{ for } i \notin J\},$$

where  $I \subset J$  are two (possibly empty) subsets of  $[q]$ . We denote  $C_J := C_{\emptyset \subset J}$ .

Unlike simplicial complexes (which are always subcomplexes of a simplex), not any cubical complex can be realised as a subcomplex of some  $I^q$ . One example of a cubical complex not embedable as a subcomplex in any  $I^q$  is shown on Figure 1. Moreover, this complex is not embedable into the standard cubical lattice in  $\mathbb{R}^q$  (for any  $q$ ). The authors are thankful to M. I. Shtogrin for giving this example.

There is the following problem.

**Problem 1.5.2** (S. P. Novikov). *Characterise  $k$ -dimensional cubical complexes  $\mathcal{C}$  (in particular, cubical manifolds) which admit*

- (a) *a (cubical) embedding into the standard cubical lattice in  $\mathbb{R}^q$ ;*
- (b) *a map to the standard cubical lattice in  $\mathbb{R}^q$  whose restriction to every  $k$ -dimensional cube identifies it with a certain  $k$ -face of the lattice.*

In the case when  $\mathcal{C}$  is homeomorphic to  $S^2$  the above problem was solved in [37]. Problem 1.5.2 is an extension of the following problem, formulated in [37].

**Problem 1.5.3** (S. P. Novikov). *Suppose we are given a 2-dimensional cubical mod 2 cycle  $\alpha$  in the standard cubical lattice in  $\mathbb{R}^3$ . Describe all maps of cubical subdivisions of 2-dimensional surfaces onto  $\alpha$  such that no two different squares are mapped to the same square of  $\alpha$ .*

As it was told to the authors by S. P. Novikov, problem 1.5.3 have arisen in connection with the 3-dimensional Ising model during the discussions with the well-known physicist A. M. Polyakov.

Below we introduce some special cubical complexes, which will play a pivotal rôle in our theory of moment-angle complexes. Each of these cubical complexes admits

a canonical cubical embedding into the standard cube. We note that the problem of embedability into the cubical lattice is closely connected with that of embedability into the standard cube. For instance, as it was shown in [37], if a cubical subdivision of a 2-dimensional surface is embedable into the standard cubical lattice in  $\mathbb{R}^q$ , then it also admits a cubical embedding into  $I^q$ .

**Construction 1.5.4** (canonical simplicial subdivision of  $I^m$ ). Let  $\Delta^{m-1}$  be the simplex on the set  $[m]$ , i.e.  $\Delta^{m-1}$  is the collection of all subsets of  $[m]$ . Assign to each subset  $I = \{i_1, \dots, i_k\} \subset [m]$  the vertex  $v_I := C_{I \subset I}$  of  $I^m$ . That is,  $v_I = (\varepsilon_1, \dots, \varepsilon_m)$ , where  $\varepsilon_i = 0$  if  $i \in I$  and  $\varepsilon_i = 1$  otherwise. Regarding  $I$  as a vertex of the barycentric subdivision of  $\Delta^{m-1}$ , we can extend the mapping  $I \mapsto v_I$  to the piecewise linear embedding  $i_c$  of the polyhedron  $|\text{bs}(\Delta^{m-1})|$  into the (boundary complex of) standard cube  $I^m$ . Under this embedding, the vertices of  $|\Delta^{m-1}|$  are mapped to the vertices  $(1, \dots, 1, 0, 1, \dots, 1) \in I^m$ , while the barycentre of  $|\Delta^{m-1}|$  is mapped to the vertex  $(0, \dots, 0) \in I^m$ . The image  $i_c(|\text{bs}(\Delta^{m-1})|)$  is the union of  $m$  facets of  $I^m$  meeting at the vertex  $(0, \dots, 0)$ . For any pair  $I, J$  of non-empty subsets of  $[m]$  such that  $I \subset J$  all simplices of  $\text{bs}(\Delta^{m-1})$  of the form  $I = I_1 \subset I_2 \subset \dots \subset I_k = J$  are mapped to the same face  $C_{I \subset J} \subset I^m$  (see (19)). The map  $i_c : |\text{bs}(\Delta^{m-1})| \rightarrow I^m$  extends to  $|\text{cone}(\text{bs}(\Delta^{m-1}))|$  by taking the vertex of the cone to  $(1, \dots, 1) \in I^m$ . The resulting map is denoted by  $\text{cone}(i_c)$ . Its image is the whole  $I^m$ . Hence  $\text{cone}(i_c) : |\text{cone}(\text{bs}(\Delta^{m-1}))| \rightarrow I^m$  is a *PL* homeomorphism linear on the simplices of  $|\text{cone}(\text{bs}(\Delta^{m-1}))|$ . This defines the *canonical triangulation* of  $I^m$ . Thus, the canonical triangulation of  $I^m$  arises from the identification of  $I^m$  with the cone over the barycentric subdivision of  $\Delta^{m-1}$ .

**Construction 1.5.5** (cubical subdivision of a simple polytope). Let  $P^n \subset \mathbb{R}^n$  be a simple polytope with  $m$  facets  $F_1^{n-1}, \dots, F_m^{n-1}$ . Choose a point in the relative interior of every face of  $P^n$  (including the vertices and the polytope itself). We get the set  $\mathcal{S}$  of  $1 + f_0 + f_1 + \dots + f_{n-1}$  points (here  $\mathbf{f}(P^n) = (f_0, f_1, \dots, f_{n-1})$  is the  $f$ -vector of  $P^n$ ). For each vertex  $v \in P^n$  define the subset  $\mathcal{S}_v \subset \mathcal{S}$  consisting of the points chosen inside the faces containing  $v$ . Since  $P^n$  is simple, the number of  $k$ -faces meeting at  $v$  is  $\binom{n}{k}$ ,  $0 \leq k \leq n$ . Hence,  $\#\mathcal{S}_v = 2^n$ . The set  $\mathcal{S}_v$  is the vertex set of an  $n$ -cube, which we denote  $C_v^n$ . The faces of  $C_v^n$  can be described as follows. Let  $G_1^k$  and  $G_2^l$  be two faces of  $P^n$  such that  $v \in G_1^k \subset G_2^l$ . Then there are exactly  $2^{l-k}$  faces  $G$  of  $P^n$  such that  $G_1^k \subset G \subset G_2^l$ . The corresponding  $2^{l-k}$  points from  $\mathcal{S}$  form the vertex set of an  $(l-k)$ -face of  $C_v^n$ . We denote this face  $C_{G_1 \subset G_2}^{l-k}$ . Every face of  $C_v^n$  is  $C_{G_1 \subset G_2}^i$  for some  $G_1, G_2$  containing  $v$ . The intersection of any two cubes  $C_v^n, C_{v'}^n$  is a face of each. Indeed, let  $G^i \subset P^n$  be the smallest face containing both vertices  $v$  and  $v'$ . Then  $C_v^n \cap C_{v'}^n = C_{G^i \subset P^n}^{n-i}$  is the face of both  $C_v^n$  and  $C_{v'}^n$ . Thus, we have constructed a cubical subdivision of  $P^n$  with  $f_{n-1}(P^n)$  cubes of dimension  $n$ . We denote this cubical complex  $\mathcal{C}(P^n)$ .

There is an embedding of  $\mathcal{C}(P^n)$  to  $I^m$  constructed as follows. Every  $(n-k)$ -face of  $P^n$  is the intersection of  $k$  facets:  $G^{n-k} = F_{i_1}^{n-1} \cap \dots \cap F_{i_k}^{n-1}$ . We map the corresponding point of  $\mathcal{S}$  to the vertex  $(\varepsilon_1, \dots, \varepsilon_m) \in I^m$ , where  $\varepsilon_i = 0$  if  $i \in \{i_1, \dots, i_k\}$  and  $\varepsilon_i = 1$  otherwise. This defines a mapping from the vertex set  $\mathcal{S}$  of  $\mathcal{C}(P^n)$  to the vertex set of  $I^m$ . Using the canonical triangulation of  $I^m$  (Construction 1.5.4) we extend this mapping to the *PL* embedding  $i_P : P^n \rightarrow I^m$ .

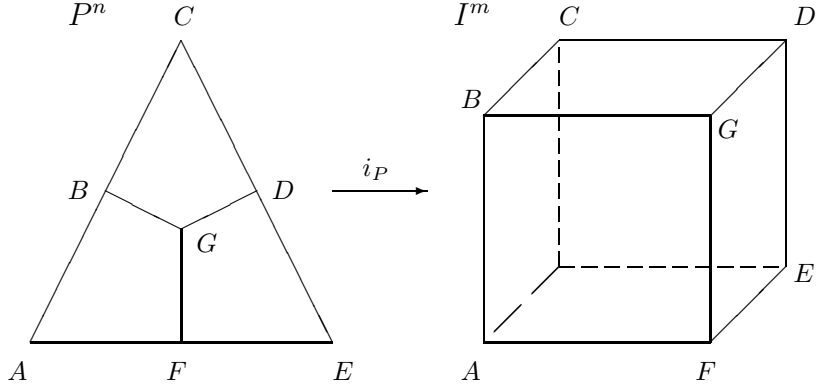
 FIGURE 2. The embedding  $i_P : P^n \rightarrow I^m$  for  $n = 2, m = 3$ .

For each vertex  $v = F_{i_1}^{n-1} \cap \dots \cap F_{i_n}^{n-1} \in P^n$  we have

$$(20) \quad i_P(C_v^n) = \{(y_1, \dots, y_m) \in I^m : y_j = 1 \text{ for } j \notin \{i_1, \dots, i_n\}\},$$

i.e.  $i_P(C_v^n) = C_{\{i_1, \dots, i_n\}} \subset I^m$  (in the notations of (19)). The embedding  $i_P : P^n \rightarrow I^m$  for  $n = 2, m = 3$  is shown on Figure 2.

We summarise the facts from the above construction in the following statement

**Theorem 1.5.6.** *A simple polytope  $P^n$  with  $m$  facets can be split into cubes  $C_v^n$ , one for each vertex  $v \in P^n$ . The resulting cubical complex  $\mathcal{C}(P^n)$  embeds canonically into the boundary of  $I^m$ , as described by (20).*

**Lemma 1.5.7.** *The number of  $k$ -faces of the cubical complex  $\mathcal{C}(P^n)$  is given by*

$$\begin{aligned} f_k(\mathcal{C}(P^n)) &= \sum_{i=0}^{n-k} \binom{n-i}{k} f_{n-i-1}(P^n) \\ &= \binom{n}{k} f_{n-1}(P^n) + \binom{n-1}{k} f_{n-2}(P^n) + \dots + f_{k-1}(P^n), \quad k = 0, \dots, n. \end{aligned}$$

*Proof.* This follows from the fact that the  $k$ -faces of  $\mathcal{C}(P^n)$  are in one-to-one correspondence with pairs  $G_1^i, G_2^{i+k}$  of faces of  $P^n$  such that  $G_1^i \subset G_2^{i+k}$ .  $\square$

**Construction 1.5.8.** Let  $K^{n-1}$  be a simplicial complex on  $[m]$ . Then  $K$  is naturally a subcomplex of  $\Delta^{m-1}$ , and  $\text{bs}(K)$  is a subcomplex of  $\text{bs}(\Delta^{m-1})$ . As it follows from Construction 1.5.4, there is a *PL* embedding  $i_c|_{\text{bs}(K)} : |\text{bs}(K)| \rightarrow I^m$ . The image  $i_c(|\text{bs}(K)|)$  is an  $(n-1)$ -dimensional cubical subcomplex of  $I^m$ , which we denote  $\text{cub}(K)$ . Then

$$(21) \quad \text{cub}(K) = \bigcup_{\emptyset \neq I \subset J \in K} C_{I \subset J} \subset I^m,$$

i.e.  $\text{cub}(K)$  is the union of faces  $C_{I \subset J} \subset I^m$  over all pairs  $I \subset J$  of non-empty simplices of  $K$ .

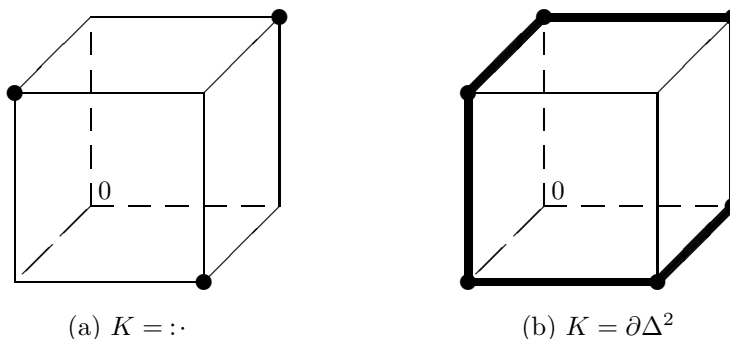
FIGURE 3. The cubical complex  $\text{cub}(K)$ .

**Construction 1.5.9.** Since  $\text{cone}(\text{bs}(K))$  is a subcomplex of  $\text{cone}(\text{bs}(\Delta^{m-1}))$ , Construction 1.5.4 also provides a *PL* embedding  $\text{cone}(i_c)|_{\text{cone}(\text{bs}(K))} : |\text{cone}(\text{bs}(K))| \rightarrow I^m$ . The image of this embedding is an  $n$ -dimensional cubical subcomplex of  $I^m$ , which we denote  $\text{cc}(K)$ . Then one easily obtains that

$$(22) \quad \text{cc}(K) = \bigcup_{J \in K} C_{I \subset J} \subset I^m.$$

Since  $C_{I \subset J} \subset C_{\emptyset \subset J} = C_J$ , we also can write  $\text{cc}(K) = \bigcup_{J \in K} C_J$ .

The following statement summarises the results of two previous constructions.

**Theorem 1.5.10.** *For any simplicial complex  $K$  on the set  $[m]$  there is a *PL* embedding of the polyhedron  $|K|$  into  $I^m$  linear on the simplices of  $\text{bs}(K)$ . The image of this embedding is the cubical subcomplex (21). Moreover, there is a *PL* embedding of the polyhedron  $|\text{cone}(K)|$  into  $I^m$  linear on the simplices of  $\text{cone}(\text{bs}(K))$ . The image of this embedding is the cubical subcomplex (22).*

As in the case of simplicial complexes, a cubical complex  $\mathcal{C}'$  is called a *cubical subdivision* of cubical complex  $\mathcal{C}$  if each cube of  $\mathcal{C}$  is a union of finitely many cubes of  $\mathcal{C}'$ .

**Proposition 1.5.11.** *For every cubical subcomplex  $\mathcal{C}$  there exists a cubical subdivision  $\mathcal{C}'$  that can be realised as a subcomplex of some  $I^q$ .*

*Proof.* Subdividing each cube of  $\mathcal{C}$  as described in Construction 1.5.4 we obtain a simplicial complex, say  $K_{\mathcal{C}}$ . Then applying Construction 1.5.8 to  $K_{\mathcal{C}}$  we get a cubical complex that subdivides  $|K_{\mathcal{C}}| = \mathcal{C}$  and embeds into some  $I^q$  (see Theorem 1.5.10) as the subcomplex  $\text{cub}(K_{\mathcal{C}})$ .  $\square$

**Example 1.5.12.** Figure 3 (a) shows the cubical complex  $\text{cub}(K)$  for the case when  $K$  is the disjoint union of 3 vertices ( $K = \cdot\cdot$ ). Figure 3 (b) shows that for the case when  $K$  is the boundary complex of a 2-simplex ( $K = \partial\Delta^2$ ). The cubical complexes  $\text{cc}(K)$  in both cases are indicated on Figure 4 (a) and (b).

*Remark.* As a topological space,  $\text{cub}(K)$  is homeomorphic to  $|K|$ , while  $\text{cc}(K)$  is homeomorphic to  $|\text{cone}(K)|$ . For simplicial complex  $\text{cone}(K)$  one may construct the cubical complex  $\text{cub}(\text{cone}(K))$ , which is also homeomorphic to  $|\text{cone}(K)|$ . However, as *cubical complexes*,  $\text{cc}(K)$  and  $\text{cub}(\text{cone}(K))$  differ (since  $\text{cone}(\text{bs}(K)) \neq \text{bs}(\text{cone}(K))$ ).

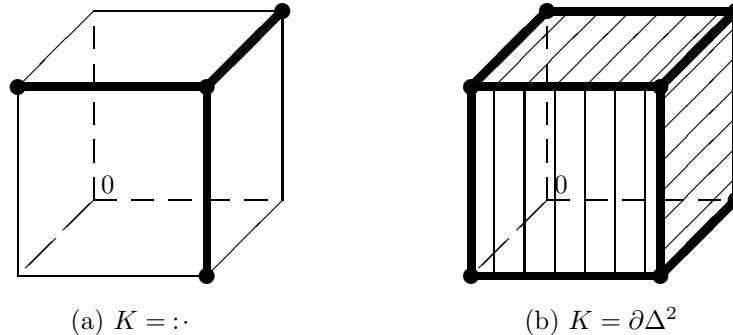
 FIGURE 4. The cubical complex  $\text{cc}(K)$ .

Let  $P$  be a simple  $n$ -polytope and  $K_P$  the corresponding simplicial  $(n-1)$ -sphere (the boundary of the polar simplicial polytope  $P^*$ ). Then  $\text{cc}(K_P)$  coincides with the cubical complex  $\mathcal{C}(P)$  from Construction 1.5.5 (more precisely,  $\text{cc}(K_P) = i_P(\mathcal{C}(P))$ ). Thus, the Construction 1.5.5 is a particular case of Construction 1.5.9.

*Remark.* Some versions of our previous constructions already appeared in the literature. A version of Construction 1.5.9 can be found in [33, p. 434] (it was used there for studying some torus actions; we return to this in the next chapter). A version of our cubical subcomplex  $\text{cub}(K) \subset I^m$  appeared in [75] in connection with Problem 1.5.2.

## 2. TORIC AND QUASITORIC MANIFOLDS

**2.1. Toric varieties.** Toric varieties appeared in algebraic geometry in the beginning of 1970's in connection with compactification problems for algebraic tori actions (see below). Very quickly the geometry of toric varieties became one of the most fascinating topics in algebraic geometry and found applications in many mathematical sciences, which otherwise seem far from algebraic geometry. We have already mentioned the proof of necessity of  $g$ -theorem for simplicial polytopes given by Stanley. Other remarkable applications include counting lattice points and volumes of lattice polytopes; relations with Newton polytopes and singularities (after Khovanskii and Kushnirenko); discriminants, resultants and hypergeometric functions (after Gelfand, Kapranov and Zelevinsky); reflexive polytopes and mirror symmetry for Calabi–Yau toric hypersurfaces (after Batyrev). The standard references in the toric geometry are Danilov's survey [32] and books by Fulton [40] and Oda [62]. More recent survey article by Cox [31] covers new applications, including mentioned above. We are not going to give a new survey of the toric geometry here. Instead, in this section we stress upon some topological and combinatorial aspects of toric varieties. We also give Stanley's argument for  $g$ -theorem.

Let  $\mathbb{C}^* = \mathbb{C} \setminus \{0\}$  denote the multiplicative group of complex numbers. The product  $(\mathbb{C}^*)^n$  of  $n$  copies of  $\mathbb{C}^*$  is known as the torus in the theory of algebraic groups. In topology, the *torus*  $T^n$  is the product of  $n$  circles. We keep the topological notations, referring to  $(\mathbb{C}^*)^n$  as the *algebraic torus*. The torus  $T^n$  is a subgroup of the algebraic torus  $(\mathbb{C}^*)^n$  in the standard way:

$$(23) \quad T^n = \{(e^{2\pi i\varphi_1}, \dots, e^{2\pi i\varphi_n}) \in \mathbb{C}^n\},$$

where  $(\varphi_1, \dots, \varphi_n)$  varies over  $\mathbb{R}^n$ .

**Definition 2.1.1.** A *toric variety* is a normal algebraic variety  $M$  containing the algebraic torus  $(\mathbb{C}^*)^n$  as a Zariski open subset in such a way that the natural action of  $(\mathbb{C}^*)^n$  on itself extends to an action on  $M$ .

Hence,  $(\mathbb{C}^*)^n$  acts on  $M$  with a dense orbit.

Every toric variety is encoded by a set of combinatorial data, namely by a (rational polyhedral) *fan* in some  $\mathbb{R}^n$ .

Let  $\mathbb{R}^n$  be the Euclidean space and  $\mathbb{Z}^n \subset \mathbb{R}^n$  the integral lattice. Given a finite set of vectors  $l_1, \dots, l_s \in \mathbb{R}^n$ , define the *convex polyhedral cone*  $\sigma$  spanned by  $l_1, \dots, l_s$  as

$$\sigma = \{r_1 l_1 + \dots + r_s l_s \in \mathbb{R}^n : r_i \geq 0\}.$$

Any convex polyhedral cone is a convex polyhedron in the sense of Definition 1.1.2. Hence, the *faces* of a convex polyhedral cone are defined. A cone  $\sigma$  is *rational* if its generator vectors  $l_1, \dots, l_s$  can be taken from  $\mathbb{Z}^n$  and is *strongly convex* if it contains no line through the origin. All cones considered below are strongly convex and rational. A cone is called *simplicial* (respectively *non-singular*) if it is generated by a part of a basis of  $\mathbb{R}^n$  (respectively  $\mathbb{Z}^n$ ). A *fan* is a set  $\Sigma$  of cones in some  $\mathbb{R}^n$  such that each face of a cone in  $\Sigma$  is also a cone in  $\Sigma$ , and the intersection of two cones in  $\Sigma$  is a face of each. A fan  $\Sigma$  is called *simplicial* (respectively *non-singular*) if all cones of  $\Sigma$  are simplicial (respectively non-singular). A fan  $\Sigma$  in  $\mathbb{R}^n$  is called *complete* if the union of all cones from  $\Sigma$  is  $\mathbb{R}^n$ .

A fan  $\Sigma$  in  $\mathbb{R}^n$  determines the toric variety  $M_\Sigma$  of complex dimension  $n$ , which orbit structure is described by the combinatorics of  $\Sigma$ . That is, the  $k$ -dimensional cones of  $\Sigma$  correspond to the codimension- $k$  orbits of the algebraic torus action on  $M_\Sigma$ . In particular, the  $n$ -dimensional cones correspond to the fixed points, while the origin corresponds to the unique dense orbit. The toric variety  $M_\Sigma$  is compact if and only if  $\Sigma$  is complete. If  $\Sigma$  is simplicial then  $M_\Sigma$  is an *orbifold* (i.e. locally homeomorphic to the quotient of  $\mathbb{R}^{2n}$  by a finite group action). Finally, if  $\Sigma$  is non-singular, then, as one should expect,  $M_\Sigma$  is non-singular (smooth). Smooth toric varieties sometimes are called *toric manifolds*.

Let  $\Sigma$  be a simplicial fan in  $\mathbb{R}^n$  with  $m$  one-dimensional cones (or *rays*). Choose generator vectors  $l_1, \dots, l_m$  for these  $m$  rays to be integer and primitive (i.e. with relatively prime integer coordinates). The fan  $\Sigma$  defines the simplicial complex  $K_\Sigma$  on the vertex set  $[m]$ , which is called the *underlying complex* of  $\Sigma$ . By definition,  $\{i_1, \dots, i_k\} \subset [m]$  is a simplex of  $K_\Sigma$  if  $l_{i_1}, \dots, l_{i_k}$  span a cone of  $\Sigma$ . It is easy to see that if  $\Sigma$  is complete, then  $K_\Sigma$  is a simplicial  $(n-1)$ -sphere.

Denote  $l_{ij} := (l_j)_i$ ,  $1 \leq i \leq n$ ,  $1 \leq j \leq m$ . Here  $l_j = (l_{1j}, \dots, l_{nj})^t \in \mathbb{Z}^n$ . Assign to each vector  $l_j$  the indeterminate  $v_j$  of degree 2, and define linear forms

$$\theta_i := l_{i1}v_1 + \dots + l_{im}v_m \in \mathbb{Z}[v_1, \dots, v_m], \quad 1 \leq i \leq n.$$

Denote by  $\mathcal{J}_\Sigma$  the ideal in  $\mathbb{Z}[v_1, \dots, v_m]$  spanned by these linear forms, i.e.  $\mathcal{J}_\Sigma = (\theta_1, \dots, \theta_n)$ . The images of  $\theta_1, \dots, \theta_n$  and  $\mathcal{J}_\Sigma$  in the Stanley–Reisner ring  $\mathbb{Z}(K_\Sigma) = \mathbb{Z}[v_1, \dots, v_m]/\mathcal{I}_{K_\Sigma}$  (see Definition 1.3.1) will be denoted by the same symbols  $\theta_1, \dots, \theta_n$  and  $\mathcal{J}_\Sigma$ .

**Theorem 2.1.2** (Danilov and Jurkiewicz). *Let  $\Sigma$  be a complete non-singular fan in  $\mathbb{R}^n$ , and  $M_\Sigma$  the corresponding toric variety. Then*

(a) The Betti numbers (the ranks of homology groups) of  $M_\Sigma$  vanish in odd dimensions, while in even dimensions are given by

$$b_{2i}(M_\Sigma) = h_i(K_\Sigma), \quad i = 0, 1, \dots, n,$$

where  $\mathbf{h}(K_\Sigma) = (h_0, \dots, h_n)$  is the  $h$ -vector of  $K_\Sigma$ .

(b) The closures of orbits corresponding to the one-dimensional cones of  $\Sigma$  are codimension-2 submanifolds (divisors)  $D_i$  of  $M_\Sigma$ . Let  $v_i$ ,  $1 \leq i \leq m$ , be the corresponding 2-dimensional cohomology classes. Then the cohomology ring of  $M_\Sigma$  is given by

$$H^*(M_\Sigma; \mathbb{Z}) \cong \mathbb{Z}[v_1, \dots, v_m] / (\mathcal{I}_{K_\Sigma} + \mathcal{J}_\Sigma) = \mathbb{Z}(K_\Sigma) / \mathcal{J}_\Sigma.$$

Moreover,  $\theta_1, \dots, \theta_n$  is a regular sequence in  $\mathbb{Z}(K_\Sigma)$ .

This theorem was proved by Jurkiewicz for projective smooth toric varieties and by Danilov [32, Theorem 10.8] in the general case. Note that the first part of Theorem 2.1.2 follows from the second part and Lemma 1.3.3.

Theorem 2.1.2 shows that the cohomology of  $M_\Sigma$  is identified with the Chow ring [40, § 5.1] of  $M_\Sigma$  and is generated by two-dimensional classes. Note that the ideal  $\mathcal{I}_{K_\Sigma}$  depends only on simplicial complex  $K_\Sigma$  (i.e. on the intersection lattice of fan), while  $\mathcal{J}_\Sigma$  depends on fan  $\Sigma$  itself.

*Remark.* As it was shown by Danilov, Theorem 2.1.2 remains true for simplicial fans and corresponding toric varieties if one replaces the coefficient ring  $\mathbb{Z}$  by any field of zero characteristic (e.g.  $\mathbb{Q}$ ).

**Construction 2.1.3** (Normal fan and toric varieties arising from polytopes). Suppose we are given an  $n$ -polytope (1) with vertices in the integer lattice  $\mathbb{Z}^n \subset \mathbb{R}^n$ . (Such polytopes are called integral (or *lattice*.) Then the vectors  $\mathbf{l}_i$  in (1),  $1 \leq i \leq m$ , can be chosen integer and primitive, and the numbers  $a_i$  can be chosen integer. Note that each  $\mathbf{l}_i$  is the normal vector of the facet  $F_i \subset P^n$  and  $\mathbf{l}_i$  is pointing inside the polytope  $P$ . Define the complete fan  $\Sigma(P)$  whose cones are generated by sets of normal vectors  $\mathbf{l}_{i_1}, \dots, \mathbf{l}_{i_k}$  such that the corresponding facets  $F_{i_1}, \dots, F_{i_k}$  have non-empty intersection in  $P$ . The fan  $\Sigma(P)$  is called the *normal fan* of  $P$ . Alternatively, if  $0 \in P$  then the normal fan consists of cones over the faces of the polar polytope  $P^*$ . Define the toric variety  $M_P := M_{\Sigma(P)}$ . The variety  $M_P$  is smooth if and only if  $P$  is simple and the normal vectors  $\mathbf{l}_{i_1}, \dots, \mathbf{l}_{i_n}$  of any set of  $n$  facets  $F_{i_1}, \dots, F_{i_n}$  meeting at the same vertex form a basis of  $\mathbb{Z}^n$ .

*Remark.* Any combinatorial simple polytope is *rational*, that is, admits a geometrical realisation with rational (or, equivalently, integer) vertex coordinates. Indeed, there is a small perturbation of defining inequalities in (1) that makes all of them rational but does not change the combinatorial type (since the half-spaces defined by the inequalities are in general position). As a result, one gets a simple polytope  $P'$  of the same combinatorial type with rational vertex coordinates. To obtain a realisation with integral vertex coordinates one should take the magnified polytope  $kP'$  for appropriate  $k \in \mathbb{Z}$ . Quite surprising thing is that there exist *non-rational* convex polytopes (non-simple and non-simplicial), see [89, Example 6.21]. Returning to simple polytopes, we note that different realisations of a given combinatorial simple polytope as lattice polytopes may produce different (even topologically) toric varieties  $M_P$ . At the same time there exist combinatorial simple polytopes that do not admit *any* geometrical realisation with smooth  $M_P$ . We discuss one such example in the next section (see Example 2.2.14).

In the rest of this section all polytopes are assumed to be simple. Construction 2.1.3 allows to define the simplicial fan  $\Sigma(P)$  and the toric variety  $M_P$  from any lattice simple polytope  $P$ . However, the polytope  $P$  contains more information than the fan  $\Sigma(P)$ . Indeed, besides the normal vectors  $\mathbf{l}_i$ , we also have numbers  $a_i \in \mathbb{Z}$ ,  $1 \leq i \leq m$ , (see (1)). The linear combination  $D = a_1 D_1 + \cdots + a_m D_m$  (see Theorem 2.1.2) is an *ample divisor*. It defines a projective embedding  $M_P \subset \mathbb{C}P^r$  for some  $r$  (which can be taken to be the number of vertices of  $P$ ). Thus, all toric varieties from polytopes are projective. Conversely, given a smooth projective toric variety  $M \subset \mathbb{C}P^r$ , one gets a very ample divisor (line bundle)  $D$  of a hyperplane section whose zero cohomology is generated by the sections corresponding to lattice points in a certain lattice simple polytope  $P$ . For this  $P$  one has  $M = M_P$ . Let  $\omega := a_1 v_1 + \cdots + a_m v_m \in H^2(M_P; \mathbb{Q})$  be the cohomology class of  $D$ .

**Theorem 2.1.4** (Hard Lefschetz theorem for toric varieties). *Let  $P^n$  be a lattice simple polytope (1),  $M_P$  the toric variety defined by  $P$ , and  $\omega = a_1 v_1 + \cdots + a_m v_m \in H^2(M_P; \mathbb{Q})$ . Then the maps*

$$H^{n-i}(M_P; \mathbb{Q}) \xrightarrow{\cdot \omega^i} H^{n+i}(M_P; \mathbb{Q}), \quad 1 \leq i \leq n,$$

are isomorphisms.

It follows from the projectivity that if  $M_P$  is smooth then it is Kähler, and  $\omega$  is the class of the Kähler 2-form.

*Remark.* If one replaces the ordinary cohomology by the *intersection cohomology*, then Theorem 2.1.4 holds for any projective toric variety, not necessarily arising from a simple lattice polytope (see the discussion in [40, § 5.2]).

**Example 2.1.5.** The complex projective space  $\mathbb{C}P^n = \{(z_0 : z_1 : \cdots : z_n), z_i \in \mathbb{C}\}$  is a toric variety.  $(\mathbb{C}^*)^n$  acts on  $\mathbb{C}P^n$  by  $(t_1, \dots, t_n) \cdot (z_0 : z_1 : \cdots : z_n) = (z_0 : t_1 z_1 : \cdots : t_n z_n)$ . Obviously,  $(\mathbb{C}^*)^n \subset \mathbb{C}^n \subset \mathbb{C}P^n$  is a dense open subset. The fan defining  $\mathbb{C}P^n$  consists of cones generated by all proper subsets of  $(n+1)$  vectors  $e_1, \dots, e_n, -e_1 - \cdots - e_n$  in  $\mathbb{R}^n$ . Theorem 2.1.2 identifies the cohomology ring  $H^*(\mathbb{C}P^n; \mathbb{Z}) = \mathbb{Z}[u]/(u^{n+1})$ ,  $\dim u = 2$ , with the quotient  $\mathbb{Z}[v_1, \dots, v_{n+1}]/(v_1 \cdots v_{n+1}, v_1 - v_{n+1}, \dots, v_n - v_{n+1})$ . The toric variety  $\mathbb{C}P^n$  arises from a polytope:  $\mathbb{C}P^n = M_P$ , where  $P$  is the standard  $n$ -simplex (2). The class  $\omega \in H^2(\mathbb{C}P^n; \mathbb{Q})$  from Theorem 2.1.4 in this case is  $\omega = v_{n+1}$ .

Now we are ready to give Stanley's argument for the necessity of  $g$ -theorem for simple polytopes.

*Proof of necessity of Theorem 1.1.17.* Realise the simple polytope as a lattice polytope  $P^n \subset \mathbb{R}^n$ . Let  $M_P$  be the corresponding toric variety. Part (a) is already proved (Theorem 1.1.11). It follows from Theorem 2.1.4 that the multiplication by  $\omega \in H^2(M_P; \mathbb{Q})$  is a monomorphism  $H^{2i-2}(M_P; \mathbb{Q}) \rightarrow H^{2i}(M_P; \mathbb{Q})$  for  $i \leq \lfloor \frac{n}{2} \rfloor$ . This together with the part (b) of Theorem 2.1.2 gives  $h_{i-1} \leq h_i$ ,  $0 \leq i \leq \lfloor \frac{n}{2} \rfloor$ , thus proving (b). To prove (c), define the graded commutative  $\mathbb{Q}$ -algebra  $A := H^*(M_P; \mathbb{Q})/(\omega)$ . Then  $A^0 = \mathbb{Q}$ ,  $A^{2i} = H^{2i}(M_P; \mathbb{Q})/\omega \cdot H^{2i-2}(M_P; \mathbb{Q})$  for  $1 \leq i \leq \lfloor \frac{n}{2} \rfloor$ , and  $A$  is generated by degree-two elements (since so is  $H^*(M_P; \mathbb{Q})$ ). It follows from Theorem 1.1.18 that the numbers  $\dim A^{2i} = h_i - h_{i-1}$ ,  $0 \leq i \leq \lfloor \frac{n}{2} \rfloor$ , are the components of an  $M$ -vector, thus proving (c) and the whole theorem.  $\square$



*Remark.* The Dehn–Sommerville equations now follow from the Poincaré duality for  $M_P$  (which holds also for singular  $M_P$  provided that  $P$  is simple).

Now we consider the action of the torus  $T^n \subset (\mathbb{C}^*)^n$  on a non-singular compact toric variety  $M$ . This action is locally equivalent to the standard action of  $T^n$  on  $\mathbb{C}^n$  (see the next section for the precise definition). The orbit space  $M/T^n$  is homeomorphic to an  $n$ -ball, invested with the topological structure of *manifold with corners* by the fixed point sets of appropriate subtori, see [40, § 4.1]. (Roughly speaking, a manifold with corners is a space that is locally modelled by open subsets of the positive cone  $\mathbb{R}_+^n$  (4). From this description it is easy to deduce the strict definition, see [49], which we omit here.)

**Construction 2.1.6.** Let  $P^n$  be a simple polytope. For any vertex  $v \in P^n$  denote by  $U_v$  the open subset of  $P^n$  obtained by deleting all faces not containing  $v$ . Obviously,  $U_v$  is diffeomorphic to  $\mathbb{R}_+^n$  (and even affinely isomorphic to an open set of  $\mathbb{R}_+^n$  containing 0). It follows that  $P^n$  is a manifold with corners, with atlas  $\{U_v\}$ .

If  $M = M_P$  arises from some (simple) polytope  $P^n$ , then the orbit space  $M/T^n$  is diffeomorphic, as a manifold with corners, to  $P^n$ . Furthermore, there exists an explicit map  $M_P \rightarrow \mathbb{R}^n$  (the *moment map*) with image  $P^n$  and  $T^n$ -orbits as fibres, see [40, §4.2]. (We consider relationships with moment maps and some aspects of symplectic geometry in more details in section 5.2.) Under this map, the interior of a codimension- $k$  face of  $P^n$  is identified with the set of orbits having the same  $k$ -dimensional isotropy subgroup. In particular, the action is free over the interior of the polytope. Regarded as a smooth manifold,  $M_P$  can be identified with quotient space  $T^n \times P^n / \sim$  for some equivalence relation  $\sim$ . Such description of the torus action on a non-singular toric variety motivated the appearance of an important topological analogue of toric varieties, namely, the theory of *quasitoric manifolds*.

**2.2. Quasitoric manifolds.** A quasitoric manifold is a smooth manifold with a torus action whose properties are similar to that of the (compact) torus action on a non-singular projective toric variety. This notion appeared in [33] under the name “toric manifold”. We use the term “quasitoric manifold”, since “toric manifold” is occupied in the algebraic geometry for “non-singular toric variety”. In the consequent definitions we follow [33], taking into account some adjustments from [26].

As in the previous section, we regard the torus  $T^n$  as the standard subgroup (23) in  $\mathbb{C}^*$ , therefore specifying the orientation and the coordinate subgroups  $T_i \cong S^1$ ,  $i = 1, \dots, n$ , in  $T^n$ . We refer to the representation of  $T^n$  by diagonal matrices in  $U(n)$  as the *standard* action on  $\mathbb{C}^n$ . The orbit space of this action is the positive cone  $\mathbb{R}_+^n$ . The canonical projection

$$T^n \times \mathbb{R}_+^n \rightarrow \mathbb{C}^n : (t_1, \dots, t_n) \times (x_1, \dots, x_n) \rightarrow (t_1 x_1, \dots, t_n x_n)$$

allows to identify  $\mathbb{C}^n$  with the quotient space  $T^n \times \mathbb{R}_+^n / \sim$  for some equivalence relation  $\sim$ , which will play an important rôle in our future considerations.

Let  $M^{2n}$  be a  $2n$ -dimensional manifold with an action of the torus  $T^n$ . Say that the  $T^n$ -action is *locally standard* if every point  $x \in M^{2n}$  lies in some  $T^n$ -invariant neighbourhood  $U(x)$  for which there exists a  $\psi$ -equivariant homeomorphism  $f : U(x) \rightarrow W$  with some ( $T^n$ -stable) open subset  $W \subset \mathbb{C}^n$ . That is, there is an automorphism  $\psi : T^n \rightarrow T^n$  such that  $f(t \cdot y) = \psi(t)f(y)$  for all  $t \in T^n$ ,  $y \in U(x)$ . The orbit space for a locally standard action of  $T^n$  on  $M^{2n}$  is an  $n$ -dimensional

manifold with corners. Quasitoric manifolds correspond to the important case when this orbit space is diffeomorphic, as manifold with corners, to a simple polytope  $P^n$ .

**Definition 2.2.1.** Given a simple polytope  $P^n$ , a manifold  $M^{2n}$  with locally standard  $T^n$ -action is said to be a *quasitoric manifold over  $P^n$*  if there is a projection map  $\pi : M^{2n} \rightarrow P^n$  whose fibres are the orbits of the action.

Under projection  $\pi$ , points that have same isotropy subgroup of codimension  $k$  are taken to the interior of a certain  $k$ -face of  $P^n$ . In particular, the action of  $T^n$  is free over the interior of  $P^n$ , while the vertices of  $P^n$  correspond to the  $T^n$ -fixed points of  $M^{2n}$ .

*Remark.* Two simple polytopes are combinatorially equivalent if and only if they are diffeomorphic as manifolds with corners.

Suppose  $P^n$  has  $m$  facets  $F_1, \dots, F_m$ . For every facet  $F_i$  the pre-image  $\pi^{-1}(F_i)$  is a submanifold  $M_i^{2(n-1)} \subset M^{2n}$  with isotropy subgroup a circle  $T(F_i)$  in  $T^n$ . Then

$$(24) \quad T(F_i) = \{ (e^{2\pi i \lambda_{1i} \varphi}, \dots, e^{2\pi i \lambda_{ni} \varphi}) \in T^n \},$$

where  $\varphi \in \mathbb{R}$  and  $\boldsymbol{\lambda}_i = (\lambda_{1i}, \dots, \lambda_{ni})^t \in \mathbb{Z}^n$  is a primitive vector. This  $\boldsymbol{\lambda}_i$  is determined by  $T(F_i)$  only up to a sign. The choice of this sign specifies an orientation of  $T(F_i)$ . For now we do not care about this sign and choose it arbitrary. More detailed treatment of these signs is the subject of the next section. We refer to  $\boldsymbol{\lambda}_i$  as the *facet vector* corresponding to  $F_i$ . The action of  $T^n/T(F_i)$  on  $M_i$  describes it as a quasitoric manifold over  $F_i$ . The correspondence

$$(25) \quad \ell : F_i \mapsto T(F_i)$$

is called the *characteristic map* of  $M^{2n}$ . Suppose we have a codimension- $k$  face  $G^{n-k}$  written as the intersection of  $k$  facets:  $G^{n-k} = F_{i_1} \cap \dots \cap F_{i_k}$ . Then the submanifolds  $M_{i_1}, \dots, M_{i_k}$  intersect transversally in a *facial submanifold*  $M(G)^{2(n-k)}$ . The map  $T(F_{i_1}) \times \dots \times T(F_{i_k}) \rightarrow T^n$  is injective since  $T(F_{i_1}) \times \dots \times T(F_{i_k})$  is identified with the  $k$ -dimensional isotropy subgroup of  $M(G)^{2(n-k)}$ . It follows that the vectors  $\boldsymbol{\lambda}_{i_1}, \dots, \boldsymbol{\lambda}_{i_k}$  form a part of integral basis of  $\mathbb{Z}^n$ .

Let  $\Lambda$  be the integer  $(n \times m)$ -matrix whose  $i$ -th column is formed by the coordinates of the facet vector  $\boldsymbol{\lambda}_i$ ,  $i = 1, \dots, m$ . Each vertex  $v \in P^n$  is the intersection of  $n$  facets:  $v = F_{i_1} \cap \dots \cap F_{i_n}$ . Let  $\Lambda_{(v)} := \Lambda_{(i_1, \dots, i_n)}$  be the maximal minor of  $\Lambda$  formed by the columns  $i_1, \dots, i_n$ . Then

$$(26) \quad \det \Lambda_{(v)} = \pm 1.$$

The correspondence

$$G^{n-k} \mapsto \text{isotropy subgroup of } M(G)^{2(n-k)}$$

extends the characteristic map (25) to a map from the face lattice of  $P^n$  to the lattice of subtori of  $T^n$ .

Like in the case of standard action of  $T^n$  on  $\mathbb{C}^n$ , there is a projection  $T^n \times P^n \rightarrow M^{2n}$  whose fibre over  $x \in M^{2n}$  has the form (isotropy subgroup of  $x$ )  $\times$  (orbit of  $x$ ). This argument can be used for reconstructing the quasitoric manifold from any given pair  $(P^n, \ell)$ , where  $P^n$  is a (combinatorial) simple polytope and  $\ell$  is a map from facets of  $P^n$  to one-dimensional subgroups of  $T^n$  such that  $\ell(F_{i_1}) \times \dots \times \ell(F_{i_k}) \rightarrow T^n$  is injective whenever  $F_{i_1} \cap \dots \cap F_{i_k} \neq \emptyset$ . Such  $(P^n, \ell)$  is called a *characteristic pair*. The map  $\ell$  directly extends to a map from the face lattice of  $P^n$  to the lattice of subtori of  $T^n$ .

**Construction 2.2.2** (Quasitoric manifold from a characteristic pair). Note that each point  $q$  of  $P^n$  lies in the relative interior of a unique face  $G(q)$ . Now construct the identification space  $(T^n \times P^n)/\sim$ , where  $(t_1, q) \sim (t_2, q)$  if and only if  $t_1 t_2^{-1}$  lies in the subtorus  $\ell(G(q))$ . The free action of  $T^n$  on  $T^n \times P^n$  obviously descends to an action on  $(T^n \times P^n)/\sim$  with quotient  $P^n$ . The latter action is free over the interior of  $P^n$  and has a fixed point for each vertex of  $P^n$ . Just as  $P^n$  is covered by the open sets  $U_v$ , based on the vertices and diffeomorphic to  $\mathbb{R}_+^n$  (see Construction 2.1.6), so the space  $(T^n \times P^n)/\sim$  is covered by open sets  $(T^n \times U_v)/\sim$  homeomorphic to  $(T^n \times \mathbb{R}_+^n)/\sim$ , and therefore to  $\mathbb{C}^n$ . This implies that the  $T^n$ -action on  $(T^n \times P^n)/\sim$  is locally standard, and therefore  $M^{2n}(\ell) := (T^n \times P^n)/\sim$  is a quasitoric manifold.

Given an automorphism  $\psi : T^n \rightarrow T^n$ , say that two quasitoric manifolds  $M_1^{2n}$ ,  $M_2^{2n}$  over the same  $P^n$  are  $\psi$ -equivariantly diffeomorphic if there is a diffeomorphism  $f : M_1^{2n} \rightarrow M_2^{2n}$  such that  $f(t \cdot x) = \psi(t)f(x)$  for all  $t \in T^n$ ,  $x \in M_1^{2n}$ . The automorphism  $\psi$  induces an automorphism  $\psi_*$  of the lattice of subtori of  $T^n$ . Any such automorphism descends to a  $\psi$ -translation of characteristic pairs, in which the two characteristic maps differ by  $\psi_*$ . The following proposition is proved in [26, Proposition 2.6] and generalises Proposition 1.8 of [33].

**Proposition 2.2.3.** *For any automorphism  $\psi$ , Construction 2.2.2 defines a bijection between  $\psi$ -equivariant diffeomorphism classes of quasitoric manifolds and  $\psi$ -translations of pairs  $(P^n, \ell)$ .*

When  $\psi$  is the identity, we deduce that two quasitoric manifolds are equivariantly diffeomorphic if and only if their characteristic maps are the same.

Now we are going to construct a cellular decomposition of  $M^{2n}$  with only even dimensional cells and calculate the Betti numbers accordingly, following [33].

**Construction 2.2.4.** We recall ‘‘Morse-theoretical arguments’’ from the proof of Dehn–Sommerville relations (Theorem 1.1.11). There we turned the 1-skeleton of  $P^n$  into a directed graph and defined the index  $\text{ind}(v)$  of a vertex  $v \in P^n$  as the number of incident edges that point towards  $v$ . These inward edges define a face  $G_v$  of dimension  $\text{ind}(v)$ . Denote by  $\widehat{G}_v$  the subset of  $G_v$  obtained by deleting all faces not containing  $v$ . Obviously,  $\widehat{G}_v$  is diffeomorphic to  $\mathbb{R}_+^{\text{ind}(v)}$  and is contained in the open set  $U_v \subset P^n$  from Construction 2.1.6. Then  $e_v := \pi^{-1}\widehat{G}_v$  is identified with  $\mathbb{C}^{\text{ind}(v)}$ , and the union of the  $e_v$  over all vertices of  $P^n$  define a cell decomposition of  $M^{2n}$ . Note that all cells are even-dimensional and the closure of the cell  $e_v$  is the facial submanifold  $M(G_v)^{2\text{ind}(v)} \subset M^{2n}$ . This construction was earlier used by Khovanskii [50] for constructing cellular decompositions of toric varieties.

**Proposition 2.2.5.** *The Betti numbers of  $M^{2n}$  vanish in odd dimensions, while in even dimensions are given by*

$$b_{2i}(M^{2n}) = h_i(P^n), \quad i = 0, 1, \dots, n,$$

where  $\mathbf{h}(P^n) = (h_0, \dots, h_n)$  is the  $h$ -vector of  $P^n$ .

*Proof.* The  $2i$ -th Betti number equals the number of  $2i$ -dimensional cells in the cellular decomposition constructed above. This number equals the number of vertices of index  $i$ , which is  $h_i(P^n)$  by the argument from the proof of Theorem 1.1.11.  $\square$

Given a quasitoric manifold  $M^{2n}$  with characteristic map (25) and facet vectors  $\lambda_i = (\lambda_{1i}, \dots, \lambda_{ni})^t \in \mathbb{Z}^n$ ,  $i = 1, \dots, m$ , define linear forms

$$(27) \quad \theta_i := \lambda_{i1}v_1 + \dots + \lambda_{im}v_m \in \mathbb{Z}[v_1, \dots, v_m], \quad 1 \leq i \leq n.$$

The images of these linear forms in the face ring  $\mathbb{Z}(P^n)$  will be denoted by the same letters.

**Lemma 2.2.6** (Davis and Januszkiewicz). *For any quasitoric manifold  $M^{2n}$  over  $P^n$ , the sequence  $\theta_1, \dots, \theta_n$  is a (degree-two) regular sequence in  $\mathbb{Z}(P^n)$ .*

Let  $\mathcal{J}_\ell$  denote the ideal in  $\mathbb{Z}(P^n)$  generated by  $\theta_1, \dots, \theta_n$ .

**Theorem 2.2.7** (Davis and Januszkiewicz). *Let  $v_i$ ,  $1 \leq i \leq m$ , be the 2-dimensional cohomology classes dual to the submanifolds  $M_i^{2(n-1)} \subset M^{2n}$ . Then the cohomology ring of  $M^{2n}$  is given by*

$$H^*(M^{2n}; \mathbb{Z}) \cong \mathbb{Z}[v_1, \dots, v_m]/(\mathcal{I}_P + \mathcal{J}_\ell) = \mathbb{Z}(P^n)/\mathcal{J}_\ell.$$

We give proofs for the above two statements in section 3.4.

*Remark.* Change of sign of vector  $\lambda_i$  corresponds to passing from  $v_i$  to  $-v_i$  in the description of the cohomology ring from Theorem 2.2.7. This fact will be crucial in the next section.

**Example 2.2.8.** A non-singular projective toric variety  $M_P$  arising from a lattice simple polytope  $P^n$  is a quasitoric manifold over  $P^n$ . The corresponding characteristic map  $\ell : F_i \mapsto T(F_i)$  is defined by (24), where  $\lambda_i = (\lambda_{1i}, \dots, \lambda_{ni})^t$  are the normal vectors  $l_i$  of facets of  $P^n$ ,  $i = 1, \dots, m$  (see (1)). The corresponding characteristic  $n \times m$ -matrix  $\Lambda$  is the matrix  $L$  from Construction 1.1.4. In particular, if  $P^n$  is the standard simplex  $\Delta^n$  (2) then  $M_P$  is  $\mathbb{C}P^n$  (Example 2.1.5) and  $\Lambda = (E \mid -\mathbf{1})$ , where  $E$  is the unit  $n \times n$ -matrix and  $\mathbf{1}$  is the column of units. See also Example 2.4.14 below.

Generally, a non-singular toric variety is not necessarily a quasitoric manifold: although the orbit space (for the action of  $T^n$ ) is a manifold with corners (see section 2.1), it may fail to be diffeomorphic (or combinatorially equivalent) to a simple polytope. The authors are thankful to N. Strickland for drawing our attention to this fact. However, we do not know any such example. In [40, p. 71] one can find the example of a complete non-singular fan  $\Sigma$  in  $\mathbb{R}^3$  which can not be obtained by taking the cones with vertex 0 over the faces of a geometrical simplicial polytope. Nevertheless, since the corresponding simplicial complex  $K_\Sigma$  is a simplicial 2-sphere, it is combinatorially equivalent to a polytopal 2-sphere. This means that the non-singular toric variety  $M_\Sigma$ , although being non-projective, is still a quasitoric manifold.

**Problem 2.2.9.** *Give an example of a non-singular toric variety which is not a quasitoric manifold.*

This problem seems to be not very hard and reduces to constructing a complete non-singular fan  $\Sigma$  whose associated simplicial complex  $K_\Sigma$  is the Barnette sphere or any other non-polytopal  $PL$ -sphere (see section 1.2). As it was pointed out by N. Strickland, the definition of quasitoric manifold can be modified in such a way that non-singular toric varieties become quasitoric manifolds. For this purpose, the simple polytope in Definition 2.2.1 is to be replaced by the polytopal complex

dual to a simplicial sphere. The corresponding constructions are currently being developed.

On the other hand, it is easy to construct a quasitoric manifold which is not a toric variety. The simplest example is the manifold  $\mathbb{C}P^2 \# \mathbb{C}P^2$  (the connected sum of two copies of  $\mathbb{C}P^2$ ). It is a quasitoric manifold over the square  $I^2$  (this follows from the construction of equivariant connected sum, see [33, 1.11], section 2.3 and corollary 2.5.5 below). However,  $\mathbb{C}P^2 \# \mathbb{C}P^2$  do not admit even an almost complex structure (i.e. a complex structure in the tangent bundle). The following problem arises.

**Problem 2.2.10.** *Let  $P^n$  be simple polytope with  $m$  facets,  $\ell$  a characteristic map (25), and  $M^{2n}(\ell)$  the derived quasitoric manifold (Construction 2.2.2). Find conditions on  $P^n$  and  $\ell$  so that  $M^{2n}(\ell)$  admits a  $T^n$ -invariant complex (respectively almost complex) structure.*

The almost complex case of the above problem was formulated in [33, Problem 7.6]. Example 2.2.8 (characteristic functions of lattice polytopes) provides a sufficient condition for Problem 2.2.10 (since a non-singular toric variety is a complex manifold). However, this condition is obviously non-necessary even for the existence of a complex structure. Indeed, there are non-singular (non-projective) toric varieties that do not arise from any lattice simple polytope (see the already mentioned example from [40, p. 71]). At the same time, we do not know any example of *non-toric* complex quasitoric manifold.

**Problem 2.2.11.** *Find an example of a non-toric quasitoric manifold that admits a  $T^n$ -invariant complex structure.*

Although a general quasitoric manifold may fail to be complex or almost complex, it always admits a  $T^n$ -invariant complex structure on the *stable* tangent bundle. The corresponding constructions are the subject of the next section.

Another class of problems arises in connection with the classification of quasitoric manifolds over a given combinatorial simple polytope. The general setting of this problem is the subject of section 2.5. Example 2.2.14 below shows that there are combinatorial simple polytopes that do not admit a characteristic map (and therefore can not arise as orbit spaces for quasitoric manifolds).

**Problem 2.2.12.** *Give a combinatorial description of the class of polytopes  $P^n$  that admit a characteristic map (25).*

A generalisation of this problem is given in section 4.4 (Problem 4.4.1).

A characteristic map is determined by an integer  $n \times m$ -matrix  $\Lambda$  which satisfies (26) for every vertex  $v \in P^n$ . The equation  $(\det \Lambda_{(v)})^2 = 1$  defines a hypersurface in the space  $\mathcal{M}(n, m; \mathbb{Z})$  of integer  $n \times m$ -matrices. Problem 2.2.12 can be reformulated in the following way.

**Proposition 2.2.13.** *The set of characteristic matrices coincides with the intersection*

$$(28) \quad \bigcap_{v \in P^n} \{(\det \Lambda_{(v)})^2 = 1\}$$

*of hypersurfaces in the space  $\mathcal{M}(n, m; \mathbb{Z})$ , where  $v$  varies over the vertices of the polytope  $P^n$ .*

**Example 2.2.14** (polytope that do not admit a characteristic function, [33, Example 1.22]).

Suppose  $P^n$  is a 2-neighbourly simple polytope with  $m \geq 2^n$  facets (e.g. the polar of the cyclic polytope  $C^n(m)$  (Example 1.1.9) with  $n \geq 4$  and  $m \geq 2^n$ ). Then  $P^n$  does not admit a characteristic map, and therefore can not appear as the quotient space for a quasitoric manifold. Indeed, by Proposition 2.2.13, it is sufficient to show that intersection (28) is empty. Since  $m \geq 2^n$ , any matrix  $\Lambda \in \mathcal{M}(n, m; \mathbb{Z})$  (without zero columns) contains two columns, say  $i$ -th and  $j$ -th, which coincide modulo 2. Since  $P^n$  is 2-neighbourly, the corresponding facets  $F_i$  and  $F_j$  have non-empty intersection in  $P^n$ . Hence, columns  $i$  and  $j$  of  $\Lambda$  enter some minor of the form  $\Lambda_{(v)}$ . This implies that the determinant of this minor is even and intersection (28) is empty.

**2.3. Stably complex structures and quasitoric representatives in cobordism classes.** This section is the review of results obtained by N. Ray and the first author in [25] and [26] supplied with some additional comments.

A *stably complex structure* on a (smooth) manifold  $M$  is defined by a complex structure on the vector bundle  $\tau(M) \oplus \mathbb{R}^k$  for some  $k$ , where  $\tau(M)$  is the *tangent bundle* of  $M$  and  $\mathbb{R}^k$  denotes the trivial real  $k$ -bundle over  $M$ . A *stably complex manifold* (in other notations, *weakly almost complex manifold* or *U-manifold*) is a manifold with fixed stably complex structure, that is, a pair  $(M, \xi)$ , where  $\xi$  is a complex bundle isomorphic, as a real bundle, to  $\tau(M) \oplus \mathbb{R}^k$  for some  $k$ . If  $M$  itself is a complex manifold, then it possesses the *canonical* stably complex structure  $(M, \tau(M))$ . The operations of disjoint union and product endow the set of cobordism classes  $[M, \xi]$  of stably complex manifolds with the structure of a graded ring, called the *complex cobordism ring*  $\Omega^U$ . By the theorem of Milnor and Novikov,  $\Omega^U \cong \mathbb{Z}[a_1, a_2, \dots]$ ,  $\deg a_i = 2i$  (see [61], [83]). The ring  $\Omega^U$  serves as the coefficient ring for a generalised (co)homology theory known as the *complex (co)bordisms*.

Stably complex manifolds were the main subject of F. Hirzebruch's talk at the 1958 International Congress of mathematicians (see [86]). Using *Milnor hypersurfaces* (Example 2.3.10) and the Milnor–Novikov theorem it was shown that every complex cobordism class contains a non-singular algebraic variety (not necessarily connected). The following problem is still open.

**Problem 2.3.1** (Hirzebruch). *Which cobordism classes in  $\Omega^U$  contain connected non-singular algebraic varieties?*

**Example 2.3.2.** The 2-dimensional cobordism group  $\Omega_2^U \cong \mathbb{Z}$  is generated by the class of  $[\mathbb{C}P^1]$  (Riemannian sphere). Every cobordism class  $k[\mathbb{C}P^1] \in \Omega_2^U$  contains a non-singular algebraic variety, namely, the disjoint union of  $k$  copies of  $\mathbb{C}P^1$  for  $k > 0$  and the disjoint union of  $k$  copies of a genus 2 Riemannian surface for  $k < 0$ . However, a *connected* algebraic variety is contained only in cobordism classes  $k[\mathbb{C}P^1]$  for  $k \leq 1$ .

The problem of choice of appropriate generators for the ring  $\Omega^U$  plays a pivotal rôle in the cobordism theory and its applications. In this section we give a solution of the quasitoric analogue of problem 2.3.1, recently obtained in [25] and [26]. This solution relies upon an important additional structure on a quasitoric manifold, namely, the *omniorientation*, which provides a canonical stably complex structure described in the combinatorial terms.

Let  $\pi : M^{2n} \rightarrow P^n$  be a quasitoric manifold with characteristic map  $\ell$ . Since the torus  $T^n$  (23) is oriented, a choice of orientation for  $P^n$  is equivalent to a choice

of orientation for  $M^{2n}$ . (An orientation of  $P^n$  is specified by orienting the ambient space  $\mathbb{R}^n$ .)

**Definition 2.3.3.** An *omniorientation* of a quasitoric manifold  $M^{2n}$  consists of a choice of an orientation for  $M^{2n}$  and for every submanifold  $M_i^{2(n-1)} = \pi^{-1}(F_i)$ ,  $i = 1, \dots, m$ .

There are therefore  $2^{m+1}$  omniorientations in all for given  $M^{2n}$ .

An omniorientation of  $M^{2n}$  determines an orientation for every normal bundle  $\nu_i := \nu(M_i \subset M^{2n})$ ,  $i = 1, \dots, m$ . Since every  $\nu_i$  is a real 2-plane bundle, an orientation of  $\nu_i$  allows to interpret it as a complex line bundle. The isotropy subgroup  $T(F_i)$  of the submanifold  $M_i^{2(n-1)} = \pi^{-1}(F_i)$  acts on the normal bundle  $\nu_i$ ,  $i = 1, \dots, m$ . Thus, we have the following statement.

**Proposition 2.3.4.** *A choice of omniorientation for  $M^{2n}$  is equivalent to a choice of orientation for  $P^n$  together with an unambiguous choice of facet vectors  $\lambda_i$ ,  $i = 1, \dots, m$  in (24).*

We refer to a characteristic map  $\ell$  as *directed* if all circles  $\ell(F_i)$ ,  $i = 1, \dots, m$ , are oriented. This implies that signs of the facet vectors  $\lambda_i = (\lambda_{1i}, \dots, \lambda_{ni})^t$ ,  $i = 1, \dots, m$ , are determined unambiguously. In the previous section we organised the facet vectors into the integer  $n \times m$  matrix  $\Lambda$ . This matrix satisfies (26). Due to (24), knowing a matrix  $\Lambda$  is equivalent to knowing a directed characteristic map. Let  $\mathbb{Z}^{\mathcal{F}}$  denote the  $m$ -dimensional free  $\mathbb{Z}$ -module spanned by the set  $\mathcal{F}$  of facets of  $P^n$ . Then  $\Lambda$  defines an epimorphism  $\lambda : \mathbb{Z}^{\mathcal{F}} \rightarrow \mathbb{Z}^n$  by  $\lambda(F_i) = \lambda_i$  and an epimorphism  $T^{\mathcal{F}} \rightarrow T^m$ , which we denote by the same letter  $\lambda$ . In the sequel we write  $\mathbb{Z}^m$  for  $\mathbb{Z}^{\mathcal{F}}$  and  $T^m$  for  $T^{\mathcal{F}}$  with the agreement that the vector  $e_i$  of the standard basis of  $\mathbb{Z}^m$  corresponds to  $F_i \in \mathcal{F}$ ,  $i = 1, \dots, m$  (and the same for  $T^m$ ). A *directed characteristic pair*  $(P^n, \Lambda)$  consists of a simple polytope  $P^n$  and an integer matrix  $\Lambda$  (or, equivalently, an epimorphism  $\lambda : \mathbb{Z}^m \rightarrow \mathbb{Z}^n$ ) that satisfies (26).

Proposition 2.3.4 shows that the characteristic pair of an omnioriented quasitoric manifold is directed. On the other hand, the quasitoric manifold derived from a directed characteristic pair by Construction 2.2.2 is omnioriented.

**Construction 2.3.5.** The orientation of the bundle  $\nu_i$  over  $M_i$  defines an integral Thom class in the cohomology group  $H^2(M(\nu_i))$ , represented by a complex line bundle over the Thom complex  $M(\nu_i)$ . We pull this back along the Pontryagin–Thom collapse  $M^{2n} \rightarrow M(\nu_i)$ , and denote the resulting bundle  $\rho_i$ . The restriction of  $\rho_i$  to  $M_i \subset M^{2n}$  is  $\nu_i$ .

**Theorem 2.3.6** ([26, Theorem 3.8]). *Every omniorientation of a quasitoric manifold  $M^{2n}$  determines a stably complex structure on it by means of the following isomorphism of real  $2m$ -bundles:*

$$\tau(M^{2n}) \oplus \mathbb{R}^{2(m-n)} \cong \rho_1 \oplus \dots \oplus \rho_m.$$

It follows that a directed characteristic pair  $(P^n, \Lambda)$  determines a complex cobordism class  $[M^{2n}, \rho_1 \oplus \dots \oplus \rho_m] \in \Omega^U$ . At the same time, the above constructions can be directly applied to computing the complex cobordism ring  $\Omega_U^*(M^{2n})$  of an omnioriented quasitoric manifold.

**Theorem 2.3.7** ([26, Proposition 5.3]). *Let  $v_i$  denote the first cobordism Chern class  $c_1(\rho_i) \in \Omega_U^2(M^{2n})$  of the bundle  $\rho_i$ ,  $1 \leq i \leq m$ . Then the cobordism ring of*

$M^{2n}$  is given by

$$\Omega_U^*(M^{2n}) \cong \Omega^U[v_1, \dots, v_m]/(\mathcal{I}_P + \mathcal{J}_\Lambda),$$

where the ideals  $\mathcal{I}_P$  and  $\mathcal{J}_\Lambda$  are defined in the same way as in Theorem 2.2.7.

Note that the Chern class  $c_1(\rho_i)$  is Poincaré dual to the inclusion  $M_i^{2(n-1)} \subset M^{2n}$  by construction of  $\rho_i$ . This highlights the remarkable fact that the complex bordism groups  $\Omega_*^U(M^{2n})$  are spanned by *embedded* submanifolds. By definition, the fundamental cobordism class  $\langle M^{2n} \rangle \in \Omega_U^{2n}(M^{2n})$  is dual to the bordism class of a point. Thus,  $\langle M^{2n} \rangle = v_{i_1} \cdots v_{i_n}$  for any set  $i_1, \dots, i_n$  such that  $F_{i_1} \cap \cdots \cap F_{i_n}$  is a vertex of  $P^n$ .

**Example 2.3.8** (bounded flag manifold [24]). A *bounded flag* in  $\mathbb{C}^{n+1}$  is a complete flag  $U = \{U_1 \subset U_2 \subset \cdots \subset U_{n+1} = \mathbb{C}^{n+1}\}$  for which  $U_k$  contains the coordinate subspace  $\mathbb{C}^{k-1}$  (spanned by the first  $k-1$  standard basis vectors) for  $2 \leq k \leq n$ . As it is shown in [26, Example 2.8], the  $2n$ -dimensional manifold  $B_n$  of all bounded flags in  $\mathbb{C}^{n+1}$  is a quasitoric manifold over the cube  $I^n$  with respect to the action induced by  $t \cdot z = (t_1 z_1, \dots, t_n z_n, z_{n+1})$  on  $\mathbb{C}^{n+1}$  (here  $t \in T^n$ ).

**Example 2.3.9.** A family of manifolds  $B_{i,j}$ ,  $0 \leq i \leq j$ , is introduced in [25]. The manifold  $B_{i,j}$  consists of pairs  $(U, W)$ , where  $U$  is a bounded flag in  $\mathbb{C}^{i+1}$  (see Example 2.3.8) and  $W$  is a line in  $U_1^\perp \oplus \mathbb{C}^{j-i}$ . So  $B_{i,j}$  is a smooth  $\mathbb{C}P^{j-1}$ -bundle over  $B_i$ . It is shown in [26, Example 2.9] that  $B_{i,j}$  is a quasitoric manifold over the product  $I^i \times D^{j-1}$ .

The canonical stably complex structures and omniorientations on the manifolds  $B_n$  and  $B_{i,j}$  are described in [26, examples 4.3, 4.5].

*Remark.* The product of two quasitoric manifolds  $M_1^{2n_1}$  and  $M_2^{2n_2}$  over polytopes  $P_1^{n_1}$  and  $P_2^{n_2}$  is a quasitoric manifold over  $P_1^{n_1} \times P_2^{n_2}$ . This construction extends to omnioriented quasitoric manifolds and is compatible with stably complex structures (details can be found in [26, Proposition 4.7]).

It is shown in [25] that the cobordism classes of  $B_{i,j}$  multiplicatively generate the ring  $\Omega^U$ . So every  $2n$ -dimensional complex cobordism class may be represented by a disjoint union of products

$$(29) \quad B_{i_1, j_1} \times B_{i_2, j_2} \times \cdots \times B_{i_k, j_k},$$

where  $\sum_{q=1}^k (i_q + j_q) - 2k = n$ . Each such component is a quasitoric manifold, under the product quasitoric structure. This result is the substance of [25]. The stably complex structures of products (29) are induced by omniorientations, and are therefore also preserved by the torus action.

**Example 2.3.10.** The standard set of multiplicative generators for  $\Omega^U$  consists of projective spaces  $\mathbb{C}P^i$ ,  $i \geq 0$ , and *Milnor hypersurfaces*  $H_{i,j} \subset \mathbb{C}P^i \times \mathbb{C}P^j$ ,  $1 \leq i \leq j$ . The hypersurfaces  $H_{i,j}$  are defined by

$$H_{i,j} = \left\{ (z_0 : \cdots : z_i) \times (w_0 : \cdots : w_j) \in \mathbb{C}P^i \times \mathbb{C}P^j : \sum_{q=0}^i z_q w_q = 0 \right\}.$$

However, as it was shown in [25], the hypersurfaces  $H_{i,j}$  are *not* quasitoric manifolds for  $i \geq 2$ .



To give genuinely toric representatives (which are, by definition, connected) for each cobordism class of dimension  $> 2$ , it remains only to replace the disjoint union of products (29) with their connected sum. This is done in [26, §6] using Construction 1.1.7 and its extension to omnioriented quasitoric manifolds.

**Theorem 2.3.11** (Buchstaber and Ray). *In dimensions  $> 2$ , every complex cobordism class contains a quasitoric manifold, necessarily connected, whose stably complex structure is induced by an omniorientation, and is therefore compatible with the action of the torus.*

This theorem gives a solution to the quasitoric analogue of Problem 2.3.1.

**2.4. Combinatorial formulae for Hirzebruch genera of quasitoric manifolds.** The constructions from the previous section open the way to evaluation of cobordism invariants (Chern numbers, Hirzebruch genera etc.) on omnioriented quasitoric manifolds in terms of the combinatorics of the quotient. In this section we expose the results obtained in this direction by the second author in [68], [69]. Namely, using arguments similar to that from the proof of Theorem 1.1.11 we construct a circle action with only isolated fixed points on any quasitoric manifold  $M^{2n}$ . If  $M^{2n}$  is omnioriented, then this action preserves the stably complex structure and its local representations near fixed points are retrieved from the characteristic matrix  $\Lambda$ . This allows to calculate Hirzebruch’s  $\chi_y$ -genus as the sum of contributions corresponding to the vertices of polytope. These contributions depend only on the “local combinatorics” near the vertex. After some adjustments the formula also allows to calculate the signature and the Todd genus of  $M^{2n}$ .

**Definition 2.4.1.** The *Hirzebruch genus* associated with the series

$$Q(x) = 1 + \sum q_k x^k, \quad q_k \in \mathbb{Q},$$

is the ring homomorphism  $\varphi_Q : \Omega^U \rightarrow \mathbb{Q}$  that to each cobordism class  $[M^{2n}] \in \Omega_{2n}^U$  assigns the value given by the formula

$$\varphi_Q[M^{2n}] = \left( \prod_{i=1}^n Q(x_i), \langle M^{2n} \rangle \right).$$

Here  $M^{2n}$  is a smooth manifold whose stable tangent bundle  $\tau(M^{2n})$  is a complex bundle with complete Chern class in cohomology

$$c(\tau) = 1 + c_1(\tau) + \cdots + c_n(\tau) = \prod_{i=1}^n (1 + x_i),$$

and  $\langle M^{2n} \rangle$  is a fundamental class in homology.

The  $\chi_y$ -genus is the Hirzebruch genus associated with the series

$$Q(x) = \frac{x(1 + ye^{-x(1+y)})}{1 - e^{-x(1+y)}},$$

where  $y \in \mathbb{R}$  is a parameter. In particular cases  $y = -1, 0, 1$  we obtain the  $n$ -th Chern number, the *Todd genus* and the *signature* of the manifold  $M^{2n}$  correspondingly.

Provided that  $M^{2n}$  is a complex manifold, the value  $\chi_y(M^{2n})$  can be calculated in terms of Euler characteristics of the *Dolbeault complexes* on  $M^{2n}$ . The general information about Hirzebruch genera can be found in [45].

In this section we assume that we are given an omnioriented quasitoric manifold  $M^{2n}$  over some  $P^n$  with characteristic matrix  $\Lambda$ . This specifies a stably complex structure on  $M^{2n}$ , as described in the previous section. The orientation of  $M^{2n}$  defines the fundamental class  $\langle M^{2n} \rangle \in H_{2n}(M^{2n}; \mathbb{Z})$ .

**Construction 2.4.2.** Suppose  $v$  is a vertex of  $P^n$  expressed as the intersection of  $n$  facets:

$$(30) \quad v = F_{i_1} \cap \cdots \cap F_{i_n}.$$

Assign to each facet  $F_{i_k}$  the edge  $E_k := \bigcap_{j \neq k} F_{i_j}$  (that is,  $E_k$  contains  $v$  and is opposite to  $F_{i_k}$ ). Let  $\mathbf{e}_k$  be a vector along  $E_k$  beginning at  $v$ . Then  $\mathbf{e}_1, \dots, \mathbf{e}_n$  is a basis of  $\mathbb{R}^n$ , which may be either positively or negatively oriented depending on the ordering of facets in (30). Throughout this section this ordering is assumed to be so that  $\mathbf{e}_1, \dots, \mathbf{e}_n$  is a positively oriented basis.

Once we specified an ordering of facets in (30), the facet vectors  $\boldsymbol{\lambda}_{i_1}, \dots, \boldsymbol{\lambda}_{i_n}$  at  $v$  may in turn constitute either positively or negatively oriented basis depending on the sign of the determinant of  $\Lambda_{(v)} = (\boldsymbol{\lambda}_{i_1}, \dots, \boldsymbol{\lambda}_{i_n})$  (see (26)).

**Definition 2.4.3.** The *sign* of a vertex  $v = F_{i_1} \cap \cdots \cap F_{i_n}$  of  $P^n$  is

$$\sigma(v) := \det \Lambda_{(v)}.$$

The collection of signs of vertices of  $P^n$  provides an important invariant of an oriented omnioriented quasitoric manifold. Note that reversing the orientation of  $M^{2n}$  changes all signs  $\sigma(v)$  to the opposite. At the same time changing the direction of a facet vector reverses the signs only for the vertices contained in the corresponding facet.

Let  $E$  be an edge of  $P^n$ . The isotropy subgroup of the 2-dimensional submanifold  $\pi^{-1}(E) \subset M^{2n}$  is an  $(n-1)$ -dimensional subtorus, which we denote by  $T(E)$ . Then we can write

$$(31) \quad T(E) = \{ (e^{2\pi i \varphi_1}, \dots, e^{2\pi i \varphi_n}) \in T^n : \mu_1 \varphi_1 + \dots + \mu_n \varphi_n = 0 \}$$

for some integers  $\mu_1, \dots, \mu_n$ . We refer to  $\boldsymbol{\mu} := (\mu_1, \dots, \mu_n)^t$  as the *edge vector* corresponding to  $E$ . This  $\boldsymbol{\mu}$  is a primitive vector in the dual lattice  $(\mathbb{Z}^n)^*$ ; it is determined by  $E$  only up to a sign. There is no canonical way to fix these signs simultaneously for all edges. However, the following lemma shows that the omniorientation of  $M^{2n}$  provides a canonical way to choose signs of edge vectors “locally” at each vertex.

**Lemma 2.4.4.** *For any vertex  $v \in P^n$ , signs of edge vectors  $\boldsymbol{\mu}_1, \dots, \boldsymbol{\mu}_n$  meeting at  $v$  can be chosen in such way that the  $n \times n$ -matrix  $M_{(v)} := (\boldsymbol{\mu}_1, \dots, \boldsymbol{\mu}_n)$  satisfies the identity*

$$M_{(v)}^t \cdot \Lambda_{(v)} = E,$$

where  $E$  is the identity matrix. In other words,  $\boldsymbol{\mu}_1, \dots, \boldsymbol{\mu}_n$  and  $\boldsymbol{\lambda}_{i_1}, \dots, \boldsymbol{\lambda}_{i_n}$  are conjugate bases.

*Proof.* At the beginning we choose signs of the edge vectors at  $v$  arbitrary, and express  $v$  as in (30). Then  $\boldsymbol{\mu}_k$  is the edge vector corresponding to the edge  $E_k$  opposite to  $F_{i_k}$ ,  $k = 1, \dots, n$ . It follows that  $E_k \subset F_{i_l}$  and  $T(F_{i_l}) \subset T(E_k)$  for  $l \neq k$ . Hence,

$$(32) \quad \langle \boldsymbol{\mu}_k, \boldsymbol{\lambda}_{i_l} \rangle = 0, \quad l \neq k,$$

(see (24) and (31)). Since  $\boldsymbol{\mu}_k$  is a primitive vector, it follows from (32) that  $\langle \boldsymbol{\mu}_k, \boldsymbol{\lambda}_{i_k} \rangle = \pm 1$ . Changing the sign of  $\boldsymbol{\mu}_{i_k}$  if necessary, we obtain

$$\langle \boldsymbol{\mu}_k, \boldsymbol{\lambda}_{i_k} \rangle = 1,$$

which together with (32) gives  $M_{(v)}^t \cdot \Lambda_{(v)} = E$ , as needed.  $\square$

In the sequel we assume that signs of edge vectors at each  $v$  are chosen as in the above lemma. It follows that the edge vectors  $\boldsymbol{\mu}_1, \dots, \boldsymbol{\mu}_n$  meeting at  $v$  constitute an integer basis of  $\mathbb{Z}^n$  and

$$(33) \quad \det M_{(v)} = \sigma(v).$$

Suppose  $M^{2n} = M_P$  is a smooth toric variety arising from a lattice simple polytope  $P$  defined by (1). Then  $\boldsymbol{\lambda}_i = \boldsymbol{l}_i$ ,  $i = 1, \dots, m$  (see Example 2.2.8), while the edge vectors at  $v \in P^n$  are the primitive integer vectors  $\boldsymbol{e}_1, \dots, \boldsymbol{e}_n$  along the edges beginning at  $v$ . It follows from Construction 2.4.2 that  $\sigma(v) = 1$  for any  $v$ . Lemma 2.4.4 in this case expresses the fact that  $\boldsymbol{e}_1, \dots, \boldsymbol{e}_n$  and  $\boldsymbol{l}_{i_1}, \dots, \boldsymbol{l}_{i_n}$  are conjugate bases of  $\mathbb{Z}^n$ . Similarly, the following statement holds.

**Proposition 2.4.5.** *Suppose that the omniorientation of the quasitoric manifold  $M^{2n}$  arises from a  $T^m$ -invariant almost complex structure (i.e. complex structure in the tangent bundle  $\tau(M^{2n})$ ). Then  $\sigma(v) = 1$  for any vertex  $v \in P^n$ .*

*Proof.* The orientation of  $P^n$  is determined by the canonical orientation of the almost complex manifold  $M^{2n}$  and the orientation of the torus (23). Since the almost complex structure on  $M^{2n}$  is  $T^n$ -invariant, it induces almost complex structures on the  $T(F_i)$ -fixed submanifolds  $M_i^{2(n-1)}$ . It follows that for any vertex (30) the vectors  $\boldsymbol{\lambda}_{i_1}, \dots, \boldsymbol{\lambda}_{i_n}$  constitute a positively oriented basis of  $\mathbb{R}^n$ .  $\square$

Proposition 2.4.5 provides a necessary condition for the existence of a  $T^n$ -invariant almost complex structure on  $M^{2n}$  (see Problem 2.2.10).

*Remark.* Globally Lemma 2.4.4 provides two directions (signs) for an edge vector, one for each of its ends. These signs are always different provided that  $M^{2n}$  is a complex manifold (e.g. a smooth toric variety), but in general this fails to be true.

Let  $\boldsymbol{\nu} = (\nu_1, \dots, \nu_n)^t \in \mathbb{Z}^n$  be a primitive vector such that

$$(34) \quad \langle \boldsymbol{\mu}, \boldsymbol{\nu} \rangle \neq 0 \quad \text{for any edge vector } \boldsymbol{\mu}.$$

The vector  $\boldsymbol{\nu}$  defines the one-dimensional oriented subtorus

$$T_{\boldsymbol{\nu}} := \{ (e^{2\pi i \nu_1 \varphi}, \dots, e^{2\pi i \nu_n \varphi}) \in T^n : \varphi \in \mathbb{R} \}.$$

**Lemma 2.4.6** ([69, Theorem 2.1]). *For any  $\boldsymbol{\nu}$  satisfying (34) the circle  $T_{\boldsymbol{\nu}}$  acts on  $M^{2n}$  with only isolated fixed points (corresponding to the vertices of  $P^n$ ). For each vertex  $v = F_{i_1} \cap \dots \cap F_{i_n}$  the action of  $T_{\boldsymbol{\nu}}$  induces a representation of  $S^1$  in the tangent space  $T_v M^{2n}$  with weights  $\langle \boldsymbol{\mu}_1, \boldsymbol{\nu} \rangle, \dots, \langle \boldsymbol{\mu}_n, \boldsymbol{\nu} \rangle$ .*

*Remark.* If  $M^{2n} = M_P$  is a smooth toric variety, then the genericity condition (34) is equivalent to that from the proof of Theorem 1.1.11.

**Definition 2.4.7.** Suppose we are given a primitive vector  $\boldsymbol{\nu}$  satisfying (34). Define the *index* of a vertex  $v \in P^n$  as the number of negative weights of the  $S^1$ -representation in  $T_v M^{2n}$  from Lemma 2.4.6. That is, if  $v = F_{i_1} \cap \dots \cap F_{i_n}$ , then

$$\text{ind}_{\boldsymbol{\nu}}(v) = \{ \#k : \langle \boldsymbol{\mu}_k, \boldsymbol{\nu} \rangle < 0 \}.$$

*Remark.* The index of a vertex  $v$  can be also defined in terms of the facet vectors at  $v$ . Indeed, Lemma 2.4.4 shows that if  $v = F_{i_1} \cap \cdots \cap F_{i_n}$ , then

$$\boldsymbol{\nu} = \langle \boldsymbol{\mu}_1, \boldsymbol{\nu} \rangle \boldsymbol{\lambda}_{i_1} + \cdots + \langle \boldsymbol{\mu}_n, \boldsymbol{\nu} \rangle \boldsymbol{\lambda}_{i_n}.$$

Hence,  $\text{ind}_{\boldsymbol{\nu}}(v)$  equals the number of negative coefficients in the representation of  $\boldsymbol{\nu}$  as a linear combination of basis vectors  $\boldsymbol{\lambda}_{i_1}, \dots, \boldsymbol{\lambda}_{i_n}$ .

**Theorem 2.4.8** ([68, Theorem 6], [69, Theorem 3.1]). *For any  $\boldsymbol{\nu}$  satisfying (34), the  $\chi_y$ -genus of  $M^{2n}$  can be calculated as*

$$\chi_y(M^{2n}) = \sum_{v \in P^n} (-y)^{\text{ind}_{\boldsymbol{\nu}}(v)} \sigma(v).$$

This theorem is proved by applying the Atiyah–Hirzebruch formula [6] to the circle action defined in Lemma 2.4.6.

The value of the  $\chi_y$ -genus  $\chi_y(M^{2n})$  at  $y = -1$  equals the  $n$ -th Chern number  $c_n(\xi)\langle M^{2n} \rangle$  for any  $2n$ -dimensional stably complex manifold  $[M^{2n}, \xi]$ . In quasitoric case Theorem 2.4.8 gives

$$(35) \quad c_n[M^{2n}] = \sum_{v \in P^n} \sigma(v).$$

If  $M^{2n}$  is a complex manifold (e.g. a smooth toric variety), then  $\sigma(v) = 1$  for all vertices  $v \in P^n$  and  $c_n[M^{2n}]$  equals the Euler characteristic  $e(M^{2n})$ . Hence, for complex  $M^{2n}$  the Euler characteristic equals the number of vertices of  $P^n$  (which is well known for toric varieties). For general quasitoric  $M^{2n}$  the Euler characteristic is also equal to the number of vertices of  $P^n$  (since the Euler characteristic of any  $S^1$ -manifold equals the sum of Euler characteristics of fixed submanifolds), however the latter number may differ from  $c_n[M^{2n}]$  (see Example 2.4.15 below).

The value of the  $\chi_y$ -genus at  $y = 1$  is the *signature* (or the *L-genus*). Theorem 2.4.8 gives in this case

**Corollary 2.4.9.** *The signature of an omnioriented quasitoric manifold  $M^{2n}$  can be calculated as*

$$\text{sign}(M^{2n}) = \sum_{v \in P^n} (-1)^{\text{ind}_{\boldsymbol{\nu}}(v)} \sigma(v).$$

Being an invariant of an *oriented* cobordism class, the signature of  $M^{2n}$  does not depend on a stably complex structure (i.e. on an omniorientation) and is determined only by an orientation of  $M^{2n}$  (or  $P^n$ ). The following modification of Corollary 2.4.9 provides a formula for  $\text{sign}(M^{2n})$  that does not depend on an omniorientation.

**Corollary 2.4.10** ([69, Corollary 3.3]). *The signature of an oriented quasitoric manifold  $M^{2n}$  can be calculated as*

$$\text{sign}(M^{2n}) = \sum_{v \in P^n} \det(\tilde{\boldsymbol{\mu}}_1, \dots, \tilde{\boldsymbol{\mu}}_n),$$

where  $\tilde{\boldsymbol{\mu}}_k$ ,  $k = 1, \dots, n$ , are the edge vectors at  $v$  oriented in such way that  $\langle \tilde{\boldsymbol{\mu}}_k, \boldsymbol{\nu} \rangle > 0$ .

If  $M^{2n} = M_P$  is a smooth toric variety, then  $\sigma(v) = 1$  for any  $v \in P^n$ , and Corollary 2.4.9 gives

$$\text{sign}(M_P) = \sum_{v \in P^n} (-1)^{\text{ind}_{\boldsymbol{\nu}}(v)}.$$

Since in this case the index  $\text{ind}_\nu(v)$  is the same as the index from the proof of Theorem 1.1.11, we obtain

$$(36) \quad \text{sign}(M_P) = \sum_{k=1}^n (-1)^k h_k(P).$$

Note that if  $n$  is odd, then the right hand side of the above formula vanishes due to the Dehn–Sommerville equations. The formula (36) appears in a more general context in recent work of Leung and Reiner [55]. The quantity in the right hand side of (36) arises in the following well known combinatorial conjecture.

**Problem 2.4.11** (Charney–Davis conjecture). *Let  $K$  be a  $(2q - 1)$ -dimensional Gorenstein\* flag complex with  $h$ -vector  $(h_0, h_1, \dots, h_{2q})$ . Is it true that*

$$(-1)^q (h_0 - h_1 + \dots + h_{2q}) \geq 0?$$

This conjecture was made in [29, Conjecture D] for flag simplicial homology spheres. Stanley [82, Problem 4] proposed to extend it to Gorenstein\* complexes. The Charney–Davis conjecture is closely connected with the following differential-geometrical conjecture.

**Problem 2.4.12** (Hopf conjecture). *Let  $M^{2q}$  be a Riemannian manifold of non-positive sectional curvature. Is it true that the Euler characteristic  $\chi(M^{2n})$  satisfies the inequality*

$$(-1)^q \chi(M^{2q}) \geq 0?$$

Both above conjectures are known to be true for  $q = 1, 2$  and for some special cases. More details can be found in [29]. For more relations of the two problems with the signature of a toric variety see [55].

Now we turn again to the  $\chi_y$ -genus of an omnioriented quasitoric manifold. The next important particular case is the *Todd genus* corresponding to  $y = 0$ . In this case the summands in the formula from Theorem 2.4.8 are not defined for the vertices of index 0, so it requires some additional analysis.

**Theorem 2.4.13** ([68, Theorem 7], [69, Theorem 3.4]). *The Todd genus of an omnioriented quasitoric manifold can be calculated as*

$$\text{td}(M^{2n}) = \sum_{v \in P^n: \text{ind}_\nu(v)=0} \sigma(v)$$

(the sum is taken over all vertices of index 0).

In the case of smooth toric variety there is only one vertex of index 0. This is the “bottom” vertex of  $P^n$ , which has all incident edges pointing out (in the notations used in the proof of Theorem 1.1.11). Since  $\sigma(v) = 1$  for every  $v \in P^n$ , Theorem 2.4.13 gives  $\text{td}(M_P) = 1$ , which is well known (see e.g. [40, §5.3]; for algebraic varieties the Todd genus equals the *arithmetic genus*).

If  $M^{2n}$  is an almost complex manifold, then  $\text{td}(M^{2n}) > 0$  by Proposition 2.4.5 and Theorem 2.4.13.

**Example 2.4.14.** The projective space  $\mathbb{C}P^2$ , regarded as a toric variety, arises from the standard lattice 2-simplex  $\Delta^2$  (with vertices  $v_1 = (0, 0)$ ,  $v_2 = (1, 0)$ ,  $v_3 = (0, 1)$ ). The orientation is standard (determined by the complex structure). The omniorientation is determined by the facet vectors  $\lambda_1, \lambda_2, \lambda_3$ , which in this case are the primitive normal vectors pointing inside the polytope. The edge vectors are

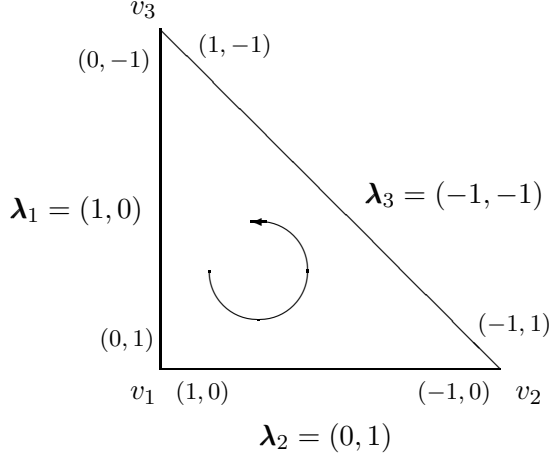
FIGURE 5.  $\tau(\mathbb{C}P^2) \oplus \mathbb{C} \simeq \bar{\eta} \oplus \bar{\eta} \oplus \bar{\eta}$ 

the primitive vectors along edges pointing out of the vertex. This can be seen on Figure 5. The corresponding stably complex structure is the standard one, that is, determined by the isomorphism of bundles  $\tau(\mathbb{C}P^2) \oplus \mathbb{R}^2 \cong \bar{\eta} \oplus \bar{\eta} \oplus \bar{\eta}$ , where  $\eta$  is the canonical Hopf line bundle. Let us calculate the Todd genus and the signature from Corollary 2.4.9 and Theorem 2.4.13. We have  $\sigma(v_1) = \sigma(v_2) = \sigma(v_3) = 1$ . Take  $\nu = (1, 2)$ , then  $\text{ind}_\nu(v_1) = 0$ ,  $\text{ind}_\nu(v_2) = 1$ ,  $\text{ind}_\nu(v_3) = 2$  (recall that the index is the number of negative scalar products of edge vectors with  $\nu$ ). Thus,  $\text{sign}(\mathbb{C}P^2) = \text{sign}[\mathbb{C}P^2, \bar{\eta} \oplus \bar{\eta} \oplus \bar{\eta}] = 1$ ,  $\text{td}(\mathbb{C}P^2) = \text{td}[\mathbb{C}P^2, \bar{\eta} \oplus \bar{\eta} \oplus \bar{\eta}] = 1$ .

**Example 2.4.15.** Now consider  $\mathbb{C}P^2$  with the omniorientation determined by the three facet vectors  $\lambda_1, \lambda_2, \lambda_3$  shown on Figure 6. This omniorientation differs from the previous example by the sign of  $\lambda_3$ . The corresponding stably complex structure is determined by the isomorphism  $\tau(\mathbb{C}P^2) \oplus \mathbb{R}^2 \cong \bar{\eta} \oplus \bar{\eta} \oplus \eta$ . Using (33) we calculate

$$\sigma(v_1) = \begin{vmatrix} 1 & 0 \\ 0 & 1 \end{vmatrix} = 1, \quad \sigma(v_2) = \begin{vmatrix} -1 & 1 \\ 1 & 0 \end{vmatrix} = -1, \quad \sigma(v_3) = \begin{vmatrix} 0 & 1 \\ 1 & -1 \end{vmatrix} = -1.$$

For  $\nu = (1, 2)$  we find  $\text{ind}_\nu(v_1) = 0$ ,  $\text{ind}_\nu(v_2) = 0$ ,  $\text{ind}_\nu(v_3) = 1$ . Thus,  $\text{sign}[\mathbb{C}P^2, \bar{\eta} \oplus \bar{\eta} \oplus \eta] = 1$ ,  $\text{td}[\mathbb{C}P^2, \bar{\eta} \oplus \bar{\eta} \oplus \eta] = 0$ . Note that in this case formula (35) gives  $c_n[\mathbb{C}P^2, \bar{\eta} \oplus \bar{\eta} \oplus \eta] = \sigma(v_1) + \sigma(v_2) + \sigma(v_3) = -1$ , while the Euler number of  $\mathbb{C}P^2$  is  $c_n[\mathbb{C}P^2, \bar{\eta} \oplus \bar{\eta} \oplus \eta] = 3$ .

$T^n$ -equivariant stably complex and almost complex manifolds were considered in works of Hattori [44] and Masuda [57] as a separate generalisation (called the *unitary toric manifolds*) of toric varieties. Instead of Davis and Januszkiewicz's characteristic maps, Masuda in [57] uses the notion of *multi-fan* to describe the combinatorial structure of the orbit space. The multi-fan is a collection of cones which may overlap unlike a usual fan. The Todd genus of a unitary toric manifold was calculated in [57] via the degree of the overlap of cones in the multi-fan. This result is equivalent to our Theorem 2.4.13 in the case of quasitoric manifolds.

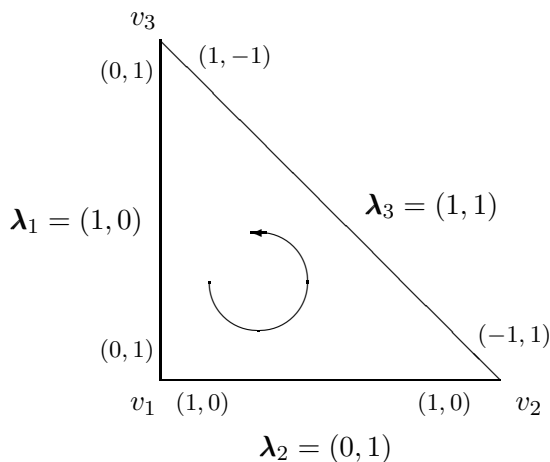
 FIGURE 6.  $\tau(\mathbb{C}P^2) \oplus \mathbb{C} \simeq \bar{\eta} \oplus \bar{\eta} \oplus \eta$ 

**2.5. The classification problem for quasitoric manifolds over a given simple polytope.** More precisely, there are two classification problems: the equivariant (i.e. up to an equivariant diffeomorphism) and the topological (i.e. up to a diffeomorphism). Due to Proposition 2.2.3, the equivariant classification problem reduces to the description of all characteristic maps for given simple polytope  $P^n$ . The topological classification problem usually requires an additional analysis.

Let  $M^{2n}$  be a quasitoric manifold over  $P^n$  with characteristic map  $\ell$ . We suppose here that the first  $n$  facets  $F_1, \dots, F_n$  share a common vertex.

**Lemma 2.5.1.** *Up to  $\psi$ -equivalence, we may assume that  $\ell(F_i)$  is the  $i$ -th coordinate subtorus  $T_i \subset T^n$ ,  $i = 1, \dots, n$ .*

*Proof.* Since the one-dimensional subtori  $\ell(F_i)$ ,  $i = 1, \dots, n$ , generate  $T^n$ , we may define  $\psi$  as any automorphism of  $T^n$  that maps  $\ell(F_i)$  to  $T_i$ ,  $i = 1, \dots, n$ .  $\square$

It follows that  $M^{2n}$  admits such an omniorientation that the corresponding characteristic  $n \times m$ -matrix  $\Lambda$  has the form  $(E | *)$ , where  $E$  is the identity matrix and  $*$  is a certain integer  $n \times (m - n)$ -matrix.

In the simplest case  $P^n = \Delta^n$  the equivariant (and topological) classification of quasitoric manifolds reduces to the following easy result.

**Proposition 2.5.2.** *Any quasitoric manifold over the simplex  $\Delta^n$  is equivariantly diffeomorphic to  $\mathbb{C}P^n$  (regarded as a toric variety, see examples 2.1.5 and 2.2.8).*

*Proof.* The characteristic map for  $\mathbb{C}P^n$  has the form

$$\ell_{\mathbb{C}P^n}(F_i) = T_i, \quad i = 1, \dots, n, \quad \ell_{\mathbb{C}P^n}(F_{n+1}) = S_d,$$

where  $S_d^1 := \{(e^{2\pi i \varphi}, \dots, e^{2\pi i \varphi}) \in T^n\}$ ,  $\varphi \in \mathbb{R}$ , is the diagonal subgroup in  $T^n$ . Let  $M^{2n}$  be a quasitoric manifold over  $\Delta^n$  with characteristic map  $\ell_M$ . We may assume that  $\ell_M(F_i) = T_i$ ,  $i = 1, \dots, n$ , by Lemma 2.5.1. Then it easily follows from (26) that

$$\ell_M(F_{n+1}) = \{(e^{2\pi i \varepsilon_1 \varphi}, \dots, e^{2\pi i \varepsilon_n \varphi}) \in T^n\}, \quad \varphi \in \mathbb{R},$$

where  $\varepsilon_i = \pm 1$ ,  $i = 1, \dots, n$ . Now define the automorphism  $\psi : T^n \rightarrow T^n$  by

$$\psi(e^{2\pi i \varphi_1}, \dots, e^{2\pi i \varphi_n}) = (e^{2\pi i \varepsilon_1 \varphi_1}, \dots, e^{2\pi i \varepsilon_n \varphi_n}).$$

It can be readily seen that  $\psi \cdot \ell_M = \ell_{\mathbb{C}P^n}$ , which together with Proposition 2.2.3 completes the proof.  $\square$

Note that the equivariant diffeomorphism provided by Proposition 2.5.2 not necessarily preserves the orientation of the quasitoric manifold  $M^{2n}$ .

The problem of equivariant and topological classification also admits a complete solution in the case  $n = 2$  (i.e. for quasitoric manifolds over polygons).

**Example 2.5.3.** The *Hirzebruch surface* is the 2-dimensional complex manifold  $H_p = \mathbb{C}P(\zeta_p \oplus \mathbb{C})$ , where  $\zeta_p$  is the complex line bundle over  $\mathbb{C}P^1$  with first Chern class  $p$ ,  $\mathbb{C}$  is the trivial complex line bundle and  $\mathbb{C}P(\cdot)$  denotes the projectivisation of the complex bundle. Hence, there is a bundle  $H_p \rightarrow \mathbb{C}P^1$  with fibre  $\mathbb{C}P^1$ . The surface  $H_p$  is homeomorphic to  $S^2 \times S^2$  for even  $p$  and to  $\mathbb{C}P^2 \# \overline{\mathbb{C}P^2}$  for odd  $p$ , where  $\overline{\mathbb{C}P^2}$  denotes the space  $\mathbb{C}P^2$  with reversed orientation. The Hirzebruch surfaces are non-singular projective toric varieties (see [40, p. 8]). The orbit space for  $H_p$  (regarded as a quasitoric manifold) is a combinatorial square; the corresponding characteristic maps can be described using Example 2.2.8 (see also [33, Example 1.19]).

**Theorem 2.5.4** ([63, p. 553]). *A quasitoric manifold of dimension 4 is equivariantly diffeomorphic to the equivariant connected sum of several copies of  $\mathbb{C}P^2$  and Hirzebruch surfaces  $H_p$ .*

**Corollary 2.5.5.** *A quasitoric manifold of dimension 4 is diffeomorphic to the connected sum of several copies of  $\mathbb{C}P^2$ ,  $\overline{\mathbb{C}P^2}$  and  $S^2 \times S^2$ .*

The classification problem for quasitoric manifolds over a given simple polytope can be considered as a generalisation of the corresponding problem for non-singular toric varieties. In [62] to every toric variety over a simple 3-polytope  $P^3$  was assigned two integer *weights* on every edge of the dual simplicial complex  $K_P$ . Using the special “monodromy conditions” for weights, the complete classification of toric varieties over simple 3-polytopes with  $\leq 8$  facets was obtained in [62]. A similar construction was used in [53] to obtain the classification of toric varieties over  $P^n$  with  $m = n + 2$  facets (note that any such simple polytope is the product of two simplices).

In [36] the construction of weights from [62] was generalised to the case of quasitoric manifolds. This allowed to obtain a criterion [36, Theorem 3] for the existence of a quasitoric manifold with given weight set and signs of vertices  $\sigma(v)$  (see Definition 2.4.3; note that our signs of vertices correspond to the two-paint colouring used in [36]). As an application, the complete classification of characteristic maps for the cube  $I^3$  is obtained in [36], along with a series of results on the classification of quasitoric manifolds over the product of arbitrary number of simplices.

### 3. MOMENT-ANGLE COMPLEXES

**3.1. Moment-angle manifolds  $\mathcal{Z}_P$  defined by simple polytopes.** For any combinatorial simple polytope  $P^n$  with  $m$  facets Davis and Januszkiewicz introduced in [33] a space  $\mathcal{Z}_P$  with an action of the torus  $T^m$  and the orbit space  $P^n$ .



This space is universal for all quasitoric manifolds over  $P^n$  in the sense that for every quasitoric manifold  $\pi : M^{2n} \rightarrow P^n$  there is a principal  $T^{m-n}$ -bundle  $\mathcal{Z}_P \rightarrow M^{2n}$  whose composite map with  $\pi$  is the orbit map for  $\mathcal{Z}_P$ . The space  $\mathcal{Z}_P$  and some its generalisations turn to be very important and effective tool for studying different combinatorial objects such as Stanley–Reisner rings, subspace arrangements, cubical complexes etc. In this section we reproduce the original definition of  $\mathcal{Z}_P$  and adjust it in the way convenient for subsequent generalisations.

Let  $\mathcal{F} = \{F_1, \dots, F_m\}$  be the set of facets of  $P^n$ . For any facet  $F_i \in \mathcal{F}$  denote by  $T_{F_i}$  the one-dimensional coordinate subgroup of  $T^{\mathcal{F}} \cong T^m$  corresponding to  $F_i$ . Then assign to every face  $G$  the coordinate subtorus

$$T_G = \bigoplus_{F_i \supset G} T_{F_i} \subset T^{\mathcal{F}}.$$

Note that  $\dim T_G = \text{codim } G$ . Recall that for any point  $q \in P^n$  we denote by  $G(q)$  the unique face containing  $q$  in the relative interior.

**Definition 3.1.1.** For any combinatorial simple polytope  $P^n$  introduce the identification space

$$\mathcal{Z}_P = (T^{\mathcal{F}} \times P^n) / \sim,$$

where  $(t_1, q) \sim (t_2, q)$  if and only if  $t_1 t_2^{-1} \in T_{G(q)}$ .

The free action of  $T^m$  on  $T^{\mathcal{F}} \times P^n$  obviously descends to an action on  $\mathcal{Z}_P$ , with quotient  $P^n$ . Let  $\rho : \mathcal{Z}_P \rightarrow P^n$  be the orbit map. The action of  $T^m$  on  $\mathcal{Z}_P$  is free over the interior of  $P^n$ , while each vertex  $v \in P^n$  represents the orbit  $\rho^{-1}(v)$  with maximal isotropy subgroup of dimension  $n$ .

**Lemma 3.1.2.** *The space  $\mathcal{Z}_P$  is a smooth manifold of dimension  $m + n$ .*

In this paper we provide several different proofs of this lemma, each of which arises from an equivalent definition of  $\mathcal{Z}_P$ . To give our first proof we need the following simple topological fact.

**Proposition 3.1.3.** *The torus  $T^k$  admits a smooth embedding into  $\mathbb{R}^{k+1}$ .*

*Proof.* In order to construct a required embedding we provide a smooth function  $g_{k+1}(x_1, \dots, x_{k+1})$  such that the equation  $g_{k+1} = 0$  defines a hypersurface diffeomorphic to  $T^k$ . For  $k = 1$  we take  $g_2(x_1, x_2) = x_1^2 + (x_2 - 2)^2 - 1$ ; then we proceed by induction on  $k$ . Suppose we have a function  $g_i(x_1, \dots, x_i)$  such that  $\{g_i = 0\}$  defines a smooth embedding  $T^{i-1} \hookrightarrow \mathbb{R}^i$  and  $x_i > 0$  for any  $(x_1, \dots, x_i)$  satisfying  $g_i = 0$ . Then set

$$g_{i+1}(x_1, \dots, x_i, x_{i+1}) := g_i(x_1, \dots, x_i, \sqrt{x_i^2 + x_{i+1}^2}).$$

The hypersurface  $\{g_{i+1} = 0\} \subset \mathbb{R}^{i+1}$  is easily seen to be diffeomorphic to  $T^i$ .  $\square$

*Proof of Lemma 3.1.2.* Construction 2.1.6 provides the atlas  $\{U_v\}$  for  $P^n$  as a manifold with corners. The set  $U_v$  is based on the vertex  $v$  and is diffeomorphic to  $\mathbb{R}_+^n$ . Then  $\rho^{-1}(U_v) \cong T^{m-n} \times \mathbb{R}^{2n}$ . We claim that  $T^{m-n} \times \mathbb{R}^{2n}$  can be realised as an open set in  $\mathbb{R}^{m+n}$ , thus providing a chart for  $\mathcal{Z}_P$ . To see this we embed  $T^{m-n}$  into  $\mathbb{R}^{m-n+1}$  as a closed hypersurface  $H$  (Proposition 3.1.3). Since the normal bundle is trivial, the small neighbourhood of  $H \subset \mathbb{R}^{m-n+1}$  is homeomorphic to  $T^{m-n} \times \mathbb{R}$ . Taking the cartesian product with  $\mathbb{R}^{2n-1}$  we obtain an open set in  $\mathbb{R}^{m+n}$  homeomorphic to  $T^{m-n} \times \mathbb{R}^{2n}$ .  $\square$

The following statement follows easily from the definition of  $\mathcal{Z}_P$ .

**Proposition 3.1.4.** *If  $P = P_1 \times P_2$  for some simple polytopes  $P_1, P_2$ , then  $\mathcal{Z}_P = \mathcal{Z}_{P_1} \times \mathcal{Z}_{P_2}$ . If  $G \subset P$  is a face, then  $\mathcal{Z}_G$  is a submanifold of  $\mathcal{Z}_P$ .*

Suppose now that we are given a characteristic map  $\ell$  on  $P^n$  and  $M^{2n}(\ell)$  is the derived quasitoric manifold (Construction 2.2.2). Choosing an omniorientation in any way we obtain a directed characteristic map  $\lambda : T^{\mathcal{F}} \rightarrow T^n$ . Denote its kernel by  $H(\ell)$  (it depends only on  $\ell$ ); then  $H(\ell)$  is an  $(m - n)$ -dimensional subtorus of  $T^{\mathcal{F}}$ .

**Proposition 3.1.5.** *The subtorus  $H(\ell)$  acts freely on  $\mathcal{Z}_P$ , thus defining a principal  $T^{m-n}$ -bundle  $\mathcal{Z}_P \rightarrow M^{2n}(\ell)$ .*

*Proof.* It follows from (26) that  $H(\ell)$  meets every isotropy subgroup only at the unit. This implies that the action of  $H(\ell)$  on  $\mathcal{Z}_P$  is free. By definitions of  $\mathcal{Z}_P$  and  $M^{2n}(\ell)$ , the projection  $\lambda \times \text{id} : T^{\mathcal{F}} \times P^n \rightarrow T^n \times P^n$  descends to the projection

$$(T^{\mathcal{F}} \times P^n)/\sim \longrightarrow (T^n \times P^n)/\sim,$$

which displays  $\mathcal{Z}_P$  as a principal  $T^{m-n}$ -bundle over  $M^{2n}(\ell)$ .  $\square$

To simplify notations we would write  $T^m, \mathbb{C}^m$  etc. instead of  $T^{\mathcal{F}}, \mathbb{C}^{\mathcal{F}}$  etc.

Define the unit poly-disk  $(D^2)^m$  in the complex space as

$$(D^2)^m = \{(z_1, \dots, z_m) \in \mathbb{C}^m : |z_i| \leq 1, \quad i = 1, \dots, m\}.$$

Then  $(D^2)^m$  is stable under the standard action of  $T^m$  on  $\mathbb{C}^m$ , and the quotient is the standard cube  $I^m \subset \mathbb{R}_+^m$ .

**Lemma 3.1.6.** *The cubical embedding  $i_P : P^n \rightarrow I^m$  from Construction 1.5.5 is covered by an equivariant embedding  $i_e : \mathcal{Z}_P \rightarrow (D^2)^m$ .*

*Proof.* Recall that the cubical decomposition of  $P^n$  consists of the cubes  $C_v^n$  based on the vertices  $v \in P^n$ . Note that  $C_v^n$  is contained in the open set  $U_v \subset P^n$  (see Construction 2.1.6). The inclusion  $C_v^n \subset U_v$  is covered by an equivariant inclusion  $B_v \subset \mathbb{C}^m$ , where  $B_v = \rho^{-1}(C_v^n)$  is a closed subset homeomorphic to  $(D^2)^m \times T^{m-n}$ . Since  $\mathcal{Z}_P = \bigcup_{v \in P^n} B_v$  and  $B_v$  is stable under the  $T^m$ -action, the resulting embedding  $\mathcal{Z}_P \rightarrow (D^2)^m$  is equivariant.  $\square$

It follows from the proof that the manifold  $\mathcal{Z}_P$  is represented as a union of  $f_{n-1}(P)$  closed  $T^m$ -invariant charts  $B_v$ . In section 3.3 we provide two different ways to construct a cellular decomposition of each  $B_v$ , thus describing  $\mathcal{Z}_P$  as a cellular complex. For now, we mention that if  $v = F_{i_1} \cap \dots \cap F_{i_n}$ , then

$$i_e(B_v) = (D^2)_{i_1, \dots, i_n}^n \times T_{[m] \setminus \{i_1, \dots, i_n\}}^{m-n} \subset (D^2)^m,$$

or, more precisely,

$$i_e(B_v) = \{(z_1, \dots, z_m) \in (D^2)^m : |z_i| = 1 \text{ for } i \notin \{i_1, \dots, i_n\}\}.$$

Recalling that the vertices of  $P^n$  correspond to the maximal simplices of the polytopal sphere  $K_P$  (boundary of the polar polytope  $P^*$ ), we can write

$$(37) \quad i_e(\mathcal{Z}_P) = \bigcup_{I \in K_P} (D^2)_I \times T_{[m] \setminus I} \subset (D^2)^m.$$

This can be regarded as an alternative definition of  $\mathcal{Z}_P$ . Introducing the polar coordinates in  $(D^2)^m$  we see that  $i_e(B_v)$  is parametrised by  $n$  radial (or moment) and  $m$  angle coordinates. That is why we refer to  $\mathcal{Z}_P$  as the *moment-angle manifold defined by  $P^n$* .

**Example 3.1.7.** Let  $P^n = \Delta^n$  (the  $n$ -simplex). Then  $\mathcal{Z}_P$  is homeomorphic to the  $(2n+1)$ -sphere  $S^{2n+1}$ . The cubical complex  $\mathcal{C}(\Delta^n)$  (see Construction 1.5.5) consists of  $(n+1)$  cubes  $C_v^n$ . Each subset  $B_v = \rho^{-1}(C_v^n)$  is homeomorphic to  $(D^2)^n \times S^1$ . In particular, for  $n=1$  we obtain the well-known representation of the 3-sphere  $S^3$  as a union of two solid tori  $D^2 \times S^1$ .

Another way to construct an equivariant embedding of  $\mathcal{Z}_P$  into  $\mathbb{C}^m$  can be derived from Construction 1.1.4.

**Construction 3.1.8.** Formula (6) defines the (affine) embedding  $A_P : P^n \hookrightarrow \mathbb{R}_+^m$ . This embedding is covered by an equivariant embedding  $\mathcal{Z}_P \hookrightarrow \mathbb{C}^m$ . A choice of matrix  $W$  in Construction 1.1.4 defines a basis in the  $(m-n)$ -dimensional subspace orthogonal to the  $n$ -plane that contain  $A_P(P^n)$  (see (6)). The following statement follows.

**Corollary 3.1.9** (see also [26, §3]). *The embedding  $\mathcal{Z}_P \hookrightarrow \mathbb{C}^m$  has the trivial normal bundle.*

**3.2. General moment-angle complexes.** In this section we extend the construction of  $\mathcal{Z}_P$  to the case of general simplicial complex  $K$ . The resulting space is not a manifold for arbitrary  $K$ , but is so when  $K$  is a simplicial sphere.

Here we denote by  $\rho$  the canonical projection  $(D^2)^m \rightarrow I^m$ , as well as any of its restriction to a closed  $T^m$ -stable subset of  $(D^2)^m$ . For each face  $C_{I \subset J}$  of  $I^m$  (see (19)) define

$$(38) \quad B_{I \subset J} := \rho^{-1}(C_{I \subset J}) \\ = \{(z_1, \dots, z_m) \in (D^2)^m : z_i = 0 \text{ for } i \in I, |z_i| = 1 \text{ for } i \notin J\}.$$

It follows that if  $\#I = i$ ,  $\#J = j$  then  $B_{I \subset J} \cong (D^2)^{j-i} \times T^{m-j}$ , where the disk factors  $D^2 \subset (D^2)^{j-i}$  are parametrised by  $J \setminus I$ , while the circle factors  $S^1 \subset T^{m-j}$  are parametrised by  $[m] \setminus J$ .

**Definition 3.2.1.** Let  $\mathcal{C}$  be a cubical subcomplex of  $I^m$ . The *moment-angle complex*  $\text{ma}(\mathcal{C})$  corresponding to  $\mathcal{C}$  is the  $T^m$ -invariant decomposition of  $\rho^{-1}(\mathcal{C})$  into the ‘‘moment-angle’’ blocks  $B_{I \subset J}$  (38) corresponding to the faces  $C_{I \subset J}$  of  $\mathcal{C}$ . Hence,  $\text{ma}(\mathcal{C})$  is defined from the commutative diagram

$$\begin{array}{ccc} \text{ma}(\mathcal{C}) & \longrightarrow & (D^2)^m \\ \downarrow & & \downarrow \rho \\ \mathcal{C} & \longrightarrow & I^m \end{array} .$$

The torus  $T^m$  acts on  $\text{ma}(\mathcal{C})$  with orbit space  $\mathcal{C}$ .

In section 1.5 two canonical cubical subcomplexes of  $I^m$ , namely  $\text{cub}(K)$  (21) and  $\text{cc}(K)$  (22), were associated to every simplicial complex  $K^{n-1}$  on  $m$  vertices. We denote the corresponding moment-angle complexes by  $\mathcal{W}_K$  and  $\mathcal{Z}_K$  respectively. Thus, we have

$$(39) \quad \begin{array}{ccc} \mathcal{W}_K & \longrightarrow & (D^2)^m \\ \rho \downarrow & & \downarrow \rho \\ \text{cub}(K) & \longrightarrow & I^m \end{array} \quad \text{and} \quad \begin{array}{ccc} \mathcal{Z}_K & \longrightarrow & (D^2)^m \\ \rho \downarrow & & \downarrow \rho \\ \text{cc}(K) & \longrightarrow & I^m \end{array} ,$$

where the horizontal arrows are embeddings, while the vertical ones are orbit maps for  $T^m$ -actions. Note that  $\dim \mathcal{Z}_K = m+n$  and  $\dim \mathcal{W}_K = m+n-1$ .

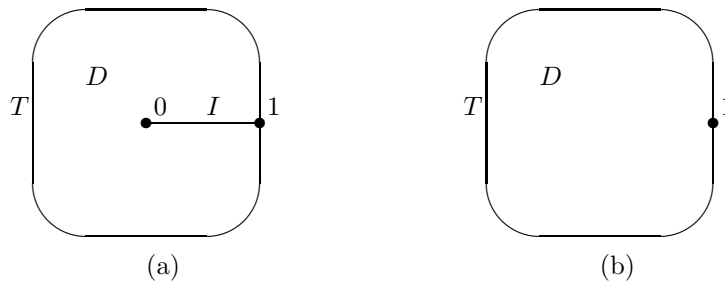
FIGURE 7. Cellular decompositions of  $D^2$ .

*Remark.* Suppose that  $K = K_P$  for some simple polytope  $P$ . Then it follows from (37) that  $\mathcal{Z}_K$  is identified with  $\mathcal{Z}_P$  (or, more precisely, with  $i_e(\mathcal{Z}_P)$ ).

**Lemma 3.2.2.** *If  $K$  is a simplicial  $(n - 1)$ -sphere, then  $\mathcal{Z}_K$  is an  $(m + n)$ -dimensional (closed) manifold.*

*Proof.* In this proof we identify the polyhedrons  $|K|$  and  $|\text{cone}(K)|$  with their images  $\text{cub}(K) \subset I^m$  and  $\text{cc}(K) \subset I^m$  under the map  $|\text{cone}(K)| \rightarrow I^m$ , see Theorem 1.5.10. For each vertex  $\{i\} \in K$  denote by  $F_i$  the union of  $(n - 1)$ -cubes of  $\text{cub}(K)$  that contain  $\{i\}$ . Alternatively,  $F_i$  is  $|\text{star}_{\text{bs}(K)}\{i\}|$ . These  $F_1, \dots, F_m$  are analogues of facets of a simple polytope. Moreover, if  $K = K_P$  for some  $P$ , then  $F_i$  is the image of a facet of  $P$  under the map  $i_P : \mathcal{C}(P) \rightarrow I^m$  (Construction 1.5.5). As in the case of simple polytopes, we define “faces” of  $\text{cc}(K)$  as non-empty intersections of “facets”  $F_1, \dots, F_m$ . Then the “vertices” (i.e. non-empty intersections of  $n$  “facets”) are the barycentres of  $(n - 1)$ -simplices of  $|K|$ . For every such barycentre  $b$  denote by  $U_b$  the open subset of  $\text{cc}(K)$  obtained by deleting all “faces” not containing  $b$ . Then  $U_b$  is identified with  $\mathbb{R}_+^n$ , while  $\rho^{-1}(U_b)$  is homeomorphic to  $T^{m-n} \times \mathbb{R}^{2n}$ . This defines a structure of manifold with corners on the  $n$ -ball  $\text{cc}(K) = |\text{cone}(K)|$ , with atlas  $\{U_b\}$ . At the same time we see that  $\mathcal{Z}_K = \rho^{-1}(\text{cc}(K))$  is a manifold, with atlas  $\{\rho^{-1}(U_b)\}$ .  $\square$

**Problem 3.2.3.** *Characterise simplicial complexes  $K$  for which  $\mathcal{Z}_K$  is a manifold.*

As we will see below (Theorem 4.2.1), for homological reasons, if  $\mathcal{Z}_K$  is a manifold, then  $K$  is a Gorenstein\* complex. So, the answer to the above problem is somewhere between “simplicial spheres” and “Gorenstein\* complexes”.

**3.3. Cellular structures on moment-angle complexes.** Here we consider two cellular decompositions of  $(D^2)^m$ , which provide cellular decompositions for moment-angle complexes. The first one has  $5^m$  cells and define a cellular complex structure (with 5 types of cells) for any moment-angle complex  $\text{ma}(\mathcal{C}) \subset (D^2)^m$ . The second cellular decomposition of  $(D^2)^m$  has only  $3^m$  cells, but is appropriate only for defining a cellular structure (with 3 types of cells) on moment-angle complexes  $\mathcal{Z}_K$ .

Let us consider the cellular decomposition of  $D^2$  with one 2-cell  $D$ , two 1-cells  $I, T$ , and two 0-cells  $0, 1$ , see Figure 7 (a). It defines a cellular decomposition of the poly-disk  $(D^2)^m$  with  $5^m$  cells. Each cell of this cellular complex is the product of cells of 5 different types:  $D_i, I_i, 0_i, T_i$  and  $1_i, i = 1, \dots, m$ . We encode the cells of  $(D^2)^m$  by “words” of type  $D_I I_J 0_L T_P 1_Q$ , where  $I, J, L, P, Q$  are pairwise

disjoint subsets of  $[m]$  such that  $I \cup J \cup L \cup P \cup Q = [m]$ . Sometimes we would drop the last factor  $1_Q$ , so in our notations  $D_I I_J 0_L T_P = D_I I_J 0_L T_P 1_{[m] \setminus I \cup J \cup L \cup P}$ . The closure of  $D_I I_J 0_L T_P 1_Q$  is homeomorphic to the product of  $\#I$  disks,  $\#J$  segments, and  $\#P$  circles. The constructed cellular decomposition of  $(D^2)^m$  allows to display moment-angle complexes as certain cellular subcomplexes in  $(D^2)^m$ .

**Lemma 3.3.1.** *For any cubical subcomplex  $\mathcal{C}$  of  $I^m$  the corresponding moment-angle complex  $\text{ma}(\mathcal{C})$  is a cellular subcomplex of  $(D^2)^m$ .*

*Proof.* Indeed,  $\text{ma}(\mathcal{C})$  is a union of “moment-angle” blocks  $B_{I \subset J}$  (38), and each  $B_{I \subset J}$  is the closure of the cell  $D_{J \setminus I} I_{\emptyset} 0_I T_{[m] \setminus J} 1_{\emptyset}$ .  $\square$

Now we concentrate on the moment-angle complex  $\mathcal{Z}_K$  corresponding to the cubical complex  $\text{cc}(K) \subset I^m$  (see (39)). By definition,  $\mathcal{Z}_K$  is the union of moment-angle blocks  $B_{I \subset J} \subset (D^2)^m$  with  $J \in K$ . Denote

$$(40) \quad B_J := B_{\emptyset \subset J} = \{(z_1, \dots, z_m) \in (D^2)^m : |z_j| = 1 \text{ for } j \notin J\}.$$

Then  $B_J = \rho^{-1}(C_J)$  (recall that  $C_J := C_{\emptyset \subset J}$ ) and  $B_{I \subset J} \subset B_J$  for any  $I \subset J$ . It follows that

$$(41) \quad \mathcal{Z}_K = \bigcup_{J \in K} B_J$$

(compare this with the note after (22)).

*Remark.* If  $K = K_P$  for a simple polytope  $P$  and  $\#J = n$ , then  $B_J$  is  $i_e(B_v)$  for  $v = \bigcap_{j \in J} F_j$ . Hence, (41) reduces to (37) in this case.

Note that  $B_J \cap B_{J'} = B_{J \cap J'}$ . This allows to simplify the cellular decomposition from Lemma 3.3.1 in the case  $\text{ma}(\mathcal{C}) = \mathcal{Z}_K$ . To do this we replace the union of cells  $0, I, D$  (see Figure 7 (a)) by one 2-dimensional cell (which we also denote  $D$ ). The resulting cellular decomposition of  $D^2$  with 3 cells is shown on Figure 7 (b). It defines a cellular decomposition of  $(D^2)^m$  with  $3^m$  cells, each of which is the product of 3 different types of cells:  $D_i, T_i$  and  $1_i, i = 1, \dots, m$ . We encode these cells of  $(D^2)^m$  as  $D_I T_P 1_Q$ , where  $I, P, Q$  are pairwise disjoint subsets of  $[m]$  such that  $I \cup P \cup Q = [m]$ . We use the notation  $D_I T_P := D_I T_P 1_{[m] \setminus I \cup P}$ . The closure of  $D_I T_P$  is the product of  $\#I$  disks and  $\#P$  circles.

**Lemma 3.3.2.** *The moment-angle complex  $\mathcal{Z}_K$  is a cellular subcomplex of  $(D^2)^m$  with respect to the  $3^m$ -cell decomposition (see Figure 7 (b)). Each cell of  $\mathcal{Z}_K$  has the form  $D_I T_P, I \in K$ .*

*Proof.* Since  $B_J = B_{\emptyset \subset J}$  is the closure of the cell  $D_J T_{[m] \setminus J} 1_{\emptyset}$ , the statement follows from (41).  $\square$

*Remark.* Note that for general  $\mathcal{C}$  the moment-angle complex  $\text{ma}(\mathcal{C})$  is *not* a cellular subcomplex for the  $3^m$ -cell decomposition of  $(D^2)^m$ .

It follows from Construction 1.5.9 that the cubical complex  $\text{cc}(K)$  always contains the vertex  $(1, \dots, 1) \in I^m$ . Hence, the torus  $T^m = \rho^{-1}(1, \dots, 1)$  is contained in  $\mathcal{Z}_K$ .

**Lemma 3.3.3.** *The inclusion  $T^m = \rho^{-1}(1, \dots, 1) \hookrightarrow \mathcal{Z}_K$  is a cellular map homotopical to the map to a point, i.e. the torus  $T^m = \rho^{-1}(1, \dots, 1)$  is a contractible cellular subcomplex of  $\mathcal{Z}_K$ .*

*Proof.* To prove that  $T^m = \rho^{-1}(1, \dots, 1)$  is a cellular subcomplex of  $\mathcal{Z}_K$  we just mention that it is the closure of the  $m$ -cell  $D_0 T_{[m]} \subset \mathcal{Z}_K$ . So, it remains to prove that  $T^m$  is contractible within  $\mathcal{Z}_K$ . To do this we show that the embedding  $T^m \subset (D^2)^m$  is homotopic to the map to the point  $(1, \dots, 1) \in T^m \subset (D^2)^m$ . On the first step we note that  $\mathcal{Z}_K$  contains the cell  $D_1 T_{2, \dots, m}$ , whose closure contains  $T^m$  and is homeomorphic to  $D^2 \times T^{m-1}$ . Hence, our  $T^m$  can be contracted to  $1 \times T^{m-1}$  within  $\mathcal{Z}_K$ . On the second step we note that  $\mathcal{Z}_K$  contains the cell  $D_2 T_{3, \dots, m}$ , whose closure contains  $1 \times T^{m-1}$  and is homeomorphic to  $D^2 \times T^{m-2}$ . Hence,  $1 \times T^{m-1}$  can be contracted to  $1 \times 1 \times T^{m-2}$  within  $\mathcal{Z}_K$ , and so on. On the  $k$ -th step we note that  $\mathcal{Z}_K$  contains the cell  $D_k T_{k+1, \dots, m}$ , whose closure contains  $1 \times \dots \times 1 \times T^{m-k+1}$  and is homeomorphic to  $D^2 \times T^{m-k}$ . Hence,  $1 \times \dots \times 1 \times T^{m-k+1}$  can be contracted to  $1 \times \dots \times 1 \times T^{m-k}$  within  $\mathcal{Z}_K$ . We end up at the point  $1 \times \dots \times 1$  to which the whole torus  $T^m$  can be contracted.  $\square$

**Corollary 3.3.4.** *For any simplicial complex  $K$  the moment-angle complex  $\mathcal{Z}_K$  is simply connected.*

*Proof.* Indeed, the 1-skeleton of our cellular decomposition of  $\mathcal{Z}_K$  is contained in the torus  $T^m = \rho^{-1}(1, \dots, 1)$ .  $\square$

**3.4. Borel construction and Stanley–Reisner space.** Let  $ET^m$  be the contractible space of the universal principal  $T^m$ -bundle over the classifying space  $BT^m$ . It is well known that  $BT^m$  is (homotopy equivalent to) the product of  $m$  copies of infinite-dimensional projective space  $\mathbb{C}P^\infty$ . The cellular decomposition of  $\mathbb{C}P^\infty$  with one cell in every even dimension determines the *canonical* cellular decomposition of  $BT^m$ . It follows that the cohomology of  $BT^m$  (with coefficients in  $\mathbf{k}$ ) is the polynomial ring  $\mathbf{k}[v_1, \dots, v_m]$ ,  $\deg v_i = 2$ .

**Definition 3.4.1.** Let  $X$  be a space with an action of the torus  $T^m$ . The *Borel construction* (alternatively, *homotopy quotient* or *associated bundle*) is the identification space

$$ET^m \times_{T^m} X := ET^m \times X / \sim,$$

where  $(e, x) \sim (eg, g^{-1}x)$  for any  $e \in ET^m$ ,  $x \in X$ ,  $g \in T^m$ .

The projection  $(e, x) \rightarrow e$  displays  $ET^m \times_{T^m} X$  as the total space of a bundle  $ET^m \times_{T^m} X \rightarrow BT^m$  with fibre  $X$  and structure group  $T^m$ . At the same time, there is a principal  $T^m$ -bundle  $ET^m \times X \rightarrow ET^m \times_{T^m} X$ .

In the sequel we denote the Borel construction  $ET^m \times_{T^m} X$  corresponding to a  $T^m$ -space  $X$  by  $B_T X$ . In particular, for any simplicial complex  $K$  on  $m$  vertices there are defined the Borel construction  $B_T \mathcal{Z}_K$  and the bundle  $p : B_T \mathcal{Z}_K \rightarrow BT^m$  with fibre  $\mathcal{Z}_K$ .

For each  $i = 1, \dots, m$  denote by  $BT_i$  the  $i$ -th coordinate subspace of  $BT^m = (\mathbb{C}P^\infty)^m$ . For any subset  $I \subset [m]$ , we denote by  $BT_I$  the product of  $BT_i$  with  $i \in I$ . Obviously,  $BT_I$  is a cellular subcomplex of  $BT^m$ , and  $BT_I \cong BT^k$  provided that  $\#I = k$ .

**Definition 3.4.2.** Let  $K$  be a simplicial complex. We refer to the cellular subcomplex

$$\bigcup_{I \in K} BT_I \subset BT^m$$

as the *Stanley–Reisner space*, and denote it  $SR(K)$ .

The name refers to the following statement, which is an immediate corollary of the definition of Stanley–Reisner ring  $\mathbf{k}(K)$  (Definition 1.3.1).

**Proposition 3.4.3.** *The cellular cochain algebra  $C^*(SR(K))$  and the cohomology algebra  $H^*(SR(K))$  are isomorphic to the face ring  $\mathbf{k}(K)$ . The cellular inclusion  $i : SR(K) \hookrightarrow BT^m$  induces the quotient epimorphism  $i^* : \mathbf{k}[v_1, \dots, v_m] \rightarrow \mathbf{k}(K) = \mathbf{k}[v_1, \dots, v_m]/\mathcal{I}_K$  in the cohomology.*

**Theorem 3.4.4.** *The fibration  $p : B_T \mathcal{Z}_K \rightarrow BT^m$  is homotopy equivalent to the cellular inclusion  $i : SR(K) \hookrightarrow BT^m$ . More precisely, there is a deformation retraction  $B_T \mathcal{Z}_K \rightarrow SR(K)$  such that the diagram*

$$\begin{array}{ccc} B_T \mathcal{Z}_K & \xrightarrow{p} & BT^m \\ \downarrow & & \parallel \\ SR(K) & \xrightarrow{i} & BT^m \end{array}$$

*is commutative.*

*Proof.* Consider the decomposition (41). Since each  $B_J \subset \mathcal{Z}_K$  is  $T^m$ -stable, the Borel construction  $B_T \mathcal{Z}_K = ET^m \times_{T^m} \mathcal{Z}_K$  is patched from the Borel constructions  $ET^m \times_{T^m} B_J$ ,  $J \in K$ . Suppose  $\#J = j$ ; then  $B_J \cong (D^2)^j \times T^{m-j}$  (see (40)). By definition of Borel construction,  $ET^m \times_{T^m} B_J \cong (ET^j \times_{T^j} (D^2)^j) \times ET^{m-j}$ . The space  $ET^j \times_{T^j} (D^2)^j$  is the total space of a  $(D^2)^j$ -bundle over  $BT^j$ . It follows that there is a deformation retraction  $ET^m \times_{T^m} B_J \rightarrow BT_J$ , which defines a homotopy equivalence between the restriction of  $p : B_T \mathcal{Z}_K \rightarrow BT^m$  to  $ET^m \times_{T^m} B_J$  and the cellular inclusion  $BT_J \hookrightarrow BT^m$ . These homotopy equivalences corresponding to different simplices  $J \in K$  fit together to yield a required homotopy equivalence between  $p : B_T \mathcal{Z}_K \rightarrow BT^m$  and  $i : SR(K) \hookrightarrow BT^m$ .  $\square$

**Corollary 3.4.5.** *The moment-angle complex  $\mathcal{Z}_K$  is a homotopy fibre of the cellular inclusion  $i : SR(K) \hookrightarrow BT^m$ .*

**Corollary 3.4.6.** *The cohomology algebra  $H^*(B_T \mathcal{Z}_K)$  is isomorphic to the face ring  $\mathbf{k}(K)$ . The projection  $p : B_T \mathcal{Z}_K \rightarrow BT^m$  induces the quotient epimorphism  $p^* : \mathbf{k}[v_1, \dots, v_m] \rightarrow \mathbf{k}(K) = \mathbf{k}[v_1, \dots, v_m]/\mathcal{I}_K$  in the cohomology.*

*Remark.* The above statement was proved in [33, Theorem 4.8] in the polytopal case ( $\mathcal{Z}_K = \mathcal{Z}_P$ ) by other methods.

The following information about the homotopy groups of  $\mathcal{Z}_K$  can be retrieved from the above constructions.

**Theorem 3.4.7.** (a) *The complex  $\mathcal{Z}_K$  is 2-connected (i.e.  $\pi_1(\mathcal{Z}_K) = \pi_2(\mathcal{Z}_K) = 0$ ), and  $\pi_i(\mathcal{Z}_K) = \pi_i(B_T \mathcal{Z}_K) = \pi_i(SR(K))$  for  $i \geq 3$ .*

(b) *If  $K = K_P$  and  $P$  is  $q$ -neighbourly, then  $\pi_i(\mathcal{Z}_K) = 0$  for  $i < 2q + 1$ , and  $\pi_{2q+1}(\mathcal{Z}_P)$  is a free Abelian group whose generators correspond to the  $(q+1)$ -element missing faces of  $K_P$  (or equivalently, to degree- $(2q+2)$  generators of the ideal  $\mathcal{I}_P$ , see Definition 1.1.20).*

*Proof.* Note that  $BT^m = K(\mathbb{Z}^m, 2)$  and the 3-skeleton of  $SR(K)$  coincides with that of  $BT^m$ . If  $P$  is  $q$ -neighbourly, then it follows from Definition 3.4.2 that the  $(2q+1)$ -skeleton of  $SR(K_P)$  coincides with that of  $BT^m$ . Now, both statements

follow easily from the exact homotopy sequence of the map  $i : SR(K) \rightarrow BT^m$  with homotopy fibre  $\mathcal{Z}_K$  (Corollary 3.4.5).  $\square$

*Remark.* Say that a simplicial complex  $K$  on the set  $[m]$  is  $k$ -neighbourly if any  $k$ -element subset of  $[m]$  is a simplex of  $K$ . (This definition is an obvious extension of the notion of  $k$ -neighbourly simplicial polytope to arbitrary simplicial complexes). Then the second part of Theorem 3.4.7 holds for arbitrary  $q$ -neighbourly simplicial complex.

Suppose now that  $K = K_P$  for some simple  $n$ -polytope  $P$  and  $M^{2n}$  is a quasitoric manifold over  $P$  with characteristic function  $\ell$ . Then we have the subgroup  $H(\ell) \subset T^m$  acting freely on  $\mathcal{Z}_P$  and the principal  $T^{m-n}$ -bundle  $\mathcal{Z}_P \rightarrow M^{2n}$  (Proposition 3.1.5).

**Proposition 3.4.8.** *The Borel construction  $ET^n \times_{T^n} M^{2n}$  is homotopy equivalent to  $B_T \mathcal{Z}_P$ .*

*Proof.* Since  $H(\ell)$  acts freely on  $\mathcal{Z}_P$ , we have

$$\begin{aligned} B_T \mathcal{Z}_P &= ET^m \times_{T^m} \mathcal{Z}_P \\ &= EH(\ell) \times \left( E(T^m/H(\ell)) \times_{T^m/H(\ell)} \mathcal{Z}_P/H(\ell) \right) \simeq ET^n \times_{T^n} M^{2n}. \end{aligned}$$

$\square$

**Theorem 3.4.9** ([33, Theorem 4.12]). *The Leray–Serre spectral sequence of the bundle*

$$(42) \quad ET^n \times_{T^n} M^{2n} \rightarrow BT^n$$

*with fibre  $M^{2n}$  collapses at the  $E_2$  term, i.e.  $E_2^{p,q} = E_\infty^{p,q}$ .*

*Proof.* The differentials of the spectral sequence are all trivial by dimensional reasons, since both  $BT^n$  and  $M^{2n}$  have cells only in even dimensions (see Proposition 2.2.5).  $\square$

**Corollary 3.4.10.** *The projection (42) induces a monomorphism  $\mathbf{k}[t_1, \dots, t_n] \rightarrow \mathbf{k}(P)$  in the cohomology. The inclusion of the fibre  $M^{2n} \hookrightarrow ET^n \times_{T^n} M^{2n}$  induces an epimorphism  $\mathbf{k}(P) \rightarrow H^*(M^{2n})$ .*

Now we are ready to prove the statements from section 2.2.

*Proof of Lemma 2.2.6 and Theorem 2.2.7.* The monomorphism

$$H^*(BT^n) = \mathbf{k}[t_1, \dots, t_n] \rightarrow \mathbf{k}(P) = H^*(ET^n \times_{T^n} M^{2n})$$

takes  $t_i$  to  $\theta_i$ ,  $i = 1, \dots, n$ . Since  $\mathbf{k}(P)$  is a free  $\mathbf{k}[t_1, \dots, t_n]$ -module (note that this follows from Theorem 3.4.9, so we do not need to use Theorem 1.3.8),  $\theta_1, \dots, \theta_n$  is a regular sequence. It follows that the kernel of  $\mathbf{k}(P) \rightarrow H^*(M^{2n})$  is exactly  $\mathcal{J}_\ell = (\theta_1, \dots, \theta_n)$ .  $\square$



**3.5. Generalisations, analogues and additional comments.** Many important constructions from our survey (namely, the cubical complex  $\text{cc}(K)$ , the moment-angle complex  $\mathcal{Z}_K$ , the Borel construction  $B_T\mathcal{Z}_K$ , the Stanley–Reisner space  $SR(K)$ , and also the complement  $U(K)$  of a coordinate subspace arrangement from section 5.2) admit the unifying combinatorial interpretation in terms of the following construction, which was proposed by N. Strickland.

**Construction 3.5.1.** Let  $X$  be a space, and  $W$  a subspace of  $X$ . Let  $K$  be a simplicial complex on the vertex set  $[m]$ . Define the following subset of the product of  $m$  copies of  $X$ :

$$K_\bullet(X, W) = \bigcup_{I \in K} \left( \prod_{i \in I} X \times \prod_{i \notin I} W \right).$$

**Example 3.5.2.** 1.  $\text{cc}(K) = K_\bullet(I^1, 1)$  (see (22)).

2.  $\mathcal{Z}_K = K_\bullet(D^2, S^1)$  (see (41)).

3.  $SR(K) = K_\bullet(\mathbb{C}P^\infty, *)$  (see Definition 3.4.2).

4.  $B_T\mathcal{Z}_K = K_\bullet(ES^1 \times_{S^1} D^2, ES^1 \times_{S^1} D^2)$  (see the proof of Theorem 3.4.4).

Note that Construction 3.5.1 is obviously extended to the set of  $m$  pairs  $(X_1, W_1), \dots, (X_m, W_m)$ ; another generalisation is obtained by replacing the cartesian product by the fibred product.

Using construction 3.5.1, the part of Theorem 1.5.10 (dealing with the complex  $\text{cc}(K)$ ) and Theorem 5.2.5 were obtained independently by N. Strickland.

Almost all constructions of our paper incorporate some action of the torus, i.e. the product of circles  $S^1$ . These constructions admit natural  $\mathbb{Z}/2$ -analogues. To see this we replace the torus  $T^m$  by its “real analogue”, that is, the group  $(\mathbb{Z}/2)^m$ . Then the standard cube  $I^m = [0, 1]^m$  is the orbit space for the action of  $(\mathbb{Z}/2)^m$  on the bigger cube  $[-1, 1]^m$ , which can be regarded as a “real analogue” of the polydisk  $(D^2)^m \subset \mathbb{C}^m$ . Now, given a cubical subcomplex  $\mathcal{C} \subset I^m$ , we can construct a  $(\mathbb{Z}/2)^m$ -symmetrical cubical complex embedded into  $[-1, 1]^m$  just in the same way as we did it in Definition 3.2.1. In particular, for any simplicial complex  $K$  on the vertex set  $[m]$  we can introduce the cubical complexes  $\mathbb{R}\mathcal{Z}_K$  and  $\mathbb{R}\mathcal{W}_K$ , the “real analogues” of the moment-angle complexes  $\mathcal{Z}_K$  and  $\mathcal{W}_K$  (39). In the notations of Construction 3.5.1 we have

$$\mathbb{R}\mathcal{Z}_K = K_\bullet([-1, 1], \{-1, 1\}).$$

If  $K$  is a simplicial  $(n - 1)$ -sphere, then  $\mathbb{R}\mathcal{Z}_K$  is an  $n$ -dimensional manifold (the proof is identical to that of Lemma 3.2.2). Thus, for any simplicial sphere  $K^{n-1}$  with  $m$  vertices we get a  $(\mathbb{Z}/2)^m$ -symmetric  $n$ -manifold with a  $(\mathbb{Z}/2)^m$ -invariant cubical subdivision. This class of cubical manifolds may be useful for the cubical analogue for the combinatorial theory of  $f$ -vectors of simplicial complexes (see also [82]). Finally, the real analogue  $\mathbb{R}\mathcal{Z}_P$  of the manifold  $\mathcal{Z}_P$  (corresponding to the case of polytopal simplicial sphere  $K^{n-1}$ ) is known as the *universal Abelian cover* of the polytope  $P^n$  regarded as an orbifold (or manifold with corners), see [43, §4.5]. In [47] manifolds  $\mathbb{R}\mathcal{Z}_P$  and  $\mathcal{Z}_P$  are interpreted as the configuration spaces of *hinge mechanisms* in  $\mathbb{R}^2$  and  $\mathbb{R}^3$ .

Passage from  $T^n$  to  $(\mathbb{Z}/2)^n$  in Definition 2.2.1 leads to real analogues of quasitoric manifolds, which were introduced in [33] under the name *small covers*. Thus, every small cover of a simple polytope  $P^n$  is a manifold  $M^n$  with an action of  $(\mathbb{Z}/2)^n$  and quotient  $P^n$ . The name refers to the fact that any branched cover of  $P^n$  by a

smooth manifold have at least  $2^n$  sheets. Small covers were studied in [33] along with quasitoric manifolds, and many results on quasitoric manifolds cited from [33] in section 2.2 have analogues in the small cover case. On the other hand, every small cover is the quotient of the universal cover  $\mathbb{R}\mathcal{Z}_P$  by a certain free action of the group  $(\mathbb{Z}/2)^{m-n}$ .

An important class of small covers over 3-dimensional simple polytopes  $P^3$  was considered in [48]. It can be shown that a simple polytope  $P^3$  admits a 3-paint colouring of its facets such that any two adjacent facets have different colour if and only if every facet have even number of edges. Every such colouring  $\varrho$  defines the quasitoric manifold  $M^6(\varrho)$  and the small cover  $M^3(\varrho)$ . It was shown in [48] that every manifold  $M^3(\varrho)$  admits an equivariant embedding into  $\mathbb{R}^4 = \mathbb{R}^3 \times \mathbb{R}$  with the standard action of  $(\mathbb{Z}/2)^3$  on  $\mathbb{R}^3$  and the trivial action on  $\mathbb{R}$ . It was also shown there that all manifolds  $M^3(\varrho)$  can be obtained from the set of 3-dimensional tori by applying the operations of equivariant connected sum and *equivariant Dehn twist*.

The quaternionic analogue of moment-angle complexes can be constructed by replacing  $T^n$  by the quaternionic torus  $Sp(1)^n \cong (S^3)^n$ . Developing the quaternionic analogues of toric and quasitoric manifolds is a problem of particular interest. This is acknowledged, in particular, by the important results of [16].

At the end we give one application of the above described constructions to the case of general group  $G$ .

**Example 3.5.3** (classifying space for group  $G$ ). Let  $K$  be a simplicial complex on the vertex set  $[m]$ . Set  $\mathcal{Z}_K(G) := K_\bullet(\text{cone}(G), G)$  (see Construction 3.5.1), where  $\text{cone}(G)$  is the cone over  $G$ . By the construction, the group  $G^m$  acts on  $\mathcal{Z}_K(G)$  with quotient  $\text{cone}(K)$ . The diagonal embedding  $G \hookrightarrow G^m$  defines a free action of  $G$  on  $\mathcal{Z}_K(G)$ .

Suppose now that  $K_0 \subset K_1 \subset \dots \subset K_i \subset \dots$  is a sequence of embedded simplicial complexes such that  $K_i$  is  $q_i$ -neighbourly and  $q_i \rightarrow \infty$  as  $i \rightarrow \infty$ . Such a sequence can be constructed, for instance, by taking  $K_{i+1} := K_i * K$  (see Construction 1.2.5), where  $K_0$  and  $K$  are arbitrary simplicial complexes. The group  $G$  acts freely on the space  $\varinjlim \mathcal{Z}_{K_i}(G)$ , and the corresponding quotient provides a realisation of the classifying space  $BG$ . Thus, we have the following filtration in the universal fibration  $EG \rightarrow BG$ :

$$\begin{array}{ccccccc} \mathcal{Z}_{K_0}(G) & \hookrightarrow & \mathcal{Z}_{K_1}(G) & \hookrightarrow & \dots & \hookrightarrow & \mathcal{Z}_{K_i}(G) & \hookrightarrow & \dots \\ \downarrow & & \downarrow & & & & \downarrow & & \\ \mathcal{Z}_{K_0}(G)/G & \hookrightarrow & \mathcal{Z}_{K_1}(G)/G & \hookrightarrow & \dots & \hookrightarrow & \mathcal{Z}_{K_i}(G)/G & \hookrightarrow & \dots \end{array}$$

The well-known *Milnor filtration* in the universal fibration of the group  $G$  corresponds to the case  $K_i = \Delta^i$ .

#### 4. COHOMOLOGY OF MOMENT-ANGLE COMPLEXES AND COMBINATORICS OF SIMPLICIAL MANIFOLDS

**4.1. Eilenberg–Moore spectral sequence.** In their 1966 paper [39] Eilenberg and Moore constructed a spectral sequence of great importance for algebraic topology. This spectral sequence can be considered as an extension of Adams' approach to calculating the cohomology of loop spaces [1]. In 1960-70s the Eilenberg–Moore spectral sequence allowed to obtain many important results on the cohomology of loop spaces and homogeneous spaces for Lie group actions. In our paper we describe new applications of this spectral sequence to combinatorial problems. This section

contains the necessary information about the spectral sequence; we follow Smith's paper [76] in this description.

To be precise, there are two Eilenberg–Moore spectral sequences, the algebraic and the topological.

**Theorem 4.1.1** (Eilenberg–Moore [76, Theorem 1.2]). *Let  $A$  be a differential graded  $\mathbf{k}$ -algebra, and  $M, N$  differential graded  $A$ -modules. Then there exists a spectral sequence  $\{E_r, d_r\}$  that converges to  $\mathrm{Tor}_A(M, N)$  and has the  $E_2$ -term*

$$E_2^{-i,j} = \mathrm{Tor}_{H[A]}^{-i,j}(H[M], H[N]), \quad i, j \geq 0,$$

where  $H[\cdot]$  denotes the cohomology algebra (module).

The spectral sequence of Theorem 4.1.1 lives in the *second* quadrant and the differential  $d_r$  adds  $(r, 1 - r)$  to bidegree. This spectral sequence is called the (algebraic) *Eilenberg–Moore spectral sequence*. It gives a decreasing filtration  $\{F^{-p} \mathrm{Tor}_A(M, N)\}$  on  $\mathrm{Tor}_A(M, N)$  with the property that

$$E_\infty^{-p,n+p} = F^{-p} \left( \sum_{-i+j=n} \mathrm{Tor}_A^{-i,j}(M, N) \right) / F^{-p+1} \left( \sum_{-i+j=n} \mathrm{Tor}_A^{-i,j}(M, N) \right).$$

Topological applications of Theorem 4.1.1 arise in the case when  $A, M, N$  are singular (or cellular) cochain algebras of certain topological spaces. The classical situation is described by the commutative diagram

$$(43) \quad \begin{array}{ccc} E & \longrightarrow & E_0 \\ \downarrow & & \downarrow \\ B & \longrightarrow & B_0, \end{array}$$

where  $E_0 \rightarrow B_0$  is a Serre fibre bundle with fibre  $F$  over the simply connected base  $B_0$ , and  $E \rightarrow B$  is the pullback along a continuous map  $B \rightarrow B_0$ . For any space  $X$ , let  $C^*(X)$  denote either the singular cochain algebra of  $X$  or (in the case when  $X$  is a cellular complex) the cellular cochain algebra of  $X$ . Obviously,  $C^*(E_0)$  and  $C^*(B)$  are  $C^*(B_0)$ -modules. Under these assumptions the following statement holds.

**Lemma 4.1.2** ([76, Proposition 3.4]).  *$\mathrm{Tor}_{C^*(B_0)}(C^*(E_0), C^*(B))$  is an algebra in a natural way, and there is a canonical isomorphism of algebras*

$$\mathrm{Tor}_{C^*(B_0)}(C^*(E_0), C^*(B)) \rightarrow H^*(E).$$

Applying Theorem 4.1.1 in the case  $A = C^*(B_0)$ ,  $M = C^*(E_0)$ ,  $N = C^*(B)$  and taking into account Lemma 4.1.2 we obtain

**Theorem 4.1.3** (Eilenberg–Moore). *There exists a spectral sequence of commutative algebras  $\{E_r, d_r\}$  with*

- (a)  $E_r \Rightarrow H^*(E)$ ;
- (b)  $E_2^{-i,j} = \mathrm{Tor}_{H^*(B_0)}^{-i,j}(H^*(E_0), H^*(B))$ .

The spectral sequence of Theorem 4.1.3 is called the (topological) *Eilenberg–Moore spectral sequence*. In the very important particular case when  $B$  is a point (see (43)) we get

**Corollary 4.1.4.** *Let  $E \rightarrow B$  be a fibration over the simply connected space  $B$  with fibre  $F$ . Then there exists a spectral sequence of commutative algebras  $\{E_r, d_r\}$  with*

- (a)  $E_r \Rightarrow H^*(F)$ ,
- (b)  $E_2 = \mathrm{Tor}_{H^*(B)}(H^*(E), \mathbf{k})$ .

We refer to the spectral sequence of Corollary 4.1.3 as the *Eilenberg–Moore spectral sequence of fibration  $E \rightarrow B$* .

**Example 4.1.5.** Let  $M^{2n}$  be a quasitoric manifold over  $P^n$ . Consider the Eilenberg–Moore spectral sequence of the bundle  $ET^n \times_{T^n} M^{2n} \rightarrow BT^n$  with fibre  $M^{2n}$ . By Proposition 3.4.8,  $H^*(ET^n \times_{T^n} M^{2n}) = H^*(B_T \mathcal{Z}_P) \cong \mathbf{k}(P^n)$ . The monomorphism

$$\mathbf{k}[t_1, \dots, t_n] = H^*(BT^n) \rightarrow H^*(ET^n \times_{T^n} M^{2n}) = \mathbf{k}(P^n)$$

takes  $t_i$  to  $\theta_i$ ,  $i = 1, \dots, n$ , see (27). The  $E_2$  term of the Eilenberg–Moore spectral sequence is

$$E_2^{*,*} = \mathrm{Tor}_{H^*(BT^n)}^{*,*}(H^*(ET^n \times_{T^n} M^{2n}), \mathbf{k}) = \mathrm{Tor}_{\mathbf{k}[t_1, \dots, t_n]}^{*,*}(\mathbf{k}(P^n), \mathbf{k}).$$

Since  $\mathbf{k}(P^n)$  is a free  $\mathbf{k}[t_1, \dots, t_n]$ -module, we have

$$\begin{aligned} \mathrm{Tor}_{\mathbf{k}[t_1, \dots, t_n]}^{*,*}(\mathbf{k}(P^n), \mathbf{k}) &= \mathrm{Tor}_{\mathbf{k}[t_1, \dots, t_n]}^{0,*}(\mathbf{k}(P^n), \mathbf{k}) \\ &= \mathbf{k}(P^n) \otimes_{\mathbf{k}[t_1, \dots, t_n]} \mathbf{k} = \mathbf{k}(P^n)/(\theta_1, \dots, \theta_n). \end{aligned}$$

Therefore,  $E_2^{0,*} = \mathbf{k}(P^n)/\mathcal{J}_\ell$  and  $E_2^{-p,*} = 0$  for  $p > 0$ . It follows that the Eilenberg–Moore spectral sequence collapses at the  $E_2$  term and  $H^*(M^{2n}) = \mathbf{k}(P^n)/J_\ell$ , in accordance with Theorem 2.2.7.

**4.2. Cohomology of moment-angle complex  $\mathcal{Z}_K$ : the case of general  $K$ .** Here we apply the Eilenberg–Moore spectral sequence to calculating the cohomology algebra of the moment-angle complex  $\mathcal{Z}_K$ . This describes  $H^*(\mathcal{Z}_K)$  as a *bigraded algebra*. The corresponding bigraded Betti numbers are important combinatorial invariants of  $K$ .

**Theorem 4.2.1.** *The following isomorphism of graded algebras holds:*

$$H^*(\mathcal{Z}_K) \cong \mathrm{Tor}_{\mathbf{k}[v_1, \dots, v_m]}(\mathbf{k}(K), \mathbf{k}).$$

*In particular,*

$$H^p(\mathcal{Z}_K) \cong \sum_{-i+2j=p} \mathrm{Tor}_{\mathbf{k}[v_1, \dots, v_m]}^{-i, 2j}(\mathbf{k}(K), \mathbf{k}).$$

*Proof.* Let us consider the Eilenberg–Moore spectral sequence of the commutative square

$$(44) \quad \begin{array}{ccc} E & \longrightarrow & ET^m \\ \downarrow & & \downarrow \\ SR(K) & \xrightarrow{i} & BT^m, \end{array}$$

where the left vertical arrow is the pullback along  $i$ . Corollary 3.4.5 shows that  $E$  is homotopy equivalent to  $\mathcal{Z}_K$ .

By Proposition 3.4.3, the map  $i : SR(K) \hookrightarrow BT^m$  induces the quotient epimorphism  $i^* : C^*(BT^m) = \mathbf{k}[v_1, \dots, v_m] \rightarrow \mathbf{k}(K) = C^*(SR(K))$ , where  $C^*(\cdot)$  denotes the cellular cochain algebra. Since  $ET^m$  is contractible, there is a chain equivalence  $C^*(ET^m) \simeq \mathbf{k}$ . Therefore, there is an isomorphism

$$(45) \quad \mathrm{Tor}_{C^*(BT^m)}(C^*(SR(K)), C^*(ET^m)) \cong \mathrm{Tor}_{\mathbf{k}[v_1, \dots, v_m]}(\mathbf{k}(K), \mathbf{k}).$$

The Eilenberg–Moore spectral sequence of commutative square (44) has

$$E_2 = \mathrm{Tor}_{H^*(BT^m)}(H^*(SR(K)), H^*(ET^m))$$

and converges to  $\mathrm{Tor}_{C^*(BT^m)}(C^*(SR(K)), C^*(ET^m))$  (Theorem 4.1.1). Since

$$\mathrm{Tor}_{H^*(BT^m)}(H^*(SR(K)), H^*(ET^m)) = \mathrm{Tor}_{\mathbf{k}[v_1, \dots, v_m]}(\mathbf{k}(K), \mathbf{k}),$$

it follows from (45) that the spectral sequence collapses at the  $E_2$  term, that is,  $E_2 = E_\infty$ . Lemma 4.1.2 shows that the module  $\mathrm{Tor}_{C^*(BT^m)}(C^*(SR(K)), C^*(ET^m))$  is an algebra isomorphic to  $H^*(\mathcal{Z}_K)$ , which concludes the proof.  $\square$

Theorem 4.2.1 describes the cohomology of  $\mathcal{Z}_K$  as a *bigraded* algebra and shows that the corresponding bigraded Betti numbers  $b^{-i, 2j}(\mathcal{Z}_K)$  coincide with that of  $\mathbf{k}(K)$ , see (17). Using the Koszul resolution for  $\mathbf{k}$  and Lemma 1.4.6, we get

**Theorem 4.2.2.** *The following isomorphism of bigraded algebras holds:*

$$H^{*,*}(\mathcal{Z}_K) \cong H[\Lambda[u_1, \dots, u_m] \otimes \mathbf{k}(K), d],$$

where the bigraded structure and the differential in the right hand side are defined by (16).

In the sequel we denote square-free monomials

$$u_{i_1} \dots u_{i_p} v_{j_1} \dots v_{j_q} \in [\Lambda[u_1, \dots, u_m] \otimes \mathbf{k}(K), d]$$

by  $u_I v_J$ , where  $I = \{i_1, \dots, i_p\}$ ,  $J = \{j_1, \dots, j_q\}$ . Note that  $\mathrm{bideg} u_I v_J = (-p, 2(p+q))$ .

*Remark.* Since the differential  $d$  in (16) does not change the second degree, the differential bigraded algebra  $[\Lambda[u_1, \dots, u_m] \otimes \mathbf{k}(K), d]$  splits into the sum of differential algebras consisting of elements of fixed second degree.

**Corollary 4.2.3.** *The Leray–Serre spectral sequence of the principal  $T^m$ -bundle  $ET^m \times \mathcal{Z}_K \rightarrow B_T \mathcal{Z}_K$  collapses at the  $E_3$  term.*

*Proof.* The spectral sequence under consideration converges to  $H^*(ET^m \times \mathcal{Z}_K) = H^*(\mathcal{Z}_K)$  and has

$$E_2 = H^*(B_T \mathcal{Z}_K) \otimes H^*(T^m) = \Lambda[u_1, \dots, u_m] \otimes \mathbf{k}(K).$$

The differential in the  $E_2$  term acts as in (16). Hence,

$$E_3 = H[E_2, d] = H[\Lambda[u_1, \dots, u_m] \otimes \mathbf{k}(K)] = H^*(\mathcal{Z}_K)$$

(the last identity follows from Theorem 4.2.2).  $\square$

**Construction 4.2.4.** Let  $A^{-q}(K) \subset \Lambda[u_1, \dots, u_m] \otimes \mathbf{k}(K)$  be the subspace generated by monomials  $u_I$  and  $u_I v_J$  such that  $J$  is a simplex of  $K$ ,  $\#I = q$  and  $I \cap J = \emptyset$ . Define

$$A^*(K) = \bigoplus_{q=0}^m A^{-q}(K).$$

Since  $d(u_i) = v_i$ , we have  $d(A^{-q}(K)) \subset A^{-q+1}(K)$ . Therefore,  $A^*(K)$  is a cochain subcomplex in  $[\Lambda[u_1, \dots, u_m] \otimes \mathbf{k}(K), d]$ . Moreover,  $A^*(K)$  inherits the bigraded module structure from  $\Lambda[u_1, \dots, u_m] \otimes \mathbf{k}(K)$ , with differential  $d$  adding  $(1, 0)$  to

bidegree. Hence, we have the additive inclusion (i.e. the monomorphism of bigraded modules)  $i_a : A^*(K) \hookrightarrow \Lambda[u_1, \dots, u_m] \otimes \mathbf{k}(K)$ . Finally,  $A^*(K)$  is an algebra in the obvious way, but is *not* a subalgebra of  $\Lambda[u_1, \dots, u_m] \otimes \mathbf{k}(K)$ . (Indeed, for instance,  $v_1^2 = 0$  in  $A^*(K)$  but not in  $\Lambda[u_1, \dots, u_m] \otimes \mathbf{k}(K)$ .) Nevertheless, we have the multiplicative *projection* (an epimorphism of bigraded algebras)  $j_m : \Lambda[u_1, \dots, u_m] \otimes \mathbf{k}(K) \rightarrow A^*(K)$ . The additive inclusion  $i_a$  and the multiplicative projection  $j_m$  obviously satisfy  $j_m \cdot i_a = \text{id}$ .

**Lemma 4.2.5.** *Cochain complexes  $[\Lambda[u_1, \dots, u_m] \otimes \mathbf{k}(K), d]$  and  $[A^*(K), d]$  have the same cohomology. This implies the following isomorphism of bigraded  $\mathbf{k}$ -modules:*

$$H[A^*(K), d] \cong \text{Tor}_{\mathbf{k}[v_1, \dots, v_m]}(\mathbf{k}(K), \mathbf{k}).$$

*Proof.* A routine check shows that the cochain homotopy operator  $s$  for the Koszul resolution (see the proof of Proposition VII.2.1 in [56]) establishes a cochain homotopy equivalence between the maps  $\text{id}$  and  $i_a \cdot j_m$  of the algebra  $[\Lambda[u_1, \dots, u_m] \otimes \mathbf{k}(K), d]$  to itself. That is,

$$ds + sd = \text{id} - i_a \cdot j_m.$$

We just illustrate the above identity on few simple examples.

- 1)  $s(u_1 v_2) = u_1 u_2$ ,  $ds(u_1 v_2) = u_2 v_1 - u_1 v_2$ ,  $sd(u_1 v_2) = u_1 v_2 - u_2 v_1$ ,  
hence,  $(ds + sd)(u_1 v_2) = 0 = (\text{id} - i_a \cdot j_m)(u_1 v_2)$ ;
- 2)  $s(u_1 v_1) = u_1^2 = 0$ ,  $ds(u_1 v_1) = 0$ ,  $d(u_1 v_1) = v_1^2$ ,  $sd(u_1 v_1) = u_1 v_1$ ,  
hence,  $(ds + sd)(u_1 v_1) = u_1 v_1 = (\text{id} - i_a \cdot j_m)(u_1 v_1)$ ;
- 3)  $s(v_1^2) = u_1 v_1$ ,  $ds(v_1^2) = v_1^2$ ,  $d(v_1^2) = 0$ ,  
hence,  $(ds + sd)(v_1^2) = v_1^2 = (\text{id} - i_a \cdot j_m)(v_1^2)$ .

□

Now we recall our cellular decomposition of  $\mathcal{Z}_K$ , see Lemma 3.3.2. The cells are  $D_I T_J$  with  $J \subset [m]$ ,  $I \in K$ , and  $I \cap J = \emptyset$ . Let  $C_*(\mathcal{Z}_K)$  and  $C^*(\mathcal{Z}_K)$  denote the corresponding cellular chain and cochain complexes respectively. Both complexes  $C^*(\mathcal{Z}_K)$  and  $A^*(K)$  have the same cohomology  $H^*(\mathcal{Z}_K)$ . The complex  $C^*(\mathcal{Z}_K)$  has the basis consisting of cochains  $(D_I T_J)^*$ . As an algebra,  $C^*(\mathcal{Z}_K)$  is generated by the cochains  $T_i^*$ ,  $D_i^*$  of dimension 1 and 2 respectively dual to the cells  $T_i$  and  $D_i$ ,  $i, j = 1, \dots, m$ . At the same time,  $A^*(K)$  is multiplicatively generated by  $u_i$ ,  $v_i$ ,  $i, j = 1, \dots, m$ .

**Theorem 4.2.6.** *The correspondence  $v_I u_J \mapsto (D_I T_J)^*$  establishes a canonical isomorphism of differential graded algebras  $A^*(K)$  and  $C^*(\mathcal{Z}_K)$ .*

*Proof.* It follows directly from the definitions of  $A^*(K)$  and  $C^*(\mathcal{Z}_K)$  that the map is an isomorphism of graded algebras. Thus, it remains to prove that it commutes with differentials. Let  $d$ ,  $d_c$  and  $\partial_c$  denote the differentials in  $A^*(K)$ ,  $C^*(\mathcal{Z}_K)$  and  $C_*(\mathcal{Z}_K)$  respectively. Since  $d(v_i) = 0$ ,  $d(u_i) = v_i$ , we need to show that  $d_c(D_i^*) = 0$ ,  $d_c(T_i^*) = D_i^*$ . We have  $\partial_c(D_i) = T_i$ ,  $\partial_c(T_i) = 0$ . Any 2-cell of  $\mathcal{Z}_K$  is either  $D_j$  or  $T_{jk}$ ,  $k \neq j$ . Then

$$(d_c T_i^*, D_j) = (T_i^*, \partial_c D_j) = (T_i^*, T_j) = \delta_{ij}, \quad (d_c T_i^*, T_{jk}) = (T_i^*, \partial_c T_{jk}) = 0,$$

where  $\delta_{ij} = 1$  if  $i = j$  and  $\delta_{ij} = 0$  otherwise. Hence,  $d_c(T_i^*) = D_i^*$ . Further, any 3-cell of  $\mathcal{Z}_K$  is either  $D_j T_k$  or  $T_{j_1 j_2 j_3}$ . Then

$$\begin{aligned} (d_c D_i^*, D_j T_k) &= (D_i^*, \partial_c(D_j T_k)) = (D_i^*, T_{jk}) = 0, \\ (d_c D_i^*, T_{j_1 j_2 j_3}) &= (D_i^*, \partial_c T_{j_1 j_2 j_3}) = 0. \end{aligned}$$

Hence,  $d_c(D_i^*) = 0$ .  $\square$

Theorem 4.2.6 provides a topological interpretation for the differential algebra  $[A^*(K), d]$ . In the sequel we do not distinguish the cochain complexes  $A^*(K)$  and  $C^*(\mathcal{Z}_K)$ , and identify  $u_i$  with  $T_i^*$ ,  $v_i$  with  $D_i^*$ .

Now we recall that the algebra  $[A^*(K), d]$  is bigraded. The isomorphism of Theorem 4.2.6 provides a bigraded structure for the cellular chain complex  $C_*(\mathcal{Z}_K), \partial_c$ , with

$$(46) \quad \text{bideg}(D_i) = (0, 2), \quad \text{bideg}(T_i) = (-1, 2), \quad \text{bideg}(1_i) = (0, 0).$$

The differential  $\partial_c$  adds  $(-1, 0)$  to bidegree, and the cellular homology of  $\mathcal{Z}_K$  also acquires a bigraded structure.

Let us assume now that the ground field  $\mathbf{k}$  is of zero characteristic (e.g.  $\mathbf{k} = \mathbb{Q}$ , the field of rational numbers). Define the bigraded Betti numbers

$$(47) \quad b_{-q, 2p}(\mathcal{Z}_K) = \dim H_{-q, 2p}[C_*(\mathcal{Z}_K), \partial_c], \quad q, p = 0, \dots, m.$$

Theorem 4.2.6 and Lemma 4.2.5 show that

$$(48) \quad b_{-q, 2p}(\mathcal{Z}_K) = \dim \text{Tor}_{\mathbf{k}[v_1, \dots, v_m]}^{-q, 2p}(\mathbf{k}(K), \mathbf{k}) = \beta^{-q, 2p}(\mathbf{k}(K))$$

(see (17)). Alternatively,  $b_{-q, 2p}(\mathcal{Z}_K)$  equals the dimension of  $(-q, 2p)$ -th bigraded component of the cohomology algebra  $H[\Lambda[u_1, \dots, u_m] \otimes \mathbf{k}(K), d]$ . For the ordinary Betti numbers  $b_k(\mathcal{Z}_K)$  holds

$$(49) \quad b_k(\mathcal{Z}_K) = \sum_{-q+2p=k} b_{-q, 2p}(\mathcal{Z}_K), \quad k = 0, \dots, m+n.$$

Below we describe some basic properties of bigraded Betti numbers (47).

**Lemma 4.2.7.** *Let  $K^{n-1}$  be a simplicial complex with  $m = f_0$  vertices and  $f_1$  edges, and let  $\mathcal{Z}_K$  be the corresponding moment-angle complex,  $\dim \mathcal{Z}_K = m+n$ . Then*

- (a)  $b_{0,0}(\mathcal{Z}_K) = b_0(\mathcal{Z}_K) = 1$ ,  $b_{0,2p}(\mathcal{Z}_K) = 0$  for  $p > 0$ ;
- (b)  $b_{-q, 2p} = 0$  for  $p > m$  or  $q > p$ ;
- (c)  $b_1(\mathcal{Z}_K) = b_2(\mathcal{Z}_K) = 0$ ;
- (d)  $b_3(\mathcal{Z}_K) = b_{-1,4}(\mathcal{Z}_K) = \binom{f_0}{2} - f_1$ ;
- (e)  $b_{-q, 2p}(\mathcal{Z}_K) = 0$  for  $q \geq p > 0$  or  $p - q > n$ ;
- (f)  $b_{m+n}(\mathcal{Z}_K) = b_{-(m-n), 2m}(\mathcal{Z}_K)$ .

*Proof.* We make calculations with the cochain complex  $A^*(K) \subset \Lambda[u_1, \dots, u_m] \otimes \mathbf{k}(K)$ . The module  $A^*(K)$  has the basis consisting of monomials  $u_J v_I$  with  $I \in K$  and  $I \cap J = \emptyset$ . Since  $\text{bideg } v_i = (0, 2)$ ,  $\text{bideg } u_j = (-1, 2)$ , the bigraded component  $A^{-q, 2p}(K)$  is generated by monomials  $u_J v_I$  with  $\#I = p - q$  and  $\#J = q$ . In particular,  $A^{-q, 2p}(K) = 0$  if  $p > m$  or  $q > p$ , whence the assertion (b) follows. To prove (a) we observe that  $A^{0,0}(K)$  is generated by 1, while any  $v_I \in A^{0,2p}(K)$ ,  $p > 0$ , is a coboundary, whence  $H^{0,2p}(\mathcal{Z}_K) = 0$ ,  $p > 0$ .

Now we prove the assertion (e). Any  $u_J v_I \in A^{-q, 2p}(K)$  has  $I \in K$ , while any simplex of  $K$  is at most  $(n-1)$ -dimensional. It follows that  $A^{-q, 2p}(K) = 0$  for  $p - q >$

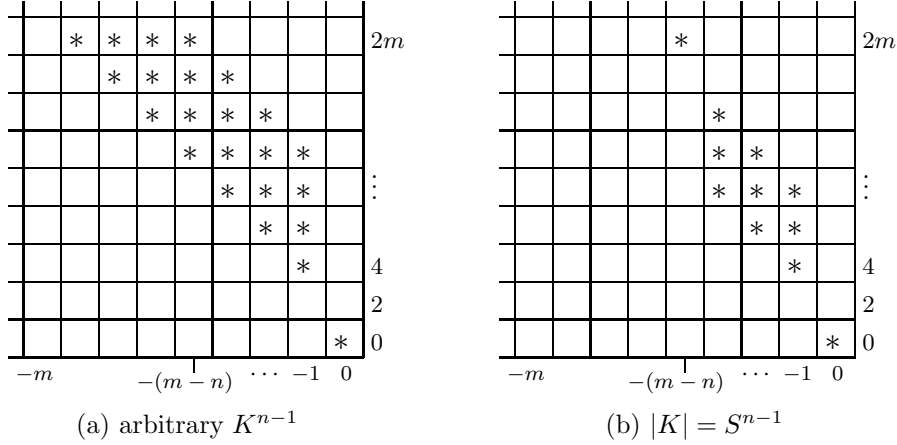

FIGURE 8. Possible locations of non-zero bigraded Betti numbers  $b_{-q,2p}(\mathcal{Z}_K)$  (marked by \*).

$n$ . By (b),  $b_{-q,2p}(\mathcal{Z}_K) = 0$  for  $q > p$ , so it remains to prove that  $b_{-q,2q}(\mathcal{Z}_K) = 0$  for  $q > 0$ . The module  $A^{-q,2q}(K)$  is generated by monomials  $u_J$ ,  $\#J = q$ . Since  $d(u_i) = v_i$ , it follows easily that there are no non-zero cocycles in  $A^{-q,2q}(K)$ . Hence,  $H^{-q,2q}(\mathcal{Z}_K) = 0$ .

The assertion (c) follows from (e) and (49).

It also follows from (e) that  $H^3(\mathcal{Z}_K) = H^{-1,4}(\mathcal{Z}_K)$ . The basis for  $A^{-1,4}(K)$  consists of monomials  $u_j v_i$ ,  $i \neq j$ . We have  $d(u_j v_i) = v_i v_j$  and  $d(u_i u_j) = u_j v_i - u_i v_j$ . It follows that  $u_j v_i$  is a cocycle if and only if  $\{i, j\}$  is not a 1-simplex in  $K$ ; in this case two cocycles  $u_j v_i$  and  $u_i v_j$  represent the same cohomology class. The assertion (d) now follows easily.

The remaining assertion (f) follows from the fact that the monomial  $u_I v_J \in A^*(K)$  of maximal total degree  $m + n$  necessarily has  $\#I + \#J = m$ ,  $\#J = n$ ,  $\#I = m - n$ .  $\square$

Lemma 4.2.7 shows that non-zero bigraded Betti numbers  $b_{r,2p}(\mathcal{Z}_K)$ ,  $r \neq 0$  appear only in the “strip” bounded by the lines  $p = m$ ,  $r = -1$ ,  $p + r = 1$  and  $p + r = n$  in the second quadrant (see Figure 8 (a)).

The homogeneous component  $C_{-q,2p}(\mathcal{Z}_K)$  has the basis consisting of cellular chains  $D_I T_J$  with  $I \in K$ ,  $\#I = p - q$ ,  $\#J = q$ . It follows that

$$(50) \quad \dim C_{-q,2p}(\mathcal{Z}_K) = f_{p-q-1} \binom{m-p+q}{q}$$

(we assume  $\binom{i}{j} = 0$  if  $i < j$  or  $j < 0$ ), where  $(f_0, f_1, \dots, f_{n-1})$  is the  $f$ -vector of  $K^{n-1}$  and  $f_{-1} = 1$ . The differential  $\partial_c$  does not change the second degree, i.e.

$$\partial_c : C_{-q,2p}(\mathcal{Z}_K) \rightarrow C_{-q-1,2p}(\mathcal{Z}_K).$$

Hence, the chain complex  $C_{*,*}(\mathcal{Z}_K)$  splits as follows:

$$[C_{*,*}(\mathcal{Z}_K), \partial_c] = \bigoplus_{p=0}^m [C_{*,2p}(\mathcal{Z}_K), \partial_c].$$

*Remark.* The similar decomposition holds also for the cellular cochain complex  $[C^{*,*}(\mathcal{Z}_K), d_c] \cong [A^{*,*}(K), d]$ .



Let us consider the Euler characteristic of the complex  $[C_{*,2p}(\mathcal{Z}_K), \partial_c]$ :

$$(51) \quad \chi_p(\mathcal{Z}_K) := \sum_{q=0}^m (-1)^q \dim C_{-q,2p}(\mathcal{Z}_K) = \sum_{q=0}^m (-1)^q b_{-q,2p}(\mathcal{Z}_K).$$

Define the generating polynomial  $\chi(\mathcal{Z}_K; t)$  as

$$\chi(\mathcal{Z}_K; t) = \sum_{p=0}^m \chi_p(\mathcal{Z}_K) t^{2p}.$$

The following theorem calculates this polynomial in terms of the  $h$ -vector of  $K$ .

**Theorem 4.2.8.** *For any  $(n-1)$ -dimensional simplicial complex  $K$  with  $m$  vertices holds*

$$(52) \quad \chi(\mathcal{Z}_K; t) = (1-t^2)^{m-n} (h_0 + h_1 t^2 + \cdots + h_n t^{2n}),$$

where  $(h_0, h_1, \dots, h_n)$  is the  $h$ -vector of  $K$ .

*Proof.* It follows from (51) and (50) that

$$(53) \quad \chi_p(\mathcal{Z}_K) = \sum_{j=0}^m (-1)^{p-j} f_{j-1} \binom{m-j}{p-j},$$

Then

$$(54) \quad \begin{aligned} \chi(\mathcal{Z}_K; t) &= \sum_{p=0}^m \chi_p(\mathcal{Z}_K) t^{2p} = \sum_{p=0}^m \sum_{j=0}^m t^{2j} t^{2(p-j)} (-1)^{p-j} f_{j-1} \binom{m-j}{p-j} \\ &= \sum_{j=0}^m f_{j-1} t^{2j} (1-t^2)^{m-j} = (1-t^2)^m \sum_{j=0}^n f_{j-1} (t^{-2} - 1)^{-j}. \end{aligned}$$

Denote  $h(t) = h_0 + h_1 t + \cdots + h_n t^n$ . Then it follows from (7) that

$$t^n h(t^{-1}) = (t-1)^n \sum_{i=0}^n f_{i-1} (t-1)^{-i}.$$

Substituting  $t^{-2}$  for  $t$  above, we finally obtain from (54)

$$\frac{\chi(\mathcal{Z}_K; t)}{(1-t^2)^m} = \frac{t^{-2n} h(t^2)}{(t^{-2} - 1)^n} = \frac{h(t^2)}{(1-t^2)^n},$$

which is equivalent to (52).  $\square$

Theorem 4.2.8 allows to express the numbers of faces of a simplicial complex in terms of the bigraded Betti numbers of the corresponding moment-angle complex  $\mathcal{Z}_K$ .

**Corollary 4.2.9.** *For any simplicial complex  $K$  the Euler characteristic of the corresponding moment-angle complex  $\mathcal{Z}_K$  is zero.*

*Proof.* We have

$$\chi(\mathcal{Z}_K) = \sum_{p,q=0}^m (-1)^{-q+2p} b_{-q,2p}(\mathcal{Z}_K) = \sum_{p=0}^m \chi_p(\mathcal{Z}_K) = \chi(\mathcal{Z}_K; 1)$$

Now the statement follows from (52).  $\square$

*Remark.* Another proof of the above corollary follows from the observation that the diagonal subgroup  $S^1 \subset T^m$  always acts freely on  $\mathcal{Z}_K$  (see also section 4.4). Hence, there exists a principal  $S^1$ -bundle  $\mathcal{Z}_K \rightarrow \mathcal{Z}_K/S^1$ , which implies  $\chi(\mathcal{Z}_K) = 0$ .

The torus  $T^m = \rho^{-1}(1, \dots, 1)$  is a cellular subcomplex of  $\mathcal{Z}_K$  (see Lemma 3.3.3). The cellular cochain subcomplex  $C^*(T^m) \subset C^*(\mathcal{Z}_K) \cong A^*(K)$  has the basis consisting of cochains  $(T_i)^*$  and is mapped to the exterior algebra  $\Lambda[u_1, \dots, u_m] \subset A^*(K)$  under the isomorphism of Theorem 4.2.6. It follows that there is an isomorphism of modules

$$(55) \quad C^*(\mathcal{Z}_K, T^m) \cong A^*(K)/\Lambda[u_1, \dots, u_m].$$

Likewise, we introduce relative bigraded Betti numbers

$$(56) \quad b_{-q, 2p}(\mathcal{Z}_K, T^m) = \dim H^{-q, 2p}[C^*(\mathcal{Z}_K, T^m), d], \quad q, p = 0, \dots, m,$$

define the  $p$ -th relative Euler characteristic  $\chi_p(\mathcal{Z}_K, T^m)$  as

$$(57) \quad \chi_p(\mathcal{Z}_K, T^m) = \sum_{q=0}^m (-1)^q \dim C^{-q, 2p}(\mathcal{Z}_K, T^m) = \sum_{q=0}^m (-1)^q b_{-q, 2p}(\mathcal{Z}_K, T^m),$$

and define the generating polynomial  $\chi(\mathcal{Z}_K, T^m; t)$  as

$$\chi(\mathcal{Z}_K, T^m; t) = \sum_{p=0}^m \chi_p(\mathcal{Z}_K, T^m) t^{2p}.$$

**Theorem 4.2.10.** *For any  $(n-1)$ -dimensional simplicial complex  $K$  with  $m$  vertices holds*

$$(58) \quad \chi(\mathcal{Z}_K, T^m; t) = (1-t^2)^{m-n} (h_0 + h_1 t^2 + \dots + h_n t^{2n}) - (1-t^2)^m.$$

*Proof.* Since  $C^*(T^m) = \Lambda[u_1, \dots, u_m]$  and  $\text{bideg } u_i = (-1, 2)$ , we have

$$\dim C^{-q}(T^m) = \dim C^{-q, 2q}(T^m) = \binom{m}{q}.$$

Combining (55), (51) and (57) we get

$$\chi_p(\mathcal{Z}_K, T^m) = \chi_p(\mathcal{Z}_K) - (-1)^p \dim C^{-p, 2p}(T^m).$$

Hence,

$$\begin{aligned} \chi(\mathcal{Z}_K, T^m; t) &= \chi(\mathcal{Z}_K; t) - \sum_{p=0}^m (-1)^p \binom{m}{p} t^{2p} \\ &= (1-t^2)^{m-n} (h_0 + h_1 t^2 + \dots + h_n t^{2n}) - (1-t^2)^m, \end{aligned}$$

where we used (52).  $\square$

We will use Theorem 4.2.10 in section 4.5.

**Theorem 4.2.11.** *Suppose that  $K^{n-1}$  is Cohen–Macaulay, and let  $\mathcal{J}$  be the ideal in  $\mathbf{k}(K)$  generated by a degree-two regular sequence of length  $n$ . Then the following isomorphism of algebras holds:*

$$H^*(\mathcal{Z}_K) \cong \text{Tor}_{\mathbf{k}[v_1, \dots, v_m]/\mathcal{J}}(\mathbf{k}(K)/\mathcal{J}, \mathbf{k}).$$

*Proof.* This follows from Theorem 4.2.1 and Lemma 1.4.9.  $\square$

Note that the  $\mathbf{k}$ -algebra  $\mathbf{k}(K)/\mathcal{J}$  is finite-dimensional. This fact sometimes makes Theorem 4.2.11 more convenient for calculations (in the Cohen–Macaulay case) than general Theorem 4.2.1.

### 4.3. Cohomology of moment-angle complex $\mathcal{Z}_K$ : the case of spherical $K$ .

If  $K$  is a simplicial sphere, then the complex  $\mathcal{Z}_K$  is a manifold (Lemma 3.2.2). This imposes additional conditions on the cohomology of  $\mathcal{Z}_K$ ; the corresponding results are described in this section together with some interesting interpretations of combinatorial problems reviewed in chapter 1.

**Theorem 4.3.1.** *Let  $K$  be an  $(n-1)$ -dimensional simplicial sphere, and  $\mathcal{Z}_K$  the corresponding moment-angle manifold,  $\dim \mathcal{Z}_K = m+n$ . Then the fundamental cohomology class of  $\mathcal{Z}_K$  is represented by any monomial  $\pm v_I u_J \in A^*(K)$  of bidegree  $(-(m-n), 2m)$  such that  $I$  is an  $(n-1)$ -simplex of  $K$  and  $I \cap J = \emptyset$ . The sign depends on the orientation of  $\mathcal{Z}_K$ .*

*Proof.* It follows from Lemma 4.2.7 (f) that  $H^{m+n}(\mathcal{Z}_K) = H^{-(m-n), 2m}(\mathcal{Z}_K)$ . By definition, the module  $A^{-(m-n), 2m}(K)$  is spanned by monomials  $v_I u_J$  such that  $I \in K^{n-1}$ ,  $\#I = n$ ,  $J = [m] \setminus I$ . Any such monomial is a cocycle. Suppose that  $I, I'$  are two  $(n-1)$ -simplices of  $K^{n-1}$  that share a common  $(n-2)$ -face. We claim that the corresponding cocycles  $v_I u_J, v_{I'} u_{J'}$ , where  $J = [m] \setminus I$ ,  $J' = [m] \setminus I'$ , represent the same cohomology class (up to a sign). Indeed, let  $v_I u_J = v_{i_1} \cdots v_{i_n} u_{j_1} \cdots u_{j_{m-n}}$ ,  $v_{I'} u_{J'} = v_{i_1} \cdots v_{i_{n-1}} v_{j_1} u_{i_n} u_{j_2} \cdots u_{j_{m-n}}$ . Since any  $(n-2)$ -face of  $K$  is contained in exactly two  $(n-1)$ -faces, the identity

$$\begin{aligned} d(v_{i_1} \cdots v_{i_{n-1}} u_{i_n} u_{j_1} u_{j_2} \cdots u_{j_{m-n}}) \\ = v_{i_1} \cdots v_{i_n} u_{j_1} \cdots u_{j_{m-n}} - v_{i_1} \cdots v_{i_{n-1}} v_{j_1} u_{i_n} u_{j_2} \cdots u_{j_{m-n}} \end{aligned}$$

holds in  $A^*(K) \subset \Lambda[u_1, \dots, u_m] \otimes \mathbf{k}(K)$ . Hence,  $[v_I u_J] = [v_{I'} u_{J'}]$  (as cohomology classes). Since  $K^{n-1}$  is a simplicial sphere, any two  $(n-1)$ -simplices can be connected by a chain of simplices such that any two successive simplices share a common  $(n-2)$ -face. Thus, all monomials  $v_I u_J$  in  $A^{-(m-n), 2m}(K)$  represent the same cohomology class (up to a sign). This class is the generator of  $H^{m+n}(\mathcal{Z}_K)$ , i.e. the fundamental cohomology class of  $\mathcal{Z}_K$ .  $\square$

*Remark.* In the proof of the above theorem we have used two combinatorial properties of  $K^{n-1}$ . The first one is that any  $(n-2)$ -face is contained in exactly two  $(n-1)$ -faces, and the second is that any two  $(n-1)$ -simplices can be connected by a chain of simplices such that any two successive simplices share a common  $(n-2)$ -face. Both properties hold for any simplicial manifold. Hence, for any simplicial manifold  $K^{n-1}$  we have  $b_{m+n}(\mathcal{Z}_K) = b_{-(m-n), 2m}(\mathcal{Z}_K) = 1$ , and the generator of  $H^{m+n}(\mathcal{Z}_K)$  can be chosen as described in Theorem 4.3.1.

**Corollary 4.3.2.** *The Poincaré duality for the moment angle manifold  $\mathcal{Z}_K$  defined by a simplicial sphere  $K^{n-1}$  regards the bigraded structure in the (co)homology, i.e.*

$$H^{-q, 2p}(\mathcal{Z}_K) \cong H_{-(m-n)+q, 2(m-p)}(\mathcal{Z}_K).$$

In particular,

$$(59) \quad b_{-q, 2p}(\mathcal{Z}_K) = b_{-(m-n)+q, 2(m-p)}(\mathcal{Z}_K). \quad \square$$

**Corollary 4.3.3.** *Let  $K^{n-1}$  be an  $(n-1)$ -dimensional simplicial sphere, and  $\mathcal{Z}_K$  the corresponding moment-angle complex,  $\dim \mathcal{Z}_K = m+n$ . Then*

- (a)  $b_{-q, 2p}(\mathcal{Z}_K) = 0$  for  $q \geq m-n$ , with only exception  $b_{-(m-n), 2m} = 1$ ;
- (b)  $b_{-q, 2p}(\mathcal{Z}_K) = 0$  for  $p-q \geq n$ , with only exception  $b_{-(m-n), 2m} = 1$ .

It follows that if  $K^{n-1}$  is a simplicial sphere, then non-zero bigraded Betti numbers  $b_{r,2p}(\mathcal{Z}_K)$ ,  $r \neq 0$ ,  $r \neq m-n$ , appear only in the “strip” bounded by the lines  $r = -(m-n-1)$ ,  $r = -1$ ,  $p+r = 1$  and  $p+r = n-1$  in the second quadrant (see Figure 8 (b)). Compare this with Figure 8 (a) corresponding to the case of general  $K$ .

**Example 4.3.4.** Let  $K = \partial\Delta^{m-1}$ . Then  $\mathbf{k}(K) = \mathbf{k}[v_1, \dots, v_m]/(v_1 \cdots v_m)$  (Example 1.3.4). It is easy to see that the cohomology groups  $H[\mathbf{k}(K) \otimes \Lambda[u_1, \dots, u_m], d]$  (see Theorem 4.2.2) are generated by the classes 1 and  $[v_1 v_2 \cdots v_{m-1} u_m]$ . We have  $\deg(v_1 v_2 \cdots v_{m-1} u_m) = 2m-1$ , and Theorem 4.3.1 shows that  $v_1 v_2 \cdots v_{m-1} u_m$  represents the fundamental cohomology class of  $\mathcal{Z}_K \cong S^{2m-1}$  (see Example 3.1.7).

**Example 4.3.5.** Let  $K$  be the boundary complex of an  $m$ -gon  $P^2$  with  $m \geq 4$ . We have  $\mathbf{k}(K) = \mathbf{k}[v_1, \dots, v_m]/\mathcal{I}_P$ , where  $\mathcal{I}_P$  is generated by the monomials  $v_i v_j$ ,  $i-j \neq 0, 1 \pmod m$ . The complex  $\mathcal{Z}_K = \mathcal{Z}_P$  is a smooth manifold of dimension  $m+2$ . The Betti numbers and the cohomology rings of these manifolds were calculated in [20]. Namely,

$$\dim H^k(\mathcal{Z}_P) = \begin{cases} 1 & \text{for } k = 0, m+2; \\ 0 & \text{for } k = 1, 2, m, m+1; \\ (m-2)\binom{m-2}{k-2} - \binom{m-2}{k-1} - \binom{m-2}{k-3} & \text{for } 3 \leq k \leq m-1. \end{cases}$$

For example, in the case  $m = 5$  the group  $H^3(\mathcal{Z}_P)$  has 5 generators represented by the cocycles  $v_i u_{i+2} \in \mathbf{k}(K) \otimes \Lambda[u_1, \dots, u_5]$ ,  $i = 1, \dots, 5$ , while the group  $H^4(\mathcal{Z}_P)$  has 5 generators represented by the cocycles  $v_j u_{j+2} u_{j+3}$ ,  $j = 1, \dots, 5$ . As it follows from Theorem 4.3.1, the product of cocycles  $v_i u_{i+2}$  and  $v_j u_{j+2} u_{j+3}$  represents a non-zero cohomology class in  $H^7(\mathcal{Z}_P)$  if and only if all indices  $i, i+2, j, j+2, j+3$  are different. Thus, for each of the 5 cohomology classes  $[v_i u_{i+2}]$  there is the unique (Poincaré dual) cohomology class  $[v_j u_{j+2} u_{j+3}]$  such that the product  $[v_i u_{i+2}] \cdot [v_j u_{j+2} u_{j+3}]$  is non-zero.

It follows from (51) and (59) that for any simplicial sphere  $K$  holds

$$\chi_p(\mathcal{Z}_K) = (-1)^{m-n} \chi_{m-p}(\mathcal{Z}_K).$$

From this and (52) we get

$$\begin{aligned} \frac{h_0 + h_1 t^2 + \cdots + h_n t^{2n}}{(1-t^2)^n} &= (-1)^{m-n} \frac{\chi_m + \chi_{m-1} t^2 + \cdots + \chi_0 t^{2m}}{(1-t^2)^m} \\ &= (-1)^n \frac{\chi_0 + \chi_1 t^{-2} + \cdots + \chi_m t^{-2m}}{(1-t^{-2})^m} = (-1)^n \frac{h_0 + h_1 t^{-2} + \cdots + h_n t^{-2n}}{(1-t^{-2})^n} \\ &= \frac{h_0 t^{2n} + h_1 t^{2(n-1)} + \cdots + h_n}{(1-t^2)^n}. \end{aligned}$$

Hence,  $h_i = h_{n-i}$ . Thus, the Dehn–Sommerville equations are a corollary of the bigraded Poincaré duality (59).

The identity (52) also allows to interpret different inequalities for the  $f$ -vectors of simplicial spheres (respectively, simplicial manifolds) in terms of topological invariants (bigraded Betti numbers) of the corresponding moment-angle manifolds (respectively, complexes)  $\mathcal{Z}_K$ .

**Example 4.3.6.** It follows from Lemma 4.2.7 that for any  $K$  we have

$$\begin{aligned}\chi_0(\mathcal{Z}_K) &= 1, & \chi_1(\mathcal{Z}_K) &= 0, \\ \chi_2(\mathcal{Z}_K) &= -b_{-1,4}(\mathcal{Z}_K) = -b_3(\mathcal{Z}_K), & \chi_3(\mathcal{Z}_K) &= b_{-2,6}(\mathcal{Z}_K) - b_{-1,6}(\mathcal{Z}_K)\end{aligned}$$

(note that  $b_4(\mathcal{Z}_K) = b_{-2,6}(\mathcal{Z}_K)$ , while  $b_5(\mathcal{Z}_K) = b_{-1,6}(\mathcal{Z}_K) + b_{-3,8}(\mathcal{Z}_K)$ ). Now, identity (52) shows that

$$\begin{aligned}h_0 &= 1, \\ h_1 &= m - n, \\ h_2 &= \binom{m-n+1}{2} - b_3(\mathcal{Z}_K), \\ h_3 &= \binom{m-n+2}{3} - (m-n)b_{-1,4}(\mathcal{Z}_K) + b_{-2,6}(\mathcal{Z}_K) - b_{-1,6}(\mathcal{Z}_K).\end{aligned}$$

It follows that the inequality  $h_1 \leq h_2$  ( $n \geq 4$ ) from the Generalized Lower Bound hypothesis (13) for simplicial spheres is equivalent to the following:

$$(60) \quad b_3(\mathcal{Z}_K) \leq \binom{m-n}{2}.$$

The next inequality  $h_2 \leq h_3$  ( $n \geq 6$ ) from (13) is equivalent to the following inequality for the bigraded Betti numbers of  $\mathcal{Z}_K$ :

$$(61) \quad \binom{m-n+1}{3} - (m-n-1)b_{-1,4}(\mathcal{Z}_K) + b_{-2,6}(\mathcal{Z}_K) - b_{-1,6}(\mathcal{Z}_K) \geq 0.$$

We see that the combinatorial Generalized Lower Bound inequalities are interpreted as “topological” inequalities for the (bigraded) Betti numbers of a certain manifold. So, one can try to use topological methods (such as the equivariant topology or Morse theory) to prove inequalities like (60) or (61). Such topological approach to problems like  $g$ -conjecture or Generalized Lower Bound has the advantage of being independent on whether the simplicial sphere  $K$  is polytopal or not. Indeed, all known proofs of the necessity of  $g$ -theorem for simplicial polytopes (including the original one by Stanley given in section 2.1, McMullen’s proof [59], and the recent proof by Timorin [85]) follow the same scheme. Namely, the numbers  $h_i$ ,  $i = 1, \dots, n$ , are interpreted as the dimensions of graded components  $A^i$  of a certain graded algebra  $A$  satisfying the Hard Lefschetz Theorem. The latter means that there is an element  $\omega \in A^1$  such that the multiplication by  $\omega$  defines a *monomorphism*  $A^i \rightarrow A^{i+1}$  for  $i < \lfloor \frac{n}{2} \rfloor$ . This implies  $h_i \leq h_{i+1}$  for  $i < \lfloor \frac{n}{2} \rfloor$  (see section 2.1). However, such an element  $\omega$  is lacking for non-polytopal  $K$ , which means that a new technique has to be developed for proving the  $g$ -conjecture for simplicial spheres.

As it was mentioned in section 1.3, simplicial spheres are Gorenstein\* complexes. Using theorems 1.4.12, 1.4.13 and our Theorem 4.2.1 we obtain the following solution of the analogue of Problem 3.2.3.

**Theorem 4.3.7.** *The complex  $\mathcal{Z}_K$  is a Poincaré duality complex (over  $\mathbf{k}$ ) if and only if for any simplex  $I \in K$  (including  $I = \emptyset$ ) the subcomplex  $\text{link } I$  has the homology of a sphere of dimension  $\dim(\text{link } I)$ .*

**4.4. Partial quotients of manifold  $\mathcal{Z}_P$ .** Here we return to the case of polytopal  $K$  (i.e.  $K = K_P$ ) and study quotients of  $\mathcal{Z}_P$  by freely acting subgroups  $H \subset T^m$ .

For any combinatorial simple polytope  $P^n$  denote by  $s(P^n)$  the maximal dimension of subgroups  $H \subset T^m$  that act freely on  $\mathcal{Z}_P$ . The number  $s(P^n)$  is obviously a combinatorial invariant of  $P^n$ .

**Problem 4.4.1** (V. M. Buchstaber). *Express  $s(P^n)$  via known combinatorial invariants of  $P^n$ .*

**Proposition 4.4.2.** *If  $P^n$  has  $m$  facets, then  $s(P^n) \leq m - n$ .*

*Proof.* Every subgroup of  $T^m$  of dimension  $> m - n$  intersects non-trivially with any  $n$ -dimensional isotropy subgroup, and therefore can not act freely on  $\mathcal{Z}_P$ .  $\square$

**Proposition 4.4.3.** *The diagonal circle subgroup  $S_d := \{(e^{2\pi i\varphi}, \dots, e^{2\pi i\varphi}) \in T^m\}$ ,  $\varphi \in \mathbb{R}$ , acts freely on any  $\mathcal{Z}_P$ . Thus,  $s(P^n) \geq 1$ .*

*Proof.* Since any isotropy subgroup for  $\mathcal{Z}_P$  is coordinate (see Definition 3.1.1), it intersects with  $S_d$  only at the unit.  $\square$

Another lower bound for the number  $s(P^n)$  was proposed in [48]. Let  $\mathcal{F} = \{F_1, \dots, F_m\}$  be the set of facets of  $P^n$ . The surjective map  $\varrho : \mathcal{F} \rightarrow [k]$  (where  $[k] = \{1, \dots, k\}$ ) is called the *regular  $k$ -paint colouring of facets of  $P^n$*  if  $\varrho(F_i) \neq \varrho(F_j)$  whenever  $F_i \cap F_j \neq \emptyset$ . The *chromatic number*  $\gamma(P^n)$  of a polytope  $P^n$  is the minimal  $k$  for which there exists a regular  $k$ -paint colouring of facets of  $P^n$ .

**Example 4.4.4.** Suppose  $P^n$  is a 2-neighbourly simple polytope with  $m$  facets. Then  $\gamma(P^n) = m$ .

**Proposition 4.4.5** ([48]). *The following inequality holds:*

$$s(P^n) \geq m - \gamma(P^n).$$

*Proof.* The map  $\varrho : \mathcal{F} \rightarrow [k]$  defines the epimorphism of tori  $\tilde{\varrho} : T^m \rightarrow T^k$ . It is easy to see that if  $\varrho$  is a regular colouring, then  $\text{Ker } \tilde{\varrho} \cong T^{m-k}$  acts freely on  $\mathcal{Z}_P$ .  $\square$

Let  $H \subset T^m$  be a subgroup of dimension  $r \leq m - n$ . Choosing a basis in  $H$ , we can write it in the form

$$(62) \quad H = \{(e^{2\pi i(s_{11}\varphi_1 + \dots + s_{1r}\varphi_r)}, \dots, e^{2\pi i(s_{m1}\varphi_1 + \dots + s_{mr}\varphi_r)}) \in T^m\},$$

where  $\varphi_i \in \mathbb{R}$ ,  $i = 1, \dots, r$ . The  $m \times r$  integer matrix  $S = (s_{ij})$  defines a monomorphism  $\mathbb{Z}^r \rightarrow \mathbb{Z}^m$  whose image is a direct summand in  $\mathbb{Z}^m$ . For any subset  $\{i_1, \dots, i_n\} \subset [m]$  denote by  $S_{i_1, \dots, i_n}$  the  $(m-n) \times r$  submatrix of  $S$  obtained by deleting the rows  $i_1, \dots, i_n$ . Recall that any vertex  $v \in P^n$  is the intersection of  $n$  facets (see (30)). The following criterion of freeness for the action of  $H$  on  $\mathcal{Z}_P$  holds.

**Lemma 4.4.6.** *The subgroup (62) acts freely on  $\mathcal{Z}_P$  if and only if for any vertex  $v = F_{i_1} \cap \dots \cap F_{i_n}$  of  $P^n$  the  $(m-n) \times r$ -submatrix  $S_{i_1, \dots, i_n}$  defines the monomorphism  $\mathbb{Z}^r \hookrightarrow \mathbb{Z}^{m-n}$  to a direct summand.*

*Proof.* It follows from Definition 3.1.1 that the orbits of the  $T^m$ -action on  $\mathcal{Z}_P$  corresponding to the vertices of  $P^n$  have maximal (rank  $n$ ) isotropy subgroups. The isotropy subgroup corresponding to the vertex  $v = F_{i_1} \cap \dots \cap F_{i_n}$  is the coordinate subtorus  $T_{i_1, \dots, i_n}^n \subset T^m$ . The subgroup (62) acts freely on  $\mathcal{Z}_P$  if and only if it intersects each isotropy subgroup only at the unit. This is equivalent to the condition that the map  $H \times T_{i_1, \dots, i_n}^n \rightarrow T^m$  is injective for any  $v = F_{i_1} \cap \dots \cap F_{i_n}$ . The latter map is injective whenever the image of the corresponding map  $\mathbb{Z}^{r+n} \hookrightarrow \mathbb{Z}^m$  is a direct summand of  $\mathbb{Z}^m$ . The matrix of the map  $\mathbb{Z}^{r+n} \hookrightarrow \mathbb{Z}^m$  is obtained by adding  $n$  columns  $(0, \dots, 0, 1, 0, \dots, 0)^t$  (1 stands at the place  $i_j$ ,  $j = 1, \dots, n$ ) to  $S$ . This

matrix defines a direct summand of  $\mathbb{Z}^m$  exactly when the same is true for each  $S_{\hat{i}_1, \dots, \hat{i}_n}$ .  $\square$

In particular, for subgroups of rank  $m - n$  we get

**Corollary 4.4.7.** *The subgroup (62) of rank  $r = m - n$  acts freely on  $\mathcal{Z}_P$  if and only if for any vertex  $v = F_{i_1} \cap \dots \cap F_{i_n}$  of  $P^n$  the minor  $S_{\hat{i}_1, \dots, \hat{i}_n}$  satisfies  $\det S_{\hat{i}_1 \dots \hat{i}_n} = \pm 1$ .*

**Proposition 4.4.8.** *A simple polytope  $P^n$  admits a characteristic map if and only if  $s(P^n) = m - n$ .*

*Proof.* Proposition 3.1.5 shows that if  $P^n$  admits a characteristic map  $\ell$ , then the  $(m - n)$ -dimensional subgroup  $H(\ell)$  acts freely on  $\mathcal{Z}_P$ , whence  $s(P^n) = m - n$ . Now suppose  $s(P^n) = m - n$ , i.e. there exists a subgroup (62) of rank  $r = m - n$  that acts freely on  $\mathcal{Z}_P$ . The corresponding  $m \times (m - n)$ -matrix  $S$  defines a monomorphism  $\mathbb{Z}^{m-n} \rightarrow \mathbb{Z}^m$  whose image is a direct summand. It follows that there is an  $n \times m$ -matrix  $\Lambda$  such that the sequence

$$0 \longrightarrow \mathbb{Z}^{m-n} \xrightarrow{S} \mathbb{Z}^m \xrightarrow{\Lambda} \mathbb{Z}^n \longrightarrow 0$$

is exact. Since  $S$  satisfies the condition of Corollary 4.4.7, the matrix  $\Lambda$  satisfies the condition (26), thus defining a characteristic map for  $P^n$ .  $\square$

For any subgroup (62) of dimension  $r = m - n$  define the following linear forms in  $\mathbf{k}[v_1, \dots, v_m]$ :

$$(63) \quad w_i = s_{1i}v_1 + \dots + s_{mi}v_m, \quad i = 1, \dots, m - n.$$

Suppose  $M^{2n}$  is a quasitoric manifold over  $P^n$  with characteristic map  $\ell$ . Write the subgroup  $H(\ell)$  in the form (62); this defines elements (63). Under these assumptions the following statement holds.

**Lemma 4.4.9.** *The following isomorphism of algebras holds:*

$$H^*(\mathcal{Z}_P) \cong \mathrm{Tor}_{\mathbf{k}[w_1, \dots, w_{m-n}]}(H^*(M^{2n}), \mathbf{k}),$$

where the  $\mathbf{k}[w_1, \dots, w_{m-n}]$ -module structure on  $H^*(M^{2n}) = \mathbf{k}[v_1, \dots, v_m]/\mathcal{I}_P + \mathcal{J}_\ell$  is defined by (63).

*Proof.* Theorem 4.2.11 shows that

$$H^*(\mathcal{Z}_K) \cong \mathrm{Tor}_{\mathbf{k}[v_1, \dots, v_m]/\mathcal{J}_\ell}(\mathbf{k}(K)/\mathcal{J}_\ell, \mathbf{k}).$$

The quotient  $\mathbf{k}[v_1, \dots, v_m]/\mathcal{J}_\ell$  is identified with  $\mathbf{k}[w_1, \dots, w_{m-n}]$ .  $\square$

**Theorem 4.4.10.** *The Leray–Serre spectral sequence of the  $T^{m-n}$ -bundle  $\mathcal{Z}_P \rightarrow M^{2n}$  collapses at the  $E_3$  term. Furthermore, the following isomorphism of algebras holds:*

$$\begin{aligned} H^*(\mathcal{Z}_P) &\cong H[\Lambda[u_1, \dots, u_{m-n}] \otimes (\mathbf{k}(P)/\mathcal{J}_\ell), d], \\ \mathrm{bideg} v_i &= (0, 2), \quad \mathrm{bideg} u_i = (-1, 2); \\ d(u_i) &= w_i, \quad d(v_i) = 0. \end{aligned}$$

*Proof.* Since  $H^*(T^{m-n}) = \Lambda[u_1, \dots, u_{m-n}]$  and  $H^*(M^{2n}) = \mathbf{k}(P)/\mathcal{J}_\ell$ , we have

$$E_3 \cong H[(\mathbf{k}(P)/\mathcal{J}_\ell) \otimes \Lambda[u_1, \dots, u_{m-n}], d].$$

By Lemma 1.4.6,

$$H[(\mathbf{k}(P)/\mathcal{J}_\ell) \otimes \Lambda[u_1, \dots, u_{m-n}], d] \cong \mathrm{Tor}_{\mathbf{k}[w_1, \dots, w_{m-n}]}(H^*(M^{2n}), \mathbf{k}).$$

Combining the above two identities with Lemma 4.4.9 we get  $E_3 = H^*(\mathcal{Z}_P)$ , which concludes the proof.  $\square$

Now we are going to describe the cohomology of the quotient  $\mathcal{Z}_P/H$  for arbitrary freely acting subgroup  $H$ . First, we write  $H$  in the form (62) and choose an  $(m-r) \times m$ -matrix  $T = (t_{ij})$  of rank  $(m-r)$  satisfying  $T \cdot S = 0$ . This is done in the same way as in the proof of Proposition 4.4.8 (in particular,  $T$  is the characteristic matrix for the quasitoric manifold  $\mathcal{Z}_P/H$  in the case  $r = m - n$ ).

**Theorem 4.4.11.** *The following isomorphism of algebras holds:*

$$H^*(\mathcal{Z}_P/H) \cong \mathrm{Tor}_{\mathbf{k}[t_1, \dots, t_{m-r}]}(\mathbf{k}(P), \mathbf{k}),$$

where the  $\mathbf{k}[t_1, \dots, t_{m-r}]$ -module structure on  $\mathbf{k}(P) = \mathbf{k}[v_1, \dots, v_m]/\mathcal{I}_P$  is given by the map

$$\begin{aligned} k[t_1, \dots, t_{m-r}] &\rightarrow k[v_1, \dots, v_m] \\ t_i &\rightarrow t_{i1}v_1 + \dots + t_{im}v_m. \end{aligned}$$

*Remark.* Theorem 4.4.11 reduces to Theorem 4.2.1 in the case  $r = 0$  and to Example 4.1.5 in the case  $r = m - n$ .

*Proof of Theorem 4.4.11.* The inclusion of the subgroup  $T^r \cong H \hookrightarrow T^m$  defines the map of classifying spaces  $h : BT^r \rightarrow BT^m$ . Let us consider the commutative square

$$\begin{array}{ccc} E & \longrightarrow & B_T P \\ \downarrow & & \downarrow p \\ BT^r & \xrightarrow{h} & BT^m, \end{array}$$

where the left vertical arrow is the pullback along  $h$ . It can be easily seen that  $E$  is homotopy equivalent to the quotient  $\mathcal{Z}_P/H$ . The Eilenberg–Moore spectral sequence of the above square converges to the cohomology of  $\mathcal{Z}_P/H$  and has

$$E_2 = \mathrm{Tor}_{\mathbf{k}[v_1, \dots, v_m]}(\mathbf{k}(P), \mathbf{k}[w_1, \dots, w_r]),$$

where the  $k[v_1, \dots, v_m]$ -module structure on  $k[w_1, \dots, w_r]$  is defined by the matrix  $S$ , i.e. by the map  $v_i \rightarrow s_{i1}w_1 + \dots + s_{ir}w_r$ . It can be shown in the same way as in the proof of Theorem 4.2.1 (using cellular decompositions) that the spectral sequence collapses at the  $E_2$  term and the following isomorphism of algebras holds:

$$(64) \quad H^*(\mathcal{Z}_P/H) = \mathrm{Tor}_{\mathbf{k}[v_1, \dots, v_m]}(\mathbf{k}(P), \mathbf{k}[w_1, \dots, w_r]).$$

Now put  $\Lambda = \mathbf{k}[v_1, \dots, v_m]$ ,  $\Gamma = \mathbf{k}[t_1, \dots, t_{m-r}]$ ,  $A = \mathbf{k}[w_1, \dots, w_r]$ , and  $C = \mathbf{k}(P)$  in Theorem 1.4.10. Since  $\Lambda$  here is a free  $\Gamma$ -module and  $\Omega = \Lambda/\Gamma \cong \mathbf{k}[w_1, \dots, w_r]$ , the spectral sequence  $\{\tilde{E}_s, \tilde{d}_s\}$  arises. Its  $E_2$  term is

$$\tilde{E}_2 = \mathrm{Tor}_{\mathbf{k}[w_1, \dots, w_r]}(\mathbf{k}[w_1, \dots, w_r], \mathrm{Tor}_{\mathbf{k}[t_1, \dots, t_{m-r}]}(\mathbf{k}(P), \mathbf{k})),$$

and it converges to  $\mathrm{Tor}_{\mathbf{k}[v_1, \dots, v_m]}(\mathbf{k}(P), \mathbf{k}[w_1, \dots, w_r])$ . Since  $\mathbf{k}[w_1, \dots, w_r]$  is a free  $\mathbf{k}[w_1, \dots, w_r]$ -module, we have

$$\tilde{E}_2^{p,q} = 0 \text{ for } p \neq 0, \quad \tilde{E}_2^{0,*} = \mathrm{Tor}_{\mathbf{k}[t_1, \dots, t_{m-r}]}(\mathbf{k}(P), \mathbf{k}).$$



Thus, the spectral sequence collapses at the  $E_2$  term, and the following isomorphism of algebras holds:

$$\mathrm{Tor}_{\mathbf{k}[v_1, \dots, v_m]}(\mathbf{k}(P), \mathbf{k}[w_1, \dots, w_r]) \cong \mathrm{Tor}_{\mathbf{k}[t_1, \dots, t_{m-r}]}(\mathbf{k}(P), \mathbf{k}),$$

which together with (64) proves the theorem.  $\square$

**Corollary 4.4.12.**  $H^*(\mathcal{Z}_P/H) \cong H[\Lambda[u_1, \dots, u_{m-r}] \otimes \mathbf{k}, d]$ , where  $du_i = (t_{i1}v_1 + \dots + t_{im}v_m)$ ,  $dv_i = 0$ ,  $\mathrm{bideg} v_i = (0, 2)$ ,  $\mathrm{bideg} u_i = (-1, 2)$ .

**Example 4.4.13.** Let  $H = S_d$  (see Proposition 4.4.3). In this situation the matrix  $S$  is the column of  $m$  units. By Theorem 4.4.11,

$$(65) \quad H^*(\mathcal{Z}_P/S_d) \cong \mathrm{Tor}_{\mathbf{k}[t_1, \dots, t_{m-1}]}(\mathbf{k}(P), \mathbf{k}),$$

where the  $\mathbf{k}[t_1, \dots, t_{m-1}]$ -module structure on  $\mathbf{k}(P) = \mathbf{k}[v_1, \dots, v_m]/I$  is defined by

$$t_i \longrightarrow v_i - v_m, \quad i = 1, \dots, m-1.$$

Suppose that the  $S^1$ -bundle  $\mathcal{Z}_P \rightarrow \mathcal{Z}_P/S_d$  is classified by the map  $c : \mathcal{Z}_P/S_d \rightarrow BT^1 \cong \mathbb{C}P^\infty$ . Since  $H^*(\mathbb{C}P^\infty) = \mathbf{k}[w]$ , the element  $c^*(w) \in H^2(\mathcal{Z}_P/S_d)$  is defined.

**Lemma 4.4.14.**  $P^n$  is  $q$ -neighbourly if and only if  $(c^*(w))^q \neq 0$ .

*Proof.* The map  $c^*$  takes the cohomology ring  $H^*(BT^1) \cong \mathbf{k}[w]$  to the subring  $\mathbf{k}(P) \otimes_{\mathbf{k}[t_1, \dots, t_{m-1}]} \mathbf{k} = \mathrm{Tor}_{\mathbf{k}[t_1, \dots, t_{m-1}]}^0(\mathbf{k}(P), \mathbf{k})$  of  $H^*(\mathcal{Z}_P/H)$ . This subring is isomorphic to the quotient  $\mathbf{k}(P)/(v_1 = \dots = v_m)$ . Now the assertion follows from the fact that a polytope  $P^n$  is  $q$ -neighbourly if and only if the ideal  $\mathcal{I}_P$  does not contain monomials of degree  $< q + 1$ .  $\square$

**4.5. Bigraded Poincaré duality and analogues of Dehn–Sommerville equations for simplicial manifolds.** Here we assume that  $K^{n-1}$  is a simplicial manifold. In this case the moment-angle complex  $\mathcal{Z}_K$  is not a manifold, however, its singularities can be easily treated. Indeed, the cubical complex  $\mathrm{cc}(K)$  (Construction 1.5.9) is homeomorphic to  $|\mathrm{cone}(K)|$ , and the vertex of the cone is the point  $p = (1, \dots, 1) \in \mathrm{cc}(K) \subset I^m$ . Let  $U_\varepsilon(p) \subset \mathrm{cc}(K)$  be a small neighbourhood of  $p$  in  $\mathrm{cc}(K)$ . Then the closure of  $U_\varepsilon(p)$  is also homeomorphic to  $|\mathrm{cone}(K)|$ . It follows from the definition of  $\mathcal{Z}_K$  (see (39)) that  $U_\varepsilon(T^m) := \rho^{-1}(U_\varepsilon(p)) \subset \mathcal{Z}_K$  is a small invariant neighbourhood of the torus  $T^m = \rho^{-1}(p)$  in  $\mathcal{Z}_K$ . For small  $\varepsilon$  the closure of  $U_\varepsilon(T^m)$  is homeomorphic to  $|\mathrm{cone}(K)| \times T^m$ . Removing  $U_\varepsilon(T^m)$  from  $\mathcal{Z}_K$  we obtain a manifold with boundary, which we denote  $W_K$ . Thus, we have

$$W_K = \mathcal{Z}_K \setminus U_\varepsilon(T^m), \quad \partial W_K = |K| \times T^m.$$

Note that since the neighbourhood  $U_\varepsilon(T^m)$  is  $T^m$ -stable, the torus  $T^m$  acts on  $W_K$ .

**Theorem 4.5.1.** *The manifold with boundary  $W_K$  is equivariantly homotopy equivalent to the moment-angle complex  $\mathcal{W}_K$  (see (39)). There is a canonical relative homeomorphism of pairs  $(W_K, \partial W_K) \rightarrow (\mathcal{Z}_K, T^m)$ .*

*Proof.* To prove the first assertion we construct homotopy equivalence  $\mathrm{cc}(K) \setminus U_\varepsilon(p) \rightarrow \mathrm{cub}(K)$  as it is shown on Figure 9. This map is covered by an equivariant homotopy equivalence  $W_K = \mathcal{Z}_K \setminus U_\varepsilon(T^m) \rightarrow \mathcal{W}_K$ . The second assertion follows easily from the definition of  $W_K$ .  $\square$

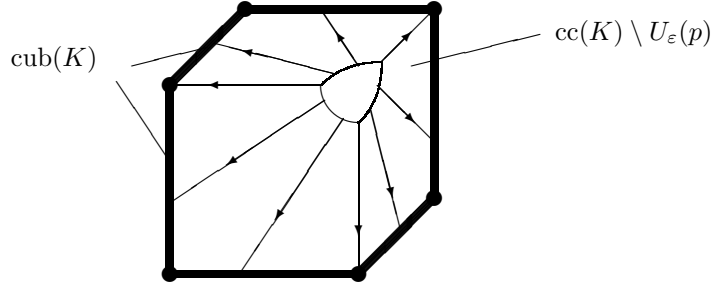

FIGURE 9. Homotopy equivalence  $cc(K) \setminus U_\varepsilon(p) \rightarrow cub(K)$ .

According to Lemma 3.3.1, the moment-angle complex  $\mathcal{W}_K \subset (D^2)^m$  has a cellular structure with 5 different cell types  $D_i, I_i, 0_i, T_i, 1_i, i = 1, \dots, m$  (see Figure 7). The homology of  $\mathcal{W}_K$  (and therefore of  $W_K$ ) can be calculated by means of the corresponding cellular chain complex, which we denote  $[\mathcal{C}_*(\mathcal{W}_K), \partial_c]$ . Though  $\mathcal{W}_K$  has more types of cells than  $\mathcal{Z}_K$  (recall that  $\mathcal{Z}_K$  has only 3 cell types  $D_i, T_i, 1_i$ ), the cellular chain complex  $[\mathcal{C}_*(\mathcal{W}_K), \partial_c]$  can be canonically made *bigraded* as well. Namely, the following statement holds (compare with (46)).

**Lemma 4.5.2.** *Put*

$$(66) \quad \begin{aligned} \text{bideg } D_i &= (0, 2), & \text{bideg } T_i &= (-1, 2), & \text{bideg } I_i &= (1, 0), \\ \text{bideg } 0_i &= \text{bideg } 1_i &= (0, 0), & i &= 1, \dots, m. \end{aligned}$$

*This makes the cellular chain complex  $[\mathcal{C}_*(\mathcal{W}_K), \partial_c]$  a bigraded differential module with differential  $\partial_c$  adding  $(-1, 0)$  to bidegree. The original grading of  $\mathcal{C}_*(\mathcal{W}_K)$  by dimensions of cells corresponds to the total degree (i.e. the dimension of a cell equals the sum of its two degrees).*

*Proof.* We need only to check that the differential  $\partial_c$  adds  $(-1, 0)$  to bidegree. This follows from (66) and the following formulae:

$$\partial_c D_i = T_i, \quad \partial_c I_i = 1_i - 0_i, \quad \partial_c T_i = \partial_c 1_i = \partial_c 0_i = 0.$$

□

Note that unlike bigraded structure in  $\mathcal{C}_*(\mathcal{Z}_K)$  elements of  $\mathcal{C}_{*,*}(\mathcal{W}_K)$  may have *positive* first degree (due to the positive first degree of  $I_i$ ). Nevertheless, the differential  $\partial_c$  does not change the second degree (as in the case of  $\mathcal{Z}_K$ ), which allows to split the bigraded complex  $\mathcal{C}_{*,*}(\mathcal{W}_K)$  into the sum of complexes  $\mathcal{C}_{*,2p}(\mathcal{W}_K)$ ,  $p = 0, \dots, m$ .

In the same way as we did for  $\mathcal{Z}_K$  and for the pair  $(\mathcal{Z}_K, T^m)$  we define

$$(67) \quad b_{q,2p}(\mathcal{W}_K) = \dim H_{q,2p}[\mathcal{C}_{*,*}(\mathcal{W}_K), \partial_c], \quad -m \leq q \leq m, \quad 0 \leq p \leq m;$$

$$(68) \quad \chi_p(\mathcal{W}_K) = \sum_{q=-m}^m (-1)^q \dim \mathcal{C}_{q,2p}(\mathcal{W}_K) = \sum_{q=-m}^m (-1)^q b_{q,2p}(\mathcal{W}_K);$$

$$\chi(\mathcal{W}_K; t) = \sum_{p=0}^m \chi_p(\mathcal{W}_K) t^{2p}$$

(note that  $q$  above may be both positive and negative).

The following theorem provides the exact formula for the generating polynomial  $\chi(\mathcal{W}_K; t)$  and is analogous to theorems 4.2.8 and 4.2.10.

**Theorem 4.5.3.** *For any simplicial complex  $K^{n-1}$  with  $m$  vertices holds*

$$\begin{aligned}\chi(\mathcal{W}_K; t) &= (1-t^2)^{m-n}(h_0 + h_1 t^2 + \cdots + h_n t^{2n}) + (\chi(K) - 1)(1-t^2)^m \\ &= (1-t^2)^{m-n}(h_0 + h_1 t^2 + \cdots + h_n t^{2n}) + (-1)^{n-1} h_n (1-t^2)^m,\end{aligned}$$

where  $\chi(K) = f_0 - f_1 + \cdots + (-1)^{n-1} f_{n-1} = 1 + (-1)^{n-1} h_n$  is the Euler characteristic of  $K$ .

*Proof.* The definition of  $\mathcal{W}_K$  (see (39)) shows that  $D_I I_J 0_L T_P 1_Q$  (see section 3.3) is a cell of  $\mathcal{W}_K$  if and only if the following two conditions are satisfied:

- (a) The set  $I \cup J \cup L$  is a simplex of  $K^{n-1}$ .
- (b)  $\#L \geq 1$ .

Let  $c_{ijlpq}(\mathcal{W}_K)$  denote the number of cells  $D_I I_J 0_L T_P 1_Q \subset \mathcal{W}_K$  with  $i = \#I$ ,  $j = \#J$ ,  $l = \#L$ ,  $p = \#P$ ,  $q = \#Q$ ,  $i + j + l + p + q = m$ . It follows that

$$(69) \quad c_{ijlpq}(\mathcal{W}_K) = f_{i+j+l-1} \binom{i+j+l}{i} \binom{j+l}{l} \binom{m-i-j-l}{p},$$

where  $(f_0, \dots, f_{n-1})$  is the  $f$ -vector of  $K$  (we also assume  $f_{-1} = 1$  and  $f_k = 0$  for  $k < -1$  or  $k > n-1$ ). By (66),

$$\text{bideg}(D_I I_J 0_L T_P 1_Q) = (j-p, 2(i+p)).$$

Now we calculate  $\chi_r(\mathcal{W}_K)$  using (68) and (69):

$$\chi_r(\mathcal{W}_K) = \sum_{\substack{i,j,l,p \\ i+p=r, l \geq 1}} (-1)^{j-p} f_{i+j+l-1} \binom{i+j+l}{i} \binom{j+l}{l} \binom{m-i-j-l}{p}.$$

Substituting  $s = i + j + l$  above we obtain

$$\begin{aligned}\chi_r(\mathcal{W}_K) &= \sum_{\substack{l,s,p \\ l \geq 1}} (-1)^{s-r-l} f_{s-1} \binom{s}{r-p} \binom{s-r+p}{l} \binom{m-s}{p} \\ &= \sum_{s,p} \left( (-1)^{s-r} f_{s-1} \binom{s}{r-p} \binom{m-s}{p} \sum_{l \geq 1} (-1)^l \binom{s-r+p}{l} \right)\end{aligned}$$

Since

$$\sum_{l \geq 1} (-1)^l \binom{s-r+p}{l} = \begin{cases} -1, & s > r-p, \\ 0, & s \leq r-p, \end{cases}$$

we get

$$\begin{aligned}\chi_r(\mathcal{W}_K) &= - \sum_{\substack{s,p \\ s > r-p}} (-1)^{s-r} f_{s-1} \binom{s}{r-p} \binom{m-s}{p} \\ &= - \sum_{s,p} (-1)^{r-s} f_{s-1} \binom{s}{r-p} \binom{m-s}{p} + \sum_s (-1)^{r-s} f_{s-1} \binom{m-s}{r-s}.\end{aligned}$$

The second sum in the above formula is exactly  $\chi_r(\mathcal{Z}_K)$  (see (53)). To calculate the first sum we observe that  $\sum_p \binom{s}{r-p} \binom{m-s}{p} = \binom{m}{r}$  (this follows from calculating the coefficient of  $\alpha^r$  in both sides of the identity  $(1+\alpha)^s (1+\alpha)^{m-s} = (1+\alpha)^m$ ). Hence,

$$\chi_r(\mathcal{W}_K) = - \sum_s (-1)^{r-s} f_{s-1} \binom{m}{r} + \chi_r(\mathcal{Z}_K) = (-1)^r \binom{m}{r} (\chi(K) - 1) + \chi_r(\mathcal{Z}_K),$$

since  $-\sum_s (-1)^s f_{s-1} = \chi(K) - 1$  (remember that  $f_{-1} = 1$ ). Finally, using (52) we calculate

$$\begin{aligned}\chi(\mathcal{W}_K; t) &= \sum_{r=0}^m \chi_r(\mathcal{W}_K) t^{2r} = \sum_{r=0}^m (-1)^r \binom{m}{r} (\chi(K) - 1) t^{2r} + \sum_{r=0}^m \chi_r(\mathcal{Z}_K) t^{2r} \\ &= (\chi(K) - 1)(1 - t^2)^m + (1 - t^2)^{m-n} (h_0 + h_1 t^2 + \cdots + h_n t^{2n}).\end{aligned}$$

□

Suppose now that  $K$  is an orientable simplicial manifold. It is easy to see that in this case  $W_K$  is also orientable. Hence, there are relative Poincaré duality isomorphisms:

$$(70) \quad H_k(W_K) \cong H^{m+n-k}(W_K, \partial W_K), \quad k = 0, \dots, m.$$

**Corollary 4.5.4** (Generalised Dehn–Sommerville equations). *The following relations hold for the  $h$ -vector  $(h_0, h_1, \dots, h_n)$  of any orientable simplicial manifold  $K^{n-1}$ :*

$$h_{n-i} - h_i = (-1)^i (\chi(K^{n-1}) - \chi(S^{n-1})) \binom{n}{i}, \quad i = 0, 1, \dots, n,$$

where  $\chi(S^{n-1}) = 1 + (-1)^{n-1}$  is the Euler characteristic of an  $(n-1)$ -sphere.

*Proof.* By Theorem 4.5.1,  $H_k(W_K) = H_k(\mathcal{W}_K)$  and  $H^{m+n-k}(W_K, \partial W_K) = H^{m+n-k}(\mathcal{Z}_K, T^m)$ . Moreover, it can be seen in the same way as in Corollary 4.3.2 that relative Poincaré duality isomorphisms (70) regard the bigraded structures in the (co)homology of  $\mathcal{W}_K$  and  $(\mathcal{Z}_K, T^m)$ . It follows that

$$\begin{aligned}b_{-q, 2p}(\mathcal{W}_K) &= b_{-(m-n)+q, 2(m-p)}(\mathcal{Z}_K, T^m), \\ \chi_p(\mathcal{W}_K) &= (-1)^{m-n} \chi_{m-p}(\mathcal{Z}_K, T^m), \\ (71) \quad \chi(\mathcal{W}_K; t) &= (-1)^{m-n} t^{2m} \chi(\mathcal{Z}_K, T^m; \frac{1}{t}).\end{aligned}$$

Using (58) we calculate

$$\begin{aligned}(-1)^{m-n} t^{2m} \chi(\mathcal{Z}_K, T^m; \frac{1}{t}) &= (-1)^{m-n} t^{2m} (1 - t^{-2})^{m-n} (h_0 + h_1 t^{-2} + \cdots + h_n t^{-2n}) \\ &\quad - (-1)^{m-n} t^{2m} (1 - t^{-2})^m \\ &= (1 - t^2)^{m-n} (h_0 t^{2n} + h_1 t^{2n-2} + \cdots + h_n) + (-1)^{n-1} (1 - t^2)^m.\end{aligned}$$

Substituting the formula for  $\chi(\mathcal{W}_K; t)$  from Theorem 4.5.3 and the above expression into (71) we obtain

$$\begin{aligned}(1 - t^2)^{m-n} (h_0 + h_1 t^2 + \cdots + h_n t^{2n}) + (\chi(K) - 1)(1 - t^2)^m \\ = (1 - t^2)^{m-n} (h_0 t^{2n} + h_1 t^{2n-2} + \cdots + h_n) + (-1)^{n-1} (1 - t^2)^m.\end{aligned}$$

Calculating the coefficient of  $t^{2i}$  in both sides after dividing the above identity by  $(1 - t^2)^{m-n}$ , we obtain  $h_{n-i} - h_i = (-1)^i (\chi(K^{n-1}) - \chi(S^{n-1})) \binom{n}{i}$ , as needed. □

If  $|K| = S^{n-1}$  or  $n-1$  is odd, Corollary 4.5.4 gives the classical equations  $h_{n-i} = h_i$ .

**Corollary 4.5.5.** *If  $K^{n-1}$  is a simplicial manifold with  $h$ -vector  $(h_0, \dots, h_n)$  then*

$$h_{n-i} - h_i = (-1)^i (h_n - 1) \binom{n}{i}, \quad i = 0, 1, \dots, n.$$

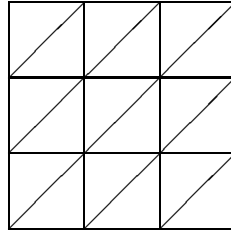

FIGURE 10. Triangulation of  $T^2$  with  $\mathbf{f} = (9, 27, 18)$ ,  $\mathbf{h} = (1, 6, 12, -1)$ .

*Proof.* Since  $\chi(K^{n-1}) = 1 + (-1)^{n-1}h_n$ ,  $\chi(S^{n-1}) = 1 + (-1)^{n-1}$ , we have

$$\chi(K^{n-1}) - \chi(S^{n-1}) = (-1)^{n-1}(h_n - 1) = (h_n - 1)$$

(the coefficient  $(-1)^{n-1}$  can be dropped since for odd  $n - 1$  the left hand side is zero).  $\square$

**Corollary 4.5.6.** *For any  $(n - 1)$ -dimensional orientable simplicial manifold the numbers  $h_{n-i} - h_i$ ,  $i = 0, 1, \dots, n$ , are homotopy invariants. In particular, they do not depend on a triangulation.*

In the particular case of  $PL$ -manifolds the topological invariance of numbers  $h_{n-i} - h_i$  was firstly observed by Pachner in [67, (7.11)].

**Example 4.5.7.** Consider triangulations of the 2-torus  $T^2$ . We have  $n = 3$ ,  $\chi(T^2) = 0$ . From  $\chi(K^{n-1}) = 1 + (-1)^{n-1}h_n$  we deduce  $h_3 = -1$ . Corollary 4.5.4 gives

$$h_3 - h_0 = -2, \quad h_2 - h_1 = 6.$$

For instance, the triangulation on Figure 10 has  $f_0 = 9$  vertices,  $f_1 = 27$  edges and  $f_2 = 18$  triangles. The corresponding  $h$ -vector is  $(1, 6, 12, -1)$ .

## 5. SUBSPACE ARRANGEMENTS AND COHOMOLOGY RINGS OF THEIR COMPLEMENTS

**5.1. Summary of results on the cohomology of general arrangement complements.** An *arrangement* is a finite set  $\mathcal{A} = \{L_1, \dots, L_r\}$  of planes (affine subspaces) in some affine space (either real or complex). For any arrangement  $\mathcal{A} = \{L_1, \dots, L_r\}$  in  $\mathbb{C}^m$  define its *support*  $|\mathcal{A}|$  as

$$|\mathcal{A}| := \bigcup_{i=1}^r L_i \subset \mathbb{C}^m,$$

and its *complement*  $U(\mathcal{A})$  as

$$U(\mathcal{A}) := \mathbb{C}^m \setminus |\mathcal{A}|,$$

and similarly for arrangements in  $\mathbb{R}^m$ .

Arrangements and their complements play a pivotal rôle in many constructions of combinatorics, algebraic and symplectic geometry etc.; they also arise as configuration spaces for different classical mechanical systems. In the study of arrangements it is very important to get a sufficiently detailed description of the topology of complements  $U(\mathcal{A})$  (this includes number of connected components, homotopy

type, homology groups, cohomology ring etc.). A host of elegant results in this direction appeared during the last three decades, however, the whole picture is far from being complete. The theory ascends to work of Arnold [4], which described the classifying space for the braid group  $B_n$  as the complement of arrangement of all diagonal hyperplanes  $\{z_i = z_j\}$  in  $\mathbb{C}^n$ . The cohomology ring of this complement was also calculated there. This result was generalised by Brieskorn [18] and motivated the further development of the theory of *complex hyperplane arrangements* (i.e. arrangements of codimension-one complex affine subspaces). One of the main results here is the following.

**Theorem 5.1.1** ([4], [18], [64]). *Let  $\mathcal{A} = \{L_1, \dots, L_r\}$  be an arrangement of complex hyperplanes in  $\mathbb{C}^m$ , and the hyperplane  $L_i$  is the zero set of linear function  $l_i$ ,  $i = 1, \dots, r$ . Then the integer cohomology algebra of the complement  $\mathbb{C}^m \setminus |\mathcal{A}|$  is isomorphic to the algebra generated by closed differential 1-forms  $\frac{1}{2\pi i} \frac{dl_i}{l_i}$ .*

Relations between the forms  $\frac{1}{2\pi i} \frac{dl_i}{l_i}$  are also explicitly described. In the case of diagonal hyperplanes  $\{z_i = z_j\}$  we have the forms  $\omega_{ij} = \frac{1}{2\pi i} \frac{d(z_i - z_j)}{z_i - z_j}$ , which are subject to the following relations:

$$\omega_{ij} \wedge \omega_{jk} + \omega_{jk} \wedge \omega_{ki} + \omega_{ki} \wedge \omega_{ij} = 0.$$

The theory of complex hyperplane arrangements is probably the most well understood part of the whole study. Several surveys and monographs are available; we mention just [65], where further references can be found. Relationships of *real* hyperplane arrangements with polytopes and *oriented matroids* are discussed in [89, Lecture 7].

In the general situation, the Goresky–MacPherson theorem [42, Part III] expresses the cohomology groups  $H^i(U(\mathcal{A}))$  (without ring structure) as a sum of homology groups of subcomplexes of a certain simplicial complex. We formulate this result below. For a detailed survey of general arrangements we refer to [14]. Some important results in this direction can be found in monograph [87].

Let  $\mathcal{A} = \{L_1, \dots, L_r\}$  be an arrangement of planes in  $\mathbb{R}^n$ . The intersections

$$v = L_{i_1} \cap \dots \cap L_{i_k}$$

form a poset  $(\mathcal{P}, <)$  with respect to the inclusion (i.e.  $v < w$  if and only if  $v$  and  $w$  are different and  $v$  is contained in  $w$ ). The poset  $\mathcal{P}$  is assumed to have a unique maximal element  $T$  corresponding to the ambient space of the arrangement. The *rank function*  $d$  on  $\mathcal{P}$  is defined by  $d(v) = \dim v$ . The order complex  $K(\mathcal{P})$  (see Example 1.2.7) is called the *order complex of arrangement  $\mathcal{A}$* . Define

$$\mathcal{P}_{(v,w)} = \{x \in \mathcal{P} : v < x < w\}, \quad \mathcal{P}_{>v} = \{x \in \mathcal{P} : x > v\}.$$

**Theorem 5.1.2** (Goresky and MacPherson [42, Part III]). *The following formula holds for the homology of the complement  $U(\mathcal{A})$ :*

$$H_i(U(\mathcal{A}); \mathbb{Z}) = \bigoplus_{v \in \mathcal{P}} H^{n-d(v)-i-1}(K(\mathcal{P}_{>v}), K(\mathcal{P}_{v,T}); \mathbb{Z}),$$

with the agreement that  $H^{-1}(\emptyset, \emptyset) = \mathbb{Z}$ .

The proof of this theorem uses the *stratified Morse theory* developed in [42].

*Remark.* The homology groups of a complex arrangement in  $\mathbb{C}^n$  can be calculated by regarding it as a real arrangement in  $\mathbb{R}^{2n}$ .

The cohomology *rings* of the complements of arrangements are much more subtle. In general, the integer cohomology ring of  $U(\mathcal{A})$  is *not* determined by the poset  $\mathcal{P}$ . An approach to calculating the cohomology algebra of the complement  $U(\mathcal{A})$  was proposed by De Concini and Procesi [34]. In particular, they proved that the *rational* cohomology ring of  $U(\mathcal{A})$  is determined by the combinatorics of intersections. This result was extended by Yuzvinsky in [88].

**5.2. Coordinate subspace arrangements and cohomology of  $Z_K$ .** An arrangement  $\mathcal{A} = \{L_1, \dots, L_r\}$  is called *coordinate* if every plane  $L_i, i = 1, \dots, r$ , is a coordinate subspace. In this section we apply the results of chapter 4 to cohomology algebras of the complements of complex coordinate subspace arrangements. The case of real coordinate arrangements is discussed at the end of the section.

Any coordinate subspace of  $\mathbb{C}^m$  has the form

$$(72) \quad L_I = \{(z_1, \dots, z_m) \in \mathbb{C}^m : z_{i_1} = \dots = z_{i_k} = 0\},$$

where  $I = \{i_1, \dots, i_k\}$  is a subset of  $[m]$ . Obviously,  $\dim L_I = m - \#I$ .

**Construction 5.2.1.** For each simplicial complex  $K$  on the set  $[m]$  define the complex coordinate subspace arrangement  $\mathcal{CA}(K)$  as the set of subspaces  $L_I$  such that  $I$  is not a simplex of  $K$ :

$$\mathcal{CA}(K) = \{L_I : I \notin K\}.$$

Denote the complement of  $\mathcal{CA}(K)$  by  $U(K)$ , that is

$$(73) \quad U(K) = \mathbb{C}^m \setminus \bigcup_{I \notin K} L_I.$$

If  $K' \subset K$  is a subcomplex, then  $U(K') \subset U(K)$ .

**Proposition 5.2.2.** *The assignment  $K \mapsto U(K)$  defines a one-to-one order-preserving correspondence between simplicial complexes on the set  $[m]$  and complements of coordinate subspace arrangements in  $\mathbb{C}^m$ .*

*Proof.* Suppose  $\mathcal{CA}$  is a coordinate subspace arrangement in  $\mathbb{C}^m$ . Define

$$(74) \quad K(\mathcal{CA}) := \{I \subset [m] : L_I \not\subset \mathcal{CA}\}.$$

Obviously,  $K(\mathcal{CA})$  is a simplicial complex. By the construction,  $K(\mathcal{CA})$  depends only on  $|\mathcal{CA}|$  (i.e. on  $U(\mathcal{CA})$ ) and  $U(K(\mathcal{CA})) = U(\mathcal{CA})$ , whence the proposition follows.  $\square$

If a coordinate subspace arrangement  $\mathcal{A}$  contains a hyperplane, say  $\{z_i = 0\}$ , then its complement  $U(\mathcal{A})$  is factorised as  $U(\mathcal{A}_0) \times \mathbb{C}^*$ , where  $\mathcal{A}_0$  is a coordinate subspace arrangement in the hyperplane  $\{z_i = 0\}$  and  $\mathbb{C}^* = \mathbb{C} \setminus \{0\}$ . Thus, for any coordinate subspace arrangement  $\mathcal{A}$  the complement  $U(\mathcal{A})$  decomposes as

$$U(\mathcal{A}) = U(\mathcal{A}') \times (\mathbb{C}^*)^k,$$

where  $\mathcal{A}'$  is a coordinate arrangement in  $\mathbb{C}^{m-k}$  that does not contain hyperplanes. On the other hand, (74) shows that  $\mathcal{CA}$  contains the hyperplane  $\{z_i = 0\}$  if and only if  $\{i\}$  is not a vertex of  $K(\mathcal{CA})$ . It follows that  $U(K)$  is the complement of a coordinate arrangement without hyperplanes if and only if the vertex set of  $K$  is the whole  $[m]$ . Keeping in mind these remarks, we restrict ourselves to coordinate subspace arrangements without hyperplanes and simplicial complexes on the vertex set  $[m]$ .

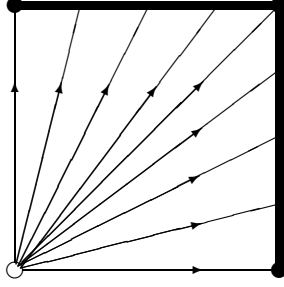

FIGURE 11. The retraction  $r : U(K) \cap \mathbb{R}_+^m \rightarrow \text{cc}(K)$  for  $K = \partial\Delta^{m-1}$ .

*Remark.* In terms of Construction 3.5.1 we have  $U(K) = K_\bullet(\mathbb{C}, \mathbb{C}^*)$ .

**Example 5.2.3.** 1. If  $K = \Delta^{m-1}$  (the  $(m-1)$ -simplex) then  $U(K) = \mathbb{C}^m$ .

2. If  $K = \partial\Delta^{m-1}$  (the boundary of simplex) then  $U(K) = \mathbb{C}^m \setminus \{0\}$ .

3. If  $K$  is a disjoint union of  $m$  vertices, then  $U(K)$  is obtained by removing all codimension-two coordinate subspaces  $z_i = z_j = 0$ ,  $i, j = 1, \dots, m$ , from  $\mathbb{C}^m$ .

The action of the algebraic torus  $(\mathbb{C}^*)^m$  on  $\mathbb{C}^m$  descends to  $U(K)$ . In particular, the standard action of the torus  $T^m$  is defined on  $U(K)$ . The quotient  $U(K)/T^m$  can be identified with  $U(K) \cap \mathbb{R}_+^m$ , where  $\mathbb{R}_+^m$  is regarded as a subset of  $\mathbb{C}^m$ .

**Lemma 5.2.4.**  $\text{cc}(K) \subset U(K) \cap \mathbb{R}_+^m$  and  $\mathcal{Z}_K \subset U(K)$  (see Construction 1.5.9 and (39)).

*Proof.* Take  $y = (y_1, \dots, y_m) \in \text{cc}(K)$ . Let  $I = \{i_1, \dots, i_k\}$  be the maximal subset of  $[m]$  such that  $y \in L_I \cap \mathbb{R}_+^m$  (i.e.  $y_{i_1} = \dots = y_{i_k} = 0$ ). Then it follows from the definition of  $\text{cc}(K)$  (see (22)) that  $I$  is a simplex of  $K$ . Hence,  $L_I \notin \mathcal{CA}(K)$  and  $y \in U(K)$ . Thus, the first statement is proved. Since  $\text{cc}(K)$  is the quotient of  $\mathcal{Z}_K$ , the second assertion follows from the first one.  $\square$

**Theorem 5.2.5.** *There is an equivariant deformation retraction  $U(K) \rightarrow \mathcal{Z}_K$ .*

*Proof.* First, we construct a deformation retraction  $r : U(K) \cap \mathbb{R}_+^m \rightarrow \text{cc}(K)$ . This is done inductively. We start from the boundary complex of an  $(m-1)$ -simplex and remove simplices of positive dimensions until we obtain  $K$ . On each step we construct a deformation retraction, and the composite map would be a required retraction  $r$ .

If  $K = \partial\Delta^{m-1}$  is the boundary complex of an  $(m-1)$ -simplex, then  $U(K) \cap \mathbb{R}_+^m = \mathbb{R}_+^m \setminus \{0\}$ . In this case the retraction  $r$  is shown on Figure 11. Now suppose that  $K$  is obtained by removing one  $(k-1)$ -dimensional simplex  $J = \{j_1, \dots, j_k\}$  from simplicial complex  $K'$ , that is  $K \cup J = K'$ . By the inductive hypothesis, there is a deformation retraction  $r' : U(K') \cap \mathbb{R}_+^m \rightarrow \text{cc}(K')$ . Let  $a \in \mathbb{R}_+^m$  be the point with coordinates  $y_{j_1} = \dots = y_{j_k} = 0$  and  $y_i = 1$  for  $i \notin J$ . Since  $J$  is not a simplex of  $K$ , we have  $a \notin U(K) \cap \mathbb{R}_+^m$ . At the same time,  $a \in C_J$  (see (19)). Hence, we may apply the retraction from Figure 11 on the face  $C_J \subset I^m$ , with centre at  $a$ . Denote this retraction by  $r_J$ . Then  $r = r_J \circ r'$  is the required deformation retraction.

The deformation retraction  $r : U(K) \cap \mathbb{R}_+^m \rightarrow \text{cc}(K)$  is covered by an equivariant deformation retraction  $U(K) \rightarrow \mathcal{Z}_K$ .  $\square$



In the case  $K = K_P$  (i.e.  $K$  is a polytopal simplicial sphere corresponding to a simple polytope  $P^n$ ) the deformation retraction  $U(K_P) \rightarrow \mathcal{Z}_P$  from Theorem 5.2.5 can be realised as the orbit map for an action of a contractible group. We denote  $U(P^n) := U(K_P)$ . Set

$$\mathbb{R}_{>}^m = \{(y_1, \dots, y_m) \in \mathbb{R}^m : y_i > 0, i = 1, \dots, m\} \subset \mathbb{R}_+^m.$$

Then  $\mathbb{R}_{>}^m$  is a group with respect to the multiplication, and it acts on  $\mathbb{R}^m$ ,  $\mathbb{C}^m$  and  $U(P^n)$  by coordinatewise multiplication. There is the isomorphism  $\exp : \mathbb{R}^m \rightarrow \mathbb{R}_{>}^m$  between the additive and the multiplicative groups taking  $(y_1, \dots, y_m) \in \mathbb{R}^m$  to  $(e^{y_1}, \dots, e^{y_m}) \in \mathbb{R}_{>}^m$ .

Let us consider the  $m \times (m - n)$ -matrix  $W$  introduced in Construction 1.1.4 for any simple polytope (1).

**Proposition 5.2.6.** *For any vertex  $v = F_{i_1} \cap \dots \cap F_{i_n}$  of  $P^n$  the maximal minor  $W_{\hat{i}_1 \dots \hat{i}_n}$  which is obtained by deleting  $n$  rows  $i_1, \dots, i_n$  from  $W$  is non-degenerate:  $\det W_{\hat{i}_1 \dots \hat{i}_n} \neq 0$ .*

*Proof.* If  $\det W_{\hat{i}_1 \dots \hat{i}_n} = 0$  then vectors  $l_{i_1}, \dots, l_{i_n}$  (see (1)) are linearly dependent, which is impossible.  $\square$

The matrix  $W$  defines the subgroup

$$(75) \quad R_W = \{(e^{w_{11}\tau_1 + \dots + w_{1,m-n}\tau_{m-n}}, \dots, e^{w_{m1}\tau_1 + \dots + w_{m,m-n}\tau_{m-n}})\} \subset \mathbb{R}_{>}^m,$$

where the parameters  $\tau_1, \dots, \tau_{m-n}$  vary over  $\mathbb{R}^{m-n}$ . Obviously,  $R_W \cong \mathbb{R}_{>}^{m-n}$ .

**Theorem 5.2.7** ([22, Theorem 2.3]). *The subgroup  $R_W \subset \mathbb{R}_{>}^m$  acts freely on  $U(P^n) \subset \mathbb{C}^m$ . The composite map  $\mathcal{Z}_P \hookrightarrow U(P^n) \rightarrow U(P^n)/R_W$  of the embedding  $i_e$  (Lemma 3.1.6) and the orbit map is an equivariant diffeomorphism (with respect to the  $T^m$ -actions).*

*Proof.* A point from  $\mathbb{C}^m$  has the non-trivial isotropy subgroup with respect to the action of  $\mathbb{R}_{>}^m$  on  $\mathbb{C}^m$  if and only if at least one of its coordinates vanishes. It follows from (73) that if a point  $x \in U(P^n)$  has some zero coordinates, then the corresponding facets of  $P^n$  have at least one common vertex  $v \in P^n$ . Let  $v = F_{i_1} \cap \dots \cap F_{i_n}$ . The isotropy subgroup of the point  $x$  with respect to the action of the subgroup  $R_W$  is non-trivial only if some linear combination of columns of  $W$  lies in the coordinate subspace spanned by  $e_{i_1}, \dots, e_{i_n}$ . But this implies that  $\det W_{\hat{i}_1 \dots \hat{i}_n} = 0$ , which contradicts Proposition 5.2.6. Thus,  $R_W$  acts freely on  $U(P^n)$ .

To prove the second part of the theorem it is sufficient to show that each orbit of the action of  $R_W$  on  $U(P^n) \subset \mathbb{C}^m$  intersects the image  $i_e(\mathcal{Z}_P)$  at a single point. Since the embedding  $i_e$  is equivariant with respect to the  $T^m$ -actions, the latter statement is equivalent to that each orbit of the action of  $R_W$  on  $U(P^n) \cap \mathbb{R}_+^m$  intersects the image  $i_P(P^n)$  (see Theorem 1.5.6) at a single point. Let  $y \in i_P(P^n) \subset \mathbb{R}^m$ . Then  $y = (y_1, \dots, y_m)$  lies in some  $n$ -face  $i_P(C_v^n)$  of the cube  $I^m \subset \mathbb{R}^m$ , see (20). We need to show that the  $(m - n)$ -dimensional subspace spanned by the vectors  $(w_{11}y_1, \dots, w_{m1}y_m)^t, \dots, (w_{1,m-n}y_1, \dots, w_{m,m-n}y_m)^t$  is in general position with the  $n$ -face  $i_P(C_v^n)$  of  $I^m$ . This follows directly from (20) and Proposition 5.2.6.  $\square$

Suppose now that  $P^n$  is a lattice simple polytope, and let  $M_P$  be the corresponding toric variety (Construction 2.1.3). Along with the real subgroup  $R_W \subset \mathbb{R}_{>}^m$  (75)

we define

$$C_W = \{(e^{w_{11}\phi_1 + \dots + w_{1,m-n}\phi_{m-n}}, \dots, e^{w_{m1}\phi_1 + \dots + w_{m,m-n}\phi_{m-n}})\} \subset (\mathbb{C}^*)^m,$$

where the parameters  $\phi_1, \dots, \phi_{m-n}$  vary over  $\mathbb{C}^{m-n}$ . Obviously,  $C_W \cong (\mathbb{C}^*)^{m-n}$ . It is shown in [7], [11], [31] that  $C_W$  acts freely on  $U(P^n)$  and the toric variety  $M_P$  can be identified with the orbit space (or *geometric quotient*)  $U(P^n)/C_W$ . Thus, we have the following commutative diagram:

$$(76) \quad \begin{array}{ccc} U(P^n) & \xrightarrow{R_W \cong \mathbb{R}_{>}^{m-n}} & \mathcal{Z}_P \\ C_W \cong (\mathbb{C}^*)^{m-n} \downarrow & & \downarrow T^{m-n} \\ M_P & \xlongequal{\quad} & M_P. \end{array}$$

*Remark.* It can be shown [31, Theorem 2.1] that *any* toric variety  $M_\Sigma$  corresponding to a fan  $\Sigma \subset \mathbb{R}^n$  with  $m$  one-dimensional cones can be identified with the universal categorical quotient  $U(\mathcal{CA}_\Sigma)/G$ , where  $U(\mathcal{CA}_\Sigma)$  is the complement of a certain coordinate arrangement (determined by the fan  $\Sigma$ ) and  $G \cong (\mathbb{C}^*)^{m-n}$ . The categorical quotient becomes the geometric quotient if and only if the fan  $\Sigma$  is simplicial. In this case  $U(\mathcal{CA}_\Sigma) = U(K_\Sigma)$ .

On the other hand, if the projective toric variety  $M_P$  is non-singular, then  $M_P$  is a symplectic manifold of dimension  $2n$ , and the action of  $T^n$  on it is Hamiltonian [7]. In this case the diagram (76) displays  $M_P$  as the result of the process of *symplectic reduction*. Namely, let  $H_W \cong T^{m-n}$  be the maximal compact subgroup in  $C_W$ , and  $\mu : \mathbb{C}^m \rightarrow \mathbb{R}^{m-n}$  the *moment map* for the Hamiltonian action of  $H_W$  on  $\mathbb{C}^m$ . Then for any regular value  $a \in \mathbb{R}^{m-n}$  of the map  $\mu$  there is the following diffeomorphism:

$$\mu^{-1}(a)/H_W \longrightarrow U(P^n)/C_W = M_P$$

(details can be found in [7]). In this situation  $\mu^{-1}(a)$  is exactly our manifold  $\mathcal{Z}_P$ . This gives us another interpretation of the manifold  $\mathcal{Z}_P$  as the level surface for the moment map (in the case when  $P^n$  can be realised as the quotient of a non-singular projective toric variety).

**Example 5.2.8.** Let  $P^n = \Delta^n$  (the  $n$ -simplex). Then  $m = n + 1$ ,  $U(P^n) = \mathbb{C}^{n+1} \setminus \{0\}$ ,  $R_W \cong \mathbb{R}_{>}$ ,  $C_W \cong \mathbb{C}^*$  and  $H_W \cong S^1$  are the diagonal subgroups in  $\mathbb{R}_{>}^{n+1}$ ,  $(\mathbb{C}^*)^{n+1}$  and  $T^{m+1}$  respectively (see Example 1.1.5). Hence,  $\mathcal{Z}_P \cong S^{2n+1} = (\mathbb{C}^{n+1} \setminus \{0\})/\mathbb{R}_{>}$  and  $M_P = (\mathbb{C}^{n+1} \setminus \{0\})/\mathbb{C}^* = \mathbb{C}P^n$ . The moment map  $\mu : \mathbb{C}^m \rightarrow \mathbb{R}$  takes  $(z_1, \dots, z_m) \in \mathbb{C}^m$  to  $\frac{1}{2}(|z_1|^2 + \dots + |z_m|^2)$ , and for  $a \neq 0$  we have  $\mu^{-1}(a) \cong S^{2n+1} \cong \mathcal{Z}_K$ .

The previous discussion illustrates the importance of calculating the cohomology of subspace arrangement complements.

**Theorem 5.2.9** (Buchstaber and Panov). *The following isomorphism of graded algebras holds:*

$$\begin{aligned} H^*(U(K)) &\cong \text{Tor}_{\mathbf{k}[v_1, \dots, v_m]}(\mathbf{k}(K), \mathbf{k}) \\ &= H[\Lambda[u_1, \dots, u_m] \otimes \mathbf{k}(K), d]. \end{aligned}$$

*Proof.* This follows from theorems 5.2.5, 4.2.1 and 4.2.2.  $\square$

Theorem 5.2.9 provides an extremely effective way to calculate the cohomology algebra of the complement of any complex coordinate subspace arrangement. The

De Concini and Procesi [34] and Yuzvinsky [88] rational models of the cohomology algebra of an arrangement complement also can be interpreted as an application of the Koszul resolution. However, these author did not discuss the relationships with the Stanley–Reisner ring in the case of coordinate subspace arrangements.

**Problem 5.2.10.** *Calculate the cohomology algebra with  $\mathbb{Z}$  coefficients of a coordinate subspace arrangement complement and describe its relationships with the corresponding Tor-algebra  $\text{Tor}_{\mathbb{Z}[v_1, \dots, v_m]}(\mathbb{Z}(K), \mathbb{Z})$ .*

**Example 5.2.11.** Let  $K$  be a disjoint union of  $m$  vertices. Then  $U(K)$  is obtained by removing all codimension-two coordinate subspaces  $z_i = z_j = 0$ ,  $i, j = 1, \dots, m$  from  $\mathbb{C}^m$  (see Example 5.2.3). The face ring is  $\mathbf{k}(K) = \mathbf{k}[v_1, \dots, v_m]/\mathcal{I}_K$ , where  $\mathcal{I}_K$  is generated by monomials  $v_i v_j$ ,  $i \neq j$ . An easy calculation using Corollary 5.2.9 shows that the subspace of cocycles in  $\mathbf{k}(K) \otimes \Lambda[u_1, \dots, u_m]$  has the basis consisting of monomials  $v_{i_1} u_{i_2} u_{i_3} \cdots u_{i_k}$  with  $k \geq 2$ ,  $i_p \neq i_q$  for  $p \neq q$ . Since  $\deg(v_{i_1} u_{i_2} u_{i_3} \cdots u_{i_k}) = k + 1$ , the space of  $(k + 1)$ -dimensional cocycles has dimension  $m \binom{m-1}{k-1}$ . The space of  $(k + 1)$ -dimensional coboundaries is  $\binom{m}{k}$ -dimensional (it is spanned by the coboundaries of the form  $d(u_{i_1} \cdots u_{i_k})$ ). Hence,

$$\begin{aligned} \dim H^0(U(K)) &= 1, & H^1(U(K)) &= H^2(U(K)) = 0, \\ \dim H^{k+1}(U(K)) &= m \binom{m-1}{k-1} - \binom{m}{k} = (k-1) \binom{m}{k}, & 2 \leq k \leq m, \end{aligned}$$

and the multiplication in the cohomology is trivial.

In particular, for  $m = 3$  we have 6 three-dimensional cohomology classes  $[v_i u_j]$ ,  $i \neq j$  subject to 3 relations  $[v_i u_j] = [v_j u_i]$ , and 3 four-dimensional cohomology classes  $[v_1 u_2 u_3]$ ,  $[v_2 u_1 u_3]$ ,  $[v_3 u_1 u_2]$  subject to one relation

$$[v_1 u_2 u_3] - [v_2 u_1 u_3] + [v_3 u_1 u_2] = 0.$$

Hence,  $\dim H^3(U(K)) = 3$ ,  $\dim H^4(U(K)) = 2$ , and the multiplication is trivial.

**Example 5.2.12.** Let  $K$  be the boundary of an  $m$ -gon,  $m > 3$ . Then

$$U(K) = \mathbb{C}^m \setminus \bigcup_{i-j \not\equiv 0, 1 \pmod m} \{z_i = z_j = 0\}.$$

By Theorem 5.2.9, the cohomology ring of  $H^*(U(K); \mathbf{k})$  is isomorphic to the ring described in Example 4.3.5.

As it is shown in [41], in the case of arrangements of *real* coordinate subspaces only *additive* analogue of our Theorem 5.2.9 holds. Namely, let us consider the polynomial ring  $\mathbf{k}[x_1, \dots, x_m]$  with  $\deg x_i = 1$ ,  $i = 1, \dots, m$ . Then the graded structure in the face ring  $\mathbf{k}(K)$  changes accordingly. The Betti numbers of the real coordinate subspace arrangement  $U_{\mathbb{R}}(K)$  are calculated by means of the following result.

**Theorem 5.2.13** ([41, Theorem 3.1]). *The following isomorphism hold:*

$$H^p(U_{\mathbb{R}}(K)) \cong \sum_{-i+j=p} \text{Tor}_{\mathbf{k}[x_1, \dots, x_m]}^{-i,j}(\mathbf{k}(K), \mathbf{k}) = H^{-i,j}[\Lambda[u_1, \dots, u_m] \otimes \mathbf{k}(K), d],$$

where  $\text{bideg } u_i = (-1, 1)$ ,  $\text{bideg } v_i = (0, 1)$ ,  $du_i = x_i$ ,  $dx_i = 0$ .

As it was observed in [41], there is *no* multiplicative isomorphism analogous to Theorem 5.2.9 in the case of real arrangements, that is, the algebras  $H^*(U_{\mathbb{R}}(K))$  and  $\mathrm{Tor}_{\mathbf{k}[x_1, \dots, x_m]}(\mathbf{k}(K), \mathbf{k})$  are not isomorphic in general. The paper [41] also contains the formulation of the first multiplicative isomorphism of our Theorem 5.2.9 for complex coordinate subspace arrangements (see [41, Theorem 3.6]), with a reference to yet unpublished paper by Babson and Chan.

Until now, we have used the description of coordinate subspaces by means of equations (see (72)). On the other hand, a coordinate subspace can be defined as the linear span of some subset of the standard basis  $\{e_1, \dots, e_m\}$ . This leads to the dual approach to the description of coordinate subspace arrangements, which corresponds to the passage from simplicial complex  $K$  to the associated complex  $\widehat{K}$  (Example 1.2.4). This approach was used in [35]. It was shown there that the summands in the Goresky–MacPherson formula in the coordinate subspace arrangement case are homology groups of links of simplices of  $\widehat{K}$ . This allowed to interpret the product of cohomology classes of the complement of a coordinate subspace arrangement (either real or complex) in terms of the combinatorics of links of simplices in  $\widehat{K}$  (see [35, Theorem 1.1]).

We mention that our theorems 4.2.2 and 5.2.5 show that the Goresky–MacPherson result (Theorem 5.1.2) in the case of coordinate subspace arrangements is equivalent to the Hochster theorem (Theorem 1.4.5).

### 5.3. Diagonal subspace arrangements and cohomology of loop space $\Omega\mathcal{Z}_K$ .

In this section we establish relationships between the results of [70] on the cohomology of real diagonal arrangement complements and the cohomology of the loop spaces  $\Omega B_T \mathcal{Z}_K$  and  $\Omega\mathcal{Z}_K$ .

For each subset  $I = \{i_1, \dots, i_k\} \subset [m]$  define the *diagonal subspace*  $D_I$  in  $\mathbb{R}^m$  as

$$D_I = \{(y_1, \dots, y_m) \in \mathbb{R}^m : y_{i_1} = \dots = y_{i_k}\}.$$

Diagonal subspaces in  $\mathbb{C}^m$  are defined similarly. An arrangement of planes  $\mathcal{A} = \{L_1, \dots, L_r\}$  (either real or complex) is called *diagonal* if all planes  $L_i$ ,  $i = 1, \dots, r$ , are diagonal subspaces. The classical example of a diagonal subspace arrangement is given by the arrangement of all diagonal hyperplanes  $\{z_i = z_j\}$  in  $\mathbb{C}^m$ ; its complement is the classifying space for the braid group  $B_m$ , see [4].

**Construction 5.3.1.** Given a simplicial complex  $K$  on the vertex set  $[m]$ , introduce the diagonal subspace arrangement  $\mathcal{DA}(K)$  as the set of subspaces  $D_I$  such that  $I$  is not a simplex of  $K$ :

$$\mathcal{DA}(K) = \{D_I : I \notin K\}.$$

Denote the complement of the arrangement  $\mathcal{DA}(K)$  by  $M(K)$ .

The proof of the following statement is similar to the proof of the corresponding statement for coordinate subspace arrangements from section 5.2.

**Proposition 5.3.2.** *The assignment  $K \mapsto M(K)$  defines a one-to-one order-preserving correspondence between simplicial complexes on the vertex set  $[m]$  and the complements of diagonal subspace arrangements in  $\mathbb{R}^m$ .*

Here we still assume that  $\mathbf{k}$  is a field. The multigraded (or  $\mathbb{N}^m$ -graded) structure in the ring  $\mathbf{k}[v_1, \dots, v_m]$  (Construction 1.4.7) defines an  $\mathbb{N}^m$ -grading in the Stanley–Reisner ring  $\mathbf{k}(K)$ . The monomial  $v_1^{i_1} \dots v_m^{i_m}$  acquires the multidegree  $(2i_1, \dots, 2i_m)$ . Let us consider the modules  $\mathrm{Tor}_{\mathbf{k}(K)}(\mathbf{k}, \mathbf{k})$ . They can be calculated,

for example, by means of the minimal free resolution (Example 1.4.2) of the field  $\mathbf{k}$  regarded as a  $\mathbf{k}(K)$ -module. The minimal resolution also carries a natural  $\mathbb{N}^m$ -grading, and we denote the subgroup of elements of multidegree  $(2i_1, \dots, 2i_m)$  in  $\mathrm{Tor}_{\mathbf{k}(K)}(\mathbf{k}, \mathbf{k})$  by  $\mathrm{Tor}_{\mathbf{k}(K)}(\mathbf{k}, \mathbf{k})_{(2i_1, \dots, 2i_m)}$ .

**Theorem 5.3.3** ([70, Theorem 1.3]). *The following isomorphism holds for the cohomology groups of the complement  $M(K)$  of a real diagonal subspace arrangement:*

$$H^i(M(K); \mathbf{k}) \cong \mathrm{Tor}_{\mathbf{k}(K)}^{-(m-i)}(\mathbf{k}, \mathbf{k})_{(2, \dots, 2)}.$$

*Remark.* Instead of simplicial complexes  $K$  on the vertex set  $[m]$  the authors of [70] considered square-free monomial ideals  $\mathcal{I} \subset \mathbf{k}[v_1, \dots, v_m]$ . Proposition 1.3.2 shows that these two approaches are equivalent.

**Theorem 5.3.4.** *The following additive isomorphism holds:*

$$H^*(\Omega_{B_T} \mathcal{Z}_K; \mathbf{k}) \cong \mathrm{Tor}_{\mathbf{k}(K)}(\mathbf{k}, \mathbf{k}).$$

*Proof.* Let us consider the Eilenberg–Moore spectral sequence of the Serre fibration  $P \rightarrow SR(K)$  with fibre  $\Omega SR(K)$ , where  $SR(K)$  is the Stanley–Reisner space (Definition 3.4.2) and  $P$  is the path space over  $SR(K)$ . By Corollary 4.1.4,

$$(77) \quad E_2 = \mathrm{Tor}_{H^*(SR(K))}(H^*(P), \mathbf{k}) \cong \mathrm{Tor}_{\mathbf{k}(K)}(\mathbf{k}, \mathbf{k}),$$

and the spectral sequence converges to  $\mathrm{Tor}_{C^*(SR(K))}(C^*(P), \mathbf{k}) \cong H^*(\Omega SR(K))$ . Since  $P$  is contractible, there is a cochain equivalence  $C^*(P) \simeq \mathbf{k}$ . We have  $C^*(SR(K)) \cong \mathbf{k}(K)$ . Therefore,

$$\mathrm{Tor}_{C^*(SR(K))}(C^*(P), \mathbf{k}) \cong \mathrm{Tor}_{\mathbf{k}(K)}(\mathbf{k}, \mathbf{k}),$$

which together with (77) shows that the spectral sequence collapses at the  $E_2$  term. Hence,  $H^*(\Omega SR(K)) \cong \mathrm{Tor}_{\mathbf{k}(K)}(\mathbf{k}, \mathbf{k})$ . Finally, Theorem 3.4.4 shows that  $H^*(\Omega SR(K)) \cong H^*(\Omega_{B_T} \mathcal{Z}_K)$ , which concludes the proof.  $\square$

**Proposition 5.3.5.** *The following isomorphism of algebras holds*

$$H^*(\Omega_{B_T} \mathcal{Z}_K) \cong H^*(\Omega \mathcal{Z}_K) \otimes \Lambda[u_1, \dots, u_m].$$

*Proof.* Consider the bundle  $B_T \mathcal{Z}_K \rightarrow BT^m$  with fibre  $\mathcal{Z}_K$ . It is not hard to prove that the corresponding loop bundle  $\Omega_{B_T} \mathcal{Z}_K \rightarrow T^m$  with fibre  $\Omega \mathcal{Z}_K$  is trivial (note that  $\Omega BT^m \cong T^m$ ). To finish the proof it remains to mention that  $H^*(T^m) \cong \Lambda[u_1, \dots, u_m]$ .  $\square$

Theorems 5.2.5 and 5.2.9 give an application of the theory of moment-angle complexes to calculating the cohomology ring of a coordinate subspace arrangement complement. Similarly, theorems 5.3.3, 5.3.4 and Proposition 5.3.5 establish the connection between the cohomology of a diagonal subspace arrangement complement and the cohomology of the loop space over the moment-angle complex  $\mathcal{Z}_K$ . However, in this case the situation is much more subtle than in the case of coordinate subspace arrangements. For instance, we do not have an analogue of the *multiplicative* isomorphism from Theorem 5.2.9. That is why we consider this concluding section only as the first step in applying the theory of moment-angle complexes to studying the complements of diagonal subspace arrangements.

## REFERENCES

- [1] J. F. Adams, *On the cobar construction*, Proc. Nat. Acad. Sci. USA **42** (1956), 409–412.
- [2] J. F. Adams, *On the non-existence of elements of Hopf invariant one*, Ann. of Math., II **72** (1960), no. 1, 20–104.
- [3] S. Akbulut and J. D. McCarthy, *Casson’s Invariant for Oriented Homology 3-spheres*, Math. Notes **36**, Princeton Univ. Press, Princeton, N.J., 1990.
- [4] V. I. Arnold, *The cohomology ring of the colored braid group*, Math. Notes **5** (1969), 138–140.
- [5] M. F. Atiyah and R. Bott, *A Lefschetz fixed point formula for elliptic complexes: I*, Annals of Math. **86** (1967), no. 2, 374–407.
- [6] M. F. Atiyah and F. Hirzebruch, *Spin-manifolds and group actions*, in: Essays in Topology and Related Topics, Springer-Verlag, Berlin-Heidelberg-New York, 1970, pp. 18–28.
- [7] M. Audin, *The Topology of Torus Actions on Symplectic Manifolds*, Progress in Mathematics **93**, Birkhäuser, Boston Basel Berlin, 1991.
- [8] A. Bahri and M. Bendersky, *The KO-theory of toric manifolds*, Trans. Amer. Math. Soc. **352** (2000), no. 3, 1191–1202; <http://xxx.lanl.gov/abs/math.AT/9904087>.
- [9] D. Barnette, *The triangulations of the 3-sphere with up to 8 vertices*, J. Combinatorial Theory. Ser. A **14** (1973), 37–42.
- [10] D. Barnette, *A proof of the lower bound conjecture for convex polytopes*, Pacific J. Math. **46** (1973), 349–354.
- [11] V. V. Batyrev, *Quantum Cohomology Rings of Toric Manifolds*, Journées de Géométrie Algébrique d’Orsay (Juillet 1992), Astérisque **218**, Société Mathématique de France, Paris, 1993, pp. 9–34; <http://xxx.lanl.gov/abs/alg-geom/9310004>.
- [12] M. Bayer and L. Billera, *Generalized Dehn–Sommerville relations for polytopes, spheres and Eulerian partially ordered sets*, Invent. Math. **79** (1985), 143–157.
- [13] L. Billera and C. Lee, *Sufficiency of McMullen’s conditions for  $f$ -vectors of simplicial polytopes*, Bull. Amer. Math. Soc. **2** (1980), 181–185.
- [14] A. Björner, *Subspace arrangements*, in: Proc. of the First European Congress of Mathematics (Paris 1992), A. Joseph et al., eds., Birkhäuser, Basel, 1994, Vol.1, pp. 321–370.
- [15] A. Björner and F. Lutz, *Simplicial manifolds, bistellar flips and 16-vertex triangulation of the Poincaré homology 3-sphere*, preprint, 1999; <http://www.math.kth.se/~bjorner/papers.html>.
- [16] C. Boyer, K. Galicki, B. Mann and E. Rees, *Compact 3-Sasakian 7-manifolds with arbitrary second Betti number*, Invent. Math. **131** (1998), 321–344.
- [17] E. Brieskorn, *Sur les groupes de tresses (d’après V. I. Arnold)*, in: Séminaire Bourbaki 1971/72, Lecture Notes in Math. **317**, Springer-Verlag, Berlin-New York, 1973, pp. 21–44.
- [18] A. Brønsted, *An introduction to convex polytopes*, Springer-Verlag, New-York, 1983.
- [19] V. M. Buchstaber and T. E. Panov, *Algebraic topology of manifolds defined by simple polytopes*, Russian Math. Surveys **53** (1998), no. 3, 623–625.
- [20] V. M. Buchstaber and T. E. Panov, *Torus actions and combinatorics of polytopes*, Proceedings of the Steklov Institute of Mathematics **225** (1999), 87–120.
- [21] V. M. Buchstaber and T. E. Panov, *Torus actions, equivariant moment-angle complexes and coordinate subspace arrangements* (Russian), in: “Representation theory, dynamical systems, combinatorial and algorithmic methods”, Part 5, A. M. Vershik, ed., Zap. Nauchn. Semin. Leningr. Otd. Mat. Inst. Steklova **266**, 2000, pp. 29–50; English translation in: Journal of Math. Sciences, 2000, to appear; <http://xxx.lanl.gov/abs/math.AT/9912199>.
- [22] V. M. Buchstaber and T. E. Panov, *Torus actions determined by simple polytopes*, in: Geometry and Topology: Aarhus, K. Grove, I. Madsen, and E. Pedersen, eds., Contemp. Math. **258**, Amer. Math. Soc., Providence, R.I., 2000, pp. 33–46.
- [23] V. M. Buchstaber and T. E. Panov, *Moment-angle complexes and combinatorics of simplicial manifolds* (Russian), Uspekhi Mat. Nauk **55** (2000), no. 3, 171–172; English translation in: Russian Math. Surveys **55** (2000), no. 3.
- [24] V. M. Buchstaber and N. Ray, *Flag manifolds and the Landweber–Novikov algebra*, Geometry & Topology **2** (1998), 79–101; <http://www.maths.warwick.ac.uk/gt/>.
- [25] V. M. Buchstaber and N. Ray, *Toric manifolds and complex cobordisms*, Russian Math. Surveys **53** (1998), no. 2, 371–373.
- [26] V. M. Buchstaber and N. Ray, *Tangential structures on toric manifolds, and connected sums of polytopes*, preprint UMIST no. 2000/5, Manchester, 2000; Internat. Math. Res. Notices (2001), to appear; <http://xxx.lanl.gov/abs/math.AT/0010025..>

- [27] J. W. Cannon, *Shrinking cell-like decompositions of manifolds. Codimension three.*, Ann. of Math., II **110** (1979), 83–112.
- [28] H. Cartan and S. Eilenberg, *Homological algebra*, Princeton Univ. Press, Princeton, N.J., 1956.
- [29] R. Charney and M. Davis, *The Euler characteristic of a nonpositively curved, piecewise Euclidean manifold*, Pacific J. Math. **171** (1995), 117–137.
- [30] B. Chen and M. Yan, *Singularity from Eulerian viewpoint*, Proceedings of the Steklov Institute of Mathematics **221** (1998), 305–319.
- [31] D. A. Cox, *Recent developments in toric geometry*, Proc. Symp. Pure Math. **62** (pt.2), Amer. Math. Soc., Providence, R.I., 1997, pp. 389–436; <http://xxx.lanl.gov/abs/alg-geom/9606016>.
- [32] V. Danilov, *The geometry of toric varieties*, Russian Math. Surveys **33** (1978), 97–154.
- [33] M. Davis and T. Januszkiewicz, *Convex polytopes, Coxeter orbifolds and torus actions*, Duke Math. J. **62** (1991), no. 2, 417–451.
- [34] C. De Concini and C. Procesi, *Wonderful models of subspace arrangements*, Selecta Math., New Ser. **1** (1995), 459–494.
- [35] M. De Longueville, *The ring structure on the cohomology of coordinate subspace arrangements*, Math. Z. **233** (2000), no. 3, 553–577.
- [36] N. Dobrinskaya, *The classification problem for quasitoric manifolds over given simple polytope*, Funct. Anal. and Appl. **34** (2000), no. 4, to appear.
- [37] N. P. Dolbilin, M. A. Shtan'ko and M. I. Shtogrin, *Cubic subcomplexes in regular lattices*, Sov. Math., Dokl. **34** (1987), 467–469.
- [38] R. D. Edwards, *The topology of manifolds and cell-like maps*, Proceedings of the International Congress of Mathematicians (Helsinki, 1978), Helsinki, 1980, pp. 111–127.
- [39] S. Eilenberg and J. C. Moore, *Homology and fibrations. I*, Comment. Math. Helv. **40** (1966), 199–236.
- [40] W. Fulton, *Introduction to Toric Varieties*, Ann. of Math. Studies **131**, Princeton Univ. Press, Princeton, N.J., 1993.
- [41] V. Gasharov, I. Peeva and V. Welker, *Coordinate subspace arrangements and monomial ideals*, preprint, 1999; <http://www.mathematik.uni-marburg.de/~welker/sections/preprints.html>.
- [42] M. Goresky and R. MacPherson, *Stratified Morse Theory*, Springer-Verlag, Berlin–New York, 1988.
- [43] M. Gromov, *Hyperbolic groups*, in: Essays in Group Theory **8**, S. M. Gersten, ed., Math. Sci. Res. Inst. Publ., Springer-Verlag, New York, 1987, pp. 75–264.
- [44] A. Hattori, *Almost complex toric manifolds and complex line bundles*, in: Homotopy and Geometry, Banach Center of Publications, vol. **45**, Polish Academy of Sciences, 1998, pp. 95–114.
- [45] F. Hirzebruch, T. Berger and R. Jung, *Manifolds and Modular Forms*, Second Edition, A Publication from the Max-Planck-Institut für Mathematik, Bonn, 1994.
- [46] M. Hochster, *Cohen–Macaulay rings, combinatorics, and simplicial complexes*, in: Ring Theory II (Proc. Second Oklahoma Conference), B. R. McDonald and R. Morris, eds., Dekker, New York, 1977, pp. 171–223.
- [47] I. Izmitiev, *Manifolds defined by simple polyhedra as configuration spaces of hinge mechanisms*, Russian Math. Surveys **55** (2000), no. 1, 176–177.
- [48] I. Izmitiev, *3-dimensional manifolds defined by simple polytopes with coloured facets* (Russian), Math. Notes **66** (2001), to appear.
- [49] K. Jänich, *On the classification of  $O(n)$ -manifolds*, Mathematische Annalen **176** (1968), 53–76.
- [50] A. G. Khovanskii, *Hyperplane sections of polyhedra*, Funct. Anal. Appl. **20** (1986), no. 1, 41–50.
- [51] R. C. Kirby and L. C. Siebenmann, *Foundational Essays on Topological Manifolds, Smoothings, and Triangulations*, Ann. of Math. Stud. **88**, Princeton Univ. Press, Princeton, N.J., 1977.
- [52] V. Klee, *A combinatorial analogue of Poincaré's duality theorem*, Canad. J. Math. **16** (1964), 517–531.
- [53] P. Kleinschmidt, *A classification of toric varieties with few generators*, Aequationes Math. **35** (1988), no. 2-3, 254–266.

- [54] P. S. Landweber, *Homological properties of comodules over  $MU_*(MU)$  and  $BP_*(BP)$* , Amer. J. Math. **98** (1976), 591–610.
- [55] N. C. Leung and V. Reiner, *The signature of a toric variety*, preprint, 1999; <http://www.math.umn.edu/~reiner/Papers/papers.html>.
- [56] S. MacLane, *Homology*, Springer-Verlag, Berlin, 1963.
- [57] M. Masuda, *Unitary toric manifolds, multi-fans and equivariant index*, Tohoku Math. J. **51** (1999), 237–265.
- [58] P. McMullen, *The numbers of faces of simplicial polytopes*, Israel J. Math. **9** (1971), 559–570.
- [59] P. McMullen, *On simple polytopes*, Invent. Math. **113** (1993), 419–444.
- [60] E. E. Moise, *Geometric Topology in Dimensions 2 and 3*, Springer-Verlag, New-York, 1977.
- [61] S. P. Novikov, *Topology I*, Encyclopaedia Math. Sci. **12**, Springer-Verlag, Berlin, 1996.
- [62] T. Oda, *Convex Bodies and Algebraic Geometry*, Springer-Verlag, New York, 1988.
- [63] P. Orlik and F. Raymond, *Actions of the torus on 4-manifolds*, Trans. Amer. Math. Soc. **152** (1970), 531–559.
- [64] P. Orlik and L. Solomon, *Combinatorics and Topology of Complements of Hyperplanes*, Invent. Math. **56** (1980), 167–189.
- [65] P. Orlik and H. Terao, *Arrangements of hyperplanes*, Springer-Verlag, New York, 1992.
- [66] U. Pachner, *Konstruktionsmethoden und das kombinatorische Homöomorphieproblem für Triangulationen kompakter semilinearer Mannigfaltigkeiten*, Abh. Math. Sem. Univ. Hamburg **57** (1986), 69–85.
- [67] U. Pachner, *P.L. homeomorphic manifolds are equivalent by elementary shellings*, European J. Combin. **12** (1991), 129–145.
- [68] T. E. Panov, *Combinatorial formulae for the  $\chi_y$ -genus of a multioriented quasitoric manifold*, Russian Math. Surveys **54** (1999), no. 5, 1037–1039.
- [69] T. E. Panov, *Hirzebruch genera of manifolds with torus actions*, preprint, 1999, <http://xxx.lanl.gov/abs/math.AT/9910083>.
- [70] I. Peeva, V. Reiner and V. Welker, *Cohomology of real diagonal subspace arrangements via resolutions*, Compositio Math. **117** (1999), no. 1, 99–115.
- [71] L. S. Pontrjagin, *Foundations of combinatorial topology*, Graylock Press, Rochester, N.Y., 1952.
- [72] A. A. Ranicki, *On the Hauptvermutung*, in: The Hauptvermutung book, *K-Monogr. Math.* **1**, Kluwer Acad. Publ., Dordrecht, 1996, pp. 3–31.
- [73] G. Reisner, *Cohen–Macaulay quotients of polynomial rings*, Adv. Math. **21** (1976), 30–49.
- [74] C. P. Rourke and B. J. Sanderson, *Introduction to Piecewise-Linear Topology*, Springer-Verlag, Berlin, 1982.
- [75] M. A. Shtan’ko and M. I. Shtogrin, *On the embedding of cubic manifolds and complexes in a cubic lattice*, Russian Math. Surveys **47** (1992), no. 1, 267–268.
- [76] L. Smith, *Homological algebra and the Eilenberg–Moore spectral sequence*, Trans. Amer. Math. Soc. **129** (1967), 58–93.
- [77] D. M. Y. Sommerville, *The relations connecting the angle-sums and volume of a polytope in space of  $n$  dimensions*, Proc. Roy. Soc. London Ser. A **115** (1927), 103–119.
- [78] R. Stanley, *Hilbert functions of graded algebras*, Adv. Math. **28** (1978), 57–83.
- [79] R. Stanley, *The number of faces of simplicial convex polytope*, Adv. Math. **35** (1980), 236–238.
- [80] R. Stanley, *A monotonicity property of  $h$ -vectors and  $h^*$ -vectors*, European J. Combin. **14** (1993), 251–258.
- [81] R. Stanley, *Combinatorics and Commutative Algebra*, second edition, Progress in Math. **41**, Birkhauser, Boston, 1996.
- [82] R. Stanley, *Positivity problems and conjectures in algebraic combinatorics*, in Mathematics: Frontiers and Perspectives, V. Arnold et al, eds., Amer. Math. Soc., Providence, R.I., 2000, pp. 295–319.
- [83] R. Stong, *Notes on Cobordism Theory*, Princeton Univ. Press, Princeton, N.J., 1968.
- [84] T. Tay, N. White, and W. Whiteley, *Skeletal rigidity of simplicial complexes. I, II*, European J. Combin. **16** (1995), no. 4, 381–403; no. 5, 503–523.
- [85] V. Timorin, *An analogue of the Hodge–Riemann relations for simple convex polytopes*, Russian Math. Surveys **54** (1999), no. 2., 381–426.
- [86] J. A. Todd (ed.), *Proceedings of the international congress of mathematicians. 14–21 August 1958*, At the University Press, Cambridge, 1960.
- [87] V. Vassiliev, *Topology of complements of discriminants* (Russian), Phasis, Moscow, 1997.



- [88] S. Yuzvinsky, *Small rational model of subspace complement*, preprint, 1999;  
<http://xxx.lanl.gov/abs/math.CO/9806143>.
- [89] G. Ziegler, *Lectures on Polytopes*, Graduate Texts in Math. **152**, Springer-Verlag, New-York, 1995.

DEPARTMENT OF MATHEMATICS AND MECHANICS, MOSCOW STATE UNIVERSITY, 119899  
MOSCOW RUSSIA

*E-mail address:* buchstab@mech.math.msu.su

*E-mail address:* tpanov@mech.math.msu.su