

COMPACT STEIN SURFACES WITH BOUNDARY AS BRANCHED COVERS OF B^4

A. Loi

Dipartimento di Matematica e Fisica
Università di Sassari – Italia
loi@ssmain.uniss.it

R. Piergallini

Dipartimento di Matematica e Fisica
Università di Camerino – Italia
pierg@camserv.unicam.it

Abstract

We prove that Stein surfaces with boundary coincide up to orientation preserving diffeomorphisms with simple branched coverings of B^4 whose branch set is a positive braided surface. As a consequence, we have that a smooth oriented 3-manifold is Stein fillable iff it has a positive open-book decomposition.

Keywords: Stein manifold, Lefschetz fibration, branched covering, positive braided surface, positive open-book decomposition, holomorphically fillable, contact structure.

AMS Classification: 57 M 10, 57 M 50

Introduction

Compact Stein surfaces with (strictly pseudoconvex) boundary play an important role for the contact topology of 3-manifolds, due to the fact that their boundaries carry natural tight contact structures, given by the complex tangencies.

It is worth remarking that, this is one of the only two known general ways for producing tight contact structures, the other one being perturbation of taut foliations (cf. [13]). On the other hand, Stein surfaces with boundary can also be used to define invariants for fillable contact structures (see [16] and [27]).

A topological characterization of compact Stein surfaces has been given by Eliashberg in term of handle decomposition, by using the notion of Legendrian surgery (cf. [10] and [16]). In [16], Gompf developed a Legendrian version of the Kirby calculus on framed links, in order to construct and study fillable contact 3-manifolds. In the same paper, he conjectured that the Poincaré homology sphere with reversed orientation could not be Stein fillable. This conjecture has been proved in [26] by Lisca. Successively, Ethnyre and Honda showed that the Poincaré homology sphere with reversed orientation cannot carry any tight contact structure (see [14]). However, we still have no general way for establishing whether a given 3-manifold has such a contact structure or not.

In this paper we propose an alternative approach to the topology of Stein surfaces with boundary, representing them as branched covers of B^4 . Namely, starting with a Legendrian handle decomposition of X , the lifting surgery method introduced by Montesinos in [29], gives us a covering $p : X \rightarrow B^4$, whose branch set is a non-singular ribbon (real) surfaces $S \subset B^4$. Then, we can apply the Rudolph's braiding process to S (cf. [35]) in order to make S into a braided surface in $B^2 \times B^2 \cong B^4$. The crucial point is that, performing all the operations in the proper way, the resulting braided surface is positive. By [34], this means that we can assume S to be analytic. At this point, the Grauert-Remmert theory of analytically branched coverings (see [7] or [18]), allows us to conclude that p itself can be assumed analytic up to orientation preserving diffeomorphisms. Viceversa, it is not difficult to prove that any analytical branched cover of B^4 is orientation preserving diffeomorphic to a Stein surface with boundary.

By composing the branched covering p with the projection $B^4 \cong B^2 \times B^2 \rightarrow B^2$, we get a positive Lefschetz fibration $f : X \rightarrow B^2$. In fact, under some natural restrictions, any Lefschetz fibration over B^2 factors in such a way. This gives us a further topological characterization of the compact Stein surfaces with boundary as positive Lefschetz fibrations of B^2 . Looking at the boundary, we immediately get a corresponding fillability criterion in terms of positive open books.

The paper is organized as follows. In section 1 we prove some preliminary results relating Lefschetz fibrations with covering branched over braided surfaces. Section 2 is interely devoted to prove our main theorem, that is the characterizations of compact Stein surfaces with boundary as branched covering of B^4 and as Lefschetz fibrations over B^2 (theorem 2.2). Finally, in section 3 we use this characterization in order to obtain the above mentioned fillability criterion (theorem 3.4).

1. Lefschetz fibrations

Let X be a smooth oriented connected compact 4-manifold with (possibly empty) boundary and Y be a smooth oriented connected compact surface with (possibly empty) boundary. A smooth map $f : X \rightarrow Y$ is called a *Lefschetz fibration* over Y iff the following properties hold:

- (a) f has finitely many singular values $y_1, \dots, y_n \in \text{Int } Y$ (the *branch points* of f) and the restriction of f over $Y - \{y_1, \dots, y_n\}$ is a locally trivial fiber bundle whose fiber F is an oriented compact surface with (possibly empty) boundary (the *regular fiber* of f);
- (b) for each $i = 1, \dots, n$, there is only one singular point $x_i \in \text{Int } X$ over the branch point y_i and the monodromy of a counterclockwise meridian loop around y_i is given by $\delta_i^{\varepsilon_i}$, where δ_i is the right-handed Dehn twist along $d_i \subset \text{Int } F$ and $\varepsilon_i = \pm 1$ (x_i is called *positive* or *negative* depending on ε_i).

We say that f is *positive* iff all its singular points x_i are positive and that f is *allowable* iff all the loops d_i are homologically non-trivial in F .

A Lefschetz fibration $f : X \rightarrow Y$ is completely determined, up to orientation preserving diffeomorphisms, by the branch points $y_1, \dots, y_n \in \text{Int } Y$ and by its restriction over $Y - \{y_1, \dots, y_n\}$. On the other hand, any locally trivial fiber bundle over $Y - \{y_1, \dots, y_n\}$ satisfying (a) and (b) uniquely extends to a Lefschetz fibration. In fact, the structure of f over a small disk D_i centered at y_i is given by the following commutative diagram, where: $T(\delta_i^{\varepsilon_i})$ is the mapping torus of $\delta_i^{\varepsilon_i}$ and $\pi : T(\delta_i^{\varepsilon_i}) \rightarrow S^1$ is the canonical projection; the singular fiber $F_{y_i} \cong F/d_i$ has a transversal self-intersection at x_i , which is positive or negative depending on ε_i ; h and k are orientation preserving diffeomorphisms such that, denoting with $i_{s,t} : F \rightarrow T(\delta_i^{\varepsilon_i}) \times (0, 1]$ the canonical inclusion defined by $i_{s,t}(x) = ([x, s], t)$ and putting $k_{s,t} = k \circ i_{s,t} : F \rightarrow F_{h(s,t)} \subset f^{-1}(D_i - \{y_i\})$, we have $k_{s,t}(d_i) \rightarrow x_i$ as $t \rightarrow 0$.

$$\begin{array}{ccccccc} T(\delta_i^{\varepsilon_i}) \times (0, 1] & \xrightarrow{k} & f^{-1}(D_i - \{y_i\}) & \subset & f^{-1}(D_i) & \supset & F_{y_i} \\ \downarrow \pi \times \text{id} & & \downarrow & & \downarrow f| & & \downarrow \\ S^1 \times (0, 1] & \xrightarrow{h} & D_i - \{y_i\} & \subset & D_i & \supset & \{y_i\} \end{array}$$

For any $i = 1, \dots, n$, there are local complex coordinates (z_1, z_2) of X and z of Y , respectively centered at x_i and at y_i , making f into the complex map $(z_1, z_2) \mapsto z = z_1^2 + z_2^2$. Moreover, such coordinates can be chosen orientation preserving iff x_i is a positive singular point. In other words, f is locally a complex Morse function. This fact could be used to get a natural handle decomposition of Y . For a detailed discussion of the topology of Lefschetz fibrations we refer to [17].

If $\text{Bd } Y \neq \emptyset$, the observations above say that a Lefschetz fibration $f : X \rightarrow Y$ is uniquely determined, up to orientation preserving diffeomorphisms, by its monodromy $\varphi_f : \pi_1(Y - \{y_1, \dots, y_n\}, *) \rightarrow \text{Map } F$ and that φ_f can be an arbitrary homomorphism satisfying the property (b).

For $Y = B^2$, the monodromy φ_f can be represented by an arbitrary sequence of Dehn twists $\delta_1^{\varepsilon_1}, \dots, \delta_n^{\varepsilon_n}$ along simple loops $d_1, \dots, d_n \subset \text{Int } B^2$, giving the monodromies of counterclockwise meridian loops around the branch points y_1, \dots, y_n , which freely generate $\pi_1(B^2 - \{y_1, \dots, y_n\}, *)$.

In order to describe Lefschetz fibrations in terms of branched coverings, we introduce the notion of braided surface in a product of surfaces (cf. [35] for the case of $B^2 \times B^2$).

Let Y and Z be smooth oriented connected compact surfaces. A regularly embedded smooth compact surface $S \subset Y \times Z$ is a *braided surface* over Y iff the restriction of the canonical projection $\pi_{Y|S} : S \rightarrow Y$ is a simple branched covering.

We observe that S is oriented as branched cover of Y and $\text{Bd } S$ is an oriented link in $\text{Bd } Y \times Z$ which intersects $C \times Z$ in a closed braid, for every component C of $\text{Bd } Y$. Furthermore, $\pi_{Y|S}$ has finitely many singular value $y_1, \dots, y_n \in \text{Int } Y$ and over each y_i there is only one singular point $s_i \in \text{Int } S$ for $\pi_{Y|S}$. We call s_1, \dots, s_n the *twist points* of S .

For any twist point s_i of S , there are fiber preserving local complex coordinates (w, z) of $Y \times Z$ centered at s_i making S into the surface $w = z^2$. We say that s_i is a positive twist point iff such coordinates can be chosen orientation preserving (with respect to the product orientation of $Y \times Z$) and a negative twist point otherwise. We call S a *positive braided surface* iff all its twist points are positive.

The following theorem on positive braided surfaces in $B^2 \times B^2$ will be used in the next section. Its proof is implicit in [34] (see remark 4.4 in [35] and observe that any positive braided surfaces in $B^2 \times B^2$ has a quasipositive band presentation).

THEOREM 1.1 (RUDOLPH). *A braided surface $S \subset B^2 \times B^2$ is positive iff it is isotopic to the intersection of a complex analytic curve with $B^2 \times B^2 \subset C^2$.*

Now, we come to the relation between Lefschetz fibrations with fiber F over a surface Y and branched coverings of products $Y \times Z$ (typically $Z \cong S^2$ for F closed and $Z \cong B^2$ for F bounded) with branch surfaces $S \subset Y \times Z$ braided over Y .

PROPOSITION 1.2. *Let Y and Z be smooth oriented connected compact surfaces and let $p : X \rightarrow Y \times Z$ be a simple branched covering whose branch set is a surface $S \subset Y \times Z$ braided over Y . Then, the composition $f = \pi_Y \circ p : X \rightarrow Y$ is a Lefschetz fibration which has the same branch points of $\pi_Y|_S$ and one positive (resp. negative) singular point over each positive (resp. negative) twist point of S . Moreover, if $\text{Bd } Z \neq \emptyset$ then the regular fiber of f has no closed components and f is allowable.*

Proof. Of course, f is regular at each regular point of p . Furthermore, given $x \in X$ singular point of p , we have $p(x) \in S$ and $T_x f(T_x X) = T_{p(x)} \pi_Y(T_x p(T_x X)) = T_{p(x)} \pi_Y(T_{p(x)} S)$, hence x a singular point of f iff $p(x)$ is a twist point of S .

Now, let $s_1, \dots, s_n \in S$ the twist points of S and $y_1, \dots, y_n \in Y$ their projections by π_Y . Then, f is regular over $Y - \{y_1, \dots, y_n\}$ and, by compactness, it satisfies property (a) of Lefschetz fibrations, the regular fiber $F \cong f^{-1}(y)$ with $y \neq y_1, \dots, y_n$ being simple covering of $Z \cong \{y\} \times Z$ branched over the (transversal) intersection with S , by the restriction of p .

On the other hand, since p is simple, over each singular value y_i there is only one singular point x_i . In order to verify property (b) of Lefschetz fibrations, we have to check that the monodromy around each y_i is a Dehn twist.

Let (w, z) be local fiber preserving complex coordinates of $Y \times Z$ centered at s_i and making S into the surface $w = z^2$. We can assume that w is orientation preserving on Y , so that $t \mapsto w(t) = \rho e^{2\pi i t}$, with $\rho > 0$ sufficiently small, is a counterclockwise parametrization of a simple loop $l_i \subset Y$ around y_i .

Then $S \cap (l_i \times Z)$ is the closed braid in $l_i \times Z$, corresponding to a half twist around an arc $a \subset \{w(0)\} \times \text{Int } Z$ between two branch points of the restriction of p over $\{w(0)\} \times Z$, whose meridians have the same monodromy. Such a half twist is right-handed (resp. left-handed) if s_i is a positive (resp. negative) twist point of S and lifts to the right-handed (resp. left-handed) Dehn twist along the unique simple loop d contained in $p^{-1}(a) \subset \text{Int } f^{-1}(w(0)) \cong \text{Int } F$ (cf. [2], lemma 4.2), which represents the monodromy of l_i .

Finally, assuming $\text{Bd } Z \neq \emptyset$, we have that each component of the regular fiber F has non-empty boundary, since it is a branched covering of Z . Similarly, for the loop $d \subset F$ considered above, we have that each component of $F - d$ has non-empty boundary. Then, we can conclude that f is allowable if $\text{Bd } Z \neq \emptyset$. \square

The following proposition shows that any allowable Lefschetz fibration over Y whose fiber is connected with (possibly empty) connected boundary, can be obtained as in proposition 1.2 from a quite special branched covering if $\text{Bd } Y \neq \emptyset$.

PROPOSITION 1.3. *Let $f : X \rightarrow Y$ be an allowable Lefschetz fibration with regular fiber F . If F and $\text{Bd } F$ are connected and $\text{Bd } Y \neq \emptyset$, there exists a 3-fold simple branched covering $p : X \rightarrow Y \times Z$ whose branch set is a surface $S \subset Y \times Z$ braided over Y , with $Z \cong S^2$ if F is closed and $Z \cong B^2$ otherwise, such that $f = \pi_Y \circ p$.*

Proof. First of all, since F and $\text{Bd } F$ are connected, there exists a 3-fold simple branched covering $q : F \rightarrow Z$, with Z as in the statement, such that any Dehn twist of F along a non-separating simple loop can be realized, up to isotopy, as the lifting of a half twist around an arc in Z between two branch points of q , whose meridians have the same monodromy (see [4] and remember that all the non-separating simple loops in F are equivalent). Then, any element of $\text{Map } F$ can be represented by the lifting of a diffeomorphism of Z onto itself isotopic to the identity, since Dehn twists along non-separating simple loops generate $\text{Map } F$.

Let $y_1, \dots, y_n \in \text{Int } Y$ be the branch points of f and $A_1, \dots, A_n \subset Y$ be disjoint disks such that $y_i \in \text{Int } A_i$ and $A_i \cap \text{Bd } Y$ is an arc in $\text{Bd } A_i$ for every $i = 1, \dots, n$. Then, the restriction of f over $Y_0 = \text{Cl}(Y - (A_1 \cup \dots \cup A_n))$ is a locally trivial fiber bundle.

Given a band presentation $Y_0 \cong B^2 \cup H_1 \dots \cup H_m$ with bands (= 1-handles) H_1, \dots, H_m , we construct a branched covering $p_0 : X_0 \rightarrow Y_0 \times Z$ as follows: start with the covering $\text{id}_Y \times q : Y_0 \times F \rightarrow Y_0 \times Z$; cut each $H_j \times F$ along $t_j \times F$ and each $H_j \times Z$ along $t_j \times Z$, where t_j is a transversal arc for the band H_j ; glue them back respectively by $\text{id}_{t_j} \times \varphi_f(e_j)$ and $\text{id}_{t_j} \times h_j$, where $\varphi_f(e_j) \in \text{Map } F$ is the monodromy of a simple loop e_j which goes once through H_j and $h_j : Z \rightarrow Z$ is a homeomorphism isotopic to the identity which lifts to $\varphi_f(e_i)$ by means of q .

In order to extend p_0 to a branched covering $p : X \rightarrow Y$, we consider a branched covering $r : W \rightarrow B^2 \times Z$ whose branch set is a surface braided over B^2 with only one positive twist point over 0 and whose restriction over $S^1_- \times Z$ coincides with $\text{id}_{S^1_-} \times q$. As we have seen in the proof of proposition 1.2, the composition $\pi_{B^2} \circ r$ is a Lefschetz fibration branched over 0 with regular fiber F , such that the monodromy of a counterclockwise meridian loop around 0 is a right-handed Dehn twist along a non-separating simple loop $\delta \subset \text{Int } F$.

Now, for any $i = 1, \dots, n$, let $\varphi_f(l_i) = \delta_i^{\varepsilon_i}$, where $l_i \subset A_i$ is a counterclockwise meridian loop around y_i , δ_i is the right-handed Dehn twist along $d_i \subset \text{Int } F$ and $\varepsilon_i = \pm 1$. Since f is allowable, d_i cannot separate F , so there exist diffeomorphisms $k_i = k'_i \times k''_i : S^1_- \times Z \rightarrow A_i \times Z$ and $\tilde{k}_i = \tilde{k}'_i \times \tilde{k}''_i : S^1_- \times F \rightarrow A_i \times F$ such that: k'_i preserve or invert the orientation according to ε_i ; k''_i is orientation preserving and

lifts to \tilde{k}_i'' with respect to q ; $\tilde{k}_i''(d) = d_i$. Then, assuming that the arcs $a_i = A_i \cap Y_0$ do not meet the 1-handles H_j , we can glue n copies of r to p_0 , by means of the diffeomorphisms k_i and \tilde{k}_i .

Calling p the branched covering of Y obtained in this way, we have that $\pi_Y \circ p$ is a Lefschetz fibration whose branch points and monodromy coincide with that ones of f , by proposition 1.2 and its proof. So, up to orientation preserving diffeomorphisms, $\pi_Y \circ p = f$ and in particular the total space of p is X . \square

REMARK 1.4. *Proposition 1.3 does not hold in general if $\text{Bd } Y = \emptyset$ (see [15] for hyperelliptic Lefschetz fibrations). In fact, to deal with this case, we should allow the braided surface S to have node and cusp singularities (cf. [33]). The connection requirement for F and $\text{Bd } F$ could perhaps be removed, by considering branched coverings of order greater than 3.*

We conclude this section by observing that, for a Lefschetz fibration $f : X \rightarrow B^2$, the condition of having connected fiber with connected boundary, does not imply any restriction on the total space X . This fact will be needed in the next section.

PROPOSITION 1.5. *If $f : X \rightarrow B^2$ is a Lefschetz fibration over B^2 , then the regular fiber of f is connected and there exists a Lefschetz fibration $g : X \rightarrow B^2$ whose fiber has connected boundary. Moreover, for f allowable and/or positive, we can take g allowable and/or positive as well.*

Proof. The connection of F follows immediately from the connection of X , since the monodromy of f is generated by Dehn twists, so it preserves the components of F . We also observe that, for the same reason, the monodromy of f fixes the boundary of F .

Now, if $\text{Bd } F = \emptyset$ or $\text{Bd } F$ is already connected, we can set $g = f$. Otherwise, in order to connect the boundary of F , we consider the following plumbing operation for Lefschetz fibrations with connected bounded fiber, which is analogous to the operation (A) introduced by Harer in [22] for open-book decomposition.

Let $F' = F \cup H$ the surface obtained by gluing an oriented band H to F (we are assuming $\text{Bd } F \neq \emptyset$) and $d \subset \text{Int } F'$ be a simple loop which goes once through H (we are also assuming F connected). Then, we consider the new Lefschetz fibration $f' : X' \rightarrow Y$ with regular fiber F' , branch points $y_1, \dots, y_n, y_{n+1} \in \text{Int } B^2$ and respective monodromies $\delta_1^{\varepsilon_1}, \dots, \delta_n^{\varepsilon_n}, \delta$, where y_1, \dots, y_n are the branch points of f , $\delta_1^{\varepsilon_1}, \dots, \delta_n^{\varepsilon_n}$ are the respective monodromies for f thought as Dehn twists of F' and δ is the right-handed Dehn twist along d .

By the definition of f' , we get $X' \cong X$, in fact X' can be obtained by adding to X a cancelling pair of handles: one 1-handle $B^2 \times H$ glued to $B^2 \times \text{Bd } F \subset \text{Bd } X$ (remember that the monodromy of f fixes $\text{Bd } F$), due to the change of the fiber, and one 2-handle attached along $\{s\} \times d \subset \{s\} \times G \subset \text{Bd}(X \cup (B^2 \times H))$ with $s \in S^1$, due to the new branch point y_{n+1} (cf. [15] and [23]). On the other hand, if $\text{Bd } F$ is not connected and the band H joins two different components of $\text{Bd } F$, then $\text{Bd } F'$ has one component less than $\text{Bd } F$ and d is non-separating in F' .

Then we can get the required Lefschetz fibration g from f , by iterating the plumbing operation, until the boundary of the fiber becomes connected. \square

REMARK 1.6. For a Lefschetz fibration $f = \pi_{B^2} \circ p$, with $p : X \rightarrow B^2 \times B^2$ simple covering branched over a braided surface $S \subset B^2 \times B^2$, a plumbing operation on f corresponds to a stabilization of S , consisting in the addition of one sheet connected to S by means of one positive twist point.

2. Stein surfaces

We recall that, a smooth real-valued function $f : X \rightarrow R$ on a complex manifold X is called *plurisubharmonic* (resp. *strictly plurisubharmonic*) iff the complex Hessian $Hf = (\partial^2 f / \partial z_i \partial \bar{z}_j)$ is everywhere positive semidefinite (resp. definite) for any local complex coordinates (z_1, \dots, z_n) . Of course, both these properties are invariant under biholomorphisms of X . Moreover, plurisubharmonicity (but not strict plurisubharmonicity) is preserved under composition with holomorphic functions on the right and with non-decreasing convex functions on the left (see [20] or [31]).

A *Stein surface* is a non-singular complex surface X which admits a proper strictly plurisubharmonic function $f : X \rightarrow [0, +\infty)$ such that $\text{Bd } X$ is a level set.

If $X \subset C^n$ is a non-singular complex surface properly embedded in C^n , then the restriction to X of the function $z \mapsto |z|^2$ is a proper strictly plurisubharmonic function, hence X is a Stein surface. In this way we get all the Stein surfaces without boundary, up to biholomorphisms, since any Stein surface without boundary can be properly holomorphically embedded in some C^n (see [18] or [20]).

If X is a Stein surface without boundary and $f : X \rightarrow [0, +\infty)$ is a proper strictly plurisubharmonic function, then the sublevel set $f^{-1}([0, c])$ is a compact Stein surface with boundary $f^{-1}(c)$, for any regular value $c > 0$. Any compact Stein surface has non-empty boundary and can be embedded in a Stein surface without boundary as a sublevel set of some proper plurisubharmonic function as above.

Any Stein surface X has a (possibly infinite) handle decomposition, induced by a plurisubharmonic Morse function, with handles of indices ≤ 2 (see [28]).

In particular, for X compact we get $X \cong X_1 \cup H_1 \cup \dots \cup H_m$, where X_1 is obtained by attaching 1-handles to B^4 and the H_i 's are 2-handle attached to X_1 . It turns that the H_i 's are attached to X_1 in a quite special way. In fact, the attaching knot $K_i \subset \text{Bd } X_1$ of each 2-handle H_i is Legendrian with respect to the standard contact structure of $\text{Bd } X_1 \cong \#_n S^1 \times S^2$ and the attaching framing is the Legendrian framing of K_i with one left-handed twist added (see [16] or [17] for more details).

We call *Legendrian* such a 2-handle H_i . For our aims, it will suffice to know how to represent Legendrian 2-handles in terms of framed links. The translation in the language of framed links is widely discussed in [16] and [17], so we limit ourselves to describe the final form of the resulting framed link.

We consider first decompositions without any 1-handles. In this case, the link $K_1 \cup \dots \cup K_m \subset S^3$ can be represented by a *front projection*, that is a link diagram with

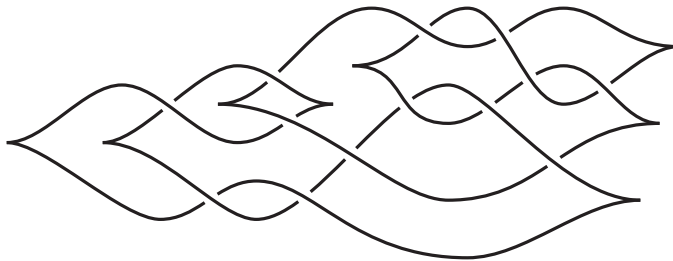

FIGURE 1.

horizontal cusps instead of vertical tangencies, such that at each crossing the arc with most negative slope crosses in front (cf. figure 1). Then, the Legendrian framing of K_i is given by the *blackboard framing* associated to the diagram with one left-twist added for each right cusp (see [9]).

In the general case, we represent the 1-handles by dotted circles stacked over the front projection of a Legendrian tangle, in such a way that the diagram of the link $K_1, \dots, K_m \subset \#_n S^1 \times S^2$ is obtained by connecting the endpoints of the tangle by means of parallel arcs, each one of which pass once through a dotted circle (cf. figure 2). Again the Legendrian framing of K_i is given by the blackboard framing associated to the diagram with one left-twist added for each right cusp.

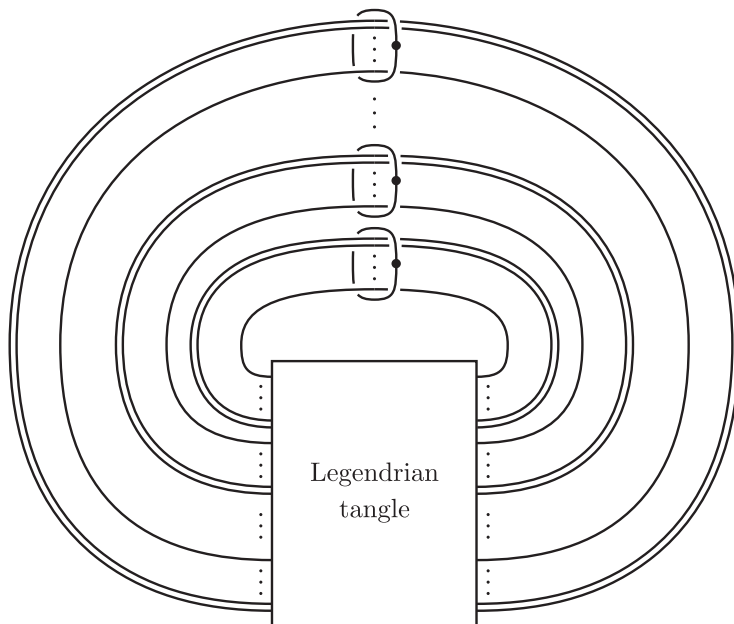

FIGURE 2.

This way of representing Legendrian 2-handles is the one suggested in [16], starting from a *Legendrian link diagram in standard form* (cf. definition 2.1 of [16] and the subsequent discussion at page 634).

In order to get a more convenient representation for our purpose, we modify the handle decomposition by twisting once negatively each 1-handle. After this change, all the diagram can be drawn as a front projection with some arcs passing through the dotted circles, the Legendrian framing still being the blackboard framing with one left-twist added for each right cusp (cf. figure 3).

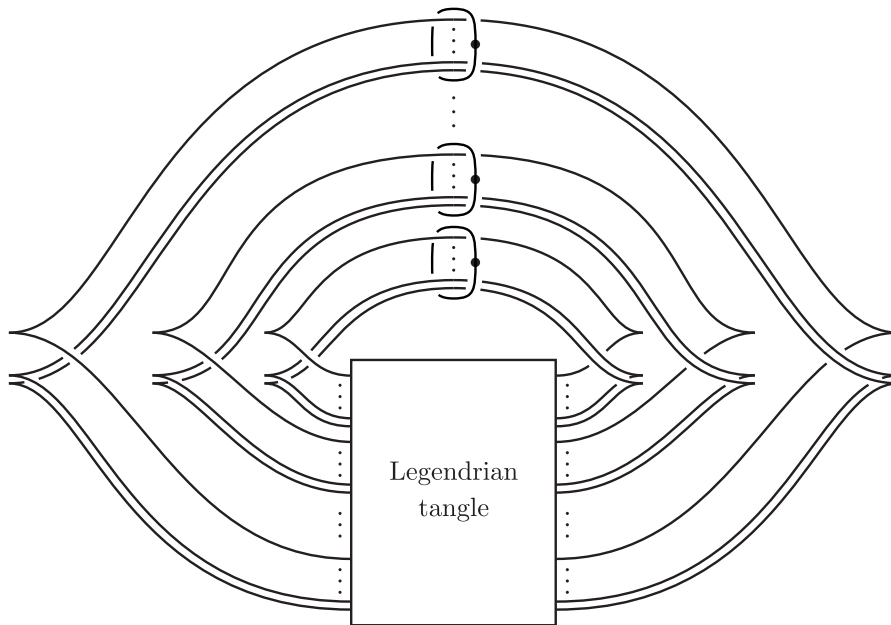

FIGURE 3.

The following theorem says that all the diagrams considered above do in fact represent handle decompositions of Stein surfaces. The proof of this fact is implicitly contained in [10] (see also [16]).

THEOREM 2.1 (ELIASHBERG). *A smooth oriented compact 4-manifold with boundary is a Stein surface, up to orientation preserving diffeomorphisms, iff it has a handle decomposition $X_1 \cup H_1 \cup \dots \cup H_m$, where X_1 consists of 0- and 1-handles and the H_i 's are Legendrian 2-handles attached to X_1 .*

Now, we come to the main theorem of this paper, which characterizes compact Stein surfaces in terms of branched covering and Lefschetz fibration. For proving it, we will use the fact that any compact Stein surface has a handle decomposition as in theorem 2.1, but not the viceversa (cf. remark 2.3).

THEOREM 2.2. *Given a smooth oriented connected compact 4-manifold X with boundary, the following statements are equivalent up to orientation preserving diffeomorphisms:*

- (a) X is a Stein surface;
- (b) X is an analytic branched covering of B^4 ;
- (c) X is a covering of $B^2 \times B^2$ branched over a positive braided surface;

(d) X is a positive allowable Lefschetz fibration over B^2 with bounded regular fiber.

Proof. (b) \Rightarrow (a). Given an analytic branched covering $p : X \rightarrow B^4$, we have that $\text{Int } X$ is a Stein surface without boundary, since the restriction of p to $\text{Int } X$ is a finite holomorphic map (see [19], p. 125). Let $f : \text{Int } X \rightarrow \mathbb{R}$ be a proper strictly plurisubharmonic function and $g : \text{Int } X \rightarrow \mathbb{R}$ be the plurisubharmonic function defined by $g(x) = 1/(1 - \|p(x)\|^2)$. By the transversality of the branch set of p with respect to S^3 , we have $X \cong g^{-1}([0, c])$ for $c > 0$ (regular value) sufficiently large. Now, the function $h = g + \varepsilon f$ is proper and strictly plurisubharmonic on $\text{Int } X$, for every $\varepsilon > 0$. By choosing ε sufficiently small, we have also $X \cong h^{-1}([0, c])$, hence X is a Stein surface with boundary.

(c) \Rightarrow (b). Let $p : X \rightarrow B^2 \times B^2$ a covering branched over a positive braided surface $S \subset B^2 \times B^2$. By theorem 1.1, p is analytically branched (see [7] for the definition). Then, by a theorem of Grauert and Remmert [18] (cf. [7]), p is a true analytic covering of $B^2 \times B^2 \cong B^4$.

(d) \Rightarrow (c). This implication follows immediately from propositions 1.5 and 1.3.

(a) \Rightarrow (d). Let X be a Stein surface with boundary. By proposition 1.2, it is enough to find a simple branched covering $p : X \rightarrow B^2 \times B^2$, whose branch set is a positive braided surface. We start with a handle decomposition $X_1 \cup H_1 \cup \dots \cup H_m$, where X_1 consists of 0- and 1-handles and the H_i 's are Legendrian 2-handles attached to X_1 . In order to make the proof easier to read, we consider first the special case of one 2-handle attached to B^4 . This allows us to explain the crucial ideas of the proof, avoiding many technical details. Then, we show how to deal simultaneously with different 2-handles and how to work the presence of 1-handles.

Case 1: no 1-handles and one 2-handle. In this case, we have $X \cong B^4 \cup H$, for a Legendrian 2-handle H . Let $K \subset S^3$ the Legendrian attaching knot of H . Then, K can be represented by a front projection diagram \mathcal{D} as described above. An example of such a diagram is depicted in figure 4; all the diagrams in the following figures 5, 6, 9 and 12 have to be considered as successive modifications of this one.

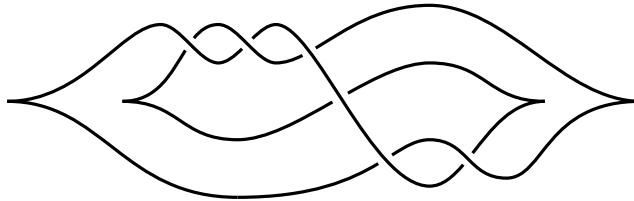

FIGURE 4.

First of all, we smooth all the cusps and add a negative kink at each right one. In this way, we get a new diagram \mathcal{E} of K (in fact of a transversal knot parallel to K , cf. [11]) whose blackboard framing represent the Legendrian framing of K (see figure 5).

Then, we redraw \mathcal{E} as a polygonal diagram with smoothed corners and edges of slope $+1$ or -1 , paying attention to not introduce local minima or maxima for the

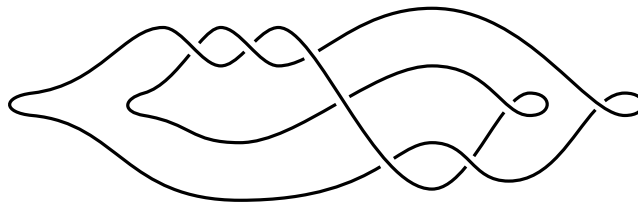

FIGURE 5.

abscissa other than the ones coming from cusps, and rotate everything of $-\pi/4$ radians. The resulting diagram \mathcal{F} (see figure 6) has the following properties: all the edges of

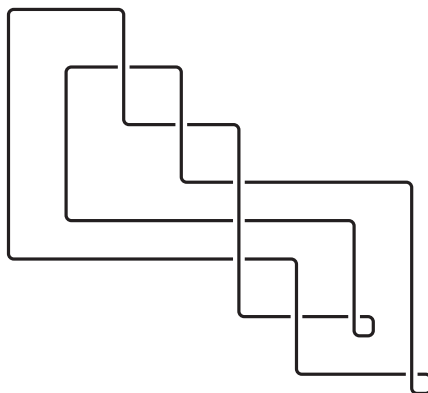

FIGURE 6.

\mathcal{F} are horizontal or vertical; at each crossing the vertical edge crosses in front; any vertical edge belongs to one of the three types shown in figure 7, depending on the local structure of \mathcal{F} in a neighborhood of it.

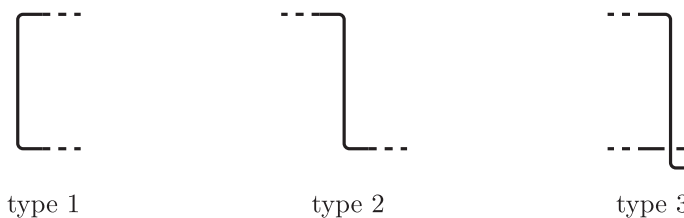

FIGURE 7.

Finally, we apply to \mathcal{F} the moves described in figure 8, in order to get a new diagram \mathcal{G} , satisfying the same properties of \mathcal{F} , with all the vertical edges of types 1 and 3 respectively in the left-most and the right-most positions. Of course, also \mathcal{G} is a diagram of K (up to smooth equivalence) whose blackboard framing represent the Legendrian framing of K .

The vertical edges of the types 1 and 3 come respectively from the left cusps and the right cusps of the diagram \mathcal{D} . Hence, putting $c = \#(\text{left cusps of } \mathcal{D}) =$

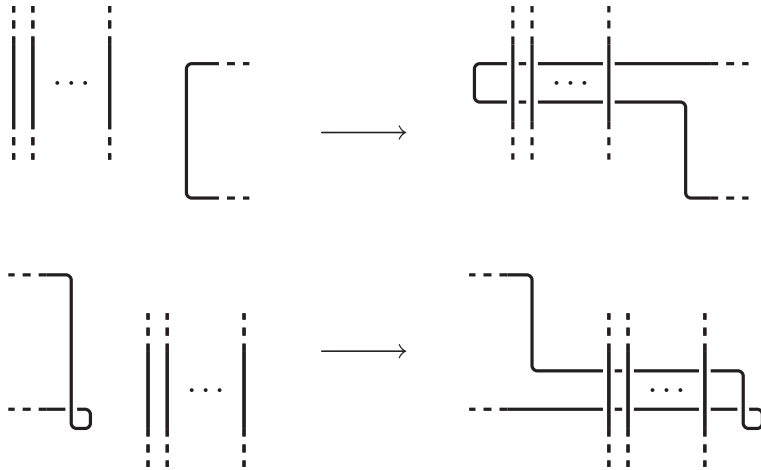

FIGURE 8.

$\#(\text{right cusps of } \mathcal{D})$, we have exactly c vertical edges of type 1 and c vertical edges of type 3. Let V_1, \dots, V_{2c} be all such edges, numbered starting from the uppermost one of type 1 and following the orientation of the diagram which induces on it the up-down orientation. We can assume that \mathcal{G} has been constructed in such a way that, going from left to right, we have in the order $V_1, V_3, \dots, V_{2c-1}$ on the left side of \mathcal{G} and V_2, V_4, \dots, V_{2c} on the right side of \mathcal{G} (see figure 9).

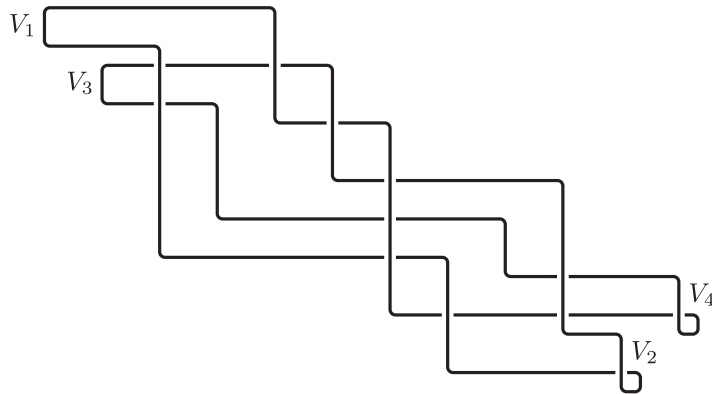

FIGURE 9.

Now, we consider the simple branched covering $p_0 : B^2 \times B^2 \rightarrow B^2 \times B^2$ with $2c + 1$ sheets labelled from 0 to $2c$, whose branch set consists of disks D_1, \dots, D_{2c} parallel to the second factor and whose monodromy around D_i is $(i-1 \ i)$, for every $i = 1, \dots, 2c$. We think D_1, \dots, D_{2c} as parallel disks in $R^3 \subset S^3 = \text{Bd } B^4 \cong B^2 \times B^2$ with interiors pushed inside B^4 and represent their boundaries as vertical lines L_1, \dots, L_{2c} in the diagram. Furthermore, we assume that: $K \cap D_1 = V_1 \subset L_1$ and $K \cap D_i = \emptyset$ for $i > 1$; L_i lies immediately on the right (resp. left) of V_i for i odd (resp.

even); \mathcal{G} crosses in front of L_i at all the crossings except the upper (resp. lower) one near to V_i for $i > 1$ odd (resp. even), as shown in figure 10.

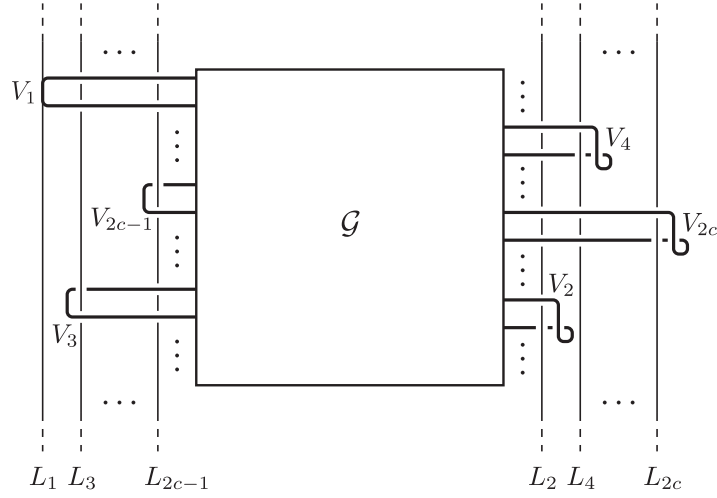

FIGURE 10.

Let V'_1, \dots, V'_{2c} be new vertical edges with the following properties: V'_i is collinear with V_i for any $i = 1, \dots, 2c$; all the V'_i 's lies above all the V_j 's; the projections of the edges V'_2, \dots, V'_{2c} on L_1 have disjoint interiors and their union coincides with V'_1 ; the bottom end of V'_i and the top end of V'_{i+1} have the same ordinate for any $i = 2, \dots, 2c - 1$.

Then, we join the V'_i 's by horizontal edges, in order to get a trivial knot diagram linked with the L_i 's as shown in figure 11, where the horizontal edges crosses behind L_i at all the crossings except the lower one near V'_i and the lowermost one too if i is odd, for any $i > 1$.

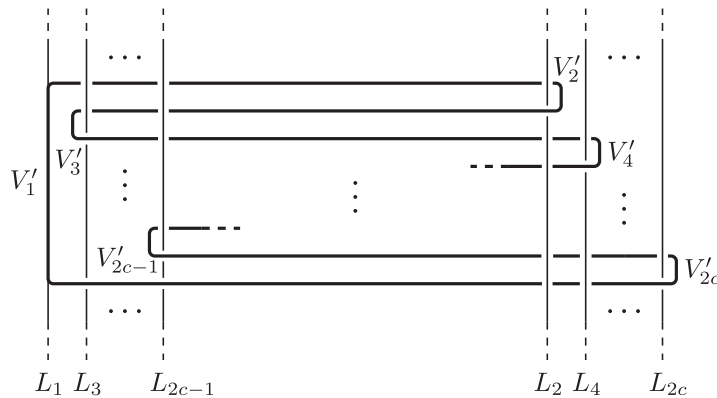

FIGURE 11.

Finally, we connect this diagram with \mathcal{G} by means of a vertical band as show in figure 12, in such a way that the resulting diagram \mathcal{H} is again a diagram of K

intersecting L_1 along an arc and the corresponding blackboard framing still represent the Legendrian framing of K .

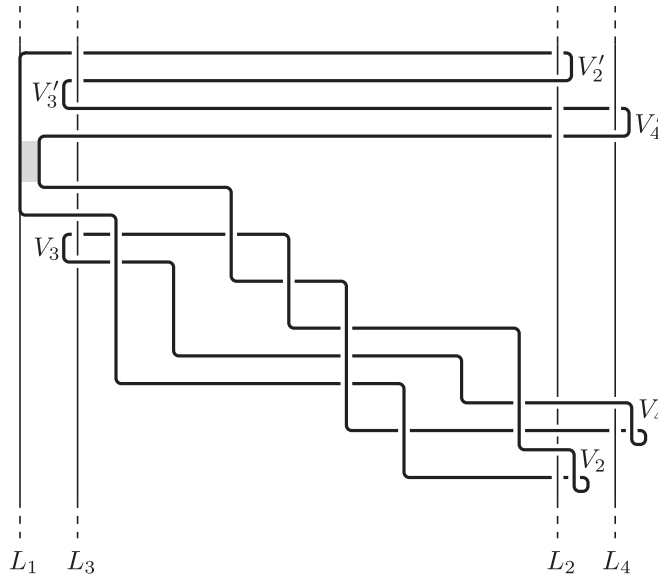

FIGURE 12.

Let $A \subset K$ be the arc represented by $\text{Cl}(\mathcal{H} - \mathcal{L}_\infty)$. Then $p_0^{-1}(A)$ is the disjoint union of $2c - 1$ arcs and a knot $\tilde{K} \subset S^3$ equivalent to K by an ambient isotopy of S^3 , which makes the lifting of the blackboard framing along A into the Legendrian framing of \tilde{K} with one left-twist added. In fact, by unfolding the sheets of p_0 we get a diagram of \tilde{K} , which is the connected sum of a copy of \mathcal{H} in the sheet 0 with a trivial loop going forth and back in the other sheets. Moreover, the unfolding process, applied to the lifting of the blackboard framing along A , gives us a framing which coincides with the blackboard one except for a right (resp. left) half-twist for each vertical segment V_i or V'_i with $i = 2, \dots, 2c$ odd (resp. even). The knot \tilde{K} obtained starting from figure 12, together with the lifting of the blackboard framing, is represented in figure 13.

At this point, the method introduced by Montesinos in [29] (see also [30]) allows us to construct a $(2c + 1)$ -fold simple branched covering $p : M \rightarrow B^2 \times B^2$, whose branch set and monodromy coincide with the ones of p_0 , except for the attachment to D_1 of a ribbon band B , which represent the blackboard framing along A (see figure 14 for the branch set arising from the diagram of figure 12). Then, denoting by $F_1 \subset B^2 \times B^2$ the ribbon annulus resulting from this surgery on D_1 , the branch set of p is the regularly embedded surface $F_1 \cup D_2 \cup \dots \cup D_{2c} \subset B^2 \times B^2$.

To conclude this part of the proof, we see that the branch set of p is isotopically equivalent to a positive braided surface (over the second factor). In fact, $D_2 \cup \dots \cup D_{2c}$ is already braided (without any twist point) and F_1 can be made into a braided surface by adapting the Rudolph's braiding process (see [35]) in such a way that all the D_i 's are left fixed. Moreover, due to the special form of F_1 , all the twist points arising in the process turn out to be positive.

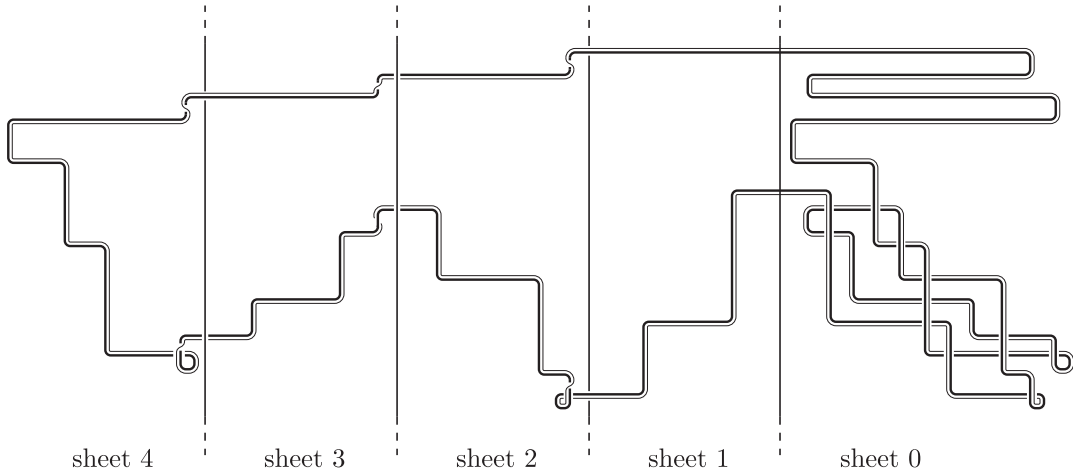

FIGURE 13.

Namely, we deform the parts of the band B corresponding to vertical edges of A of types 1, 2 and 3 (including the V_i 's with i odd), one by one from left to right, to new disks parallel to the D_i 's, successively putted in front of the previous ones, as shown in figure 15.

After all these deformations have been performed, we are left with a certain number of parallel disks and bands between them (in particular, some of such bands correspond to the edges V_i with i even). All such bands have the form depicted in the left part of figure 16 (up to conjugation), each one being linked to an arbitrary number (possibly

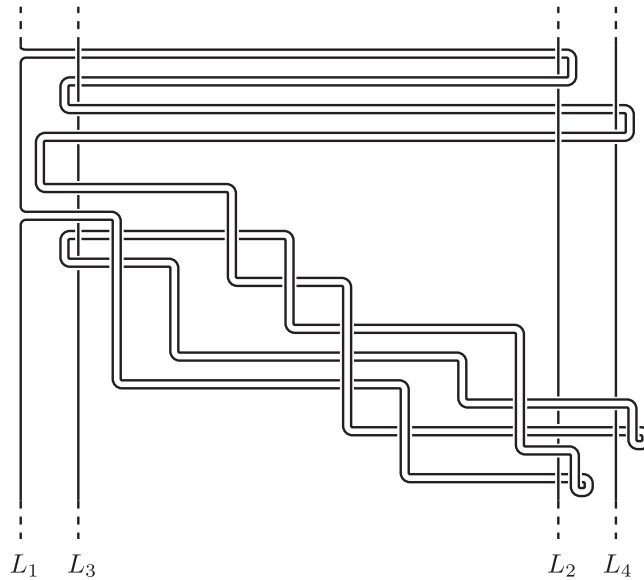

FIGURE 14.

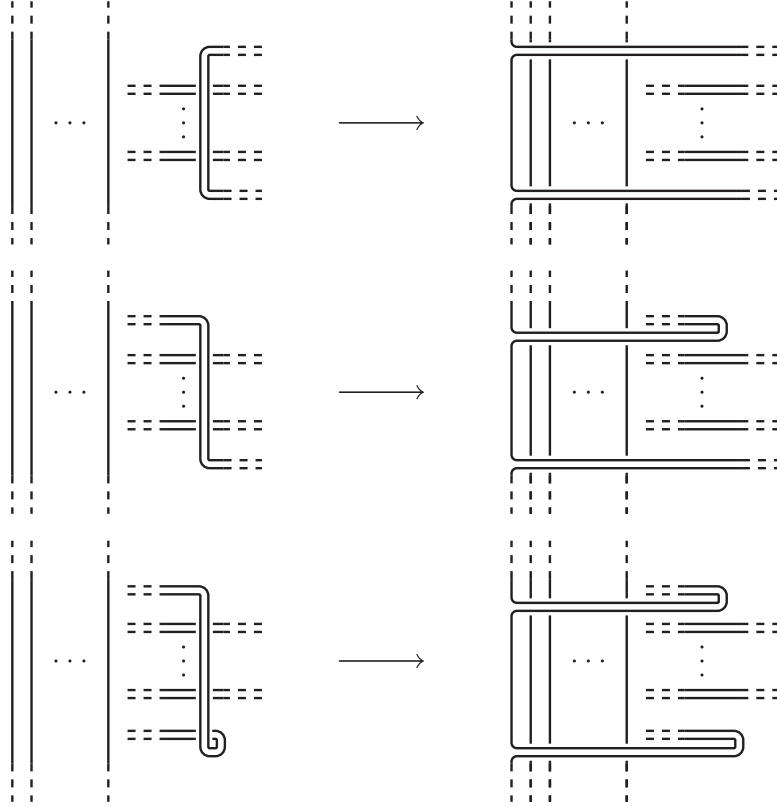

FIGURE 15.

none) of vertical lines. The right part of figure 16, shows how such a band can isotoped to a braided one with a positive twist point (cf. [35]).

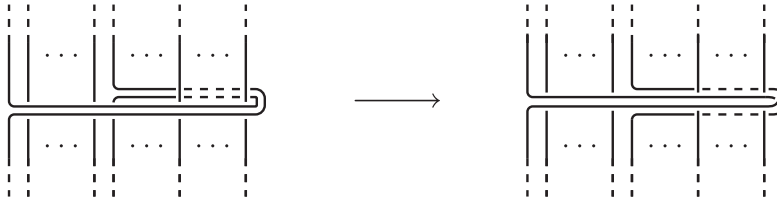

FIGURE 16.

Case 2: no 1-handles. This time we have $X \cong B^4 \cup H_1 \cup \dots \cup H_m$, for some Legendrian 2-handles H_1, \dots, H_m . Let \mathcal{D} be a front projection diagram of the Legendrian link $K = K_1 \cup \dots \cup K_m \subset S^3$, where K_j is the attaching knot of H_j . New diagrams \mathcal{E} , \mathcal{F} and \mathcal{G} of K can be obtained starting from \mathcal{D} as in case 1; we use the subscript j for the part of a diagram corresponding to K_j . Then, putting $c_j = \#(\text{left cusps of } \mathcal{D}_j) = \#(\text{right cusps of } \mathcal{D}_j)$ and $s_j = c_1 + \dots + c_j$, we denote by V_1, \dots, V_{2s_m} the vertical edges of types 1 and 3 of \mathcal{G} .

We assume the V_i 's and the K_j 's numbered in such a way that: $V_{2s_{j-1}+1}, \dots, V_{2s_j}$ belong to \mathcal{G}_j and are ordered in case 1 (starting from the uppermost of type 1), for

any $j = 1, \dots, m$; the first edges of the \mathcal{G}_j 's have increasing indices from bottom to top, that is we have in the order $V_1, V_{2s_1+1}, \dots, V_{2s_{m-1}+1}$. We also assume the V_i 's placed so that, going from left to right, we have in the order $V_1, V_{2s_1+1}, \dots, V_{2s_{m-1}+1}$ $V_3, V_5, \dots, V_{2s_1-1}, \dots, V_{2s_1+1}, V_{2s_1+3}, \dots, V_{2s_2-1}, \dots, V_{2s_{m-1}+1}$ $V_{2s_{m-1}+3}, \dots, V_{2s_m-1}$ on the left side of \mathcal{G} and $V_2, V_4, \dots, V_{2s_m}$ on the right side of \mathcal{G} .

Then, we consider the simple branched covering $p_0 : B^2 \times B^2 \rightarrow B^2 \times B^2$ with $2s_m + 1$ sheets labelled from 0 to $2s_m$, whose branch set consists of disks D_1, \dots, D_{2s_m} parallel to the second factor and whose monodromy around D_i is $(0 \ 2s_j+1)$ if $i = 2s_j+1$ and $(i-1 \ i)$ otherwise. As above, we think the D_i 's as parallel disks in R^3 with the interiors pushed inside B^4 and represent their boundaries as vertical lines L_1, \dots, L_{2s_m} in the diagram. Furthermore, we assume that: $K \cap D_{2s_{j-1}+1} = V_{2s_{j-1}+1} \subset L_{2s_{j-1}+1}$ for any $j = 1, \dots, m$; $K \cap D_i = \emptyset$ for all the other D_i 's; the positions of the L_i 's and the crossings of \mathcal{G} with them are as in case 1.

Finally, we change each \mathcal{G}_j into a new diagram \mathcal{H}_j , by the same construction we have performed in the previous case on the entire diagram \mathcal{G} for obtaining \mathcal{H} . Thanks to the choices made above about the position of the V_i 's, we can do that without creating any extra crossing. In other words, the new parts of the diagram, representing the unknots and the bands connecting them with the K_j 's, do not cross each other nor the remaining part of the old diagram \mathcal{G} . Moreover, we let the unknot diagram arising from \mathcal{G}_j cross in front of all the L_i 's with $i \neq 2s_{j-1} + 1, \dots, 2s_j$.

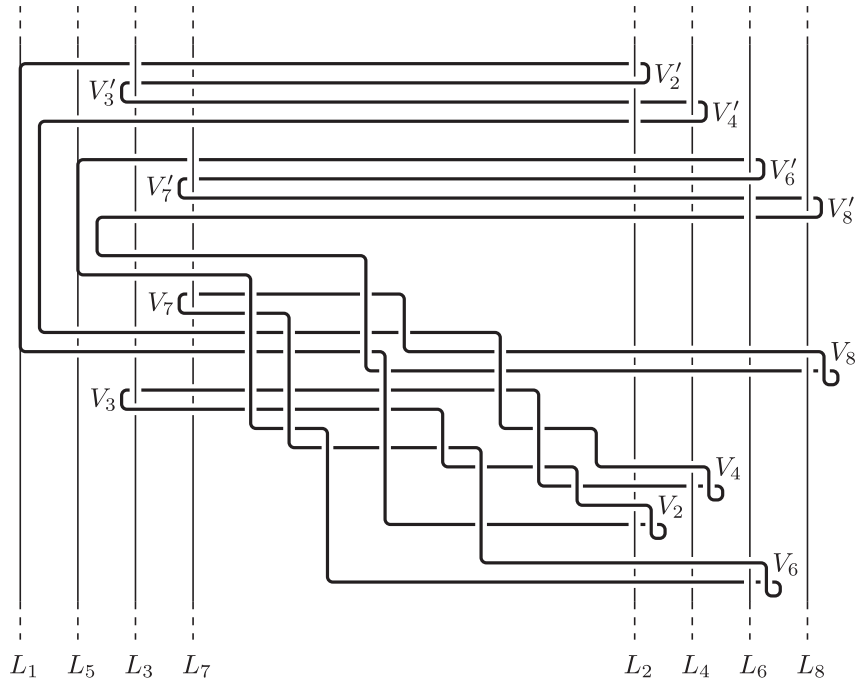

FIGURE 17.

In this way, we get a new diagram $\mathcal{H} = \mathcal{H}_\infty \cup \dots \cup \mathcal{H}_\uparrow$ of the link K , such that each \mathcal{H}_j meets $L_1 \cup \dots \cup L_{2s_m}$ along an arc in $L_{2s_{j-1}+1}$ and it is a diagram of K_j

whose blackboard framing represent the Legendrian framing of K_j (see figure 17 for the diagram \mathcal{H} obtained starting with the diagram \mathcal{D} of figure 1).

Let $A = A_1 \cup \dots \cup A_m$, where $A_j \subset K_j$ is the arc represented by $\text{Cl}(\mathcal{H} | -\mathcal{L}_{\infty} + \infty)$. Then, $p_0^{-1}(A)$ is the disjoint union of some arcs and a link $\tilde{K} \subset S^3$ equivalent to K by an ambient isotopy of S^3 , which makes the lifting of the blackboard framing along each A_j into the Legendrian framing of K_j with one left-twist added. We can prove this fact as in case 1, after observing that, as in that case, \tilde{K} is essentially contained in the sheet 0, being the component \tilde{K}_j of \tilde{K} over K_j contained in the sheets $0, 2s_{j-1} + 1, \dots, 2s_j$, so that different \tilde{K}_j 's interact only in the sheet 0.

In order to get a $(2s_m + 1)$ -fold simple branched covering $p : M \rightarrow B^2 \times B^2$, we modify p_0 by attaching to each disk $D_{2s_{j-1}+1}$ a ribbon band B_j , which represents the blackboard framing along A_j and is disjoint from the other D_i 's. Then, the branch set of p is a regularly embedded surface in $B^2 \times B^2$, consisting of $2s_m - m$ disks and m annuli, that can be made into a positive braided surface, by the same method used in case 1.

General case. Let $X = X_1 \cup H_1 \cup \dots \cup H_m$, where X_1 is obtained attaching n 1-handles to B^4 and the H_j 's are Legendrian 2-handles. We represent such handle decomposition by a diagram \mathcal{D} as in figure 3 and we get diagrams \mathcal{E} and \mathcal{F} of K as in the previous cases, expanding the dotted circles behind the diagram and representing them by dotted vertical lines. So, \mathcal{F} crosses in front of these vertical lines at all the crossings, except the ones corresponding to passages of the link K through the 1-handles, as shown in figure 18.

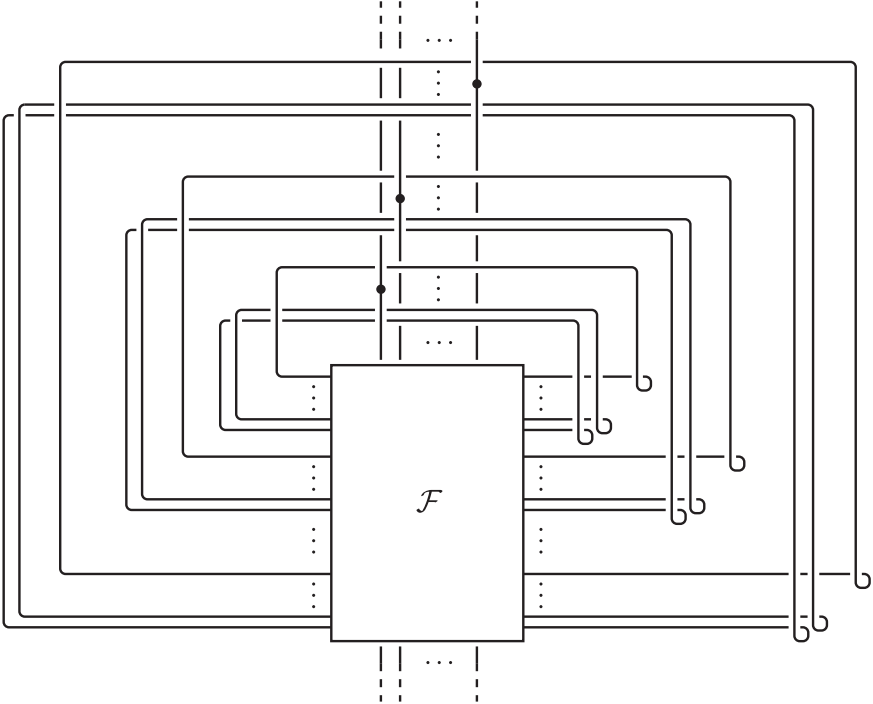

FIGURE 18.

Then, we push away from \mathcal{F} all the vertical edges of type 1 and 3 (including the ones needed to realize the arcs which go through the 1-handles), by using the moves of figure 8. In this way, we get a diagram \mathcal{G} as in the previous case 2. We also assume such vertical edges V_1, \dots, V_{2s_m} , as well as the subdiagrams $\mathcal{G}_\infty, \dots, \mathcal{G}_\uparrow$, numbered and placed as in that case.

Now, let $p_0 : B^2 \times B^2 \rightarrow B^2 \times B^2$ the $(2s_m+1)$ -simple branched covering constructed as in case 2, starting from the actual diagram \mathcal{G} , without taking into account the dotted components. In order to make p_0 into a simple branched covering $p_1 : X_1 \rightarrow B^2 \times B^2$, we add to it n sheets labelled from $2s_m + 1$ to $2s_m + n$ and $2n$ branch disks $D_{2s_m+1}, \dots, D_{2s_m+2n}$ parallel to the previous ones, whose meridians have monodromies $(0 \ 2s_m+1), (0 \ 2s_m+1), \dots, (0 \ 2s_m+n), (0 \ 2s_m+n)$. Assuming also these new disks as parallel disks in $R^3 \subset B^2 \times B^2$ with the interiors pushed inside B^4 , we can represent their boundaries in the diagram by $2n$ vertical lines $L_{2s_m+1}, \dots, L_{2s_m+2n}$.

We think the k -th 1-handle of X_1 , being realized by the $(2s_m+k)$ -th sheet together with the pair of branch disks $D_{2s_m+2k-1}, D_{2s_m+2k}$ (cf. [29]). Then, we draw the lines L_{2s_m+2k-1} and L_{2s_m+2k} in correspondence of the k -th dotted vertical line from the left in figure 18, letting a horizontal edge of \mathcal{G} cross in front of them iff it crosses in front of such dotted line (see figure 19).

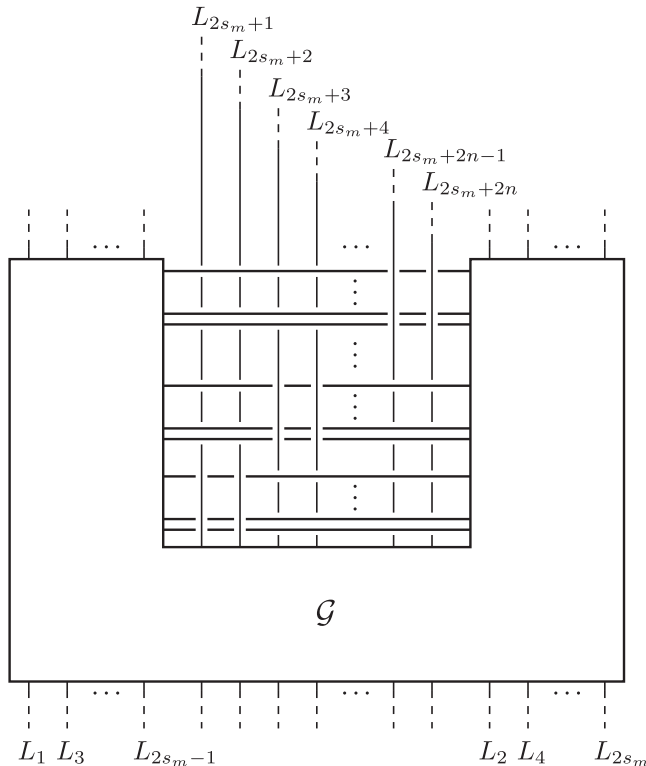

FIGURE 19.

At this point, we construct another diagram \mathcal{H} of K , by modifying \mathcal{G} as in case 2 and letting all the new horizontal edges introduced in the construction cross in front of the vertical lines $L_{2s_m+1}, \dots, L_{2s_m+2n}$.

Finally, we define the disjoint union of arcs $A \subset S^3$ as above and see, in the same way, that $p_1^{-1}(A)$ is the disjoint union of some arcs and a link $\tilde{K} \subset X_1$ equivalent to K and that the blackboard framing along each A_j lifts to the right framing of \tilde{K}_j . Hence, by attaching to each disk $D_{2s_{j-1}+1}$ a ribbon band B_j as above, we change p_1 into a $(2s_m + n + 1)$ -fold simple branched covering $p : M \rightarrow B^2 \times B^2$. The branch set of p is a regularly embedded surface in $B^2 \times B^2$, consisting of $2s_m + 2n - m$ disks and m annuli, that can be made into a positive braided surface, again by the same method used in case 1. \square

REMARK 2.3. *In proving the implication (a) \Rightarrow (d), we used the hypothesis only to guarantee the existence of a Legendrian handle decomposition. Then, our proof of theorem 2.2 also provides a new proof of the “if” part of theorem 2.1.*

Moreover, we observe that the positivity condition in (c) and (d) is directly related to the framing properties of Legendrian handles. In fact, by forgetting such conditions, we have that: for a 4-manifold as in the statement, having a handle decomposition with handles of indices ≤ 2 is equivalent to being a covering of $B^2 \times B^2$ branched over a braided surface or a Lefschetz fibration over B^2 with bounded regular fiber (cf. [21] or [17]).

3. Stein fillability

In this section we apply our main theorem in order to characterize Stein fillable 3-manifolds in terms of open books. First of all, we briefly recall some definitions and basic facts.

A smooth oriented closed 3-manifold M is called *Stein fillable* iff it is the oriented boundary of some compact Stein surface X (up to orientation preserving diffeomorphisms). By [5], any strictly pseudoconvex boundary of a compact complex surface is Stein fillable. Stein fillability is relevant in the context of contact topology of 3-manifolds, since the natural contact structure on $M = \text{Bd } X$, given by the complex tangencies, turns out to be tight (see [11] or [16]). The Eliashberg’s characterization of Stein surfaces (theorem 2.1) has been exploited by Gompf in [16] for producing several families of fillable 3-manifolds, given in terms of framed links. Using Seiberg-Witten theory, Lisca proved in [26] that the Poincaré homology sphere with reversed orientation is not Stein fillable (in fact, not symplectically semi-fillable), as already conjectured in [16]. Theorem 3.4 below, together with the Harer’s equivalence theorem for fibered links (see [22]), could enable us to define an effectively computable obstruction to Stein fillability.

On the other hand, given a smooth oriented connected compact surface F with non-empty boundary and a mapping $\varphi \in \text{Map}(F, \text{Bd } F)$, the *open book* with *page* F and *monodromy* φ is the space $M_\varphi = T(\varphi) \cup_k \text{Bd } F$, where $T(\varphi)$ is the mapping torus of

φ and the attaching map $k : T(\varphi|_{\text{Bd } F}) \cong \text{Bd } F \times S^1 \rightarrow \text{Bd } F$ is the projection onto the first factor. It turns out that M_φ is a smooth oriented closed 3-manifold (well defined up to orientation preserving diffeomorphisms) and that $L_\varphi = \text{Bd } F \subset M_\varphi$ (the *binding* of the open book) is a fibered link in M_φ (cf. [22]). In fact, any such a 3-manifolds M is orientation preserving diffeomorphic to some open book with connected binding (see [2]). We say that M_φ is a *positive* open book iff its monodromy φ is a product of right-handed Dehn twists.

The following propositions tell us that the open books coincide, up to orientation preserving diffeomorphisms, with the boundaries of Lefschetz fibrations over B^2 .

PROPOSITION 3.1. *Let $f : X \rightarrow B^2$ be a Lefschetz fibration whose regular fiber F has non-empty boundary. Then $\text{Bd } X$ is orientation preserving diffeomorphic to the open book M_φ with page F and monodromy $\varphi_f(l) = \varphi$, where l is the counterclockwise loop along S^1 .*

Proof. Let $y_1, \dots, y_n \in \text{Int } B^2$ the branch points of f and l_1, \dots, l_n meridian loops around them, such that $l_1 \dots l_n = l$ in $\pi_1(B^2 - \{y_1, \dots, y_n\}, *)$. Putting $T = f^{-1}(S^1)$, we have that the restriction $f|_T : T \rightarrow S^1$ is a locally trivial bundle with fibre F and monodromy $\varphi_f \circ i_*$, where i_* is the homomorphism induced by the inclusion of S^1 into the complement of the branch points $B^2 - \{y_1, \dots, y_n\}$. Then, T is orientation preserving diffeomorphic to the mapping torus $T(\varphi)$ of the mapping $\varphi = \varphi_f(l) = \varphi_f(l_1) \dots \varphi_f(l_n) \in \text{Map}(F, \text{Bd } F)$. On the other hand, $T' = \text{Cl}(\text{Bd } X - T) \cong B^2 \times \text{Bd } F$, since the restriction $f|_{T'} : T' \rightarrow B^2$ is a (locally) trivial bundle with fiber $\text{Bd } F$. So, we conclude that $\text{Bd } X = T \cup_{\text{Bd}} T' \cong M_\varphi$. \square

PROPOSITION 3.2. *For any open book M_φ with page F there exists a Lefschetz fibration $f : X \rightarrow B^2$ with regular fiber F , such that $\text{Bd } X \cong M_\varphi$. Moreover, we can choose f allowable if $\text{Bd } F$ is connected and positive if M_φ is a positive open book.*

Proof. Given a open book M_φ with page F , we can write $\varphi = \delta_1^{\varepsilon_1} \dots \delta_n^{\varepsilon_n}$, with δ_i right-handed Dehn twist along $d_i \subset \text{Int } F$ and $\varepsilon_i = \pm 1$. Then, fixed $y_1, \dots, y_n \in \text{Int } B^2$ and l_1, \dots, l_n meridian loops around them, such that $l_1 \dots l_n = l$ in $\pi_1(B^2 - \{y_1, \dots, y_n\}, *)$, we consider the Lefschetz fibration $f : X \rightarrow B^2$ determined by the branch points y_1, \dots, y_n and the monodromies $\varphi_f(l_i) = \delta_i^{\varepsilon_i}$ for $i = 1, \dots, n$ (cf. section 1). By proposition 3.1, we have $\text{Bd } X \cong M$.

For the second part of the proposition, observe that we can choose the d_i 's non-separating if $\text{Bd } F$ connected and the ε_i 's positive if M_φ is a positive open book. The following lemma 3.3 guarantees that such choices can be made simultaneously. \square

LEMMA 3.3. *Let F be an oriented connected compact surface with non-empty connected boundary and let δ be the right-handed Dehn twist along a simple loop $d \subset \text{Int } F$ parallel to $\text{Bd } F$. Then, there exist right-handed Dehn twists $\delta_1, \dots, \delta_n$ along non-separating simple loops d_1, \dots, d_n , such that $\delta = \delta_1 \dots \delta_n$ in $\text{Map}(F, \text{Bd } F)$.*

Proof. Looking at the double branched covering $p : F \rightarrow B^2$ shown in figure 20, we see that d covers twice the loop $e \subset \text{Int } B^2$ encircling all the $2g+1$ branch points, where g denotes the genus of F . Then δ is the lifting of a double right-handed twist along e .

By expressing the corresponding braid in terms of the standard generators, it can be easily realized that $\delta = (\alpha_1\beta_1 \dots \alpha_g\beta_g)^{4g+2}$, where α_i and β_i are the right-handed Dehn twists along the loops a_i and b_i depicted in the figure. \square

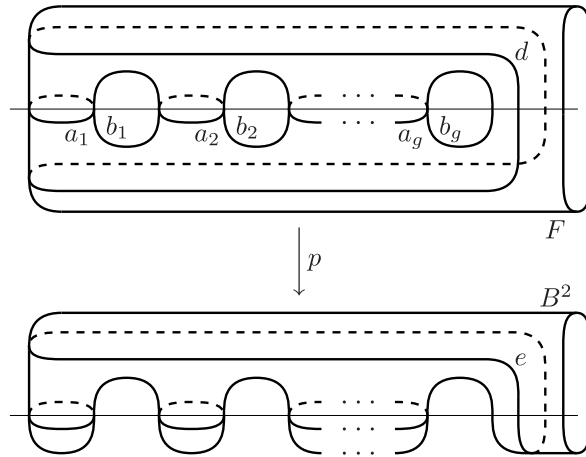

FIGURE 20.

Now, we are ready to give our fillability criterion.

THEOREM 3.4. *A smooth oriented closed 3-manifold is Stein fillable iff it is orientation preserving diffeomorphic to a positive open-book.*

Proof. By theorem 2.2 and proposition 3.1, the oriented boundary of any compact Stein surface is orientation preserving diffeomorphic to a positive open book. Vice-versa, given a positive open book M_φ , we can assume, up to the plumbing operation (A) introduced in [22] (cf. proof of proposition 1.5 above), that the binding of M_φ is connected. Then, by proposition 3.2 and theorem 2.2, M_φ is the oriented boundary of a compact Stein surface. \square

COROLLARY 3.5. *For any smooth oriented closed 3-manifolds M and any fibered knot $K \subset M$, there is a (possibly trivial) surgery along K which makes M into a Stein fillable 3-manifold.*

Proof. Let M_φ be an open book with page F and binding $L_\varphi \subset M_\varphi$, such that (M, K) is orientation preserving diffeomorphic to (M_φ, L_φ) . Since $\text{Map}(F, \text{Bd } F)$ is generated by Dehn twists along non-separating simple loops, we can express φ as a product of such twists. Now, by lemma 3.3, any left-handed twist along a non-separating loop can be obtained as a product of some right-handed twists and of δ^{-1} . In fact, using the notations of lemma 3.3, this is true for the loop $\delta_1^{-1} = \delta_2 \dots \delta_n \delta^{-1}$, hence the same holds for any non-separating simple loop in $\text{Int } F$, being all such loops equivalent. Then, we have $\varphi = \psi \delta^{-k}$, with ψ a product of right-handed Dehn twists and $k \geq 0$, because δ is a central element of $\text{Map}(F, \text{Bd } F)$. So, we can surgery M along K in order to get a new 3-manifold M' , orientation preserving diffeomorphic to the positive open book M_ψ , which is Stein fillable by theorem 3.4. \square

References

- [1] J. Amorós, F. Bogomolov, L. Katzarkov and T. Pantev, *Symplectic Lefschetz fibrations with arbitrary fundamental groups*, preprint 1998.
- [2] I. Bernstein and A. L. Edmonds, *On the construction of branched coverings of low-dimensional manifolds*, Trans. Amer. Math. Soc. **247** (1979), 87–124.
- [3] J. S. Birman, *Braids, link, and mapping class groups*, Annals of Mathematics Studies **82**, Princeton Univ. Press 1974.
- [4] J. S. Birman and B. Wajnryb, *3-fold branched coverings and the mapping class group of a surface*, in “Geometry and Topology”, Lecture Notes in Mathematics **1167**, Springer-Verlag 1985, 24–46. Errata: Israel J. Math. **88** (1994), 425–427.
- [5] F. Bogomolov, *Fillability of contact pseudoconvex manifolds*, Göttingen Univ. preprint, Helf **13** (1993), 1–13.
- [6] G. Burde and H. Zieschang, *Knots*, de Gruyter Studies in Mathematics **5**, Walter de Gruyter 1985.
- [7] G. Dethloff and H. Grauert, *Seminormal complex spaces*, in “Several Complex Variables VII”, Encyclopaedia of Mathematical Sciences **74**, Springer-Verlag 1994, 183–220.
- [8] Y. M. Eliashberg, *Classification of overtwisted contact structures on 3-manifolds*, Invent. Math. **98** (1989), 623–637.
- [9] Y. M. Eliashberg, *Filling by holomorphic discs and its applications*, in “Geometry of Low-dimensional manifolds: 2”, London Math. Soc. Lecture Notes **151**, Cambridge University Press 1990, 45–67.
- [10] Y. Eliashberg, *Topological characterization of Stein manifolds in dimension > 2* , Intern. Journ. of Math. **1** (1990), 29–46.
- [11] Y. M. Eliashberg, *Legendrian and transversal knots in tight contact 3-manifolds*, in “Topological Methods in Modern Mathematics”, Publish or Perish 1993, 171–193.
- [12] Y. Eliashberg, *Symplectic topology in the nineties*, Diff. Geom. and its Appl. **9** (1998), 59–88.
- [13] Y. M. Eliashberg and W. P. Thurston, *Confoliations*, University Lecture Series **13**, Amer. Math. Soc. 1998.
- [14] J. B. Etnyre and K. Honda, *On the non-existence of tight contact structures*, preprint 1999.
- [15] T. Fuller, *Hyperelliptic Lefschetz fibrations and branched covering spaces*, preprint 1999.
- [16] R. E. Gompf, *Handlebody construction of Stein surfaces*, Ann. of Math. **148** (1998), 619–693.

- [17] R. E. Gompf and A. I. Stipsicz, *4-manifolds and Kirby calculus*, Graduate Studies in Mathematics **20**, Amer. Math. Soc. 1999.
- [18] H. Grauert and R. Remmert, *Komplexe Räume*, Math. Ann. **136** (1958), 245–318.
- [19] H. Grauert and R. Remmert, *The theory of Stein spaces*, Grundlehren der mathematischen Wissenschaften **236**, Springer-Verlag 1977.
- [20] R. C. Gunning and H. Rossi, *Analytic functions of several complex variables*, Prentice-Hall Series in Modern Analysis, Prentice-Hall Inc. 1965.
- [21] J. Harer, *Pencils of curves on 4-manifolds*, Dissertation, Univ. of California, Berkeley 1979.
- [22] J. Harer, *How to construct all fibered knots and links*, Topology **21** (1982), 263–280.
- [23] A. Kas, *On the handlebody decomposition associated to a Lefschetz fibration*, Pacific J. Math. **89** (1980), 89–104.
- [24] R. Kirby, *The topology of 4-manifolds*, Lecture Notes in Mathematics **1374**, Springer-Verlag 1989.
- [25] W. B. R. Lickorish, *A finite set of generators for the homeotopy group of a 2-manifold*, Proc. Camb. Phil. Soc. **60** (1964), 769–778. Corrigendum: Proc. Camb. Phil. Soc. **62** (1966), 679–681.
- [26] P. Lisca, *Symplectic fillings and positive scalar curvature*, Geometry & Topology **2** (1998), 103–116.
- [27] P. Lisca and G. Matić, *Stein 4-manifolds with boundary and contact structures*, Topology and its Appl. **88**, (1998), 55–66.
- [28] J. Milnor, *Morse theory*, Annals of Mathematics Studies **51**, Princeton Univ. Press 1963.
- [29] J. M. Montesinos, *4-manifolds, 3-fold covering spaces and ribbons*, Trans. Amer. Math. Soc. **245** (1978), 453–467.
- [30] J. M. Montesinos, *Lifting surgeries to branched covering spaces*, Trans. Amer. Math. Soc. **259** (1980), 157–165.
- [31] T. Peternell, *Pseudoconvexity, the Levi problem and vanishing theorems*, in “Several Complex Variables VII”, Encyclopaedia of Mathematical Sciences **74**, Springer-Verlag 1994, 221–258.
- [32] R. Piergallini, *Covering Moves*, Trans Amer. Math. Soc. **325** (1991), 903–920.
- [33] R. Piergallini, *Four-manifolds as 4-fold branched covers of S^4* , Topology **34** (1995), 497–508.
- [34] L. Rudolph, *Algebraic functions and closed braids*, Topology **22** (1983), 191–202.

- [35] L. Rudolph, *Braided surfaces and Seifert ribbons for closed braids*, Comment. Math. Helvetici **58** (1983), 1–37.
- [36] A. Simon, *Geschlossene Zöpfe als Verweigungsmenge irregulärer Überlagerungen der 3-Sphäre*, Dissertation, Frankfurt am Main 1998.